

Community Discovery Algorithm Based on Spatio-temporal Graph Embedding in Dynamic Social Networks

Yingnan Xu^{a,1},

^a*Southern Methodist University, 6425 Boaz Lane, 75205, Dallas, TX, USA*

Abstract

Community discovery is one of the key issues in the study of dynamic social networks. Traditional community discovery algorithms only focus on the establishment and disconnection of connections between nodes, failing to capture deeper factors. To address this limitation, in this work, we propose a community discovery algorithm based on spatiotemporal graph embedding (CDA-SGE), which integrates spatial information and evolutions of nodes to comprehensively capture the dynamic features of networks. Specifically, this algorithm employs Graph Convolutional Neural Networks (GCN) to aggregate latent spatial information, effectively representing the embedding of nodes in space. Temporal evolutions of the nodes are then modeled using Gated Recurrent Units (GRU), thereby solving problems such as node dynamism and relationship transmission. Finally, a Self-Organizing Map (SOM) is applied to cluster dynamic network representations and identify community affiliations of nodes. We then perform simulations on four types of dynamic networks and show that the CDA-SGE outperforms traditional community discovery algorithms in terms of purity, standardized mutual information, heterogeneity, and homogeneity. These results demonstrate the algorithm's superior ability to accurately uncover community structures hidden in dynamic social networks.

Keywords: Community Discovery; Dynamic Social Networks; Spatiotemporal Graph Embedding; Gate Controlled Cycle Unit

1. Introduction

Social networks have become an indispensable part of daily lives, with explosive growth in both scale and complexity. Dynamic social networks are composed of a vast number of user nodes and the evolving connections between them. These networks contain rich information and intricate structural patterns that are worth exploring.

Community discovery(Kang et al., 2024), one of the key tasks in social network analysis, aims to identify community structures in the network that exhibit strong internal connections while being relatively independent of other groups. The applications of community discovery span a wide range of domains, providing valuable insights and effective solutions. In targeted marketing and personalization, communities offer a deeper understanding of shared interests and

behavioral patterns(Paliouras, 2012), enabling the development of more effective recommendation systems and customized advertising strategies. In epidemiology and public health(Leung et al., 2004; Rostami et al., 2023), identified communities can represent populations at higher risk or groups vulnerable to the spread of infectious diseases, facilitating the design of targeted intervention and containment measures. Similarly, in security and fraud detection, community discovery plays a crucial role in identifying anomalous groups within financial or communication networks(Sarvari et al., 2014; Andre et al., 2012; Waskiewicz, 2012), helping analysts detect fraudulent activities, cyber threats, or other malicious entities. Finally, in social science and behavioral analysis(Dhawan et al., 2021; Lancieri and Durand, 2006), understanding community dynamics provides critical insights into cultural trends, patterns of social influence, and the evolution of social norms over time. These diverse applications underscore the importance of studying communities within dynamic networks to address real-world challenges.

Email address: yingnanxu@mail.smu.edu (Yingnan Xu)

In static social networks, numerous community discovery algorithms(Zhang et al., 2024) have achieved certain results. However, the temporal variability of dynamic social networks poses significant challenges for community discovery(He et al., 2024; Wu et al., 2024). Traditional static algorithms(Zhang et al., 2020) face challenges in capturing dynamic changes in network properties across different time points, and fail to accurately reflect the real community structure and its evolution process. Recently, graph embedding techniques(Yuan et al., 2022) emerged in the field of social network analysis. Such techniques map nodes in the network to a low-dimensional vector space, thereby preserving the structure and semantic information of nodes. However, most existing graph embedding methods still focus primarily on static networks, with significant limitations in the joint processing of temporal and spatial dimension information in dynamic social networks(Duan et al., 2021).

To address these issues, in this paper, we propose a community discovery algorithm based on spatiotemporal graph embedding. The proposed algorithm fully accounts for the spatial connectivity relationships and temporal trends of the nodes in dynamic social networks. Through innovative embedding techniques, it integrates spatiotemporal information into a unified framework, enabling more accurate detection of the community structure of networks and a clearer visualization of their evolution path. This approach provides strong support for a deeper understanding of the inherent laws and mechanisms of dynamic social networks and has great potential for applications in social network analysis, recommendation systems, information dissemination, and other fields.

This paper is organized as follows. In Sect. 1, we briefly discuss the motivation to propose a dynamic community discovery algorithm. In Sect. 2, we review some of the progress and limitations of current community discovery algorithms. In Sect. 3, we discuss the necessary definitions related to CDA-SGE and introduce the algorithm. Experiments and comparisons are conducted in Sect. 4. And finally Sect. 5 concludes the paper.

2. Related Works

Researchers have made significant progress in the study of community discoveries within dynamic social networks. Yang and Duan (2023) proposed a dynamic community discovery algorithm based on spectral clustering (SC-DCDA) to address the problems of network structure analysis, insufficient clustering information,

and excessive computational overhead caused by the lack of historical information necessary for community nodes in static community discovery algorithms for social networks. This algorithm is based on the division of community network evolution events and the analysis of major community events. Traditional community discovery methods assume that nodes have an equal status in the network, ignoring the influence of nodes in community formation. To address this issue, Yang et al. (2023) proposed a community discovery method based on node influence expansion. This approach begins by calculating the local influence of the nodes using Monte Carlo simulation. Next, a novel eccentricity-based method is introduced to screen bridge nodes and enhance seed quality. Finally, dynamic programming is applied to expand the seeds and generate communities. To reveal hidden dynamic phenomena in virtual social networks, Li et al. (2021) proposed a multi-time dense subgraph discovery algorithm for online social network discovery, which considers both topic and time. In this algorithm, conversations or comments are modeled as an interactive network, which is then partitioned into topic-specific communities using its topological structure. Within each community, dense subgraphs are mined on the basis of time dimension, capturing temporal dynamics.

However, current dynamic social network community discovery algorithms still have many limitations: (a) The explosive growth of social network data increases computational complexity, memory usage, and runtime. Many algorithms require recalculating at each time step, causing the time complexity to rise significantly with the number of steps, hindering real-time performance. (b) Some algorithms neglect temporal correlations and fail to capture the true evolution of communities and complex structures such as nesting, overlap, and hierarchy, leading to the loss of critical information. (c) Algorithms often struggle with the dynamic nature of social networks, exhibiting poor adaptability to structural changes and sensitivity to parameter adjustments. In addition, they are vulnerable to noise and abnormal data, compromising accuracy and reliability. Considering these limitations, to fully extract the dynamic features of the network and the interaction information between nodes, and to deeply mine the dynamic features of the network, we propose a community discovery algorithm based on spatiotemporal graph embedding (CDA-SGE). This algorithm employs Graph Convolutional Neural Networks (GCN) to aggregate latent spatial information, effectively representing the embedding of nodes in space. The temporal evolutions of nodes are then modeled using Gated Recur-

rent Units (GRU), thereby solving problems such as node dynamism and relationship transmission. Finally, a Self-Organizing Map (SOM) is applied to cluster dynamic network representations and identify community affiliations of nodes.

3. Dynamic Community Discovery Algorithm

In this section, we first provide definitions and descriptions of the relevant concepts used in this paper. Then, we introduce the proposed algorithm.

3.1. Definitions

Definition 1. (Dynamic Network) Let $V = \{v_1, v_2, \dots, v_n\}$ be the set of nodes in a dynamic network, and $E = \{e_{ij} \mid \forall i, j \in \{1, \dots, n\}, i \neq j\}$ be the set of edges. Then $g_t = (V, E_t)$ is the snapshot network at time t . Here, the number of nodes remains constant, and the number of edges changes over time. A dynamic network G consists of time snapshots of a network, i.e. $G = (V, E) = \{g_1, g_2, \dots, g_t, \dots, g_T\}, 1 \leq t \leq T$.

Definition 2. (Dynamic Community) We use $C_t = \{c_t^1, c_t^2, \dots, c_t^p \mid \forall t \in \{1, \dots, T\}\}$ to denote the p communities divided by the time slice network g_t . The dynamic community divided by the dynamic network G is represented by $C = \{C_1, C_2, \dots, C_T\}$.

Definition 3. (Graph Embedding) Graph embedding can map dynamic network $G(V, E)$ from high-dimensional space to low-dimensional space. The mapping function Γ at time t is defined as

$$\Gamma : v_t^i \longrightarrow f_t^i \in \mathbb{R}^d, 1 \leq i \leq n, 1 \leq t \leq T, d \ll n.$$

Here, f_t^i is the embedding vector of Γ to node v_i in the network at time t , and d represents the dimension of the embedding vector, which is much smaller than the total number of nodes n .

Tab. 1 provides commonly used symbol representations and their corresponding descriptions in this paper.

Symbol	Description
G	Dynamic network (dynamic graph)
t	current time
T	The number of time slice networks
m	Number of edges
n	Number of nodes
d	Embedding vector dimension
C	Community Collection of Dynamic
F_S	Networks
F_t	Time domain embedding features at time t

Table 1: Symbols and descriptions used in this paper.

3.2. The CDA-SGE Algorithm

The dynamic network community discovery process based on spatiotemporal graph embedding, shown in Fig. 1, consists of three main components: spatial feature extraction, temporal feature extraction, and community discovery. In order to fully utilize the spatial information of the nodes in the network, we first employ GCN to learn the feature representation of the nodes from a spatial perspective and aggregate the social information of users who communicate with each other. Next, we share the GCN's weight parameters using GRU to maintain the dynamics of spatial nodes and extract the features of dynamic nodes, addressing node dynamics and long-term dependencies to form the feature representation of the dynamic network. Finally, the SOM algorithm is applied to analyze the network embedding and perform community discovery for dynamic artificial and real social networks. We dub this process as the CDA-SGE algorithm.

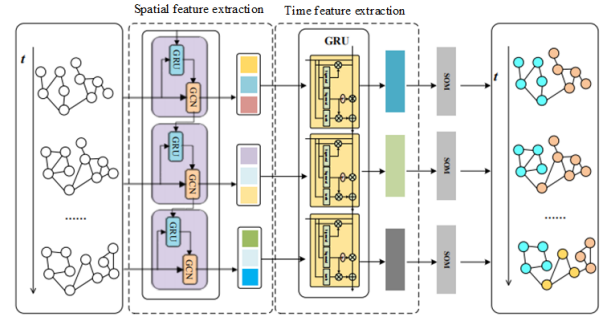

Figure 1: Research framework of CDA-SGE.

3.3. Spatial Feature Extraction

In the spatial feature extraction stage, we start with node interaction learning and use GCN to learn the topological structure information of nodes in the snapshot network and obtain the embeddings of nodes. This process involves two key aspects: space embedding learning and weight parameter sharing.

3.3.1. Space Embedding Learning

GCN is composed of multiple layers of graph convolutions, which utilize convolution operations for neighborhood aggregation. At time t , in the l -th layer, the adjacency matrix A_t and the embedding matrix F_t^{l-1} are taken as input. The weight matrix W_t^{l-1} is used to update the node embedding matrix to F_t^l , which is the output:

$$F_t^l = \Gamma(F_t^{l-1}, A_t, W_t^{l-1}) = \sigma(\hat{A}_t F_t^{l-1} W_t^{l-1}). \quad (1)$$

Here, \hat{A}_t , the normalized adjacency matrix, serves as an approximate graph convolution filter. It can be obtained by

$$\begin{aligned}\hat{A}_t &= \hat{D}_t^{-1/2} \hat{A}_t \hat{D}_t^{-1/2}, \\ \hat{A}_t &= A_t + \mathbb{I},\end{aligned}\quad (2)$$

where \hat{A}_t is the adjacency matrix of the time snapshot network at time t and $A = \{A_1, A_2, \dots, A_t, \dots, A_T\}$ is the adjacency matrix composed of snapshot networks. If there is a connecting edge between node v_i and v_j , $A_{ij} = 0$ and 1 otherwise. \mathbb{I} is the identity matrix, which is added and summed with the adjacency matrix to form a self-loop among the nodes in the snapshot network, providing a more detailed representation of the characteristics of the nodes. \hat{D}_t is the degree matrix representing the nodes of the network,

$$\hat{D}_t = \text{diag} \left(\sum_{j=1}^n A_{t(ij)} \right). \quad (3)$$

$F_t = \{f_t^1, f_t^2, \dots, f_t^m\}$, $1 \leq t \leq T$ represents the characteristics of the node. In this paper, since the relevant dynamic network only includes nodes and edges, we use a random initialization method to generate input features from the nodes. The activation function σ used in this paper follows LeakyReLU method.

In Eq. 2, at time t , the input of the first layer of the network is a randomly initialized node embedding matrix F_0^t , where one row represents the d -dimensional eigenvector of a node. After convolution in the l -th layer, the output features of each time snapshot aggregate the interaction information between the node and its neighbors.

3.3.2. Weight Parameter Sharing

Given the dynamic nature of the network, dynamic update strategies are incorporated into the graph convolutional layers. This is necessary because any change in nodes or edges triggers an adjustment of the weight parameters in the convolutional layers to adapt to the evolving network structure. Therefore, we follow the method of EvolveGCN (Duan et al., 2021) and use GRU to update the weight parameters of GCN at the previous time step, which serves as the weight of GCN at the current time step, to adapt to the development of dynamic networks. The weight update strategy for the l -th layer

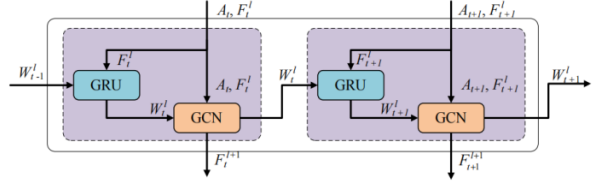

Figure 2: Spatial feature extraction.

at time t is as follows:

$$\begin{aligned}Z_t^l &= \text{sigmoid} \left(U_Z^l W_{t-1}^l + V_Z^l F_t^l + B_Z^l \right), \\ R_t^l &= \text{sigmoid} \left(U_R^l W_{t-1}^l + V_R^l F_t^l + B_R^l \right), \\ \hat{W}_t^l &= \tanh \left(U_W^l (R_t^l \circ W_{t-1}^l) + V_W^l F_t^l + B_W^l \right), \\ W_t^l &= \Phi \left(F_t^l, W_{t-1}^l \right) = (1 - Z_t^l) \circ \hat{W}_t^l + Z_t^l \circ W_{t-1}^l,\end{aligned}\quad (4)$$

where Z_t^l is the the update gate output matrix, R_t^l the reset gate output matrix and \hat{W}_t^l the pre-output matrix. U and V are the weight matrix in GRU, and B is a bias term.

The GCN module aggregates information between nodes and their neighbors, while the GRU adaptively adjusts weight parameters over time. Together, these modules dynamically capture the evolving neighborhood information of the nodes. Thus, operations in the spatial feature extraction stage can be formally represented as

$$F_t^l = \Gamma \left(F_t^{l-1}, A_t, W_t^{l-1} \right) = \Gamma \left(F_t^{l-1}, A_t, \Phi \left(F_t^{l-1}, W_t^{l-1} \right) \right), \quad (5)$$

where $\Gamma(\cdot)$ represents graph convolution operation, and $\Phi(\cdot)$ represents weight update operation using GRU. The spatial feature extraction model is shown in Fig. 2.

3.4. Time Feature Extraction

Classic statistical models and machine learning models can effectively identify sequence data but cannot solve the problem of long-range dependencies of dynamic nodes. That is, in the process of node evolution, the connections established between nodes in the current-time network may have been established a long time ago and only re-established in the current time. In order to obtain information on the dynamic changes of nodes in the time domain and solve the problem of long-distance dependencies between dynamic nodes, we use GRU's gating mechanism to adjust the input and memory information of temporal data. Compared with LSTM, GRU, instead of using unit states, uses hidden states to transmit information. Therefore, by incorporating GRU in the learning process, the model becomes easier to train, significantly enhancing learn-

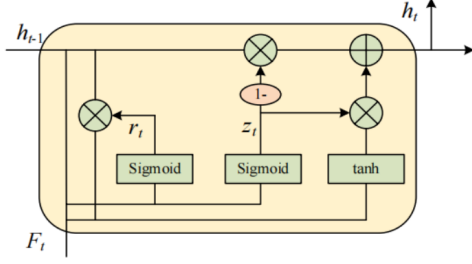

Figure 3: Structure of GRU.

ing efficiency while achieving comparable results. The structure diagram of GRU is shown in Fig. 3. In the GRU computation process, there are two gating mechanisms, the update gate and the reset gate. The update gate controls the extent to which state information from the previous time step is incorporated into the current state. A larger value indicates that more information on the previous state is retained. Conversely, the reset gate controls the degree to which the previous state is ignored; a smaller value means more emphasis on ignoring the previous state information.

The current temporal feature F_t and the hidden state h_{t-1} transmitted from the previous time node form reset and update gates. Among them, the reset gate mainly determines the selection of node information for long-term memory, and it can be obtained as

$$r_t = \sigma(W_r F_t + U_r h_{t-1} + B_r). \quad (6)$$

The update gate mainly updates the status

$$z_t = \sigma(W_z F_t + U_z h_{t-1} + B_z). \quad (7)$$

After obtaining the two gate control signals, the reset gate is first applied to select the relevant information from the previous hidden state and the current input data. The information from the two states is then combined to compute the new memory state

$$\hat{h}_t = \tanh(r_t \circ U_h h_{t-1} + W_h X_t + B_h). \quad (8)$$

where W and U are weight vectors, and B is the bias term. Finally, the update gate selectively retains information from the current hidden state while forgetting the previous hidden state, yielding the current-time feature. The calculation process is as follows

$$h_t = (1 - z_t) \circ h_{t-1} + z_t \circ \hat{h}_t. \quad (9)$$

3.5. Community Detection

The algorithm proposed in this paper learns node representations of dynamic networks in an unsupervised manner. To ensure consistency between nodes in the

embedded and real spaces, Euclidean distance is used to measure proximity, ensuring that connected nodes are placed close to each other, while unconnected nodes are positioned far apart. This can maintain the first-order (pairwise proximity between nodes) and second-order (pairwise proximity between node neighborhood structures) proximity of nodes. Specifically, for the set $S = \{(f_x, f_y), \forall (x, y) \in E\}$, in the pairwise aggregation of nodes, the following objective loss function can be used

$$L = \sum_{(f_x, f_y) \in S} \sum_{(f_x, f_u) \in S} \left[m + \|f_x - f_y\|_2^2 - \|f_x - f_u\|_2^2 \right]_+, \quad (10)$$

where m is a constant representing the size of the security domain, the operator $[\cdot]_+ = \max(\cdot, 0)$ represents the hinge loss.

In large-scale social networks, most nodes are often not connected by edges, and minimizing this loss function is computationally time-consuming. Therefore, we use the negative sampling technique (Duan et al., 2021; Yang et al., 2023) to tackle with this problem. In this technique, negative samples are collected based on the degree of the node, and is then sampled based on the noise distribution $P_n(v) \sim d_v$, where d_v represents the degree of the node v . The loss function is

$$L = \sum_{(f_x, f_y) \in S} \left(\sum_{q=1}^Q E_{v_q \sim P_n(v)} \right) \times \left[m + \|f_x - f_y\|_2^2 - \|f_x - f_{v_q}\|_2^2 \right]_+. \quad (11)$$

where Q is the number of negative samples. After obtaining the embedding features of the dynamic network through spatiotemporal graph embedding, the SOM algorithm is used to learn the embedding information. Competitive learning clusters the input node embeddings, resulting in the final community division of the nodes. The pseudo-code of the CDA-SGE algorithm is shown in Algorithm 1.

Algorithm 1 Dynamic Community Discovery Method Based on Spatiotemporal Graph Embedding

Require: $G = \{g_1, g_2, \dots, g_t, \dots, g_T\}$ \triangleright Input graph sequence**Ensure:** $C = \{C_1, C_2, \dots, C_T\}$ \triangleright Output community sequence**for** g_t in G **do** Create time snapshot adjacency matrix $A_t \in \mathbb{R}^{n \times n}$ Create time snapshot unit matrix $\mathbb{I}_t \in \mathbb{R}^{n \times n}$ Initialize node feature matrix $F_t \in \mathbb{R}^{n \times d}$ $W_t^1 \leftarrow \Phi(F_t, W_{t-1}^1)$ $F_t^1 \leftarrow \Gamma(A_t, F_t, W_t^1)$ $W_t^2 \leftarrow \Phi(F_t^1, W_{t-1}^2)$ $F_t^2 \leftarrow \Gamma(A_t, F_t^1, W_t^2)$ $F_s \leftarrow F_t^2$ $F_t \leftarrow \text{GRU}(F_s, F_{t-1})$ $C_t \leftarrow \text{SOM}(F_t)$ Append C_t to C **end for** **return** W_t^1, W_t^2, F_t

4. Results and Analysis

4.1. Experiment Setup

All algorithms in the paper are programmed using Python, and the relevant environment is configured using Anaconda. The GCN and GRU parts of the code are built based on Pytorch. The operating system of the computer is 64 bit Windows 10 system, and the hardware configuration is Lenovo Qitian M510; AMD PRO A10-8700 3.5GHz; 8GB memory; 128GB+1TB hard drive. The data set used in this experiment is a time snapshot network, including both artificial and real network data sets. In the experiment, the parameters are taken to be $N = 1000$, $s = 9$, $\mu \in [0.1, 0.8]$. We change the value of μ to obtain 8 dynamic artificial datasets, labeled as LFR1 to LFR8. We validate the performance of CDA-SGE using four types of dynamic networks: PS, CW, DBLP5, and Brain, ranging from small to large. The experimental evaluation uses cluster indicators, including purity, standardized mutual information, heterogeneity, and homogeneity, as performance metrics.

4.2. Comparison Algorithms

The evaluation of spatiotemporal graph embedding models is performed by comparing them with traditional static graph embedding methods (SDNE(Wang et al., 2023), DeepWalk(Perozzi et al., 2014)) and dynamic graph embedding algorithms (DynAE, DynGEM)(Goyal et al., 2020). After obtaining node embeddings, K-means clustering is used to divide the nodes

into communities. In this paper, purity and normalized mutual information (NMI) are used to evaluate the quality of the clustering results. The parameter settings for the relevant dynamic graph embedding algorithm are shown in Tab. 2.

Algorithm	Parameter settings
DynAE	$\beta = 5, lb = 2$
DynGEM	$\beta = 5, a = 1e-5, v_1 = v_2 = 1e-6,$ $\rho = 0.3, \theta = 0.01$
DeepWalk	$l = 40, w = 10, \gamma = 6$

Table 2: Parameter settings of related algorithms.

To evaluate the community discovery capability of the proposed algorithm, we compared the CDA-SGE-K, where K stands for the final K-means clustering, with dynamic community discovery algorithms Dyperm and FacetNet(Lin et al., 2023), the static community discovery algorithm Louvain(Blondel et al., 2023), and the dynamic community discovery method DyCTWE based on time walk graph embedding.

4.3. Results

4.3.1. Ablation Experiments

In complex machine learning models, which often consist of multiple modules, ablation experiments are used to assess the importance of specific components by removing certain modules and rerunning the experiments. The results are then compared with those from the original model to evaluate the impact of the removed modules. We evaluate the effectiveness of dynamic community methods based on spatiotemporal graph embedding through ablation experiments. The experiments are conducted on a dynamic artificial network (LFR2) with $\mu = 0.2$. We compare the full model with GRU, GCN, and GCN-GRU. The evaluation criteria include the average NMI, completeness, and homogeneity of the dynamic network, which are used to verify the superiority of the proposed algorithm. A detailed comparison is presented in Tab 3.

Algorithm	NMI	Comp	Homo
GCN	0.748334	0.748316	0.748352
GRU	0.695722	0.695708	0.695736
GCN-GRU	0.893428	0.892967	0.893891
CDA-SGE	0.938524	0.937010	0.940042

Table 3: Comparison of Ablation Experimental Results

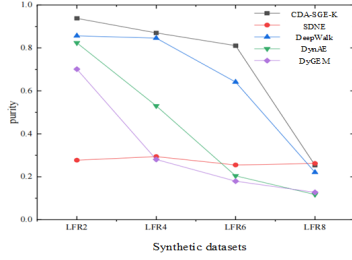

(a)

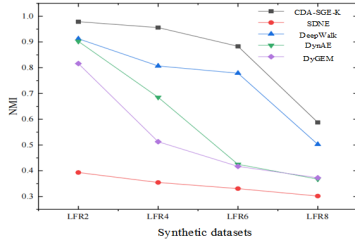

(b)

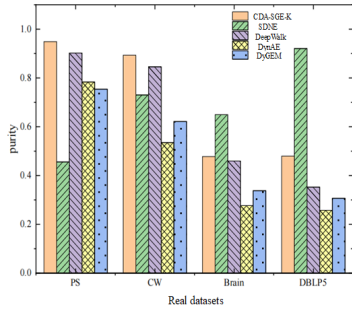

(c)

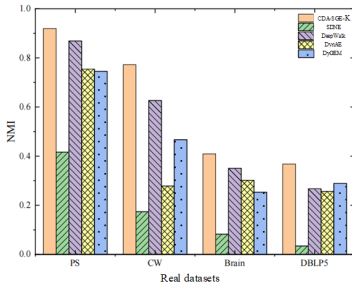

(d)

Figure 4: The average evaluation results of embedding models in datasets: the average purity in LFR (a), the average NMI in LFR (b), the average purity in real dataset (c), and the average NMI in real dataset (d).

As shown in Tab. 3, the community discovery results of CDA-SGE outperform other graph embedding methods, demonstrating its effectiveness in capturing complex relationships in dynamic networks. The CDA-SGE algorithm achieves superior performance across all

evaluation metrics, including NMI, completeness, and homogeneity, indicating that its integrated approach to spatiotemporal graph embedding is well-suited for dynamic community discovery tasks.

The lower performance of GRU can be attributed to its primary focus on learning the temporal changes of the nodes while neglecting the spatial structural characteristics of the network. This limitation reduces its ability to fully capture the intricate dependencies between nodes, leading to suboptimal community discovery. Additionally, the random initialization of node features without fixed semantics introduces inconsistencies in the representation of nodes, further diminishing the effectiveness of the GRU.

Furthermore, the results demonstrate that the GCN-GRU method performs significantly better than GCN alone, indicating that combining spatial topology learning with temporal sequence modeling provides a more holistic understanding of the network’s evolution. The synergy of GCN and GRU enables a better representation of evolving community structures and achieves higher performance across all metrics.

4.3.2. Comparative Analysis of Embedding Methods

In Fig. 4 we present the evaluation results of various graph embedding algorithms on dynamic artificial synthesis datasets and real datasets. We first analyze the performance of the embedding algorithms on synthetic networks. From Fig. 4(a) and Fig. 4(b), it is observed that as the complexity coefficient increases, the average evaluation results for synthetic networks show a decreasing trend. This indicates that as the complexity of the network grows, the ability of the graph embedding algorithm to represent the network structure declines. The CDA-SGE-K algorithm exhibits strong representation capabilities for artificial networks, with K-means yielding superior community partitioning accuracy compared to other embedding models. This demonstrates that the spatiotemporal graph embedding model effectively captures spatiotemporal relationships and preserves node interaction information in complex dynamic networks. The dynamic graph embedding methods DynGEM and DynAE can also provide good embedding features, and the evaluation results of community partitioning achieve good results when the network complexity is low. However, as complexity increases, the evaluation results rapidly decline. This may be attributed to the fact that these two algorithms primarily focus on learning the spatial structure of nodes during graph embedding. For instance, DynGEM only considers the influence of the previous time snapshot on the current one, neglecting the long-range

dependencies of dynamic nodes. Consequently, as network complexity increases, the graph embedding performance declines, impacting community discovery effectiveness. The static embedding algorithm DeepWalk achieves strong results, while SDNE shows stable but modest performance on artificial datasets, with minimal changes in NMI values. This suggests that SDNE can consistently characterize dynamic artificial networks, but its ability to extract node features requires further improvement.

We then analyze the performance of the embedded model in real networks and present the results in Fig. 5. It is evident that all graph embedding models perform better in node partitioning accuracy on smaller dynamic datasets than on larger ones. The decrease in accuracy as the network size grows can be attributed to the increase in the number of nodes and the more complex interaction relationships between them. Larger networks introduce additional challenges, such as denser connections, overlapping communities, and a greater diversity of dynamic interactions, which make it harder for models to effectively capture and preserve all relevant spatiotemporal features.

Despite these challenges, the CDA-SGE proposed in this paper consistently maintains high accuracy across both small and large datasets. This highlights its robustness and its ability to effectively extract dynamic spatiotemporal information, allowing it to characterize the evolution of real-world networks more accurately. The model’s ability to integrate spatial and temporal embeddings enables it to uncover subtle patterns and interactions that are often missed by other methods.

Among the baseline models, DeepWalk achieves the second-best performance due to its ability to learn meaningful node representations through random walks. However, its lack of temporal modeling limits its performance on dynamic datasets. SDNE, on the other hand, yields relatively lower accuracy on large-scale dynamic datasets, probably because its emphasis on preserving local structures struggles to scale effectively with the increasing complexity of larger networks. Among dynamic graph embedding algorithms, DynGEM outperforms DynAE in community discovery, highlighting that SDNE’s embedding performance on the network surpasses that of fully connected neural networks.

4.3.3. Comparative Analysis of Community Discovery Methods

In Fig. 5 we present the evaluation results of community discovery algorithms on dynamic networks.

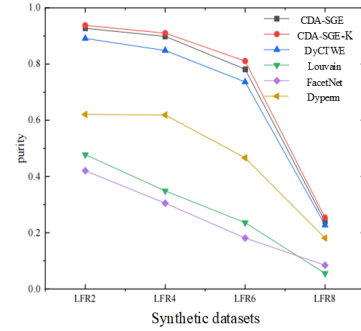

(a)

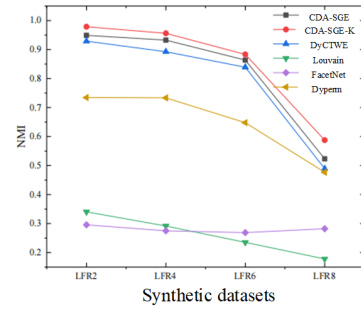

(b)

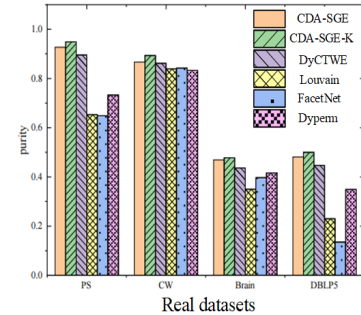

(c)

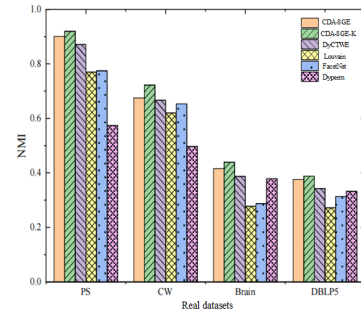

(d)

Figure 5: The average evaluation results of all algorithms in datasets: the average purity in synthetic datasets (a), the average NMI in synthetic datasets (b), the average purity in real datasets (c), and the average NMI in real datasets (d).

From the figure, it is clear that CDA-SGE shows a noticeable effect on community partitioning for both real and synthetic network datasets. However, its performance on large real dynamic networks is significantly lower than on smaller ones, highlighting that the complexity and variability of large dynamic networks remain key challenges in the research. However, CDA-SGE has achieved strong evaluation results across both artificially synthesized and real dynamic network datasets. The accuracy of purity and NMI in various datasets are presented in Tab. 4.

Dataset	Purity (%)	NMI (%)
LFR2	93.73	94.89
LFR4	89.84	93.25
LFR6	78.17	86.36
LFR8	24.03	52.31
PS	92.68	90.10
CW	86.64	67.45
Brain	46.91	41.56
DBLP5	48.10	37.60

Table 4: Accuracy of Purity and NMI in Various Datasets

Comparing the proposed algorithm with traditional static community discovery algorithms, such as Louvain, and dynamic community discovery algorithms such as Dyperm and FacetNet, CDA-SGE outperforms these methods in community partitioning. FacetNet’s performance on artificial networks is suboptimal, although it performs better on real networks, suggesting that it focuses more on changes in real-world social activities. Dyperm demonstrates relatively stable community partitioning performance, while Louvain performs well in real online communities.

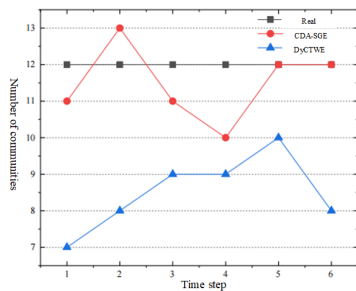
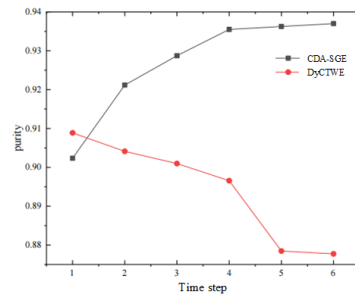

Figure 6: Number of communities divided by the thesis algorithms in PS dataset.

The comparison between CDA-SGE and CDA-SGE-K primarily evaluates the impact of clustering algorithms on the partitioning results of the graph em-

bedding model. From the results, it is observed that the evaluation results for both the SOM and the K-means clustering algorithms are similar, with differences within 5%. The SOM algorithm was chosen because it does not require specifying the number of clusters in advance, only the number of competing units, neighborhood range, and learning rate. This allows for adaptive community division based on the embedding representation of nodes. In contrast, the K-means algorithm requires prior knowledge of the number of clusters, which is often difficult to determine in real dynamic networks. Hence, SOM clustering is more suitable for this work.



(a)

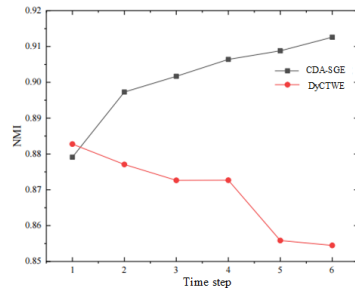

(b)

Figure 7: The evaluation results of the thesis algorithms in PS dataset: the average purity in PS (a), and the average NMI in PS (b).

In Fig. 6, we present the comparison of community partitioning results for the PS dataset, while in Fig. 7, we present the evaluation results of both algorithms on the same dataset. From Fig. 6, it is evident that CDA-SGE’s partitioning results are closely aligned with the actual number of communities, with only minor discrepancies. In contrast, DyCTWE shows a maximum difference of 5 communities from the real partitioning. Fig. 7 reveals that the quality of DyCTWE’s partitioning deteriorates over time, indicating error accumulation and a decline in community discovery performance. This issue likely arises because DyCTWE overly emphasizes local incremental updates, neglecting the over-

all evolution of the network. On the other hand, CDA-SGE demonstrates an increasing trend in performance over time, suggesting that spatiotemporal graph embedding effectively captures the dynamic evolution of nodes and offers robust representation capabilities for dynamic networks.

5. Conclusion

In this work, we explore the complex structure and rules of social networks in the spatiotemporal dimension through a community discovery algorithm based on spatiotemporal graph embedding. Experimental validation demonstrates the effectiveness of the proposed algorithm in mining dynamic social network communities, offering new insights and methods to understand group organization and information flow in such networks.

For future work, we plan to optimize the algorithm by integrating advanced deep learning architectures, such as attention-based neural networks, to improve spatiotemporal feature learning, automatically adjust embedding parameters, and enhance the accuracy of community discovery. Additionally, we plan to extend the algorithm to dynamic network analysis in more fields, such as transportation networks, biological networks, particle interactions, etc., to verify its generality and effectiveness. In addition, we will integrate the CDA-SGE with other community discovery algorithms, complement each other's strengths and weaknesses, and build a more powerful hybrid algorithm framework to cope with the increasingly complex and changing network environment, providing stronger technical support for the development of dynamic social network research and related application fields.

References

Kang, H., Jing, W., & Zhang, Y. (2024). Overlapping Community Discovery Algorithm Based on Industrial Big Data. *Computer Integrated Manufacturing System*, **30**(6), 2130–2138.

Zhang, X., Wu, F., Jia, H., et al. (2024). Local Community Discovery Algorithm that Balances Similarity and Closeness. *Mini-Micro Systems*, **45**(4), 960–967.

He, C., Cheng, Q., Cheng, J., et al. (2024). A Dynamic Community Discovery Method that Integrates Node Change Information. *Acta Electronica Sinica*, **52**(8), 2786–2798.

Wu, Y., Dou, S., Li, J., et al. (2024). A Review of Community Discovery Research Integrating Heterogeneity and Dynamics. *Computer Engineering and Applications*, **60**(21), 55–72.

Zhang, H., Zhou, H., Zhang, X., et al. (2020). Progress in Community Discovery Research on Online Social Networks. *Library and Information Work*, **64**(9), 142–152.

Yuan, L., Li, X., Wang, X., et al. (2022). Overview of Graph Embedding Models. *Computer Science and Exploration*, **16**(1), 59–87.

Duan, X., Yuan, G., & Meng, F. (2021). A Review of Research on Dynamic Community Discovery Methods. *Computer Science and Exploration*, **15**(4), 612–630.

Yang, Y., & Duan, W. (2023). Dynamic Community Discovery Algorithm for Social Networks Based on Spectral Clustering. *Computer Application*, **43**(10), 3129–3135.

Yang, H., Zhao, X., Chen, C., et al. (2023). Social Network Community Discovery Algorithm Based on Node Influence Expansion. *Journal of Harbin University of Science and Technology*, **28**(3), 10–19.

Li, J., Cao, N., Zhang, Q., et al. (2021). Online Social Network Group Discovery Algorithm Considering Theme and Time. *Journal of Shandong University of Science and Technology (Natural Science Edition)*, **40**(4), 94–102.

Wang, D., Cui, P., & Zhu, W. (2023). Structural Deep Network Embedding. In *Proceedings of the 22nd International Conference on Knowledge Discovery and Data Mining* (pp. 1225–1234). ACM.

Perozzi, B., Al-Rfou, R., & Skiena, S. (2014). Deepwalk: Online Learning of Social Representations. In *Proceedings of the 20th International Conference on Knowledge Discovery and Data Mining* (pp. 701–710). ACM.

Goyal, P., Chhetri, S. R., & Canedo, A. (2020). Dyngraph2vec: Capturing Network Dynamics Using Dynamic Graph Representation Learning. *Knowledge-Based Systems*, **18**(7), 104816–104823.

Lin, Y. R., Chi, Y., Zhu, S., et al. (2023). FacetNet: A Framework for Analyzing Communities and Their Evolutions in Dynamic Networks. In *Proceedings of the 32th International Conference on World Wide Web* (pp. 685–694). ACM.

Blondel, V. D., Guillaume, J. L., Lambiotte, R., et al. (2023). Fast Unfolding of Communities in Large Networks. *Journal of Statistical Mechanics: Theory and Experiment*, **21**(10), 10008–10020.

Leung, M. W., Yen, I. H., & Minkler, M. (2004). Community-based participatory research: a promising approach for increasing epidemiology's relevance in the 21st century. *International Journal of Epidemiology*, **33**(3), 499–506.

Rostami, M., Oussalah, M., Berahmand, K., & Farrahi, V. (2023). Community Detection Algorithms in Healthcare Applications: A Systematic Review. *IEEE Access*, **PP**, 1–1. <https://doi.org/10.1109/ACCESS.2023.3260652>

Paliouras, G. (2012). Discovery of Web user communities and their role in personalization. *User Modeling and User-Adapted Interaction*, **22**, –. <https://doi.org/10.1007/s11257-011-9111-y>

Sarvari, H., Abozinadah, E., Mbaziira, A., & Mccoy, D. (2014). Constructing and Analyzing Criminal Networks. In *2014 IEEE Security and Privacy Workshops* (pp. 84–91). <https://doi.org/10.1109/SPW.2014.22>

Andre, C., Pinheiro, R., & De Janeiro, R. (2012). Community detection to identify fraud events in telecommunications networks. In *SAS SUGI Proceedings: Customer Intelligence. SAS Global Forum 2012*.

Waskiewicz, T. (2012). Friend of a friend influence in terrorist social networks. In *Proceedings on the International Conference on Artificial Intelligence (ICAI)* (p. 1). The Steering Committee of The World Congress in Computer Science, Computer.

Dhawan, S., Singh, K., & Batra, A. (2021). Community discovery and behavior prediction in online social networks employing node centrality. In *Mobile Radio Communications and 5G Networks: Proceedings of MRCN 2020* (pp. 73–85). Springer.

Lancieri, L., & Durand, N. (2006). Internet user behavior: compared study of the access traces and application to the discovery of communities. *IEEE Transactions on Systems, Man, and Cybernetics - Part A: Systems and Humans*, **36**(1), 208–219. <https://doi.org/10.1109/TSMCA.2005.859095>