

Statistically Preserved Structures in Shell Models of Passive Scalar Advection

Yoram Cohen, Thomas Gilbert and Itamar Procaccia

Dept. of Chemical Physics, The Weizmann Institute of Science, Rehovot 76100, Israel

arXiv:nlin/0107016v1 [nlin.CD] 8 Jul 2001

It was conjectured recently that Statistically Preserved Structures underlie the statistical physics of turbulent transport processes. We analyze here in detail the time-dependent (non compact) linear operator that governs the dynamics of correlation functions in the case of shell models of passive scalar advection. The problem is generic in the sense that the driving velocity field is neither Gaussian nor δ -correlated in time. We show how to naturally discuss the dynamics in terms of an effective compact operator that displays “zero modes” which determine the anomalous scaling of the correlation functions. Since shell models have neither Lagrangian structure nor “shape dynamics” this example differs significantly from standard passive scalar advection. Nevertheless with the necessary modifications the generality and efficacy of the concept of Statistically Preserved Structures are further exemplified. In passing we point out a bonus of the present approach, in providing analytic predictions for the time-dependent correlation functions in decaying turbulent transport.

I. INTRODUCTION

Turbulent transport processes refer to the advection of a transported field $\phi(\mathbf{r}, t)$ (scalar or vector) by a turbulent velocity field $\mathbf{u}(\mathbf{r}, t)$ [1,2]. The basic equation of motion is linear, having the form

$$\partial_t \phi = \mathcal{L} \phi. \quad (1)$$

Here \mathcal{L} is an operator that is built out of the turbulent velocity field, and as such may be stochastic. Examples are the advection of a passive scalar $\theta(\mathbf{r}, t)$, with the equation of motion

$$\frac{\partial \theta}{\partial t} + \mathbf{u} \cdot \nabla \theta = \kappa \nabla^2 \theta, \quad (2)$$

or a vector, like a magnetic field $\mathbf{B}(\mathbf{r}, t)$ satisfying [3]

$$\frac{\partial \mathbf{B}}{\partial t} + (\mathbf{u} \cdot \nabla) \mathbf{B} = (\mathbf{B} \cdot \nabla) \mathbf{u} + \kappa \nabla^2 \mathbf{B}. \quad (3)$$

We may also consider advection, as in [4], of a vector field \mathbf{w} whose divergence vanishes, $\nabla \cdot \mathbf{w} = 0$:

$$\frac{\partial \mathbf{w}}{\partial t} + (\mathbf{u} \cdot \nabla) \mathbf{w} = -\nabla p + \kappa \nabla^2 \mathbf{w}. \quad (4)$$

In all these equations the velocity field \mathbf{u} comes from either a solution of a fluid-mechanical equation, or is a random field defined with some statistical properties. A fundamental consequence of the linearity of the equations of motion is that the correlation functions may be expressed as

$$\langle \phi(\mathbf{r}_1, t) \dots \phi(\mathbf{r}_N, t) \rangle = \int \mathcal{P}_{\underline{\mathbf{r}}|\underline{\rho}}^{(N)}(t) \langle \phi(\rho_1, 0) \dots \phi(\rho_N, 0) \rangle d\underline{\rho}, \quad (5)$$

where $\langle \dots \rangle$ is an average over the statistics of the initial conditions *and* the statistics of the advecting velocity field. The notation $\underline{\mathbf{r}} = (\mathbf{r}_1, \dots, \mathbf{r}_N)$ is used for simplicity. Note that we have used the passive nature of the transported field, i.e. the fact that the velocity is independent of the *initial* distribution of ϕ , to separate the averages over the initial conditions and the velocity. Such a decoupling cannot be afforded at any other time because of the build-up of correlations between the advecting and advected fields. The linear operator $\mathcal{P}_{\underline{\mathbf{r}}|\underline{\rho}}^{(N)}(t)$ propagates the N th-order correlation function from time zero to time t .

The evolution operator \mathcal{L} generally includes dissipative terms, and without fresh input (forcing) the statistics of the field ϕ is time-dependent; this is the *decaying* case, Eq. (1). A related problem of much experimental and theoretical interest is *forced* turbulent transport where an input term f is added to the Eq. (1). The situations of interest in turbulence typically involve an input acting only at large scales of order L . The objects of major interest are the stationary correlation functions $F^{(N)}$ of the advected field,

$$F^{(N)}(\mathbf{r}_1, \dots, \mathbf{r}_N) \equiv \langle \phi(\mathbf{r}_1, t) \dots \phi(\mathbf{r}_N, t) \rangle_f. \quad (6)$$

One cares about the scaling properties at distances much smaller than L and at the stationary state. As usual in turbulent flows, the correlation functions of the advected field are expected to contain anomalous contributions behaving as

$$\langle \phi(\lambda \mathbf{r}_1, t) \dots \phi(\lambda \mathbf{r}_N, t) \rangle_f = \lambda^{\zeta_N} \langle \phi(\mathbf{r}_1, t) \dots \phi(\mathbf{r}_N, t) \rangle_f, \quad (7)$$

with scaling exponents ζ_N which cannot be inferred from dimensional analysis.

Recently [5], two conjectures were proposed, pertaining to a wide variety of turbulent transport processes, without special provisos on the properties of the advecting velocity field:

(i) In the decaying case, despite the non-stationarity of the statistics, there exist special functions $Z^{(N)}(\underline{\mathbf{r}})$ such that

$$I^{(N)}(t) = \int Z^{(N)}(\underline{\mathbf{r}}) \langle \phi(\mathbf{r}_1, t) \dots \phi(\mathbf{r}_N, t) \rangle d\underline{\mathbf{r}} \quad (8)$$

are statistical integrals of motion. In the limit of infinitely large system $I^{(N)}$ does not change with time. It

follows from (5) and the conservation of $I^{(N)}(t)$ that in the infinite size limit the $Z^{(N)}$'s are left-eigenfunctions of the operator:

$$Z^{(N)}(\mathbf{r}) = \int \mathcal{P}_{\underline{\rho}|\mathbf{z}}^{(N)}(t) Z^{(N)}(\underline{\rho}) d\underline{\rho}. \quad (9)$$

note that this does not mean that the operator $\mathcal{P}_{\underline{\rho}|\mathbf{z}}^{(N)}(t)$ admits an eigenvector decomposition, and see below for a further discussion of this point.

(ii) The anomalous part of the stationary correlation functions in the forced problem is dominated by statistically conserved structures. In other words, at least in the scaling sense

$$F^{(N)}(\mathbf{r}) \sim Z^{(N)}(\mathbf{r}). \quad (10)$$

A direct consequence is that the small-scale statistics of the transported field ϕ in the forced case rests on the understanding of the decaying problem. A by-product is that the scaling exponents ζ_N are universal, i.e. independent of the forcing mechanisms for any forcing that is statistically independent of the velocity field.

The conjectures were exemplified in the context of shell models of passive scalar advection. The model's equations read [5,6]

$$\begin{aligned} \frac{d\theta_m}{dt} &= i(k_{m+1}\theta_{m+1}u_{m+1} + k_m\theta_{m-1}u_m^*) - \kappa k_m^2 \theta_m, \quad (11) \\ &\equiv \mathcal{L}_{m,m'} \theta_{m'} \end{aligned}$$

where the variables u_n are generated by the ‘‘Sabra’’ shell model [7]

$$\begin{aligned} \frac{du_n}{dt} &= i(ak_{n+1}u_{n+2}u_{n+1}^* + bk_n u_{n+1}u_{n-1}^* \\ &\quad + ck_{n-1}u_{n-1}u_{n-2}) - \nu k_n^2 u_n + f_n. \quad (12) \end{aligned}$$

Here the coefficients a , b , and c are real. In Eqs. (11) and (12) the wavevectors are $k_n = k_0 2^n$. The velocity forcing f_n is limited to the first shell $n = 0$. For $\kappa = \nu = 0$ and $a + b + c = 0$ the energies $\sum_n |u_n|^2$ and $\sum_n |\theta_n|^2$ are *dynamically conserved*, i.e. realization by realization. The statistical physics of this model were studied carefully [7] in the regime of $b \approx -0.5$. Taking the forcing to be random (with random phases) leads to non-trivial statistics of the velocity field, with anomalous exponents that characterize the scaling behavior of the correlation functions.

The operator $\mathcal{P}^{(N)}$ of Eqs. (5), (9) takes here the explicit form

$$\mathcal{P}_{\underline{n}|\underline{m}}^{(N)}(t) = \langle R_{n_1, m_1}(t|0) \cdots R_{n_N, m_N}(t|0) \rangle, \quad (13)$$

where $\underline{n} = (n_1, \dots, n_N)$ and

$$R_{n,m}(t|0) \equiv T^+ \left[\exp \left[\int_0^t ds \mathcal{L}(s) \right] \right]_{n,m}, \quad (14)$$

with T^+ being the time ordering operator. Note that for notational simplicity we dropped the dependence on the initial time from $\mathcal{P}^{(N)}$, but left it, for future purposes, in $\mathbf{R}(t|0)$.

To demonstrate the *statistical* conservation laws, two things were done [5]. First the forced problem was considered, adding random forcing to Eq. (11):

$$\frac{d\theta_m}{dt} = \mathcal{L}_{m,m'} \theta_{m'} + f_m, \quad (15)$$

$$\langle f_m(t) f_n^*(t') \rangle = C_m \delta_{m,n} \delta(t - t'). \quad (16)$$

Due to phase symmetry constraints [7], there is only one non-zero second order correlation, but a number of different higher order ones. For example, the correlation $\langle \theta_{n+2} \theta_{n+1}^* \theta_{n+1}^* \theta_{n-1} \rangle_f$ is not zero. For concreteness we concentrated our attention to the following ones (we put a subscript f to stress that these are statistical averages in the stationary forced ensemble):

$$F_n^{(2)} \equiv \langle |\theta_n|^2 \rangle_f, \quad (17)$$

$$F_{n,m}^{(4)} \equiv \langle |\theta_n|^2 |\theta_m|^2 \rangle_f, \quad (18)$$

$$F_{n,m,k}^{(6)} \equiv \langle |\theta_n|^2 |\theta_m|^2 |\theta_k|^2 \rangle_f. \quad (19)$$

Secondly, the decaying problem was examined, preparing initial states $\theta_n(t=0)$ and following their evolution. The following objects were then computed:

$$I^{(2)}(t) \equiv \sum_n \langle |\theta_n(t)|^2 \rangle F_n^{(2)}, \quad (20)$$

$$I^{(4)}(t) \equiv \sum_{n,m} \langle |\theta_n(t)|^2 |\theta_m(t)|^2 \rangle F_{n,m}^{(4)}, \quad (21)$$

$$I^{(6)}(t) \equiv \sum_{n,m,k} \langle |\theta_n(t)|^2 |\theta_m(t)|^2 |\theta_k(t)|^2 \rangle F_{n,m,k}^{(6)}. \quad (22)$$

Figure 1 summarizes the results which are reproduced from [5]. We show, for these three orders, (i) the time dependence of the n th order decaying correlation functions themselves, (ii) the time dependence of $I^{(N)}(t)$. In panel (C) we show also for comparison the time dependence of $I^{(6)}(t)$ if we replace the measured forced $F^{(6)}$ by its dimensional shell dependence (i.e. the shell dependence if the Kolmogorov theory were right). We see that only the properly computed $I^{(n)}(t)$ are time independent for times smaller than the large scale eddy turn over time, T_L . The decay observed for times larger than T_L is simply due to finite size effects intervening when the decaying field reaches the largest scales.

In trying to understand these results, it is very tempting to interpret Eq. (9) as an eigenvalue equation, with $Z^{(N)}$ being an eigenfunction of eigenvalue 1. Unfortunately, the operator $\mathcal{P}^{(N)}$ is not Hermitian, and in addition it does not lend itself to an expansion in terms of eigenvectors and eigenvalues: it is not defined on a compact space. There are two ‘‘non-compact’’ directions, that of length scale and that of time. We thus need to

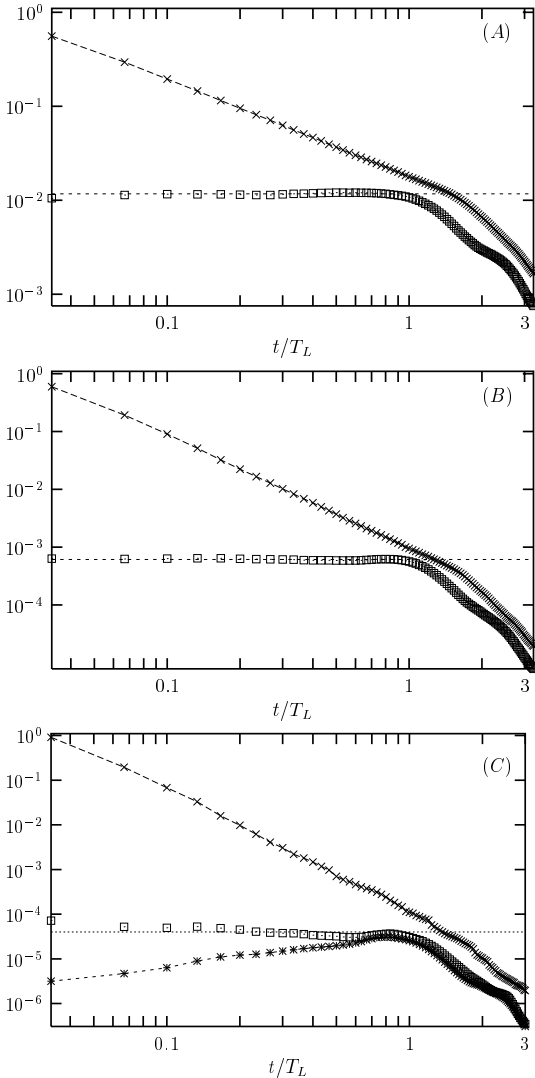

FIG. 1. Panel (A): time dependence of the decaying second order correlation functions (\times), together with the time dependence of the statistically conserved quantities $I^{(2)}$, (\square). Equations (11) and (12) have been integrated with a total number of shells $N = 33$. Time in the horizontal-axis is given in units of the large eddy turn over time T_L . Panel (B): the same as panel (A) but for the fourth order correlation function and with $N = 25$. Panel (C): the same of panel (B) but for the sixth order correlation function. Here we also present $I^{(6)}$ when we replace the forced solution $F_{n,m,k}^{(6)}$ with its dimensional prediction, ($*$). In the simulations $\kappa = \nu = 5 \times 10^{-7}$, $a = 1$, $b = -0.4$, and $c = a + b$. The wavevectors are $k_n = k_0 2^n$ with $n = 0, \dots, N$. The smallest wavevector is given by $k_0 = 0.05$ while N defines the ultraviolet cut-off. As initial states distributions of $\theta_n = 0$ were taken, except for $n = 14, 15$ where the field was initialized with a constant modulus and random phases. The random forcing of the passive scalar was restricted to the first shell.

learn how to take care of these before we can write down a proper theory.

In the context of the passive scalar advection problem, Eq. (2), these issues were solved elegantly in the framework of Lagrangian dynamics [8–12]. For the passive scalar equation (2) the advected field is conserved along the trajectories of the tracer particles $d\mathbf{r}(t) = \mathbf{u}(\mathbf{r}(t), t) dt + \sqrt{2\kappa} d\boldsymbol{\beta}(t)$, where $\boldsymbol{\beta}(t)$ is a Brownian process. To know the scalar field at position \mathbf{r} and time t it is enough to track the corresponding tracer particle back to its initial position $\boldsymbol{\rho}$. The evolution operator $\mathcal{P}_{\mathbf{r}|\boldsymbol{\rho}}^{(N)}(t)$ in Eq. (5) coincides then with the probability density that N tracer particles reach the positions \mathbf{r} at time t given their initial positions $\boldsymbol{\rho}$. For example, to understand the exponent ζ_3 one needs to focus on the dynamics of three tracer particles. Obviously, three particles define at any moment of time a triangle, which in turn is fully characterized by one length scale R (say the sum of the lengths of its sides), two of its internal angles, and all the angles that specify the orientation of the triangle in space. When the particles are advected by the turbulent velocity field, the scale R of the triangle and its shape (angles) change continuously. The statement that can be made is that *there exist distributions on the space of the triangle configurations, that are statistically invariant to the turbulent dynamics* [8–10,12]. In other words, if we release trios of Lagrangian tracers many times into the turbulent fluid, and we choose the distribution of their shapes and sizes correctly, it will remain invariant to the turbulent advection [13]. Such statistically conserved structures are the aforementioned zero modes and they come to dominate the statistics of the scalar field at small scales. The anomalous exponents of the zero modes, such as ζ_3 , can be understood as the rescaling exponents characterizing precisely such special distributions. Of course, the same ideas apply to any order correlation function with the appropriate shape dynamics. The relevance of Lagrangian trajectories can be also demonstrated for the magnetic field case (3), by adding a tangent vector to the tracer particle, and see [14] for more details.

The problem of non-compactness due to the explicit time dependence of the operator is taken care here by expressing time in terms of a single scale variable R , using the Richardson law of turbulent diffusion [11]. Then instead of looking at the problem on the non-compact space of particle separation, one focuses on the space of shapes which is compact, and in which one can demonstrate the existence of eigenfunctions and eigenvalues [11,12]. Obviously, for the case of the shell model considered here we cannot repeat verbatim the same ideology. There are no “shapes”, and it is not immediately obvious how to relate time to scales. The Lagrangian invariance is broken by the discretization of shell space, and the genericity of the time properties of the velocity field does not allow explicit calculations of the operator $\mathcal{P}_{\mathbf{m}|\mathbf{n}}^{(N)}(t)$.

The aim of this paper is to achieve the equivalent understanding for the shell model, that in [5] was originally

chosen to be as far removed as possible from the continuous passive scalar problem. We will discover that also in this case there is a typical “moving” scale that carries the explicit time dependence. By considering the relevant operators with shell indices expressed in terms of the moving scale, we compactify the picture with respect to its time dependence. Moreover, in this moving frame we will discover that the operators decay rapidly as a function of shell differences. This will allow us to compactify the theory altogether and to offer a satisfactory understanding of the existence of the statistically preserved structures and its implication for the forced problem.

In Sect. 2 we present the theory for 2nd order objects. On the basis of numerical simulations we offer an analytic form for the operator $\mathcal{P}^{(2)}$. We show that it has an explicit time dependence in addition to a dependence on a moving scale that we identify analytically. In Sect. 3 we use the explicit form of $\mathcal{P}^{(2)}$ to explain why $I^{(2)}$ is a statistical constant of the motion. The basic property that is crucial is the effective compactness of the operator in the space of shells, once it is expressed in terms of the moving scale. Next we show how the forced stationary correlation function $F^{(2)}$ is obtained by solving the forced problem with the same propagator $\mathcal{P}^{(2)}$. Finally we derive the fact that $F^{(2)}$ acts as a left-eigenvector of $\mathcal{P}^{(2)}$ with eigenvalue 1. To help in throwing light on some issues we also consider in this section a simple model obtained by replacing the Sabra model for the velocity field by a delta-function correlated field (the Kraichnan shell model [6,15]). In Sects. 4 and 5 we turn to a discussion of the 4th order objects. We proceed in parallel to what had been achieved in Sects. 2 and 3. We first derive, on the basis of simulations and the fusion rules [16], the analytic form of $\mathcal{P}^{(4)}$. Using this form we explain why $I^{(4)}$ is a statistical constant of the motion when the stationary correlation function $F^{(4)}$ is identified with $Z^{(4)}$. Last we turn to the forced problem, and demonstrate that $F^{(4)}$ is indeed the forced solution. This calculation is not trivial, calling for a careful discussion of the time-decay and decorrelation properties of the operators $R_{n,m}(t|0)$. Throughout the discussion we make use of the simpler Kraichnan shell model in which the operators are all computed analytically (see Appendix) to further our understanding of the generic case. In Sect. 6 we present a discussion and a summary of the paper. One very important conclusion is that we can in fact offer an *analytic solution* for the time-dependent correlation functions in the decaying case; this is a considerable bonus of the present approach.

II. THE FORM OF THE 2ND ORDER TIME PROPAGATOR

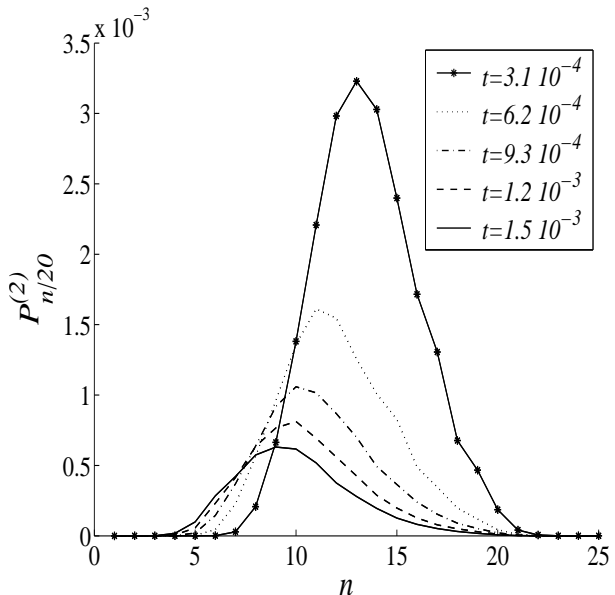

FIG. 2. Typical time dependence of one column of the second order propagator $\mathcal{P}_{n|m}^{(2)}(t)$. Shown here is $\mathcal{P}_{n|20}^{(2)}(t)$ for the different times displayed in the inset in units of τ_0 . Note that the maximum moves in time to lower shell numbers.

A. Simulations

In this section we analyze the form of the 2nd order propagator that governs the dynamics of the second order passive structure function. It is defined by:

$$\langle |\theta_n(t)|^2 \rangle = \sum_m \mathcal{P}_{n|m}^{(2)}(t) \langle |\theta_m(0)|^2 \rangle. \quad (23)$$

The $\langle \dots \rangle$ average is over realizations of the velocity field and the initial conditions of the passive field. As mentioned above at time $t = 0$ the statistics of the advected field is independent of the statistics of the velocity field. Using simulations we can generate the matrix representation of $\mathcal{P}_{n|m}^{(2)}(t)$ column by column by initiating a decaying simulation (without forcing) starting with δ -function initial conditions in shell m . Measuring $\langle |\theta_n(t)|^2 \rangle$ and averaging over many realizations of the Sabra velocity field we collect data for $\mathcal{P}_{n|m}^{(2)}(t)$.

In Fig. 2 we show a typical column of $\mathcal{P}_{n|m}^{(2)}(t)$, where $m = 20$. We used 28 shells in both Sabra and the passive field, with the dissipative scales being around $n = 25$. We observe two effects. First, the overall area under the curve decreases with time, this is the effect of the dissipation. Second, the maximum in the curve shifts to lower shell numbers. These are the two issues that we need to tackle, the time dependence and the increase in length scale (or, equivalently the decrease in shell number), which contribute to the non-compact nature of our operator.

In attempting to contain these two issues we try the following ansatz for the propagator:

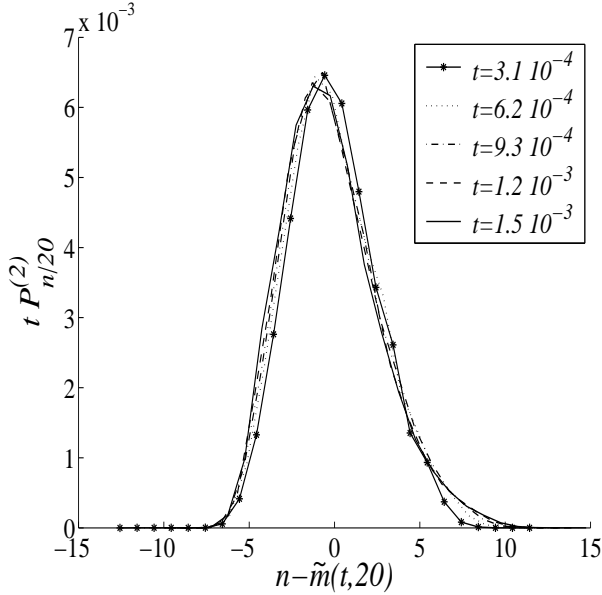

FIG. 3. A plot of $t\mathcal{P}_{n/20}^{(2)}(t)$ as a function of $n - \tilde{m}(t, 20)$. The quality of the data collapse is deteriorating at the right tail because of viscous effects, where power law scaling crosses over to exponential decay.

$$\mathcal{P}_{n|m}^{(2)}(t) = \frac{\tau_m}{t} H(n - \tilde{m}(t, m)), \quad \text{for } t \gg \tau_m, \quad (24)$$

where τ_m is a typical time scale associated with the shell in which the simulation was initiated. We use below

$$\tau_m = 2^{-m\zeta_2} / k_0 \sqrt{\langle |u_0|^2 \rangle}, \quad (25)$$

with ζ_2 being the scaling exponent of the second order structure function, cf. Eq. (7). Accordingly, all times t below are also measured in units of $\tau_0 = 1/k_0 \sqrt{\langle |u_0|^2 \rangle}$. The function $H(x)$ has a peak at $x = 0$, with $H(0) = 1$ and for $x > 0$ it has the form

$$H(x) \sim 2^{-\zeta_2 x}, \quad (26)$$

The location of the maximum of $\mathcal{P}_{n|m}^{(2)}(t)$ is $\tilde{m}(t, m)$, and is a real valued function of time and of the initial peak location for $t = 0$, which is m . For $t > 0$ it satisfies $\tilde{m}(t, m) < m$.

To show that the ansatz (24) is well supported by the data, we show in Fig. 3 $t\mathcal{P}_{n/20}^{(2)}(t)$ as a function of $n - \tilde{m}(t, m)$. The quality of the data collapse speaks for itself. We draw the attention of the reader to the fact that the function shown in Fig. 3 falls off sharply around the maximum. This will be the clue to understanding how to remove the noncompact dependence on the ever increasing scale $\tilde{m}(t, m)$. Sums over n will be extended below from $-\infty$ to ∞ , with impunity. The important conclusion is that to a good approximation the following sum

$$\sum_n H(n - \tilde{m}) = \sum_{n-\tilde{m}} H(n - \tilde{m}) = \sum_k H(k) = \text{Const}, \quad (27)$$

is time independent.

B. The time dependence of the maximum

Next we want to find an analytic expression for the moving scale $\tilde{m}(t, m)$. In order to find the time behavior of the peak we examine Eq. (23) for an initial condition $\langle |\theta_k(0)|^2 \rangle = \delta_{k,m}$. On the one hand, for these initial conditions, after time differentiating we get:

$$\frac{d}{dt} \sum_n \langle |\theta_n(t)|^2 \rangle = \frac{d}{dt} \sum_n \mathcal{P}_{n|m}^{(2)}(t). \quad (28)$$

On the other hand, using Eq. (11) one finds:

$$\frac{d}{dt} \sum_n \langle |\theta_n(t)|^2 \rangle = -2\kappa \sum_n k_n^2 \langle |\theta_n(t)|^2 \rangle. \quad (29)$$

To evaluate the sum on the R.H.S of Eq. (29), we note that for this linear problem the shell d from which the dissipation of the scalar becomes significant is independent of the scalar value (and thus time independent). We can estimate it by comparing the terms on the RHS of Eq. (11):

$$\kappa k_d^2 \approx u_d k_d. \quad (30)$$

We can now estimate the scalar dissipation, under the approximation that it takes place mainly in shells with $m > d$. In this region the value of $\langle |\theta_n(t)|^2 \rangle$ begins to fall off exponentially with k_n , and the sum in Eq. (29) is well approximated by the first term $\kappa k_d^2 \langle |\theta_d(t)|^2 \rangle$. Plugging in the functional form of $\mathcal{P}^{(2)}$ given by Eq. (24), using Eqs. (27)-(29) we get:

$$\begin{aligned} \frac{d}{dt} \sum_n \mathcal{P}_{n|m}^{(2)}(t) &= -\frac{1}{t^2} \sum_k H(k) \\ &\approx -\frac{c\kappa k_d^2 \tau_m}{t} 2^{-\zeta_2(d - \tilde{m}(t, m))}. \end{aligned} \quad (31)$$

Examining Eq. (31) we conclude that in order for the RHS to scale like t^{-2} for $t \gg \tau_m$, while demanding that for $t \approx \tau_m$ $\tilde{m}(t, m) \approx m$, we must have:

$$\begin{aligned} \tilde{m}(t, m) &= m - \frac{1}{\zeta_2} \log_2 \left[g \left(\frac{t}{\tau_m} \right) \right], \\ g(0) &= 1, \quad \lim_{x \rightarrow \infty} g(x) = x. \end{aligned} \quad (32)$$

where τ_m was defined in Eq. (25). Thus for large times we will use

$$\tilde{m}(t, m) = -\frac{1}{\zeta_2} \log_2 \left(\frac{t}{\tau_0} \right), \quad t \gg \tau_m, \quad (33)$$

Note that for large time ($t \gg \tau_m$), $\tilde{m}(t, m)$ becomes independent of m . This is appropriate, since the exponential increase in typical time scales τ_m when the shell

index decreases implies that the position of the maximum becomes independent of its initial position. We can now express the time dependence of the operator $\mathcal{P}^{(2)}$ in Eq. (24), solely through the time behavior of $\tilde{m}(t, m)$, by inverting Eq. (32), to find t :

$$\mathcal{P}_{n|m}^{(2)}(t) \propto 2^{-\zeta_2(m-\tilde{m})} H(n-\tilde{m}), \quad t \geq \tau_m. \quad (34)$$

Having done so, we have gotten rid altogether of the explicit time dependence of $\mathcal{P}_{n|m}^{(2)}(t)$. Note that the dependence of the operator on both its shell indices turns naturally to a dependence on the difference between these indices and the single moving shell. This is the first important step in overcoming the non-compactness of our 2nd order operator.

III. CONSEQUENCES OF THE FORM OF THE 2ND ORDER PROPAGATOR

At this point we can reap the benefit of the explicit form of the 2nd order propagator Eq. (34). First we derive the existence of the statistical constant of the motion $I^{(2)}$.

A. Second order constant of the motion

Returning to the definition of $I^{(2)}$, Eq. (20), and recognizing that $F_n^{(2)} \propto 2^{-\zeta_2 n}$ (which is also demonstrated in the next Subsection), we see that we need to evaluate the weighted sum $\sum_n \langle |\theta_n(t)|^2 \rangle 2^{-\zeta_2 n}$. Since the problem is linear, any initial condition can be represented as a weighted sum of δ -function initial conditions, and therefore we only need to consider sums of the form

$$\sum_n \mathcal{P}_{n|m}^{(2)}(t) 2^{-\zeta_2 n} = 2^{-\zeta_2 m} \sum_n H(n-\tilde{m}) 2^{-\zeta_2(n-\tilde{m})}. \quad (35)$$

As the components of the sum are a function of n only through the combination $n-\tilde{m}$, we can change the summation to run on $n-\tilde{m}$. In light of Eq. (27) the sum is time independent. In Fig. 4 we show the summand as a function of time and $n-\tilde{m}$.

B. The Forced 2nd order steady state solution

For the forced solution we can use again the fact that the statistics of the velocity field has no correlation with the forcing of the passive scalar field at any time. Therefore we have:

$$\langle |\theta_n(t)|^2 \rangle_f = \int_0^t \sum_k \mathcal{P}_{n|k}^{(2)}(t-t') \langle |f_k(t')|^2 \rangle dt'. \quad (36)$$

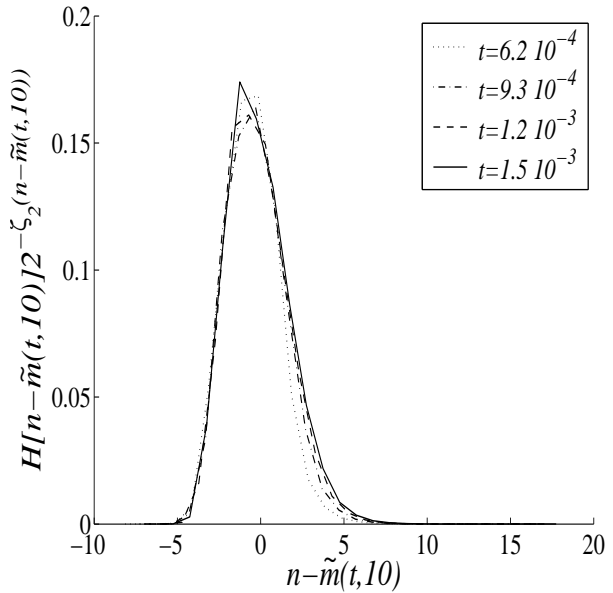

FIG. 4. The summand $H(n-\tilde{m})2^{-\zeta_2(n-\tilde{m})}$ as a function of $n-\tilde{m}$.

We should think of this equation only in the limit of $t \rightarrow \infty$, since we need to eliminate the effects of exponentially decaying initial value terms that do not contribute to the stationary forced correlation function. With a force which is Gaussian white noise, we write $\langle |f_k(t)|^2 \rangle = f^2 \delta_{k,m}$. Using Eq. (34) for the propagator we get:

$$\langle |\theta_n(t)|^2 \rangle_f \propto f^2 \int_0^{t-\tau_m} H(n-\tilde{m}(t-t', m)) \times 2^{-\zeta_2(m-\tilde{m}(t-t', m))} dt'. \quad (37)$$

We remind the reader that τ_m is the time it takes for the initial δ -function to develop a “scaling tail” for $n > m$, and now m is the shell at which the random forcing is localized. The idea here is to use the fact that we know how to eliminate the time variable in favor of the moving scale variable $\tilde{m}(t, m)$. Changing variables of integration to \tilde{m} , using Eq. (32) we can write explicitly for $\tilde{m} \ll n$:

$$\langle |\theta_n(t)|^2 \rangle_f \propto \zeta_2 \ln(2) f^2 \times \int_{-\infty}^m 2^{-\zeta_2(n-\tilde{m})} 2^{-\zeta_2(m-\tilde{m})} 2^{-\zeta_2 \tilde{m}} d\tilde{m}. \quad (38)$$

Note that we have extended in a formal manner the range of shell indices all the way to $-\infty$, to allow for a long development of a self similar solution. Naturally, since the integral converges quickly, this is immaterial. Finally, using (17):

$$F_n^{(2)} = \text{Const} \times 2^{-\zeta_2 n}. \quad (39)$$

This solution has the expected $2^{-\zeta_2 n}$, and is time independent.

We note at this point that the forced solution $F_n^{(2)}$ had been shown to be a *left* eigenfunction of eigenvalue 1 in Eq. (35). Thus the first two subsections together fully demonstrate the two conjectures (i) and (ii) from the introduction for the case of the second order objects.

C. Why this simple time dependence?

The knowledgeable reader might have noticed at this point that the explicit time dependence of the 2nd order propagator, as displayed in Eq. (24) is very simple. The exponent of time, t^{-1} , is not anomalous, and appears independent of the second order exponent of the velocity field. This is not so in the understood example of the Kraichnan model of passive scalar advection, in which the time dependence of the operator is anomalous [15,11]. To clarify this point we turn to the analysis of the passive scalar shell model driven by a δ -correlated velocity field [6]. In other words, for the velocity field u in Eq. (11), we use a Gaussian field, δ -correlated in time, that satisfies:

$$\begin{aligned} \langle u_n(t)u_m^*(t') \rangle &= \delta_{n,m}\delta(t-t')C_n, \\ C_n &= C_0 2^{-\xi n}, \end{aligned} \quad (40)$$

The calculations are described in Appendix A, with the following results:

$$\frac{d}{dt} \langle |\theta_n(t)|^2 \rangle = M_{n,m}^{(2)} \langle |\theta_m(t)|^2 \rangle \quad (41)$$

Where the matrix $M^{(2)}$ is given by

$$M_{n,m}^{(2)} = -\frac{2\delta_{n,m}}{\tau_n^{-1} + \tau_{n+1}^{-1}} + \frac{2\delta_{m,n+1}}{\tau_n} + \frac{2\delta_{m,n-1}}{\tau_{n+1}}. \quad (42)$$

Here $\tau_n \equiv 2^{-(2-\xi)n}/k_0 C_0$. Since this matrix is time independent we have

$$\mathcal{P}_{n|m}^{(2)}(t) = [\exp(tM^{(2)})]_{n,m}. \quad (43)$$

It is straightforward to check that the 2nd order forced solution $\langle |\theta_n|^2 \rangle_f \sim 2^{-(2-\xi)n} \sim \tau_n$ is a zero mode of $M^{(2)}$. In this case it is also straightforward to prove that $I^{(2)}$ in Eq. (20) is a conserved variable (in the infinite system limit). To do so we note that on the one hand from Eq. (A5) we have the following exact equation:

$$\frac{d}{dt} \sum_{n=1}^d \langle |\theta_n(t)|^2 \rangle = -\frac{\langle |\theta_d(t)|^2 \rangle}{\tau_{d+1}}. \quad (44)$$

The explicit form of the quantity $I^{(2)}$ is in this case

$$I^{(2)} = \sum_m \tau_m \langle |\theta_m(t)|^2 \rangle \quad (45)$$

The rate of change of this object is

$$\frac{d}{dt} \sum_m \tau_m \langle |\theta_m(t)|^2 \rangle = \sum_{m,n} \tau_m M_{m,n}^{(2)} \langle |\theta_n(t)|^2 \rangle \quad (46)$$

Using the properties of $M^{(2)}$ we can write:

$$\frac{d}{dt} \sum_n \tau_n \langle |\theta_n(t)|^2 \rangle = -\langle |\theta_d(t)|^2 \rangle. \quad (47)$$

Taking the ratio of Eq. (44) and Eq. (47) we see that for the limit $d \rightarrow \infty$ the quantity $I^{(2)}$ is conserved with respect to the sum $\sum_m \langle |\theta_m(t)|^2 \rangle$.

Now write the propagator in the form pertaining to $t \gg \tau_m$,

$$\mathcal{P}_{n|m}^{(2)}(t) = c \left(\frac{\tau_m}{t} \right)^\alpha H(n - \tilde{m}(t, m^*)), \quad (48)$$

with

$$\tilde{m}(t) = m_0 - \frac{1}{2-\xi} \log_2(t/\tau_m). \quad (49)$$

Write now the conservation law just proven as

$$I^{(2)} = \sum_n \tau_n \mathcal{P}_{n|m}^{(2)}(t) \approx \text{Const.} \quad (50)$$

Using the form (48) we require

$$\sum_n H(n - \tilde{m}(t, m^*)) 2^{-(2-\xi)(n - \alpha \tilde{m}(t, m^*))} = \text{Const.} \quad (51)$$

Obviously, this is constant iff $\alpha = 1$, demonstrating the point that the explicit time dependence in our propagator is not anomalous.

IV. THE 4TH ORDER PROPAGATOR

A. Simulations

The 4th order propagator is defined by:

$$\langle |\theta_n(t)|^2 |\theta_m(t)|^2 \rangle = \mathcal{P}_{n,m|p,q}^{(4)}(t) \langle |\theta_p(0)|^2 |\theta_q(0)|^2 \rangle. \quad (52)$$

We remind the reader that the LHS has also contributions from other initial conditions, i.e. $\langle \theta_{n+2}(0)\theta_{n+1}^*(0)\theta_{n+1}^*(0)\theta_{n-1}(0) \rangle$ but these contributions appear in the numerics to be very small, and will not be considered in this paper. For δ -function initial conditions (say on shell p) it is sufficient to consider $\mathcal{P}_{n,m|p,p}^{(4)}(t)$. For $m, n \ll p, q$ and for large times, $\mathcal{P}_{n,m|p,q}^{(4)}(t)$ is indistinguishable from $\mathcal{P}_{n,m|p,p}^{(4)}(t)$.

First we studied the typical time dependence of the operator via direct simulations. In Fig. 5 we plot the diagonal elements $\mathcal{P}_{n,n|25,25}^{(4)}(t)$ as functions of n for different times. Note the movement of the peak and the decay of the function. This is very similar to what we

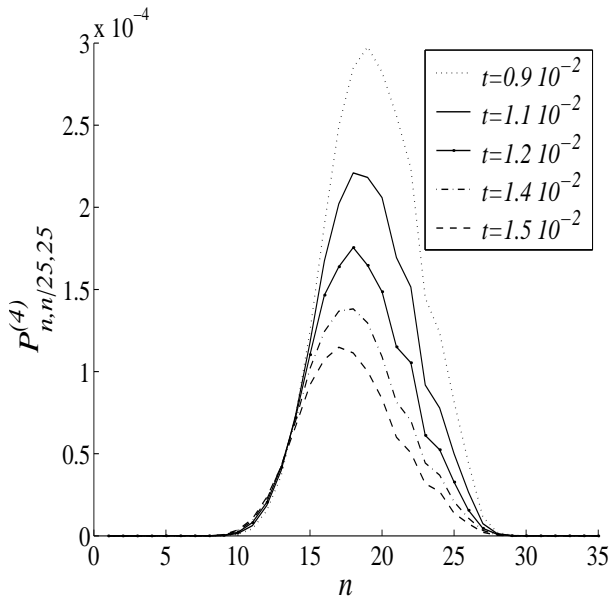

FIG. 5. The diagonal elements of $\mathcal{P}_{n,n|25,25}^{(4)}(t)$ as functions of n for five different times. The simulations were performed with 30 shells.

found for the second order propagator. In order to proceed we need to guess an analytic form for the propagator and compare it with the numerical data.

Our ansatz for the 4th order propagator is constructed using the fusion rules [16]. For the forced 4th order correlation functions the fusion rules predict that asymptotically for $|n - m| \gg 1$

$$F_{n,m}^{(4)} \propto 2^{-\zeta_4 \min(m,n)} 2^{-\zeta_2 |m-n|}. \quad (53)$$

This form was amply tested and demonstrated for shell models in [17]. It was shown that the asymptotic form is obtained very rapidly, for any $|n - m| \geq 1$. Accordingly we expect that

$$\mathcal{P}_{n,m|p,p}^{(4)}(t) = \left(\frac{\tau_p}{t}\right)^{\zeta_4/\zeta_2} G\left(\min(m,n) - \tilde{m}(t,p)\right) 2^{-\zeta_2 |m-n|} \quad (54)$$

where the function $\tilde{m}(t,p)$ is the same as in Eq. (32) but with p replacing m . The function $G(x)$ is expected to have, for $x \gg 0$, the scaling form:

$$G(x) \propto 2^{-\zeta_4 x}. \quad (55)$$

The form (54) is very well supported by the data. In Fig. 6 we replot the data of Fig. 5 multiplied by t^{ζ_4/ζ_2} , as a function of $n - \tilde{m}(t, 25)$, where $\tilde{m}(t, 25)$ solves Eq. (32). It is obvious that the form (54) is justified for the diagonal.

It is more difficult to demonstrate the full tensor by direct simulations; the off-diagonal elements are more noisy, and the scaling behavior is somewhat less apparent than on the diagonal. We can however obtain much better data for the Kraichnan model, for which $\mathcal{P}_{n,m|p,p}^{(4)}(t)$

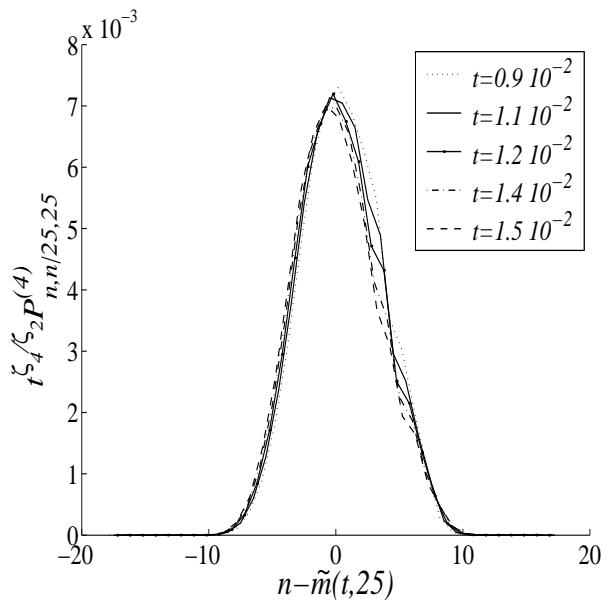

FIG. 6. The diagonal elements of $t^{\zeta_4/\zeta_2} \mathcal{P}_{n,n|25,25}^{(4)}(t)$ as a function of $n - \tilde{m}(t, 25)$.

can be computed essentially analytically. In Appendix A we present the derivation. Here we show in Fig. 7 $\mathcal{P}_{n,m|18,18}^{(4)}(t)$ for three different times. The spread and decay are apparent. In Fig. 8 the same data is shown after multiplying it by t^{ζ_4/ζ_2} , and replotting it as a function of $(n - \tilde{m}(t, 18), m - \tilde{m}(t, 18))$. Now the function is preserved with respect to time.

V. CONSEQUENCES OF THE FORM OF THE 4TH ORDER PROPAGATOR

A. The 4th order constant of the motion

According to the conjectures discussed in the introduction (in particular Eq. (10)), we expect the forced solution $F^{(4)}$ to act as the *left* eigenfunction of eigenvalue 1, Z^4 . Here we demonstrate that $I^{(4)}$ as defined by Eq. (21) is indeed a constant of the motion. Using for $F^{(4)}$ Eq. (53), and expressing t^{ζ_4/ζ_2} in terms of \tilde{m} we get:

$$I^{(4)}(t) = \sum_{n,m} G\left(\min(m,n) - \tilde{m}(p,t)\right) \times 2^{-2\zeta_2 |m-n|} 2^{-\zeta_4 (\min(m,n) - \tilde{m}(p,t))} \quad (56)$$

As in Eq. (35), the time dependance of the sum is eliminated because time is introduced only through the expression $\min(m,n) - \tilde{m}(p,t)$. Consequently the object $I^{(4)}$ becomes time independent. We demonstrate this invariance for the diagonal part of the summand in Fig. 9. To display the invariance for the whole weighted tensor we employ again the data presented in Fig. 7. After

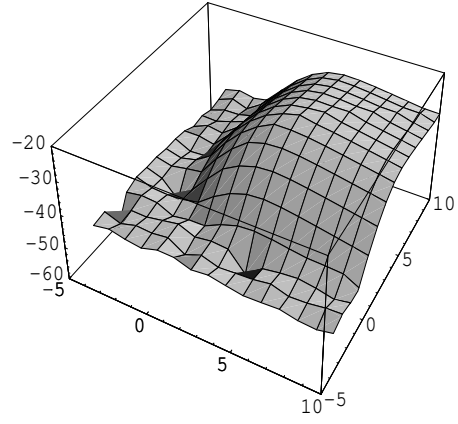
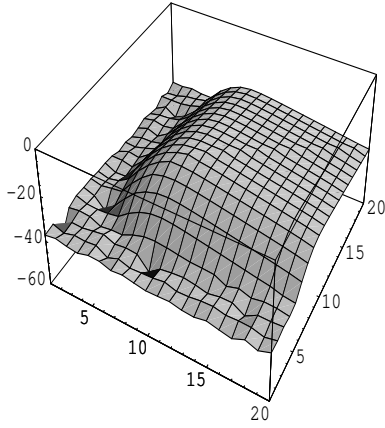
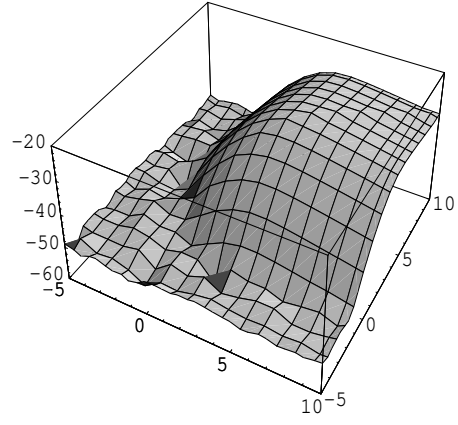
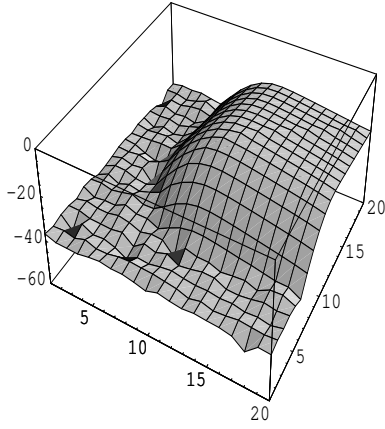
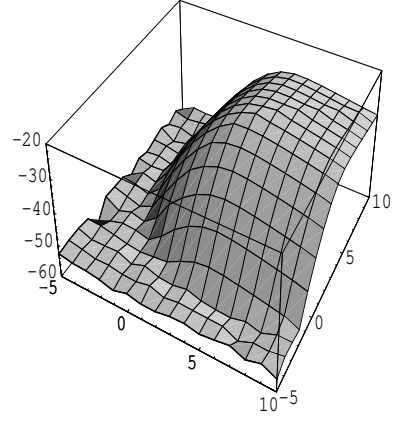
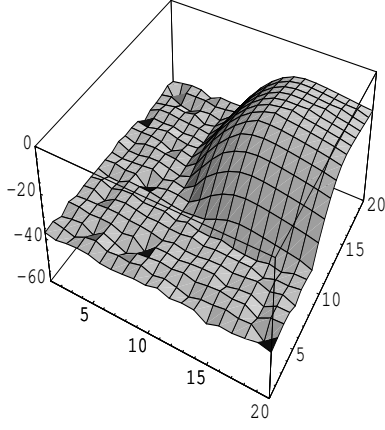

FIG. 7. The logarithm of the elements of $\mathcal{P}_{n,m|18,18}^{(4)}(t)$ for the Kraichnan shell model as a function of n and m for the three different times $1.54 \times 10^{-6} \tau_0$ (panel a), $1.67 \times 10^{-5} \tau_0$ (panel b) and $1.74 \times 10^{-4} \tau_0$ (panel c).

FIG. 8. The logarithm of the elements of $t^{\zeta_4/\zeta_2} \mathcal{P}_{n,m|18,18}^{(4)}(t)$ for the Kraichnan shell model as a function of $(n - \tilde{m}(t, 18), m - \tilde{m}(t, 18))$. The times are the same as in Fig. 7. The invariance of the function is obvious.

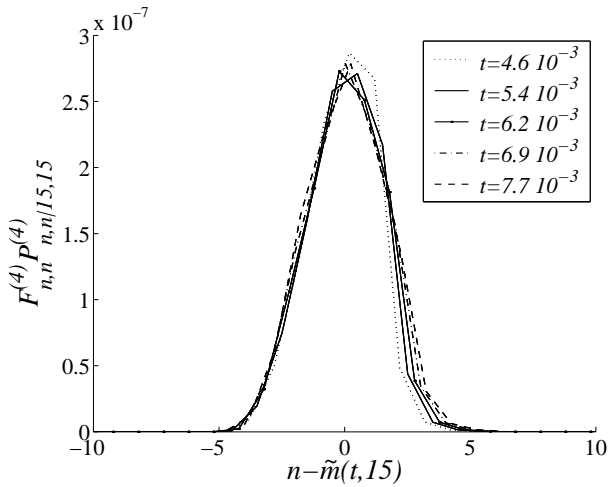

FIG. 9. The weighted elements $F_{n,n}^{(4)} \mathcal{P}_{n,n|15,15}^{(4)}(t)$ as a function of $n - \tilde{m}(t, 15)$.

multiplication by the weights $F_{n,m}^{(4)}$ and replotting in moving coordinates, the constancy of the summand of $I^{(4)}$ is demonstrated. This is done in Fig. 10, using the analytic results of Appendix A.

B. The forced 4th order steady state solution

Finally, we can calculate the analog of Eq. (36), for the steady state 4-point function in a system forced by gaussian white noise. Returning to Eq. (14) we write

$$F_{n,m}^{(4)} = \int_0^t \cdots \int_0^t ds_1 \cdots ds_4 \langle R_{n,p}(t|s_1) R_{n,p'}^*(t|s_2) R_{m,q}(t|s_3) R_{m,q'}^*(t|s_4) \rangle \langle f_p(s_1) f_{p'}^*(s_2) f_q(s_3) f_{q'}^*(s_4) \rangle, \quad (57)$$

where we have used the statistical independence of the forcing from the velocity field. We note that in Eq. (57) the time integration can be (and should be) extended to arbitrarily long times, to get a stationary forced correlation function. This way we also get rid of exponentially decaying initial value terms. Using the correlation properties of the forcing Eq. (16) we obtain

$$F_{n,m}^{(4)}(t) = 2C_p C_q \int_0^t ds_1 \int_0^t ds_2 \langle |R_{n,p}(t|s_1)|^2 |R_{m,q}(t|s_2)|^2 \rangle. \quad (58)$$

We next split the integral into two domains in which $s_2 \leq s_1$ and the opposite. Consider the first domain in which the integral on the RHS has the form

$$\int_0^t ds_1 \int_0^{s_1} ds_2 \langle |R_{n,p}(t|s_1)|^2 |R_{m,q}(t|s_2)|^2 \rangle = \int_0^t ds_1 \int_0^{s_1} ds_2 \langle |R_{n,p}(t|s_1)|^2 |R_{m,\ell}(t|s_1)|^2 |R_{\ell,q}(s_1|s_2)|^2 \rangle. \quad (59)$$

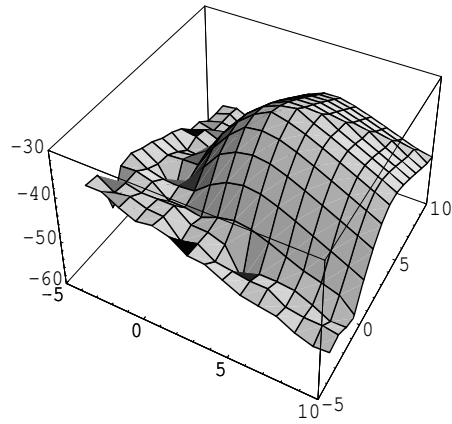
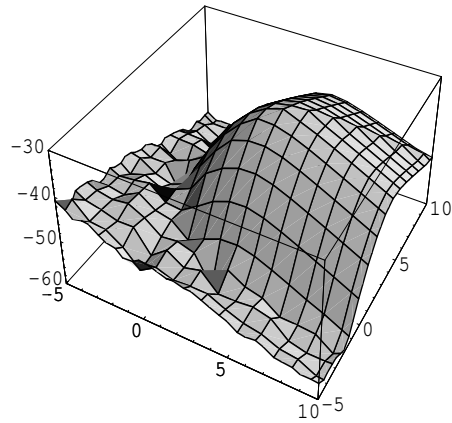
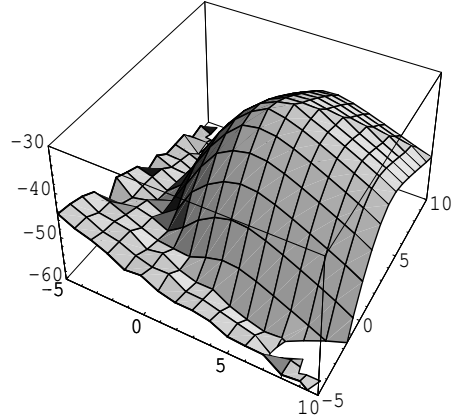

FIG. 10. The elements of $F_{n,m}^{(4)} \mathcal{P}_{n,m|18,18}^{(4)}(t)$ for the Kraichnan shell model as a function of $(n - \tilde{m}(t, 18), m - \tilde{m}(t, 18))$. The times are the same as in Fig. 7. The invariance of the function is obvious.

To proceed we need to consider the decay time of the operator $R_{n,m}(t|t_0)$ compared to the decorrelation properties of products of such operators *at different times*. On the one hand we know that these operators depend explicitly on time, decaying like a power of time (cf. Eq. (54)). On the other hand, we expect the correlation of products of different time operators to decay exponentially, since the operators $R_{n,m}(t|t_0)$ contain the chaotic velocity field that appears in the exponential, cf. Eq. (14). The time domain is arbitrarily long, but throughout most of the time integration the product is actually decorrelated, and we can write

$$\int_0^t ds_1 \int_0^{s_1} ds_2 \langle |R_{n,p}(t|s_1)|^2 |R_{m,\ell}(t|s_1)|^2 |R_{\ell,q}(s_1|s_2)|^2 \rangle \approx \int_0^t ds_1 \langle |R_{n,p}(t|s_1)|^2 |R_{m,\ell}(t|s_1)|^2 \rangle \int_0^{s_1} ds_2 \langle |R_{\ell,q}(s_1|s_2)|^2 \rangle. \quad (60)$$

We can now perform the integral over s_2 , with a result independent of either s_1 or t . Finally, if we choose the forcing in Eq. (57) as a single shell forcing on the shell p , $\langle |f_k(t)|^2 |f_\ell(t)|^2 \rangle = C_p^4 \delta_{k,p} \delta_{\ell,p}$ we get:

$$F_{n,m}^{(4)} \propto 2^{-\zeta_2|m-n|} \int_0^{t-\tau_p} \left(\frac{\tau_p}{t-t'} \right)^{\zeta_4/\zeta_2} \times 2^{-\zeta_4(\min(m,n)-\tilde{m}(t-t',p))} dt', \quad (61)$$

where we have used the analytic asymptotic form of $\mathcal{P}_{n,m|p,p}^{(4)}(t)$, Eq. (54). Changing the integration variable to $\tilde{m}(t-t',p)$ we get:

$$F_{n,m}^{(4)} \propto 2^{-\zeta_2|m-n|} 2^{-\zeta_4(\min(m,n))} \times \int_{-\infty}^p 2^{2\zeta_4\tilde{m}} 2^{-\zeta_2\tilde{m}} d\tilde{m}, \quad (62)$$

or, we find a time independent solution:

$$F_{n,m}^{(4)} = \text{Const} \times 2^{-\zeta_2|m-n|} 2^{-\zeta_4 \min(m,n)} \quad (63)$$

As expected, this is the correct form of the 4th order correlation function, in agreement with the fusion rules.

The theory for the sixth and higher order correlation functions follows the same lines, and will not be reproduced here.

VI. SUMMARY AND CONCLUDING REMARKS

In summary, we examined in detail the statistical physics of the shell model of a passive scalar advected by a turbulent velocity field. We presented a theory to explain and solidify the two conjectures proposed in [5] and reproduced in the introduction. These conjectures state that (i) in the decaying problem there exist infinitely many statistically conserved quantities, denoted above as $I^{(N)}$; (ii) These quantities are obtained by integrating (or summing) the decaying correlation functions against the stationary correlation functions of the

forced problem. We have pointed out that the conjectures imply that the forced solutions are *left*-eigenvectors of eigenvalue 1 of the propagators $\mathcal{P}^{(N)}$. For the model discussed above we have established these conjectures by examining the form of the propagators $\mathcal{P}^{(N)}$. Using numerical simulations as a clue, we proposed analytic expressions for the operators $\mathcal{P}^{(2)}$ and $\mathcal{P}^{(4)}$, pointing out that similar concepts (fusion rules [16] in particular) can be used to write down also the higher order operators. We checked the analytic forms against the simulations, and proceeded to demonstrate that the forced, stationary correlation functions are indeed left-eigenvectors of eigenvalue 1 of these operators. This implies that the objects $I^{(N)}$ are indeed constants of the motion. Next we derived the forced, stationary correlation functions, and showed that the form of our operators dictates scaling solutions in agreement with the fusion rules. As a result the two conjectures were confirmed. In our analytic calculations we used repeatedly the fact that the operators “compactify” in shell-space once expressed in terms of a single moving scale whose dynamics was determined analytically.

One should state a caveat at this point: the analytic form of the operators $\mathcal{P}^{(2)}$ and $\mathcal{P}^{(4)}$ was *guessed* on the basis of numerics and the fusion rules. Although they appear to agree with the simulations, we cannot state that the forms are *exact*. Accordingly, until these forms are derived from first principles, the exact status of the conjectures is not established. It may be that the conjectures are only satisfied to a good approximation. This question needs to be addressed in future research.

Notwithstanding this caveat, we should point out a surprising bonus of the approach discussed in this paper: we have at hand an analytic form of the propagators. *We can thus provide analytic predictions for the decaying correlation functions for arbitrary initial conditions*. Considering that the velocity field is a solution of a highly non-trivial chaotic dynamical system, and that the passive scalar is slaved to it, it is quite gratifying that nevertheless one can offer analytic solutions for the time-dependent correlation functions of the latter. It is of course very tempting to hope that a similar theory can be developed in other cases of turbulent transport, leading to analytic predictability of the time-dependent correlation functions in the decaying case. Since this paper demonstrated that the Lagrangian structure is not a prerequisite for the existence of Statistically Preserved Structures, we feel that such a theory should be sought in the Eulerian frame in which calculations are much easier than in the Lagrangian frame. This development should be addressed by future research.

ACKNOWLEDGMENTS

It is a pleasure to acknowledge extensive discussions with I. Arad, L. Biferale, A. Celani, K. Gawedzki,

P. Muratore-Ginanneschi and M. Vergassola. Special thanks are due to L. Biferale for sharing with us his numerical results, and to L. Biferale, A. Celani and M. Vergassola for a critical reading of a draft of this paper. This work has been supported in part by the European Union under the TMR program “nonideal turbulence”, the German Israeli Foundation and the Naf-tali and Anna Backenroth-Bronicki Fund for Research in Chaos and Complexity. TG thanks the Israeli Council for Higher Education and the Feinberg postdoctoral Fel-lowships program at the WIS for financial support.

APPENDIX A: THE KRAICHNAN SHELL MODEL

For the velocity field u in Eq. (11) we use a Gaussian, delta-correlated in time field that satisfies:

$$\begin{aligned} \langle u_n(t)u_m^*(t') \rangle &= \delta_{n,m}\delta(t-t')C_n, \\ C_n &= C_0 2^{-\xi n}, \end{aligned} \quad (\text{A1})$$

For this simple model we can find a closed form equation for the time derivative of $\mathcal{P}^{(2)}(t)$. For simplicity we set the diffusivity $\kappa = 0$, and replace its effect by truncating the operator at the dissipative shell d (cf. Eq. (30)).

1. The 2nd order operator

We evaluate the 2nd order propagator’s time derivative by multiplying Eq. (11) by θ_n^* and adding the complex conjugate to get:

$$\begin{aligned} \frac{d}{dt} \langle |\theta_n(t)|^2 \rangle &= ik_{n+1} \langle u_{n+1}(t)\theta_{n+1}(t)\theta_n^*(t) \rangle \\ &+ ik_n \langle u_n^*(t)\theta_n^*(t)\theta_{n-1}(t) \rangle + C.C, \end{aligned} \quad (\text{A2})$$

Using Gaussian integration by parts we compute the 3rd order correlation functions including the velocity:

$$\begin{aligned} \langle \theta_n^*(t)\theta_m(t)u_m(t) \rangle &= \int dt' \sum_p \langle u_m(t)u_p^*(t') \rangle \\ &\times \left[\langle \frac{\delta\theta_n^*(t)}{\delta u_p^*(t')} \theta_m(t) \rangle + \langle \theta_n^*(t) \frac{\delta\theta_m(t)}{\delta u_p^*(t')} \rangle \right]. \end{aligned} \quad (\text{A3})$$

From Eq. (11) we have for the functional derivatives:

$$\begin{aligned} \frac{\delta\theta_p(t)}{\delta u_q^*(t')} &= i\Theta(t-t')\delta_{p,q}k_q\theta_{q-1}(t'), \\ \frac{\delta\theta_p^*(t)}{\delta u_q^*(t')} &= -i\Theta(t-t')\delta_{p+1,q}k_q\theta_q^*(t'), \end{aligned} \quad (\text{A4})$$

where $\Theta(t)$ is the step function, $\Theta(t) = 0, t < 0, \Theta(t) = 1, t > 0, \Theta(0) = 1/2$. Plugging Eqs.(A1), (A4) into Eq. (A3), Eq. (A2) becomes

$$\begin{aligned} \frac{d}{2dt} \langle |\theta_n(t)|^2 \rangle &= C_{n+1}k_{n+1}^2 \langle |\theta_{n+1}(t)|^2 \rangle + C_n k_n^2 \langle |\theta_{n-1}(t)|^2 \rangle \\ &- (C_n k_n^2 + C_{n+1}k_{n+1}^2) \langle |\theta_n(t)|^2 \rangle. \end{aligned} \quad (\text{A5})$$

This can be written in matrix form as:

$$\frac{d}{dt} \langle |\theta_n(t)|^2 \rangle = M_{n,m}^{(2)} \langle |\theta_m(t)|^2 \rangle \quad (\text{A6})$$

Where the matrix $\mathbf{M}^{(2)}$ is given by Eq. (42). It is time independent and thus a solution for $\mathcal{P}_{n|m}^{(2)}(t)$, defined in Eq. (36), can be written as Eq. (43)

2. The 4th order operator

Let us consider the propagator of the 4-point correlation function $\langle |\theta_n(t)|^2 |\theta_m(t)|^2 \rangle$:

$$\frac{d}{dt} \langle |\theta_n(t)|^2 |\theta_m(t)|^2 \rangle = M_{n,m,p,q}^{(4)} \langle |\theta_p(t)|^2 |\theta_q(t)|^2 \rangle, \quad (\text{A7})$$

where the operator $\mathbf{M}^{(4)}$ can be computed in analogy to Eqs. (A5), (A6), (42):

$$\begin{aligned} M_{n,m,p,q}^{(4)} &= \\ &\frac{1}{2} \left(M_{n,p}^{(2)}\delta_{m,q} + M_{n,q}^{(2)}\delta_{m,p} + \delta_{n,p}M_{m,q}^{(2)} + \delta_{n,q}M_{m,p}^{(2)} \right) \\ &+ 2\tau_n^{-1} \left(\delta_{n,m} - \delta_{n,m+1} \right) \left(\delta_{n,p}\delta_{n-1,q} + \delta_{n,q}\delta_{n-1,p} \right) \\ &+ 2\tau_{n+1}^{-1} \left(\delta_{n,m} - \delta_{n+1,m} \right) \left(\delta_{n,p}\delta_{n+1,q} + \delta_{n,q}\delta_{n+1,p} \right). \end{aligned} \quad (\text{A8})$$

We note that $\mathbf{M}^{(4)}$ is not symmetric under the exchange of left and right indices, i. e. $M_{n,m,p,q}^{(4)} \neq M_{p,q,n,m}^{(4)}$, and thus admits different left and right eigenvectors. The zero-mode of Eq. (A7) satisfies

$$M_{n,m,p,q}^{(4)} Y_{p,q}^{(4)} = 0, \quad (\text{A9})$$

and is expected to be a symmetric function of the form

$$Y_{n,m}^{(4)} = 2^{-\zeta_4 \min(m,n)} f^R(|m-n|). \quad (\text{A10})$$

Equivalently one can consider a *left* zero-mode of $\mathbf{M}^{(4)}$, which we denoted above by $\mathbf{Z}^{(4)}$ (cf. Eq. (9)),

$$M_{p,q,n,m}^{(4)} Z_{p,q}^{(4)} = 0, \quad (\text{A11})$$

$$Z_{n,m}^{(4)} = 2^{-\zeta_4 \min(m,n)} f^L(|m-n|). \quad (\text{A12})$$

We will show that both left and right zero modes have overall scaling exponent ζ_4 , multiplied by a function $f^{\text{R/L}}(|m-n|)$, which scales like $2^{-\zeta_2|m-n|}$ provided $|m-n| \gg 1$, in agreement with the fusion rules. We therefore propose the following ansatz

$$f^{\text{R/L}}(q) = \sum_{j=1}^{\infty} a_j^{\text{R/L}} \tau_q^j, \quad q > 0. \quad (\text{A13})$$

Plugging this ansatz into Eqs. (A9), (A11), we find three different cases : (i) $m = n$, (ii) $m = n \pm 1$ and (iii) $|m - n| > 1$. This last case, which is identical for both left and right equations, reads (assuming $m > n + 1$)

$$\begin{aligned} & (\tau_n^{-1} + \tau_m^{-1} + \tau_{n+1}^{-1} + \tau_{m+1}^{-1})f^{\text{R/L}}(m - n) \\ &= \tau_{m+1}^{-1}f^{\text{R/L}}(m - n + 1) + \tau_m^{-1}f^{\text{R/L}}(m - n - 1) \\ &+ \tau_{n+1}^{-1}2^{-\zeta_4}f^{\text{R/L}}(m - n - 1) + \tau_n^{-1}2^{\zeta_4}f^{\text{R/L}}(m - n + 1), \end{aligned} \quad (\text{A14})$$

which, defining $\beta = \zeta_4 - 2\zeta_2$, yields the following recursion relation for the coefficients $a_j^{\text{R/L}}$ in Eq. (A13),

$$a_j^{\text{R/L}} = -\frac{1 + \tau_1^{-1} - 2^{-\beta}\tau_{j-2}^{-1} - 2^{\beta}\tau_{j-3}^{-1}}{1 + \tau_1^{-1} - \tau_{j-1}^{-1} - \tau_j^{-1}}a_{j-1}^{\text{R/L}} \quad j \geq 2. \quad (\text{A15})$$

It then remains to determine β , $f^{\text{R/L}}(0)$ and $a_1^{\text{R/L}}$, which is done with the help of cases (i) and (ii) above. In the case of the right zero-mode, we have

$$(1 + \tau_1^{-1})f^{\text{R}}(0) = 2\tau_1^{-1}(1 + 2^{\beta}\tau_1^{-1})f^{\text{R}}(1), \quad (\text{A16})$$

$$\begin{aligned} (1 + 4\tau_1^{-1} + \tau_2^{-1})f^{\text{R}}(1) &= (\tau_1^{-1} + 2^{-\beta}\tau_1)f^{\text{R}}(0) \\ &+ (1 + 2^{\beta})\tau_2^{-1}f^{\text{R}}(2), \end{aligned} \quad (\text{A17})$$

whereas the left zero-mode yields

$$(1 + \tau_1^{-1})f^{\text{L}}(0) = \tau_1^{-1}(1 + 2^{\beta}\tau_1^{-1})f^{\text{L}}(1), \quad (\text{A18})$$

$$\begin{aligned} (1 + 4\tau_1^{-1} + \tau_2^{-1})f^{\text{L}}(1) &= 2(\tau_1^{-1} + 2^{-\beta}\tau_1)f^{\text{L}}(0) \\ &+ (1 + 2^{\beta})\tau_2^{-1}f^{\text{L}}(2). \end{aligned} \quad (\text{A19})$$

We note that, provided we impose $f^{\text{L}}(0) = 1/2f^{\text{R}}(0)$, which amounts to fixing the arbitrary relative multiplicative factor between $\mathbf{Y}^{(4)}$ and $\mathbf{Z}^{(4)}$, we obtain two identical solutions, i. e. $a_j^{\text{R}} = a_j^{\text{L}} \forall j \geq 1$. The anomaly β is then the same for both systems of equations and can be determined numerically.

- [6] R. Benzi, L. Biferale and A. Wirth, Phys. Rev. Lett. **78**,4926 (1997)
- [7] V. S. L'vov, E. Podivilov, A. Pomyalov, I. Procaccia and D. Vandembroucq, Phys. Rev. E. **58**, 1811 (1998).
- [8] O. Gat and R. Zeitak, Phys. Rev. E **57**,5331 (1998).
- [9] O. Gat, I. Procaccia and R. Zeitak, Phys. Rev. Lett., **80**, 5536 (1998).
- [10] U. Frisch, A. Mazzino and M. Vergassola, Phys. Rev. Lett., **80**, 5532 (1998).
- [11] D. Bernard, K. Gawędzki and A. Kupiainen, J. Stat. Phys. **90**, 519 (1998).
- [12] I. Arad and I. Procaccia "Anomalous Scaling in Passive Scalar Advection and Lagrangian Shape Dynamics", Proceedings of IUTAM Symposium on Geometry and Statistics of Turbulence" eds. T. Kambe, T. Nakano and T. Miyauchi, (Kluwer 2001).
- [13] A. Celani and M. Vergassola, Phys. Rev. Lett., **86**, 424 (2001)
- [14] A. Celani and A. Mazzino, unpublished (2000).
- [15] R. H. Kraichnan, Phys. Rev. Lett., **52**, 1016 (1994).
- [16] V. S. L'vov and I. Procaccia, Phys. Rev. Lett., **76** , 2896 (1996).
- [17] L. Biferale, G. Boffetta, A. Celani and F. Toschi, Physica D**127**,187 (1999).

-
- [1] A.S. Monin and A.M. Yaglom, *Statistical Fluid Mechanics*, vol. 1, chapter 5, (MIT, Cambridge 1979).
 - [2] G.T. Csanady, *Turbulent Diffusion in the Environment*, (D. Reidel, Dodrecht 1980).
 - [3] Ya. B. Zeldovich, A. A. Ruzmaikin and D. D. Sokoloff, *Magnetic Fields in Astrophysics* Gordon and Breach Publ. (1983).
 - [4] I. Arad and I. Procaccia "Spectrum of Anisotropic Exponents in Hydrodynamic Systems with Pressure", Phys. Rev. E, **63**, 056302 (2001)
 - [5] I. Arad, L. Biferale, A. Celani, I. Procaccia and M. Vergassola, "Statistical Conservation Laws in Turbulent Transport", submitted to Phys. Rev. Lett., also nlin.CD/0104027.