

ON A MAP FROM PURE BRAIDS TO KNOTS

JACOB MOSTOVOY AND THEODORE STANFORD

We study a certain type of braid closure which resembles the plat closure but has certain advantages; for example, it maps pure braids to knots. The main results of this note are a Markov-type theorem and a description of how Vassiliev invariants behave under this braid closure.

1. DEFINITION AND PROPERTIES OF THE SHORT-CIRCUIT MAP.

We define the “short-circuit” map \mathcal{S}_n from the pure braid group on $2n + 1$ strands \mathcal{P}_{2n+1} to the monoid of the isotopy classes of oriented knots \mathcal{K} as pictured on Figure 1. The strands of the braid are joined together in turn at the bottom and at the top. We think of knots as of non-compact, or “long” knots here. These

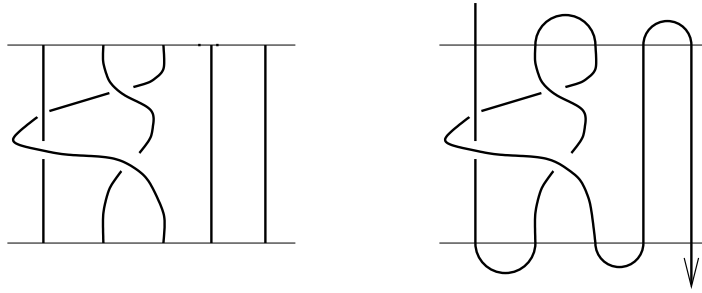
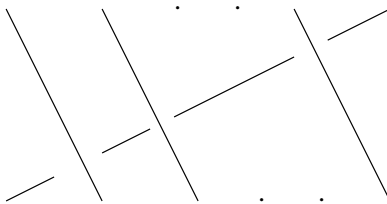

FIGURE 1. A braid $b \in \mathcal{P}_5$ and the knot $\mathcal{S}_2(b)$.

maps are compatible with the inclusions $\mathcal{P}_{2n+1} \hookrightarrow \mathcal{P}_{2n+3}$ so they extend to a map $\mathcal{S} : \mathcal{P}_\infty \rightarrow \mathcal{K}$. Here by \mathcal{P}_∞ we understand the inductive limit of the sequence of inclusions $\mathcal{P}_i \hookrightarrow \mathcal{P}_{i+1}$.

The construction and, as we will see later, some properties of the map \mathcal{S} resemble those of the plat closure which sends braids with even number of strands to links. (For the definition and properties of the plat closure see [B1, B2].) Indeed, if t_n denotes the $2n$ -strand braid pictured on Figure 2, then for any $x \in \mathcal{P}_{2n+1}$ the (unoriented) knot $\mathcal{S}(x)$ is equivalent to the knot, obtained by taking the image of x in \mathcal{P}_{2n+2} under the standard inclusion, multiplying by t_{n+1} on the left (i.e. on the top) and taking the plat closure.

However, if we are interested in knots rather than links the map \mathcal{S} is more convenient than the plat closure. The most obvious difference is the behaviour under stabilization maps and tensor products. Adding two unbraided strands to a braid changes its image under the plat closure by adding an unknotted and unlinked component, while the image of the short-circuit map does not change. As for tensor (external) products, the plat closure sends a product of braids to the distant union

FIGURE 2. The braid t_n .

of their plat closures, while under short-circuiting the tensor product of braids is sent to the connected sum of the corresponding knots.

To make the last statement more precise, we may define the tensor product of two pure braids with odd numbers of strands as follows.

Let $i : \mathcal{P}_{2n+1} \hookrightarrow \mathcal{P}_{2(n+m)+1}$ be the standard inclusion onto the first $2n+1$ strands and $i' : \mathcal{P}_{2m+1} \hookrightarrow \mathcal{P}_{2(n+m)+1}$ be the inclusion onto the last $2m+1$ strands. Then we can define a product

$$\mathcal{P}_{2n+1} \otimes \mathcal{P}_{2m+1} \rightarrow \mathcal{P}_{2(n+m)+1}$$

by sending a pair (b_1, b_2) , where $b_1 \in \mathcal{P}_{2n+1}$ and $b_2 \in \mathcal{P}_{2m+1}$ to

$$i(b_1)i'(b_2) \in \mathcal{P}_{2(n+m)+1}.$$

With this definition it is clear that

$$\mathcal{S}_n(b_1) \# \mathcal{S}_m(b_2) = \mathcal{S}_{n+m}(b_1 \otimes b_2).$$

The restriction to an odd number of strands is by no means crucial. If $b \in \mathcal{P}_{2n}$ we can define an analogue of the short-circuit map as a suitably oriented plat closure of the braid $t_n b$. This definition is equally good for the purposes of our paper and has certain advantages. Namely, this version of the short-circuit closure respects the usual tensor product of braids; also, in this set-up Theorem 1 below becomes tautological.

Nevertheless, we prefer to work with braids on odd number of strands. It follows from Theorem 1 that any knot which can be realized as a plat closure of a $2n$ -stranded braid can be obtained by short-circuiting some pure braid on $2n-1$ strands. This generalizes the well-known fact that a 2-bridge knot can be represented by a braid in \mathcal{P}_3 . In this sense, the short-circuit map for \mathcal{P}_{odd} is more “economic”. We repeat, however, that in our context this is a matter of taste.

1.1. Filtration by the number of strands and the bridge number. Any filtration on the infinite pure braid group \mathcal{P}_∞ is sent by \mathcal{S} to a filtration on knots. The most obvious filtration on \mathcal{P}_∞ to consider is the filtration “by the number of strands”

$$\mathcal{P}_1 \subset \mathcal{P}_3 \subset \mathcal{P}_5 \subset \dots \subset \mathcal{P}_\infty.$$

Theorem 1. *The filtration on knots by $\mathcal{S}(\mathcal{P}_{2n+1})$ is the filtration by knots with bridge number less than or equal to $n+1$.*

To prove Theorem 1 it is enough to show that the minimal number of maxima of the height function in a realization of a knot in \mathbf{R}^3 as a long knot is the bridge number minus 1; this will be done in Section 2.

The bridge number minus 1 is an additive knot invariant (see [Sch]) so, the filtration by $\mathcal{S}(\mathcal{P}_{2n+1})$ gives rise to an additive grading on \mathcal{K} .

1.2. Structure of the short-circuit map. First we introduce some notation. By $A_{i,j}$ where $i \neq j$ are positive integers we denote the standard generators of \mathcal{P}_∞ . By ϕ_i^n we mean the homomorphism $\mathcal{P}_{2n} \rightarrow \mathcal{P}_{2n+1}$ which doubles the i th strand. Homomorphisms ϕ_i^n respect the standard inclusions of the pure braid groups so as n tends to infinity the limit $\phi_i : \mathcal{P}_\infty \rightarrow \mathcal{P}_\infty$ is well-defined.

Let $H^T \in \mathcal{P}_\infty$ be the subgroup generated by $A_{i,i+1}$ and $\phi_i(A_{i,j})$ for all even i and all $j \neq i$. Similarly we define the subgroup H^B with the only difference that i is required to be odd. The subgroup H^T acts on \mathcal{P}_∞ on the left and this action preserves the fibres of \mathcal{S} , see Figure 3. Similarly, H^B act on \mathcal{P}_∞ on the right, also

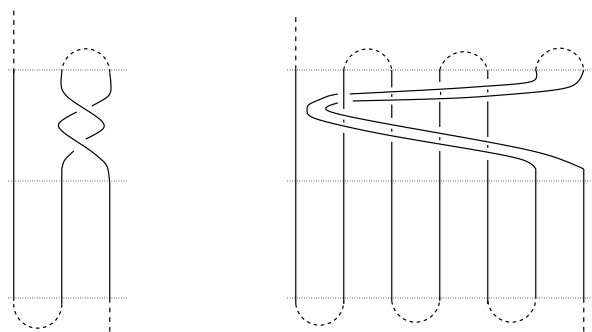

FIGURE 3. Examples of the action of H^T on the trivial braid.

preserving the fibres.

Theorem 2. *The short-circuit map identifies the monoid of knots \mathcal{K} with the quotient set $H^T \backslash \mathcal{P}_\infty / H^B$.*

This theorem is a version of the main theorem of [B2] which describes the equivalence classes of plat closures. The proof we sketch in Section 3 is simplified by the fact that we are only interested in knots. Note also that Birman's theorem as stated in [B2] concerns unoriented knot and link types, whereas our theorem concerns oriented knot types.

1.3. Lower central series and Vassiliev invariants. One can easily check that Vassiliev knot invariants pull back under the short-circuit map to Vassiliev invariants of braids. The action of H^T and H^B on \mathcal{P}_∞ induces an action on Vassiliev braid invariants which, clearly, preserves the type. (Here we do not assume the invariants to be normalized, i.e. do not require them to take a prescribed value on the trivial braid.) Thus the finite type knot invariants can be identified with those finite type pure braid invariants which are fixed by the two-sided action of H^T and H^B .

Sometimes it is more convenient, however, to think of Vassiliev invariants in the dual setting. Recall that a knot (pure braid) is called n -trivial if it cannot be distinguished from the trivial knot (braid) by invariants of order less than n . For pure braids n -triviality is well-understood: $b \in \mathcal{P}_k$ is n -trivial if and only if $b \in \gamma_n \mathcal{P}_k$ - the n -th term of the lower central series of \mathcal{P}_k .

Let $\mathcal{K}_n \subset \mathcal{K}$ be the set of n -trivial knots.

Theorem 3. *Short-circuiting sends the filtration of \mathcal{P}_∞ by the lower central series to the filtration by n -trivial knots:*

$$\mathcal{S}(\gamma_n \mathcal{P}_\infty) = \mathcal{K}_n.$$

This allows to formulate problems from the theory of Vassiliev knot invariants in purely group-theoretic terms. For example, finite type knot invariants separate the unknot if and only if any orbit of the two-sided action of H^T and H^B , apart from the orbit of the trivial braid, intersects only a finite number of terms of the lower central series. Another way to state this is to consider the nilpotent topology on \mathcal{P}_∞ (with basis the cosets of $\gamma_n \mathcal{P}_\infty$ for all n). Then finite type invariants separate the unknot if and only if the set $H^T H^B = \{tb \mid t \in H^T, b \in H^B\}$ is closed in the nilpotent topology.

The proof of Theorem 3 follows closely the same arguments as in [St]. It is even simplified in some ways in our setting. For example, if x and y are two braids, then $\mathcal{S}(x)\#\mathcal{S}(y) = \mathcal{S}(xyb) = \mathcal{S}(xy) = \mathcal{S}((t^{-1}xtx^{-1})xy)$, which is equivalent to $\mathcal{S}(xy)$ modulo a commutator. Inductively, braid product and connected sum are equivalent, modulo commutators of higher order, which is the main idea behind the results in [St].

2. BRIDGE NUMBER FOR LONG KNOTS.

Here we will see that the minimal number of maxima b_L of the “height function” in the realization of a knot in \mathbf{R}^3 as a long knot is less by 1 than the minimal number of maxima of the height function in the compact realization $S^1 \hookrightarrow \mathbf{R}^3$ of the same knot, i.e. than the bridge number b .

For a long knot with b_L maxima of the height function it is obvious that there exist a compact embedding of the same knot with $b_L + 1$ maxima, see Figure 4.

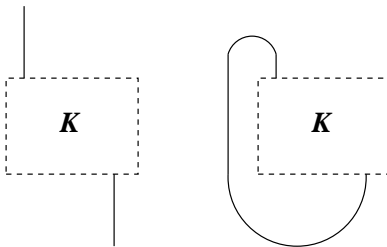

FIGURE 4. A long knot K and the corresponding compact knot.

Conversely, let k be a compact knot $S^1 \hookrightarrow \mathbf{R}^3$ with b maxima and b minima which can be taken to be non-degenerate. We construct a long knot k' with $b - 1$ maxima which is equivalent to k as follows.

Choose a point on k which is not critical for the height function to be the origin in \mathbf{R}^3 . Let A be the maximum and B the minimum between which the chosen point lies; by AB we denote the closed segment of k which lies between A and B and passes through the origin.

Let $F(t) : \mathbf{R} \rightarrow \mathbf{R}^3$ be a curve which intersects each horizontal plane once and such that its intersection with the knot k is exactly the segment AB . We can

assume that the curve F is parametrized by the z -coordinate in \mathbf{R}^3 , i.e. $F(t) = (F_x(t), F_y(t), t)$, and that F is a smooth function of t everywhere apart from the points where $F(t) = A$ or $F(t) = B$.

Consider a map $\Phi : \mathbf{R}^3 \rightarrow \mathbf{R}^3$ given by

$$\Phi(x, y, z) = (x - F_x(z), y - F_y(z), z).$$

The transformation Φ preserves the horizontal planes, so it does not change the number of maxima and minima of the height function on the knot k . It is clear that there exist such $R > 0$ that the intersection of the image of the embedding $\Phi(k)$ with the cylinder $x^2 + y^2 < R^2$ is an interval, which is embedded with exactly one minimum and one maximum of the height function. Strictly speaking, the embedding $\Phi(k)$ is only piecewise-smooth, however, we can smooth it out in such a way that its intersection with the cylindrical neighbourhood of the z -axis of radius R is an interval, which intersects the z -axis in the origin only and which is embedded with exactly one minimum and one maximum of the height function, see Figure 5(a).

Thus in what follows we can assume that k has the above form. Now we com-

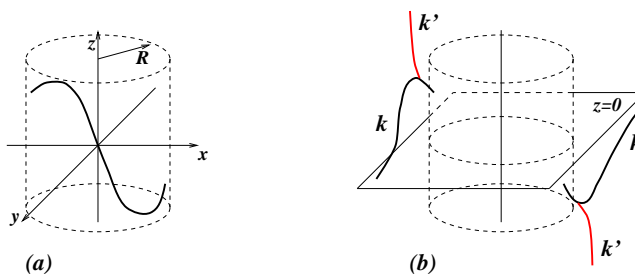

FIGURE 5.

pactify \mathbf{R}^3 to S^3 by an interval adding a point at infinity to each horizontal plane and two points $z = \pm\infty$. Denote by $V \subset S^3$ a copy of \mathbf{R}^3 obtained by throwing out the closure of the z -axis. The intersection of the knot k with V is a long knot, which is equivalent to k if we choose the orientation of V to be compatible with that of \mathbf{R}^3 . In the coordinates centred at the point at infinity whose z -coordinate is zero, this long knot looks as on Figure 5(b). Obviously, it is equivalent to the knot k' that differs from k only inside the cylindrical neighbourhood of the z -axis (which is pictured as the outside part of the cylinder on Figure 5(b)) and has exactly $b - 1$ maxima and $b - 1$ minima.

3. SHORT-CIRCUIT MAP AS A TWO-SIDED QUOTIENT MAP.

We say that a smooth long knot $k(t) : \mathbf{R} \rightarrow \mathbf{R}^3$ is a Morse knot if the height function on it: (a) has only a finite number of critical points, all of which are non-degenerate; (b) tends to $\pm\infty$ as $t \rightarrow \mp\infty$; in other words, we assume that all knots “point downwards”. Two Morse knots are Morse equivalent if one can be deformed into the other through Morse knots.

Let k be a Morse knot and x be a point on k which is non-critical for the height function. We will say that a knot k' is obtained from k by insertion of a hump at x if k and k' coincide outside some small neighbourhood of x and inside this neighbourhood they differ as on Figure 6.

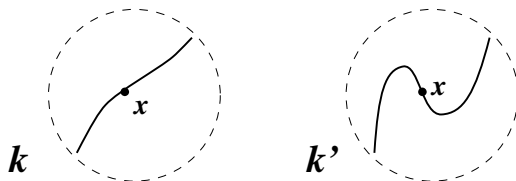

FIGURE 6. Inserting a hump.

Lemma 3.1. *Any two knots obtained from the same Morse knot by insertion of a hump are Morse equivalent.*

Proof. The lemma is clearly true if there are no critical points of the height function between the points x_1 and x_2 where we insert humps. In case there is one critical point between x_1 and x_2 the lemma follows from the argument on Figure 7. This

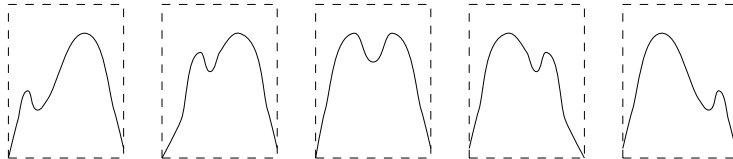

FIGURE 7. Passing a hump through a critical point.

also proves the lemma in the general case. \square

Let $b_1 \in \mathcal{P}_{2n+1}$ and $b_2 \in \mathcal{P}_{2m+1}$ and, as before, denote by $i(b_k)$ the image of the standard inclusion of b_k into \mathcal{P}_{2N+1} , $N \geq n, m$.

Lemma 3.2. *If $\mathcal{S}_n(b_1)$ and $\mathcal{S}_m(b_2)$ are in the same isotopy class in \mathcal{K} there exists $N \geq n, m$ such that $\mathcal{S}_N(i(b_1))$ and $\mathcal{S}_N(i(b_2))$ are Morse equivalent.*

Proof. Let

$$f^T(t) = (f_x^T(t), f_y^T(t), f_z^T(t))$$

where $T \in [0, 1]$ and $t \in \mathbf{R}$ be a homotopy between $\mathcal{S}_n(b_1)$ and $\mathcal{S}_m(b_2)$, that is, for each T the map $f^T(t) : \mathbf{R} \rightarrow \mathbf{R}^3$ defines a long knot and $f^0(t) = \mathcal{S}_n(b_1)$ and $f^1(t) = \mathcal{S}_m(b_2)$.

In $[0, 1] \times \mathbf{R}$ consider the subset W of pairs (T, t) such that $\frac{\partial}{\partial t} f_z^T(t) = 0$. Without loss of generality we can assume that W is a union of smooth compact non-singular curves whose boundary is either empty or belongs to $(\{0\} \cup \{1\}) \times \mathbf{R}$ and that there are only a finite number of tangencies of W with horizontal lines of the form $\{T\} \times \mathbf{R}$. In addition we require these tangencies to take place at different values of the parameter T ; see Figure 8. These assumptions imply, in particular, that for all but a finite number of values of T the knot $f^T(t)$ is Morse and that the perestroikas at the bifurcation values of T are generic, i.e. are insertions (or removals) of humps.

If there are no points of tangency of W with horizontal lines the knots $\mathcal{S}_n(b_1)$ and $\mathcal{S}_m(b_2)$ are Morse equivalent and $n = m = N$.

Otherwise, choose the point of tangency of W with a horizontal line which corresponds to the insertion of a hump with the smallest value of T . It is clear that

we can connect it with the lower boundary line $\{0\} \times \mathbf{R}$ by a segment s of a curve which is disjoint from W and whose tangent is nowhere horizontal, see Figure 8(a).

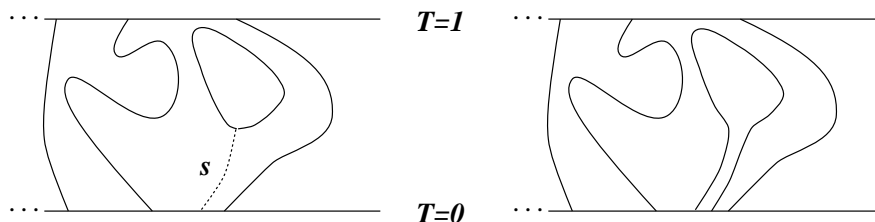

FIGURE 8.

In the neighbourhood of each point of s we can modify the knots $f^T(t)$ by inserting humps, this changes W as shown on Figure 8(b). Notice that the number of points where W has a horizontal tangent has decreased by one and the knot $f^0(t) = \mathcal{S}_n(b_1)$ was changed by an insertion of a hump.

Thus, proceeding inductively, we eliminate all insertions of humps. In the same way we eliminate the removals of humps with the only difference that we connect them to the upper boundary line and proceed from the bifurcation with the largest value of T downwards.

The result is that we construct a Morse equivalence between $\mathcal{S}_n(b_1)$, possibly with several humps inserted, and $\mathcal{S}_m(b_2)$, also with some extra humps. However, from Lemma 3.1 we know that $\mathcal{S}_n(b_1)$ and $\mathcal{S}_m(b_2)$ with humps inserted are Morse equivalent to $\mathcal{S}_N(i(b_1))$ and $\mathcal{S}_N(i(b_2))$ respectively (here N is the number of maxima of the modified knots) and this proves the lemma. \square

Let $b_1 \in \mathcal{P}_{2N+1}$ and $b_2 \in \mathcal{P}_{2N+1}$ represent the same knot. Lemma 3.2 allows us to assume that the knots $\mathcal{S}_N(b_1)$ and $\mathcal{S}_N(b_2)$ are Morse equivalent.

Given a deformation of $\mathcal{S}_N(b_1)$ to $\mathcal{S}_N(b_2)$ through Morse knots we are going to construct a one-dimensional family of braids $f^T : [0, 1] \rightarrow \mathcal{P}_{2N+1}$ such that $f^0 = b_1$, $f^1 = b_2$ and which is not continuous only at a finite number of values of the parameter, where the “jump” can be expressed as the multiplication by some element of H^T or H^B .

The braid f^0 is obtained by “suspending” the knot $\mathcal{S}_N(b_1)$ by maxima and minima, see Figure 9. Here we choose the points α_i and β_i in such a way that the deformation of $\mathcal{S}_n(b_1)$ into $\mathcal{S}_n(b_2)$ takes place entirely between the horizontal planes in which α_i and β_i are situated. Of course, f^0 is the same braid as b_1 . Think of the double lines which connect maxima and minima with the points α_i and β_i respectively as of very narrow rubber strips. Then, if we deform the knot keeping the points α_i and β_i fixed, the suspended knot also deforms and gives the braid f^T .

It may happen in the process of deformation that some rubber strips intersect the knot or intersect each other. Without loss of generality we can assume that these events take place near a finite number of distinct values of T .

Suppose that the rubber strip which connects a maximum with points α_i and α_{i+1} intersects the knot between $T = T_0$ and $T = T_0 + \epsilon$. Then one can find $x, y \in \mathcal{P}_{2N+1}$ such that:

- (a) $f^{T_0} = xy$ and $f^{T_0+\epsilon} = x \cdot \phi_i^N(A_{i,j}^{\pm 1}) \cdot y$ for some j ;
 (b) $x = \phi_i^N(x')$ for some $x' \in \mathcal{P}_{2N}$.

Thus

$$f^{T_0+\epsilon} = x \phi_i^N(A_{i,j}^{\pm 1}) x^{-1} \cdot f^{T_0} = \phi_i^N(x' A_{i,j}^{\pm 1} x'^{-1}) \cdot f^{T_0}.$$

Notice that conjugation by x' maps $A_{i,j}$ to a product of A_{i,j_m} for some set of j_m , so $\phi_i^N(x' A_{i,j}^{\pm 1} x'^{-1})$ lies in H^T .

Similarly, if the rubber strip is attached to the minimum, f^{T_0} is multiplied on the right by some braid from H^B . In case two rubber strips intersect each other we have to multiply by a product of two braids of such form; as above, the product will lie in H^T or H^B . (If one rubber strip is attached to a minimum and the other one to a maximum this product will automatically lie in the intersection $H^T \cap H^B$.) Finally, when the isotopy is finished and all minima and maxima have arrived back

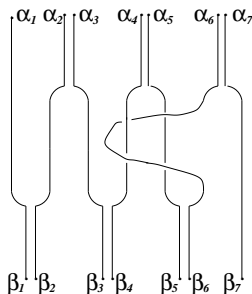

FIGURE 9. Getting a braid from a knot.

to their places what may happen is that some rubber strips may be twisted. This corresponds to multiplications by some $A_{i,i+1}$ on the left for i even and on the right for i odd.

Acknowledgments. We would like to thank Mario Eudave for finding an important reference, Sofia Lambropoulou and other organizers of the conference “Knots in Hellas ’98” who gave us a chance to meet, and Natig Atakishiev with whose pen a part of this paper was written. The second author was partially supported by the Naval Academy Research Council.

REFERENCES

- [B1] J. Birman, Braids, links, and mapping class groups, *Annals of Mathematics Studies*, No. 82. Princeton University Press, Princeton, N.J.; University of Tokyo Press, Tokyo, 1974.
 [B2] J. Birman, *On the stable equivalence of plat representations of knots and links*, *Canad. J. Math.* **28** (1976), no. 2, 264–290.
 [Sch] H. Schubert, *Über eine numerische Knoteninvariante*, *Math. Z.* **61** (1954), 245–288.
 [St] T. Stanford, *Vassiliev invariants and knots modulo pure braid subgroups*, math.GT/9805092.

INSTITUTO DE MATEMÁTICAS (UNIDAD CUERNAVACA), UNIVERSIDAD NACIONAL AUTÓNOMA DE MÉXICO, A.P. 273-3 ADMON. DE CORREOS NO. 3, CUERNAVACA, MORELOS, MEXICO

E-mail address: jacob@matcuer.unam.mx

MATHEMATICS DEPARTMENT, UNITED STATES NAVAL ACADEMY, 572C HOLLOWAY ROAD, ANNAPOLIS MD 21402, USA

E-mail address: stanford@nadm.navy.mil