

Representation Theory and Numerical AF-invariants

The representations and centralizers
of certain states on \mathcal{O}_d

Ola Bratteli

Palle E. T. Jorgensen

Vasyl' Ostrovs'kyĭ

MATHEMATICS INSTITUTE, UNIVERSITY OF OSLO, PB 1053 BLINDERN, N-0316 OSLO, NORWAY

E-mail address: bratteli@math.uio.no

URL: <http://www.math.uio.no/~bratteli/>

DEPARTMENT OF MATHEMATICS, THE UNIVERSITY OF IOWA, IOWA CITY, IA 52242-1419, U.S.A.

E-mail address: jorgen@math.uiowa.edu

URL: <http://www.math.uiowa.edu/~jorgen/>

INSTITUTE OF MATHEMATICS, NATIONAL ACADEMY OF SCIENCES OF UKRAINE, TERESHCHENKIVS'KA STR. 3, 252601 KIEV 4, UKRAINE

E-mail address: vo@imath.kiev.ua

1991 *Mathematics Subject Classification*. Primary 46L30, 46L55, 46L89, 47A13, 47A67; Secondary 47A20, 47D25, 43A65

Work supported by the Norwegian Research Council, the University of Oslo, the U.S. National Science Foundation, and the CRDF research grant UM1-311.

ABSTRACT. Let \mathcal{O}_d be the Cuntz algebra on generators S_1, \dots, S_d , $2 \leq d < \infty$, and let $\mathcal{D}_d \subseteq \mathcal{O}_d$ be the abelian subalgebra generated by monomials $S_\alpha S_\alpha^* = S_{\alpha_1} \cdots S_{\alpha_k} S_{\alpha_k}^* \cdots S_{\alpha_1}^*$ where $\alpha = (\alpha_1 \dots \alpha_k)$ ranges over all multi-indices formed from $\{1, \dots, d\}$. In any representation of \mathcal{O}_d , \mathcal{D}_d may be simultaneously diagonalized. Using $S_i (S_\alpha S_\alpha^*) = (S_{i\alpha} S_{i\alpha}^*) S_i$, we show that the operators S_i from a general representation of \mathcal{O}_d may be expressed directly in terms of the spectral representation of \mathcal{D}_d . We use this in describing a class of type III representations of \mathcal{O}_d and corresponding endomorphisms, and the heart of the memoir is a description of an associated family of AF-algebras arising as the fixed-point algebras of the associated modular automorphism groups. Chapters 5–18 are devoted to finding effective methods to decide isomorphism and non-isomorphism in this class of AF-algebras.

Key words and phrases. C^* -algebras, Fourier basis, irreducible representations, Hilbert space, wavelets, radix-representations, lattices, iterated function systems.

Contents

Preface	v
Introduction	vi
Part A. Representation Theory	1
Chapter 1. General representations of \mathcal{O}_d on a separable Hilbert space	3
Chapter 2. The free group on d generators	12
Chapter 3. β -KMS states for one-parameter subgroups of the action of \mathbb{T}^d on \mathcal{O}_d	18
Chapter 4. Subalgebras of \mathcal{O}_d	22
Part B. Numerical AF-Invariants	43
Chapter 5. The dimension group of \mathfrak{A}_L	45
Chapter 6. Invariants related to the Perron–Frobenius eigenvalue	58
Chapter 7. The invariants N , D , $\text{Prim}(m_N)$, $\text{Prim}(R_D)$, $\text{Prim}(Q_{N-D})$	61
Chapter 8. The invariants $K_0(\mathfrak{A}_L) \otimes_{\mathbb{Z}} \mathbb{Z}_n$ and $(\ker \tau) \otimes_{\mathbb{Z}} \mathbb{Z}_n$ for $n = 2, 3, 4, \dots$	74
Chapter 9. Associated structure of the groups $K_0(\mathfrak{A}_L)$ and $\ker \tau$	80
Chapter 10. The invariant $\text{Ext}(\tau(K_0(\mathfrak{A}_L)), \ker \tau)$	85
Chapter 11. Scaling and non-isomorphism	90
Chapter 12. Subgroups of $G_0 = \bigcup_{n=0}^{\infty} J_0^{-n} \mathcal{L}$	113
Chapter 13. Classification of the AF-algebras \mathfrak{A}_L with $\text{rank}(K_0(\mathfrak{A}_L)) = 2$	116
Chapter 14. Linear algebra of J	126
Chapter 15. Lattice points	129
Chapter 16. Complete classification in the cases $\lambda = 2$, $N = 2, 3, 4$	131
Chapter 17. Complete classification in the case $\lambda = m_N$	141
1. The case $N = 1$	149
2. The case $N = 2$	149
3. The case $N = 3$	149

4. The case $N \geq 4$	151
Chapter 18. Further comments on two examples from Chapter 16	160
Bibliography	166
List of Figures	170
List of Tables	172
List of Terms and Symbols	173

Preface

The present memoir consists of two parts. The first part encompasses Chapters 1–4, and is concerned with the description of a class of representations of the Cuntz algebra \mathcal{O}_d , starting out with a very general description of such representations. The second part encompasses Chapters 4–18 and is a description of a class of AF-algebras with constant incidence matrices J of the special form (6.1). The two parts are thus connected by Chapter 4, where it is explained how these AF-algebras arise as the fixed-point algebras of modular automorphism groups associated to certain states on \mathcal{O}_d . Readers who are not interested in representation theory can therefore read the memoir from Chapter 5. Since the special examples we study can be understood very concretely, we hope that the memoir may serve as an invitation for graduate students who want to study isomorphism and invariants in more general settings.

Oslo, Iowa City and Kiev, June 1999, January 2003, and May 2003
Ola Bratteli Palle E. T. Jorgensen Vasyl' Ostrovs'kyĭ

Introduction

The origin of this monograph was the desire to understand certain concrete operator relations arising as realizations of filtering processes in signal theory. Our research did, however, lead us naturally in the direction of analyzing certain non-commutative dynamical systems and their fixed points and states. In this introduction, we give an overview of the contents of the monograph in three stages: First (1) a very general discussion, then (2) a discussion with more specific definitions and details, and finally (3) a detailed technical account of what the paper actually contains.

1. General discussion and motivation. This monograph is centered around the issue of distinguishing a particular family of AF-algebras, those which arise as the centralizers of certain states on Cuntz algebras—or equivalently, as the fixed-point algebras under certain one-parameter subgroups of the gauge action. (The Cuntz algebras are the range of a functor from Hilbert space into C^* -algebras. The term AF-algebra is short for approximately finite-dimensional C^* -algebra. Both the Cuntz algebras and the AF-algebras play a role in several areas of mathematics, e.g., K -theory and dynamical systems, and in applications, for example to statistical mechanics [19].) While AF-algebras generally are classified up to stable isomorphism by the equivalence classes of their Bratteli diagrams, or by the isomorphism classes of their ordered dimension groups, none of the three items in this triple of equivalence classes, of AF-algebras, Bratteli diagrams, or ordered dimension groups, respectively, is especially amenable to computation. In this memoir, we therefore try to approach the subject via classes of concrete examples, which do in fact admit algorithms for distinguishing isomorphism classes, in particular by the computation of numerical invariants which distinguish these classes. The examples are chosen so they illustrate in a concrete manner the main issues of computation in each of the three incarnations, AF-algebras, Bratteli diagrams, or dimension groups. The terms in this paragraph will be defined in Section 2 of this introduction.

The first part of our memoir is in a sense divorced from the central theme, that of numerical invariants. But we feel that it helps the reader see how the main issue fits into a wider context, and hopefully it will help the reader make connections to the areas of mathematics and its applications which are touched upon in a more indirect manner. The ubiquitous Cuntz algebras and their representations have a surprising number of applications in a wide range of areas, also outside the subject of operator algebras, such as wavelets and dynamical systems, to mention just two. One of the recent areas of application of dimension groups and Perron–Frobenius structures is to notions of equivalence for symbolic dynamics, and more specifically

subshifts. Section 7.5 in the book [63] serves as an excellent background reference. In particular, it describes how substitution matrices and dimension groups are derived from symbolic systems in dynamics, and it gives the basics on some of the numerical invariants used there. The matrices that we encounter in the context of AF- C^* -algebras are a subclass of those used for the general dynamics problem, and our notion of equivalence is weaker. As we show in [13], our notion of C^* -equivalence for two dimension groups corresponds to a weaker concept of equivalence than the ones of strong shift equivalence and shift equivalence. The latter are nicely surveyed in [91], which also recounts the history of the Williams problem, and its resolution.

Let us give a short rundown of this problem. In the rest of this paragraph, let the term ‘matrix’ mean ‘matrix over the nonnegative integers’. Then two square matrices J, K are *elementary shift equivalent* if there exist matrices A, B such that $J = BA$ and $K = AB$. We say that J, K are *shift equivalent of lag k* if $AJ = KA, BK = JB, BA = J^k$, and $AB = K^k$ hold for some matrices A, B , and they are *shift equivalent* if they are shift equivalent of some lag k in \mathbb{N} . Thus shift equivalence of lag 1 is the same as elementary shift equivalence [63, Proposition 7.3.2]. The matrices J, K are *strongly shift equivalent* if they can be connected by a finite chain of elementary shift equivalent matrices. (Note that elementary shift equivalence is not an equivalence relation; it is not transitive.) Strong shift equivalence trivially implies shift equivalence [63, Theorem 7.3.3], but the converse is the longstanding Williams conjecture, and it is not true [57], even when J and K are irreducible [58]. The conjecture was stated in [93]. The properly weaker notion of C^* -equivalence or weak equivalence of two square matrices A, B is defined by the existence of a sequence $A_1, B_1, A_2, B_2, \dots$ of matrices and sequences $(n_k), (m_k)$ of natural numbers such that

$$\begin{aligned} J^{n_k} &= B_k A_k \\ K^{m_k} &= A_{k+1} B_k \end{aligned}$$

for $k = 1, 2, \dots$

One notes that the numerical invariants that are known in the subject have a history based on computation, and that applies to the issue of C^* -equivalence, also called weak equivalence, as well. And the invariants for weak equivalence are different from those used in [91] and the papers cited there. The latter are based on sign-gradation conditions, cohomology, and the K -theory group K_2 : see [91, Section 1]. A part of the paper [91] further describes a class of one-dimensional systems for which equivalence up to homeomorphism is decided by weak equivalence (C^* -equivalence) for the corresponding dimension groups.

Chapter 1 is a discussion of the spectral decomposition of representations of the Cuntz algebras relative to canonical MASAs (maximal abelian subalgebras). It serves as a pointer to how the particular AF-algebras in Chapter 4, which form the basis for our analysis, arise. But the dimension groups of the AF-algebras which result as fixed-point subalgebras from our operator-theoretic construct turn out also to come up in other areas of mathematics, and readers primarily interested in dynamics may wish to consult [63], or [5] for this alternative use of the same special dimension groups. These problems have a flavor of algebraic number theory; see also [14]. Chapter 2 specialises the general setup of Chapter 1 to

a certain class of representations of the Cuntz algebras, and the chapter is motivated partly by the representations arising from wavelet theory. These chapters describe basic theory of Cuntz-representation representations which has also been considered in [70, Section 2.5.3]. Chapter 3 is devoted to so-called KMS states (short for Kubo–Martin–Schwinger states) from statistical physics. More specifically, we look at KMS states of the dynamic defined by one-parameter groups of quasi-free automorphisms on a Cuntz C^* -algebra. One theorem gives a characterization of when there is, or is not, such a KMS state. Chapter 4 determines when, in this situation, the fixed-point algebra is AF, and gives an outline of how to go about computing the corresponding Bratteli diagrams. Since a main aim of the memoir is to make an otherwise technical subject concrete, many examples are offered to help the reader appreciate the abstract theorems, and to motivate the numerical invariants that are introduced later. The rest of the memoir is devoted to the analysis of the isomorphism classes of these AF-algebras. Thus the initial chapters are mainly devoted to setting up the class of AF-algebras to be considered. But we feel that they are of independent interest, and have relevance outside the particular issue of AF-algebra classification. Part A is representation-theoretic, while Part B describes numerical invariants for the AF-algebra classification context, and associated Bratteli diagrams. There are discussions of special cases of the general problem which are related to: (i) the Williams problem (the issue of understanding the two main ways of classifying dimension groups in dynamics—see [91] for more on this connection); (ii) Krieger’s theorem and conjugacy of the corresponding actions on the Cuntz algebras (see [63]); (iii) invariants related to the Perron–Frobenius eigenvalue; and (iv) more algebraic invariants with examples, or situations where the invariants become complete.

The one-parameter groups of automorphisms that we consider act upon the Cuntz algebras, and they are called gauge actions; they scale the generators with a unitary gauge. Our analysis is focused on the corresponding fixed-point algebras: their classification, and their significance in, for example, symbolic dynamics. But there are analogous and interesting questions for more general C^* -algebras which arise in dynamical systems, for instance the Cuntz–Krieger algebras \mathcal{O}_A . These are algebras, naturally generalizing the Cuntz algebras, defined on generators S_i and relations, the relations being given by a 0-1 matrix A . The matrix A in turn determines, in a standard fashion, see [63], a state space S_A for a dynamical system called a subshift. While we will not treat them here, our methods suggest directions for future work on other gauge actions, as illustrated by recent papers of Exel, Laca, and Vershik, for example [43] and [41, 42]. A gauge action on an algebra scales the generators by a unitary phase, and a recent paper [40] defines the notions of gauge action and KMS states in the setting of Cuntz–Krieger algebras. While our present analysis for the Cuntz algebras is relatively manageable for computations, involving only Perron–Frobenius theory for finite matrices, the analogous analysis of Exel if carried through would instead be based on an infinite-dimensional version of the Perron–Frobenius theorem, due to Ruelle (see [81] and [82]). In Ruelle’s theorem, the finite matrix from the classical Perron–Frobenius theorem is replaced by an operator, now called the Ruelle transfer operator (see [54], [12, Section 3.1]), and the Perron–Frobenius left eigenvector from the classical case, by a measure on the state space S_A . The Ruelle transfer operator acts on functions on the compact space S_A , and the right Perron–Frobenius eigenvector is a continuous function on

S_A . Following the model from the simpler case of the Cuntz algebra, and using the Ruelle–Perron–Frobenius theorem, Exel in [40] computes the KMS states for the Cuntz–Krieger algebras, and it would be interesting to analyze the issues of fixed-point subalgebras and state centralizers in this context. Relevant for our present analysis is the fact that unital endomorphisms of $\mathcal{B}(\mathcal{H})$ are known to correspond to representations of the Cuntz algebras \mathcal{O}_d , and the integer d is the Powers index. The corresponding index in the setting of [40] is not necessarily integer-valued, but some methods in our memoir point to generalizations and future directions of research in this and other algebraic settings of symbolic dynamics.

The use of certain representations of \mathcal{O}_d in wavelet theory is outlined in [12, Exercises 1–11, 1–12, and 2–25]. The starting observations there are the facts (i) that the system of frequency-subband filters with d subbands is known to satisfy the relations which define representations of \mathcal{O}_d , and (ii) that the multiresolution approach to wavelets is based on subband filters.

Yet other uses of the representations of the Cuntz algebras \mathcal{O}_d to dynamics include the work of J. Ball and V. Vinnikov [1, 2] on Lax–Phillips scattering theory for multivariable linear systems. These two papers develop a functional model for representations of \mathcal{O}_d in a setting which is more special than that of Theorem 1.2 below.

The original AF-algebra in [6] had Pascal’s triangle as its diagram and arose as the fixed-point algebra of the standard infinite-product-type action of the circle on the infinite tensor product of a sequence of full 2×2 matrix algebras. Infinite-tensor-product-type actions of more general compact groups have been considered by Anthony Wassermann, Adrian Ocneanu and others, and the fixed-point algebras are related to the AF-algebras occurring in Vaughan Jones’s subfactor theory, which again has important applications in knot theory, low-dimensional manifolds, conformal field theory, etc.; see [38, 49]. But this is far outside the scope of the present monograph.

As noted in [65], the list of applications of Bratteli diagrams includes such areas of applied mathematics as the fast Fourier transform, and more general Fourier transforms on finite or infinite nonabelian groups. These transforms in turn are widely used in computational mathematics, in error-correction codes, and even in P. Shor’s fast algorithm for integer factorization on a quantum computer [83, 84]. As reviewed in [65], the effectiveness of the Bratteli diagrams for development of algorithms pays off especially well when a sequence of operations is involved, with a succession of steps, perhaps with a scaling similarity, and with embeddings from one step into the next. In the case of matrix algebras, the embeddings are in the category of rings, while for groups, the embeddings are group homomorphisms. The number of embeddings may be infinite, as it is in the applications in the present memoir, or it may be finite, as in the case of the fast-Fourier-transform algorithms of Cooley and Tukey, see [65].

The discrete Fourier transform for the cyclic group $\mathbb{Z}/n\mathbb{Z}$ involves the unitary matrix $\frac{1}{\sqrt{n}} (e^{i2\pi jk/n})_{j,k=0}^{n-1}$ and is of complexity $O(n^2)$. If n is a composite number, such as $n = 2^k$, then there are choices of Bratteli diagrams built on $\mathbb{Z}/n\mathbb{Z}$ which turn the discrete Fourier transform into a fast Fourier transform of complexity $O(n \log n)$. For each of the Bratteli diagrams formed from a sequence of subgroups of $\mathbb{Z}/n\mathbb{Z}$, the corresponding fast Fourier transform involves a summation over the paths of the Bratteli diagram.

The subject of this memoir is developing into a long-term programme by the authors, also in collaboration with Kim and Roush [13, 14, 15]. The results are often somewhat technical. The paper [91] provides a beautiful survey of the Williams problem, its history, and its resolution. The subject of equivalences, strong, shift equivalence, or weak equivalence, is situated neither directly in operator algebras, nor perhaps precisely in dynamical systems or wavelet analysis, but rather intermingles these, and more, areas of mathematics.

Let us now add more specific definitions and go into more details:

2. Three ways of measuring isomorphism. During the sixties and seventies it was established that there is a one-to-one canonical correspondence between the following three sets [6, 30, 32, 33, 34, 47]:

- (i) the isomorphism classes of AF-algebras,
- (ii) the isomorphism classes of certain ordered abelian groups, called dimension groups,

and finally

- (iii) the equivalence classes of certain combinatorial objects, called Bratteli diagrams.

In more recent times, this has led to an undercurrent of misunderstanding that AF-algebras, which are complex objects, are classified by dimension groups, which are easy objects, and that this is the end of the story. However, as anyone who has worked with these matters knows, although for special subsets it may be easier to work with one of the three sets mentioned above rather than another, in general the computation of isomorphism classes in any of the three categories is equally difficult. Although dimension groups are easy objects, their isomorphism classes in general are not! One may even be tempted to flip the coin around and say that dimension groups are classified by AF-algebras. If one thinks about isomorphism classes, this is logically true, but the only completely general method to decide isomorphism classes in all the cases is to resort to the computation of the equivalence relation for the associated Bratteli diagrams. This problem is not only hard in general, it is even undecidable: There is no general recursive algorithm to decide if two effective presentations of Bratteli diagrams yield equivalent diagrams [66]. In this memoir, we will encounter this problem in a very special situation, and try to resolve it in a modest way by introducing various numerical invariants which are easily computable from the diagram. In the situation that the AF-embeddings are given by a constant primitive nonsingular matrix, the classification problem has, after the writing of this monograph, been proved in general to be decidable [13, 14, 15].

Recall that an *AF-algebra* is a separable C^* -algebra with the property that for any $\varepsilon > 0$, any finite subset of the algebra can be approximated with elements of some finite-dimensional $*$ -subalgebra with the precision given by ε . An AF-algebra is *stable* if it is isomorphic to its tensor product with the compact operators on a separable Hilbert space. A *dimension group* is a countable abelian group with an order satisfying the Riesz interpolation property and which is unperforated. The *Bratteli diagram* is described in [6], [29], and [38], and the equivalence relation is also described in detail in [7] and in Remark 5.6. (All these concepts will be treated in some detail in Chapter 5, where it is also explained that the stability assumption

on the AF-algebra can be removed by putting more structure on the group and the diagram.)

Recently there has been a fruitful interaction between the theory of dynamical systems, analytic number theory, and C^* -algebras. In [4], the authors show how β -KMS states may be used in understanding the Riemann zeta function, and vice versa. In [88], [21], [37], [49], [39], [52], [55], and [60], certain dynamical systems are used to generate new simple C^* -algebras from the Cuntz algebras, and to better understand the corresponding isomorphism classes of C^* -algebras. The results in Chapter 4 should be contrasted with results of Izumi [53] and Watatani [92] which deal with crossed product constructions built from the Cuntz algebras \mathcal{O}_d . Here we study the AF-subalgebras of \mathcal{O}_d formed from the one-parameter automorphism groups of Chapter 3.

It follows from the definition of the \mathcal{O}_d -relations that they are well adapted to d -multiresolutions of the kind used in wavelets and fractal analysis. The number d represents the scaling factor of the wavelet. This viewpoint was exploited in recent papers [16], [9], [10], and [28]. While the representations for these applications are type I, the focus in the present memoir is type III representations of \mathcal{O}_d , and a family of associated AF- C^* -algebras $\mathfrak{A}_L (\subseteq \mathcal{O}_d \text{ for some } d)$. These representations arise from a modified version of the technique which we used in generating wavelet representations. This starting point in fact yields a general decomposition result for representations of \mathcal{O}_d which seems to be of independent interest. To understand better the resulting decomposition structure, we will establish that the centralizers of these states are simple AF-algebras, and that the Bratteli diagrams have stationary incidence matrices J of a special form given in (7.2). (In general the centralizer of a state ω on a C^* -algebra \mathfrak{A} is defined as the set of $x \in \mathfrak{A}$ such that $\omega(xy) = \omega(yx)$ for all $y \in \mathfrak{A}$. If ω is a KMS state with respect to a dynamical one-parameter group σ , as in (3.3), then this is equivalent to saying that x is a fixed point for the dynamic σ .) Clearly the rank of the corresponding dimension group is an invariant, but it appeared at first sight that different matrices J and J' would yield non-isomorphic AF-algebras \mathfrak{A}_J and $\mathfrak{A}_{J'}$. This turns out not to be the case, however, and the bulk of the memoir concerns numerical AF-invariants. It is not easy to get invariants that discriminate the most natural cases of algebras \mathfrak{A}_J that arise from this seemingly easy family of AF-algebras. There is a connection to subshifts in dynamical systems, but if subshifts are constructed, from J and J' , say, we note that strong shift equivalence in the sense of Krieger is equivalent to $J = J'$, while isomorphism of the AF-algebras \mathfrak{A}_J and $\mathfrak{A}_{J'}$ turns out to be a much more delicate problem; see also [13]. While we do not have a complete set of numerical AF-invariants for our algebras \mathfrak{A}_J , we do find interesting subfamilies of \mathfrak{A}_J 's which do in fact admit a concrete isomorphism labeling, and Part B of the memoir concentrates on these cases. In contrast, we mention that [14] and [15] do have general criteria for C^* -isomorphism of the algebras \mathfrak{A}_J , but those conditions are rather abstract in comparison with the explicit and numerical invariants which are the focus of the present memoir. A complete algorithm for C^* -isomorphism is written out in [14, pp. 1651–1653 and corrigendum].

Let us now go into even more nitty-gritty technical details:

3. Detailed outline. The Cuntz algebra \mathcal{O}_d with generators s_i and relations $s_i^* s_j = \delta_{ij} 1$, $\sum_{i=1}^d s_i s_i^* = 1$ contains a natural abelian subalgebra $\mathcal{D}_d \cong C(\prod_1^\infty \mathbb{Z}_d)$,

$\mathbb{Z}_d = \{1, \dots, d\}$ (see [26]). We relate general representations of \mathcal{O}_d with the spectral resolution of the restriction of the representation to \mathcal{D}_d . From this, we read off cocycle formulations of the factor property, irreducibility, and of equivalence of representations. We then specialize to the representations associated with the GNS construction from states $\omega = \omega_p$ on \mathcal{O}_d indexed by $p_i > 0$, $\sum_{i=1}^d p_i = 1$, given by

$$\omega(s_{\alpha_1} \cdots s_{\alpha_k} s_{\gamma_l}^* \cdots s_{\gamma_1}^*) = \delta_{kl} \delta_{\alpha_1 \gamma_1} \cdots \delta_{\alpha_k \gamma_k} p_{\alpha_1} \cdots p_{\alpha_k}$$

where α and γ are multi-indices formed from \mathbb{Z}_d . The cyclic space \mathcal{H}_{ω_p} , for (p_i) fixed, is shown in Chapter 2 to have a bundle structure over the set of all \mathbb{Z}_d -multi-indices with fiber $\ell^2(\mathbb{S}_d)$ where \mathbb{S}_d is the free semigroup on d generators.

Let $L = (L_1, \dots, L_d) \in \mathbb{R}^d$, and consider the one-parameter group σ^L of $*$ -automorphisms of \mathcal{O}_d defined by

$$\sigma_t^L(s_j) = \exp(itL_j) s_j.$$

It can be shown ([35], or Proposition 3.1) that σ^L admits a σ^L -KMS state, at some value β , if and only if all L_j 's are nonzero and have the same sign. This value β is then unique and is defined as the solution of

$$\sum_{k=1}^d e^{-\beta L_k} = 1,$$

and the (σ^L, β) -KMS state is then also unique, and is the state defined in the previous paragraph with $p_k = e^{-\beta L_k}$. Note that the group σ^L is periodic if and only if any pair L_j, L_k is rationally dependent. In that case, let \mathfrak{A}_L be the fixed-point subalgebra in \mathcal{O}_d under the action σ^L . We show in Chapter 4 that \mathfrak{A}_L is an AF-algebra ([6], [32]) if and only if all L_k 's have the same sign, and furthermore the \mathfrak{A}_L 's are then simple with a unique trace state (namely the restriction of the state in the previous paragraph to \mathfrak{A}_L). We compute the Bratteli diagrams of the \mathfrak{A}_L in this case, and show (using a result from [25]) that the endomorphism $\rho(a) := \sum_{i=1}^d s_i a s_i^*$ restricts to a shift (in the sense of Powers [77]) on each of the algebras \mathfrak{A}_L , i.e., $\bigcap_{k=1}^{\infty} \rho^k(\mathfrak{A}_L) = \mathbb{C}1$.

While the dimension group $D(\mathfrak{A}_L)$, described in [6], [34], [32], and [29] in principle is a complete AF-invariant, we have mentioned that its structure is not immediately transparent. For the present AF-algebras \mathfrak{A}_L , the classification is facilitated by the display of specific numerical invariants, derived from $D(\mathfrak{A}_L)$, but at the same time computable directly in terms of the given data (L_1, \dots, L_d) . These invariants are described in Chapters 6–17 where their connection to Ext is partially explained.

Let us give a short road map to the various invariants introduced and where it proved that they are invariants (sometimes in restricted settings): $K_0(\mathfrak{A}_L)$ in (5.6), (5.19); $\tau(K_0(\mathfrak{A}_L))$ in (5.22); $D(\mathfrak{A}_L) = (K_0(\mathfrak{A}_L), K_0(\mathfrak{A}_L)_+, [\mathbf{1}])$ in (5.30); $\ker \tau$ in (5.31); $\mathbb{Q}[\lambda]$ together with the prime factors of λ before (6.1); $N, D, \text{Prim}(m_N), \text{Prim}(Q_{N-D}), \text{Prim}(R_D)$ in Theorem 7.8; $K_0(\mathfrak{A}_L) \otimes_{\mathbb{Z}} \mathbb{Z}_n$ and $\ker \tau \otimes_{\mathbb{Z}} \mathbb{Z}_n$ in Chapter 8, M in (8.26); $\text{rank } \mathcal{L}_k$ in Corollary 9.5; class in $\text{Ext}(\tau(K_0(\mathfrak{A}_L)), \ker \tau)$ in Chapter 10; $D_\lambda(K_0(\mathfrak{A}_L))$ in (11.57)–(11.58); $I(J)$ in (17.12) and Corollary 17.6. In general it is very hard to find complete invariants apart from $D(\mathfrak{A}_L)$, even for special subclasses; but if the Perron–Frobenius eigenvalue λ of J is rational (and thus integral) and $N = 2$ and $\text{Prim}(\lambda) = \text{Prim}(m_2/\lambda)$, then $\text{Prim}(\lambda)$ is a complete invariant by

Proposition 13.3. The same is true if the condition $\text{Prim}(\lambda) = \text{Prim}(m_2/\lambda)$ is replaced by $\text{Prim}(\lambda + \frac{m_2}{\lambda}) \subseteq \text{Prim}(\lambda)$ by Proposition 13.4.

In Chapter 16 we give a complete classification of the class $\lambda = 2$, $N = 2, 3, 4$. This class contains 28 specimens, and it turns out that all of them are non-isomorphic except for a subset consisting of the three specimens in Figure 19.

The most striking classification result for a restricted, but infinite, class of examples in this memoir is that if $\lambda = m_N$, then $(N, \text{Prim} \lambda, I(J))$ is a *complete* invariant. This is proved in Theorem 17.18.

In addition to these formal invariants there are very efficient methods to decide non-isomorphism when λ is rational based on a quantity $\tau(v) = \langle \alpha | v \rangle$ defined in (11.3)–(11.4); see Theorem 11.10, Remark 11.11, Corollaries 11.12–11.13, Scholium 11.24. In fact $I(J) = \lambda^{N-1} \langle \alpha | v \rangle = \lambda^{N-1}$ times the inner product of the right and left Perron–Frobenius eigenvectors α, v of J , normalized so that $\alpha_1 = v_1 = 1$.

In two new papers [14, 15] written jointly with K.H. Kim and F. Roush, we give a completely general algorithm to decide C^* -equivalence of two square matrices A and B . In its most general form, however, this general algorithm is not merely based on the computation of a complete set of invariants, and the methods of the present monograph are still most useful for the particular examples arising from the noncommutative dynamical systems we are considering.

Part A

Representation Theory

General representations of \mathcal{O}_d on a separable Hilbert space

Representations of the Cuntz algebras \mathcal{O}_d play a role in several recent papers; see, e.g., [37], [16], [21], [22], [23], [31], [92], [53]. Since \mathcal{O}_d is purely infinite, there are few results that cover all representations. The following result does just that, and serves as a “noncommutative spectral resolution”. We will use the convention that S_i denotes the representative of the Cuntz algebra generator s_i in any given representation.

Let $\Omega = \prod_1^\infty \mathbb{Z}_d$, and let σ be the right shift on Ω :

$$(1.1) \quad \sigma(x_1, x_2, \dots) = (x_2, x_3, \dots)$$

Define sections σ_i of σ by

$$(1.2) \quad \sigma_i(x_1, x_2, \dots) = (i, x_1, x_2, \dots),$$

for $i = 1, \dots, d$. Note that σ is a d -to-1 map and that the sections are injective. The sets

$$(1.3) \quad \Omega_i = \sigma_i(\Omega)$$

form a partition of the Cantor set Ω into clopen sets. The σ_i are right inverses of σ :

$$(1.4) \quad \sigma\sigma_i = \text{id}$$

for $i = 1, \dots, d$. If μ is a probability measure on Ω , we say that μ is σ -quasi-invariant if

$$(1.5) \quad \mu(E) = 0 \implies \mu(\sigma^{-1}(E)) = 0$$

for all Borel sets $E \subseteq \Omega$, and we say that μ is σ_i -quasi-invariant if

$$(1.6) \quad \mu(E) = 0 \implies \mu(\sigma_i^{-1}(E)) = 0$$

for all Borel sets $E \subseteq \Omega$, where

$$(1.7) \quad \begin{aligned} \sigma_i^{-1}(E) &= \{x \mid \sigma_i(x) = (i, x_1, x_2, \dots) \in E\}, \\ \sigma^{-1}(E) &= \{x \mid \sigma(x) = (x_2, x_3, \dots) \in E\}. \end{aligned}$$

The set of d conditions (1.6) is equivalent to the set of d conditions

$$(1.8) \quad \mu(\sigma_i(F)) \implies \mu(F) = 0$$

for $i = 1, \dots, d$. The condition (1.5) is implied by, but does not imply, the condition

$$(1.9) \quad \mu(\sigma(F)) = 0 \implies \mu(F) = 0.$$

(Conditions like (1.8) and (1.9) make sense in this setting since σ_i and σ are local homeomorphisms, and thus map measurable sets into measurable sets.) Note that

$$(1.10) \quad \sigma^{-1}(E) = \bigcup_i \sigma_i(E)$$

for all sets E by the chain: $x \in \bigcup_i \sigma_i(E) \iff x = iy$ for some $i = 1, \dots, d$, $y \in E \iff \sigma(x) \in E \iff x \in \sigma^{-1}(E)$. Note also that if μ is both σ - and σ_i -quasi-invariant, we have the connection

$$\frac{d\mu(\sigma_i(y))}{d\mu(y)} = \frac{d\mu(\sigma_i(y))}{d\mu(\sigma\sigma_i(y))} = \left(\frac{d\mu \circ \sigma}{d\mu} \right)^{-1}(\sigma_i(y))$$

between the Radon–Nikodym derivatives.

Note also that the two quasi-invariance conditions (1.5) and (1.6) together imply the d equivalences

$$(1.11) \quad \mu(E) = 0 \iff \mu(\sigma_i E) = 0, \quad i = 1, \dots, d,$$

for all Borel sets $E \subseteq \Omega$, and that (1.11) implies the σ -invariance (1.5). (When referring to (1.6) (or (1.11)) in the following we mean “(1.6) (or (1.11)) for all $i = 1, \dots, d$ ”). Let us prove this.

(1.5) & (1.6) \Rightarrow (1.11): If (1.5) and (1.6) hold and $\mu(E) = 0$, it follows from (1.5) that $\mu(\sigma^{-1}(E)) = 0$ and hence from (1.10) that $\mu(\sigma_i(E)) = 0$ for all i . Conversely, if $\mu(\sigma_i(E)) = 0$ for some i , then since $E = \sigma_i^{-1}\sigma_i E$ it follows from (1.6) that $\mu(E) = 0$.

(1.11) \Rightarrow (1.5): Assume that (1.11) holds and that $\mu(E) = 0$. Then $\mu(\sigma_i(E)) = 0$ for all i by (1.11) and hence $\mu(\sigma^{-1}(E)) = 0$ by (1.10).

The condition (1.11) does not, however, imply σ_i -quasi-invariance (1.6), by the following example: $d = 2$, $\mu = \delta$ -measure on $(1, 1, 1, \dots)$. Then (1.11) holds for all E , but (1.6) fails for $E = \{(2, 1, 1, 1, \dots)\}$ and $i = 2$. In this case μ is σ -quasi-invariant and σ_1 -quasi-invariant, but not σ_2 -quasi-invariant, so (1.5) does not imply (1.6). More interestingly, the converse implication is always valid:

Proposition 1.1. *If μ is a probability measure on Ω and μ is σ_i -quasi-invariant for $i = 1, \dots, d$, then μ is σ -quasi-invariant.*

Proof. Put $\rho_i(y) = \frac{d\mu(\sigma_i(y))}{d\mu(y)}$. Since the maps σ_i are injective and have disjoint ranges, there is actually one function G such that

$$(1.12) \quad G(\sigma_i(y)) = \rho_i(y).$$

One now proves as in (1.38) below (the tacit assumption there that μ is σ -quasi-invariant is not needed for this) that

$$(1.13) \quad \int_{\Omega} g(x) d\mu(x) = \int_{\Omega} R(g)(x) d\mu(x),$$

where

$$(1.14) \quad R(g)(x) = \sum_{\substack{y \\ \sigma(y)=x}} G(y) g(y).$$

Note that the Ruelle operator R has the property

$$(1.15) \quad R(f \circ \sigma) = R(1) \cdot f,$$

by the computation

$$R(f \circ \sigma)(x) = \sum_{\substack{y \\ \sigma(y)=x}} G(y) f(\sigma(y)) = f(x) \sum_{\substack{y \\ \sigma(y)=x}} G(y) = f(x) R(1)(x).$$

We observe that $R(1)$ is a positive function by (1.14) and it is μ -integrable, as can be seen by using (1.13) on $g = 1$. If f is a positive bounded function on Ω we have from (1.15):

$$(1.16) \quad \mu(f \circ \sigma) = \mu(R(f \circ \sigma)) = \mu(R(1) \cdot f).$$

Putting f equal to characteristic functions, the σ -quasi-invariance (1.5) of μ is immediate. \square

As a final note on invariance, observe that (1.11) implies the condition

$$\mu(E) = 0 \iff \mu(\sigma(E)) = 0,$$

by the following reasoning. Assume (1.11) throughout. If $\mu(\sigma(E)) = 0$, then $\mu(\sigma_i \sigma(E)) = 0$ for all i , but as $E \subseteq \bigcup_i \sigma_i \sigma(E)$ it follows that $\mu(E) = 0$. Conversely, if $\mu(E) = 0$, write E as $E = \bigcup_i \sigma_i(E_i)$, and then $\mu(\sigma_i(E_i)) \leq \mu(E) = 0$, and hence, as $\sigma(E) = \bigcup_i \sigma_i(E_i)$, we have $\mu(\sigma(E)) = 0$.

We now come to the main result in this chapter.

Theorem 1.2. *For any nondegenerate representation $s_i \mapsto S_i$ of \mathcal{O}_d on a separable Hilbert space \mathcal{H} , there exists a probability measure μ on Ω which is σ_i -quasi-invariant for $i = 1, \dots, d$ (and thus σ -quasi-invariant by Proposition 1.1), and a measurable direct integral decomposition*

$$(1.17) \quad \mathcal{H} = \int_{\Omega}^{\oplus} \mathcal{H}(x) d\mu(x)$$

of \mathcal{H} into Hilbert spaces $\mathcal{H}(x)$ such that the spaces $\mathcal{H}(x)$ are constant (have fixed dimension) over σ -orbits in Ω , and there exists a measurable field $\Omega \ni x \mapsto U(x)$ of unitary operators such that if

$$(1.18) \quad \xi = \int_{\Omega}^{\oplus} \xi(x) d\mu(x)$$

is a vector in \mathcal{H} , then

$$(1.19) \quad S_i \xi = \int_{\Omega}^{\oplus} (S_i \xi)(x) d\mu(x),$$

$$(1.20) \quad S_i^* \xi = \int_{\Omega}^{\oplus} (S_i^* \xi)(x) d\mu(x),$$

where

$$(1.21) \quad (S_i \xi)(x) = \chi_i(x) \rho(x) U(x) \xi(\sigma(x)),$$

$$(1.22) \quad (S_i^* \xi)(x) = \rho(\sigma_i(x))^{-1} U(\sigma_i(x))^* \xi(\sigma_i(x)).$$

Here

$$(1.23) \quad \rho(x) = \left(\frac{d\mu(\sigma(x))}{d\mu(x)} \right)^{\frac{1}{2}},$$

so that

$$(1.24) \quad \rho(\sigma_i(x))^{-1} = \left(\frac{d\mu(\sigma_i(x))}{d\mu(x)} \right)^{1/2}$$

and

$$(1.25) \quad \chi_i(x) = \begin{cases} 1 & \text{if } x_1 = i, \\ 0 & \text{otherwise.} \end{cases}$$

Conversely, if μ , \mathcal{H} , $x \mapsto \mathcal{H}(x)$ and $x \mapsto U(x)$ satisfy all the conditions in the initial part of the theorem, the formulae (1.19)–(1.24) define a nondegenerate representation of \mathcal{O}_d on \mathcal{H} .

Remark 1.3. At the outset the formula (1.21) does not make sense, since $U(x)$ is an operator on $\mathcal{H}(x)$, while $\xi(\sigma(x)) \in \mathcal{H}(\sigma(x))$. Here we have actually made an identification of the Hilbert spaces $\mathcal{H}(x)$ over each orbit of σ . The Hilbert spaces over each σ -invariant set have constant dimension μ -almost everywhere by the argument after (1.53) below. Hence if we define

$$\Omega_{(n)} = \{x \in \Omega \mid \dim(\mathcal{H}(x)) = n\}$$

for $n = 1, 2, \dots, \aleph_0$, then the sets $\Omega_{(n)}$ are μ -measurable and σ -, as well as σ_i -, invariant up to sets of measure zero. If \mathcal{H}_n is the Hilbert space of dimension n for $n = 1, \dots, \aleph_0$, then we may identify $\mathcal{H}(x)$ with \mathcal{H}_n for $x \in \Omega_{(n)}$, and we have the decomposition

$$\mathcal{H} = \int_{\Omega}^{\oplus} \mathcal{H}(x) d\mu(x) = \bigoplus_{n=1}^{\aleph_0} \int_{\Omega_{(n)}}^{\oplus} \mathcal{H}(x) d\mu(x) = \bigoplus_{n=1}^{\aleph_0} \mathcal{H}_n \otimes L^2(\Omega_{(n)}, d\mu).$$

Hence we may view $U(x)$ as a unitary operator on \mathcal{H}_n for all $x \in \Omega_{(n)}$. Since the $\Omega_{(n)}$ are σ - and σ_i -invariant, the formula (1.21) is meaningful, and expressions like the one on the third line of (1.42) make sense since $\xi(x)$ and $\eta(\sigma(x))$ lie in the same Hilbert space. The direct sum above is a decomposition of the representation of \mathcal{O}_d . See also Remark 1.5, and see the book [70, Section 2.5.3] for more details.

Before proving this theorem, let us consider the intertwiner space between two representations $s_i \mapsto S_i$ and $s_i \mapsto T_i$. Recall that an operator T intertwines these representations if and only if it intertwines the operators S_i, T_i :

$$(1.26) \quad TS_i = T_iT, \quad i = 1, \dots, d.$$

“Only if” is obvious. As for “if”, note that if T satisfies (1.26), then

$$(1.27) \quad \begin{aligned} T_i^*T &= \sum_{j=1}^d T_i^*TS_jS_j^* \\ &= \sum_{j=1}^d T_i^*T_jTS_j^* \\ &= TS_i^*. \end{aligned}$$

Theorem 1.4. Let S_i, \tilde{S}_i be representations of \mathcal{O}_d on separable Hilbert spaces

$$(1.28) \quad \mathcal{H} = \int_{\Omega}^{\oplus} \mathcal{H}(x) d\mu(x)$$

and

$$(1.29) \quad \tilde{\mathcal{H}} = \int_{\Omega}^{\oplus} \tilde{\mathcal{H}}(x) d\tilde{\mu}(x)$$

as defined in Theorem 1.2. Partition Ω into three σ -invariant Borel sets

$$(1.30) \quad \Omega = \Omega_0 \cup \Omega_1 \cup \Omega_2$$

such that μ and $\tilde{\mu}$ are equivalent on Ω_0 , $\tilde{\mu}(\Omega_1) = 0$, and $\mu(\Omega_2) = 0$. Then an operator $T \in \mathcal{B}(\mathcal{H}, \tilde{\mathcal{H}})$ is an intertwiner between the two representations, i.e.,

$$(1.31) \quad TS_i = \tilde{S}_i T,$$

if and only if T has a measurable decomposition

$$(1.32) \quad T = \int_{\Omega_0}^{\oplus} T(x) d\mu(x)$$

where $T(x) \in \mathcal{B}(\mathcal{H}(x), \tilde{\mathcal{H}}(x))$ and

$$(1.33) \quad T(x)U(x) = \tilde{U}(x)T(\sigma(x))$$

for almost all $x \in \Omega_0$.

Remark 1.5. In particular, if $S_i = T_i$, the commutant of the representation consists of all decomposable operators

$$(1.34) \quad T = \int_{\Omega}^{\oplus} T(x) d\mu(x)$$

such that

$$(1.35) \quad T(x)U(x) = U(x)T(\sigma(x))$$

for almost all $x \in \Omega$, and the center of the representation consists of all decomposable operators

$$(1.36) \quad T = \int_{\Omega}^{\oplus} \lambda(x) \mathbb{1}_{\mathcal{H}(x)} d\mu(x)$$

where the scalar function $\lambda \in L^{\infty}(\Omega, d\mu)$ is σ -invariant. Thus the representation is a factor representation if and only if the right shift on $L^{\infty}(\Omega, d\mu)$ is ergodic. If in addition $\dim(\mathcal{H}(x)) = 1$ for almost all x , then the representation is irreducible since (1.35) then only has the trivial solutions $T(x) = \text{const}$.

Note that if the right shift on $L^2(\Omega, d\mu)$ is ergodic, then $\dim(\mathcal{H}(x))$ is constant for almost all x , and if \mathcal{H}_0 is a Hilbert space of that dimension, then we have an isomorphism

$$\int_{\Omega}^{\oplus} \mathcal{H}(x) d\mu(x) \cong L^2(\Omega, d\mu) \otimes \mathcal{H}_0$$

and U may be viewed as a measurable function from Ω into the unitary group $\mathcal{U}(\mathcal{H}_0)$ on \mathcal{H}_0 . The element T is then a function from Ω into $\mathcal{B}(\mathcal{H}_0)$ and (1.35) takes the form

$$T(x) = U(x)T(\sigma(x))U^*(x).$$

Thus the commutant of the representation is canonically isomorphic to the fixed-point algebra in

$$L^{\infty}(\Omega, d\mu) \otimes \mathcal{B}(\mathcal{H}_0) = L^{\infty}(\Omega, \mathcal{B}(\mathcal{H}_0))$$

for the endomorphism

$$T \mapsto U(T \circ \sigma)U^*.$$

Cocycle equivalence of functions with values in groups G of unitaries have been studied recently in ergodic theory; see, e.g., [72, 73]. Equation (1.33) above in that setup is the assertion that U and \tilde{U} (taking values in the corresponding G) are cohomologous.

Proof of Theorem 1.2. We will first verify that the relations (1.17)–(1.25) define a representation of \mathcal{O}_d , and verify that its restriction to the abelian subalgebra

$$(1.37) \quad \mathcal{D}_d = C^* \left(s_\alpha s_\alpha^* \mid \alpha \in \prod_1^\infty \mathbb{Z}_d \right)$$

is the spectral representation. If $g \in L^1(\Omega, d\mu)$, we have

$$(1.38) \quad \begin{aligned} \int_\Omega g(x) d\mu(x) &= \sum_i \int_{\Omega_i} g(x) d\mu(x) \\ &= \sum_i \int_\Omega g(\sigma_i(y)) \frac{d\mu(\sigma_i(y))}{d\mu(y)} d\mu(y) \\ &= \sum_i \int_\Omega g(\sigma_i(y)) \frac{d\mu(\sigma_i(y))}{d\mu(\sigma\sigma_i(y))} d\mu(y) \\ &= \sum_i \int_\Omega g(\sigma_i(y)) \rho(\sigma_i(y))^{-2} d\mu(y) \\ &= \int_\Omega \left(\sum_{\substack{x \\ \sigma(x)=y}} g(x) G(x) \right) d\mu(y), \end{aligned}$$

where $G(x) = \rho(x)^{-2}$. (If it happens that $\sum_{x: \sigma(x)=y} G(x) = 1$, the relation (1.38) says that μ is σ -invariant, and μ is then what is called a G -measure in [56].) Applying (1.38) to $g(x) = f(x, \sigma(x))$ we obtain

$$(1.39) \quad \int_\Omega f(x, \sigma(x)) d\mu(x) = \sum_i \int_\Omega f(\sigma_i(y), y) \rho(\sigma_i(y))^{-2} d\mu(y).$$

Defining S_i by (1.19) and (1.21), we see immediately from the $\chi_i(x)$ term that the ranges of S_i are mutually orthogonal, and if $\xi \in \mathcal{H}$, then from (1.39):

$$(1.40) \quad \begin{aligned} \|S_i \xi\|_2^2 &= \int_\Omega \chi_i(x) \rho(x)^2 \|\xi(\sigma(x))\|^2 d\mu(x) \\ &= \int_{\Omega_i} \rho(x)^2 \|\xi(\sigma(x))\|^2 d\mu(x) \\ &= \int_\Omega \rho(\sigma_i(y))^2 \|\xi(y)\|^2 \rho(\sigma_i(y))^{-2} d\mu(y) \\ &= \|\xi\|^2 \end{aligned}$$

so each S_i is an isometry, and hence

$$(1.41) \quad S_i^* S_j = \delta_{ij} \mathbf{1}.$$

Furthermore

$$\begin{aligned}
 (1.42) \quad \langle S_i^* \xi | \eta \rangle &= \langle \xi | S_i \eta \rangle \\
 &= \int_{\Omega} \langle \xi(x) | (S_i \eta)(x) \rangle d\mu(x) \\
 &= \int_{\Omega} \chi_i(x) \rho(x) \langle U(x)^* \xi(x) | \eta(\sigma(x)) \rangle d\mu(x) \\
 &= \int_{\Omega_i} \rho(x) \langle U(x)^* \xi(x) | \eta(\sigma(x)) \rangle d\mu(x) \\
 &= \int_{\Omega} \rho(\sigma_i(y)) \langle U(\sigma_i(y))^* \xi(\sigma_i(y)) | \eta(y) \rangle \rho(\sigma_i(y))^{-2} d\mu(y) \\
 &= \int_{\Omega} \rho(\sigma_i(y))^{-1} \langle U(\sigma_i(y))^* \xi(\sigma_i(y)) | \eta(y) \rangle d\mu(y),
 \end{aligned}$$

and the expression (1.22) for S_i^* follows.

If $\alpha = (\alpha_1 \alpha_2 \dots \alpha_n)$ with $\alpha_k \in \mathbb{Z}_d$, define

$$(1.43) \quad s_{\alpha} = s_{\alpha_1} s_{\alpha_2} \cdots s_{\alpha_n}, \quad S_{\alpha} = S_{\alpha_1} S_{\alpha_2} \cdots S_{\alpha_n}.$$

One verifies from (1.21) and (1.22) that

$$\begin{aligned}
 (1.44) \quad S_{\alpha} \xi(x) &= \chi_{\alpha_1}(x) \chi_{\alpha_2}(\sigma(x)) \cdots \chi_{\alpha_n}(\sigma^{n-1}(x)) \\
 &\quad \times \rho(x) \rho(\sigma(x)) \cdots \rho(\sigma^{n-1}(x)) \\
 &\quad \times U(x) U(\sigma(x)) \cdots U(\sigma^{n-1}(x)) \xi(\sigma^n(x))
 \end{aligned}$$

and

$$\begin{aligned}
 (1.45) \quad S_{\alpha}^* \xi(x) &= \rho(\sigma_{\alpha_n}(x))^{-1} \rho(\sigma_{\alpha_{n-1}} \sigma_{\alpha_n}(x))^{-1} \cdots \rho(\sigma_{\alpha_1} \cdots \sigma_{\alpha_n}(x))^{-1} \\
 &\quad \times U(\sigma_{\alpha_n}(x))^* U(\sigma_{\alpha_{n-1}} \sigma_{\alpha_n}(x))^* \cdots U(\sigma_{\alpha_1} \cdots \sigma_{\alpha_n}(x))^* \xi(\sigma_{\alpha_1} \cdots \sigma_{\alpha_1}(x)).
 \end{aligned}$$

Combining (1.44)–(1.45) with the relations

$$\begin{aligned}
 (1.46) \quad \sigma_{\alpha_n} \sigma^n(x) &= \sigma^{n-1}(x), \\
 &\quad \vdots \\
 \sigma_{\alpha_1} \cdots \sigma_{\alpha_n} \sigma^n(x) &= x,
 \end{aligned}$$

which are valid if $x = (\alpha_1, \dots, \alpha_n, x_{n+1}, \dots)$, we obtain

$$(1.47) \quad S_{\alpha} S_{\alpha}^* \xi(x) = \chi_{\alpha}(x) \xi(x),$$

where

$$(1.48) \quad \chi_{\alpha}(x_1, x_2, x_3, \dots) = \delta_{\alpha_1 x_1} \delta_{\alpha_2 x_2} \cdots \delta_{\alpha_n x_n}.$$

This proves firstly that

$$(1.49) \quad \sum_{i=1}^d S_i S_i^* = \mathbf{1};$$

and (1.41) and (1.49) show that $s_i \mapsto S_i$ is indeed a representation of the Cuntz relations. Secondly, (1.47) shows that \mathcal{D}_d maps onto the algebra of operators on \mathcal{H} of the form

$$(1.50) \quad \int_{\Omega} \lambda(x) \mathbf{1}_{\mathcal{H}(x)} d\mu(x)$$

where λ ranges over all continuous functions on the Cantor set Ω . Thus the restriction of the representation $s_i \mapsto S_i$ to \mathcal{D}_d is indeed the spectral representation.

To show the main part of Theorem 1.2, i.e., the existence of the objects $\mathcal{H}(x)$, $d\mu(x)$, $U(x)$, one does indeed start with a spectral measure μ for the restriction of the representation to \mathcal{D}_d . The spectrum of \mathcal{D}_d is Ω , so this gives the decomposition (1.17), and the action of \mathcal{D}_d on \mathcal{H} is given by (1.47). If $f \in C(\Omega) = \mathcal{D}_d$, and M_f is the representative of f in \mathcal{H} :

$$(1.51) \quad M_f = \int_{\Omega}^{\oplus} f(x) \mathbb{1}_{\mathcal{H}(x)} d\mu(x),$$

then

$$(1.52) \quad M_{f \circ \sigma} = \sum_{i=1}^d S_i M_f S_i^*$$

and the quasi-invariance of μ under σ follows. Thus one may define $\rho(x)$ by (1.23). Similarly, if $f \in C(\Omega) = \mathcal{D}_d$ has support in $\sigma_i(\Omega) = i\Omega = \Omega_i$, one verifies that

$$(1.53) \quad M_{f \circ \sigma_i} = S_i^* M_f S_i.$$

Thus the two representations of $C(\Omega_i)$ given by $f \mapsto M_f$ on $M_{\chi_i} \mathcal{H}$ and $f \mapsto M_{f \circ \sigma_i}$ on \mathcal{H} are unitarily equivalent. In particular, this means that $\dim(\mathcal{H}(x)) = \dim(\mathcal{H}(\sigma_i(x)))$ for μ -almost all x , so the constancy of $\dim(\mathcal{H}(x))$ almost everywhere over the orbits of $\sigma_1, \dots, \sigma_d$ follows. But (1.4) then implies that $\dim(\mathcal{H}(x))$ is constant on σ -orbits (actually the two forms of constancy are equivalent). Also it follows from the unitary equivalence (1.53) that μ is quasi-invariant under σ_i and that $\rho(\sigma_i(x))^{-1} = \left(\frac{d\mu(\sigma_i(x))}{d\mu(x)}\right)^{1/2}$ exists. See [67] or [70, Section 2.5.3] for details on spectral multiplicity theory. Now, one may define a representation $s_i \mapsto T_i$ of \mathcal{O}_d on \mathcal{H} by

$$(1.54) \quad (T_i \xi)(x) = \chi_i(x) \rho(x) \xi(\sigma(x)).$$

One checks that this is indeed a representation of \mathcal{O}_d by the first part of the proof, and by the proof of (1.47) it follows that

$$(1.55) \quad T_{\alpha} T_{\alpha}^* = S_{\alpha} S_{\alpha}^*$$

for all multi-indices α . Define an operator U by

$$(1.56) \quad U = \sum_{i=1}^d S_i T_i^*.$$

Using the Cuntz relations in a standard manner, one checks that U is a unitary operator, and

$$(1.57) \quad S_i = U T_i$$

for $i = 1, \dots, d$. Putting

$$(1.58) \quad i\alpha := (i \alpha_1 \alpha_2 \dots \alpha_n),$$

we have by (1.55)

$$\begin{aligned}
 (1.59) \quad T_{i\alpha} T_{i\alpha}^* &= S_{i\alpha} S_{i\alpha}^* \\
 &= S_i S_\alpha S_\alpha^* S_i^* \\
 &= U T_i T_\alpha T_\alpha^* T_i^* U^* \\
 &= U T_{i\alpha} T_{i\alpha}^* U^*,
 \end{aligned}$$

and hence U commutes with the representatives on \mathcal{H} of the algebra \mathcal{D}_d . Hence U has a decomposition

$$(1.60) \quad U = \int_{\Omega}^{\oplus} U(x) d\mu(x)$$

where $\Omega \ni x \mapsto U(x)$ is a measurable field on unitaries. It now follows from (1.54) and (1.57) that S_i has the form (1.21). This ends the proof of Theorem 1.2. \square

Proof of Theorem 1.4. Adopt the assumptions in Theorem 1.4 and let T be an intertwiner between the two representations. In particular this means that T intertwines the two spectral representations of \mathcal{D}_d on \mathcal{H} and $\tilde{\mathcal{H}}$, respectively, i.e.,

$$(1.61) \quad T S_\alpha S_\alpha^* = \tilde{S}_\alpha \tilde{S}_\alpha^* T$$

for all multi-indices α . But this is equivalent to Ω having the decomposition (1.30) and T having the measurable decomposition

$$(1.62) \quad T = \int_{\Omega_0}^{\oplus} T(x) d\mu(x)$$

where $T(x) \in \mathcal{B}(\mathcal{H}(x), \tilde{\mathcal{H}}(x))$. We now compute, using (1.21),

$$\begin{aligned}
 (1.63) \quad T S_i \xi(x) &= T(x) (S_i \xi)(x) \\
 &= \chi_i(x) \rho(x) T(x) U(x) \xi(\sigma(x))
 \end{aligned}$$

and

$$\begin{aligned}
 (1.64) \quad \tilde{S}_i T \xi(x) &= \chi_i(x) \rho(x) \tilde{U}(x) (T \xi)(\sigma(x)) \\
 &= \chi_i(x) \rho(x) \tilde{U}(x) T(\sigma(x)) \xi(\sigma(x)).
 \end{aligned}$$

Using the intertwining property (1.31) we thus deduce that

$$(1.65) \quad T(x) U(x) = \tilde{U}(x) T(\sigma(x)).$$

Conversely, if T satisfies (1.65), the intertwining follows from (1.63) and (1.64). This ends the proof of Theorem 1.4. \square

CHAPTER 2

The free group on d generators

In this chapter we will construct certain representations of \mathcal{O}_d in the Hilbert spaces \mathcal{H} where the decomposition in Theorem 1.2 takes the form

$$(2.1) \quad \int_{\Omega}^{\oplus} \mathcal{H}(x) d\mu(x) \cong L^2(\Omega, d\mu) \otimes \mathcal{H}_0.$$

We will equip $\Omega = \prod_{i=1}^{\infty} \mathbb{Z}_d$ with the product measure $\mu = \mu_p$ defined from a choice of weights $(p_i)_{i=1}^d$, with $p_i > 0$, and $\sum_i p_i = 1$. Then the representation (1.21)–(1.22) takes the form

$$(2.2) \quad (S_i \xi)(x) = \delta_i(x_1) \frac{1}{\sqrt{p_i}} U(x) \xi(\sigma(x)),$$

$$(2.3) \quad (S_i^* \xi)(x) = \sqrt{p_i} U(\sigma_i(x))^* \xi(\sigma_i(x)).$$

The simplest case of this is when $\dim \mathcal{H}_0 = 1$ and $U(x) \equiv 1$. Then the corresponding operators S_i of (2.2) act on scalar functions in $L^2(\Omega, \mu)$. The constant function $\mathbb{1}$ in $L^2(\Omega, \mu)$ satisfies $S_i^* \mathbb{1} = \sqrt{p_i} \mathbb{1}$, and the state $\omega_{\mathbb{1}} = \langle \mathbb{1} | \cdot | \mathbb{1} \rangle$ on $\mathcal{B}(L^2(\Omega, \mu))$ satisfies

$$(2.4) \quad \omega_{\mathbb{1}}(\rho(A)) = \omega_{\mathbb{1}}(A), \quad A \in \mathcal{B}(L^2(\Omega, \mu))$$

where

$$\rho(A) = \sum S_i A S_i^*.$$

This is the representation defined by the Cuntz states [16, Theorem 4.1].

It is well known, see, e.g., [16], that there is a correspondence between representations of \mathcal{O}_d (for some d including $d = \infty$) and endomorphisms of $\mathcal{B}(\mathcal{H})$. An endomorphism ρ of $\mathcal{B}(\mathcal{H})$ has a finite Powers index d if the commutant of $\rho(\mathcal{B}(\mathcal{H}))$ is isomorphic to $M_d(\mathbb{C})$, and then the corresponding representation is of \mathcal{O}_d . Two representations $\pi, \tilde{\pi}$ of \mathcal{O}_d define the same endomorphism if and only if there exists a g in the group $U(d)$ of complex unitary $d \times d$ matrices such that $\tilde{\pi} = \pi \circ \alpha_g$ where α_g is the canonical $U(d)$ -action on \mathcal{O}_d rotating the generators.

There is precisely one conjugacy class of endomorphisms of $\mathcal{B}(\mathcal{H})$ with an invariant vector state ω , i.e.,

$$(2.5) \quad \omega \circ \rho = \omega,$$

see (2.4) and [76, 77] or [16, Theorem 4.2]. We showed in [10] and [9] that the theory of wavelets gives examples of endomorphisms in different conjugacy classes. In this memoir, we will also look at endomorphisms of von Neumann algebras not of type I.

Scale-two wavelet representations are constructed from measurable functions on \mathbb{T} subject to $|m(z)|^2 + |m(-z)|^2 = 2$. If

$$\begin{cases} m_1(z) = m(z) \\ m_2(z) = z\bar{m}(-z) \end{cases}$$

then

$$(2.6) \quad (S_j \xi)(z) = m_j(z) \xi(z^2), \quad j = 1, 2$$

define a representation of \mathcal{O}_2 . Giving the wavelet representations (of \mathcal{O}_2) in the form of Theorem 1.2 amounts to representing the commuting operators (in fact projections)

$$S_{j_1} \cdots S_{j_k} S_{j_k}^* \cdots S_{j_1}^* = S_\alpha S_\alpha^* \quad (\alpha = (j_1 \cdots j_k))$$

as multiplication operators on some $L^2(\Omega, \mathcal{H}_0)$. Such a representation will involve a 2-adic completion, but will perhaps not be explicit enough for practical applications: In the representation, the operator

$$(2.7) \quad (S_\alpha S_\alpha^* \xi)(z) = \frac{1}{2^k} m_{j_1}(z) \cdots m_{j_k}(z^{2^{k-1}}) \\ \times \sum_{w^{2^k}=1} \bar{m}_{j_1}(wz) \bar{m}_{j_2}(w^2 z^2) \cdots \bar{m}_{j_k}(w^{2^{k-1}} z^{2^{k-1}}) \xi(wz)$$

must be multiplication by a characteristic function of a set E_α in the 2-adic completion.

We postpone the details to a later paper.

Returning to the computation of the measurable field $\Omega \ni x \mapsto U(x)$ of unitary operators in Theorem 1.2, we do the calculation for the (p_1, \dots, p_d) -product measure on $\Omega = \prod_1^\infty \mathbb{Z}_d$, and with the resulting representation $s_i \mapsto S_i$ of type III. (More details on β -KMS states and the $\mathbb{T}^d \subseteq U(d)$ action on \mathcal{O}_d are included in Chapter 3 below.) We show there that if

$$(2.8) \quad p_j = e^{-\beta L_j}, \quad j = 1, \dots, d,$$

and $L = (L_1, \dots, L_d) \in \mathbb{R}^d$, $L_j > 0$, then the state ω on \mathcal{O}_d given by

$$(2.9) \quad \omega(s_{i_1} \cdots s_{i_k} s_{j_1}^* \cdots s_{j_l}^*) = \delta_{kl} \delta_{i_1 j_1} \cdots \delta_{i_k j_k} p_{i_1} p_{i_2} \cdots p_{i_k}$$

is a (unique) β -KMS state for the one-parameter subgroup of \mathbb{T}^d defined by L , i.e., $t \mapsto (e^{itL_1}, e^{itL_2}, \dots, e^{itL_d})$. (For ω to be a state, β must be chosen such that $\sum_j p_j = 1$, and then ω_β is the gauge-invariant extension to \mathcal{O}_d of the product state defined on $\text{UHF}_d \cong \bigotimes_1^\infty M_d$ as $\bigotimes_1^\infty \varphi$, where φ is the state on M_d defined by the density matrix $\text{diag}(p_1, \dots, p_d)$.) Let $s_i \mapsto T_i$ be the representation of \mathcal{O}_d which is induced from ω via the GNS construction. Let \mathbb{F}_d be the free group on d generators g_1, \dots, g_d , and let $\mathbb{F}_d \ni g \mapsto \lambda(g)$ be the trace representation of \mathbb{F}_d . Recall the trace tr on $C_r^*(\mathbb{F}_d)$ is given by

$$\text{tr}(\lambda(g)) = \begin{cases} 1 & \text{if } g = e, \\ 0 & \text{if } g \neq e. \end{cases}$$

The Hilbert space $\ell^2(\mathbb{F}_d)$ has as orthonormal basis the functions

$$\{\xi_g \mid g \in \mathbb{F}_d\} \quad \text{where } \xi_g(x) = \begin{cases} 1 & \text{if } x = g, \\ 0 & \text{if } x \neq g, \end{cases}$$

and

$$(2.10) \quad \mathrm{tr}(A) = \langle \xi_e | \lambda(A) \xi_e \rangle, \quad A \in C_r^*(\mathbb{F}_d).$$

Let $\mathcal{H}_0 = \ell^2(\mathbb{F}_d)$. For multi-indices α , set $p^\alpha = p_{\alpha_1} \cdots p_{\alpha_k}$.

Proposition 2.1. *The state defined by (2.9), i.e.,*

$$(2.11) \quad \omega(s_\alpha s_\gamma^*) = \delta_{\alpha\gamma} p^\alpha$$

is the vector state defined by $\mathbb{1} \otimes \xi_e$ in the representation on $L_\mu^2(\prod_1^\infty \mathbb{Z}_d, \ell^2(\mathbb{F}_d)) = L_\mu^2(\prod_1^\infty \mathbb{Z}_d) \otimes \ell^2(\mathbb{F}_d)$ by

$$(2.12) \quad (T_j \xi)(x) = e^{\frac{1}{2}\beta L_j} \chi_j(x) \lambda(g_j) \xi(\sigma(x)),$$

$$(2.13) \quad (T_j^* \xi)(x) = e^{-\frac{1}{2}\beta L_j} \lambda(g_j^{-1}) \xi(\sigma_i(x)),$$

so, in particular, the operators $U(x)$ from Theorem 1.2 are independent of the product measure μ when the representation is realized in $L_\mu^2(\prod_1^\infty \mathbb{Z}_d, \ell^2(\mathbb{F}_d))$, i.e., on vector-valued functions on the group $\prod_1^\infty \mathbb{Z}_d$ with values in $\ell^2(\mathbb{F}_d)$ and with μ equal to the product measure on $\prod_1^\infty \mathbb{Z}_d$ relative to $p_j = e^{-\beta L_j}$, $j = 1, \dots, d$.

Proof. Note that the representation T_j in (2.12)–(2.13) is of the form $T_j = S_j \otimes \lambda(g_j)$ where S_j is the representation in Theorem 1.2 corresponding to the scalar-valued case with μ product measure and $U \equiv 1$. We then use

Lemma 2.2. *Let (S_j) be a representation of \mathcal{O}_d in a Hilbert space \mathcal{L} and let \mathcal{H}_0 be a second Hilbert space. If $(A_j)_{j=1}^d$ are operators in \mathcal{H}_0 , then $T_j := S_j \otimes A_j$ define a representation of \mathcal{O}_d in $\mathcal{L} \otimes \mathcal{H}_0$ if and only if the A_i 's are unitary.*

Proof. We have

$$\begin{aligned} T_j^* T_k &= S_j^* S_k \otimes A_j^* A_k \\ &= \delta_{jk} \mathbb{1}_{\mathcal{L}} \otimes A_j^* A_k. \end{aligned}$$

Hence $T_j^* T_k = \delta_{jk} \mathbb{1}_{\mathcal{L} \otimes \mathcal{H}_0}$ holds if and only if each A_j is isometric.

We have

$$\sum_j T_j T_j^* = \sum_j S_j S_j^* \otimes A_j A_j^*.$$

But the projections $S_j S_j^*$ are mutually orthogonal. So $\sum_j T_j T_j^* = \mathbb{1}_{\mathcal{L} \otimes \mathcal{H}_0}$ if and only if each A_j is coisometric. The result follows. \square

Now we apply the lemma to $A_j = \lambda(g_j)$, $\mathcal{H}_0 = \ell^2(\mathbb{F}_d)$, and it remains to check that the vector state

$$(2.14) \quad \Omega_0 := \mathbb{1} \otimes \xi_e \in L^2\left(\prod_1^\infty \mathbb{Z}_d, \mu\right) \otimes \ell^2(\mathbb{F}_d)$$

yields the state ω in (2.11). Let $g_\alpha = g_{\alpha_1} g_{\alpha_2} \cdots g_{\alpha_k}$ for multi-indices $\alpha = (\alpha_1 \dots \alpha_k)$, $\alpha_i \in \mathbb{Z}_d$, $1 \leq i \leq k$. Then $T_\alpha = S_\alpha \otimes \lambda(g_\alpha)$, and

$$\begin{aligned} \langle \Omega_0 | T_\alpha T_\gamma^* \Omega_0 \rangle &= \langle \xi_e | \lambda(g_\alpha g_\gamma^{-1}) \xi_e \rangle \langle \mathbb{1} | S_\alpha S_\gamma^* \mathbb{1} \rangle \\ &= \delta_{\alpha\gamma} p_\alpha \end{aligned}$$

where $p^\alpha = p_{\alpha_1} p_{\alpha_2} \cdots p_{\alpha_k}$, and where we used Theorem 1.2 for the scalar-valued representation S_j in $L^2(\prod_1^\infty \mathbb{Z}_d)$ and the observations from above on the trace of \mathbb{F}_d . The term

$$\langle \xi_e | \lambda(g_\alpha g_\gamma^{-1}) \xi_e \rangle = \mathrm{tr}(g_\alpha g_\gamma^{-1})$$

is nonzero (and therefore = 1) if and only if $g_\alpha = g_\gamma$, i.e.,

$$g_{\alpha_1} g_{\alpha_2} \cdots g_{\alpha_k} = g_{\gamma_1} g_{\gamma_2} \cdots g_{\gamma_l}.$$

Since we are in the free group, this happens precisely when $k = l$ and $g_{\alpha_1} = g_{\gamma_1}, \dots, g_{\alpha_k} = g_{\gamma_k}$. \square

We now turn to the characterization of the cyclic subspace generated by the representation π_ω from Proposition 2.1 when the state ω is given as in (2.9), (2.11). Let

$$(2.15) \quad \mathcal{H}_{\Omega_0} := [\pi_\omega(\mathcal{O}_d)\Omega_0]$$

where $\Omega_0 = \mathbf{1} \otimes \xi_e$ and $\pi_\omega(s_i) = S_i \otimes \lambda(g_i)$.

Let g_1, \dots, g_d be the generators of \mathbb{F}_d , and let $\mathbb{S}_d \subseteq \mathbb{F}_d$ be the corresponding free semigroup, i.e., \mathbb{S}_d consists of elements $g_\alpha = g_{\alpha_1} g_{\alpha_2} \cdots g_{\alpha_k}$ (containing no inverses of any g_i , $i = 1, \dots, d$) indexed by $\alpha = (\alpha_1 \dots \alpha_k)$, $\alpha_i \in \mathbb{Z}_d = \{1, \dots, d\}$, $1 \leq i \leq k$, with k depending on α . Let $\mathbb{S}_d^{-1} = \{s^{-1} \mid s \in \mathbb{S}_d\}$, and let $\mathcal{H}_- := [\lambda(\mathbb{S}_d^{-1})\xi_e] \subseteq \ell^2(\mathbb{F}_d)$ be the closed linear span in $\ell^2(\mathbb{F}_d)$ of the vectors $\{\lambda(s^{-1})\xi_e \mid s \in \mathbb{S}_d\}$. For a multi-index α , and $v \in \mathcal{H}_-$, define $\xi_v^{(\alpha)}: \prod_1^\infty \mathbb{Z}_d \rightarrow \ell^2(\mathbb{F}_d)$ by

$$(2.16) \quad \begin{aligned} \xi_v^{(\alpha)}(x) &= \chi_\alpha(x) \lambda(g_\alpha) v \\ &= (\chi_\alpha \otimes \lambda(g_\alpha) v), \quad x \in \prod_1^\infty \mathbb{Z}_d, \quad x = (x_1, x_2, \dots), \end{aligned}$$

where

$$\chi_\alpha(x) = \delta_{\alpha_1 x_1} \delta_{\alpha_2 x_2} \cdots \delta_{\alpha_k x_k}$$

and we use the convention

$$(2.17) \quad \xi_v^{(\emptyset)}(x) = v.$$

Lemma 2.3. *The cyclic subspace $\mathcal{H}_{\Omega_0} = [\pi_\omega(\mathcal{O}_d)\Omega_0] \subseteq L_\mu^2(\prod_1^\infty \mathbb{Z}_d, \ell^2(\mathbb{F}_d))$ generated by $\Omega_0 = \mathbf{1} \otimes \xi_e$ in the representation defined by $T_i = S_i \otimes \lambda(g_i)$, where $(S_i \xi)(x) = e^{\frac{1}{2}\beta L_i} \chi_i(x) \xi(\sigma(x))$, $\xi \in L^2(\prod_1^\infty \mathbb{Z}_d, \mu)$, is the closure in $L_\mu^2(\prod_1^\infty \mathbb{Z}_d, \ell^2(\mathbb{F}_d))$ of the linear span of the functions $\xi_v^{(\alpha)}$ in (2.16).*

Proof. From (2.12)–(2.13), we have

$$(2.18) \quad T_\alpha T_\gamma^* (\mathbf{1} \otimes \xi_e)(x) = e^{(\beta/2)(L(\alpha) - L(\gamma))} \chi_\alpha(x) \lambda(g_\alpha g_\gamma^{-1}) \xi_e,$$

where $\alpha = (\alpha_1 \dots \alpha_k)$, $\gamma = (\gamma_1 \dots \gamma_l)$ are multi-indices, and

$$(2.19) \quad L(\alpha) = \sum_i L_{\alpha_i} = \sum_j \#_j(\alpha) L_j, \quad \#_j(\alpha) = \#\{\alpha_i \mid \alpha_i = j\}.$$

Since $v_\gamma := \lambda(g_\gamma^{-1})\xi_e \in \mathcal{H}_-$, the result follows. \square

Remark 2.4. The cyclic subspace \mathcal{H}_{Ω_0} is a proper subspace in $L_\mu^2(\prod_1^\infty \mathbb{Z}_d, \ell^2(\mathbb{F}_d))$. If $i \neq j$, define $\xi(x) = \delta_i(x_1) \lambda(g_j) \xi_e$, $x \in \prod_1^\infty \mathbb{Z}_d$. Then ξ is orthogonal to \mathcal{H}_{Ω_0} . For this, we need only show that ξ is orthogonal to the vectors $\xi_v^{(\alpha)}$ in (2.16). We have

$$\begin{aligned} \langle \xi \mid \xi_v^{(\alpha)} \rangle &= \sum_{r=1}^d p_r \delta_i(r) \delta_{\alpha_1}(r) \int_{\prod_1^\infty \mathbb{Z}_d} \chi_{\alpha_2 \dots \alpha_k}(x) d\mu(x) \langle \lambda(g_j) \xi_e \mid \lambda(g_\alpha) v \rangle \\ &= p_{\alpha_1} \delta_i \alpha_1 p_{\alpha_2} \cdots p_{\alpha_k} \langle \xi_e \mid \lambda(g_j^{-1} g_\alpha) v \rangle. \end{aligned}$$

Since $v \in \mathcal{H}_-$, it is enough to show that

$$\delta_{i\alpha_1} \langle \xi_e \mid \lambda(g_j^{-1}g_\alpha) \xi_{s^{-1}} \rangle$$

vanishes for $s \in \mathbb{S}_d$. The second factor is $\text{tr}(g_j^{-1}g_\alpha s^{-1})$, and this is nonvanishing only if $g_j s = g_\alpha$. But the first factor is $\delta_{i\alpha_1}$, so we must have $\alpha_1 = i$ for the product to be $\neq 0$. Hence $g_j s = g_i g_{\alpha_2} \cdots g_{\alpha_k}$ must hold at a place where the product is $\neq 0$. But this is impossible in the free group \mathbb{F}_d .

The vectors $\xi_v^{(\alpha)}$ in (2.16) are indexed by the multi-indices $\alpha = (\alpha_1 \dots \alpha_k)$ and vectors $v \in \mathcal{H}_-$. Using these we get the following explicit formula for the operators $T_i = \pi_\omega(s_i)$.

Proposition 2.5. *The generators T_i , $1 \leq i \leq d$, for the cyclic \mathcal{O}_d -representation of the state defined by (2.11) act as follows on the vectors $\xi_v^{(\alpha)}(x) = \chi_\alpha(x) \lambda(g_\alpha)$ defined by (2.16) and (2.17) ($x \in \prod_1^\infty \mathbb{Z}_d$, $v \in \mathcal{H}_-$):*

$$(2.20) \quad T_i \left(\xi_v^{(\alpha)} \right) = e^{(\beta/2)L_i} \xi_v^{(i\alpha)},$$

$$(2.21) \quad T_i^* \left(\xi_v^{(\alpha)} \right) = e^{-(\beta/2)L_i} \delta_{i\alpha_1} \xi_v^{(\alpha_2 \alpha_3 \dots \alpha_k)},$$

if $\alpha \neq \emptyset$,

$$(2.22) \quad T_i^* \left(\xi_v^{(\emptyset)} \right) = e^{-(\beta/2)L_i} \xi_{\lambda(g_i^{-1})v}^{(\emptyset)},$$

$$(2.23) \quad T_\gamma T_\gamma^* \left(\xi_v^{(\alpha)} \right) = \chi_\gamma(\alpha) \xi_v^{(\alpha)}$$

if $|\gamma| \leq |\alpha|$ (i.e., $l \leq k$, $\gamma = (\gamma_1 \dots \gamma_l)$, $\alpha = (\alpha_1 \dots \alpha_k)$),

and

$$(2.24) \quad (T_\gamma T_\gamma^*) \xi_v^{(\emptyset)} = \chi_\gamma \otimes v$$

with $\gamma = (\gamma_1 \dots \gamma_l)$.

Hence, if $l > k$,

$$(2.25) \quad T_\eta T_\gamma^* \xi_v^{(\alpha)} = e^{(\beta/2)(L(\eta) - L(\gamma))} \delta_{\gamma_1 \alpha_1} \cdots \delta_{\gamma_k \alpha_k} \xi_{\lambda(g_{\gamma_1}^{-1} \dots g_{\gamma_{k+1}}^{-1})v}^{(\eta)}.$$

Proof. We compute the action of T_i and T_i^* directly from the formulas given in Proposition 2.1. We have

$$\begin{aligned} T_i \xi_v^{(\alpha)}(x) &= e^{\frac{1}{2}\beta L_i} \chi_i(x) \chi_\alpha(\sigma(x)) \lambda(g_i) \lambda(g_\alpha) v \\ &= e^{\frac{1}{2}\beta L_i} \delta_i(x_1) \delta_{\alpha_1}(x_2) \cdots \delta_{\alpha_k}(x_{k+1}) \lambda(g_i g_\alpha) v \\ &= e^{\frac{1}{2}\beta L_i} \chi_{(i\alpha)}(x) \lambda(g_{(i\alpha)}) v \\ &= e^{(\beta/2)L_i} \xi_v^{(i\alpha)}(x), \end{aligned}$$

proving (2.20), and

$$\begin{aligned} T_i^* \xi_v^{(\alpha)}(x) &= e^{-(\beta/2)L_i} \chi_\alpha(\sigma_i(x)) \lambda(g_i^{-1}) \lambda(g_\alpha) v \\ &= e^{-(\beta/2)L_i} \delta_{i\alpha_1} \chi_{(\alpha_2 \alpha_3 \dots \alpha_k)}(x) \lambda(g_i^{-1} g_\alpha) v \\ &= e^{-(\beta/2)L_i} \delta_{i\alpha_1} \chi_{(\alpha_2 \dots \alpha_k)}(x) \lambda(g_i^{-1} g_i g_{\alpha_2} \cdots g_{\alpha_k}) v \\ &= e^{-(\beta/2)L_i} \delta_{i\alpha_1} \chi_{(\alpha_2 \dots \alpha_k)}(x) \lambda(g_{(\alpha_2 \dots \alpha_k)}) v \\ &= e^{-(\beta/2)L_i} \delta_{i\alpha_1} \xi_v^{(\alpha_2 \dots \alpha_k)}(x), \end{aligned}$$

proving (2.21). The stated formulas for $T_i^* \xi_v^{(\emptyset)}$ and $T_\gamma T_\gamma^* \xi_v^{(\alpha)}$, $v \in \mathcal{H}_-$, result from the following covariance principle: $\chi_i \otimes v = \xi_{\lambda(g_i^{-1})v}^{(i)}$, and, more generally, $\chi_\alpha \otimes v = \xi_{\lambda(g_\alpha^{-1})v}^{(\alpha)}$. The formula (2.24) is a special case of (1.47). \square

Corollary 2.6. *Let v be an arbitrary vector in \mathcal{H}_- . As $\gamma = (\gamma_1 \dots \gamma_l)$ ranges over all \mathbb{Z}_d -multi-indices, the closed linear span of $\left\{ (T_\gamma T_\gamma^*) \xi_v^{(\emptyset)} \right\}_\gamma$ in $L_\mu^2 \left(\prod_1^\infty \mathbb{Z}_d, \ell^2(\mathbb{F}_d) \right)$ is $L_\mu^2 \left(\prod_1^\infty \mathbb{Z}_d \right) \otimes v$ where μ is still the (p_i) -product measure on $\prod_1^\infty \mathbb{Z}_d$.*

Proof. This is immediate from (2.24). \square

Remark 2.7. Let \mathcal{H}_{Ω_0} be the cyclic subspace of the representation of \mathcal{O}_d induced from the state $\omega_{(p)}(s_\alpha s_\gamma^*) = p_\alpha \delta_{\alpha\gamma}$. Then $L^2 \left(\prod_1^\infty \mathbb{Z}_d \right) \otimes \mathcal{H}_-$ is a proper subspace in \mathcal{H}_{Ω_0} . For example, the vector $\chi_i \otimes \xi_{g_i}$ is in $\mathcal{H}_{\Omega_0} \ominus (L^2 \otimes \mathcal{H}_-)$.

Proof. We check that $\langle \chi_i \otimes \xi_{g_i} | f \otimes v \rangle = 0$ for all $f \in L^2 \left(\prod_1^\infty \mathbb{Z}_d \right)$, and $v \in \mathcal{H}_-$. We may assume that $v = \xi_{s^{-1}}$ for $s \in \mathbb{S}_d$ (= the free semigroup on the generators $\{g_j\}_{j=1}^d$). The inner product is

$$p_i \int f(i, x) d\mu_{(p)}(x) \langle \xi_{g_i} | \xi_{s^{-1}} \rangle,$$

and $\langle \xi_{g_i} | \xi_{s^{-1}} \rangle = \text{tr}(g_i^{-1} s^{-1}) = 0$, since there is no solution $s \in \mathbb{S}_d$ to the equation $sg_i = e$. \square

Summarizing Remarks 2.4 and 2.7 we have

$$L_\mu^2 \otimes \mathcal{H}_- \subsetneq \mathcal{H}_{\Omega_0} \subsetneq L_\mu^2 \otimes \ell^2(\mathbb{F}_d).$$

Definition 2.8. Let \mathcal{H} and \mathcal{H}_- be Hilbert spaces, and let \mathcal{M} be a set. We say that \mathcal{H} is *fibred* over \mathcal{M} with fibers isomorphic to \mathcal{H}_- if there are isometries i_α , indexed by $\alpha \in \mathcal{M}$, $i_\alpha: \mathcal{H}_- \rightarrow \mathcal{H}$, such that \mathcal{H} is the closed linear span of $\{i_\alpha(\mathcal{H}_-) \mid \alpha \in \mathcal{M}\}$.

The Fibred Space. Let $\omega_{(p)}$ be the state from above, and let \mathcal{H}_{Ω_0} be the cyclic space of the \mathcal{O}_d -representation. Let $\mathcal{M}(\mathbb{Z}_d)$ be the set of all multi-indices formed from \mathbb{Z}_d . Then \mathcal{H}_{Ω_0} is fibred (as a Hilbert space) over $\mathcal{M}(\mathbb{Z}_d)$, the fiber over each α in $\mathcal{M}(\mathbb{Z}_d)$ is a copy of \mathcal{H}_- .

To prove this, let $\alpha \in \mathcal{M}(\mathbb{Z}_d)$, and define $\mathcal{H}(\alpha) \cong \mathcal{H}_-$ by

$$\mathcal{H}(\alpha) = \{ \chi_\alpha \otimes \lambda(g_\alpha) v \mid v \in \mathcal{H}_- \}.$$

The isomorphism $\mathcal{H}(\alpha) \cong \mathcal{H}_-$ and the isometries i_α are then made explicit by using the scale given by the following identity:

$$\| \chi_\alpha \otimes \lambda(g_\alpha) v \|_{\mathcal{H}_{\Omega_0}}^2 = p^\alpha \| v \|_{\mathcal{H}_-}^2,$$

where $p^\alpha = p_{\alpha_1} p_{\alpha_2} \dots p_{\alpha_k} > 0$. The convention for the empty index \emptyset in $\mathcal{M}(\mathbb{Z}_d)$ is that the fiber $\mathcal{H}(\emptyset)$ over \emptyset is

$$\mathcal{H}(\emptyset) = \{ \mathbb{1} \otimes v \mid v \in \mathcal{H}_- \}$$

where $\mathbb{1} = \chi_\emptyset$ denotes the constant function “one” in $L^2 \left(\prod_1^\infty \mathbb{Z}_d \right)$. The action of T_i, T_i^* on the fibers is given by Proposition 2.5. In particular it follows from (1.47) that the action of $L^\infty \left(\prod_1^\infty \mathbb{Z}_d \right)$ is given by

$$\pi_\omega(f) \xi_v^{(\alpha)} = (f \chi_\alpha) \otimes \lambda(g_\alpha) v, \quad v \in \mathcal{H}_-.$$

CHAPTER 3

β -KMS states for one-parameter subgroups
of the action of \mathbb{T}^d on \mathcal{O}_d

Consider the action of \mathbb{T}^d on \mathcal{O}_d given by

$$(3.1) \quad \sigma(z_1, \dots, z_d)(s_i) = z_i s_i.$$

If $L = (L_1, \dots, L_d) \in \mathbb{R}^d$, consider the one-parameter group

$$(3.2) \quad \sigma_t^L(x) = \sigma(e^{itL_1}, \dots, e^{itL_d})(x).$$

In general, if \mathfrak{A} is a C^* -algebra and $t \mapsto \sigma_t$ is a one-parameter group of $*$ -automorphisms of \mathfrak{A} , and $\beta \in \mathbb{R}$, recall that a state ω over \mathfrak{A} is defined to be a σ -KMS state at value β , or a (σ, β) -KMS state if

$$(3.3) \quad \omega(x\sigma_{i\beta}(y)) = \omega(yx)$$

for all x, y in a norm-dense σ -invariant $*$ -algebra of σ -analytic elements of \mathfrak{A} (see [19, Section 5.3.1] for several alternative formulations of this condition). It is well known that if $L = (1, 1, \dots, 1)$, so that σ is the so-called gauge group, the group σ^L has a KMS state at value β if and only if $\beta = \log d$, and this state is unique and is given by

$$(3.4) \quad \omega(s_\alpha s_\gamma^*) = \delta_{\alpha\gamma} d^{-|\alpha|};$$

see [19, Example 5.3.27], [8], or [69]. We first note that the latter result has an easy extension to more general one-parameter subgroups.

Proposition 3.1. *The one-parameter group σ^L admits a KMS state at some value β if and only if L_1, L_2, \dots, L_d all are nonzero and have the same sign. This value β is then unique and is given as the real solution of*

$$(3.5) \quad \sum_{k=1}^d e^{-\beta L_k} = 1.$$

The σ^L -KMS state ω at value β is then also unique, and is given by

$$(3.6) \quad \omega(s_\alpha s_\gamma^*) = \delta_{\alpha\gamma} e^{-\beta \sum_{k=1}^{|\alpha|} L_{\alpha_k}}.$$

Proof. If ω is a KMS state at value β , then

$$(3.7) \quad \omega(s_\alpha s_\gamma^*) = \omega(s_\gamma^* \sigma_{i\beta}(s_\alpha)) = e^{-\beta \sum_{k=1}^{|\alpha|} L_{\alpha_k}} \omega(s_\gamma^* s_\alpha).$$

If $\alpha = (k)$, $\gamma = (j)$, this says

$$(3.8) \quad \omega(s_k s_j^*) = \delta_{kj} e^{-\beta L_k}.$$

But

$$(3.9) \quad 1 = \sum_{k=1}^d \omega(s_k s_k^*) = \sum_{k=1}^d e^{-\beta L_k}$$

and hence β is a solution of (3.5). But this equation has solutions β if and only if all L_k are nonzero, and all have the same sign; and, in that case, the solution β is unique. For definiteness, assume that all L_k are positive, and then the solution β of (3.5) is also positive. Because of the Cuntz relations, the element $s_\gamma^* s_\alpha$ is either $\mathbb{1}$ (if $\gamma = \alpha$), 0, or of the form s_δ or s_δ^* for some δ . But from (3.7), we have

$$(3.10) \quad \omega(s_\delta) = e^{-\beta \sum_{k=1}^{|\delta|} L_k} \omega(s_\delta)$$

and thus $\omega(s_\delta) = 0$ for all nonempty strings δ . Hence it follows from (3.7) again that

$$(3.11) \quad \omega(s_\alpha s_\gamma^*) = e^{-\beta \sum_{k=1}^{|\alpha|} L_{\alpha_k}} \delta_{\alpha\gamma},$$

which is (3.6). But this expression does indeed define a state by Proposition 2.1. The case that all L_k are negative is treated similarly, so this proves Proposition 3.1. \square

The KMS states and the one-parameter subgroups of automorphisms were also used in recent papers [39, 59, 60] where crossed products $\mathcal{O}_d \rtimes_\sigma \mathbb{R}$ were studied. The states (3.6) seem to have first appeared in [27], [35] and [36].

The result in Proposition 3.1 is also related to results in [62], where KMS states for one-parameter subgroups of the dual actions of actions of lattice semigroups of endomorphisms scaling tracial states of a given C^* -algebra are considered. It turns out that the KMS states have non-trivial symmetries apart from invariance under the one-parameter semigroup, and in particular an “explanation” is given of the fact that our states given by (3.6) have the $\delta_{\alpha\gamma}$ term which forces them to live on the maximal abelian subalgebra \mathcal{D}_d which is the closure of the linear span of the monomials $s_\alpha s_\alpha^*$, i.e., the fixed-point algebra of the canonical coaction of \mathbb{F}_d .

Let us comment a bit on the representations defined by the state ω in (3.8). For definiteness, assume that L_1, \dots, L_d are all strictly positive. Let \mathfrak{A}_L be the fixed-point algebra of the modular automorphism group $\sigma^{(L)}$. We prove in Proposition 4.1 and Remark 14.1, below, that \mathfrak{A}_L is an AF-algebra. We consider the following algebras:

- \mathcal{O}_d = closed linear span of all $s_\alpha s_\gamma^*$,
- $\mathcal{O}_d^\mathbb{T}$ = UHF_d = closed linear span of all $s_\alpha s_\gamma^*$ with $|\alpha| = |\gamma|$
= fixed-point algebra of the gauge action of \mathbb{T} ,
- \mathfrak{A}_L = closed linear span of all $s_\alpha s_\gamma^*$ with $L(\alpha) = L(\gamma)$
= fixed-point algebra of the action $\sigma^{(L)}$, where $L(\alpha)$ is defined by (4.2),
- $\mathcal{O}_d^{\mathbb{T}^d}$ = GICAR_d = closed linear span of all $s_\alpha s_\gamma^*$ where $|\alpha| = |\gamma|$ and γ is a permutation of α
= fixed-point algebra of the gauge action of \mathbb{T}^d ,
- \mathcal{D}_d = closed linear span of all $s_\alpha s_\alpha^*$ (see (1.37))
= fixed-point algebra of the coaction of \mathbb{F}_d .

We have the following inclusions:

$$\begin{array}{ccccc}
 & & & \mathcal{O}_d^{\mathbb{T}} & \\
 & & & \nearrow & \searrow \\
 \mathcal{D}_d & \hookrightarrow & \mathcal{O}_d^{\mathbb{T}^d} & & \mathcal{O}_d, \\
 & & \searrow & & \nearrow \\
 & & & \mathfrak{A}_L &
 \end{array}$$

where $\mathfrak{A}_L = \mathcal{O}_d^{\mathbb{T}^d}$ if and only if L_1, L_2, \dots, L_d are rationally independent and $\mathfrak{A}_L = \mathcal{O}_d^{\mathbb{T}}$ if and only if $L_1 = L_2 = \dots = L_d$. In general \mathfrak{A}_L has a skew position relative to $\mathcal{O}_d^{\mathbb{T}} = \text{UHF}_d$.

We will here only analyze the representations given by the state (3.6) in the case that $L = (L_1, \dots, L_d)$ is in a class extensively studied in the remainder of the memoir: Each pair L_i, L_j is rationally dependent. We have to refer to results in Chapters 4 and 5. By a renormalization (see remarks after (4.1)) we may assume that the L_i 's are positive (nonzero) integers, and that $\gcd(L_1, \dots, L_d) = 1$. Then the associated one-parameter group $\sigma^{(L)}$ is periodic with period 2π , so we may view $\sigma^{(L)}$ as a representation of \mathbb{T} in the automorphism group of \mathcal{O}_d . Since $\gcd(L_1, \dots, L_d) = 1$, it follows, from the Euclidean algorithm and (4.5), that the spectral subspaces

$$(3.12) \quad \mathcal{O}_d^\sigma(n) = \left\{ x \in \mathcal{O}_d \mid \sigma_t^{(L)}(x) = e^{int}x \right\}$$

are nonzero for all $n \in \hat{\mathbb{T}} = \mathbb{Z}$ [18]. But we argue in the beginning of Chapter 5 that the fixed-point algebra

$$(3.13) \quad \mathfrak{A}_L = \mathcal{O}_d^\sigma(0)$$

is a simple unital AF-algebra with a unique trace state $\tau = \omega|_{\mathfrak{A}_L}$. Since all the spaces $\mathcal{O}_d^\sigma(n) \mathcal{O}_d^\sigma(n)^*$ are ideals in \mathfrak{A}_L , it follows further that

$$(3.14) \quad \mathcal{O}_d^\sigma(n) \mathcal{O}_d^\sigma(n)^* = \mathfrak{A}_L$$

for all $n \in \mathbb{N}$. If $(\hat{\sigma}, \hat{\omega})$ denotes the pair of extensions of (σ, ω) to the weak closure \mathcal{O}_d'' of \mathcal{O}_d in the representation defined by ω , it follows from (3.14) that the Γ -spectrum of the extension is

$$(3.15) \quad \Gamma(\hat{\sigma}) = \hat{\mathbb{T}} = \mathbb{Z}.$$

Also, since ω is a $\sigma^{(L)}$ -KMS state at value β , where β is defined by (3.5), it follows that

$$(3.16) \quad t \mapsto \hat{\sigma}(-t\beta)$$

is the modular automorphism group of $\hat{\omega}$; see [19, Definition 5.3.1 and Theorem 5.3.10].

Now, since $\tau = \omega|_{\mathfrak{A}_L}$ is the unique trace state on \mathfrak{A}_L , it defines a type II₁ factor representation of \mathfrak{A}_L . Using (3.14) in the form

$$(3.17) \quad \mathcal{O}_d^\sigma(n) \mathfrak{A}_L \mathcal{O}_d^\sigma(n)^* = \mathfrak{A}_L,$$

it follows that the representation of \mathcal{O}_d defined by ω , restricted to \mathfrak{A}_L , is quasiequivalent to the trace representation, and in particular \mathfrak{A}_L'' is isomorphic to the hyperfinite II_1 factor,

$$(3.18) \quad \mathfrak{A}_L'' \cong \mathcal{R}.$$

Using the definition (4.2), we see that

$$(3.19) \quad s_\alpha s_\gamma^* \in \mathcal{O}_d^\sigma(n) \iff L(\alpha) - L(\gamma) = n \quad \text{for all multi-indices } \alpha, \gamma.$$

Thus, using (3.6), we see that, if $y \in \mathfrak{A}_L$ and $x \in \mathcal{O}_d^\sigma(n)$ with $x^*xy = y = yx^*x$, then

$$(3.20) \quad \omega(xy x^*) = e^{-\beta n} \omega(y),$$

as follows from (3.16), (3.18), and (3.20). To see this, consider for example $x = s_\alpha s_\gamma^*$ with $L(\alpha) - L(\gamma) = n$. Let y be the initial projection of the partial isometry x , i.e.,

$$y = x^*x = s_\gamma s_\alpha^* s_\alpha s_\gamma^* = s_\gamma s_\gamma^* \in \mathfrak{A}_L.$$

Then

$$\omega(y) = e^{-\beta L(\gamma)}$$

from (3.6). But

$$\begin{aligned} xyx^* &= s_\alpha s_\gamma^* s_\gamma s_\alpha^* s_\gamma s_\alpha^* \\ &= s_\alpha s_\alpha^*, \end{aligned}$$

and so

$$\begin{aligned} \omega(xy x^*) &= e^{-\beta L(\alpha)} \\ &= e^{-\beta(L(\alpha) - L(\gamma))} e^{-\beta L(\gamma)} \\ &= e^{-\beta n} \omega(y). \end{aligned}$$

An elaboration of this computation proves (3.20).

It now follows from (3.16), (3.18), (3.20), and [24] or [86, Proposition 29.1] that \mathcal{O}_d'' is the hyperfinite $\text{III}_{e^{-\beta}}$ -factor. The factor \mathcal{O}_d'' can be written as the crossed product of $\mathfrak{A}_L'' \otimes \mathcal{B}(\mathcal{H})$ (= the hyperfinite II_∞ -factor) by an automorphism scaling the trace by $e^{-\beta}$, something which is reflected in (3.20). This automorphism is described in the end of Chapter 5, and should not be confused with a stabilized version of the endomorphism $\lambda = \sum_i s_i \cdot s_i^*$, except when $L_1 = L_2 = \dots = L_d = 1$.

We defer a detailed analysis of the case when the L_i 's are not pairwise rationally dependent to a later paper. Although \mathfrak{A}_L is still an AF-algebra, it is no longer simple, and it does not have a unique trace state. For example if $d = 2$ and L_1, L_2 are rationally independent, then \mathfrak{A}_L is the GICAR algebra which is a primitive, non-simple C^* -algebra, and the extremal boundary of the compact convex set of trace states is homeomorphic to the unit interval $[0, 1]$; see [6], [78], or [29, Examples III.5.5 and IV.3.7]. Hence the analysis of the algebras \mathfrak{A}_L will be radically different for general L than in the remaining chapters of the present memoir.

CHAPTER 4

Subalgebras of \mathcal{O}_d

In this chapter we will study the fixed-point subalgebras of \mathcal{O}_d under the one-parameter groups $\sigma = \sigma^{(L)}$ of automorphisms defined by

$$(4.1) \quad \sigma_t^{(L)}(s_j) = e^{itL_j} s_j, \quad j = 1, \dots, d,$$

where we will assume that all the L_j have the same sign and any pair (L_j, L_k) is rationally dependent. By a renormalization of the variable t we may, and will, assume that all the L_k are positive integers and that the greatest common divisor of L_1, \dots, L_d is 1. The group $\sigma_t^{(L)}$ is then periodic with period 2π . If $\alpha = (\alpha_1 \dots \alpha_k)$ is a multi-index with $\alpha_m \in \mathbb{Z}_d$, we define the weight function

$$(4.2) \quad L(\alpha) = \sum_{j=1}^d \#_j(\alpha) L_j = \sum_{m=1}^k L_{\alpha_m}$$

where

$$(4.3) \quad \#_j(\alpha) = \# \{ \alpha_i \mid \alpha_i = j \}$$

and using the standard multi-index notation

$$(4.4) \quad s_\alpha = s_{\alpha_1} s_{\alpha_2} \cdots s_{\alpha_k}$$

we have

$$(4.5) \quad \sigma_t(s_\alpha s_\gamma^*) = e^{it(L(\alpha) - L(\gamma))} s_\alpha s_\gamma^*.$$

Since these elements span \mathcal{O}_d , it follows that the eigenspace $\mathcal{O}_d^\sigma(n)$ in \mathcal{O}_d is the closed linear span of the $s_\alpha s_\gamma^*$ with $L(\alpha) - L(\gamma) = n$. In particular, the fixed-point algebra $\mathfrak{A}_L = \mathcal{O}_d^\sigma = \mathcal{O}_d^\sigma(0)$ is the closure of the linear span of $s_\alpha s_\gamma^*$ with $L(\alpha) = L(\gamma)$.

The first result on \mathfrak{A}_L is that it is an AF-algebra, i.e., it is the closure of the union of an increasing sequence of finite-dimensional subalgebras:

Proposition 4.1. *Let L_1, \dots, L_d be integers and consider the periodic one-parameter group σ of $*$ -automorphisms of \mathcal{O}_d defined by*

$$(4.6) \quad \sigma_t(S_j) = e^{itL_j} S_j.$$

Then the following conditions are equivalent.

- (i) *The fixed-point algebra \mathfrak{A}_L is an AF-algebra.*
- (ii) *All the L_i have the same sign (in particular none are zero).*
- (iii) *There is a $\beta \in \mathbb{R}$ such that \mathcal{O}_d admits a (σ, β) -KMS state.*

Furthermore, if these conditions are not fulfilled, \mathfrak{A}_L contains an isometry which is not unitary.

Proof. (ii) \Leftrightarrow (iii) was established in Proposition 3.1.

(i) \Rightarrow (ii): Assume that (ii) does not hold. Then there exist $i, j \in \{1, \dots, d\}$ with $L_i > 0$, $L_j < 0$. Put

$$(4.7) \quad s = s_i^{-L_j} s_j^{L_i}.$$

Then s is an isometry in \mathfrak{A}_L which is not unitary. Hence \mathfrak{A}_L cannot be an AF-algebra. This also establishes the final remark in Proposition 4.1.

(ii) \Rightarrow (i): We may assume that all L_i are positive. We have noted that $\mathcal{O}_d^\sigma = \mathcal{O}_d^\sigma(0)$ is the closure of the linear span of $s_\alpha s_\gamma^*$ with $L(\alpha) = L(\gamma)$. If $L(\alpha) = L(\gamma)$, we define

$$(4.8) \quad \text{grade}(s_\alpha s_\gamma^*) = L(\alpha),$$

and we set $\text{grade}(\mathbb{1}) = \text{grade}(0) = 0$. Now, if $s_\alpha s_\gamma^*$, $s_\delta s_\varepsilon^*$ are in \mathcal{O}_d^σ then either the product $s_\alpha s_\gamma^* s_\delta s_\varepsilon^*$ is zero, or we have $\gamma = \delta\gamma'$ and the product is $s_\alpha s_{\varepsilon\gamma'}^*$, or we have $\delta = \gamma\delta'$ and the product is $s_{\alpha\delta'} s_\varepsilon^*$. In the latter two cases $\text{grade}(s_\alpha s_\gamma^* s_\delta s_\varepsilon^*) = \max(\text{grade}(s_\alpha s_\gamma^*), \text{grade}(s_\gamma s_\delta^*))$, and, in the former case, $\text{grade}(s_\alpha s_\gamma^* s_\delta s_\varepsilon^*) = 0$. Thus in general,

$$(4.9) \quad \text{grade}(s_\alpha s_\gamma^* s_\varepsilon s_\delta^*) \leq \max(\text{grade}(s_\alpha s_\gamma^*), \text{grade}(s_\varepsilon s_\delta^*)).$$

Thus if we define

$$(4.10) \quad \mathfrak{A}_n = \text{lin span} \{s_\alpha s_\gamma^* \mid L(\alpha) = L(\gamma) \leq n\},$$

then \mathfrak{A}_n is a $*$ -algebra, and \mathfrak{A}_n is finite-dimensional since $L_i > 0$ for $i = 1, \dots, d$. Since any $s_\alpha s_\gamma^* \in \mathcal{O}_d^\sigma$ has a grade, it follows that $\bigcup_n \mathfrak{A}_n$ is dense in $\mathcal{O}_d^\sigma = \mathfrak{A}_L$. Thus \mathfrak{A}_L is an AF-algebra, and Proposition 4.1 is proved. \square

We refer to [6] and Remark 5.6 for AF-algebras and Bratteli diagrams, to [3] for K -theory, and to [80], [29] and [48] for good recent treatments of both. In order to analyze the AF-algebra \mathfrak{A}_L further, it turns out to be convenient to define subalgebras \mathfrak{A}_n in a more sophisticated way than above, and this is the object of the following. Note that, except for simple cases (like $d = 2$), the finite-dimensional subalgebras introduced below are larger than \mathfrak{A}_n . The main structure theorem on \mathfrak{A}_L is the following.

Theorem 4.2. *Let $L_1 \leq L_2 \leq \dots \leq L_d$ be positive integers such that the greatest common divisor of L_1, \dots, L_d is 1. It follows that \mathfrak{A}_L is a simple AF-algebra with a unique trace state defined as follows: Let β be the positive real number such that*

$$(4.11) \quad \sum_{i=1}^d e^{-\beta L_i} = 1,$$

and put

$$(4.12) \quad p_i = e^{-\beta L_i}.$$

Then the unique trace state is the restriction to \mathfrak{A}_L of the state ω defined on \mathcal{O}_d by

$$(4.13) \quad \omega(s_\alpha s_\gamma^*) = \delta_{\alpha\gamma} p^\alpha$$

where

$$(4.14) \quad p^\alpha = p_{\alpha_1} p_{\alpha_2} \cdots p_{\alpha_k}$$

for $\alpha = (\alpha_1 \dots \alpha_k)$.

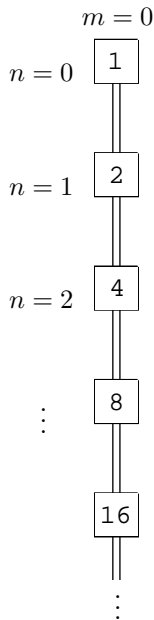

FIGURE 1. $d = 2$; $L_1 = 1$, $L_2 = 1$; $\beta = \ln 2$.

Remark 4.3. During the proof of Theorem 4.2, we will show that the AF-algebra \mathfrak{A}_L has a Bratteli diagram which stabilizes after a finite number of steps to having constant incidence matrices. This diagram may be described explicitly as follows: The nodes are indexed by (n, m) , where n indexes the rows, $n = 0, 1, 2, \dots$, and m indexes the nodes in the row, $m = 0, 1, \dots, L_d - 1$. Some of the nodes in the first rows may correspond to the algebra 0: for example, $(0, m)$, $m = 0, 1, \dots, L_d - 1$, correspond to the algebras $M_1 = \mathbb{C}, 0, 0, 0, \dots, 0$. The embedding from one row to the next is given as follows: There are lines from $(n - 1, 0)$ to (n, m) if and only if $m = L_k - 1$ for some k , and the number of lines between these nodes is equal to the number of such k 's. There is a single line from $(n - 1, m)$ to $(n, m - 1)$ for $m = 1, \dots, L_d - 1$. Finally, to obtain the actual Bratteli diagram, one should throw away all nodes corresponding to the algebra 0 as well as the edges emanating from such nodes. The assumption that the greatest common divisor of L_1, \dots, L_d is 1 will imply that there are just finitely many such nodes. It will be clear from the proof how this pattern appears. We give some examples in the figures below.

We will show that the unique positive eigenvalue of the constant incidence matrix (the Frobenius eigenvalue) is e^β .

Before proving Theorem 4.2 and Remark 4.3, we look at some examples.

Figure 1 is the CAR-algebra of type 2^∞ ; see [47], [6], [32], [19] and [78].

Figure 2 is the AF-algebra with same dimension group as the rotation algebra \mathfrak{A}_θ for $\theta = \frac{\sqrt{5}-1}{2}$ = the golden ratio. Pimsner and Voiculescu [75] embedded \mathfrak{A}_θ into this AF-algebra.

Figure 3 illustrates that the Bratteli diagram is more “slow” in stabilizing when the L_i -numbers are dispersed. Figures 4 and 5 illustrate how the multi-indices build up as the sizes of the matrix algebras increase going down the Bratteli diagram.

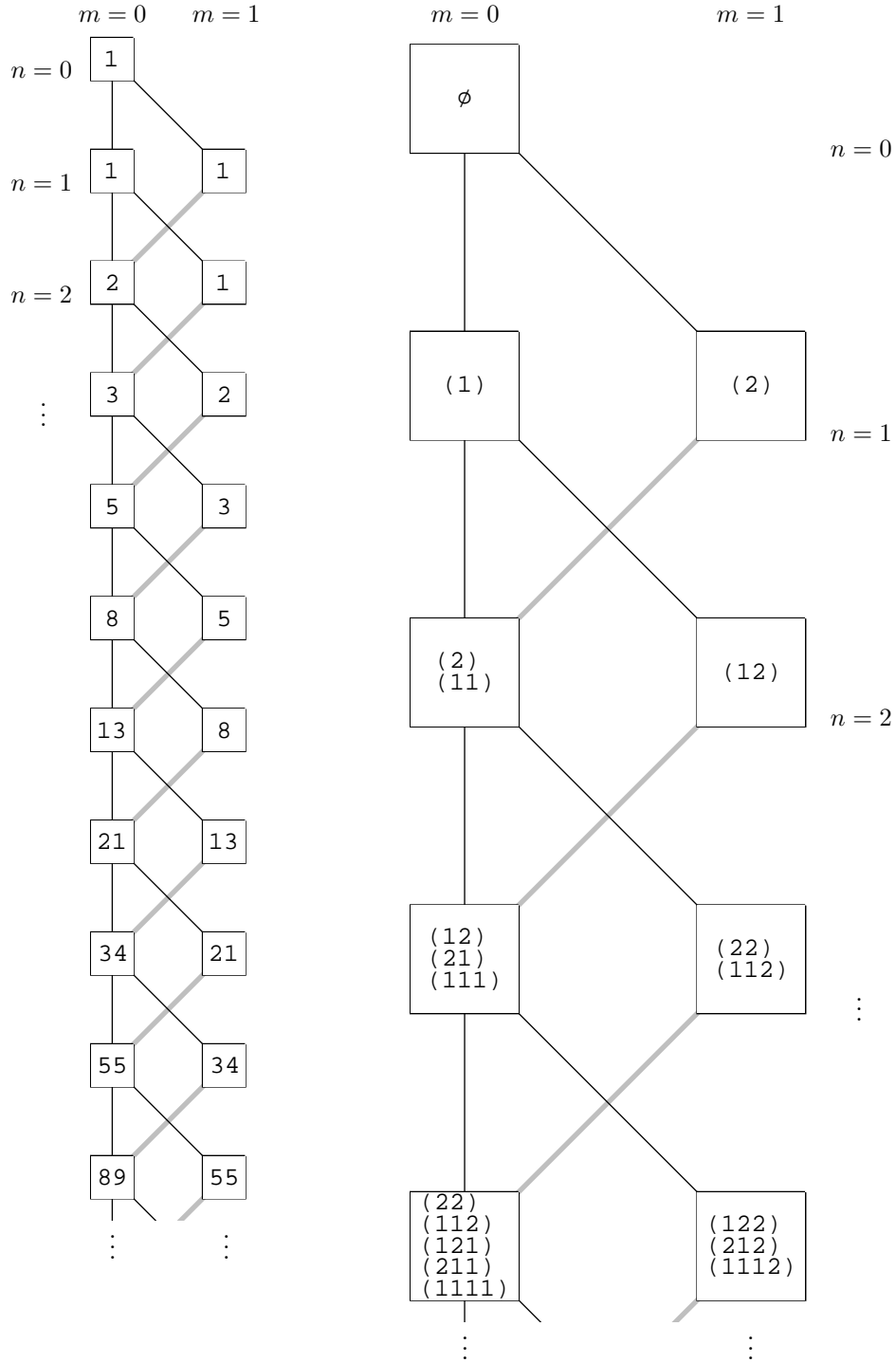

FIGURE 2. $d = 2$; $L_1 = 1$, $L_2 = 2$; $\beta = -\ln((\sqrt{5} - 1)/2)$. Then the Bratteli diagram is given by the Fibonacci sequence. Detail on the right shows the multi-indices for each node in the top five rows.

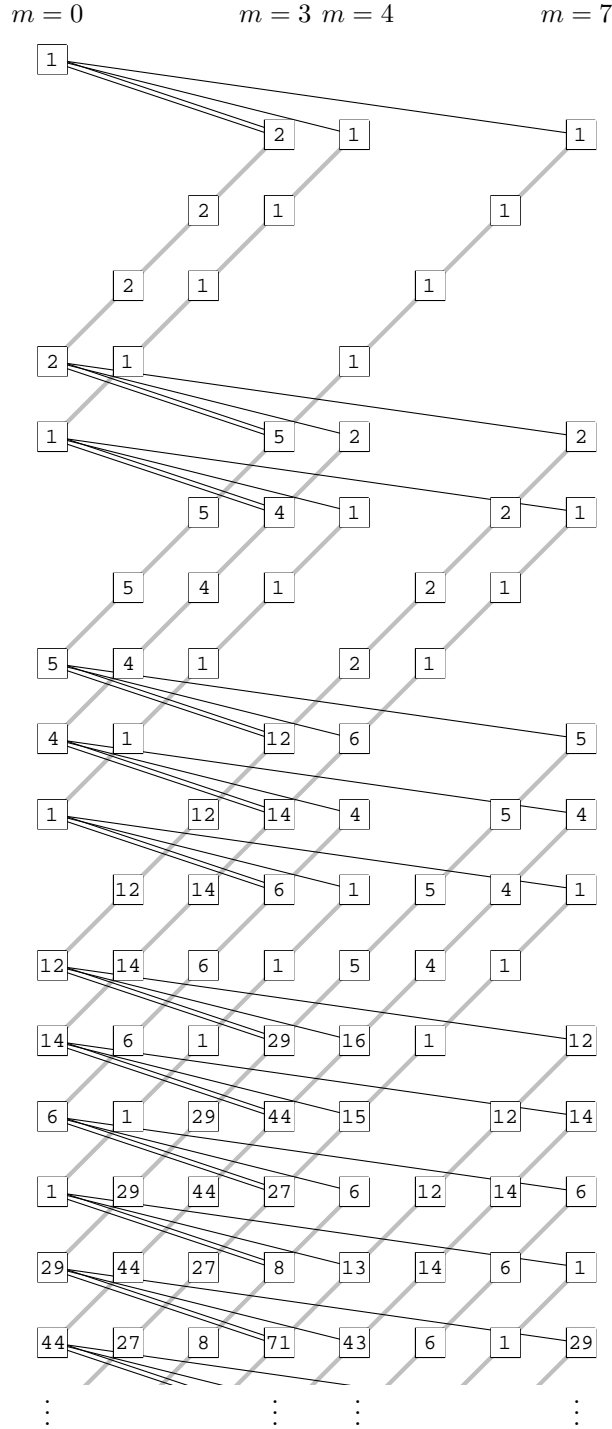

FIGURE 3. $d = 4$; $L = \{4, 4, 5, 8\}$; first matrix column = $(0\ 0\ 0\ 2\ 1\ 0\ 0\ 1)^t$; $\beta = -\ln x$ where $x = (-2 + \sqrt[3]{100 + 12\sqrt{69}} + \sqrt[3]{100 - 12\sqrt{69}})/6 \approx 0.7549$ solves $2x^4 + x^5 + x^8 = 1$. (Actually x solves $x^2 + x^3 = 1$.) See the $n = 5$ case in Example 5.3.

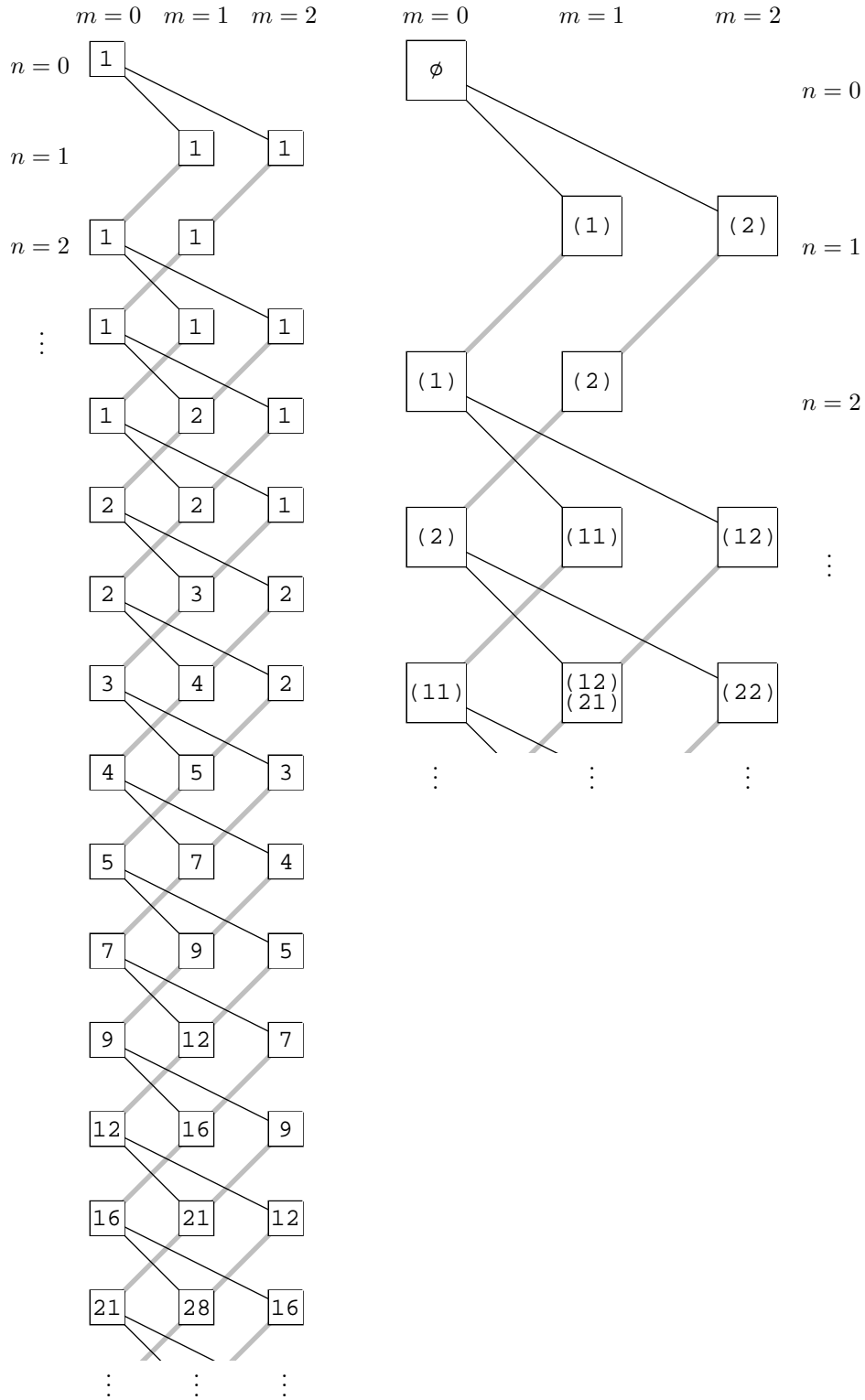

FIGURE 4. $d = 2$; $L = \{2, 3\}$; first matrix column = $(0 \ 1 \ 1)^t$; $\beta = -\ln x$ where $x > 0$ solves $x^2 + x^3 = 1$. Detail on the right shows the multi-indices for each node in the top five rows. See the proof of Lemma 4.6.

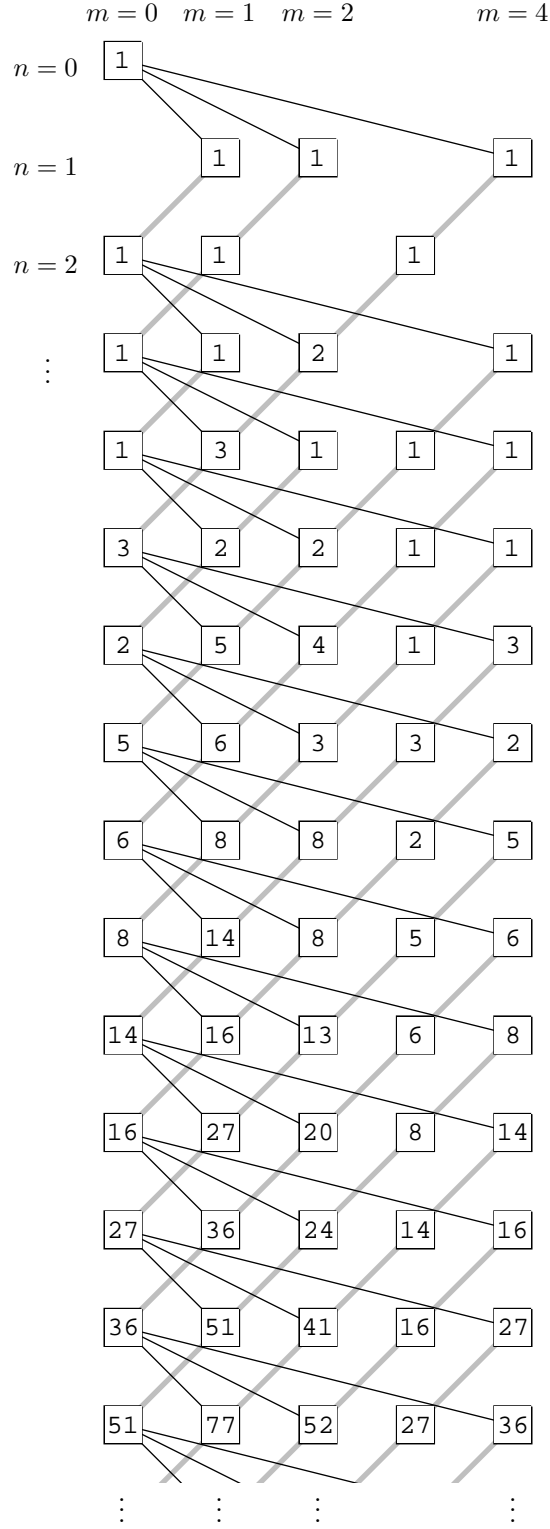

FIGURE 5. $d = 3$; $L = \{2, 3, 5\}$; first matrix column $= (0 \ 1 \ 1 \ 0 \ 1)^t$;
 $\beta = -\ln x$ where $x > 0$ solves $x^2 + x^3 + x^5 = 1$.

The significance of the choices of L_i -numbers will become more clear in Chapter 5 below where we study isomorphism invariants for the AF-algebras \mathfrak{A}_L in general.

Figure 4 represents $(0 \ 1 \ 1)$, the first of two AF-algebras which share Perron–Frobenius eigenvalue $\lambda = e^\beta$ where $a = e^{-\beta} \approx 0.7549$ is the real root of $x^2 + x^3 = 1$. The other one, $(1 \ 0 \ 0 \ 1)$, is obtained from $x + x^5 = 1$, which has the same positive root a . (See Remark 4.10 and Chapter 5 for more details on the Perron–Frobenius eigenvalue.) Yet these two AF-algebras are non-isomorphic, since their dimension groups have rank 3 and 5, respectively. (See Theorem 7.8.) They correspond to the pair of lattice points $(2, 3)$, $(1, 5)$ that is illustrated in Figure 18.

Figure 6 illustrates the procedure in the proof of Lemma 4.6, below.

Let τ be the additive real character defined on the dimension group $K_0(\mathfrak{A}_L)$ by the trace state, [32]. Figure 12 represents two examples with the same $\ker(\tau)$ ($\cong \mathbb{Z}^3$), the same $\tau(K_0)$ ($\cong \mathbb{Z}[\frac{1}{2}]$) but still non-isomorphic AF-algebras, as they represent different elements of $\text{Ext}(\mathbb{Z}[\frac{1}{2}], \mathbb{Z}^3)$. (Details in Chapter 10.)

We will prove Theorem 4.2 and Remark 4.3 via a series of lemmas. First a definition:

Definition 4.4. A set $\{e_{\alpha\gamma}\}_{\alpha, \gamma \in I}$ of elements of a C^* -algebra \mathfrak{A} , doubly indexed by a finite set I , is said to be a *system of matrix units* if

- (i) $e_{\alpha\gamma}e_{\xi\eta} = \delta_{\gamma\xi}e_{\alpha\eta}$,
- (ii) $e_{\gamma\alpha}^* = e_{\alpha\gamma}$.

In that case, matrices $(A_{\alpha\gamma})_{\alpha, \gamma \in I}$ over \mathbb{C} may be represented in \mathfrak{A} as follows: $(A_{\alpha\gamma}) \mapsto \sum_{\alpha} \sum_{\gamma} A_{\alpha\gamma} e_{\alpha\gamma}$. Note that we do *not* assume that the projection $\sum_{\alpha} e_{\alpha\alpha}$ is the identity of \mathfrak{A} .

Lemma 4.5. Let L_1, L_2, \dots, L_d be positive integers and let $\sigma = \sigma^L$ be the associated automorphism group (4.5). Let $\mathcal{B}_I = \{s_{\alpha} s_{\gamma}^*\}_{\alpha, \gamma \in I}$ be a finite set of elements of $\mathfrak{A}_L = \mathcal{O}_d^{\sigma}$. The doubly indexed set \mathcal{B}_I is then a set of matrix units if and only if there is an $n \in \mathbb{N}$ such that $L(\alpha) = n$ for all $\alpha \in I$.

Proof. Consider arbitrary multi-indices α, γ, ξ , and η built from \mathbb{Z}_d . The product

$$(4.15) \quad (s_{\alpha} s_{\gamma}^*) (s_{\xi} s_{\eta}^*)$$

is nonzero only if either γ is of the form $\gamma = (\xi\gamma')$, or ξ is of the form $\xi = (\gamma\xi')$. If each of the factors in (4.15) is in \mathcal{O}_d^{σ} , then $L(\alpha) = L(\gamma)$ and $L(\xi) = L(\eta)$. Recall that the grade of the first factor is $L(\alpha)$, and that of the second is $L(\xi)$. If the two factors have different grades, and if the product is nonzero, then $\gamma' \neq \emptyset$ or $\xi' \neq \emptyset$. In the first case, the product is $s_{\alpha} s_{(\eta\gamma')}^*$, and in the second it is $s_{(\alpha\xi')} s_{\eta}^*$. In either case, if $\gamma' \neq \emptyset$ or $\xi' \neq \emptyset$, the product of the two elements from \mathcal{B}_I will be nonzero with $\gamma \neq \xi$, see (4.15), so \mathcal{B} will not then be a set of matrix units, i.e., condition (i) of Definition 4.4 will not hold. This proves the “only if” part of Lemma 4.5.

Conversely, if there exists an n such that $L(\alpha) = n$ for all $\alpha \in I$, then the case $\gamma = (\xi\gamma')$ with $\gamma' \neq \emptyset$ is excluded since $L(\xi\gamma') = L(\xi) + L(\gamma')$. For if $L(\gamma) = L(\xi) = n$, then $L(\gamma') = 0$, and $\gamma' = \emptyset$. The same argument also excludes $\xi = (\gamma\xi')$ with $\xi' \neq \emptyset$. It follows that condition (i) of Definition 4.4 will be satisfied for $e_{\alpha\gamma} = s_{\alpha} s_{\gamma}^*$ with I as an index set. \square

Lemma 4.6. Let $d \in \mathbb{N}$ and let L_1, \dots, L_d be positive integers. Define $L(\alpha) = \sum_j \#_j(\alpha) L_j$ on all finite multi-indices α from \mathbb{Z}_d as in (4.2). Define

$$(4.16) \quad L^{-1}(n) = \{\alpha \mid L(\alpha) = n\}$$

and put

$$(4.17) \quad E_n = \{\gamma \mid \gamma = (\alpha i) \text{ where } L(\alpha) < n \text{ and } L(\alpha) + L_i > n\}.$$

Then

$$(4.18) \quad \sum_{\alpha \in L^{-1}(n)} s_\alpha s_\alpha^* + \sum_{\gamma \in E_n} s_\gamma s_\gamma^* = 1,$$

i.e., the projections in the family $\{s_\alpha s_\alpha^* \mid \alpha \in L^{-1}(n)\} \cup \{s_\gamma s_\gamma^* \mid \gamma \in E_n\}$ are mutually orthogonal with sum 1.

Proof. Let us use the shorthand notation

$$(\alpha) = e_{\alpha\alpha} \quad (= s_\alpha s_\alpha^*).$$

It follows from the computations in the proof of Lemma 4.5 that, given two projections (α) , (γ) , then (α) , (γ) are either mutually orthogonal, or one is contained in the other; and the latter case occurs in, and only in, the following two cases:

Case 1. $\alpha = \gamma\alpha'$. Then $(\alpha) \leq (\gamma)$. Or,

Case 2. $\gamma = \alpha\gamma'$. Then $(\gamma) \leq (\alpha)$ (with strict inequalities if and only if $\alpha' \neq \emptyset$, $\gamma' \neq \emptyset$, respectively).

Using this, it follows easily from case-by-case considerations that the projections in the family

$$A_n := \{(\alpha) \mid \alpha \in L^{-1}(n) \cup E_n\}$$

are mutually orthogonal. For example, the projections (α) , $\alpha \in L^{-1}(n)$ are mutually orthogonal by Lemma 4.5, and if $\alpha \in L^{-1}(n)$ and $\gamma = (\delta i) \in E_n$ with $L(\delta) < n$, $L(\delta) + i > n$, then both Case 1 and 2 are excluded, so $(\alpha)(\gamma) = 0$; and similarly, if $\alpha = (\varepsilon j)$ and $\gamma = (\delta i)$ are in E_n , then $(\alpha)(\gamma) \neq 0$ implies $\alpha = \gamma$. It remains to show that the projections in these two families add up to 1. If not, there would exist a multi-index (δ) such that (δ) is orthogonal to all projections in the two families. If then $L(\delta) < n$, we could find a δ' such that $\delta\delta' \in L^{-1}(n)$ or $\delta\delta' \in E_n$, but since $(\delta)(\delta\delta') = (\delta\delta') \neq 0$, this is impossible. If $L(\delta) = n$, then $\delta \in L^{-1}(n)$, which is impossible. If $L(\delta) > n$, write $\delta = (\delta_1\delta_2 \dots \delta_k)$. If there exists an $m < k$ such that $\sum_{i=1}^m L_{\delta_i} = n$, then $(\delta) \leq ((\delta_1 \dots \delta_m))$, which is impossible; and, if not, there is an m with $\sum_{i=1}^m L_{\delta_i} < n$ and $\sum_{i=1}^{m+1} L_{\delta_i} > n$. But then $(\delta_1 \dots \delta_{m+1}) \in E_n$, and $(\delta) \leq ((\delta_1 \dots \delta_{m+1}))$, so this is equally impossible. Thus the projections in the two families add up to 1, and Lemma 4.6 is proved. \square

Example 4.7. The procedure in the proof of Lemma 4.6 may be illustrated graphically as follows: Let $\alpha = (\alpha_1 \dots \alpha_p) \in L^{-1}(n)$, and set

$$E_n(\alpha) = \{\gamma \mid \exists q < p \text{ such that } \gamma = (\alpha_1 \dots \alpha_q \gamma_{q+1}) \text{ and } L(\gamma) > n\}.$$

For the example $d = 3$, $L_1 = 1$, $L_2 = 2$, $L_3 = 4$, we have

$$\begin{aligned} E_4((1111)) &= \{(1112), (1113), (113), (13)\}; \\ E_4((121)) \setminus E_4((1111)) &= \{(122), (123)\}; \\ E_4((22)) &\quad \text{contains a new element } (23); \\ E_4((211)) &\quad \text{contains the rest, i.e., } (212), (213). \end{aligned}$$

This is illustrated in Figure 6. Elements from $L^{-1}(4)$ have arrows coming from the left ending at dark bars, while elements from E_4 have arrows coming from the

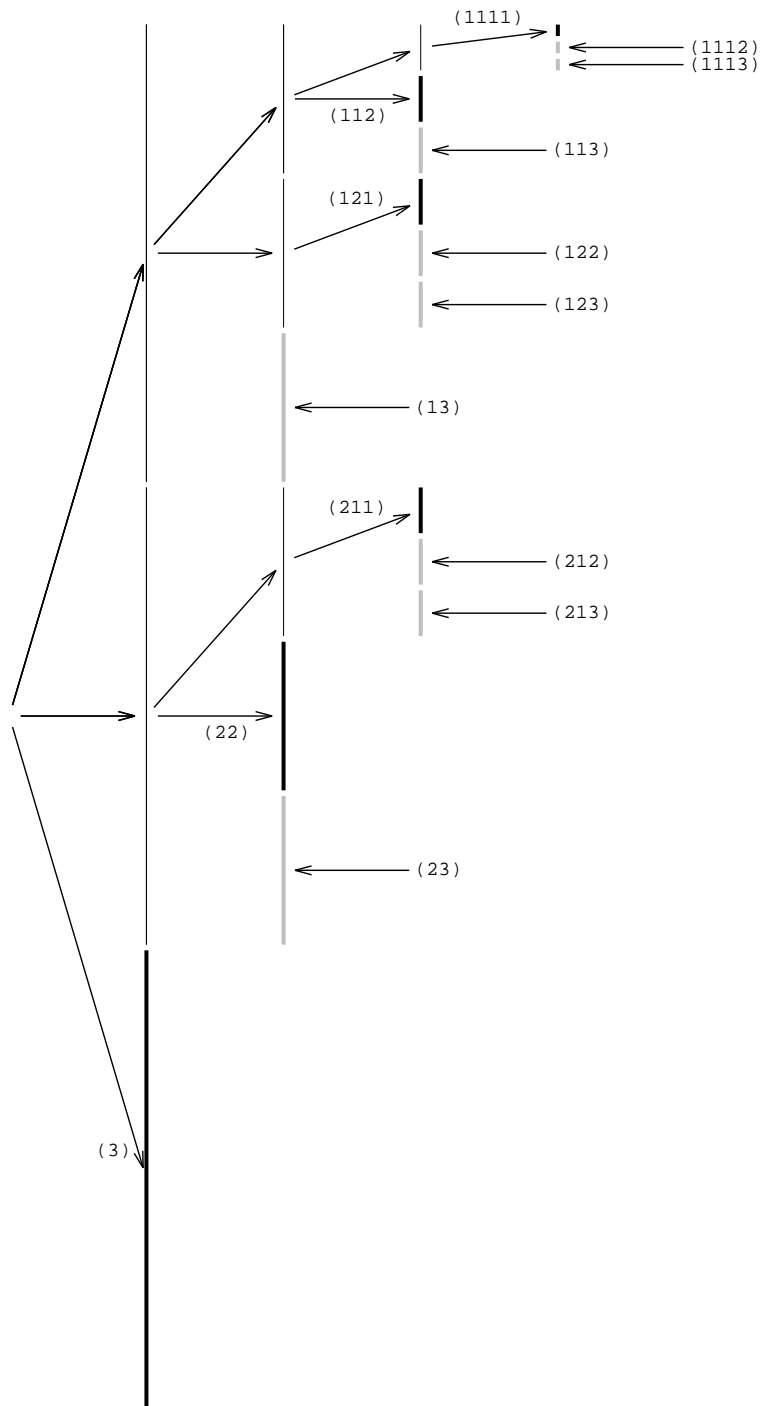

FIGURE 6. Illustration of procedure in proof of Lemma 4.6, with $d = 3$, $L = \{1, 2, 4\}$. Compare with Figure 7 and Example 4.7.

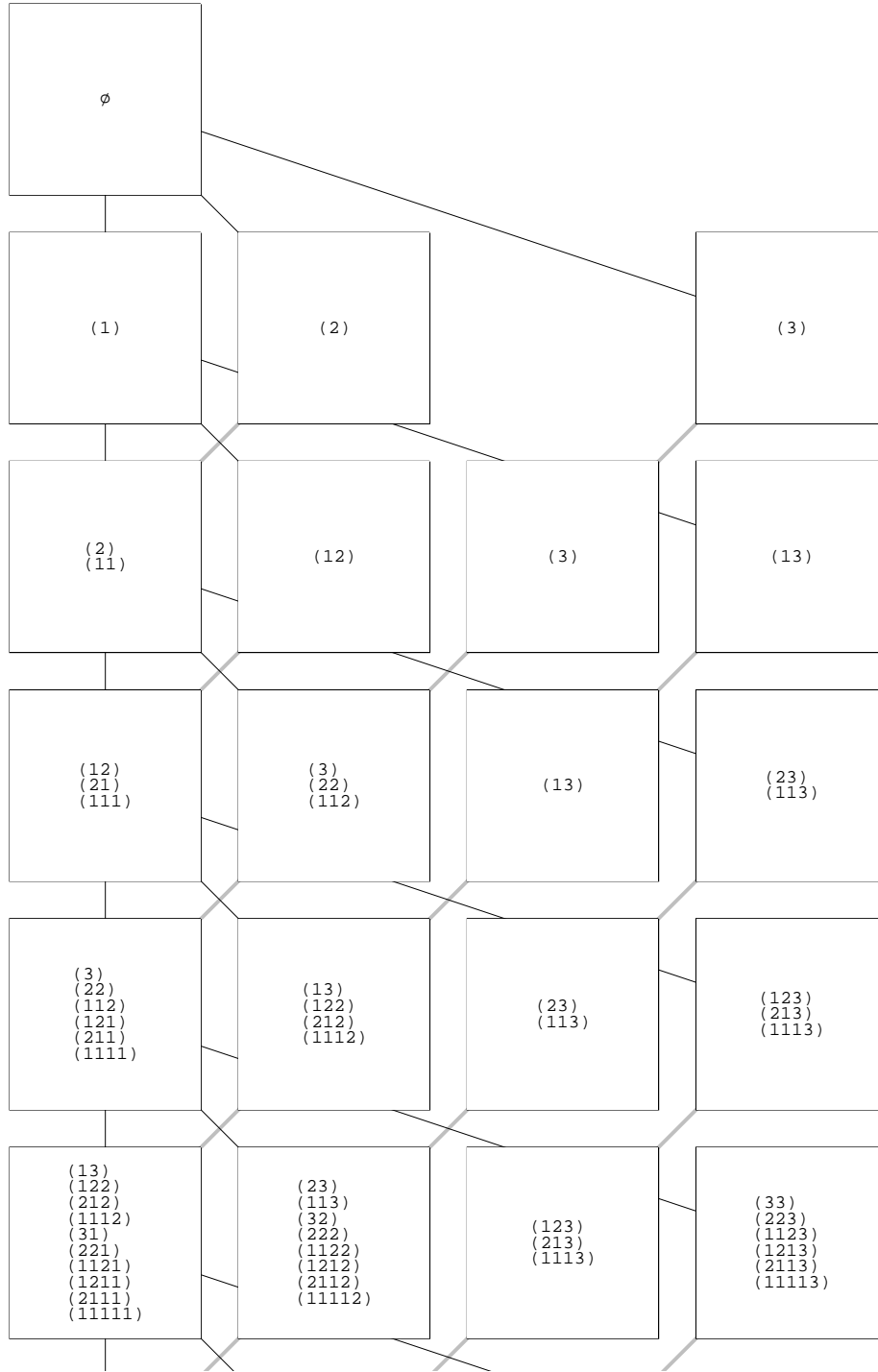

FIGURE 7. $d = 3$; $L = \{1, 2, 4\}$; first matrix column = $(1 \ 1 \ 0 \ 1)^t$. Compare with Figure 6 and Example 4.7.

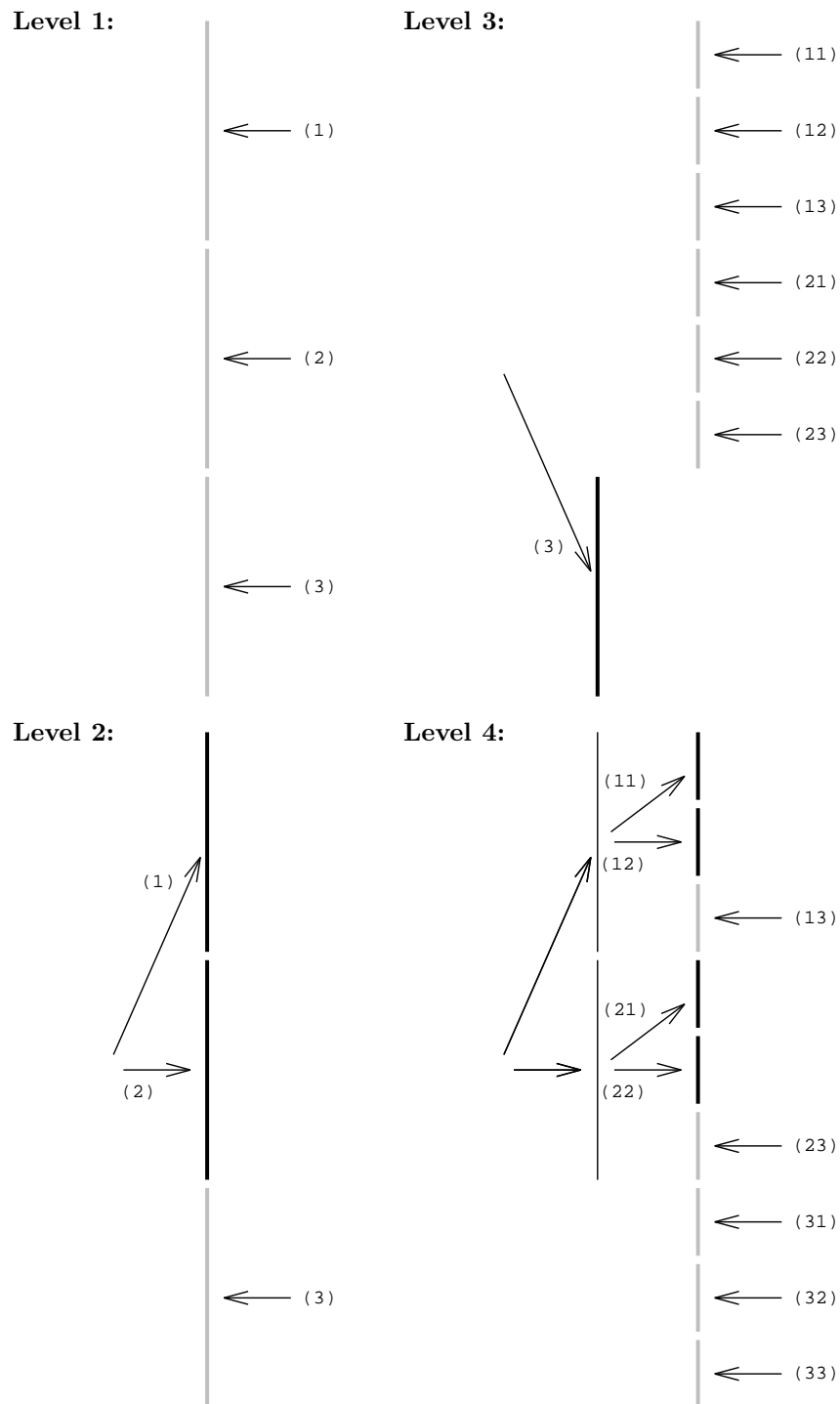
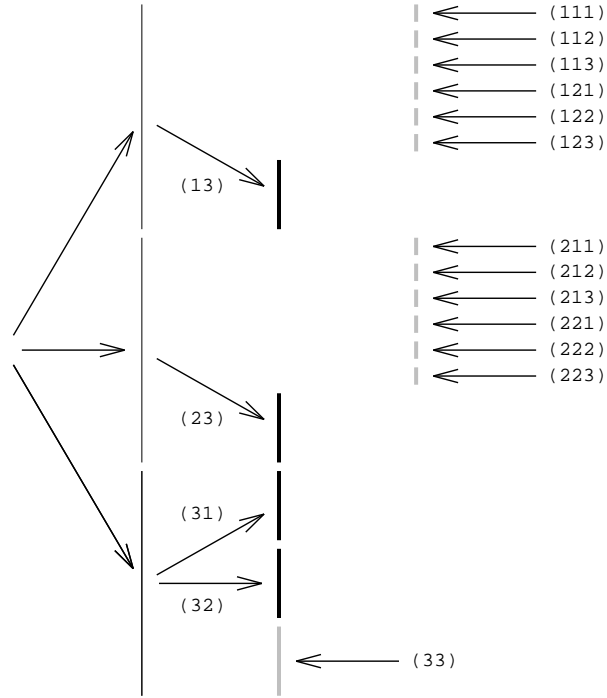
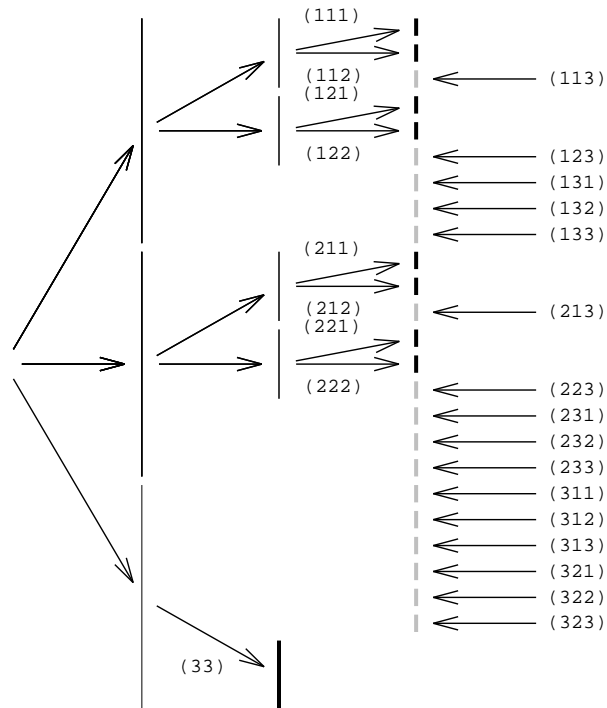

FIGURE 8. $L = \{2, 2, 3\}$; levels 1-4. Compare Figures 8, 9, and 10 with Figure 11.

Level 5:**Level 6:**FIGURE 9. $L = \{2, 2, 3\}$; levels 5–6.

Level 7:

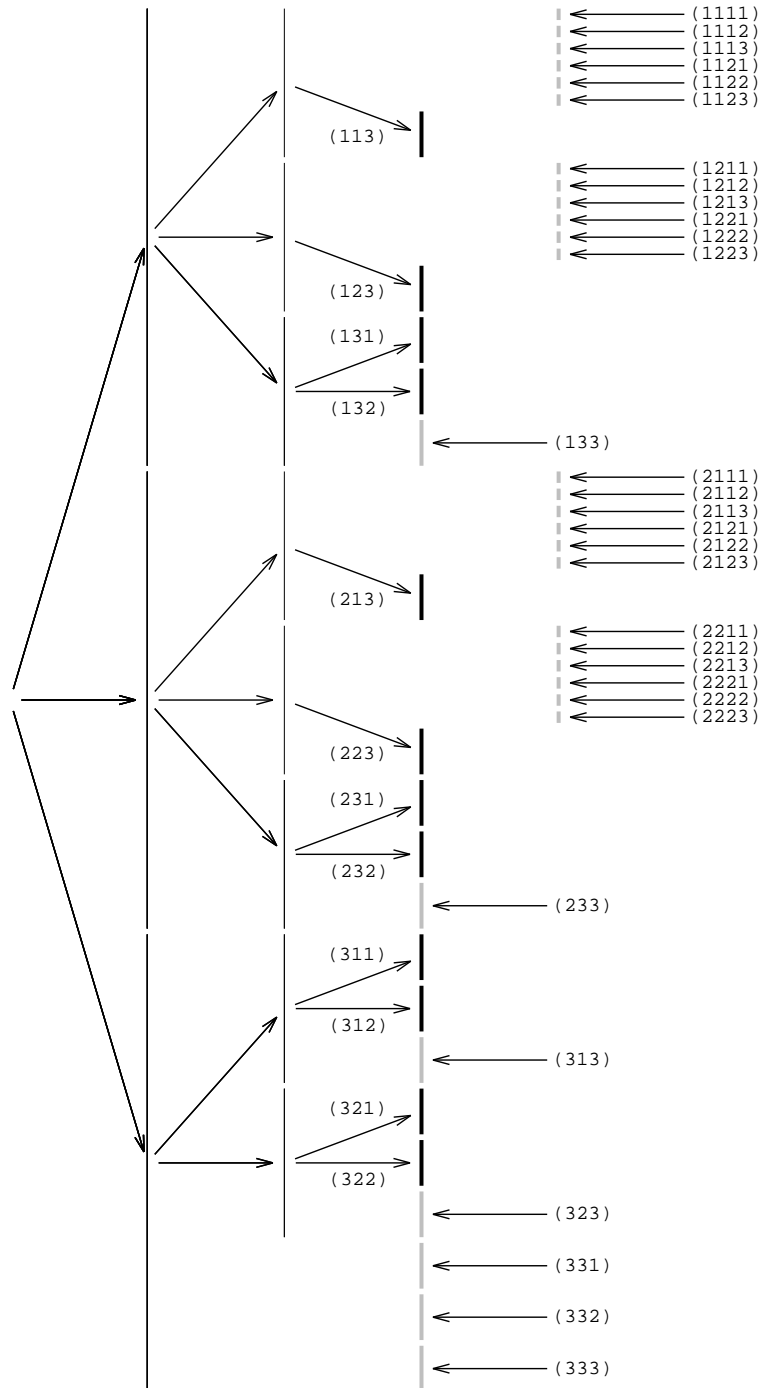

FIGURE 10. $L = \{2, 2, 3\}$; level 7.

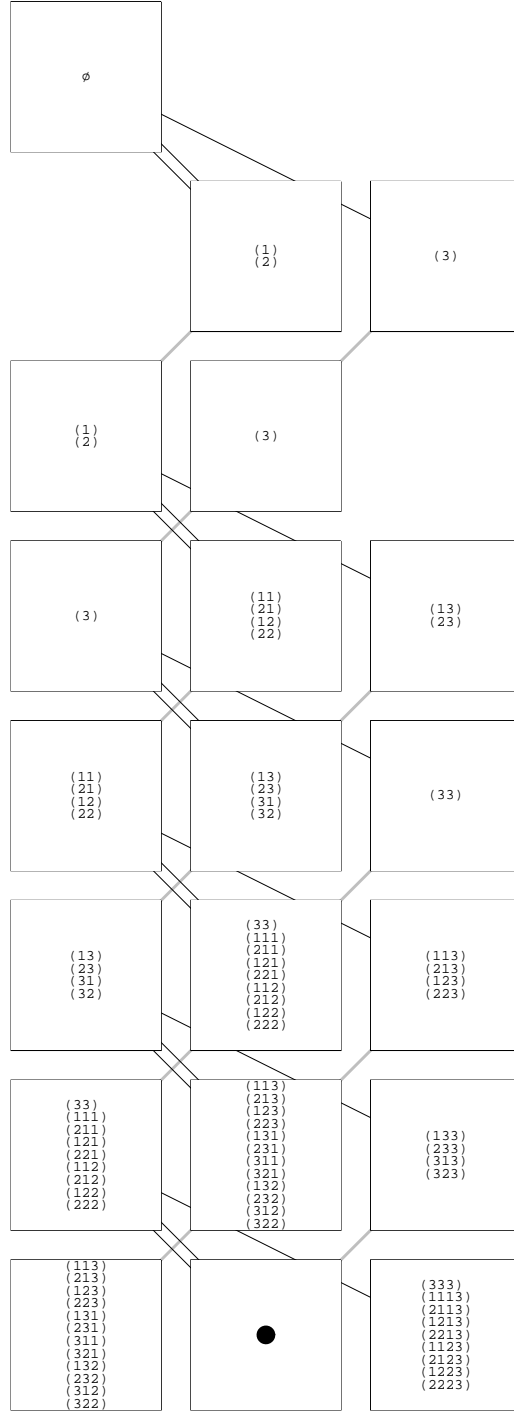

FIGURE 11. $d = 3$; $L = \{2, 2, 3\}$; first matrix column = $(0 \ 2 \ 1)^t$. Compare with Figures 8, 9, and 10.

right ending at light bars. The points in $L^{-1}(4) \cup E_4$ together represent Cuntz algebra generators. The ordinary diagram for this \mathfrak{A}_L is illustrated in Figure 7. Corresponding diagrams for $L_1 = L_2 = 2$, $L_3 = 3$ are shown in Figures 8, 9, 10, and 11.

Proof of Theorem 4.2 and Remark 4.3. Referring to Lemma 4.6, define

$$(4.19) \quad E_n(0) = L^{-1}(n)$$

and

$$(4.20) \quad E_n(m) = \{\gamma \in E_n \mid L(\gamma) = n + m\}$$

for $m = 1, 2, \dots, L_d - 1$; for greater m 's, $E_n(m)$ becomes the empty set. $E_n(m)$ may also be the empty set for some $m \in \{0, \dots, L_d - 1\}$, but we will prove in a moment that if the greatest common divisor of L_1, \dots, L_d is 1, this only happens for finitely many pairs (n, m) . Now, define $\mathfrak{A}^{(n,m)}$ as the linear span of elements $e_{\alpha\gamma} = s_\alpha s_\gamma^*$ with $\alpha, \gamma \in E_n(m)$, $m = 0, \dots, L_d - 1$, with the convention that $\mathfrak{A}^{(n,m)}$ is empty if $E_n(m) = \emptyset$ and $\mathfrak{A}^{(0,0)} = \mathbb{C}\mathbb{1}$, $\mathfrak{A}^{(0,m)} = 0$ for $m = 1, \dots, L_d - 1$. It follows from Lemma 4.5 that each $\mathfrak{A}^{(n,m)}$ is a full $\#(E_n(m)) \times \#(E_n(m))$ matrix algebra, and that the units of $\mathfrak{A}^{(n,m)}$ are orthogonal and add up to $\mathbb{1}$ as m runs over $0, 1, \dots, L_d - 1$ for fixed n . Put

$$(4.21) \quad \mathfrak{A}_n = \bigoplus_{k=0}^{L_d-1} \mathfrak{A}^{(n,k)}.$$

If $L(\gamma) = n$, then

$$(4.22) \quad (\gamma) = \sum_{i=1}^d (\gamma^i)$$

and

$$(4.23) \quad \gamma^i \in E_{n+1}(L_i - 1), \quad i = 1, \dots, d;$$

and hence $\mathfrak{A}^{(n,0)}$ is partially embedded in $\mathfrak{A}^{(n+1,m)}$ with multiplicity equal to the number of k 's such that $L_k - 1 = m$. We also have

$$(4.24) \quad E_{n+1}(m) \subseteq E_n(m+1)$$

for $m = 0, 1, \dots, L_k - 2$, and thus $\mathfrak{A}^{(n,m+1)}$ is embedded into $\mathfrak{A}^{(n+1,m)}$ with multiplicity 1 for $m = 0, 1, \dots, L_k - 2$. It follows that \mathfrak{A}_n is indeed an increasing sequence of finite-dimensional subalgebras, and in particular \mathfrak{A}_n contains all monomials $s_\alpha s_\gamma^* \in \mathfrak{A}_L$ of grade $\leq n$. Thus $\bigcup_n \mathfrak{A}_n$ is dense in \mathfrak{A}_L , reestablishing that \mathfrak{A}_L is an AF-algebra, and the description of the embedding $\mathfrak{A}_n \hookrightarrow \mathfrak{A}_{n+1}$ proves Remark 4.3. The remaining statements in Theorem 4.2 will be proved after Lemma 4.8, below.

By Proposition 3.1, the state defined on \mathcal{O}_d by (4.13) is a (σ, β) -KMS state. Thus the restriction to $\mathfrak{A}_L = \mathcal{O}_d^\sigma$ is a trace state. Now the embeddings $\mathfrak{A}_n \hookrightarrow \mathfrak{A}_{n+1}$ are given by a constant embedding matrix J : if, for example, $d = 4$, $L_1 = 1$, $L_2 = L_3 = 3$, $L_4 = 4$, then

$$J = \begin{pmatrix} 1 & 1 & 0 & 0 \\ 0 & 0 & 1 & 0 \\ 2 & 0 & 0 & 1 \\ 1 & 0 & 0 & 0 \end{pmatrix}.$$

In general J has the property that J^n has strictly positive matrix elements for some positive n . This is in fact equivalent to the property that the numbers L_1, \dots, L_d have greatest common divisor 1, which may be seen as follows:

Lemma 4.8. *Let \mathcal{P} be the semigroup generated by L_1, \dots, L_d :*

$$(4.25) \quad \mathcal{P} = \left\{ \sum_{k=1}^d n_k L_k \mid n_k \in \mathbb{N} \cup \{0\} \right\}.$$

Then $\mathbb{N} \setminus \mathcal{P}$ is finite.

Proof. Since L_1, \dots, L_d have greatest common divisor 1, there are $n_k \in \mathbb{Z}$ such that

$$\sum_{k=1}^d n_k L_k = 1,$$

and hence there are $x_1, x_2 \in \mathcal{P}$ such that

$$x_1 = x_2 + 1.$$

Now, if *ad absurdum* $\mathbb{N} \setminus \mathcal{P}$ is infinite we may find arbitrarily large $y \in \mathbb{N} \setminus \mathcal{P}$, but then $y - x_1, y - x_2$ are not contained in \mathcal{P} ; thus $y - x_1 - x_1, y - x_1 - x_2, y - x_2 - x_2$ are not in \mathcal{P} , etc., and thus we can find arbitrarily long sequences of the form $(z, z + 1, z + 2, \dots, z + k)$ not in \mathcal{P} . But as \mathcal{P} contains $\mathbb{N}L_1$, this is impossible. Thus $\mathbb{N} \setminus \mathcal{P}$ is finite. \square

End of proof of Theorem 4.2. Since any node in the Bratteli diagram is connected to a node of the form $(n, 0)$ further down, and $(n, 0)$ is connected to all nodes $(n + m, 0)$ where $m \in \mathcal{P}$, it follows that all nodes in a row will be connected to all nodes in some row further down, which means that J^n has strictly positive matrix elements for some $n \in \mathbb{N}$. Therefore \mathfrak{A}_L is simple [6], and \mathfrak{A} has a unique trace state [32, Theorem 6.1], [87]. This ends the proof of Theorem 4.2. \square

Remark 4.9. The semigroup \mathcal{P} defined by (4.25) can be read off the diagram of \mathfrak{A}_L as follows: $n \in \mathcal{P}$ if and only if the node $(n, 0)$ actually occurs in the diagram, i.e., if and only if $L^{-1}(n) \neq \emptyset$. To decide which (n, m) actually occurs, start with the vector $(0, 0) = 1, (0, m) = 0, m = 1, \dots, L_d - 1$, and apply the incidence matrix J . For example, in the example illustrated in Figure 3, with $L = \{4, 4, 5, 8\}$, we have $\mathcal{P} = \{4, 5, 8, 9, 10, 12, 13, 14, \dots\}$, while in the right-hand example in Figure 14, we have $\mathcal{P} = \{3, 6, 7, 9, 10, 12, 13, 14, \dots\}$ (both \mathcal{P} 's continuing with no further gaps in the sequence).

Remark 4.10. The result on the unique trace state cited at the end of the proof above is actually related to the classical Perron–Frobenius theorem [46, 74, 44]. If $v^{(n)}$ is the value of the trace state on the minimal projections in $\mathfrak{A}_m^{(n)} = \mathfrak{A}^{(n, m)}$, and $v^{(n)} = \left(v_0^{(n)}, \dots, v_{L_d-1}^{(n)} \right)$, then

$$(4.26) \quad v^{(n-1)} = v^{(n)} J,$$

provided n is so large that the Bratteli diagram has stabilized, i.e., $\mathfrak{A}_m^{(n)} \neq \{0\}$ for $m = 0, 1, \dots, L_d - 1$. Since the components of $v^{(n)}$ have to be nonnegative, the

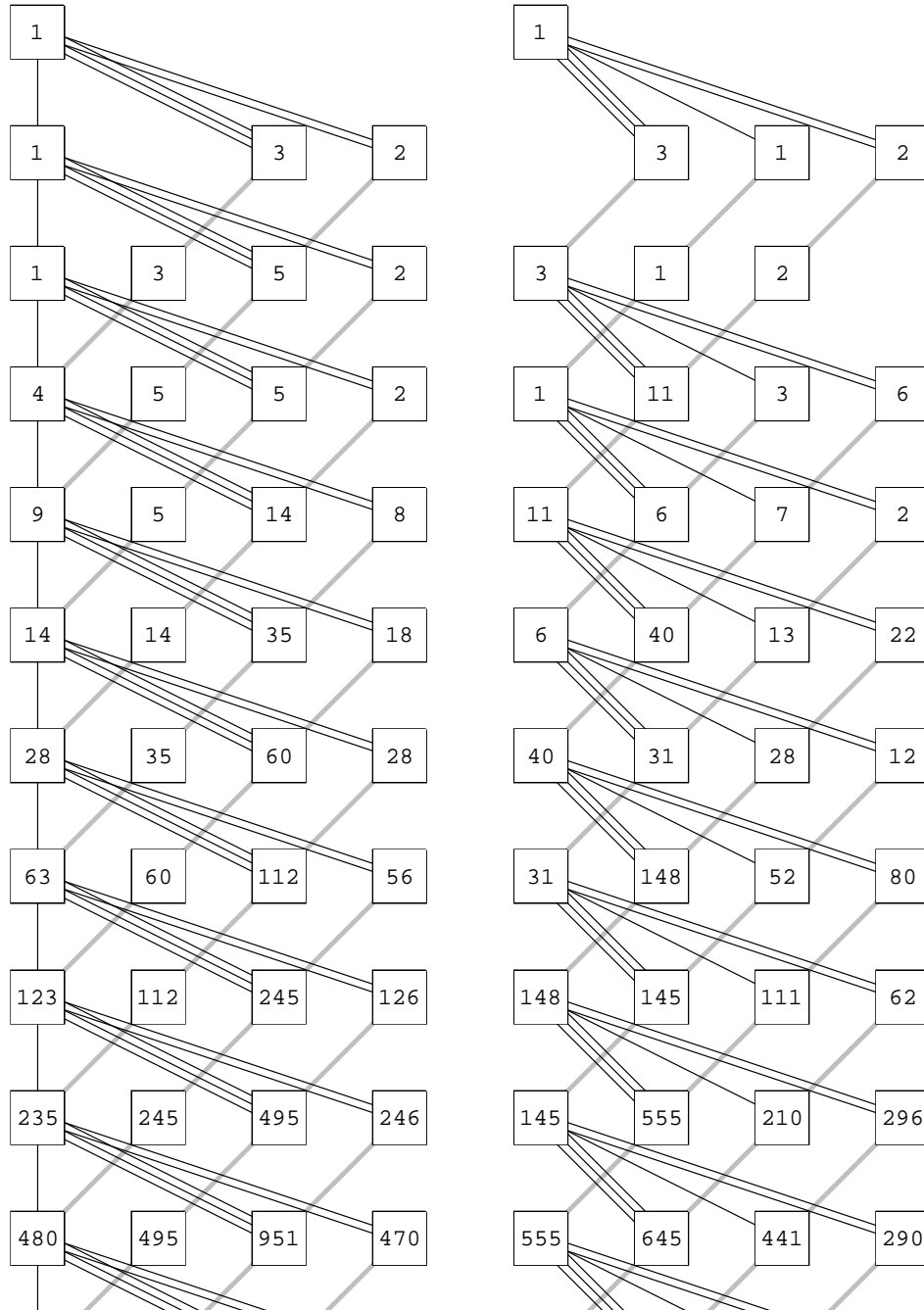

FIGURE 12. $d = 6$; $L = \{1, 3, 3, 3, 4, 4\}$ (left), $L = \{2, 2, 2, 3, 4, 4\}$ (right). These define non-isomorphic algebras (see Chapter 16).

$$J = \begin{pmatrix} m_1 & 1 & 0 & 0 & 0 & 0 & \cdots & 0 & 0 & 0 \\ 0 & 0 & 1 & 0 & 0 & 0 & \cdots & 0 & 0 & 0 \\ 0 & 0 & 0 & 1 & 0 & 0 & \cdots & 0 & 0 & 0 \\ m_2 & 0 & 0 & 0 & 1 & 0 & \cdots & 0 & 0 & 0 \\ 0 & 0 & 0 & 0 & 0 & 1 & \cdots & 0 & 0 & 0 \\ 0 & 0 & 0 & 0 & 0 & 0 & \ddots & 0 & 0 & 0 \\ \vdots & \vdots & \vdots & \vdots & \vdots & & \ddots & \ddots & \vdots & \vdots \\ 0 & 0 & 0 & 0 & 0 & 0 & & 0 & 1 & 0 \\ 0 & 0 & 0 & 0 & 0 & 0 & \cdots & 0 & 0 & 1 \\ m_k & 0 & 0 & 0 & 0 & 0 & \cdots & 0 & 0 & 0 \end{pmatrix} \begin{array}{l} \leftarrow \text{place } M_1 \\ \\ \\ \leftarrow \text{place } M_2 \\ \\ \\ \\ \\ \\ \\ \leftarrow \text{place } M_k \end{array}$$

FIGURE 13. Incidence matrix.

only solutions of (4.26) are such that each $v^{(n)}$ (for large n) is a multiple of the Perron–Frobenius eigenvector v of J , i.e.,

$$(4.27) \quad vJ = \lambda_0 v.$$

Recall that the irreducibility of J (some power of J has only positive matrix units) implies that J has a simple positive eigenvalue λ_0 such that $\lambda_0 > |\mu|$ for all other eigenvalues μ , and the corresponding one-dimensional eigenspace is spanned by a vector v with positive components. All $v^{(n)}$'s for large n are multiples of v . (This is because of the uniqueness of the normalized positive solution of (4.27), together with the fact that $v^{(n)} = \text{const.} \cdot e^{-\beta n} v$ is indeed a solution. Note that the Perron–Frobenius eigenvalue of J is e^β .) Thus v may be computed explicitly in the examples by choosing n so large that the diagram has stabilized, and using (4.13) and (4.20) to evaluate the trace on the minimal projections in $\mathfrak{A}_m^{(n)}$. The result is surprisingly simple; see (5.17) in the next chapter.

Let us give the details of the graphic description of the embedding of \mathfrak{A}_n into \mathfrak{A}_{n+1} . Suppose that the integral weights of Theorem 4.2 are $1 \leq L_1 \leq L_2 \leq \cdots \leq L_d$ with possible multiple occupancy. Let

$$(4.28) \quad \begin{array}{ll} L_i = M_1 & \text{for } 1 \leq i \leq i_1, \\ L_i = M_2 & \text{for } i_1 < i \leq i_2, \\ \vdots & \vdots \\ L_i = M_k & \text{for } i_{k-1} < i \leq i_k = d. \end{array}$$

Let $m_j = i_j - i_{j-1}$ be the multiplicities. Then, after stabilization, the partial embedding of $\mathfrak{A}_0^{(n-1)}$ into the factors $\mathfrak{A}_m^{(n)}$, $m = 0, \dots, L_d - 1$, are given by the

diagram in (4.29) below (illustrated in the case $L_1 = 1$):

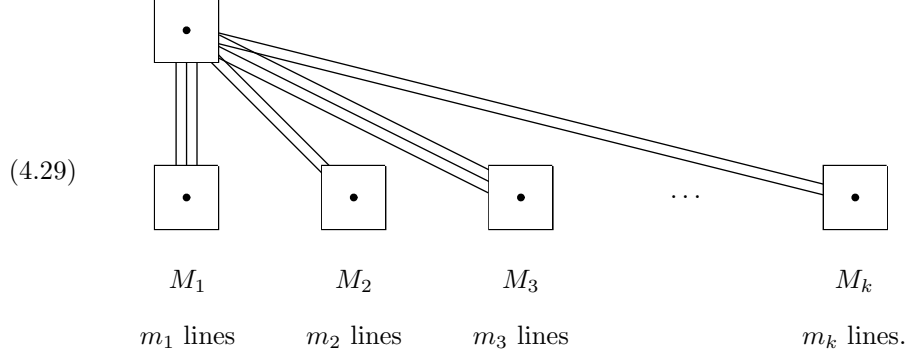

Then J^{-1} is given by the matrix

(4.30)

$$J^{-1} = \begin{pmatrix} 0 & 0 & 0 & 0 & 0 & \cdots & \cdots & 0 & 0 & \frac{1}{m_k} \\ 1 & 0 & 0 & 0 & 0 & \cdots & \cdots & 0 & 0 & -\frac{m_1}{m_k} \\ 0 & 1 & 0 & 0 & 0 & \cdots & \cdots & 0 & 0 & 0 \\ 0 & 0 & 1 & 0 & 0 & \cdots & \cdots & 0 & 0 & 0 \\ 0 & 0 & 0 & 1 & 0 & \cdots & \cdots & 0 & 0 & -\frac{m_2}{m_k} \\ \vdots & \vdots & \vdots & \vdots & \ddots & \ddots & & & & \vdots \\ \vdots & \vdots & \vdots & \vdots & & \ddots & \ddots & & & \vdots \\ \vdots & \vdots & \vdots & \vdots & & & \ddots & \ddots & & -\frac{m_j}{m_k} \\ \vdots & \vdots & \vdots & \vdots & & & & \ddots & \ddots & \vdots \\ 0 & 0 & 0 & 0 & 0 & \cdots & \cdots & 1 & 0 & 0 \\ 0 & 0 & 0 & 0 & 0 & \cdots & \cdots & 0 & 1 & 0 \end{pmatrix} \leftarrow \begin{array}{l} \text{place } M_{j+1}, \\ j=1, \dots, k-1 \end{array}$$

The characteristic polynomial for the corresponding inverse J^{-1} is proportional to

(4.31)

$$p_m(x) = m_k x^{M_k} + m_{k-1} x^{M_{k-1}} + \cdots + m_1 x^{M_1} - 1$$

Since $\sum_{i=1}^k m_i e^{-\beta M_i} = 1$, we see that $x = e^{-\beta}$ is the unique positive root for this polynomial. Thus e^β is the Perron–Frobenius eigenvalue for J .

Remark 4.11. Note that the implications (i) \Leftarrow (ii) \Leftrightarrow (iii) in Proposition 4.1 remain true even if L_1, \dots, L_d are not integers, by essentially the same proof. This is because the action $\sigma^{(L)}$ defined by (4.1) is almost periodic in all cases, and hence \mathfrak{A}_L is the closure of the linear span of $s_\alpha s_\gamma^*$ with $L(\alpha) = L(\gamma)$ even in the general case, using (4.5) and the definition

$$L(\alpha) = \sum_{m=1}^k L_{\alpha_m}.$$

It is no longer true that (i) \Rightarrow (ii). Take for example $d = 2$ and L_1, L_2 rationally independent irrational numbers of opposite sign. Then \mathfrak{A}_L is the GICAR algebra [29].

Part B

Numerical AF-Invariants

The dimension group of \mathfrak{A}_L

In this chapter and the following ones we will construct isomorphism invariants for \mathfrak{A}_L and try to classify the \mathfrak{A}_L . It is known that there exists a complete isomorphism invariant for AF-algebras \mathfrak{A} , namely the dimension group. In the case that \mathfrak{A} has a unit this is the triple $(K_0(\mathfrak{A}), K_0(\mathfrak{A})_+, [\mathbf{1}])$ where $K_0(\mathfrak{A})$ is an abelian group, $K_0(\mathfrak{A})_+$ are the positive elements of $K_0(\mathfrak{A})$ relative to an order making $K_0(\mathfrak{A})$ into a Riesz ordered group without perforation, and $[\mathbf{1}]$ is the class of the identity in $K_0(\mathfrak{A})$ (if \mathfrak{A} is nonunital, replace $[\mathbf{1}]$ by the hereditary subset $\{[p] \mid p \text{ projection in } \mathfrak{A}\}$ of $K_0(\mathfrak{A})_+$). See [32] for details on this and the following statements. (Connections to ergodic theory are also described in [90], [89].) Let us now specialize to the case that \mathfrak{A} is given by a constant $N \times N$ incidence matrix J (with nonnegative integer entries) which is primitive, i.e., J^n has only positive entries for some $n \in \mathbb{N}$. Then \mathfrak{A} is simple with a unique trace state τ . In the case that $K_0(\mathfrak{A}) \cong \mathbb{Z}^N$, this class of AF-algebras (or rather dimension groups) has been characterized intrinsically in [50, Theorems 3.3 and 4.1]. In general when J is an $n \times n = L_d \times L_d$ matrix with nonnegative entries, the dimension group is the inductive limit

$$(5.1) \quad \mathbb{Z}^N \xrightarrow{J} \mathbb{Z}^N \xrightarrow{J} \mathbb{Z}^N \xrightarrow{J} \dots$$

with order generated by the order defined by

$$(5.2) \quad (m_1, \dots, m_N) \geq 0 \iff m_i \geq 0 \quad \text{on } \mathbb{Z}^N.$$

This group can be computed explicitly as a subgroup of \mathbb{R}^N as follows when $\det(J) \neq 0$ (as it is in our case): Put

$$(5.3) \quad G_m = J^{-m}(\mathbb{Z}^N), \quad m = 0, 1, \dots,$$

and equip G_m with the order

$$(5.4) \quad G_m^+ = J^{-m}((\mathbb{Z}^N)^+).$$

Then

$$(5.5) \quad G_0 \subseteq G_1 \subseteq G_2 \subseteq \dots,$$

and

$$(5.6) \quad K_0(\mathfrak{A}_L) = \bigcup_m G_m,$$

a subgroup of \mathbb{R}^N (containing \mathbb{Z}^N), with order defined by

$$(5.7) \quad g \geq 0 \quad \text{if } g \geq 0 \text{ in some } G_m.$$

The action of the trace state τ on $K_0(\mathfrak{A}_L)$ may be computed as follows: If λ is the Frobenius eigenvalue of J , and $\alpha = (\alpha_1, \dots, \alpha_N)$ is a corresponding eigenvector in the sense

$$(5.8) \quad \alpha J = \lambda \alpha$$

(i.e., $J^t \alpha^t = \lambda \alpha^t$, see [32, pp. 33–37]), then if α is suitably normalized (by multiplying with a positive factor), the trace applied to something at the m 'th stage of

$$(5.9) \quad \begin{array}{ccccccc} & & & & & g & \\ & & & & & \cap & \\ \mathbb{Z}_1^N & \longrightarrow & \mathbb{Z}_2^N & \longrightarrow & \mathbb{Z}_3^N & \longrightarrow & \dots \longrightarrow \mathbb{Z}_m^N \longrightarrow \dots \end{array}$$

is

$$(5.10) \quad \tau(g) = \lambda^{-m+1} \langle \alpha | g \rangle,$$

where $\langle \cdot | \cdot \rangle$ here denotes the usual inner product in \mathbb{R}^N , i.e., $\langle \alpha | g \rangle = \sum_{i=1}^N \alpha_i g_i$. Taking α as the Frobenius eigenvector in (5.10) makes the ansatz well defined: if $g \in G_m \subseteq G_{m+1}$, then

$$(5.11) \quad \lambda^{-m+1} \langle \alpha | g \rangle = \lambda^{-(m+1)+1} \langle \alpha | Jg \rangle.$$

Thus τ is an additive character on $K_0(\mathfrak{A}_L)$, and up to normalization the unique positive such. If we identify $[\mathbf{1}]_0$ with $(1, 0, 0, \dots)$ in the first \mathbb{Z}^N , the normalization of α is $\alpha_1 = 1$.

Elements of the kernel of the additive real-valued character τ on $K_0(\mathfrak{A})$ are called infinitesimal elements. Thus $K_0(\mathfrak{A})$ is an extension of $\tau(K_0(\mathfrak{A}))$ by the kernel of τ . But in general it is not the trivial extension, i.e.,

$$K_0(\mathfrak{A}_L) \not\cong \tau(K_0(\mathfrak{A}_L)) \oplus (\text{kernel of } \tau),$$

which complicates classification; see Chapter 10.

Suppose we calculate the groups $\tau(K_0(\mathfrak{A}_L))$ and $\ker(\tau_L)$ for a specific pair, given by L and L' , say. Then if one of the two groups $\tau(K_0(\mathfrak{A}_L))$ or $\ker(\tau_L)$ is different for L and for L' , the AF-algebras \mathfrak{A}_L and $\mathfrak{A}_{L'}$ are non-isomorphic. We show, however, in Chapter 10 that the AF-algebras can be non-isomorphic even if the two groups agree for L and L' .

It can then be shown that the range of the trace on projections is $\tau(K_0(\mathfrak{A}_L)) \cap [0, 1]$.

When $K_0(\mathfrak{A}_L)$ is given concretely in \mathbb{R}^N as above, the trace can be computed as

$$(5.12) \quad \tau(g) = \langle \alpha | g \rangle,$$

where $g \in m$ 'th term \mathbb{Z}^N is identified with its image $J^{-m+1}g$ in \mathbb{R}^N ; and the positive cone in $K_0(\mathfrak{A}_L) \subseteq \mathbb{R}^N$ identifies with those g such that $\tau(g) > 0$, or $g = 0$.

Let us now specialize to the case that $J = J_L$ has the special form we are interested in. So assume that $1 \leq L_1 \leq L_2 \leq \dots \leq L_d$, that the greatest common divisor of L_1, \dots, L_d is 1, and put

$$(5.13) \quad \{L_1, \dots, L_d\} = \left\{ \begin{array}{c} M_1, \dots, M_k \\ m_1 \quad \dots \quad m_k \end{array} \right\},$$

where m_i is the multiplicity of M_i . Put

$$(5.14) \quad N = M_k = L_d.$$

Then the incidence matrix J is

$$(5.15) \quad J = \begin{matrix} & \begin{matrix} 1 \\ \vdots \\ M_1 \\ \vdots \\ M_2 \\ \vdots \\ M_k \end{matrix} & \begin{pmatrix} 0 & 1 & 0 & \cdots & 0 & 0 & 0 & \cdots & 0 & 0 & 0 & \cdots & \cdots & 0 & 0 \\ 0 & 0 & 1 & & 0 & 0 & 0 & \cdots & 0 & 0 & 0 & \cdots & \cdots & 0 & 0 \\ \vdots & & \ddots & \ddots & \vdots & \vdots & & \vdots & \vdots & \vdots & & & & \vdots & \vdots \\ 0 & 0 & 0 & \ddots & 1 & 0 & 0 & \cdots & 0 & 0 & 0 & \cdots & \cdots & 0 & 0 \\ m_1 & 0 & 0 & & 0 & 1 & 0 & \cdots & 0 & 0 & 0 & \cdots & \cdots & 0 & 0 \\ 0 & 0 & 0 & \cdots & 0 & 0 & 1 & & 0 & 0 & 0 & \cdots & \cdots & 0 & 0 \\ \vdots & \vdots & \vdots & & \vdots & \ddots & \ddots & & \vdots & \vdots & & & & \vdots & \vdots \\ 0 & 0 & 0 & \cdots & 0 & 0 & 0 & \ddots & 1 & 0 & 0 & \cdots & \cdots & 0 & 0 \\ m_2 & m_2 & 0 & 0 & \cdots & 0 & 0 & 0 & & 0 & 1 & 0 & \cdots & \cdots & 0 & 0 \\ 0 & 0 & 0 & \cdots & 0 & 0 & 0 & \cdots & 0 & 0 & 1 & & \cdots & 0 & 0 \\ \vdots & \vdots & \vdots & & \vdots & \vdots & \vdots & & \vdots & \ddots & \ddots & & & \vdots & \vdots \\ \vdots & \vdots & \vdots & & \vdots & \vdots & \vdots & & \vdots & \vdots & & \ddots & \ddots & & \vdots \\ 0 & 0 & 0 & \cdots & 0 & 0 & 0 & \cdots & 0 & 0 & 0 & & \ddots & 1 & 0 \\ 0 & 0 & 0 & \cdots & 0 & 0 & 0 & \cdots & 0 & 0 & 0 & \cdots & & 0 & 1 \\ m_k & m_k & 0 & 0 & \cdots & 0 & 0 & 0 & \cdots & 0 & 0 & 0 & \cdots & \cdots & 0 & 0 \end{pmatrix} \end{matrix}.$$

Let $x = e^{-\beta}$ be the unique solution in $(0, 1)$ of

$$(5.16) \quad 1 - \sum_i m_i x^{M_i} = 0.$$

If

$$(5.17) \quad \alpha = (1, e^{-\beta}, e^{-2\beta}, \dots, e^{-(N-1)\beta}),$$

then α is the left Frobenius eigenvector

$$(5.18) \quad \alpha J = e^\beta \alpha.$$

As explained before, we have the identification

$$(5.19) \quad K_0(\mathfrak{A}_L) = \bigcup_{n=0}^{\infty} J^{-n} \mathbb{Z}^N \quad (\subseteq \mathbb{R}^N)$$

with the trace functional

$$(5.20) \quad \tau(y) = \langle \alpha | y \rangle, \quad y \in \bigcup_{n=0}^{\infty} J^{-n} \mathbb{Z}^N.$$

Using

$$(5.21) \quad \langle \alpha | J^{-n} k \rangle = e^{-n\beta} \langle \alpha | k \rangle = e^{-n\beta} \sum_{i=1}^N k_i e^{-\beta(i-1)}$$

for $k \in \mathbb{Z}^N$, $n \in \mathbb{N}$, together with the fact that the range of the trace is a subgroup of the additive group \mathbb{R} , it is clear that the range of the trace is $\mathbb{Z}[e^{-\beta}]$, i.e.,

$$(5.22) \quad \tau(K_0(\mathfrak{A}_L)) = \mathbb{Z}[e^{-\beta}],$$

and, furthermore, from [32],

$$(5.23) \quad \tau(\{p \mid p \text{ projection in } \mathfrak{A}_L\}) = \mathbb{Z}[e^{-\beta}] \cap [0, 1].$$

Now, if $m = (m_1, \dots, m_N)$ is an element of the k 'th group

$$(5.24) \quad \mathbb{Z}^N \xrightarrow{J} \mathbb{Z}^N \xrightarrow{J} \mathbb{Z}^N \xrightarrow{J} \dots$$

and m is an infinitesimal element then $\langle \alpha \mid m^t \rangle = 0$, i.e.,

$$(5.25) \quad \sum_{i=1}^N m_i (e^{-\beta})^{i-1} = 0$$

(where we include zero terms!). This sum $\sum_{i=1}^N m_i x^{i-1}$ is a multiple of the minimal polynomial $p_\beta(x)$ having $e^{-\beta}$ as a root. If this minimal polynomial happens to be $1 - \sum_i m_i x^{M_i}$, which has degree N , then there are no nontrivial infinitesimal elements, and

$$(5.26) \quad K_0(G) \cong \mathbb{Z}[e^{-\beta}].$$

If p_β has degree $\deg(p_\beta) < N$, it follows that

$$(5.27) \quad \sum_{i=1}^N m_i x^{i-1} = p(x) \cdot (\text{arbitrary polynomial of degree } \leq (N-1) - \deg p_\beta).$$

It follows that the group of infinitesimal elements of the m 'th group \mathbb{Z}^N is isomorphic to

$$(5.28) \quad \mathbb{Z}^{N - \deg p_\beta},$$

and as J maps these groups into each other, we obtain the infinitesimal elements as an inductive limit

$$(5.29) \quad \mathbb{Z}^{N - \deg p_\beta} \xrightarrow{J_0} \mathbb{Z}^{N - \deg p_\beta} \xrightarrow{J_0} \dots,$$

where J_0 is a restriction of J , so J_0 is an injective matrix with integer entries, but the entries are no longer necessarily positive, as we see in the examples. See Chapter 7 for more details on J_0 .

In conclusion, the complete invariant

$$(5.30) \quad (K_0(\mathfrak{A}_L), K_0(\mathfrak{A}_L)_+, [\mathbf{1}])$$

of the algebras \mathfrak{A}_L defines an extension

$$(5.31) \quad 0 \longrightarrow \ker(\tau) \xrightarrow{i} K_0(\mathfrak{A}_L) \xrightarrow{\tau} \mathbb{Z}[e^{-\beta}] \longrightarrow 0$$

together with an element $[\mathbf{1}]$ of $K_0(\mathfrak{A}_L)$ such that

$$(5.32) \quad \tau([\mathbf{1}]) = 1.$$

See Chapter 10 for more details on these extensions. Concretely, $K_0(\mathfrak{A}_L)$ is the subgroup (5.19) of \mathbb{R}^N , τ is given by (5.20) and (5.17) and

$$(5.33) \quad [\mathbf{1}] = (1, 0, 0, \dots, 0)$$

and

$$(5.34) \quad K_0(\mathfrak{A}_L)_+ = \{0\} \cup \{v \in K_0(\mathfrak{A}_L) \mid \langle \alpha \mid v \rangle > 0\}.$$

Note in passing that if G is any countable abelian group which is an extension

$$0 \longrightarrow G_0 \hookrightarrow G \xrightarrow{\tau} \mathbb{Z}[a] \longrightarrow 0$$

where G_0 is a torsion-free abelian group and a is a real number, and $\mathbb{Z}[a]$ is equipped with the order coming from $\mathbb{Z}[a] \subseteq \mathbb{R}$, and if G is equipped with the order $g > 0$ if and only if $\tau(g) > 0$, then G is unperforated and has the Riesz interpolation property, so G is the dimension group of an AF-algebra by Effros–Handelman–Shen’s theorem [33], [29].

Another way of describing $(K_0(\mathfrak{A}_L), K_0(\mathfrak{A}_L)_+, [\mathbf{1}])$ which will be quite useful in the sequel is the following: Let $p_L(x)$ be $|\det J|$ times the characteristic polynomial of J^{-1} , see (4.31), (5.16), (5.48), and let $a = e^{-\beta}$ be the positive real root of this polynomial (i.e., $1/a$ is the Perron–Frobenius eigenvalue of J). Then

$$(5.35) \quad K_0(\mathfrak{A}_L) \cong \mathbb{Z}[x] / (p_L)$$

as additive groups, and the order on $K_0(\mathfrak{A}_L)$ is given by that $p + \mathbb{Z}[x]p_L(x) > 0$ if and only if

$$(5.36) \quad p(a) > 0$$

(this condition is well defined since $p_L(a) = 0$). The element $[\mathbf{1}]$ corresponds to $1 + \mathbb{Z}[x]p_L(x)$ by this isomorphism. Application of J^{-1} on $K_0(\mathfrak{A}_L)$ (which is well defined by (5.19)) corresponds to multiplication by x , i.e.,

$$(5.37) \quad J^{-1}(p(x) + \mathbb{Z}[x]p_L(x)) = xp(x) + \mathbb{Z}[x]p_L(x)$$

where the left-hand polynomial is identified with its representative in $K_0(\mathfrak{A}_L)$ given as in (5.38), below. The isomorphism between the concrete realization of $K_0(\mathfrak{A}_L)$ in (5.19) and $\mathbb{Z}[x] / (p_L)$ is thus given by

$$(5.38) \quad (a_0, \dots, a_{N-1}) \longmapsto a_0 + a_1x + \dots + a_{N-1}x^{N-1} \pmod{p_L(x)},$$

and using this and (5.21) the statements above follow immediately. Note also that in this picture

$$(5.39) \quad \ker \tau = \mathbb{Z}[x]p_a(x) / (p_L(x)),$$

where $p_a \in \mathbb{Z}[x]$ is the minimal polynomial of a , which is a factor of p_L . Factorizing

$$(5.40) \quad p_L(x) = p_0(x)p_a(x)$$

we thus have

$$(5.41) \quad \ker \tau \cong \mathbb{Z}[x] / (p_0(x)).$$

This viewpoint will be important in Chapter 7 and later chapters.

One connection between the cone (5.2) and that of (5.34) can be made by the use of [45, Lemma 2], which shows that a given element g of $K_0(\mathfrak{A}_L) = \bigcup_{k \geq 0} J_L^{-k} \mathbb{Z}^N$ satisfies $\tau(g) > 0$ if and only if there are $k \in \{0, 1, 2, \dots\}$, $n = (n_1, \dots, n_N) \in \mathbb{Z}^N$, such that $n_i > 0$, and $v \in \ker(\tau)$ such that

$$g = v + J_L^{-k}n.$$

In applications, this “concrete” realization of $(K_0(\mathfrak{A}_L), K_0(\mathfrak{A}_L)_+, [\mathbf{1}])$ is often nevertheless not concrete enough to decide isomorphism and non-isomorphism of

the algebras \mathfrak{A}_L , but there is a simple sufficient condition for isomorphism, namely equality:

Corollary 5.1. *Let $1 \leq L_1 \leq \dots \leq L_d$ and $1 \leq L'_1 \leq \dots \leq L'_{d'}$ be two sets of integers, each with greatest common divisor 1. Assume*

(5.42) *the unique solutions $x, y \in (0, 1)$ of the equations*

$$1 - \sum_i^d x^{L_i} = 0 \text{ and } 1 - \sum_i^{d'} y^{L'_i} = 0 \text{ are the same, i.e., } x = y;$$

and

$$(5.43) \quad L_d = L'_{d'} (= N) \quad \text{and} \quad \bigcup_{n=0}^{\infty} J_L^{-n}(\mathbb{Z}^N) = \bigcup_{n=0}^{\infty} J_{L'}^{-n}(\mathbb{Z}^N).$$

It follows that \mathfrak{A}_L and $\mathfrak{A}_{L'}$ are isomorphic C^ -algebras.*

Proof. By condition (5.42) and (5.16)–(5.18) the Perron–Frobenius eigenvalue e^β and the normalized left Perron–Frobenius eigenvector α are the same for J_L and $J_{L'}$. But (5.43) states that $K_0(\mathfrak{A}_L)$ and $K_0(\mathfrak{A}_{L'})$ are the same subgroup of \mathbb{Q}^N , and by (5.34) the positive cones are the same. By (5.33), $[\mathbb{1}]$ is represented by the same element of the two cases, and thus the complete invariants (5.30) are the same. Thus \mathfrak{A}_L and $\mathfrak{A}_{L'}$ are isomorphic C^* -algebras. \square

Still we will see in the examples that the computation of $\bigcup_{n=0}^{\infty} J_L^{-n}(\mathbb{Z}^N)$ is not so simple in general. But there is one simple special case, namely when $m_k = 1$ in (5.15), i.e., $|\det(J_L)| = 1$. Then J_L^{-1} is a matrix with integer entries, so $J_L: \mathbb{Z}^N \rightarrow \mathbb{Z}^N$ is bijective and hence

$$(5.44) \quad K_0(\mathfrak{A}_L) = \mathbb{Z}^N$$

by (5.19). It follows immediately from Corollary 5.1 that

Corollary 5.2. *Let $1 \leq L_1 \leq \dots \leq L_d$ and $1 \leq L'_1 \leq \dots \leq L'_{d'}$ be two sets of integers, each with greatest common divisor 1. Assume*

(5.45) *the unique solutions $x, y \in (0, 1)$ of the equations*

$$1 - \sum_i^d x^{L_i} = 0 \text{ and } 1 - \sum_i^{d'} y^{L'_i} = 0 \text{ are the same, i.e., } x = y;$$

and

$$(5.46) \quad L_d = L'_{d'} \text{ and } L_{d-1} < L_d \text{ and } L'_{d'-1} < L'_{d'} \text{ (i.e., the matrices } J_L \text{ and } J_{L'} \text{ have the same rank, and the lower left matrix element is 1)}.$$

It follows that \mathfrak{A}_L and $\mathfrak{A}_{L'}$ are isomorphic C^ -algebras.*

Proof. In this case $|\det J_L| = |\det J_{L'}| = 1$ so $K_0(\mathfrak{A}_L) = K_0(\mathfrak{A}_{L'}) = \mathbb{Z}^N$ and the result follows from Corollary 5.1. \square

In general we will see in the examples that the algebras \mathfrak{A}_L for different L 's are “almost never” isomorphic. However, Corollary 5.2 may be used to make some isomorphic tuples:

Example 5.3. It is convenient from here and henceforth to write J in the form

$$(5.47) \quad J = \begin{pmatrix} m_1 & 1 & 0 & \cdots & 0 & 0 \\ m_2 & 0 & 1 & \cdots & 0 & 0 \\ \vdots & & \ddots & \ddots & \vdots & \vdots \\ m_{N-2} & 0 & & \ddots & 1 & 0 \\ m_{N-1} & 0 & 0 & & 0 & 1 \\ m_N & 0 & 0 & \cdots & 0 & 0 \end{pmatrix},$$

instead of (5.15), and then equation (5.16) becomes

$$(5.48) \quad p_L(x) = \sum_{j=1}^N m_j x^j - 1 = 0.$$

As noted in (4.30)–(4.31) this equation is m_N times the characteristic equation of

$$(5.49) \quad J^{-1} = \begin{pmatrix} 0 & 0 & \cdots & 0 & 0 & \frac{1}{m_N} \\ 1 & 0 & & 0 & 0 & -\frac{m_1}{m_N} \\ 0 & 1 & \ddots & & 0 & -\frac{m_2}{m_N} \\ \vdots & \vdots & \ddots & \ddots & & \vdots \\ 0 & 0 & \cdots & 1 & 0 & -\frac{m_{N-2}}{m_N} \\ 0 & 0 & \cdots & 0 & 1 & -\frac{m_{N-1}}{m_N} \end{pmatrix}$$

The condition in Corollary 5.2 is that $m_N = 1$, i.e., the polynomial (5.48) should be monic. Now it follows from Corollary 5.2 that two *monic* polynomials of the form (5.48) give rise to isomorphic algebras if they have the same degree N and the root in $(0, 1)$ is the same for the two polynomials (under the overall condition $\gcd(\{i \mid m_i \neq 0\}) = 1$). (This is no longer true if the polynomials are not monic; see, e.g., the examples in Chapters 16 and 17.) To generate polynomials of the form (5.48) with the same root, one may start with a fixed polynomial of the required form, e.g.,

$$p_0(x) = x^3 + x^2 - 1,$$

and then multiply $p_0(x)$ with a polynomial

$$q(x) = x^n + k_{n-1}x^{n-1} + k_{n-2}x^{n-2} + \cdots + k_1x + 1.$$

Choose the coefficients k_1, \dots, k_{n-1} as integers such that $m_j \geq 0$ for all j in

$$p_0(x)q(x) = x^{n+3} + \sum_{j=1}^{n+2} m_j x^j - 1.$$

This procedure, applied to $n = 2, 3, 4, 5$, gives the following values for the possible first column

$$\begin{pmatrix} m_1 \\ \vdots \\ m_{n+3} \end{pmatrix} = \begin{pmatrix} m_1 \\ \vdots \\ m_N \end{pmatrix} = \begin{pmatrix} m_1 \\ \vdots \\ m_{N-1} \\ 1 \end{pmatrix}$$

of the incidence matrix J :

$n = 2$: Two isomorphic algebras:

$$\begin{pmatrix} 1 \\ 0 \\ 0 \\ 0 \\ 1 \end{pmatrix}, \begin{pmatrix} 0 \\ 0 \\ 1 \\ 1 \\ 1 \end{pmatrix}.$$

$n = 3$: Two isomorphic algebras:

$$\begin{pmatrix} 0 \\ 1 \\ 0 \\ 0 \\ 1 \\ 1 \end{pmatrix}, \begin{pmatrix} 0 \\ 0 \\ 0 \\ 1 \\ 2 \\ 1 \end{pmatrix}.$$

$n = 4$: Three isomorphic algebras, which are subalgebras of \mathcal{O}_5 , \mathcal{O}_4 , \mathcal{O}_3 , respectively:

$$\begin{pmatrix} 0 \\ 0 \\ 0 \\ 0 \\ 2 \\ 2 \\ 1 \end{pmatrix}, \begin{pmatrix} 0 \\ 0 \\ 1 \\ 0 \\ 1 \\ 1 \\ 1 \end{pmatrix}, \begin{pmatrix} 0 \\ 0 \\ 2 \\ 0 \\ 0 \\ 0 \\ 1 \end{pmatrix}.$$

See Figure 14.

$n = 5$: There are $6 + 1$ possibilities to begin with,

$$\begin{pmatrix} 0 \\ 0 \\ 0 \\ 0 \\ 1 \\ 2 \\ 2 \\ 1 \end{pmatrix}, \begin{pmatrix} 0 \\ 0 \\ 1 \\ 1 \\ 1 \\ 1 \\ 1 \end{pmatrix}, \begin{pmatrix} 0 \\ 0 \\ 0 \\ 0 \\ 1 \\ 1 \\ 1 \end{pmatrix}, \begin{pmatrix} 0 \\ 0 \\ 1 \\ 0 \\ 1 \\ 1 \\ 1 \end{pmatrix}, \begin{pmatrix} 1 \\ 0 \\ 0 \\ 0 \\ 0 \\ 1 \\ 1 \end{pmatrix}, \begin{pmatrix} 0 \\ 0 \\ 0 \\ 2 \\ 1 \\ 0 \\ 0 \\ 1 \end{pmatrix}, \begin{pmatrix} 0 \\ 1 \\ 0 \\ 1 \\ 0 \\ 0 \\ 0 \\ 1 \end{pmatrix},$$

but in the last example $\gcd(L) = 2$, so this falls outside our scope. The remaining 6 vectors give rise to isomorphic subalgebras of \mathcal{O}_d with $d = 6, 5, 4, 4, 3, 4$, respectively. Note that this shows that d is *not* an invariant. The next-to-last example is illustrated in Figure 3.

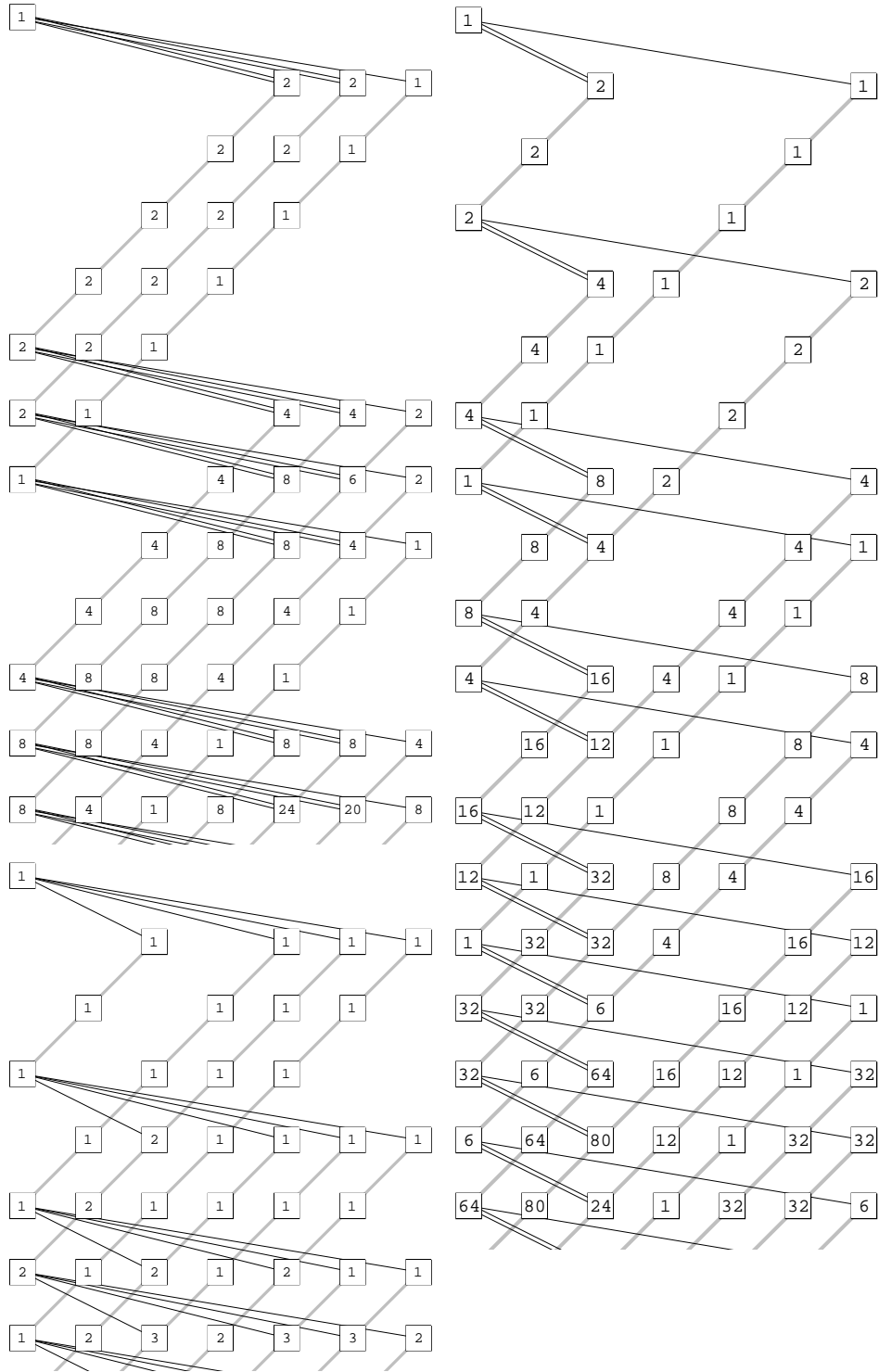

FIGURE 14. $L = \{5, 5, 6, 6, 7\}$ (top left), $\{3, 5, 6, 7\}$ (bottom left), and $\{3, 3, 7\}$ (right), illustrating the $n = 4$ case in Example 5.3. These represent isomorphic algebras.

Remark 5.4. The isomorphism of the algebras \mathfrak{A}_L and $\mathfrak{A}_{L'}$ established in Example 5.3 for various pairs L, L' was arrived at in a quite roundabout way. In general it follows from [6, Theorem 2.7] that \mathfrak{A}_L and $\mathfrak{A}_{L'}$ are stably isomorphic if and only if there exist natural numbers $k_1, k_2, k_3, \dots, l_1, l_2, l_3, \dots$, and matrices $A_1, A_2, \dots, B_1, B_2, \dots$ with nonnegative integer matrix elements such that the following diagram commutes:

$$(5.50) \quad \begin{array}{ccc} \bullet & & \\ \downarrow J_L^{k_1} & \searrow A_1 & \bullet \\ \bullet & \swarrow B_1 & \downarrow J_{L'}^{l_1} \\ \downarrow J_L^{k_2} & \searrow A_2 & \bullet \\ \bullet & \swarrow B_2 & \downarrow J_{L'}^{l_2} \\ \downarrow J_L^{k_3} & \searrow A_3 & \bullet \\ \bullet & \swarrow B_3 & \downarrow J_{L'}^{l_3} \\ \downarrow & \searrow A_4 & \bullet \\ \vdots & \swarrow & \downarrow \\ & & \vdots \end{array}$$

This means that

$$(5.51) \quad \begin{aligned} J_L^{k_i} &= B_i A_i, \\ J_{L'}^{l_i} &= A_{i+1} B_i \end{aligned}$$

for $i = 1, 2, \dots$. There are examples showing that the sequences A, B, k, l cannot always be taken to be constant when they exist [13]. In our case, when the J_L 's are nonsingular, the existence of constant sequences would entail that J_L and $J_{L'}$ have the same dimension, and J_L^k be conjugate to $J_{L'}^l$. Note in this connection that

J_L is conjugate to $J_{L'}$ if and only if $L = L'$, because the characteristic polynomial of J_L completely determines $L = (L_1, \dots, L_d)$, as we have seen.

In the covariant version of this isomorphism problem, it is known from a theorem by Krieger that the sequences can be taken to be constant. Let $G(L)$ be the dimension group associated to L , and $(\sigma_L)_*$ the automorphism of $G(L)$ determined by J_L . Let now $\mathfrak{B}_L = \mathfrak{A}_L \otimes \mathcal{K}(\ell^2)$ be the stable AF-algebra associated to $G(L)$, and σ_L an automorphism of \mathfrak{B}_L such that the corresponding automorphism of $G(L)$ is $(\sigma_L)_*$. Then Krieger's theorem [61] says that $(G(L), (\sigma_L)_*)$ is isomorphic to $(G(L'), (\sigma_{L'})_*)$ if and only if there is a $k \in \mathbb{N}$ and nonnegative rectangular matrices A, B such that

$$(5.52) \quad \begin{aligned} AJ_L &= J_{L'}A, \\ BJ_{L'} &= J_LB, \\ AB &= J_L^k, \\ BA &= J_{L'}^k. \end{aligned}$$

If also $N > 1$, it was proved recently in [17] that this is also equivalent to outer conjugacy of σ_L and $\sigma_{L'}$. All these results were proved in the more general setting of constant incidence matrices. In the J_L case, the conditions simply mean $L = L'$. In fact, the third condition in (5.52) implies that both A and B are nonsingular. Hence, the first condition reads $J_{L'} = AJ_L A^{-1}$, and we conclude that J_L and $J_{L'}$ have the same characteristic polynomial. Since the coefficients in the characteristic polynomial of J_L are the numbers in the first column of J_L , it follows that $J_L = J_{L'}$ as claimed. (See also (11.1)–(11.2) for more details.)

Note that the Williams conjecture discussed at the end of Chapter 6 in [32] has been settled in the negative in [58].

Let us end this chapter by mentioning another corollary of results in [17], which classifies the actions $\sigma^{(L)}$ of \mathbb{T} on \mathcal{O}_d defined by (4.1):

Corollary 5.5. *Let $1 \leq L_1 \leq \dots \leq L_d$ and $1 \leq L'_1 \leq \dots \leq L'_d$ be two sets of integers, each with greatest common divisor 1. The following conditions are equivalent.*

- (i) *The automorphism σ_L of $\mathfrak{A}_L \otimes \mathcal{K}(\ell^2)$ defined prior to (5.52) is outer conjugate to $\sigma_{L'}$.*
- (ii) *$(G(L), (\sigma_L)_*)$ is isomorphic to $(G(L'), (\sigma_{L'})_*)$.*
- (iii) *The action $\sigma^{(L)}$ of \mathbb{T} on \mathcal{O}_d defined by (4.1) is outer conjugate to the action $\sigma^{(L')}$.*
- (iv) *$\sigma^{(L)}$ and $\sigma^{(L')}$ are conjugate actions of \mathbb{T} .*
- (v) *$L = L'$.*

Proof. We already noted above that (i) \Leftrightarrow (ii) is [17, Corollary 1.5]. But (ii) \Leftrightarrow (iv) follows from [17, Corollary 4.1]. The implication (iii) \Rightarrow (ii) follows by noting that the stabilization of the dual actions of $\sigma^{(L)}, \sigma^{(L')}$ is outer conjugate to $\sigma_L, \sigma_{L'}$ by Takai duality. The only remaining nontrivial implication is (ii) \Rightarrow (v); as noted in [13], the relations (5.52) imply that J_L and $J_{L'}$ are similar, and thus have the same characteristic polynomial. But by (10.10), the characteristic polynomial determines J_L and thus L uniquely. Thus (ii) \Rightarrow (v). \square

Remark 5.6. The equivalence relation of Bratteli diagrams referred to in the second paragraph in the Introduction can be described as follows: The diagram itself can be described as a sequence of incidence matrices

$$(5.53) \quad J_1, J_2, J_3, J_4, \dots$$

These are (not necessarily square) matrices with integer nonnegative matrix units such that the number of columns in J_{n+1} is equal to the number of rows in J_n . One way of obtaining an equivalent diagram is then to remove rows from the diagram and connect the remaining vertices by edges with multiplicity given by the number of ways one can go from the upper vertex to the lower along the original diagram. In terms of incidence matrices, one picks an increasing sequence $1 \leq n_1 < n_2 < n_3$ of integers, and replaces the sequence (5.53) by

$$(5.54) \quad J_{n_2-1} J_{n_2-2} \cdots J_{n_1}, \quad J_{n_3-1} J_{n_3-2} \cdots J_{n_2}, \quad \dots$$

The equivalence relation is then simply the equivalence relation on sequences of incidence matrices generated by this relation. One has to apply the relation or its inverse four times to go from one diagram to another. Roughly, start from

$$\mathfrak{A}_1 \longrightarrow \mathfrak{A}_2 \longrightarrow \mathfrak{A}_3 \longrightarrow \dots$$

by removing rows to obtain

$$\mathfrak{A}_{n_1} \longrightarrow \mathfrak{A}_{n_2} \longrightarrow \mathfrak{A}_{n_3} \longrightarrow \dots,$$

then insert new rows to obtain

$$\mathfrak{A}_{n_1} \longrightarrow \mathfrak{B}_{m_1} \longrightarrow \mathfrak{A}_{n_2} \longrightarrow \mathfrak{B}_{m_2} \longrightarrow \dots,$$

then remove rows to obtain

$$\mathfrak{B}_{m_1} \longrightarrow \mathfrak{B}_{m_2} \longrightarrow \mathfrak{B}_{m_3} \longrightarrow \dots,$$

and finally insert rows to obtain

$$\mathfrak{B}_1 \longrightarrow \mathfrak{B}_2 \longrightarrow \mathfrak{B}_3 \longrightarrow \dots.$$

One example from [6], where the first and last steps are unnecessary, is

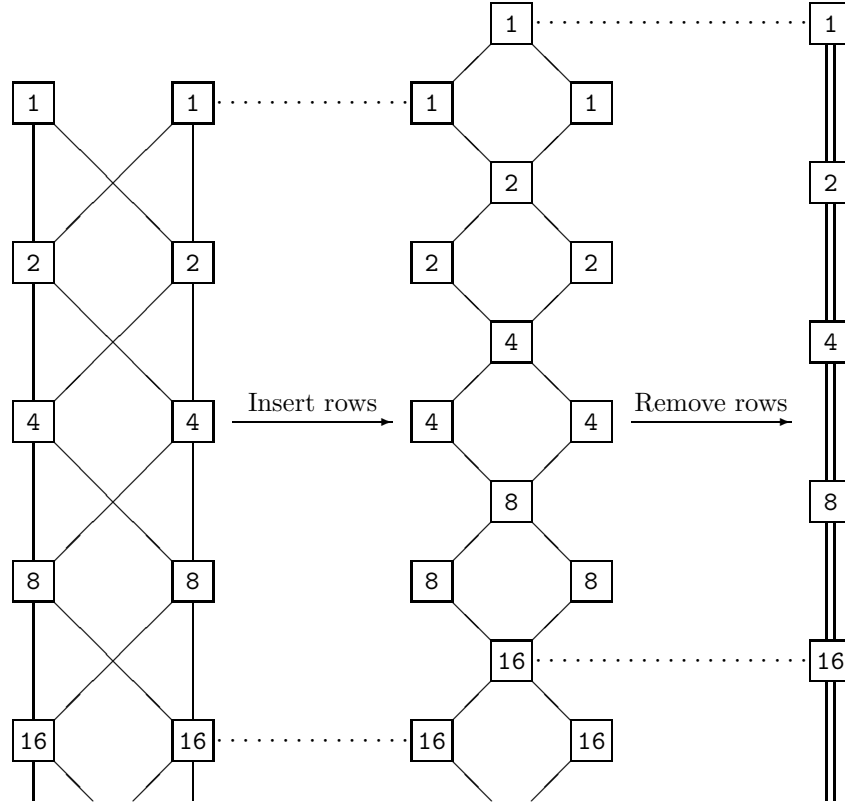

Here the algebra is the UHF algebra $\otimes^\infty M_2$ of Glimm type 2^∞ , also illustrated in Figure 1. The algebra to the left is the fixed-point subalgebra of $\otimes^\infty M_2$ under the infinite-product action $\otimes^\infty \text{Ad} \begin{pmatrix} 1 & 0 \\ 0 & -1 \end{pmatrix}$ of \mathbb{Z}_2 , and the figure shows that this fixed-point algebra is isomorphic to the full algebra [85]. To show directly that the pairs or triples of diagrams shown in Figures 14, 15, 17, 19, and 20 can be transformed into each other by this method is presumably a much harder task, as it is to show directly that the pair in Figure 12 cannot be transformed into each other.

Invariants related to the Perron–Frobenius eigenvalue

Let J, K be two nonsingular $N \times N$ matrices with nonnegative matrix elements which are primitive, i.e., for sufficiently large $n \in \mathbb{N}$, J^n and K^n have only strictly positive matrix elements. Let λ_1, λ_2 be the Perron–Frobenius eigenvalues of J, K . Then λ_1, λ_2 are algebraic numbers, and $\mathbb{Q}[\lambda_1]$ and $\mathbb{Q}[\lambda_2]$ are fields which are finite extensions of \mathbb{Q} . If λ_1 and λ_2 are rational, they are integers since they satisfy a monic equation. If in addition $N = 1$, then the stable C^* -algebras associated with the corresponding dimension groups characterized in (5.1)–(5.34) are $M_{\lambda_i^\infty} \otimes \mathcal{K}(\mathcal{H})$, where M_{λ^∞} is the UHF algebra of Glimm type λ^∞ and $\mathcal{K}(\mathcal{H})$ is the compact operators on a separable Hilbert space \mathcal{H} . It follows from Glimm’s theorem [47] that these algebras are isomorphic if and only if λ_1 and λ_2 contain the same prime factors. In particular, if $J = (6)$ and $K = (12)$ (as 1×1 matrices), the associated C^* -algebras are isomorphic. See also [13, Example 9]. This was partly generalized in [13, Theorem 10], where it was proved that if J, K are nonsingular primitive $N \times N$ matrices and the stable C^* -algebras they define are isomorphic, then $\mathbb{Q}[\lambda_1] = \mathbb{Q}[\lambda_2]$ and λ_1, λ_2 are products of the same primes over this field (i.e., primes in the subring generated by the algebraic integers in the field). The example mentioned above shows that λ itself is not an invariant, and the purpose of this chapter is to show that λ itself is not an invariant in more interesting examples of matrices of type (5.47),

$$(6.1) \quad J = \begin{pmatrix} m_1 & 1 & 0 & \cdots & 0 & 0 \\ m_2 & 0 & 1 & \cdots & 0 & 0 \\ \vdots & & \ddots & \ddots & \vdots & \vdots \\ m_{N-2} & 0 & & \ddots & 1 & 0 \\ m_{N-1} & 0 & 0 & & 0 & 1 \\ m_N & 0 & 0 & \cdots & 0 & 0 \end{pmatrix},$$

where the m_i are nonnegative integers, $m_N \neq 0$ and $\gcd\{i \mid m_i \neq 0\} = 1$. The characteristic polynomial of J is

$$(6.2) \quad \det(t\mathbf{1} - J) = t^N - m_1 t^{N-1} - m_2 t^{N-2} - \cdots - m_{N-1} t - m_N$$

and the Perron–Frobenius eigenvalue λ is the unique positive solution of this equation.

More examples of this kind where the J ’s are 2×2 matrices can be constructed by a machine developed in Chapter 13; see in particular Example 13.5 and remarks prior to Proposition 13.4.

The example we shall give here is a modification of another example in [13, Example 9]. For $a = 2, 3, 4, \dots$, consider the monic polynomial

$$(6.3) \quad p_a(t) = (t - a^2)(t^2 + at + a^2) = t^3 + (-a^2 + a)t^2 + (-a^3 + a^2)t - a^4.$$

The last three coefficients are negative for $a = 2, 3, \dots$, so this is the characteristic polynomial of

$$(6.4) \quad J = \begin{pmatrix} a^2 - a & 1 & 0 \\ a^3 - a^2 & 0 & 1 \\ a^4 & 0 & 0 \end{pmatrix}.$$

The spectrum of J_a consists of the roots

$$(6.5) \quad \text{sp}(J_a) = \left\{ a^2, \left(-\frac{1}{2} + \frac{i}{2}\sqrt{3} \right) a, \left(-\frac{1}{2} - \frac{i}{2}\sqrt{3} \right) a \right\}$$

and hence we observe

$$(6.6) \quad \text{sp}(J_{a^2}) = \{ \lambda^2 \mid \lambda \in \text{sp}(J_a) \}.$$

Thus J_{a^2} and J_a^2 are conjugate over $\mathbb{Q}[\sqrt{3}]$, and hence over \mathbb{Q} . Now put

$$(6.7) \quad K = J_2 = \begin{pmatrix} 2 & 1 & 0 \\ 4 & 0 & 1 \\ 16 & 0 & 0 \end{pmatrix}, \quad J = J_4 = \begin{pmatrix} 12 & 1 & 0 \\ 48 & 0 & 1 \\ 256 & 0 & 0 \end{pmatrix}.$$

Then we compute that

$$(6.8) \quad JT = TK^2$$

for

$$(6.9) \quad T = \begin{pmatrix} 1 & 0 & 0 \\ -4 & 2 & 1 \\ 0 & 16 & -4 \end{pmatrix}.$$

Let

$$(6.10) \quad S = T^{-1} = \begin{pmatrix} 1 & 0 & 0 \\ \frac{2}{3} & \frac{1}{6} & \frac{1}{24} \\ \frac{8}{3} & \frac{2}{3} & -\frac{1}{12} \end{pmatrix}.$$

It follows from (6.8) that

$$(6.11) \quad SJ = K^2S.$$

For a given $n \in \mathbb{N}$, put

$$(6.12) \quad A = K^{2n}S = SJ^n, \quad B = T.$$

It follows from (6.8), (6.11), and $ST = TS = \mathbf{1}$ that

$$(6.13) \quad J^n = TSJ^n = BA, \quad K^{2n} = K^{2n}ST = AB.$$

This is a version of (5.51) except that A, B are not necessarily matrices with positive integer matrix elements, only rational elements. To remedy this we now replace J, K by scaled versions

$$(6.14) \quad K_d = \begin{pmatrix} 2d & 1 & 0 \\ 4d^2 & 0 & 1 \\ 16d^3 & 0 & 0 \end{pmatrix}, \quad J_d = \begin{pmatrix} 12d^2 & 1 & 0 \\ 48d^4 & 0 & 1 \\ 256d^6 & 0 & 0 \end{pmatrix},$$

where d is an integer. One now checks that the eigenvalues of both K_d^2 and J_d are

$$(6.15) \quad 16d^2, \quad 4 \left(-\frac{1}{2} \pm \frac{i}{2} \sqrt{3} \right) d^2,$$

and then

$$(6.16) \quad J_d T_d = T_d K_d^2, \quad S_d J_d = K_d^2 S_d,$$

with

$$(6.17) \quad T_d = \begin{pmatrix} 1 & 0 & 0 \\ -4d^2 & 2d & 1 \\ 0 & 16d^3 & -4d^2 \end{pmatrix}, \quad S_d = T_d^{-1} = \begin{pmatrix} 1 & 0 & 0 \\ \frac{2}{3}d & \frac{1}{6d} & \frac{1}{24d^3} \\ \frac{8}{3}d^2 & \frac{2}{3} & -\frac{1}{12d^2} \end{pmatrix}.$$

With this change, we note that K_d^n is a multiple of an arbitrary large power of d with an integer matrix provided n is large enough. Taking $n = 4$ we compute

$$(6.18) \quad K_d^4 S_d = \begin{pmatrix} 192d^4 & 12d^2 & 1 \\ \frac{1184}{3}d^5 & \frac{80}{3}d^3 & \frac{2}{3}d \\ \frac{2432}{3}d^6 & \frac{128}{3}d^4 & \frac{8}{3}d^2 \end{pmatrix}.$$

Choosing $d = 3$ we see that

$$(6.19) \quad A = K_3^4 S_3 = S_3 J_3^2$$

is a positive integer matrix. Similarly

$$(6.20) \quad T_d K_d^4 = \begin{pmatrix} 144d^4 & 40d^3 & 8d^2 \\ 640d^6 & 96d^5 & 48d^4 \\ 2048d^8 & 512d^7 & 256d^6 \end{pmatrix}$$

is a positive integer matrix whatever integer value d has, and we put

$$(6.21) \quad B = T_3 K_3^4 = J_3^2 T_3.$$

Now, redefining

$$(6.22) \quad K := K_3 = \begin{pmatrix} 6 & 1 & 0 \\ 36 & 0 & 1 \\ 432 & 0 & 0 \end{pmatrix}, \quad J := J_3 = \begin{pmatrix} 108 & 1 & 0 \\ 3888 & 0 & 1 \\ 186624 & 0 & 0 \end{pmatrix},$$

it follows from (6.16), (6.17), (6.19), and (6.21) that

$$(6.23) \quad \begin{aligned} AJ &= K^2 A, \\ JB &= BK^2, \\ J^4 &= BA, \\ K^8 &= AB. \end{aligned}$$

Thus, J and K^2 are shift equivalent in the sense of (5.52), and in particular, J and K define isomorphic AF-algebras by (5.51). But the Perron–Frobenius eigenvalues of these matrices are $16d^2 = 12^2 = 144$ and $4d = 12$, respectively. Hence this eigenvalue in itself is not an isomorphism invariant.

CHAPTER 7

**The invariants N , D , $\text{Prim}(m_N)$, $\text{Prim}(R_D)$,
 $\text{Prim}(Q_{N-D})$**

In this chapter, we establish a triangular representation $J_L = \left(\begin{array}{c|c} J_0 & Q \\ \hline 0 & J_D \end{array} \right)$ of a matrix J_L in the standard form (7.2) such that the submatrices J_0 and J_D are again in the same standard form (with the exception that the integers corresponding to m_1, \dots, m_N are no longer necessarily positive), and $\ker(\tau)$ is obtained from J_0 the same way $K_0(\mathfrak{A}_L)$ is obtained from J_L . We then use this for the derivation of numerical C^* -isomorphism invariants.

Proposition 8.1, Corollary 8.3, and Theorem 7.5 below account for the terms $\mathbb{Z}[\frac{1}{k}]$ (where $k \in \mathbb{Z}$, $k \geq 2$) in $K_0(\mathfrak{A}_L)$ and in $\ker(\tau_L)$ when they are present, as they are in many examples; see, e.g., Examples 18.1 and 18.2. The convention regarding $L = (L_1, \dots, L_d)$ is as in Theorem 4.2. We assume $1 \leq L_1 \leq L_2 \leq \dots \leq L_d$, and we count the values of the L_i 's with multiplicity according to:

$$(7.1) \quad m_j := \#\{L_i \mid L_i = j\}$$

for $j = 1, \dots, N$ where $N := L_d$. Then the matrix $J = J_L$ takes the form

$$(7.2) \quad J_L = \begin{pmatrix} m_1 & 1 & 0 & \cdots & 0 & 0 \\ m_2 & 0 & 1 & \cdots & 0 & 0 \\ m_3 & 0 & 0 & \ddots & 0 & 0 \\ \vdots & \vdots & & \ddots & \ddots & \vdots \\ m_{N-1} & 0 & 0 & & 0 & 1 \\ m_N & 0 & 0 & \cdots & 0 & 0 \end{pmatrix}.$$

We always assume $\gcd\{i \mid m_i \neq 0\} = 1$. With this convention, we have $m_N \geq 1$. Let $a := e^{-\beta}$ where β is the unique solution to

$$(7.3) \quad \sum_i e^{-\beta L_i} = \sum_j m_j e^{-\beta j} = 1.$$

As explained in (5.15)–(5.18), $\lambda := e^\beta$ is the Perron–Frobenius eigenvalue for J_L .

The results in this chapter are somewhat technical. The matrix J is given a representation which admits a triangular form $\left(\begin{array}{c|c} J_0 & Q \\ \hline 0 & R \end{array} \right)$ where J_0 and R have the same type (7.2) as J , and Q is of rank one (see Theorem 7.5). Hence it is easy to read off the determinants of J and J_0 . We use this to show that the prime factors of these determinants are C^* -isomorphism invariants (Theorem 7.8).

Each lattice \mathbb{Z}^N is (linearly) isomorphic to the space \mathcal{V}_N of polynomials $f \in \mathbb{Z}[x]$ of degree $\leq N - 1$. This means that matrix multiplication by J_L in \mathbb{Z}^N is equivalent to an operation on the polynomials $\mathbb{Z}[x]$ of degree $\leq N - 1$. This operation can be described by the following explicit representation.

Lemma 7.1. *Define*

$$(7.4) \quad \mathcal{V}_N := \{f(x) \in \mathbb{Z}[x] \mid \deg f \leq N - 1\}.$$

Let

$$(7.5) \quad f_m(x) := m_1 + m_2x + \cdots + m_Nx^{N-1}.$$

Then matrix multiplication by J in \mathbb{Z}^N induces the following operation \tilde{J} on \mathcal{V}_N :

$$(7.6) \quad (\tilde{J}f)(x) = f(0)f_m(x) + \frac{f(x) - f(0)}{x}, \quad f \in \mathcal{V}_N.$$

Proof. For $k = (k_1, \dots, k_N) \in \mathbb{Z}^N$, let $f_k(x) = k_1 + k_2x + \cdots + k_Nx^{N-1}$. Then

$$\begin{aligned} (\tilde{J}f_k)(x) &= f_{Jk}(x) \\ &= m_1k_1 + k_2 + (m_2k_1 + k_3)x + \cdots \\ &\quad + (m_{N-1}k_1 + k_N)x^{N-2} + m_Nk_1x^{N-1} \\ &= k_1 \sum_{i=1}^N m_i x^{i-1} + \sum_{j=2}^N k_j x^{j-2} \\ &= f_k(0)f_m(x) + \frac{f_k(x) - f_k(0)}{x}, \end{aligned}$$

which proves the lemma. \square

The construction of $K_0(\mathfrak{A}_L)$ and $\ker(\tau_L)$ involves the Frobenius eigenvector $\alpha = (\alpha_1, \alpha_2, \dots, \alpha_N)$ which solves

$$(7.7) \quad \alpha J = \lambda \alpha$$

where $\lambda = e^\beta$ is the Frobenius eigenvalue. (See (5.8).)

Lemma 7.2. *Let $a := \lambda^{-1} = e^{-\beta}$. When normalized with $\alpha_1 = 1$, the eigenvector α from (7.7) is*

$$(7.8) \quad \alpha = (1, a, a^2, \dots, a^{N-1}).$$

Proof. This was verified in (5.17). \square

Lemma 7.3. *Let $\alpha = (1, a, \dots, a^{N-1})$ be the Frobenius eigenvector, and let*

$$p_a(x) \in \mathbb{Z}[x]$$

be the minimal polynomial of $a = e^{-\beta}$. With the identification

$$\mathbb{Z}^N \cong \mathcal{V}_N = \{f \in \mathbb{Z}[x] \mid \deg f \leq N - 1\},$$

as in (7.4), the following two conditions are equivalent for $k = (k_1, \dots, k_N) \in \mathbb{Z}^N$:

- (i) $k \in \{\alpha\}^\perp$.
- (ii) $p_a(x) \mid f_k(x)$, where $f_k(x) = \sum_{i=1}^N k_i x^{i-1}$.

Proof. We have

$$(7.9) \quad \langle k | \alpha \rangle = \sum_{i=1}^N k_i a^{i-1} = f_k(a),$$

showing that $f_k(a) = 0$ if and only if $k \in \{\alpha\}^\perp$. But $f_k(x)$ is divisible by $p_a(x)$ if and only if a is a root. \square

Corollary 7.4. *If $D := \text{degree of } p_a \leq N - 1$, then the subgroup $\{\alpha\}^\perp \cap \mathbb{Z}^N$ may be represented in the form*

$$\{q(x)p_a(x) \mid q(x) \in \mathcal{V}_{N-D}\}.$$

If $D = N$, then $\{\alpha\}^\perp \cap \mathbb{Z}^N = \{0\}$. In any case, J leaves $\{\alpha\}^\perp \cap \mathbb{Z}^N$ invariant, and if $D \leq N - 1$, J induces an operator $q \mapsto J_0(q)$ on \mathcal{V}_{N-D} by

$$(7.10) \quad J(qp_a)(x) = (J_0q)(x)p_a(x), \quad q \in \mathcal{V}_{N-D}.$$

Proof. The representation $q(x)p_a(x)$ is unique since $p_a(x)$ is irreducible. To see that $\{\alpha\}^\perp \cap \mathbb{Z}^N$ is invariant under J , use (7.7) directly, or substitute $x = a$ into (7.6) as follows: If $f \in \mathbb{Z}[x]$ satisfies $f(a) = 0$, then

$$(\tilde{J}f)(a) = f(0)f_m(a) + \frac{f(a) - f(0)}{a} = f(0)a^{-1} - f(0)a^{-1} = 0,$$

where we used the identity $f_m(a) = a^{-1}$ which in turn is equivalent to (7.3). \square

We need one more prelude to the main theorem of this chapter. As in Lemma 7.3, let $p_a \in \mathbb{Z}[x]$ be the minimal polynomial of $a = e^{-\beta}$, and let p_λ be the minimal polynomial of the Perron–Frobenius eigenvalue $\lambda = 1/a = e^\beta$. It is clear that these polynomials have the same degree D , and up to a sign

$$(7.11) \quad p_\lambda(x) = x^D p_a\left(\frac{1}{x}\right), \quad p_a(x) = x^D p_\lambda\left(\frac{1}{x}\right).$$

Since λ is a root of the monic polynomial (10.10) in $\mathbb{Z}[x]$, it follows that p_λ is a monic polynomial, and hence the constant term in $p_a(x)$ is ± 1 , i.e.,

$$(7.12) \quad p_a(0) \in \{\pm 1\}.$$

(This also follows from (4.31), or (5.48).) We will often fix the normalization of p_a such that $p_a(0) = 1$.

Theorem 7.5. *Let J be a matrix of the form (7.2) with the m_i positive integers, $m_N \neq 0$, $\text{gcd}\{i \mid m_i \neq 0\} = 1$. Normalize the minimal polynomial $p_a(x)$ by $p_a(0) = 1$. Decompose the polynomial $f_m(x) = m_1 + m_2x + \cdots + m_Nx^{N-1}$, given in (7.5), by the Euclidean algorithm, yielding*

$$(7.13) \quad f_m(x) = q_m(x)p_a(x) + r_m(x),$$

where $q_m(x) = \sum_{k=1}^{N-D} Q_k x^{k-1}$, $r_m(x) = \sum_{k=1}^D R_k x^{k-1}$. It follows that, in the basis

$$(7.14) \quad \{p_a(x), xp_a(x), \dots, x^{N-D-1}p_a(x), 1, x, \dots, x^{D-1}\}$$

for $\mathbb{Z}^N \cong \mathcal{V}_N$, the operator J is given by

$$(7.15) \quad J = \left(\begin{array}{cccccc|cccc} Q_1 & 1 & 0 & \cdots & 0 & 0 & Q_1 & 0 & 0 & \cdots & 0 & 0 \\ Q_2 & 0 & 1 & \cdots & 0 & 0 & Q_2 & 0 & 0 & \cdots & 0 & 0 \\ Q_3 & 0 & 0 & \ddots & 0 & 0 & Q_3 & 0 & 0 & \cdots & 0 & 0 \\ \vdots & \vdots & & \ddots & \ddots & \vdots & \vdots & \vdots & \vdots & \ddots & \vdots & \vdots \\ Q_{N-D-1} & 0 & 0 & & 0 & 1 & Q_{N-D-1} & 0 & 0 & \cdots & 0 & 0 \\ Q_{N-D} & 0 & 0 & \cdots & 0 & 0 & Q_{N-D} & 0 & 0 & \cdots & 0 & 0 \\ \hline 0 & & \cdots & & 0 & & R_1 & 1 & 0 & \cdots & 0 & 0 \\ & & & & & & R_2 & 0 & 1 & \cdots & 0 & 0 \\ \vdots & & & & & & R_3 & 0 & 0 & \ddots & 0 & 0 \\ & & & & & & \vdots & \vdots & & \ddots & \ddots & \vdots \\ & & & & & & R_{D-1} & 0 & 0 & & 0 & 1 \\ 0 & & \cdots & & 0 & & R_D & 0 & 0 & \cdots & 0 & 0 \end{array} \right).$$

In the extreme case $D = N$, the upper left-hand matrix in (7.15) disappears, and the lower right-hand matrix is just (7.2). If $D = N - 1$, the upper left-hand matrix is (Q_1) , and if $D = 1$, the lower right-hand matrix is $(R_1) = (R_D)$. In general, the coefficients R_1, \dots, R_D can be computed from the formula

$$(7.16) \quad r_m(x) = \frac{1 - p_a(x)}{x}.$$

(Without the normalization $p_a(0) = 1$, the upper left-hand matrix elements Q_i must be replaced by $p_a(0)Q_i$ where $p_a(0) \in \{\pm 1\}$.)

Proof. We leave the modifications needed to cope with the extremal cases $D = N, N - 1, 1$ to the reader, and consider the generic situation $1 < D < N - 1$. We use formula (7.6) in calculating J in the basis defined from Lemma 7.3 and Corollary 7.4. Define

$$(7.17) \quad e_j := x^j p_a(x), \quad j = 0, \dots, N - D - 1.$$

Then $\{e_j\}$ is a basis for $\{\alpha\}^\perp \cap \mathbb{Z}$ by Lemma 7.3. Furthermore,

$$\begin{aligned} J(e_0) &= J(p_a) = p_a(0) f_m(x) + \frac{p_a(x) - p_a(0)}{x} \\ &= p_a(0) q_m(x) p_a(x) + \underbrace{\left(p_a(0) r_m(x) + \frac{p_a(x) - p_a(0)}{x} \right)}_{\text{remainder}}. \end{aligned}$$

Since $\deg((p_a(x) - p_a(0))/x) < D$ it follows from Corollary 7.4 that the remainder is zero (this accounts for (7.16)), and

$$J(e_0) = p_a(0) q_m(x) p_a(x) = p_a(0) \sum_{j=1}^{N-D} Q_j e_{j-1},$$

which accounts for the upper left column in (7.15) via formula (7.13). Since for $j > 0$

$$J(x^j p_a) = 0 + \frac{x^j p_a - 0}{x} = x^{j-1} p_a,$$

the rest of the left half of the matrix (7.15) is accounted for.

For the rest of the entries in the formula (7.15) for J , pick the monomials $1, x, \dots, x^{D-1}$ as a basis for the remainder terms in the Euclidean representation of $\mathbb{Z}^N \cong \mathcal{V}_N$. Using again (7.6), we get

$$J(1) = f_m(x) = q_m(x) p_a(x) + r_m(x),$$

which accounts for the $(N - D + 1)$ 'st column in (7.15).

For j such that $0 < j < D$ we have, using (7.6):

$$J(x^j) = 0 + \frac{x^j - 0}{x} = x^{j-1},$$

and that accounts for the remaining columns in (7.15). \square

Corollary 7.6. *Assume $1 \leq D \leq N - 1$. Then the relationship between the determinants of J and the restriction J_0 of J to $\{\alpha\}^\perp \cap \mathbb{Z}^N$ is given by*

$$(7.18) \quad \det(J) = (-1)^{D-1} R_D \det(J_0) = (-1)^{N-1} m_N,$$

and

$$(7.19) \quad \det(J_0) = (-1)^{N-D-1} p_a(0) Q_{N-D},$$

and therefore

$$(7.20) \quad p_a(0) Q_{N-D} = (-1)^D \frac{m_N}{R_D},$$

which implies that $Q_{N-D} \neq 0$.

Proof. Use the standard rules for computing determinants on (7.15), and use (7.13). \square

Note that the number m_N is *not* an isomorphism invariant. See, for example, (6.22)–(6.23), or let us consider the following example from [13, Proposition 5 and following remark]. If

$$(7.21) \quad J = \begin{pmatrix} 4 & 1 \\ 32 & 0 \end{pmatrix}, \quad J' = \begin{pmatrix} 6 & 1 \\ 16 & 0 \end{pmatrix},$$

then in both cases the dimension group G_J (resp. $G_{J'}$) is $\mathbb{Z} \left[\frac{1}{2} \right] \oplus \mathbb{Z} \left[\frac{1}{2} \right]$ with order given by $(x, y) > 0 \iff 8x + y > 0$. Furthermore, $a = \frac{1}{8}$, so the minimal polynomial is $p_a(x) = 8x - 1$ in both cases. Clearly $m_2 = 32$ for J and $m'_2 = 16$ for J' , so $m_N = m_2$ is not an invariant. But, as

$$4 + 32x = 4p_a(x) + 8, \quad 6 + 16x = 2p_a(x) + 8$$

we have $R_1 = 8$ for both J and J' , so this does not *a priori* rule out that R_D is an invariant. This is, however, ruled out by (6.22), where R_D has the value 144, 12 for the two matrices respectively. We will in fact prove in Theorem 7.8 that the sets of prime factors of m_N , R_D , respectively, are invariants. See (10.11) and Figure 15 for more on (7.21).

Proposition 7.7. *Let (J, \mathbb{Z}^N) , $D = \deg(p_a)$, and the trace $\tau(\cdot) = \langle \cdot | \alpha \rangle$ be as described in Theorem 7.5 and (5.20). Let J_0 denote the restriction of J to $\{\alpha\}^\perp \cap \mathbb{Z}^N \cong \mathbb{Z}^{N-D}$. Then*

$$(7.22) \quad \ker(\tau) = \bigcup_{n \geq 0} J_0^{-n}(\mathbb{Z}^{N-D}),$$

where the equality refers to the identification (7.17).

Proof. This proposition is essentially also true in the more general situation where J is a primitive nonsingular matrix. Using the standard basis for \mathbb{Z}^N , we saw in (5.3)-(5.6) that

$$K_0(\mathfrak{A}_L) = \bigcup_{m=1}^{\infty} J^{-m}(\mathbb{Z}^N).$$

But $g = J^{-m}(n)$ is in $\ker \tau$ if and only if (using (5.8) and (5.10)):

$$0 = \tau(g) = \tau(J^{-m}(n)) = \langle \alpha | J^{-m}n \rangle = \lambda^{-m} \langle \alpha | n \rangle,$$

i.e., if and only if $n \in \mathbb{Z}^N \cap \{\alpha\}^\perp$, that is,

$$J^{-m}(n) \cap \ker \tau = J^{-m}(\mathbb{Z}^N \cap \{\alpha\}^\perp).$$

Using the basis (7.14) in Theorem 7.5, this is (7.18). More specifically, we saw in (7.15) of Theorem 7.5 that J takes the block form $\left(\begin{array}{c|c} J_0 & Q \\ \hline 0 & J_R \end{array} \right)$ relative to the decomposition

$$(7.23) \quad \mathbb{Z}^N \cong L_0 \oplus \mathbb{Z}^D, \quad L_0 = \mathbb{Z}^{N-D}.$$

The submatrices J_0 and J_R are both invertible in dimensions $N-D$ and D , respectively. Moreover (7.15) shows that each of the submatrices J_0 and J_R has a form which is similar to that of J itself. The $(N-D) \times D$ matrix Q was also computed in (7.15). For J^{-1} , we therefore have the formula

$$(7.24) \quad J^{-1} = \left(\begin{array}{c|c} J_0^{-1} & -J_0^{-1}QJ_R^{-1} \\ \hline 0 & J_R^{-1} \end{array} \right)$$

and, similarly,

$$(7.25) \quad J^{-n} = \left(\begin{array}{c|c} J_0^{-n} & * \quad * \\ \hline 0 & J_R^{-n} \end{array} \right).$$

□

Theorem 7.8. *The following numbers and sets of primes are isomorphism invariants for the AF-algebras \mathfrak{A}_L , where the members of L satisfy the hypothesis in Theorem 4.2:*

- (i) N , i.e., L_d ,
- (ii) the set of prime factors of m_N ,
- (iii), resp. (iii)', the set of prime factors of Q_{N-D} , resp. R_D , the coefficient in the highest-order term in $q_m(x)$, resp. $r_m(x)$, where

$$(7.26) \quad m_1 + m_2x + \cdots + m_Nx^{N-1} = q_m(x)p_a(x) + r_m(x),$$

and

(iv) $D = \deg(p_a)$.

The invariants can be read off from the following commutative diagram:

$$(7.27) \quad \begin{array}{cccccccc} & 0 & & 0 & & 0 & & 0 \\ & \downarrow & & \downarrow & & \downarrow & & \downarrow \\ \mathbb{Z}^{N-D} & \xrightarrow{J_0} & \mathbb{Z}^{N-D} & \xrightarrow{J_0} & \mathbb{Z}^{N-D} & \xrightarrow{J_0} & \dots & \xrightarrow{\text{ind}} \ker(\tau) \\ & \downarrow & & \downarrow & & \downarrow & & \downarrow \\ \mathbb{Z}^N & \xrightarrow{J} & \mathbb{Z}^N & \xrightarrow{J} & \mathbb{Z}^N & \xrightarrow{J} & \dots & \xrightarrow{\text{ind}} K_0(\mathfrak{A}) \\ & \downarrow & & \downarrow & & \downarrow & & \downarrow \\ \mathbb{Z}^D & \xrightarrow{J_R} & \mathbb{Z}^D & \xrightarrow{J_R} & \mathbb{Z}^D & \xrightarrow{J_R} & \dots & \xrightarrow{\text{ind}} \mathbb{Z}[\lambda^{-1}] \\ & \downarrow & & \downarrow & & \downarrow & & \downarrow \\ & 0 & & 0 & & 0 & & 0 \end{array}$$

where the vertical sequences of maps are short exact sequences, and the horizontal maps are injective, and where J has the form (7.15), $J = \left(\begin{array}{c|c} J_0 & Q \\ \hline 0 & J_R \end{array} \right)$. This picture is also valid when J is a general nonsingular primitive $N \times N$ matrix, except that J_0 , Q , J_R do not then have the special form in Theorem 7.5. Nevertheless, N , D , $\text{Prim}(\det J)$, $\text{Prim}(\det J_0)$, $\text{Prim}(\det J_R)$ are still invariants for stable C^* -isomorphism, where $\text{Prim}(n)$ denotes the set of prime factors of n for any $n \in \mathbb{Z} \setminus \{0\}$.

Remark 7.9. The Prim-invariants are independent in the following sense: In Chapter 16, we give examples J, J' for the same fixed values of N and D where

$$\text{Prim}(Q_{N-D}) = \text{Prim}(Q'_{N-D})$$

but

$$\text{Prim}(R_D) \neq \text{Prim}(R'_D);$$

and also examples with

$$\begin{cases} \text{Prim}(m_N) = \text{Prim}(m'_{N'}) \\ \text{Prim}(R_D) = \text{Prim}(R'_D) \end{cases}$$

but

$$\text{Prim}(Q_{N-D}) \neq \text{Prim}(Q'_{N-D}).$$

Proof of Theorem 7.8. (i) We have already commented that $N = L_d$ is the rank of the group $K_0(\mathfrak{A}_L)$, so N is an isomorphism invariant.

(ii) If $n \in \mathbb{N}$, let again $\text{Prim}(n)$ denote the set of prime factors of n , with the convention $\text{Prim}(1) = \emptyset$. If \mathfrak{A}_L and $\mathfrak{A}_{L'}$ are isomorphic, it follows from (5.51) by taking the determinant on both sides that

$$(7.28) \quad \begin{aligned} \text{Prim}(m_N) &= \text{Prim}(|\det(B_i)|) \cup \text{Prim}(|\det(A_i)|), \\ \text{Prim}(m'_{N'}) &= \text{Prim}(|\det(A_{i+1})|) \cup \text{Prim}(|\det(B_i)|), \\ \text{Prim}(m_N) &= \text{Prim}(|\det(B_{i+1})|) \cup \text{Prim}(|\det(A_{i+1})|), \\ \text{Prim}(m'_{N'}) &= \text{Prim}(|\det A_{i+2}|) \cup \text{Prim}(|\det B_{i+1}|), \end{aligned}$$

where we used Corollary 7.6. Hence

$$\text{Prim}(m'_{N'}) \subseteq \text{Prim}(m_N) \subseteq \text{Prim}(m'_{N'})$$

so

$$(7.29) \quad \text{Prim}(m'_{N'}) = \text{Prim}(m_N).$$

Thus in particular $\text{Prim}(m_N)$ is an isomorphism invariant, as claimed.

As the exact sequence

$$(7.30) \quad 0 \longrightarrow \ker \tau \hookrightarrow K_0(\mathfrak{A}_L) \longrightarrow \tau(K_0(\mathfrak{A}_L)) \longrightarrow 0$$

is uniquely determined by the dimension group $(K_0(\mathfrak{A}_L), K_0(\mathfrak{A}_L)_+)$, the group $\ker \tau$ is an isomorphism invariant. But if J_0 denotes the restriction of J to $\ker \tau = \mathbb{Z}^N \cap \{\alpha\}^\perp$, then J_0 identifies with the upper left-hand part of the matrix (7.15). But $Q_{N-D} \neq 0$ by Corollary 7.6 and hence $\det J_0 \neq 0$ by (7.19). It follows from Proposition 7.7 that $N - D = \text{rank}(\ker \tau)$ is an isomorphism invariant and thus D is so. Thus (iv) is proved. Furthermore, if J' is another nonsingular primitive incidence matrix defining the same dimension group as J , it follows from Proposition 7.7 that

$$(7.31) \quad \bigcup_{n \geq 0} (J'_0)^{-n} (\mathbb{Z}^{N-D}) \cong \bigcup_{n \geq 0} J_0^{-n} (\mathbb{Z}^{N-D})$$

and thus J_0 and J'_0 are related as J_L and $J_{L'}$ in (5.51), except that the B_i, A_i now are just (necessarily nonsingular) integer matrices, without any positivity. (See an elaboration of this in the following paragraph.) But positivity did not play any role in the first part of the present proof, and hence

$$\text{Prim}(|\det J_0|) = \text{Prim}(|\det J'_0|).$$

But $|\det J_0| = |Q_{N-D}|$ and $|\det J'_0| = |Q'_{N-D}|$, so $\text{Prim}(Q_{N-D})$ is an isomorphism invariant, which shows (iii).

By [32], the groups $K_0(\mathfrak{A}(J_L))$ and $K_0(\mathfrak{A}(J_{L'}))$ are order isomorphic. Let θ be the corresponding order isomorphism. It follows from (5.34) that θ restricts to an isomorphism of $\ker(\tau)$ onto $\ker(\tau')$. We have shown in Proposition 7.7 that $\ker(\tau)$ is constructed from J_0 the same way $K_0(\mathfrak{A}(J_L))$ is gotten from J_L as an inductive limit. Now apply (7.22) to both $\ker(\tau)$ and $\ker(\tau')$. Then the argument from (5.51) yields

$$\begin{aligned} J_0^{k_i} &= C_i E_i, \\ (J'_0)^{l_i} &= E_{i+1} C_i, \end{aligned}$$

where $k_1, k_2, \dots, l_1, l_2, \dots$ are natural numbers, and the matrices C_1, C_2, \dots and E_1, E_2, \dots are $(N - D) \times (N - D)$ over \mathbb{Z} .

The argument which yields $\ker(\tau)$ as the inductive limit $\bigcup_{n \geq 0} J_0^{-n} \mathbb{Z}^{N-D}$ in (7.22) also yields the following associated isomorphism:

$$(7.32) \quad K_0(\mathfrak{A}_L) / \ker(\tau) \cong \bigcup_{n \geq 0} J_0^{-n} \mathbb{Z}^D.$$

This follows by general category theory from the commutativity of the diagram (7.27) and exactness of the vertical short exact sequences of this diagram. Let us elaborate on this: Use induction, and (7.22) for $\ker(\tau)$, starting with the obvious isomorphism

$$\mathbb{Z}^N / \mathbb{Z}^{N-D} \cong \mathbb{Z}^D$$

given by

$$\begin{pmatrix} \mathbb{Z}^{N-D} \\ \mathbb{Z}^D \end{pmatrix} \ni \begin{pmatrix} k \\ l \end{pmatrix} \mapsto l \in \mathbb{Z}^D,$$

and arriving at

$$(7.33) \quad J^{-n} \begin{pmatrix} k \\ l \end{pmatrix} \xrightarrow{\rho_n} J_R^{-n} l.$$

Since

$$(7.34) \quad J^{-n} \begin{pmatrix} k \\ l \end{pmatrix} = \begin{pmatrix} J_0^{-n} k + Q_n^* l \\ J_R^{-n} l \end{pmatrix}$$

for a suitable matrix Q_n^* by (7.25), we get

$$(7.35) \quad J^{-n} \mathbb{Z}^N / J_0^{-n} \mathbb{Z}^{N-D} \cong J_R^{-n} \mathbb{Z}^D$$

with the isomorphism induced by ρ_n of (7.33). It is an isomorphism, for if $J_R^{-n} l = 0$ then $l = 0$ since J_R is nonsingular. So then

$$J^{-n} \begin{pmatrix} k \\ 0 \end{pmatrix} = \begin{pmatrix} J_0^{-n} k \\ 0 \end{pmatrix}$$

by (7.34). This proves (7.35).

By (7.27), we get

$$K_0(\mathfrak{A}_L) / \ker(\tau) \cong \left(\text{the inductive limit} \right. \\ \left. \text{constructed from } J^{-n} \mathbb{Z}^N / J_0^{-n} \mathbb{Z}^{N-D} \right),$$

and so

$$K_0(\mathfrak{A}_L) / \ker(\tau) \cong \text{ind}_n J_R^{-n} \mathbb{Z}^D \\ = \bigcup_{n \geq 0} J_R^{-n} \mathbb{Z}^D$$

by (7.35). To see this, we must also check that the defining homomorphism (7.33) does indeed pass to the respective inductive limit groups $\bigcup_{n \geq 0} J^{-n} \mathbb{Z}^N$ and $\bigcup_{n \geq 0} J_R^{-n} \mathbb{Z}^D$. But note that

$$J^{-n} \begin{pmatrix} k \\ l \end{pmatrix} = J^{-(n+1)} \begin{pmatrix} J_0 k + Q l \\ J_R l \end{pmatrix}$$

and the right-hand side is mapped into

$$J_R^{-(n+1)} J_R l = J_R^{-n} l$$

under ρ_{n+1} from (7.33). So we have the commutative diagram

$$\begin{array}{ccc} J^{-n} \mathbb{Z}^N & \hookrightarrow & J^{-(n+1)} \mathbb{Z}^N \\ \searrow \rho_n & & \swarrow \rho_{n+1} \\ & J_R^{-n} \mathbb{Z}^D & \end{array}$$

of homomorphisms of abelian groups. As a result, there is an induced homomorphism of the respective inductive limit groups

$$K_0(\mathfrak{A}_J) \xrightarrow{\rho} \bigcup_{n \geq 0} J_R^{-n} \mathbb{Z}^D,$$

where $J = J_L$ for short. The formula (7.34) shows that

$$\ker(\rho) \cong \bigcup_{n \geq 0} J_0^{-n} \mathbb{Z}^{N-D} \cong \ker(\tau)$$

where we used (7.22) in the last step. Hence, by the homomorphism theorem, we have

$$K_0(\mathfrak{A}_J) / \ker(\tau) \cong \bigcup_{n \geq 0} J_R^{-n} \mathbb{Z}^D,$$

which is the assertion (7.32).

Let L and L' be as in Theorem 4.2 with associated matrices $J = J_L$ and $J' = J_{L'}$, and suppose the C^* -algebras \mathfrak{A}_L and $\mathfrak{A}_{L'}$ are isomorphic. The corresponding order isomorphism

$$\theta: K_0(\mathfrak{A}_L) \longrightarrow K_0(\mathfrak{A}_{L'})$$

therefore induces isomorphisms

$$\theta_{(\text{restriction})}: \ker(\tau) \longrightarrow \ker(\tau')$$

and

$$\theta_{(\text{quotient})}: K_0(\mathfrak{A}_L) / \ker(\tau) \longrightarrow K_0(\mathfrak{A}_{L'}) / \ker(\tau').$$

It follows further that $\theta_{(\text{quotient})}$ then induces an *isomorphism*

$$\bigcup_{n \geq 0} J_R^{-n} \mathbb{Z}^D \cong \bigcup_{n \geq 0} (J'_R)^{-n} \mathbb{Z}^D.$$

This makes sense since we have already concluded that $N = N'$ and $D = D'$. (Recall that $N - D = \text{rank}(\ker(\tau))$.)

Now the argument after (7.31) applies to J_R and J'_R , the same way as we used it to get identity of the sets of primes for $|\det J_0|$ and $|\det J'_0|$. Using finally

$$R_D = |\det J_R|, \quad R'_D = |\det J'_R|,$$

we conclude that

$$\text{Prim}(R_D) = \text{Prim}(R'_D),$$

which is the claim. The final statement of Theorem 7.8 is clear from the proof in the special case that J has the form (7.2). The only thing that separates the general case from the special one is the special form of J_0 , Q , J_R in (7.15), and thus the formulae $|\det(J)| = m_N$, $|\det(J_0)| = |Q_{N-D}|$ and $|\det J_R| = |R_D|$. \square

Corollary 7.10. *Assume that J satisfies the hypotheses of Theorem 7.5 and let λ be the Perron–Frobenius eigenvalue of J . Define J_R as in the proof of Proposition 7.7.*

- (i) *There is a natural isomorphism between the two (unordered) groups $\mathbb{Z}[\frac{1}{\lambda}]$ and $\text{ind}(J_R) = \bigcup_{n \geq 0} J_R^{-n} \mathbb{Z}^D$.*
- (ii) *If $\alpha_D := (1, 1/\lambda, \dots, 1/\lambda^{D-1})$, so that $\alpha_D J_R = \lambda \alpha_D$, the isomorphism is determined by $\langle \alpha_D | \cdot \rangle$ as follows:*

$$\begin{array}{ccccccc} 0 & \longrightarrow & \text{ind}(J_R) & \longrightarrow & \mathbb{Z}[1/\lambda] & \longrightarrow & 0 \\ & & \downarrow & & \downarrow & & \\ & & \mathbb{Q}^D & \longrightarrow & \mathbb{R} & & \\ & & \Psi & & \Psi & & \\ & & v & \longmapsto & \langle \alpha_D | v \rangle & & \end{array}$$

where $\langle \cdot | \cdot \rangle$ is the usual inner product in \mathbb{R}^D .

Proof. The result follows from the equality $\tau(K_0(\mathfrak{A}_J)) = \mathbb{Z}[\frac{1}{\lambda}]$ in (5.22), and the natural isomorphism

$$\tau(K_0(\mathfrak{A}_J)) \cong K_0(\mathfrak{A}_J) / \ker(\tau) \cong \bigcup_{n \geq 0} J_R^{-n} \mathbb{Z}^D$$

coming from (7.27) in Theorem 7.8 above. See also (7.40)–(7.43) below. \square

Corollary 7.11. *If J , J' are two matrices of the form (7.2), one of them has a rational Perron–Frobenius eigenvalue, and they define isomorphic AF-algebras, then both the Perron–Frobenius eigenvalues λ , λ' are integral, and $R_D = \lambda$ and $R'_D = \lambda'$, so*

$$\text{Prim}(R_D) = \text{Prim}(\lambda) = \text{Prim}(\lambda') = \text{Prim}(R'_D).$$

Proof. If for example λ is rational then λ is integral since it is a solution of a monic polynomial. If J and J' define isomorphic AF-algebras, then it follows from [13, Theorem 10] that $\mathbb{Q}[\lambda'] = \mathbb{Q}[\lambda] = \mathbb{Q}$, i.e., λ' is rational and thus integral, and λ , λ' are products of the same primes, $\text{Prim}(\lambda) = \text{Prim}(\lambda')$. But in this case $p_a(x) = 1 - \lambda x$, and by (7.16) $r_m(x) = \lambda x/x = \lambda = R_D = R$. \square

Remark 7.12. If $g \in K_0(\mathfrak{A}_L) \subseteq \mathbb{Q}^N$ has coordinates $g^{\mathcal{A}} = (k_0, k_1, \dots, k_{N-1})$ relative to the old basis $\mathcal{A} = (1, x, \dots, x^{N-1})$ and coordinates $g^{\mathcal{B}} = (l_0, l_1, \dots, l_{N-1})$ relative to the new basis in Theorem 7.8, then g corresponds to the polynomial

$$(7.36) \quad p_g(x) = \sum_{i=0}^{N-1} k_i x^i = \sum_{i=0}^{N-D-1} l_i x^i p_a(x) + \sum_{i=N-D}^{N-1} l_i x^{i-N+D}.$$

If

$$(7.37) \quad p_a(x) = \sum_{m=0}^D a_m x^m,$$

we hence compute

$$(7.38) \quad p_g(x) = \sum_{j=0}^{N-1} \left(\sum_{i=(j-D) \vee 0}^{j \wedge (N-D-1)} a_{j-i} l_i \right) x^j + \sum_{j=0}^{D-1} l_{j+N-D} x^j,$$

and hence the transformation matrix between the new and the old coordinate system is

$$(7.39) \quad I_{\mathcal{B}}^{\mathcal{A}} = \begin{array}{c} 0 \\ 0 \\ \vdots \\ D-1 \\ D \\ \vdots \\ N-1 \\ 0 \end{array} \left(\begin{array}{cccccccccccc} & 0 & & & & & & & & & & N-D-1 & N-D & & & & N-1 \\ a_0 & 0 & 0 & \cdots & 0 & 0 & 1 & 0 & \cdots & 0 & 0 \\ a_1 & a_0 & 0 & \cdots & 0 & 0 & 0 & 1 & & 0 & 0 \\ \vdots & & & \ddots & & & \vdots & \vdots & \ddots & \vdots & \vdots \\ a_{D-1} & a_{D-2} & & & 0 & & & 0 & 0 & \cdots & 1 & & & & & & & \\ a_D & a_{D-1} & a_{D-1} & \cdots & a_0 & 0 & & & & 0 & \cdots & 0 & & & & & & \\ 0 & a_D & & & & \ddots & & & & \vdots & \vdots & & & & & & & \\ \vdots & & \ddots & & & & a_0 & 0 & & & & & & & & & & \\ & & & 0 & a_D & \cdots & a_2 & a_1 & a_0 & & & & & & & & & \\ & & & & 0 & & & a_2 & a_1 & & & & & & & & & \\ \vdots & & & & & \ddots & & & & \vdots & & & & & & & & \\ 0 & 0 & \cdots & 0 & a_D & a_{D-1} & \vdots & & & \vdots & & & & & & & & \\ 0 & 0 & \cdots & 0 & 0 & a_D & 0 & \cdots & 0 & & & & & & & & & \\ 0 & & & & & & & & & & & N-D-1 & N-D & & & & & N-1 \end{array} \right) \begin{array}{c} 0 \\ 0 \\ \vdots \\ D-1 \\ D \\ \vdots \\ N-1 \\ 0 \end{array} .$$

More interestingly, let us illustrate the power of the polynomial representation in the computation of the trace functional $\tau(g)$ in the new representation. Recall from Lemma 7.2 that

$$(7.40) \quad \tau(g) = \langle \alpha | g^{\mathcal{A}} \rangle = p_g(a).$$

If $\beta \in (\mathbb{R}^N)^*$ is the row vector such that

$$(7.41) \quad \tau(g) = \langle \beta | g^{\mathcal{B}} \rangle = \langle \beta | I_{\mathcal{A}}^{\mathcal{B}} g^{\mathcal{A}} \rangle$$

we have $\beta = \alpha I_{\mathcal{B}}^{\mathcal{A}} = \alpha (I_{\mathcal{A}}^{\mathcal{B}})^{-1}$. But note that

$$(7.42) \quad \tau(g) = p_a(a) = \sum_{i=0}^{N-1} k_i a^i = \sum_{i=0}^{N-D-1} l_i a^i p_a(a) + \sum_{i=N-D}^{N-1} l_i a^{i-N+D} = \sum_{i=0}^{N-1} l_i a^{i-N+D}$$

and hence

$$(7.43) \quad \beta = (0, 0, \dots, 0, \underset{0}{1}, \underset{N-D-1}{a}, \underset{N-D}{a^2}, \dots, \underset{N-1}{a^{D-1}})$$

gives the trace functional in the representation (7.14)–(7.15). This is useful in explicit computations of the dimension group from the formulae (5.19)–(5.20):

$$(7.44) \quad K_0(\mathfrak{A}_L) = \bigcup_{n=0}^{\infty} J^{-n} \mathbb{Z}^N,$$

which in the new representation becomes

$$(7.45) \quad K_0(\mathfrak{A}_L) = \bigcup_{n=0}^{\infty} (J_B^{\mathcal{B}})^{-n} I_A^{\mathcal{B}} \mathbb{Z}^N.$$

Here $J_B^{\mathcal{B}}$ is J in the alias (7.15) and $I_A^{\mathcal{B}} = (I_B^{\mathcal{A}})^{-1}$ where $I_B^{\mathcal{A}}$ is given in (7.39). Note that

$$(7.46) \quad |\det I_B^{\mathcal{A}}| = |a_D|^{N-D}$$

so $I_A^{\mathcal{B}} \mathbb{Z}^N$ is a lattice containing \mathbb{Z}^N as a proper sublattice if $|a_D| \neq 1$.

CHAPTER 8

The invariants $K_0(\mathfrak{A}_L) \otimes_{\mathbb{Z}} \mathbb{Z}_n$ and $(\ker \tau) \otimes_{\mathbb{Z}} \mathbb{Z}_n$ for $n = 2, 3, 4, \dots$

In this chapter we will mainly study invariants deducible from the groups $K_0(\mathfrak{A}_L) = G$ and $\ker \tau = G_0$ alone without the order structure. Of course any invariant associated to these groups will be an invariant of the algebra. For example viewing G as a \mathbb{Z} -module, the groups $G \otimes \mathbb{Z}_p$, for $p = 2, 3, \dots$, are invariants. We will also discuss structure on G coming from the embedding $\mathbb{Z}^N \hookrightarrow G$ given by (5.3)–(5.6) and the shift automorphism defined by G , but since this is extraneous structure it is not clear that it leads to invariants (the shift itself is not an invariant by the example (6.22)–(6.23)).

Both in the construction of $K_0(\mathfrak{A}_L)$, and in that of $\ker(\tau_L)$, the following inductive limit is involved:

$$(8.1) \quad \mathcal{L} \subseteq J^{-1}(\mathcal{L}) \subseteq J^{-2}(\mathcal{L}) \subseteq \dots$$

where \mathcal{L} is a lattice of the same rank as the matrix J . But both \mathcal{L} and J change in passing from $K_0(\mathfrak{A}_L)$ to $\ker(\tau_L)$ for the inductive limit construction.

We next show that quotients of these lattices, which are obviously finite groups, are necessarily *cyclic* when J is the original J_L .

Proposition 8.1. *The quotient*

$$(8.2) \quad J^{-(k+1)}(\mathcal{L}) / J^{-k}(\mathcal{L})$$

is isomorphic to the cyclic group $\mathbb{Z}_{m_N} = \mathbb{Z}/m_N\mathbb{Z}$ for each $k = 0, 1, \dots$

Proof. In general, if Γ is a lattice in \mathbb{R}^N and if M is an $N \times N$ matrix such that $M(\Gamma) \subseteq \Gamma$, then $\Gamma/M(\Gamma)$ is a finite abelian group of order $|\det(M)|$. See, e.g., [94, Proposition 5.5, p. 109]. Applying this to (8.2) for each k , we get that

$$(8.3) \quad A_k := J^{-(k+1)}\mathcal{L} / J^{-k}\mathcal{L}$$

has order $= |\det J| = m_N$. Note from Corollary 7.6 that

$$(8.4) \quad \det(J) = (-1)^{N-1} m_N.$$

A further calculation shows that the usual matrix multiplication, $\mathcal{L} \ni l \mapsto Jl$, induces an isomorphism of abelian groups $A_k \cong A_{k+1}$ for each k ; so, in proving cyclicity, it is enough to deal with $k = 0$ where the assertion amounts to the

Claim 8.2. There is an isomorphism

$$(8.5) \quad \mathbb{Z}^N / J\mathbb{Z}^N \longrightarrow \mathbb{Z}_{m_N}$$

given by

$$(8.6) \quad \begin{pmatrix} 0 \\ 0 \\ \vdots \\ 0 \\ i \end{pmatrix} + J\mathbb{Z}^N \mapsto i + m_N\mathbb{Z}, \quad i \in \mathbb{Z}.$$

Proof of Claim. Since $\mathbb{Z}^N / J\mathbb{Z}^N$ has order m_N it is enough to show that the lattice element $v_i := \begin{pmatrix} 0 \\ 0 \\ \vdots \\ 0 \\ i \end{pmatrix} = ie_N$ is in $J\mathbb{Z}^N$ if and only if the number i is divisible by m_N .

Hence, we must show that, if $i \in \mathbb{Z}$, then the equation $v_i = Jk$ is solvable in \mathbb{Z}^N if and only if $m_N | i$. But $k = J^{-1}(v_i) = iJ^{-1}(e_N)$ is a solution in \mathbb{R}^N ; in fact, the explicit formula is given by (4.30) or (5.49) as follows:

$$(8.7) \quad \begin{cases} k_1 = \frac{i}{m_N}, \\ k_2 = -m_1 \frac{i}{m_N}, \\ k_3 = -m_2 \frac{i}{m_N}, \\ \vdots \\ k_N = -m_{N-1} \frac{i}{m_N}. \end{cases}$$

This proves that $k \in \mathbb{Z}^N$ if and only if $m_N | i$ as claimed. \square

As mentioned, the claim proves Proposition 8.1. \square

This can be used to give a unique representation of elements $g \in G$.

Corollary 8.3. *Let G be the inductive limit group formed from (8.1).*

- (i) *In terms of the elements $v_i = ie_N$, $i = 1, \dots, m_N$, introduced in the proof of Claim 8.2, the following unique representation for points g in G is valid:*

$$(8.8) \quad g = l + J^{-1}v_{i_1} + J^{-2}v_{i_2} + \dots$$

where $l \in \mathcal{L}$, $i_1, i_2, \dots \in \{0, 1, \dots, m_N - 1\}$, and the sum is finite.

- (ii) *The \mathbb{Z}^N -coordinates of g in (8.8) are elements of $\mathbb{Z} \left[\frac{1}{m_N} \right]$.*
 (iii) *If g is represented as in (8.8) and $l = (l_1, \dots, l_N) \in \mathbb{Z}^N$, and the trace τ is given by the Frobenius eigenvector α in (7.8) as in (5.20), then*

$$(8.9) \quad \tau(g) = \sum_{j=1}^N l_j a^{j-1} + \sum_{k \geq 1} i_k a^{N+k-1}.$$

Proof. Follows directly from Proposition 8.1, Lemma 7.1, and Lemma 7.2. See in particular (8.7) and (5.3)–(5.6). \square

Remark 8.4. Note that the right-hand side of (8.9) is related to the β -expansion ($a = 1/\beta$, or $\beta = \lambda$) of the number $\tau(g)$ ([71] or [45]). But the expansion here is finite.

Corollary 8.5. *If G is described in the polynomial representation (5.35) as*

$$(8.10) \quad G \cong \mathbb{Z}[x] / p_L(x) \mathbb{Z}[x],$$

where

$$(8.11) \quad p_L(x) = \sum_{j=1}^N m_j x^j - 1,$$

then the element g in (8.8) is given in this representation by the polynomial

$$(8.12) \quad p(x) = \sum_{j=1}^N l_j x^{j-1} + \sum_{k \geq 1} i_k x^{N+k-1}.$$

This representation is unique within the constraint $0 \leq i_k \leq m_N - 1$.

Proof. Immediate from (5.35)–(5.38) and Corollary 8.3. \square

We will consider an analogue of Corollary 8.3 for $\ker(\tau)$ later, in (8.16) and Corollary 8.8.

Remark 8.6. If $q(x)$ is some representative polynomial in $\mathbb{Z}[x]$ for $g \in G = \mathbb{Z}[x] / (p_L(x))$, one may obtain $p(x)$ as follows: Let nx^M be the leading term in $q(x)$. If $M \leq N - 1$, there is nothing to do. If $M \geq N$, add an integer multiple of $p_L(x)x^{M-N}$ to $q(x)$ such that the leading coefficient is contained in $\{0, 1, \dots, m_N - 1\}$. Then do the same thing for the second leading term in the new polynomial, etc. We are soon going to adapt this procedure to the case where \mathbb{Z} is replaced by $\mathbb{Z}_p = \mathbb{Z}/p\mathbb{Z}$.

So far we have mainly considered ordered groups in this chapter and Chapter 7. The order is not essential for most of the results, however. Let us first consider Theorem 7.5.

Let J be a nonsingular $N \times N$ matrix over \mathbb{Z} , and set $\text{ind}(J) := \bigcup_{n \geq 0} J^{-n} \mathbb{Z}^N$. We identify it concretely as a subgroup of \mathbb{Q}^N (actually of $\mathbb{Z}[1/|\det J|]^N$), by the natural inclusion mapping

$$\text{ind}(J) \hookrightarrow \mathbb{Q}^N.$$

Corollary 8.7. *Let J be a nonsingular $N \times N$ matrix over \mathbb{Z} , and suppose that there is some D such that J has the triangular representation*

$$(8.13) \quad \left(\begin{array}{c|c} J_0 & V \\ \hline 0 & J_D \end{array} \right) \begin{array}{l} N-D \\ D \end{array}$$

where the entry block matrices are also over \mathbb{Z} , and their sizes are as indicated. Then there is a natural short exact sequence in the category of abelian groups

$$\begin{array}{ccccccc} 0 & \longrightarrow & \text{ind}(J_0) & \longrightarrow & \text{ind}(J) & \longrightarrow & \text{ind}(J_D) \longrightarrow 0 \\ & & \downarrow & & \downarrow & & \downarrow \\ 0 & \longrightarrow & \mathbb{Q}^{N-D} & \longrightarrow & \mathbb{Q}^N & \longrightarrow & \mathbb{Q}^D \longrightarrow 0 \\ & & \Downarrow & & \Downarrow & & \Downarrow \\ & & u & \xrightarrow{\iota} & \begin{pmatrix} u \\ 0 \end{pmatrix} \in \begin{pmatrix} \mathbb{Q}^{N-D} \\ \mathbb{Q}^D \end{pmatrix} & \ni & \begin{pmatrix} u \\ v \end{pmatrix} \xrightarrow{\pi} v \end{array}$$

where the morphisms in the first row are restrictions of those in the second one, as follows: If $k \in \mathbb{Z}^{N-D}$, and $l \in \mathbb{Z}^D$, then

$$\iota(J_0^{-n}k) = J^{-n} \begin{pmatrix} k \\ 0 \end{pmatrix}$$

and

$$\pi \left(J^{-n} \begin{pmatrix} k \\ l \end{pmatrix} \right) = J_D^{-n}l.$$

Proof. The details are contained in the last part of the proof of Theorem 7.8. \square

We now specialize to the case where J has a form similar to (5.47),

$$(8.14) \quad J_0 = \begin{pmatrix} q_1 & 1 & 0 & \cdots & 0 & 0 \\ q_2 & 0 & 1 & \cdots & 0 & 0 \\ \vdots & & & \ddots & \vdots & \vdots \\ q_{M-2} & 0 & & \ddots & 1 & 0 \\ q_{M-1} & 0 & 0 & & 0 & 1 \\ q_M & 0 & 0 & \cdots & 0 & 0 \end{pmatrix},$$

but now we merely assume that q_1, \dots, q_M are (not necessarily positive) integers and that J_0 is nonsingular, i.e., $q_M \neq 0$. Again one verifies that q_M times the characteristic polynomial of J_0^{-1} is

$$(8.15) \quad p_0(x) = \sum_{j=1}^M q_j x^j - 1,$$

and one verifies as in (5.35)–(5.38) that $G_0 = \text{ind } J_0$ identifies with the additive group

$$(8.16) \quad G_0 \cong \mathbb{Z}[x] / (p_0(x))$$

in such a way that application of J_0^{-1} corresponds to multiplication by x .

Corollary 8.8. *Adopt the notation and assumptions in the preceding paragraph, in particular*

$$(8.17) \quad G_0 = \text{ind}(J_0) = \bigcup_{n=0}^{\infty} J_0^{-n} \mathbb{Z}^M.$$

Then the results (i), (ii) in Corollary 8.3 and (8.12) in Corollary 8.5 remain valid, i.e.:

- (i) In terms of the elements $v_i = ie_M$, $i = 1, \dots, q_M$, the following unique representations of elements g of G_0 are valid:

$$(8.18) \quad g = l + J_0^{-1}v_{i_1} + J_0^{-2}v_{i_2} + \dots$$

where $l \in \mathbb{Z}^M$, $i_1, i_2, \dots \in \{0, 1, \dots, q_M - 1\}$, and the sum is finite.

- (ii) The polynomial representative of g in (8.18) is

$$(8.19) \quad \sum_{j=1}^M l_j x^{j-1} + \sum_{k \geq 1} i_k x^{M+k-1},$$

and this form of the representative (i.e., with $0 \leq i_k < q_M$) is unique.

Proof. As the proofs of Corollary 8.3 and Corollary 8.5. \square

In the following we will consider derived groups of the form $G_0 \otimes_{\mathbb{Z}} C$ where C is an abelian group. Recall from [20] that $G_0 \otimes_{\mathbb{Z}} C$ is the free abelian group generated by $g \otimes C$, with $g \in G_0$, $c \in C$, modulo the relations $(g_1 + g_2) \otimes C = g_1 \otimes C + g_2 \otimes C$, $g \otimes (C_1 + C_2) = g \otimes C_1 + g \otimes C_2$. (This and all the other remarks also apply to G as an unordered abelian group with the obvious modifications.) We will be interested in the case $C = \mathbb{Z}_n$, where $n \in \{2, 3, \dots\}$.

Since $G_0 = \mathbb{Z}[x]/p_0(x)\mathbb{Z}[x]$ we have a short exact sequence

$$(8.20) \quad 0 \longrightarrow p_0(x)\mathbb{Z}[x] \longrightarrow \mathbb{Z}[x] \longrightarrow G_0 \longrightarrow 0.$$

But by [20, Proposition II.4.5] the functor $\cdot \otimes_{\mathbb{Z}} C$ is right exact for any abelian group C , so in particular,

$$(8.21) \quad p_0(x)\mathbb{Z}[x] \otimes_{\mathbb{Z}} \mathbb{Z}_n \longrightarrow \mathbb{Z}[x] \otimes_{\mathbb{Z}} \mathbb{Z}_n = \mathbb{Z}_n[x] \longrightarrow G_0 \otimes_{\mathbb{Z}} \mathbb{Z}_n \longrightarrow 0$$

is exact for $n = 2, 3, 4, \dots$. Thus $G_0 \otimes_{\mathbb{Z}} \mathbb{Z}_n$ is isomorphic to $\mathbb{Z}_n[x]$ modulo the image of $p_0(x)\mathbb{Z}[x] \otimes_{\mathbb{Z}} \mathbb{Z}_n$ in $\mathbb{Z}_n[x]$, and this image is easily seen to be $p_0^{(n)}(x)\mathbb{Z}_n[x]$, where $p_0^{(n)}(x)$ is the polynomial $p_0(x)$ with the coefficients reduced modulo n . (This is because the map $m \rightarrow m \pmod n$ is a ring morphism $\mathbb{Z} \rightarrow \mathbb{Z}_n$.) Thus

$$(8.22) \quad G_0 \otimes_{\mathbb{Z}} \mathbb{Z}_n \cong \mathbb{Z}_n[x] / \left(p_0^{(n)}(x)\mathbb{Z}_n[x] \right)$$

Corollary 8.9. *Adopt the notation and assumptions in Corollary 8.8, and let $n \in \{2, 3, \dots\}$. Let*

$$(8.23) \quad \text{div} = \gcd\{n, q_M\},$$

where q_M is the leading coefficient in $p_0(x)$ (see (8.15)). Then any

$$(8.24) \quad g \in G_0 \otimes \mathbb{Z}_n \cong \mathbb{Z}_n[x] / p_0^{(n)}(x)\mathbb{Z}_n[x]$$

has a unique polynomial representative of the form

$$(8.25) \quad \sum_{j=1}^M l_j x^{j-1} + \sum_{k \geq 1} i_k x^{M+k-1},$$

where $0 \leq l_j < n$, $0 \leq i_k < \text{div} = \gcd\{n, q_M\}$, and the right-hand sum is finite. In particular, if $\gcd\{n, q_M\} = 1$, then

$$(8.26) \quad G_0 \otimes \mathbb{Z}_n \cong \mathbb{Z}_n^M.$$

Proof. If $q(x)$ is a polynomial in $\mathbb{Z}_n[x] \setminus (p_0^{(n)}(x))$, we may assume that all the coefficients of q are in $\{0, 1, \dots, n-1\}$ by reducing modulo n . Let mx^N be the leading term in $q(x)$. If $N \leq M-1$, there is nothing to do. If $N \geq M$ add an integer multiple of $p_0(x)x^{N-M}$ to $q(x) \pmod n$ such that the leading coefficient is contained in $\{0, 1, \dots, \gcd(n, q_M) - 1\}$. Then do the same thing for the second leading term in the new polynomial, etc. It is clear that this procedure determines the coefficients i_k uniquely.

In the special case that $\gcd(n, q_M) = 1$, the expansion (8.25) reduces to

$$\sum_{j=1}^M l_j x^{j-1}$$

and hence

$$G_0 \otimes \mathbb{Z}_n \cong \mathbb{Z}_n^M$$

in that case. □

Remark 8.10. We will see later, in Chapter 16, that Corollary 8.9 gives an efficient method of distinguishing cases which are not distinguished by the invariants in Chapters 6 and 7.

Associated structure of the groups $K_0(\mathfrak{A}_L)$ and $\ker \tau$

In this chapter we will study associated structure of the groups $K_0(\mathfrak{A}_L)$ and $\ker \tau$ which is related to the action of J , to the embeddings $\mathbb{Z}^N \subseteq K_0(\mathfrak{A}_L)$ and $\mathbb{Z}^{N-D} \subseteq \ker \tau$, and to invariant subgroup structure of J . It is not clear that these additional structures define invariants *per se*, but we will see in Chapter 16 that they can be used to establish a quite effective machine to determine non-isomorphism when the basic invariants from Chapter 7 are the same.

Remark 9.1. Let J be a nonsingular matrix with nonnegative integer entries, and suppose, for some $k \in \mathbb{N}$, that J^k has only positive entries. We saw near (5.1)–(5.6) that then G_J may be obtained as the inductive limit

$$(9.1) \quad \mathbb{Z}^N \hookrightarrow J^{-1}\mathbb{Z}^N \hookrightarrow J^{-2}\mathbb{Z}^N \hookrightarrow \dots,$$

and N is the rank of G_J . Moreover, (9.1) defines an embedding of \mathbb{Z}^N as a subgroup of G_J , and we can consider the quotient group $F(J) := G_J/\mathbb{Z}^N$. (It is not clear that the group $F(J)$ is an isomorphism invariant.) Using Theorem 7.5 we can similarly show that $\ker(\tau)$ has an analogous representation. Its rank is $M = N - D$, and it is obtained as an inductive limit

$$(9.2) \quad \mathbb{Z}^M \hookrightarrow J_0^{-1}\mathbb{Z}^M \hookrightarrow J_0^{-2}\mathbb{Z}^M \hookrightarrow \dots,$$

where J_0 is the upper left-hand submatrix of (7.15):

$$(9.3) \quad J_0 = \begin{pmatrix} Q_1 & 1 & \cdots & 0 & 0 \\ Q_2 & 0 & \ddots & 0 & 0 \\ \vdots & & \ddots & \ddots & \vdots \\ Q_{M-1} & 0 & & 0 & 1 \\ Q_M & 0 & \cdots & 0 & 0 \end{pmatrix}, \quad Q_i \in \mathbb{Z}, Q_M \neq 0.$$

The number m_N cannot be derived from the groups $F(L) := G_L/\mathbb{Z}^N$ and $F_\tau(L) := \ker(\tau)/\mathbb{Z}^M$ by the example below, where N , resp. M , is still the rank of G_L , resp. $\ker(\tau)$.

Three important properties we establish in Lemma 9.2 below, which relate m_N and the group $F(J)$, are the following (see details below):

- (i) $F(J)$ has elements of minimal order m_N ;
- (ii) every element of $F(J)$ has a finite order which is a divisor of a power of m_N ; and
- (iii) $m_N F(J) = F(J)$.

Lemma 9.2. *Let the $(L_i)_{i=1}^d$ system be as in Theorem 4.2. Let J be the incidence matrix (7.2), and assume $|\det J| = m_N > 1$. Consider the group $F(L) = K_0(\mathfrak{A}_L) / \mathbb{Z}^N$, where we use the concrete realization (5.6) or (9.1) of $K_0(\mathfrak{A}_L)$.*

Let e_1, \dots, e_N be the standard basis for \mathbb{Z}^N , and define

$$(9.4) \quad g_i = J^{-i} e_N$$

for $i = 1, 2, 3, \dots$, and

$$(9.5) \quad g_{-i} = e_{N-i}$$

for $i = 0, 1, \dots, N-1$. Then the elements g_i generate $K_0(\mathfrak{A})$ as an abelian group, and satisfy the relations

$$(9.6) \quad m_N g_{N+i} = g_i - m_1 g_{i+1} - \dots - m_{N-1} g_{N+i-1}$$

for $i = -(N-1), -(N-1)+1, \dots$. Moreover, $K_0(\mathfrak{A})$ can be characterized as a group as the abelian group generated by elements $g_{-N+1}, g_{-N+2}, \dots$ satisfying these relations, and the order in $K_0(\mathfrak{A})$ is given by

$$(9.7) \quad \sum_{i \geq 1-N} c_i g_i > 0 \iff \sum_{i \geq 1-N} c_i \lambda^{-i} > 0,$$

where the sums are finite and λ is the Perron–Frobenius eigenvalue of J .

Correspondingly, if we put

$$(9.8) \quad x_i = g_i \pmod{\mathbb{Z}^N},$$

the x_i satisfy the relations

$$(9.9) \quad x_i = 0$$

for $i = 1-N, 2-N, \dots, 0$ and

$$(9.10) \quad m_N x_{N+i} = x_i - m_1 x_{i+1} - \dots - m_{N-1} x_{N+i-1}$$

for $i = 1-N, 2-N, \dots$, and $F(L)$ can be characterized as the abelian group generated by these relations.

Proof. Let $g_i = J^{-i} e_N \in G(L)$, $x_i = g_i \pmod{\mathbb{Z}^N}$, and $m = m_N$. Then

$$\begin{aligned} mg_1 &= e_1 - m_1 e_2 - \dots - m_{N-1} e_N, \\ mg_2 &= J^{-1} e_1 - m_1 J^{-1} e_2 - \dots - m_{N-1} J^{-1} e_N \\ &= e_2 - m_1 e_3 - \dots - m_{N-2} e_N - m_{N-1} g_1, \end{aligned}$$

and

$$\begin{aligned} mg_3 &= e_3 - m_1 e_4 - \dots - m_{N-2} g_1 - m_{N-1} g_2, \\ &\vdots \\ mg_{N+i} &= g_i - m_1 g_{i+1} - \dots - m_{N-1} g_{N+i-1}, \end{aligned}$$

and in $F(L) = G(L) / \mathbb{Z}^N$:

$$\begin{aligned}
mx_1 &= 0, \\
mx_2 &= -m_{N-1}x_1, \\
mx_3 &= -m_{N-2}x_1 - m_{N-1}x_2, \\
&\vdots \\
mx_N &= -m_1x_1 - \cdots - m_{N-1}x_{N-1}, \\
&\vdots \\
mx_{N+i} &= x_i - m_1x_{i+1} - \cdots - m_{N-1}x_{N+i-1}.
\end{aligned}$$

This proves the relations (9.6), (9.9) and (9.10). To prove that the relations (9.6) actually characterize $K_0(\mathfrak{A}_L)$ we use the polynomial representation (5.35)–(5.38). There $K_0(\mathfrak{A}_L)$ is characterized as the additive group $\mathbb{Z}[x]$ modulo the linear combinations of the elements

$$x^n p_L(x)$$

for $n = 0, 1, 2$, where $p_L(x)$ is given by (5.48) as

$$p_L(x) = \sum_{j=1}^N m_j x^j - 1.$$

Thus $K_0(\mathfrak{A}_L)$ is characterized as the abelian group generated by elements $1, x, x^2, \dots$ with the relations

$$m_N x^{N+i} = x^i - m_1 x^{i+1} - \cdots - m_{N-1} x^{N+i-1}$$

for $i = 0, 1, 2, \dots$. But then the abelian group defined by the relations (9.6) above is isomorphic to this polynomial group through the map

$$g_i \longmapsto x^{i+N-1}$$

for $i = 1 - N, 2 - N, \dots$. This proves that the abelian group defined by (9.6) is isomorphic to $K_0(\mathfrak{A}_L)$, and furthermore, an isomorphism between the groups is given by

$$\sum_{i \geq 1-N} c_i g_i \longmapsto \sum_{i \geq 1-N} c_i x^{i+N-1}.$$

Using (5.36), we thus see that (9.7) is valid.

Since $\mathbb{Z}^N \subseteq K_0(\mathfrak{A})$ identifies with the free abelian group generated by $g_{1-N}, g_{2-N}, \dots, g_0$ in the above picture, the remaining statement about $F(L)$ is immediate. \square

Remark 9.3. For the example $J = \begin{pmatrix} 1 & 1 & 0 \\ 0 & 0 & 1 \\ 4 & 0 & 0 \end{pmatrix}$, the relations for the x_i take the form

$$\begin{aligned}
4x_1 &= 0, \\
4x_2 &= 0, \\
4x_3 &= -x_1, \\
&\vdots \\
4x_i &= x_{i-3} - x_{i-2}, \quad i = 4, 5, \dots
\end{aligned}$$

This example has Perron–Frobenius eigenvalue $\lambda = 2$. Thus we see that the group $F(L)$ for this example is isomorphic to $(\mathbb{Z}[\frac{1}{2}]/\mathbb{Z})^2$ by the isomorphism

$$\begin{aligned} x_1 &\longrightarrow \left(\frac{1}{4}, 0\right), \\ x_2 &\longrightarrow \left(0, \frac{1}{4}\right), \\ x_3 &\longrightarrow \left(-\frac{1}{4^2}, 0\right), \\ x_4 &\longrightarrow \left(\frac{1}{4^2}, -\frac{1}{4}\right), \\ x_5 &\longrightarrow \left(\frac{1}{4^3}, \frac{1}{4^2}\right), \\ x_6 &\longrightarrow \left(-\frac{2}{4^3}, \frac{1}{4^2}\right), \quad \text{etc.} \end{aligned}$$

We will later, in Proposition 11.25 and Remark 11.23, use these relations to prove the useful scaling property

$$\{g \in K_0(\mathfrak{A}_J) \mid 4^i g \in \mathbb{Z}^3\} = J^{-2i} \mathbb{Z}^3$$

for $i = 1, 2, \dots$; see, e.g., Corollary 11.22 for the use of the scaling. We know from (5.31) that $K_0(\mathfrak{A}_J)$ is an extension of $\mathbb{Z}[\frac{1}{2}]$ by $\ker \tau$, and we will show in Example 18.1 by using relations analogous to the above for $\ker \tau$ that $\ker \tau$ is an extension of $\mathbb{Z}[\frac{1}{2}]$ by \mathbb{Z} .

For the example $J = \begin{pmatrix} 4 & 1 \\ 0 & 0 \end{pmatrix}$, $\lambda = 2 \cdot (1 + \sqrt{2})$, we have $N = 2$. Here $\text{order}(x_1) = \text{order}(x_2) = 4$, while

$$\begin{cases} 4x_{2i+1} = x_{2i-1} \\ 4x_{2i+2} = 3x_{2i-1} + x_{2i} \end{cases}$$

for $i \in \mathbb{N}$; that is, the transition matrix in this example is $\begin{pmatrix} 1 & 0 \\ 3 & 1 \end{pmatrix}$. It follows from Proposition 11.25 and Remark 11.23 that also this example has the scaling property $\{g \in K_0(\mathfrak{A}_J) \mid 4^i g \in \mathbb{Z}^2\} = J^{-2i} \mathbb{Z}^2$.

Remark 9.4. The spectra of the respective matrices of the decomposition $J = \left(\begin{array}{c|c} J_0 & Q \\ \hline 0 & J_R \end{array} \right)$ in Theorem 7.8 and Corollary 7.10 may be summarized by the factorization

$$(9.11) \quad \det(t\mathbb{1}_N - J) = \det(t\mathbb{1}_{N-D} - J_0) \det(t\mathbb{1}_D - J_R).$$

Since all three matrices J , J_0 , and J_R have the form (7.2), the coefficients in the respective characteristic polynomials are just the numbers from the first columns in the three matrices. It is also clear from Theorem 7.5 that the Perron–Frobenius eigenvalue λ is in the spectrum of J_R , and so the points σ in the spectrum of J_0 satisfy $|\sigma| < \lambda$.

Corollary 9.5. *Let (J, \mathcal{L}) , $\mathcal{L} = \mathbb{Z}^N$, be as described in Proposition 7.7. Then there is a finite decomposition series of lattices $\mathcal{L}_1, \mathcal{L}_2, \dots, \mathcal{L}_p$ such that*

- (i) *the characteristic polynomial of $J|_{\mathcal{L}_p}$ is irreducible;*
- (ii) *$N > \text{rank } \mathcal{L}_1 > \text{rank } \mathcal{L}_2 > \dots > \text{rank } \mathcal{L}_p$ (if more than one term) with each \mathcal{L}_i invariant under J ;*

- (iii) when the corresponding inductive limit groups G_i are formed from each \mathcal{L}_i , they satisfy $G_p \hookrightarrow \dots \hookrightarrow G_2 \hookrightarrow G_1 \hookrightarrow K_0(\mathfrak{A}_L)$ and $G_1 = \ker(\tau)$. The step from \mathcal{L}_i to \mathcal{L}_{i+1} is that of Theorems 7.5 and 7.8. The first column in $J_i = J|_{\mathcal{L}_i}$ defines an element of $\mathbb{Z}[x]$ by (7.5). If this polynomial is irreducible, then the algorithm stops. If not, it has a real root a_i , and we use the corresponding minimal polynomial $p_{a_i}(t) \in \mathbb{Z}[t]$ in passing to the next step $i+1$ of the algorithm as done above in the proof of Theorems 7.5 and 7.8. The corresponding absolute determinants $|\det J_i|$ and polynomials $p_i(t)$ form successions of divisors.

Proof. The proof is similar to the proof of Proposition 7.7. We use the fact that if $J = \left(\begin{array}{c|c} J_0 & Q \\ \hline 0 & J_R \end{array} \right)$ represents a step in the algorithm, and if $p_J(t)$, $p_{J_0}(t)$ and $p_{J_R}(t)$ are the corresponding characteristic polynomials, then $p_J(t) = p_{J_0}(t) \cdot p_{J_R}(t)$.

As described in (iii), the argument is by recursion: Suppose

$$J \cong \left(\begin{array}{c|c} J_1 & V_1 \\ \hline 0 & K_1 \end{array} \right)$$

is a triangular representation as in Corollary 8.7. Then formula (9.11) yields divisibility for the respective characteristic polynomials

$$(9.12) \quad \text{ch}_J(t) = \text{ch}_{J_1}(t) \text{ch}_{K_1}(t).$$

If this first reduction decreases the rank, then (9.12) shows that $\text{ch}_J(t)$ could not be irreducible. At the first step in the reduction, Theorem 7.8 and Corollary 7.10 show that the Perron–Frobenius eigenvalue λ is a root of $\text{ch}_{K_1}(t)$. We must show that, if $\text{ch}_{J_1}(t)$ factors nontrivially, i.e., $\text{ch}_{J_1}(t) = q(t)p(t)$, with $q(t), p(t) \in \mathbb{Z}[t]$, and say $p(t)$ irreducible, then the process may continue. Since the matrices J_1 and K_1 have the same form as J at the outset, we would get

$$(9.13) \quad J_1 \cong \left(\begin{array}{c|c} J_2 & V_2 \\ \hline 0 & K_2 \end{array} \right),$$

again with the properties from the proof of Theorem 7.8 and Corollary 8.7. Let $f(t) = \text{ch}_{J_1}(t)$. Then J_1 may be represented, via (7.11), as multiplication by t on $\mathbb{Z}[t] \not\sim (f(t))$. Let W denote the following induced linear mapping (quotient by ideals):

$$\mathbb{Z}[t] \not\sim (q(t)) \xrightarrow{W} \mathbb{Z}[t] \not\sim (f(t)),$$

$W(h(t) + q) := p(t)h(t) + (f)$, for $h(t) \in \mathbb{Z}[t]$. It is well defined and injective due to the assumptions made on $f(t)$. Since J_1 is represented as multiplication by t in $\mathbb{Z}[t] \not\sim (f(t))$, the range of W is then a nontrivial invariant subspace (over \mathbb{Z}) for J_1 , and we arrive at the triangular form (9.13). The argument from the proof of Theorem 7.8 shows that the entries of (9.13) must have the same standard form as described in the previous step. Hence the process may continue until at some step, p say, $\text{ch}_{J_p}(t)$ is irreducible. \square

The invariant $\text{Ext}(\tau(K_0(\mathfrak{A}_L)), \ker \tau)$

In this chapter and the next we study the set $\mathcal{L}(\lambda)$ of matrices J_m of the form (7.2) such that $\lambda^N - m_1\lambda^{N-1} - \dots - m_{N-1}\lambda - m_N = 0$. For the case when $\lambda \in \mathbb{Z}_+$, we will show in Theorem 11.10, Corollary 11.12, Corollary 11.13, Theorem 11.17, Corollary 11.20, and Proposition 11.21 that $\tau(v)$ can be used to show non-isomorphism where τ is the normalized trace, and v is the right Perron–Frobenius eigenvector, i.e., $Jv = \lambda v$, $v_1 = 1$. See (14.5) for the explicit form of v .

There are examples J, J' such that all the three Prim-invariants agree on J and J' while the C^* -algebras \mathfrak{A}_J and $\mathfrak{A}_{J'}$ are non-isomorphic. Take, for example, $N = 3$, $D = 1$, $\lambda = \lambda' = 2$, and

$$m = \begin{pmatrix} m_1 \\ m_2 \\ m_3 \end{pmatrix} = \begin{pmatrix} 1 \\ 0 \\ 4 \end{pmatrix}, \quad \text{and} \quad m' = \begin{pmatrix} m'_1 \\ m'_2 \\ m'_3 \end{pmatrix} = \begin{pmatrix} 0 \\ 2 \\ 4 \end{pmatrix}.$$

(For more examples, see also Chapter 16 and Table 1 in Chapter 11.) Then the respective triangular forms are

$$J \cong \left(\begin{array}{cc|c} -1 & 1 & 1 \\ -2 & 0 & 2 \\ 0 & 0 & 2 \end{array} \right), \quad J' \cong \left(\begin{array}{cc|c} -2 & 1 & 2 \\ -2 & 0 & 2 \\ 0 & 0 & 2 \end{array} \right).$$

and therefore

$$Q_2 = Q'_2 = R_1 = R'_1 = 2.$$

In the next chapters, we identify additional quantities which can be used to distinguish \mathfrak{A}_J and $\mathfrak{A}_{J'}$. If v denotes the right Perron–Frobenius eigenvector, then one of these quantities is $\tau(v)$. The actual non-isomorphism of the two specimens above can, however, be established by using (8.26) in Corollary 8.9; see the $N = 3$ case in Chapter 16.

We mentioned in Chapter 5 that the dimension group $D(\mathfrak{A}_L)$, that is the group $K_0(\mathfrak{A}_L)$ with the Riesz order and the element $[\mathbf{1}]_0$, is a complete isomorphism invariant by the general theory. Objects that can be derived from $D(\mathfrak{A}_L)$, like $\tau(K_0(\mathfrak{A}_L))$, $\ker \tau$, Ext , $N = \text{rank}(K_0(\mathfrak{A}_L))$, and the sets of prime factors of m_N , R_D , and Q_{N-D} , are secondary invariants. In this chapter and the next we shall treat the invariant in $\text{Ext}(\tau(K_0(\mathfrak{A}_L)), \ker \tau)$ defined by $K_0(\mathfrak{A}_L)$.

Aside from the two groups $\ker(\tau)$ and $\tau(K_0(\mathfrak{A}_L))$ themselves, $D(\mathfrak{A}_L)$ determines the intrinsic exact sequence:

$$(10.1) \quad 0 \longrightarrow \ker(\tau) \xrightarrow{\iota} G \xrightarrow{\tau} \tau(G) \longrightarrow 0,$$

where we use the shorthand notation $G = G_L := K_0(\mathfrak{A}_L)$. Hence the complete invariant $D(\mathfrak{A}_L)$ for isomorphism of the AF- C^* -algebras \mathfrak{A}_L includes (10.1), characterized as an element of $\text{Ext}(\tau(G), \ker(\tau))$. We shall need a few facts from

homology about the Ext-groups, and we refer to [64] for background material: if A and C are abelian groups, an element of $\text{Ext}(C, A)$ is an equivalence class of short exact sequences of abelian groups

$$(10.2) \quad 0 \longrightarrow A \xrightarrow{\iota} E \xrightarrow{\tau} C \longrightarrow 0.$$

It is conventional to use the same letter E also to denote this exact sequence and E or $[E]$ to denote the equivalence class. Two elements E and E' are said to be equivalent in $\text{Ext}(C, A)$ if there is an isomorphism $\theta: E \rightarrow E'$ of abelian groups such that

$$(10.3) \quad \begin{array}{ccccccc} & & & E & & & \\ & & & \downarrow \theta & & & \\ 0 & \longrightarrow & A & \begin{array}{c} \nearrow \iota \\ \searrow \iota' \end{array} & \begin{array}{c} \searrow \tau \\ \nearrow \tau' \end{array} & C & \longrightarrow & 0 \\ & & & E' & & & \end{array}$$

commutes, or more globally if

$$(10.4) \quad \begin{array}{ccccccc} 0 & \longrightarrow & A & \longrightarrow & E & \longrightarrow & C & \longrightarrow & 0 \\ & & \alpha \downarrow & & \theta \downarrow & & \downarrow \gamma & & \\ 0 & \longrightarrow & A' & \longrightarrow & E' & \longrightarrow & C' & \longrightarrow & 0 \end{array}$$

commutes, where α , γ are isomorphisms of abelian groups. Note if we have $\theta \in \text{Hom}(E, E')$, and if α and γ are isomorphisms, then θ will be an isomorphism by the Short Five Lemma; see [64]. With a standard addition $E + E'$, $\text{Ext}(C, A)$ itself acquires the structure of an abelian group. $E'' = E + E'$ is defined by

$$E'' = \{(x, y) \in E \oplus E' \mid \tau(x) = \tau'(y)\} / \{(\iota(a), -\iota'(a)) \mid a \in A\}$$

with

$$\iota'': A \longrightarrow E'': a \longmapsto [(\iota(a), 0)]$$

and

$$\tau'': E'' \longrightarrow C: [(x, y)] \longrightarrow \tau(x).$$

(In these considerations, τ , τ' , and τ'' are only viewed as maps of abelian semigroups.) This makes $\text{Ext}(C, A)$ into an abelian semigroup, with identity element the trivial extension

$$\begin{aligned} E_0 &= A \oplus C, \\ \iota_0: A &\longrightarrow E_0: a \longrightarrow (a, 0), \\ \tau_0: E_0 &\longrightarrow C: (a, b) \longrightarrow b. \end{aligned}$$

Any element has an inverse given by

$$\begin{aligned} E' &= E, \\ \iota' &= -\iota, \\ \tau' &= \tau, \end{aligned}$$

and this makes $\text{Ext}(C, A)$ into an abelian group.

We say that (10.2) *splits* if there is a $\psi \in \text{Hom}(C, E)$ such that $\tau \circ \psi = \text{id}$. This is equivalent to

$$E \cong A \oplus C \quad (\text{direct sum of abelian groups}),$$

with trivial maps ι , τ , and then the corresponding E is the zero element of the abelian group $\text{Ext}(C, A)$. Note that $\text{Ext}(\mathbb{Z}_2, \mathbb{Z}) \cong \mathbb{Z}_2$. The corresponding two group elements, 0, resp., 1, are (the equivalence classes of) (10.5) and (10.6):

$$(10.5) \quad 0 \longrightarrow 2\mathbb{Z} \hookrightarrow (2\mathbb{Z}) \oplus \mathbb{Z}_2 \xrightarrow{0+\text{id}} \mathbb{Z}_2 \longrightarrow 0$$

and

$$(10.6) \quad 0 \longrightarrow 2\mathbb{Z} \hookrightarrow \mathbb{Z} \xrightarrow{\text{proj}} \mathbb{Z}_2 \longrightarrow 0,$$

where the second, (10.6), is non-split. More generally,

$$(10.7) \quad \text{Ext}(\mathbb{Z}_m, A) \cong A/mA;$$

see [64]. A refinement of (10.7), also due to Mac Lane et al., is the characterization of

$$(10.8) \quad \text{Ext}\left(\mathbb{Z}\left[\frac{1}{k}\right], \mathbb{Z}^l\right)$$

as a solenoid, depending on $k, l \in \mathbb{N}$, $k > 1$. In particular, (10.8) is overcountable. The description of our \mathfrak{A}_L 's associated with $|\det J_L| = k$ in the special case that $\ker(\tau) \cong \mathbb{Z}^l$, must be given in terms of (10.8).

In the general case, we have J_L of the form

$$(10.9) \quad J_L = \begin{pmatrix} m_1 & 1 & 0 & \cdots & 0 & 0 \\ m_2 & 0 & 1 & \cdots & 0 & 0 \\ m_3 & 0 & 0 & \ddots & 0 & 0 \\ \vdots & \vdots & & \ddots & \ddots & \vdots \\ m_{N-1} & 0 & 0 & & 0 & 1 \\ m_N & 0 & 0 & \cdots & 0 & 0 \end{pmatrix},$$

where $m_N = (-1)^{N-1} \det J_L$, and the characteristic polynomial $p_L(\lambda)$ is

$$(10.10) \quad p_L(\lambda) = \det(\lambda - J_L) = \lambda^N - m_1\lambda^{N-1} - \cdots - m_{N-1}\lambda - m_N.$$

Here N is the rank of G_L . Then \mathbb{Z}^N is embedded in G_L , and we can introduce the quotient group G_L/\mathbb{Z}^N . Using this, we show that G_L/\mathbb{Z}^N is a specific extension of the inductive limit group \mathcal{C}_{m_N} defined by

$$\mathbb{Z}_{m_N} \xrightarrow{m_N} \mathbb{Z}_{m_N^2} \xrightarrow{m_N} \mathbb{Z}_{m_N^3} \longrightarrow \cdots.$$

Let τ be the normalized trace on G_L . Then there is a short exact sequence

$$0 \longrightarrow \ker(\tau) \longrightarrow G_L \xrightarrow{\tau} \tau(G_L) \longrightarrow 0.$$

We further show that, if M is the rank of $\ker(\tau)$, then $\ker(\tau)/\mathbb{Z}^M$ is an extension of a second inductive limit group \mathcal{C}_k formed from finite cyclic groups:

$$\mathbb{Z}_k \xrightarrow{k} \mathbb{Z}_{k^2} \xrightarrow{k} \mathbb{Z}_{k^3} \xrightarrow{k} \cdots,$$

where k divides m_N . It will follow in particular from the construction that every element of G_L/\mathbb{Z}^N has a (finite) order which divides a power of m_N ; and, similarly, that every element of $\ker(\tau)/\mathbb{Z}^M$ has an order which is a divisor of k^i for some i (depending on the element).

Note that, as a consequence of (10.10), the vector (m_1, \dots, m_N) is a similarity invariant for J_L , i.e., two nonsingular matrices J_L and $J_{L'}$ of the form (10.9) are similar if and only if they are equal. But similarity of two J_L 's is a condition which *a priori* is much more restrictive than isomorphism of the corresponding pair of C^* -algebras, \mathfrak{A}_L and $\mathfrak{A}_{L'}$. In [13] this is discussed in detail, and we show for example that the matrices we discussed in (7.21),

$$(10.11) \quad J_L = \begin{pmatrix} 4 & 1 \\ 32 & 0 \end{pmatrix} \quad \text{and} \quad J_{L'} = \begin{pmatrix} 6 & 1 \\ 16 & 0 \end{pmatrix},$$

define isomorphic C^* -algebras. (See Figure 15, below.) Other examples are in Example 5.3, in (6.22), in Chapters 13 and 16, and in [13].

Let L be such that $\tau(G_L) = \mathbb{Z}[\frac{1}{k}]$ for some k . Then \mathfrak{A}_L corresponds to a nonzero element of $\text{Ext}(\mathbb{Z}[\frac{1}{k}], \ker(\tau))$, if and only if

$$(10.12) \quad 0 \longrightarrow \ker(\tau) \longrightarrow G_L \xrightarrow{\tau} \mathbb{Z}[\frac{1}{k}] \longrightarrow 0$$

is non-split. Let J_L be given as usual (see (10.9)), and let G_L be the inductive limit from

$$(10.13) \quad \mathbb{Z}^N \subseteq J_L^{-1}(\mathbb{Z}^N) \subseteq J_L^{-2}(\mathbb{Z}^N) \subseteq \dots.$$

For the pair (10.11) we show in [13], or, more generically, in Proposition 13.3, that (10.12) is the following exact sequence:

$$(10.14) \quad 0 \longrightarrow \mathbb{Z}[\frac{1}{2}] \xrightarrow{z \mapsto (z, -8z)} \mathbb{Z}[\frac{1}{2}] \times \mathbb{Z}[\frac{1}{2}] \xrightarrow{\tau = \langle \cdot, (1, 1/8) \rangle} \mathbb{Z}[\frac{1}{2}] \longrightarrow 0.$$

This is the zero element of $\text{Ext}(\mathbb{Z}[\frac{1}{2}], \mathbb{Z}[\frac{1}{2}])$: an injection $\psi: \mathbb{Z}[\frac{1}{2}] \rightarrow \mathbb{Z}[\frac{1}{2}] \times \mathbb{Z}[\frac{1}{2}]$ may be defined by

$$(10.15) \quad \psi(u) := \left(\frac{7}{8}u, u \right), \quad u \in \mathbb{Z}[\frac{1}{2}].$$

Then clearly $\tau(\psi(u)) = u$, so ψ defines a section, and (10.14) splits.

The inductive limit G_L from (10.13), and $\tau(G_L) = \mathbb{Z}[\frac{1}{k}]$, $k > 1$, in general define a nontrivial element of Ext , i.e., (10.12) is non-split in general. It is split if and only if there is an element $g \in G_L$ such that $(k^{-i})g \in G_L$, $\forall i \in \mathbb{N}$, and $\tau(g) = 1$.

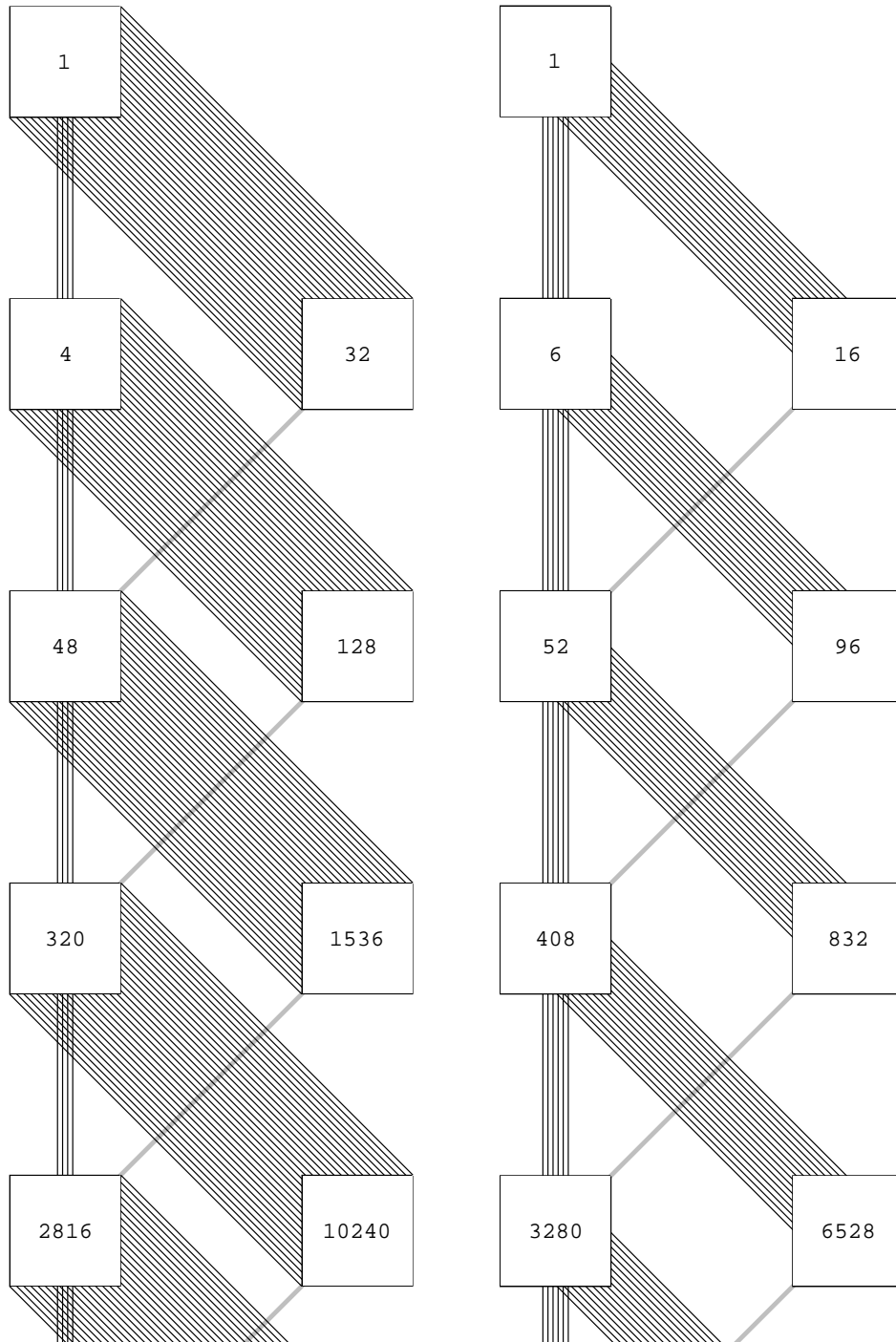

FIGURE 15. $L = \{1, 1, 1, 1, \underbrace{2, \dots, 2}_{32}\}$, first column = $(4 \ 32)^t$ (left);
 $L = \{1, 1, 1, 1, 1, 1, \underbrace{2, \dots, 2}_{16}\}$, first column = $(6 \ 16)^t$ (right). See
 (10.11). These diagrams represent isomorphic algebras.

Scaling and non-isomorphism

In this chapter we introduce a number $\tau(v)$, and prove in Theorem 11.10 and Corollary 11.22 that it can be used to establish non-isomorphism for classes of algebras where the basic invariants in Theorem 7.8 are the same..

Let $\lambda \in \mathbb{R}_+$, and let

$$\mathcal{L}(\lambda) = \{J \mid J \text{ is of the form (11.2) with Perron–Frobenius eigenvalue } \lambda\}.$$

In particular, the standard matrix J_m is in $\mathcal{L}(\lambda)$ if and only if

$$(11.1) \quad \lambda^N - m_1\lambda^{N-1} - m_2\lambda^{N-2} - \cdots - m_{N-1}\lambda - m_N = 0.$$

The admissible numbers λ must therefore be algebraic. These algebraic integers λ may be specified further; see, e.g., [51], [79], and [71] for more details on this point.

We are not restricting the size $N \times N$ of the matrices J in $\mathcal{L}(\lambda)$.

Our main result, Theorem 11.10, in this chapter, is that $\tau(v) = \langle \alpha \mid v \rangle$, introduced in (11.3)–(11.4), can be used to show non-isomorphism of a class of cases in $\mathcal{L}(\lambda)$ when $\lambda \in \mathbb{Z}_+$, $\lambda > 1$.

We consider matrices $J = J_m = J_L$ having the form

$$(11.2) \quad J_m = \begin{pmatrix} m_1 & 1 & 0 & \cdots & 0 & 0 \\ m_2 & 0 & 1 & \cdots & 0 & 0 \\ m_3 & 0 & 0 & \ddots & 0 & 0 \\ \vdots & \vdots & & \ddots & \ddots & \vdots \\ m_{N-1} & 0 & 0 & & 0 & 1 \\ m_N & 0 & 0 & \cdots & 0 & 0 \end{pmatrix},$$

with $m_i \in \mathbb{Z}$, $m_i \geq 0$, $m_N > 0$, and satisfying the further requirement that for some $k \in \mathbb{N}$, J^k has only positive entries (equivalently, $\gcd\{i \mid m_i \neq 0\} = 1$). Non-unimodularity means $m_N > 1$.

Recall from (5.17) that the vector $\alpha = \alpha_\lambda = (1, \lambda^{-1}, \dots, \lambda^{-(N-1)})$ satisfies

$$(11.3) \quad \alpha J = \lambda \alpha,$$

and also there is a unique $v \in \mathbb{Z}[\lambda]^N$ such that

$$(11.4) \quad Jv = \lambda v \quad \text{and} \quad v_1 = 1.$$

An explicit expression for v is given in (14.5). When J is given, let \mathfrak{A}_J be the corresponding AF-algebra.

TABLE 1. Parameters for Examples A and B in (11.5)–(11.6).

	λ	m_N	R_D	$\ker(\tau)$	$F = K_0/\mathbb{Z}^3$	$\langle \alpha v \rangle$
Example A:	2	2	2	\mathbb{Z}^2	$\mathbb{Z}[\frac{1}{2}]/\mathbb{Z}$	$\frac{9}{4}$
Example B:	4	4	4	\mathbb{Z}^2	$\mathbb{Z}[\frac{1}{2}]/\mathbb{Z}$	$\frac{33}{16}$

Our list of invariants, so far, cannot separate the AF-isomorphism classes corresponding to the following pair of examples (Examples A and B) where:

$$(11.5) \quad \begin{pmatrix} m_1 \\ m_2 \\ m_3 \end{pmatrix}_A = \begin{pmatrix} 0 \\ 3 \\ 2 \end{pmatrix} \text{ and } \begin{pmatrix} m_1 \\ m_2 \\ m_3 \end{pmatrix}_B = \begin{pmatrix} 0 \\ 15 \\ 4 \end{pmatrix}, \quad \lambda_A = 2 \text{ and } \lambda_B = 4.$$

The stabilized Bratteli diagrams:

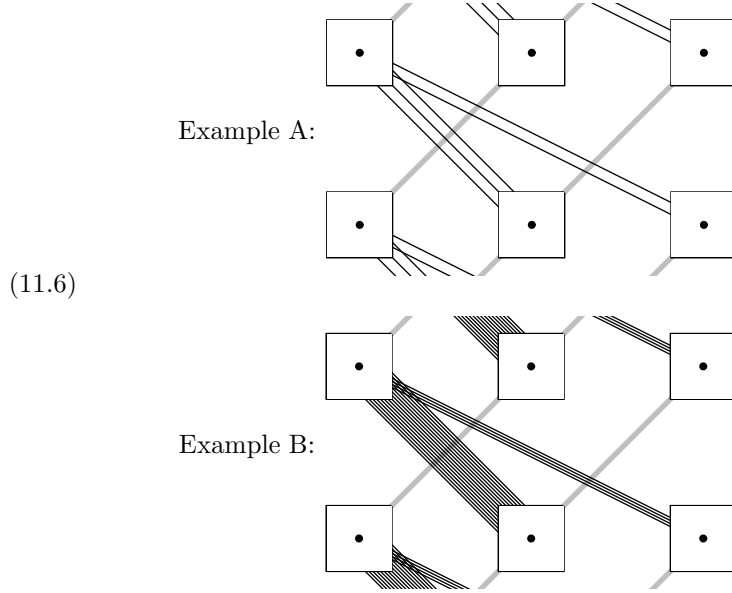

For both these examples, the basic invariants in Chapter 7 have the values $N = 3$, $D = 1$, $\text{Prim}(m_N) = \{2\}$, $\text{Prim}(R_D) = \{2\}$, $\text{Prim}(Q_{N-D}) = \emptyset$. These invariants do not directly separate the isomorphism classes of the examples. However, since one Perron–Frobenius eigenvalue is a power of the other, we will show that $\tau(v)$ can be used to check non-isomorphism of the two AF-algebras \mathfrak{A}_A and \mathfrak{A}_B . This is shown for this specific example in Observation 11.2, and more generally in Theorem 11.10.

It is easy to check that both examples have $\ker(\tau) \cong \mathbb{Z}^2$, and $\tau(K_0) \cong \mathbb{Z}[\frac{1}{2}]$. Strictly speaking, $\tau(K_0)$ is $\mathbb{Z}[\frac{1}{2}]$ for Example A, and $\mathbb{Z}[\frac{1}{4}]$ for Example B; but $\mathbb{Z}[\frac{1}{2}] = \mathbb{Z}[\frac{1}{4}]$ with the natural isomorphism specified by

$$\frac{1}{4^i} \mapsto \frac{1}{2^{2i}}.$$

Hence, both of the examples are characterized as elements of $\text{Ext}(\mathbb{Z}[\frac{1}{2}], \mathbb{Z}^2)$, in the usual manner. Let G_A and G_B be the respective K_0 -groups. The rank of each group is clearly $N = 3$.

The next Observation illustrates the previous remarks about m_N . Let $F_A := G_A/\mathbb{Z}^3$, and similarly for F_B .

Observation 11.1. $G_A/\mathbb{Z}^3 \cong G_B/\mathbb{Z}^3 \cong \mathbb{Z}[\frac{1}{2}]/\mathbb{Z}$.

Proof. The respective quotient groups have the following generators:

$$F_A: x_i = J_A^{-i} e_3 \pmod{\mathbb{Z}^3}$$

and

$$F_B: y_i = J_B^{-i} e_3 \pmod{\mathbb{Z}^3},$$

and a use of Lemma 9.2 yields:

- (a) $2x_1 = 0, 2x_{i+1} = x_i, i \in \mathbb{N}$, and
- (b) $4y_1 = 0, 4y_{i+1} = y_i, i \in \mathbb{N}$.

Hence $G_A/\mathbb{Z}^3 \cong \mathbb{Z}[\frac{1}{2}]/\mathbb{Z}$, and $G_B/\mathbb{Z}^3 \cong \mathbb{Z}[\frac{1}{4}]/\mathbb{Z} = \mathbb{Z}[\frac{1}{2}]/\mathbb{Z}$. \square

The crucial property derived from (a)–(b) above is not really Observation 11.1, but that scaling by a power of 2 (in Example A) and 4 (in B) determines a *filtration* of $G_A = \bigcup_{n \geq 0} J_A^{-n} \mathbb{Z}^3$. Specifically, let $\pi_A: G_A \rightarrow F_A = G_A/\mathbb{Z}^3$ be the quotient mapping. If elements of F_A are represented as $(i_1, i_2, \dots, i_{n-1}, 1), i_j \in \mathbb{Z}_2$, we write

$$\begin{aligned} g_n = & x + i_1 J_A^{-1} e_3 + i_2 J_A^{-2} e_3 + \dots \\ & + i_{n-1} J_A^{-n-1} e_3 + 1 \cdot J_A^{-n} e_3 \quad \text{for } x \in \mathbb{Z}^3, i_j \in \{0, 1\}. \end{aligned}$$

Recall from Corollary 8.3 that this representation is unique. Then

$$\pi_A(g_n) = (i'_1, i'_2, \dots, i'_{n-1}, 1), \quad g_n \in G_n(A) = J_A^{-n} \mathbb{Z}^3,$$

and we note that

$$\pi_A(2g_n) = (\underbrace{i'_2, i'_3, \dots, i'_{n-1}}_{n-1 \text{ places}}, 1) = \pi_A(J_A g_n).$$

A similar remark applies to $F_B = G_B/\mathbb{Z}^3$, but there the scaling is by a power of 4. We have proved the following:

An element g of G_A is in $G_n(A)$ if and only if $2^n g \in \mathbb{Z}^3$.

Similarly, when $g \in G_B$, then $g \in G_n(B) = J_B^{-n} \mathbb{Z}^3$ if and only if $4^n g \in \mathbb{Z}^3$. We shall need this in the proof of Observation 11.2 below. (See Figure 16.)

In summary, both examples have $N = 3, D = 1$, and $\tau(K_0(\mathfrak{A})) = \mathbb{Z}[\frac{1}{2}]$, and the other data are as in Table 1 (above).

The proof of non-isomorphism for A and B uses the fact that $\langle \alpha_A | v_A \rangle$ and $\langle \alpha_B | v_B \rangle$ have different prime factors than 2 for their numerators.

Observation 11.2. Examples A and B correspond to non-isomorphic AF-algebras \mathfrak{A}_A and \mathfrak{A}_B .

The argument proves that there is not even a nontrivial homomorphism $\theta: G_B \rightarrow G_A$ which makes the diagrams in (11.7) and Figure 16 (below) commutative.

The nonexistent isomorphism $\theta: G_B \rightarrow G_A$:

$$(11.7) \quad \begin{array}{ccccccc} 0 & \longrightarrow & \ker(\tau_B) & \xrightarrow{i_B} & G_B & \xrightarrow{\tau_B} & \tau_B(G_B) \longrightarrow 0 \\ & & \cong \downarrow & & \downarrow \theta & & \cong \downarrow \\ & & \mathbb{Z}^2 & & \neq & & \mathbb{Z} \left[\frac{1}{2} \right] \\ & & \cong \downarrow & & \downarrow & & \cong \downarrow \\ 0 & \longrightarrow & \ker(\tau_A) & \xrightarrow{i_A} & G_A & \xrightarrow{\tau_A} & \tau_A(G_A) \longrightarrow 0 \end{array}$$

Proof. It is enough to show that G_A and G_B represent different elements of $\text{Ext}(\mathbb{Z}[\frac{1}{2}], \mathbb{Z}^2)$. This can be done by recursion, and use of the relations (a)–(b). Alternatively, it can be checked directly by the argument from the proof of Theorem 11.10 below that the two Ext-elements G_A and G_B are different in $\text{Ext}(\mathbb{Z}[\frac{1}{2}], \mathbb{Z}^2)$. Both arguments are essentially based on the $\langle \alpha | v \rangle$ -number, even though $\lambda_A \neq \lambda_B$. In the present case, $\lambda_A^2 = 4 = \lambda_B$, which is good enough. The present argument is essentially a “baby” version of the argument in the rest of this chapter.

We sketch the details. It is a proof by contradiction. Suppose θ were an isomorphism of the ordered K_0 -groups, say $\theta: G_B \rightarrow G_A$, which made them the same element of $\text{Ext}(\mathbb{Z}[\frac{1}{2}], \mathbb{Z}^2)$. Since $G_A = \bigcup_{n \geq 0} J_A^{-n} \mathbb{Z}^3$, there is a k such that $\theta(\mathbb{Z}^3) \subseteq J_A^{-k} \mathbb{Z}^3$. We then claim that $\theta(J_B^{-n} \mathbb{Z}^3) \subseteq J_A^{-(k+2n)} \mathbb{Z}^3$ for all n . The argument for this is based on properties (a)–(b) for the generators: Let $x \in \mathbb{Z}^3$. To verify that $\theta(J_B^{-n} x) \in J_A^{-k-2n} \mathbb{Z}^3$, we must check that $2^{2n+k} \theta(J_B^{-n} x) \in \mathbb{Z}^3$. This holds since $2^{2n+k} \theta(J_B^{-n} x) = 2^k \theta(4^n J_B^{-n} x) \in 2^k \theta(\mathbb{Z}^3) \subseteq 2^k J_A^{-k} \mathbb{Z}^3 \subseteq \mathbb{Z}^3$. Hence $2^{2n+k} \theta(J_B^{-n} x) \in \mathbb{Z}^3$, and therefore $\theta(J_B^{-n} x) \in J_A^{-(k+2n)} \mathbb{Z}^3$ as claimed.

These maps may be represented with matrices $\psi_n \in M_3(\mathbb{Z})$ as follows:

$$\theta(J_B^{-n} x) = J_A^{-(k+2n)} \psi_n(x), \quad x \in \mathbb{Z}^3, \quad n = 0, 1, 2, \dots,$$

with the consistency conditions

$$\psi_n = J_A^{2n} \psi_0 J_B^{-n}, \quad n \in \mathbb{N}.$$

Thus $\psi_0 = J_A^k \theta|_{\mathbb{Z}^3}$, and $\psi_n = J_A^{k+2n} \theta J_B^{-n}|_{\mathbb{Z}^3}$ (see Figure 16). This defines the sequence ψ_n as a sequence of linear endomorphisms of \mathbb{Z}^3 , and so each ψ_n is represented by a matrix in $M_3(\mathbb{Z})$. That turns out to be very restrictive. It is not satisfied for $\psi_0 = I_3$. In fact, even $J_A^2 J_B^{-1}$ has a non-integral entry. (The matrices ψ_n play the role of the intertwiners A_n in the diagram (5.50), with $A_1 = \psi_0$, $A_2 = \psi_1$, etc., but in the reasoning here positivity does not play a role.)

Let $v_A = \begin{pmatrix} 1 \\ 2 \\ 1 \end{pmatrix}$ and $v_B = \begin{pmatrix} 1 \\ 4 \\ 1 \end{pmatrix}$ be the normalized Perron–Frobenius eigenvectors:

$$J_A v_A = 2v_A, \quad J_B v_B = 4v_B.$$

Hence

$$\psi_n(v_B) = J_A^{2n} \psi_0 J_B^{-n} v_B = 4^{-n} J_A^{2n} \psi_0(v_B) \xrightarrow{n \rightarrow \infty} \frac{\tau_A(\psi_0 v_B)}{\tau_A(v_A)} v_A$$

by the Perron–Frobenius theorem. But

$$\tau_A(\psi_0 v_B) = 2^k \tau_B(v_B)$$

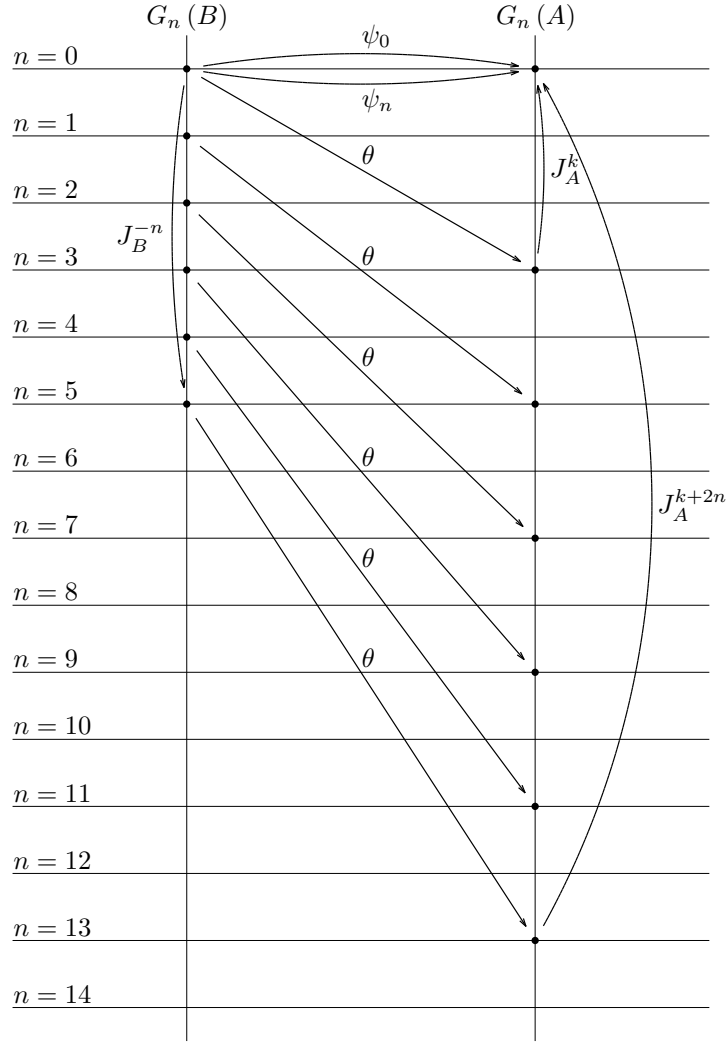

FIGURE 16. The (nonexistent) matrices ψ_n in the proof of Observation 11.2 (example with $k = 3$).

since θ preserves the normalized trace; see (11.7).

Hence, by taking n large, $\psi_n(v_B) \in \mathbb{Z}^3$ will be arbitrarily close to $2^k \frac{\tau_B(v_B)}{\tau_A(v_A)} v_A = 2^k \frac{11}{12} \begin{pmatrix} 1 \\ 2 \\ 1 \end{pmatrix}$, where we used the numbers from the last column in Table 1. If $(Q_{ij}^{(n)})_{i,j=1}^3$ denote the matrix entries of ψ_n , then $Q_{ij}^{(n)} \in \mathbb{Z}$, and $\psi_n(v_B)_1 = Q_{11}^{(n)} + 4Q_{12}^{(n)} + Q_{13}^{(n)}$. But they are integers, so there is an $n_0 \in \mathbb{N}$ such that $\mathbb{Z} \ni \psi_n(v_B)_1 = \frac{11 \cdot 2^k}{12}$ for all $n \geq n_0$. Since 3 does not divide 11, this is a contradiction. We have proved that the Ext-elements are different as claimed. \square

Remark 11.3. We will get back to the idea of defining θ by a matrix in $\mathrm{GL}(N, \mathbb{R})$ in a more systematic way later, in Proposition 11.7.

Let J be a matrix specified as in (11.2) and let $G = G_J$ be the corresponding inductive limit group (see Chapter 5). Recall $m_N = |\det J|$. Setting $G_i := J^{-i}\mathbb{Z}^N$, we shall use the homomorphisms, $g \mapsto m_N^i g$, in localizing the scaling G_i , $i = 1, 2, \dots$. It is immediate from the proof of Claim 8.2 that $m_N J^{-1}$ has integral entries, i.e., is in $M_N(\mathbb{Z})$. Since $m_N^i J^{-i} = (m_N J^{-1})^i$, this is also true for the iterations. We have proved the following implication:

$$(11.8) \quad g \in G_i \implies g \in G \quad \text{and} \quad m_N^i g \in \mathbb{Z}^N.$$

It will be useful that a scaled version of the converse also is true.

Proposition 11.4. *Let J be given as specified in (11.2). Then there exists a $p \in \mathbb{N}$ such that the following implication (a) \implies (b) holds for $g \in G_J$:*

$$\begin{aligned} (a) \quad & m_N g \in \mathbb{Z}^N \\ & \downarrow \\ (b) \quad & g \in J^{-p}(\mathbb{Z}^N) \end{aligned}$$

Furthermore, for the same $p \in \mathbb{N}$ we have the following implications for $g \in G_J$:

$$\begin{aligned} (c) \quad & m_N^i g \in \mathbb{Z}^N \\ & \downarrow \\ (d) \quad & g \in J^{-ip}(\mathbb{Z}^N) \text{ for } i = 1, 2, 3, \dots \end{aligned}$$

Proof. If $m_N g \in \mathbb{Z}^N$, then $g \in \frac{1}{m_N}\mathbb{Z}^N$, and hence g has the form

$$g = \frac{(k_1, \dots, k_N)}{m_N} + m$$

where $k_i \in \{0, 1, \dots, m_N - 1\}$ for $i = 1, \dots, N$, and $m \in \mathbb{Z}^N$. But G_J can contain at most m_N^N elements of the form $(k_1, \dots, k_N)/m_N$ where $k_i \in \{0, 1, \dots, m_N - 1\}$, and since this number is finite and

$$G_J = \bigcup_n J^{-n}\mathbb{Z}^N$$

is an increasing union, it follows that there is a $p \in \mathbb{N}$ such that all these elements are contained in $J^{-p}\mathbb{Z}^N$. But as $\mathbb{Z}^N \subseteq J^{-p}\mathbb{Z}^N$, the implication (a) \implies (b) follows.

Next, choose $p \in \mathbb{N}$ such that (a) \implies (b) holds. We prove by induction with respect to i that (c) \implies (d) holds. $i = 1$ is (a) \implies (b), so assume (c) \implies (d) holds for $i - 1$, and assume that $g \in G_J$ and

$$m_N^i g = m_N^{i-1} m_N g \in \mathbb{Z}^N.$$

By the induction hypothesis, we then have

$$m_N g \in J^{-p(i-1)}\mathbb{Z}^N.$$

But applying $J^{p(i-1)}$ to both sides, we have

$$m_N J^{p(i-1)} g \in \mathbb{Z}^N.$$

Applying the case $i = 1$, one obtains

$$J^{p(i-1)} g \in J^{-p}\mathbb{Z}^N,$$

and applying $J^{-p(i-1)}$ to both sides

$$g \in J^{-pi}\mathbb{Z}^N$$

and this proves (c) \Rightarrow (d). \square

Note that the implication (a) \Rightarrow (b) holds if there is a $p \in \mathbb{N}$, and an $E \in M_N(\mathbb{Z})$, such that

$$(11.9) \quad J^p = m_N E.$$

If (c) \Rightarrow (d) holds for all $g \in \mathbb{Q}^N$, then $J^{ip}(\mathbb{Z}^N) \subseteq m_N^i \mathbb{Z}^N$ for all i , so (11.9) is valid. Thus (11.9) is stronger than (c) \Rightarrow (d).

Definition 11.5. Suppose J is a matrix of the form (11.2). We say that J has *scaling degree* $\leq p$, and write $\text{deg}(J) \leq p$ if there exists an $n_0 \in \mathbb{N}$ such that, for $g \in G_J$,

$$m_N^i g \in \mathbb{Z}^N \implies g \in J^{-[ip]-n_0} \mathbb{Z}^N.$$

More generally, if m is a positive integer containing exactly the same prime factors as m_N , we say that J has *m -scaling degree* $\leq p = p^{(m)}$ and write $m\text{-deg}(J) \leq p$ if there exists an $n_0 \in \mathbb{N}$ such that, for $g \in G_J$

$$m^i g \in \mathbb{Z}^N \implies g \in J^{-[ip]-n_0} \mathbb{Z}^N.$$

Note that as m contains the same prime factors as m_N , J has a finite m -scaling degree if and only if it has a finite scaling degree, and the last is true by Proposition 11.4.

We note *en passant* that the above remark implies the following corollary, which is true whether the Perron–Frobenius eigenvalue λ is rational or not. (But if λ is rational under the conditions in the corollary, it follows from the characteristic equation that $\text{Prim}(\lambda) \subseteq \text{Prim}(m_N)$).

Corollary 11.6. *Let J be a matrix of the form (11.2), and assume that each m_i is either 0 or contains all the prime factors of m_N . It follows that*

$$G = \mathbb{Z} \left[\frac{1}{m_N} \right]^N$$

when G is identified as a subgroup of \mathbb{Q}^N by (5.6).

Proof. Since $J^{-1} = \frac{1}{m_N} E$ where E is a matrix with integer coefficients, it is clear from (5.6) that

$$G \subseteq \mathbb{Z} \left[\frac{1}{m_N} \right]^N.$$

But it follows from (11.9) that

$$\frac{1}{m_N^n} \mathbb{Z}^N \subseteq J^{-pn} \mathbb{Z}^N \subseteq G$$

for $n = 1, 2, \dots$, and hence the converse inclusion is valid. \square

It follows from the inductive limit construction for G , i.e., $G = \bigcup_{i \geq 0} G_i$, $G_i \subseteq G_{i+1}$, that if the implication (c) \Rightarrow (d) holds for some $p \in \mathbb{N}$, then it also holds for $p+1$, and so the scaling degree is well defined.

While the two groups from (10.11), $K_0(\mathfrak{A}_{J_L})$ and $K_0(\mathfrak{A}_{L'})$, agree, the relationship between the corresponding scale of subgroups is more subtle. Using (11.9) we can establish the following subgroup inclusions:

$$(11.10) \quad \text{(a) } G_i \subseteq G'_{6i} \quad \text{and} \quad \text{(b) } G'_i \subseteq G_{3i},$$

where

$$G_k := J_L^{-k} \mathbb{Z}^2 \quad \text{and} \quad G'_k := J_{L'}^{-k} \mathbb{Z}^2.$$

To prove this, let $J = J_L$ and $K = J_{L'}$. We proved after the statement of (11.9) that there is an $E \in M_2(\mathbb{Z})$ such that $J^3 = 16E$. Since $16K^{-1} \in M_2(\mathbb{Z})$, we conclude that

$$J^3K^{-1} = E \cdot (16K^{-1}) \in M_2(\mathbb{Z})$$

and so

$$K^{-1}\mathbb{Z}^2 \subseteq J^{-3}\mathbb{Z}^2.$$

Similarly

$$J^{3i}K^{-i} = E^i (16^i K^{-1}) \in M_2(\mathbb{Z})$$

since each factor is in $M_2(\mathbb{Z})$. This yields

$$K^{-i}\mathbb{Z}^2 \subseteq J^{-3i}\mathbb{Z}^2,$$

which is the assertion (11.10)(b). The claim (11.10)(a) follows by the same argument applied to the factorization $K^6 = 32F$ for some $F \in M_2(\mathbb{Z})$, and $32J^{-1} \in M_2(\mathbb{Z})$.

The discussion above leads to the notion of the *degree* of an isomorphism or homomorphism $\theta: G \rightarrow G'$ as follows. When talking about isomorphisms and homomorphisms, we will henceforth always assume that $\theta([\mathbb{1}]) = [\mathbb{1}']$, i.e., in the concrete representations,

$$(11.11) \quad G = \bigcup_n J^{-n}\mathbb{Z}^N = \bigcup_n G_n, \quad G' = \bigcup_n J'^{-n}\mathbb{Z}^N = \bigcup_n G'_n,$$

θ maps $\begin{pmatrix} 1 \\ 0 \\ \vdots \\ 0 \\ 0 \end{pmatrix}$ into $\begin{pmatrix} 1 \\ 0 \\ \vdots \\ 0 \\ 0 \end{pmatrix}$. We may assume $N = N'$ in the discussion since N is an isomorphism invariant. But as θ is an order isomorphism, this means that $\tau' \circ \theta = \tau$ for the associated normalized traces. Recall from (5.20) that

$$(11.12) \quad \tau' = \langle 1, a', a'^2, \dots, a'^{N-1} \rangle, \quad \tau = \langle 1, a, \dots, a^{N-1} \rangle$$

where $a' = 1/\lambda'$, $a = 1/\lambda$ where λ is the Perron–Frobenius eigenvalue of J' , J , respectively.

The following proposition is a globalization of Corollary 5.1.

Proposition 11.7. *A map*

$$(11.13) \quad \theta: G = \bigcup_n J^{-n}\mathbb{Z}^N \rightarrow G' = \bigcup_n J'^{-n}\mathbb{Z}^N$$

is an isomorphism between the ordered groups (G, G_+) and (G', G'_+) (mapping $[\mathbb{1}]$ into $[\mathbb{1}']$) if and only if there exists a matrix $\Lambda \in \mathrm{GL}(N, \mathbb{R})$ and a sequence (n_i) in \mathbb{N} with the following properties:

1. $\theta(g) = \Lambda g$ for $g \in G \subseteq \mathbb{R}^N$;
2. $\alpha' \Lambda = \alpha$ where $\alpha = (1, a, \dots, a^{N-1})$, etc.;
3. $J'^{n_i} \Lambda J^{-i} \in M_N(\mathbb{Z})$ for $i = 1, 2, \dots$;
4. $J^{n_i} \Lambda^{-1} J'^{-i} \in M_N(\mathbb{Z})$ for $i = 1, 2, \dots$;
5. $\Lambda \begin{pmatrix} 1 \\ 0 \\ \vdots \\ 0 \end{pmatrix} = \begin{pmatrix} 1 \\ 0 \\ \vdots \\ 0 \end{pmatrix}$.

(11.14)

Furthermore, θ is a homomorphism from (G, G_+) into (G', G'_+) (mapping $[\mathbf{1}]$ into $[\mathbf{1}']$) if and only if there exists a matrix $\Lambda \in M_N(\mathbb{R})$ with the properties (1), (2), (3) and (5). In both cases we actually have

$$\Lambda \in M_N \left(\frac{1}{m_N'^{n_1}} \mathbb{Z} \right)$$

Proof. Assume first that θ is given, and define the matrix Λ by

$$(11.15) \quad \Lambda = \left(\theta \begin{pmatrix} 1 \\ 0 \\ 0 \\ \vdots \\ 0 \end{pmatrix}, \theta \begin{pmatrix} 0 \\ 1 \\ 0 \\ \vdots \\ 0 \end{pmatrix}, \dots, \theta \begin{pmatrix} 0 \\ 0 \\ 0 \\ \vdots \\ 1 \end{pmatrix} \right).$$

If $g \in G$, then $g \in G_i = J^{-i}\mathbb{Z}^N$ for some i , and hence $g \in m_N^{-i}\mathbb{Z}^N$, i.e., $m_N^i g \in \mathbb{Z}^N$. But then

$$(11.16) \quad m_N^i \theta(g) = \theta(m_N^i g) = \Lambda(m_N^i g) = m_N^i \Lambda g$$

and as G has no torsion,

$$(11.17) \quad \theta(g) = \Lambda g$$

which shows (1). But then (2) follows from $\tau' \circ \theta = \tau$. Furthermore, as $G_i = J^{-i}\mathbb{Z}^N$ is finitely generated, it follows that $\theta(G_i) \subseteq G'_{n_i}$ for some n_i , i.e.,

$$(11.18) \quad \Lambda J^{-i}\mathbb{Z}_N \subseteq J^{-n_i}\mathbb{Z}_N$$

which shows (3). The property (4) follows likewise from $\theta^{-1}(G'_i) \subseteq G_{m_i}$ for some m_i . Property (5) follows from

$$(11.19) \quad \theta([\mathbf{1}]) = [\mathbf{1}'].$$

Conversely, if $\Lambda \in \text{GL}(N, \mathbb{R})$ is given with the properties (2)–(4), one deduces that θ defined by (1) has the properties:

$$(11.20) \quad \begin{aligned} \tau' \circ \theta &= \tau, \\ \theta(G_i) &\subseteq G'_{n_i}, \\ \theta^{-1}(G'_i) &\subseteq G_{m_i}, \\ \theta([\mathbf{1}]) &= [\mathbf{1}'], \end{aligned}$$

so θ is an order-automorphism from the property (5.34), i.e.,

$$(11.21) \quad G_+ = \{g \in G \mid \tau(g) > 0\} \cup \{0\}.$$

The last statements in Proposition 11.7 are straightforward from $|\det(J'^{n_i})| = m_N'^{m_i}$. \square

Our next aim is to show that the constants n_i, m_i in Proposition 11.7 can be chosen such that they increase linearly with i . First, a definition:

Definition 11.8. Adopt the notation (11.11), and let θ be a homomorphism from G into G' . We say that the degree of $\theta \leq s$, and write $\text{deg}(\theta) \leq s$, if there exists an $n_0 \in \mathbb{N}$ such that

$$(11.22) \quad \theta(G_i) \subseteq G'_{n_0 + [si]}$$

for all $i \in \mathbb{N}$. (Here $[si]$ is the largest integer $\leq si$).

We next show that *any* homomorphism $\theta: G \rightarrow G'$ (mapping $[\mathbb{1}]$ into $[\mathbb{1}']$) has a finite degree which can be computed in concrete examples.

Proposition 11.9. *Let $G = G_J$, $G' = G_{J'}$ and let θ be a morphism from G into G' mapping $[\mathbb{1}]$ into $[\mathbb{1}']$. Assume that $N = N'$, $\text{Prim}(m_N) = \text{Prim}(m'_N)$ and let $m = \text{lcm}(m_N, m'_N)$. Then*

$$(11.23) \quad \deg \theta \leq m\text{-deg}(J').$$

(The last statement means that if $m\text{-deg}(J') \leq s$, then $\deg \theta \leq s$.)

Proof. If

$$(11.24) \quad \theta: \bigcup_n J^{-n} \mathbb{Z}^N \longrightarrow \bigcup_n J'^{-n} \mathbb{Z}^N$$

is a morphism, there is a k_0 such that

$$(11.25) \quad \theta(\mathbb{Z}^N) \subseteq J'^{-k_0} \mathbb{Z}^N = G'_{k_0}.$$

Then

$$(11.26) \quad \begin{aligned} m^{k_0+i} \theta(G_i) &= \left(\frac{m}{m_N}\right)^i m^{k_0} \theta(m_N^i G_i) \\ &\subseteq \left(\frac{m}{m_N}\right)^i m^{k_0} \theta(\mathbb{Z}^N) \\ &= \left(\frac{m}{m_N}\right)^i \left(\frac{m}{m'_N}\right)^{k_0} m'^{k_0} \theta(\mathbb{Z}^N) \\ &\subseteq \left(\frac{m}{m_N}\right)^i \left(\frac{m}{m'_N}\right)^{k_0} m'^{k_0} G'_{k_0} \\ &\subseteq \left(\frac{m}{m_N}\right)^i \left(\frac{m}{m'_N}\right)^{k_0} \mathbb{Z}^N \\ &\subseteq \mathbb{Z}^N. \end{aligned}$$

Thus, if $m\text{-deg}(J') \leq p$, then

$$(11.27) \quad \theta(G_i) \subseteq G'_{[(i+k_0)p]+n_0}$$

for some n_0 and all i , and hence $\deg \theta \leq p$. \square

Note now that if

$$(11.28) \quad m\text{-deg}(J') \leq \frac{p}{q}$$

where $p, q \in \mathbb{N}$, then the conclusion in Proposition 11.9 says that there is an n_0 such that

$$(11.29) \quad J'^{np+n_0} \Lambda J^{-nq} \in M_N(\mathbb{Z})$$

for $n = 1, 2, \dots$, where Λ is the matrix in Proposition 11.7. This implies the main result on the Ext-invariant in this chapter, which, together with Remark 11.11, is surprisingly effective in establishing non-isomorphism when all the elementary invariants in Chapter 7 are the same.

Theorem 11.10. *Let J, J' be matrices of the form (11.2) with $N = N'$ and $\text{Prim } m_N = \text{Prim } m'_N$. Assume that the associated Perron–Frobenius eigenvalues λ, λ' are rational (and thus integers), and let $m = \text{lcm}(m_N, m'_N)$. Assume there exist rational numbers p, q with*

$$(11.30) \quad m\text{-deg}(J') \leq \frac{p}{q}$$

and such that

$$(11.31) \quad \lambda'^p = \lambda^q.$$

Let α', α , resp. v', v , be the left, respectively right, Perron–Frobenius eigenvectors of J, J' given by (5.17), (14.5), respectively.

If there exists a unital isomorphism $\mathfrak{A}_J \rightarrow \mathfrak{A}_{J'}$, then

$$(11.32) \quad \frac{\langle \alpha | v \rangle}{\langle \alpha' | v' \rangle} \in \mathbb{Z} \left[\frac{1}{\lambda'} \right].$$

Remark 11.11. A rather effective “workhorse” to show non-isomorphism in cases where all the basic invariants in Theorem 7.8 are the same and the Perron–Frobenius eigenvalues are integers, is to use Theorem 11.10 together with the fact that $m'_N\text{-deg}(J') = 1$ if m'_{N-1} is nonzero and m'_N, m'_{N-1} are mutually prime. See Proposition 11.25 and Remark 11.23 below. More generally, $m'_N\text{-deg}(J') = n$ if $m'_{N-k} = 0 \pmod{m_N}$ for $k = 1, \dots, n-1$ and m'_{N-n} and m'_N are mutually prime.

Note for example that this theorem covers the two matrices:

$$J_A = \begin{pmatrix} 0 & 1 & 0 \\ 3 & 0 & 1 \\ 2 & 0 & 0 \end{pmatrix} \quad J_B = \begin{pmatrix} 0 & 1 & 0 \\ 15 & 0 & 1 \\ 2 & 0 & 0 \end{pmatrix}$$

considered in Observation 11.2. We have $\lambda_A = 2, \lambda_B = 4$, and since 3 and 15 are mutually prime with 2, we have $2 \deg J_A = 1 = 4 \deg J_B$. (This also follows from Lemma 11.14). Using the computation in Observation 11.2,

$$\langle \alpha_A | v_A \rangle = \frac{9}{4}, \quad \langle \alpha_B | v_B \rangle = \frac{13}{4}.$$

Since $1\text{-deg } J_A = 1$, we have $2\text{-deg } J_A = 2$ by Proposition 11.4, and applying Theorem 11.10 with $m = \text{lcm}(2, 4) = 4, J' = J_A, J = J_B, p = 2, q = 1$, we see that (11.32) takes the form

$$\frac{13}{9} \in \mathbb{Z} \left[\frac{1}{2} \right]$$

which is clearly false. Hence, there is no unital morphism $\mathfrak{A}_B \rightarrow \mathfrak{A}_A$. Of course, the proof of Theorem 11.10 is just a more general version of the proof of Observation 11.2.

Proof. By (11.30) in the form (11.29), it follows that there exists an n_0 such that

$$(11.33) \quad J'^{np+n_0} \Lambda J^{-nq} \in M_N(\mathbb{Z})$$

for $n = 1, 2, \dots$, when Λ is the matrix associated to the homomorphism

$$\theta: G_\Gamma \longrightarrow G_{\Gamma'}$$

by Proposition 11.7. We have

$$(11.34) \quad J'^{np+n_0} \Lambda J^{-nq} v = \lambda^{-nq} J'^{np+n_0} \Lambda v$$

Since $\lambda^{-nq}\lambda'^{np} = 1$ for all n , it follows from Perron–Frobenius theory that there exists a constant $c \in \mathbb{R}$ such that

$$(11.35) \quad \lim_{n \rightarrow \infty} \lambda^{-nq} J'^{np+n_0} \Lambda v = cv'.$$

But the first component of v' is 1 by (14.5) and

$$J'^{np+n_0} \Lambda J^{-nq} \in M_N(\mathbb{Z})$$

for all n , and since *all* components of v are integer by (14.5) and $\lambda \in \mathbb{N}$, it follows that c is an integer. But it follows from (11.35) that

$$\begin{aligned} c \langle \alpha' | v' \rangle &= \lim_{n \rightarrow \infty} \lambda^{-nq} \langle \alpha' | J'^{np+n_0} \Lambda v \rangle \\ &= \lim_{n \rightarrow \infty} \lambda^{-nq} \lambda'^{np+n_0} \langle \alpha' | \Lambda v \rangle \\ &= \lambda'^{n_0} \langle \alpha | v \rangle \end{aligned}$$

where we used (11.14)(2). It follows that

$$\frac{\langle \alpha | v \rangle}{\langle \alpha' | v' \rangle} = \frac{c}{\lambda'^{n_0}}$$

so

$$\frac{\langle \alpha | v \rangle}{\langle \alpha' | v' \rangle} \in \mathbb{Z} \left[\frac{1}{\lambda'} \right] = \mathbb{Z} \left[\frac{1}{\lambda} \right]. \quad \square$$

We will often apply this theorem in the following special form:

Corollary 11.12. *Let J, J' be matrices of the form (11.2) with $N = N'$ and $m_N | m'_{N'}$, and same Perron–Frobenius eigenvalue $\lambda = \lambda'$. If $\deg(J') \leq 1$ and there exists a unital morphism $\mathfrak{A}_J \rightarrow \mathfrak{A}_{J'}$, then*

$$(11.36) \quad \frac{\langle \alpha | v \rangle}{\langle \alpha' | v' \rangle} \in \mathbb{Z} \left[\frac{1}{\lambda'} \right] = \mathbb{Z} \left[\frac{1}{\lambda} \right].$$

Proof. In this case $m = m'_N$. □

The following even more special corollary will be useful in Chapter 16.

Corollary 11.13. *Let J, J' be matrices of the form (11.2) with $N = N'$ and $m_N = m_{N'} = \lambda = \lambda'$. If there exists a unital morphism $\mathfrak{A}_J \rightarrow \mathfrak{A}_{J'}$, then*

$$(11.37) \quad \frac{\langle \alpha | v \rangle}{\langle \alpha' | v' \rangle} \in \mathbb{Z} \left[\frac{1}{\lambda} \right].$$

Proof. First apply Lemma 11.14 below to deduce m_N -deg $J = 1$ and m'_k -deg $J' = 1$. But then we may apply Theorem 11.10 with $p = q = 1$ and $m = m_N = m'_N$. □

Lemma 11.14. *Let J be a matrix of the form (11.2) with $m_N = \lambda$. Then*

$$(11.38) \quad m_N\text{-deg}(J) = \deg(J) = 1.$$

Remark 11.15. If $\lambda = m_N$, it follows that $R_D = \lambda = \pm m_N$ and $Q_{N-D} = \pm 1$ in (7.15), hence $|\det J_0| = 1$ where J_0 is given by (9.3) and $\ker \tau \cong \mathbb{Z}^{N-1}$ by Theorem 7.8. Conversely, if $\ker \tau \cong \mathbb{Z}^{N-1}$ we must have $|\det J_0| = 1$, hence $R_D = \pm \lambda = \pm m_N$, i.e., $\lambda = m_N$.

Conclusion:

$$\lambda = m_N \iff \ker \tau \cong \mathbb{Z}^{N-1}.$$

The theory for the $\lambda = m_N$ case will be developed in much more detail in Chapter 17.

Proof. If $\lambda = m_N$, the matrix $J_B^\mathcal{B}$ in (7.15) takes the form (now $D = 1$):

$$(11.39) \quad J_B^\mathcal{B} = \begin{pmatrix} Q_1 & 1 & 0 & \cdots & 0 & 0 & Q_1 \\ Q_2 & 0 & 1 & \cdots & 0 & 0 & Q_2 \\ Q_3 & 0 & 0 & \ddots & 0 & 0 & Q_3 \\ \vdots & \vdots & & \ddots & \ddots & \vdots & \vdots \\ Q_{N-2} & 0 & 0 & & 0 & 1 & Q_{N-2} \\ -1 & 0 & 0 & \cdots & 0 & 0 & -1 \\ 0 & 0 & 0 & \cdots & 0 & 0 & m_N \end{pmatrix}$$

where

$$(11.40) \quad \begin{aligned} Q_1 &= m_1 - \lambda \\ Q_2 &= m_2 + \lambda m_1 - \lambda^2 \\ Q_3 &= m_3 + \lambda m_2 + \lambda^2 m_1 - \lambda^3 \\ &\vdots \\ Q_{N-1} &= m_{N-1} + \lambda m_{N-2} + \cdots + \lambda^{N-2} m_1 - \lambda^{N-1} = -1 \end{aligned}$$

Note in passing that

$$(11.41) \quad v = \begin{pmatrix} 1 \\ -Q_1 \\ -Q_2 \\ \vdots \\ -Q_{N-1} \end{pmatrix}$$

is the right Perron–Frobenius eigenvector of J by (14.5).

Using (7.24) one computes that

$$(11.42) \quad J_B^{\mathcal{B}-1} = \left(\begin{array}{cccccc|c} 0 & 0 & \cdots & 0 & 0 & -1 & -\frac{1}{m_N} \\ 1 & 0 & & 0 & 0 & Q_1 & 0 \\ 0 & 1 & \ddots & & 0 & Q_2 & 0 \\ \vdots & \vdots & \ddots & \ddots & & \vdots & \vdots \\ 0 & 0 & \cdots & 1 & 0 & Q_{N-3} & 0 \\ 0 & 0 & \cdots & 0 & 1 & Q_{N-2} & 0 \\ \hline 0 & 0 & \cdots & 0 & 0 & 0 & \frac{1}{m_N} \end{array} \right)$$

Iterating, one computes that

$$(11.43) \quad J_{\mathcal{B}}^{\mathcal{B}-k} = \left(\begin{array}{cccc|ccc} & & & & p_1^{(k)}\left(\frac{1}{m_N}\right) & & \\ & & & & \vdots & & \\ & & & & \vdots & & \\ & & & & p_{N-1}^{(k)}\left(\frac{1}{m_N}\right) & & \\ \hline 0 & 0 & \cdots & \cdots & 0 & 0 & \frac{1}{m_N^k} \end{array} \right)$$

where $p_l^{(k)}(x) \in \mathbb{Z}[x]$ and the degree of the polynomial $p_l^{(k)}$ is:

$$\deg p_l^{(k)} = (k - l + 1) \vee 0$$

for $l = 1, \dots, N - 1$. Using this and the transformation matrix

$$(11.44) \quad I_{\mathcal{A}}^{\mathcal{B}} = (I_{\mathcal{B}}^{\mathcal{A}})^{-1} = \begin{pmatrix} 0 & -\frac{1}{m_N} & -\frac{1}{m_N^2} & \cdots & -\frac{1}{m_N^{N-3}} & -\frac{1}{m_N^{N-2}} & -\frac{1}{m_N^{N-1}} \\ 0 & 0 & -\frac{1}{m_N} & & -\frac{1}{m_N^{N-4}} & -\frac{1}{m_N^{N-3}} & -\frac{1}{m_N^{N-2}} \\ \vdots & & \ddots & \ddots & & \vdots & \vdots \\ \vdots & & & \ddots & \ddots & \vdots & \vdots \\ 0 & 0 & 0 & & 0 & -\frac{1}{m_N} & -\frac{1}{m_N^2} \\ 0 & 0 & 0 & \cdots & 0 & 0 & -\frac{1}{m_N} \\ 1 & \frac{1}{m_N} & \frac{1}{m_N^2} & \cdots & \frac{1}{m_N^{N-3}} & \frac{1}{m_N^{N-2}} & \frac{1}{m_N^{N-1}} \end{pmatrix}$$

and the definition of m_N -deg together with (7.45) one has to show that for any $l, k \in \mathbb{N}$ with $l \leq k$ and any $n \in \mathbb{Z}^N$ that

$$(11.45) \quad \begin{cases} m_N^l J_{\mathcal{B}}^{\mathcal{B}-k} I_{\mathcal{A}}^{\mathcal{B}} n \in I_{\mathcal{A}}^{\mathcal{B}} \mathbb{Z}^N \\ \quad \quad \quad \downarrow \\ J_{\mathcal{B}}^{\mathcal{B}-k} I_{\mathcal{A}}^{\mathcal{B}} n \in J_{\mathcal{B}}^{\mathcal{B}-l} I_{\mathcal{A}}^{\mathcal{B}} \mathbb{Z}^N \\ \quad \quad \quad \updownarrow \\ J_{\mathcal{B}}^{\mathcal{B}l-k} I_{\mathcal{A}}^{\mathcal{B}} n \in I_{\mathcal{A}}^{\mathcal{B}} \mathbb{Z}^N. \end{cases}$$

(The last equivalence is trivial.) This can be done by brute force, looking at highest order terms in $\frac{1}{m_N}$. We do omit the painful details, however, since the result can also be proved by another method described below. \square

The alternative way of proving Lemma 11.14 is based on:

Proposition 11.16. *Let J be a matrix of the form (11.2) with $m_N = \lambda = m$. Use the concrete realization (5.6) or (9.1) of $G = K_0(\mathfrak{A}_J)$, and define $F = G/\mathbb{Z}^N$. Then the generators x_1, x_2, x_3 of F defined in Lemma 9.2 satisfy*

$$(11.46) \quad mx_1 = 0$$

and

$$(11.47) \quad mx_i = x_{i-1}, \quad i = 2, 3, \dots$$

Thus,

$$(11.48) \quad F \cong \mathbb{Z} \left[\frac{1}{m} \right] / \mathbb{Z}$$

the isomorphism being given by

$$(11.49) \quad x_i \longrightarrow \frac{1}{m^i}.$$

Proof. From the relations (11.40), it follows that

$$(11.50) \quad \begin{aligned} m_1 &= Q_1 + m \\ m_2 &= -mQ_1 + Q_2 \\ m_3 &= -mQ_2 + Q_3 \\ &\vdots \\ m_{N-1} &= -mQ_{N-2} + Q_{N-1} \\ m_N &= m = -mQ_{N-1} \Rightarrow Q_{N-1} = -1. \end{aligned}$$

Inserting these relations in the relations (9.10) for x_i in Lemma 9.2 gives

$$(11.51) \quad \begin{aligned} mx_i &= x_{i-N} - (Q_1 + m)x_{i-N+1} \\ &\quad - (-mQ_1 + Q_2)x_{i-N+2} \\ &\quad - (-mQ_2 + Q_3)x_{i-N+3} \\ &\quad - \dots \\ &\quad - (-mQ_{N-2} + Q_{N-1})x_{i-1}. \end{aligned}$$

We know already from (9.9) that $x_i = 0$ for $i = 1 - N, 2 - N, \dots, 0$. Assume by induction that $x_{j-1} = mx_j$ for all $j < i$. It follows from (11.51) that

$$\begin{aligned} mx_i &= x_{i-N} - Q_1x_{i-N+1} - x_{i-N} \\ &\quad - Q_2x_{i-N+2} + Q_1x_{i-N+1} \\ &\quad - Q_3x_{i-N+3} + Q_2x_{i-N+2} \\ &\quad - \dots \\ &\quad - Q_{N-1}x_{i-1} + Q_{N-2}x_i \\ &= -(-1)x_{i-1} = x_{i-1}. \end{aligned}$$

This shows (11.47), and the remaining statements in Proposition 11.16 are obvious. \square

Alternative Proof of Lemma 11.14. Use the notation of Proposition 11.16 and define

$$(11.52) \quad G_i = J^{-i}\mathbb{Z}^N, \quad F_i = G_i / \mathbb{Z}^N.$$

It follows from Proposition 11.16 that

$$(11.53) \quad F_i \cong \mathbb{Z}_{N^i} = \mathbb{Z} / N^i\mathbb{Z}.$$

The conclusion in Lemma 11.14 is

$$(11.54) \quad G_i = \{g \in G \mid m^i g \in \mathbb{Z}^n\}.$$

But

$$(11.55) \quad m^i g \in \mathbb{Z}^N \iff m^i(g + \mathbb{Z}^n) = 0,$$

so this conclusion is equivalent to

$$(11.56) \quad F_i = \{h \in F \mid m^i F = 0\}.$$

But the last statement is obvious from (11.49) and (11.53). This proves Lemma 11.14. \square

We will now prove a theorem somewhat close in spirit to Theorem 11.10. If G is a torsion free abelian group, and $n = 2, 3, 4, \dots$, we define

$$(11.57) \quad \begin{aligned} D_n(G) &= \bigcap_{k=1}^{\infty} n^k G \\ &= \text{the set of elements} \\ &\quad \text{of } G \text{ which are} \\ &\quad \text{infinitely divisible by } n. \end{aligned}$$

$D_n(G)$, as well as its rank, is clearly an isomorphism invariant of G , and any homomorphism $G \rightarrow G'$ will map $D_n(G)$ into $D_n(G')$. $D_n(G)$ only depends on G and the prime factors of n , and $D_n(G)$ is in a natural way a $\mathbb{Z}[\frac{1}{n}]$ -module. Note that even if the rank of $D_n(G)$ is 1, $D_n(G)$ is not necessarily isomorphic to $\mathbb{Z}[\frac{1}{n}]$, as seen from the example $G = \mathbb{Z}[\frac{1}{6}]$ and $n = 2$. But in the rank 1 case, $D_n(G)$ is isomorphic with a subgroup of the additive group \mathbb{R} containing $\mathbb{Z}[\frac{1}{n}]$.

In the special case that $G = K_0(\mathfrak{A}_J)$, where J is a matrix of the form (11.2), and the Perron–Frobenius eigenvalue λ of J is rational, and thus an integer, we note that the right Perron–Frobenius eigenvector v , normalized as in (14.5), is contained in $D_\lambda(G)$. In fact, since $J^{-1}v = \lambda^{-1}v$ we have

$$(11.58) \quad D_\lambda(G) \supseteq \mathbb{Z}[\frac{1}{\lambda}]v.$$

If, furthermore, $\text{rank}(D_\lambda(G)) = 1$, there exists a subgroup $D_\lambda^{\mathbb{Q}}(G) \subseteq \mathbb{Q}$ such that

$$(11.59) \quad D_\lambda(G) = D_\lambda^{\mathbb{Q}}(G)v$$

and this identity defines an isomorphism between $D_\lambda(G)$ and $D_\lambda^{\mathbb{Q}}(G)$.

Let $D_\lambda^{\mathbb{Q}U}(G)$ be the set of multiplicatively invertible elements of $D_\lambda^{\mathbb{Q}}(G)$, so if for example $D_\lambda^{\mathbb{Q}U}(G) = \mathbb{Z}[\frac{1}{n}]$, this is the set of numbers of the form $p_1^{n_1} p_2^{n_2} \dots p_m^{n_m}$ where $p_1 \dots p_m$ are the prime factors in n and $n_1, n_2, \dots, n_m \in \mathbb{Z}$.

Theorem 11.17. *Let J, J' be matrices of the form (11.2) with rational Perron–Frobenius eigenvalues λ, λ' and $\text{Prim}(\lambda) = \text{Prim}(\lambda') = \{p_1, \dots, p_m\}$. Assume*

$$\text{rank}(D_{\lambda'}(K_0(\mathfrak{A}_{J'}))) = 1$$

and let α, α' , resp. v, v' , be the left, respectively right, Perron–Frobenius eigenvectors of J, J' given by (5.17), (14.5), respectively. If there exists a unital morphism $\mathfrak{A}_J \rightarrow \mathfrak{A}_{J'}$, then

$$(11.60) \quad \frac{\langle \alpha \mid v \rangle}{\langle \alpha' \mid v' \rangle} \in D_{\lambda'}^{\mathbb{Q}}(G')$$

In particular, if

$$(11.61) \quad D_{\lambda'}(K_0(\mathfrak{A}_{J'})) = \mathbb{Z}[\frac{1}{\lambda'}]v'$$

we conclude

$$(11.62) \quad \frac{\langle \alpha | v \rangle}{\langle \alpha' | v' \rangle} \in \mathbb{Z} \left[\frac{1}{\lambda} \right] = \mathbb{Z} \left[\frac{1}{\lambda'} \right].$$

If in addition the unital homomorphism $\mathfrak{A}_J \rightarrow \mathfrak{A}_{J'}$ is an isomorphism, and

$$(11.63) \quad D_\lambda(K_0(\mathfrak{A}_J)) = \mathbb{Z} \left[\frac{1}{\lambda} \right] v,$$

then there exist integers n_1, \dots, n_m such that

$$(11.64) \quad \frac{\langle \alpha | v \rangle}{\langle \alpha' | v' \rangle} = p_1^{n_1} p_2^{n_2} \cdots p_m^{n_m}.$$

Remark 11.18. It does not suffice instead of (11.61) to assume that $D_{\lambda'}(K_0(\mathfrak{A}_{J'}))$ is isomorphic to $\mathbb{Z} \left[\frac{1}{\lambda'} \right]$, because, say, $\mathbb{Z} \left[\frac{1}{\lambda'} \right] / p$ is isomorphic to $\mathbb{Z} \left[\frac{1}{\lambda'} \right]$ if p is a prime not in the set $\{p_1, \dots, p_m\}$. For the same reason, even though the existence of an isomorphism $\mathfrak{A}_J \rightarrow \mathfrak{A}_{J'}$ implies that $D_\lambda(K_0(\mathfrak{A}_J)) \approx \mathbb{Z} \left[\frac{1}{\lambda'} \right]$ one cannot omit condition (11.63) to obtain (11.64). See the proof for explanation of this.

Proof. Let $\psi: K_0(\mathfrak{A}_J) \rightarrow K_0(\mathfrak{A}_{J'})$ be the K -theory morphism defined by the morphism $\mathfrak{A}_J \rightarrow \mathfrak{A}_{J'}$. Since $\text{Prim}(\lambda) = \text{Prim}(\lambda')$ we have

$$D_\lambda(K_0(\mathfrak{A}_J)) = D_{\lambda'}(K_0(\mathfrak{A}_{J'}))$$

and since

$$D_{\lambda'}(K_0(\mathfrak{A}_{J'})) = D_{\lambda'}^{\mathbb{Q}}(G')v'$$

and thus

$$\psi(v) \in \psi(D_\lambda(K_0(\mathfrak{A}_J))) \subseteq D_{\lambda'}^{\mathbb{Q}}(G')v'$$

there is a $\xi \in D_{\lambda'}^{\mathbb{Q}}(G')$ such that

$$\psi(v) = \xi v'.$$

Apply $\langle \alpha' |$ to both sides

$$\langle \alpha' | \psi(v) \rangle = \xi \langle \alpha' | v' \rangle.$$

But since the morphism is assumed to be unital, we have $\langle \alpha' | \psi = \langle \alpha |$ by uniqueness of the trace, and hence

$$\langle \alpha | v \rangle = \xi \langle \alpha' | v' \rangle.$$

This proves (11.60). Since (11.61) means $D_{\lambda'}^{\mathbb{Q}}(K_0(\mathfrak{A}_{J'})) = \mathbb{Z} \left[\frac{1}{\lambda'} \right]$, (11.62) follows. Finally, if the homomorphism $\mathfrak{A}_J \rightarrow \mathfrak{A}_{J'}$ is an isomorphism and (11.63) holds, it follows by reverting the proof that $\frac{\langle \alpha' | v' \rangle}{\langle \alpha | v \rangle} \in \mathbb{Z} \left[\frac{1}{\lambda} \right]$, and thus $\frac{\langle \alpha | v \rangle}{\langle \alpha' | v' \rangle}$ has a multiplicative inverse in $\mathbb{Z} \left[\frac{1}{\lambda} \right]$. But multiplicative invertible elements of $\mathbb{Z} \left[\frac{1}{\lambda} \right]$ have the form on the right-hand side of (11.64). \square

There is one interesting circumstance where (11.62) or (11.64) is automatically satisfied.

Lemma 11.19. *Let J be a matrix of the form (11.2) with rational (and thus integer) Perron–Frobenius eigenvalue λ . Assume that*

$$(11.65) \quad \text{Prim}(m_N) = \text{Prim}(\lambda)$$

and that

$$(11.66) \quad \text{rank}(D_\lambda(G)) = 1.$$

It follows that

$$(11.67) \quad D_\lambda(G) = \mathbb{Z} \left[\frac{1}{\lambda} \right] v$$

where v is the right Perron–Frobenius eigenvector given by (14.5).

Proof. Since $J^{-n}v = \lambda^{-n}v$, it is clear that

$$(11.68) \quad \mathbb{Z} \left[\frac{1}{\lambda} \right] v \subseteq D_\lambda(G).$$

Conversely, if $g \in D_\lambda(G) \subseteq G$, then $m_N^i g \in \mathbb{Z}^N$ for some N since

$$m_N = (-1)^{N+1} \det(J).$$

But as $\text{Prim}(\lambda) = \text{Prim}(m_N)$, it follows that $\lambda^j g \in \mathbb{Z}^N$ for some j . But $D_\lambda(G)$ has rank 1 and $v \in D_\lambda(G)$, so $D_\lambda(G) \subseteq \mathbb{Q}v$. Thus

$$\lambda^j g \in \mathbb{Q}v \cap \mathbb{Z}^N.$$

But as $v \in \mathbb{Z}^N$ and the first component of v is 1, it follows that $\mathbb{Q}v \cap \mathbb{Z}^N = \mathbb{Z}v$. Thus $\lambda^j g = nv$ for an $n \in \mathbb{Z}$, so

$$g = \frac{n}{\lambda^j} v \in \mathbb{Z} \left[\frac{1}{\lambda} \right] v.$$

This together with (11.68) proves the lemma. \square

Corollary 11.20. *Let J, J' be matrices of the form (11.2) with integer Perron–Frobenius eigenvalues λ, λ' , and let α, α' , resp. v, v' , be the left, resp. right, Perron–Frobenius eigenvectors of J, J' given by (5.17), (14.5), respectively. Assume that*

$$(11.69) \quad \text{Prim}(\lambda) = \text{Prim}(\lambda') = \text{Prim}(m_N) = \text{Prim}(m'_{N'}) = \{p_1, \dots, p_m\}$$

and that

$$(11.70) \quad \text{rank}(D_{\lambda'}(K_0(\mathfrak{A}_{J'}))) = 1.$$

If there exists a unital morphism $\mathfrak{A}_J \rightarrow \mathfrak{A}_{J'}$, then

$$(11.71) \quad \frac{\langle \alpha | v \rangle}{\langle \alpha' | v' \rangle} \in \mathbb{Z} \left[\frac{1}{\lambda} \right]$$

and if this morphism is an isomorphism, there exist integers n_1, \dots, n_m such that

$$(11.72) \quad \frac{\langle \alpha | v \rangle}{\langle \alpha' | v' \rangle} = p_1^{n_1} p_2^{n_2} \cdots p_m^{n_m}.$$

Proof. If there exists an isomorphism, then

$$(11.73) \quad \begin{aligned} D_\lambda(K_0(\mathfrak{A}_J)) &= D_{\lambda'}(K_0(\mathfrak{A}_J)) \\ &\cong D_{\lambda'}(K_0(\mathfrak{A}_{J'})) \end{aligned}$$

and hence it follows from (11.70) that $\text{rank } D_\lambda(K_0(\mathfrak{A}_J)) = 1$. The rest is straightforward from Lemma 11.19 and Theorem 11.17. \square

In applying Corollary 11.20, the most difficult condition to verify is of course (11.70). To this end, the following criterion is often useful.

Proposition 11.21. *Let J be a matrix of the form (11.2) with integer Perron–Frobenius eigenvalue λ , and let v be the corresponding right eigenvector given by (14.5). Put*

$$G_i = J^{-i} \mathbb{Z}^N \text{ and } G = \bigcup_i G_i$$

as usual. Assume that there is an $n \in \mathbb{N}$ such that

$$(11.74) \quad \{g \in G \mid \lambda^{ni} g \in \mathbb{Z}^N\} \subseteq G_{ni}$$

for all $i \in \mathbb{N}$, and assume that

$$(11.75) \quad \lambda^n J^{-n} \text{ has integer entries.}$$

It follows that

$$(11.76) \quad D_\lambda(G) = \mathbb{Z} \left[\frac{1}{\lambda} \right] v,$$

so in particular (11.70) is fulfilled.

Proof. It suffices to show that

$$(11.77) \quad D_\lambda(G) \cap \mathbb{Z}^N = \mathbb{Z}v.$$

For this, let $w \in D_\lambda(G) \cap \mathbb{Z}^N$. Then $w = \lambda^{ni} g_i$ for a $g_i \in G$ for all $i \in \mathbb{N}$. Using (11.74) we have

$$g_i \in G_{ni} = J^{-ni} \mathbb{Z}^N$$

so

$$w = \lambda^{ni} g_i \in (\lambda^n J^{-n})^i \mathbb{Z}^N.$$

Thus

$$w \in \bigcap_{i \geq 0} (\lambda^n J^{-n})^i \mathbb{Z}^N.$$

But λ^n , being the Perron–Frobenius eigenvalue of the primitive matrix J^n , is strictly larger in absolute value than any other eigenvalue, and since $\lambda^n J^{-n}$ is a matrix with integer matrix elements, it follows that

$$\bigcap_{i \geq 0} (\lambda^n J^{-n})^i \mathbb{Z}^N \subseteq \mathbb{R}v \cap \mathbb{Z}^N.$$

But since the first component of v is 1 by (14.5), it follows that

$$\mathbb{R}v \cap \mathbb{Z}^N = \mathbb{Z}v \cap \mathbb{Z}^N$$

so

$$w \in \mathbb{Z}v \cap \mathbb{Z}^N$$

and this proves (11.77) and thereby (11.76). \square

Corollary 11.22. *Let J, J' be matrices of the form (11.2) with integer Perron–Frobenius eigenvalues λ, λ' and let α, α' , resp. v, v' , be the left, resp. right, Perron–Frobenius eigenvectors of J, J' given by (5.17), (14.5), respectively. Assume that*

$$(11.78) \quad \text{Prim}(\lambda) = \text{Prim}(\lambda') = \text{Prim}(m_N) = \text{Prim}(m'_N) = \{p_1, \dots, p_m\}$$

and there is an $n \in \mathbb{N}$ such that

$$(11.79) \quad \{g \in G' \mid \lambda^{ni} g \in \mathbb{Z}^N\} \subseteq G'_{ni}$$

for all $i \in \mathbb{N}$, where

$$G'_{ni} = J'^{-ni} \mathbb{Z}^N,$$

and

$$(11.80) \quad \lambda'^n J'^{-n} \text{ has integer entries.}$$

If there exists a unital morphism $\mathfrak{A}_J \rightarrow \mathfrak{A}_{J'}$, then

$$(11.81) \quad \frac{\langle \alpha \mid v \rangle}{\langle \alpha' \mid v' \rangle} \in \mathbb{Z} \left[\frac{1}{\lambda} \right]$$

and if this morphism is an isomorphism, there exist integers n_1, \dots, n_m such that

$$(11.82) \quad \frac{\langle \alpha | v \rangle}{\langle \alpha' | v' \rangle} = p_1^{n_1} p_2^{n_2} \cdots p_m^{n_m}.$$

Proof. This follows from Corollary 11.20 and Proposition 11.21. \square

Remark 11.23. Note that condition (11.80) is equivalent to $\lambda^{in} J'^{-in}$ having integer entries for $i = 1, 2, \dots$ and hence this condition is equivalent to

$$G'_{ni} \subseteq \{g \in G' \mid \lambda^{ni} g \in \mathbb{Z}^N\}$$

for $i = 1, 2, \dots$. Thus, conditions (11.79) and (11.80) taken together are equivalent to the single condition

$$(11.83) \quad \{g \in G' \mid \lambda^{ni} g \in \mathbb{Z}^N\} = G'_{ni}$$

for $i = 1, 2, \dots$

Now one proves as in Proposition 11.4 that (11.79) is equivalent to the same condition for $i = 1$, and hence (11.83) is equivalent to the single condition

$$(11.84) \quad \{g \in G' \mid \lambda^n g \in \mathbb{Z}^N\} = G'_n.$$

By the same token, (11.74) \wedge (11.75) is equivalent to (11.84).

Scholium 11.24. We saw in Lemma 11.14 that if $\lambda = m_N$, condition (11.84) is automatically fulfilled with $n = 1$, and this was used in the proof of Corollary 11.13. Thus, Corollary 11.13 may be viewed as a special case of Corollary 11.22. But in order to verify the hypotheses (11.84), we need an efficient algorithm. One such algorithm is one that in particularly “pure” form occurs in the proof of Proposition 11.16. So in terms of $G = K_0(\mathfrak{A}_L)$,

$$\begin{aligned} F &= G / \mathbb{Z}^N \\ F_i &= G_i / \mathbb{Z}^N = J^{-i} \mathbb{Z}^N / \mathbb{Z}^N \end{aligned}$$

we want to establish (11.84), i.e.,

$$(11.85) \quad \{h \in F \mid \lambda^n h = 0\} = F_n.$$

In the special case $\lambda^n = m_N = m$, we may proceed like this: If x_1, x_2 are the generators of F in Lemma 9.2, (9.8) and (9.9), then

$$(11.86) \quad \begin{aligned} mx_1 &= 0 \\ mx_2 &= -m_{N-1}x_1 \\ mx_3 &= -m_{N-2}x_1 - m_{N-1}x_2 \\ &\vdots \\ mx_k &= x_{k-N} - m_1x_{k-N+1} - \cdots - m_{N-1}x_{k-1} \end{aligned}$$

(where we use $x_l = 0$ for $l \leq 0$). As seen for example in Corollary 8.8, any element $h \in F$ can be uniquely represented as

$$(11.87) \quad h = t_1x_1 + t_2x_2 + \cdots + t_kx_k$$

for some k , where $t_i \in \{0, 1, \dots, m-1\}$. It follows from (11.86) that $mh = 0$ is equivalent to

$$(11.88) \quad -t_2m_{N-1}x_1 + \cdots + t_k(x_{k-N} - m_1x_{k-N+1} - \cdots - m_{N-1}x_{k-1}) = 0.$$

The leading term here is $-t_k m_{N-1} x_{k-1}$. If now

$$t_k m_{N-1} \not\equiv 0 \pmod{m}$$

for $t_k = 1, 2, \dots, m-1$, it follows that $mh = 0 \Rightarrow t_k = 0$. Thus $t_k x_k$ cannot be the leading term in h . Continuing in this manner, one loops off t_{k-1}, t_{k-2} , etc., and one ends up showing $mh = 0 \Leftrightarrow h \in F_1$. If now $m_{N-1} = 0 \pmod m$, one gets from the outset that $mx_2 = 0$, and hence there are no restrictions on t_2 , and since now $m_{N-1}x_{k-1}$ can be expanded in x_{k-2}, x_{k-3} , etc., one may try to go one step further and show that $t_k = 0$, etc., and then $h \in F_2$ if $tm_{N-2} \neq 0 \pmod m$ for $t \in \{1, \dots, m-1\}$, etc. In general, it may of course happen for example that $tm_{N-2} \neq 0 \pmod m$ for some $t \in \{1, \dots, m-1\}$ and $tm_{N-2} = 0 \pmod m$ for some other t , and then the computation of $\{h \in F \mid mh = 0\}$ becomes much more complicated. Let us single out the simple case.

Proposition 11.25. *Let J be a matrix of the form (11.2) and put $m = m_N$. Choose $n \in \{1, \dots, N\}$ such that*

$$(11.89) \quad m_{N-k} = 0 \pmod{m_N}$$

for $k = 0, \dots, n-1$, and assume that

$$(11.90) \quad \gcd(m_{N-n}, m_N) = 1.$$

It follows that

$$(11.91) \quad \{h \in F \mid mh = 0\} = F_n.$$

If $n = N$, condition (11.90) may be omitted.

Proof. Once one notes that condition (11.90),

$$\gcd(m_{N-n}, m_N) = 1,$$

means that

$$tm_{N-n} \neq 0 \pmod{m_N}$$

for $t = 1, 2, \dots, m_{N-1}$, this is clear from the discussion preceding the proposition. \square

Example 11.26. Consider

$$J = \begin{pmatrix} 0 & 1 & 0 & 0 \\ 1 & 0 & 1 & 0 \\ 2 & 0 & 0 & 1 \\ 8 & 0 & 0 & 0 \end{pmatrix}, \quad J' = \begin{pmatrix} 1 & 1 & 0 & 0 \\ 1 & 0 & 1 & 0 \\ 0 & 0 & 0 & 1 \\ 4 & 0 & 0 & 0 \end{pmatrix}.$$

Here $\lambda = \lambda' = 2$, so

$$\text{Prim}(\lambda) = \text{Prim}(\lambda') = \text{Prim}(m_N) = \text{Prim}(m'_N) = \{2\}.$$

Note that

$$4J'^{-2} = \begin{pmatrix} 0 & 0 & 1 & 0 \\ 0 & 0 & -1 & 1 \\ 4 & 0 & -1 & -1 \\ 0 & 4 & 0 & -1 \end{pmatrix}$$

so (11.75) is satisfied with $n = 2$. Further note that

$$\langle \alpha \mid v \rangle = \left(1, \frac{1}{2}, \frac{1}{4}, \frac{1}{8}\right) \begin{pmatrix} 1 \\ 2 \\ 3 \\ 4 \end{pmatrix} = \frac{13}{4}$$

and

$$\langle \alpha' | v' \rangle = \left(1, \frac{1}{2}, \frac{1}{4}, \frac{1}{8}\right) \begin{pmatrix} 1 \\ 1 \\ 1 \\ 2 \end{pmatrix} = 2$$

and hence

$$\frac{\langle \alpha | v \rangle}{\langle \alpha' | v' \rangle} = \frac{13}{2} \in \mathbb{Z} \left[\frac{1}{2}\right],$$

but this number does not have a multiplicative inverse in $\mathbb{Z} \left[\frac{1}{2}\right]$. Thus, if we can show (11.79),

$$\{g \in G' \mid \lambda^{2i} g \in \mathbb{Z}^N\} \subseteq G'_{2^i},$$

it follows from Corollary 11.22 that \mathfrak{A}_J and $\mathfrak{A}_{J'}$ are non-isomorphic. But Proposition 11.25 applied to J' shows that

$$\{h \in F \mid 4h = 0\} = F_2.$$

Thus (11.84) holds with $n = 2$ and in particular (11.79) is valid. This shows the non-isomorphism of the two dimension groups.

In addition to the criteria of non-isomorphism given by Theorem 11.10, Corollary 11.12, Corollary 11.13, Theorem 11.17, Corollary 11.20 and Proposition 11.21, it is frequently possible to decide non-isomorphism by another route, namely by establishing that the exact sequence (5.31):

$$0 \longrightarrow \ker \tau \hookrightarrow K_0(\mathfrak{A}_J) \xrightarrow{\tau} \mathbb{Z} \left[\frac{1}{\lambda}\right] \longrightarrow 0$$

splits for one specimen but not for another. With $K_0(\mathfrak{A}_J)$ realized as (5.19), there is a simple criterion for this.

Lemma 11.27. *Let J be a matrix of the form (11.2) with integer Perron–Frobenius eigenvalue λ with*

$$\text{Prim}(\lambda) = \{p_1, \dots, p_m\}.$$

The following conditions (i) and (ii) are equivalent.

(i) *The exact sequence*

$$0 \longrightarrow \ker \tau \hookrightarrow K_0(\mathfrak{A}_J) \xrightarrow{\tau} \mathbb{Z} \left[\frac{1}{\lambda}\right] \longrightarrow 0$$

splits.

(ii) *There is a $w \in D_\lambda(G)$ such that $\tau(w)$ has a multiplicative inverse in $\mathbb{Z} \left[\frac{1}{\lambda}\right]$, i.e., $\tau(w) = p_1^{n_1} p_2^{n_2} \cdots p_m^{n_m}$ for suitable $n_1, \dots, n_m \in \mathbb{Z}$.*

Proof. (i) \Rightarrow (ii): If the sequence splits, let

$$\psi: \mathbb{Z} \left[\frac{1}{\lambda}\right] \longrightarrow K_0(\mathfrak{A}_J)$$

be a section, and put $w = \psi(1)$. Then

$$w \in \psi \left(\mathbb{Z} \left[\frac{1}{\lambda}\right] \right) \subseteq D_\lambda(G) \text{ and } \tau(w) = 1.$$

(ii) \Rightarrow (i): If (ii) holds, we can define a section ψ by

$$\psi(\tau(w)) = w$$

and since $\mathbb{Z} \left[\frac{1}{\lambda}\right] \tau(w) = \mathbb{Z} \left[\frac{1}{\lambda}\right]$, and $w \in D_\lambda(G)$, ψ extends uniquely to $\mathbb{Z} \left[\frac{1}{\lambda}\right]$. \square

Corollary 11.28. *Let J be a matrix of the form (11.2) with integer Perron–Frobenius eigenvalue λ with $\text{Prim}(\lambda) = \{p_1, \dots, p_m\}$ and left and right Frobenius eigenvectors α, v given by (5.17), (14.5), respectively. The exact sequence (5.31):*

$$(11.92) \quad 0 \longrightarrow \ker \tau \hookrightarrow K_0(\mathfrak{A}_J) \xrightarrow{\tau} \mathbb{Z} \left[\frac{1}{\lambda} \right] \rightarrow 0$$

splits if

$$(11.93) \quad \langle \alpha \mid v \rangle = p_1^{n_1} p_2^{n_2} \cdots p_m^{n_m}$$

for suitable n_1, n_2, \dots, n_m in \mathbb{Z} .

Conversely, if (11.92) splits and $\text{rank}(D_\lambda(G)) = 1$ and $\text{Prim}(m_N) = \text{Prim}(\lambda)$, then $\langle \alpha \mid v \rangle$ has the form (11.93).

Proof. Since always $v \in D_\lambda(G)$, the first statement follows from Lemma 11.27.

The last statement follows from Lemma 11.19: If $\text{rank}(D_\lambda(G)) = 1$ and $\text{Prim}(m_N) = \text{Prim}(\lambda)$, then $D_\lambda(G) = Z \left[\frac{1}{\lambda} \right] v$ and if ψ is a section for (11.92), then $\psi(1) \in D_\lambda(G) = Z \left[\frac{1}{\lambda} \right] v$. Thus, there is a $t \in Z \left[\frac{1}{\lambda} \right]$ such that $\psi(1) = tv$. But then

$$1 = \langle \alpha \mid \psi(1) \rangle = \langle \alpha \mid tv \rangle = t \langle \alpha \mid v \rangle$$

and it follows that $\langle \alpha \mid v \rangle$ has the multiplicative inverse t in $Z \left[\frac{1}{\lambda} \right]$, so $\langle \alpha \mid v \rangle$ has the form (11.93). \square

Example 11.29. An instance where the isomorphism question for two C^* -algebras \mathfrak{A}_J and $\mathfrak{A}_{J'}$ is not immediate is when

$$J = \begin{pmatrix} 1 & 1 & 0 \\ 1 & 0 & 1 \\ 2 & 0 & 0 \end{pmatrix} \quad \text{and} \quad J' = \begin{pmatrix} 0 & 1 & 0 \\ 3 & 0 & 1 \\ 2 & 0 & 0 \end{pmatrix}.$$

Both matrices are regular, and both have determinant 2 and Perron–Frobenius eigenvalue 2. The respective right eigenvectors are

$$v_J = \begin{pmatrix} 1 \\ 1 \\ 1 \end{pmatrix} \quad \text{and} \quad v_{J'} = \begin{pmatrix} 1 \\ 2 \\ 1 \end{pmatrix}.$$

Since

$$\frac{\tau(v_J)}{\tau(v_{J'})} = \frac{7}{9},$$

it follows from Corollary 11.13 that the two C^* -algebras \mathfrak{A}_J and $\mathfrak{A}_{J'}$ are non-isomorphic. The non-isomorphism here is perhaps a bit surprising since the two matrices J^6 and J'^6 have the same spectrum.

Later, in Theorem 17.14, we will show that $\{\text{Prim } \lambda, \lambda^2 \tau(v)\}$ is a *complete* isomorphism invariant for 3×3 matrices with $\lambda = m_3$. For the two matrices above one computes that $\lambda^2 \tau(v)$ is 7, 9, respectively, confirming that they are non-isomorphic. See also Theorem 17.16.

Subgroups of $G_0 = \bigcup_{n=0}^{\infty} J_0^{-n} \mathcal{L}$

Before applying our general theory of isomorphism of stationary AF-algebras to more specific examples in Chapters 13–18, we will mention one more example of how to decide nontriviality of extensions which is sometimes useful. In many examples we compute that $G = K_0(\mathfrak{A}_L)$ or $G_0 = \ker \tau$ or some other group is an extension of the form

$$(12.1) \quad 0 \longrightarrow H \longrightarrow G_0 \longrightarrow \mathbb{Z} \left[\frac{1}{d} \right] \longrightarrow 0.$$

We first state a proposition which is a variation of a result due to David Handelman [11, Proposition 10.1].

Proposition 12.1. *Let \mathbb{E} be an $N \times N$ matrix with integer entries and assume $\det(\mathbb{E}) \neq 0$. Let $f(x) = \det(x\mathbf{1} - \mathbb{E})$ be the characteristic polynomial of \mathbb{E} and let $f(x) = f_1(x)f_2(x)\cdots f_n(x)$ be the decomposition of f into irreducible polynomials in $\mathbb{Z}[x]$. Define*

$$q(x) = \prod_{|f_i(0)|=1} f_i(x), \quad p(x) = \prod_{|f_i(0)|\neq 1} f_i(x).$$

Then

$$p(\mathbb{E})\mathbb{Z}^N \subseteq \{m \in \mathbb{Z}^N \mid q(\mathbb{E})m = 0\} = \bigcap_k \mathbb{E}^k \mathbb{Z}^N.$$

Proof. The left inclusion follows from $q(\mathbb{E})p(\mathbb{E}) = f(\mathbb{E}) = 0$. Next note that $W = \{m \in \mathbb{Z}^N \mid q(\mathbb{E})m = 0\}$ is an \mathbb{E} -invariant sublattice of \mathbb{Z}^N . Note that if $q(x) = \sum_{i=0}^k q_i x^i$, then $q_0 = \pm 1$, so we may assume $q_0 = -1$, and hence $m \in W$ if and only if

$$m = \sum_{i=1}^k q_i \mathbb{E}^i m.$$

But then by iteration

$$m = \left(\sum_{i=1}^k q_i \mathbb{E}^i \right)^l m$$

for $l = 1, 2, \dots$, and expanding those polynomials we see that

$$m \in \bigcap_l \mathbb{E}^l \mathbb{Z}^N.$$

Thus

$$W \subseteq V \equiv \bigcap_i \mathbb{E}^i \mathbb{Z}^N.$$

But V is also an \mathbb{E} -invariant sublattice of \mathbb{Z}^N , and thus a free abelian group, and the restriction of \mathbb{E} to V is clearly surjective. Since \mathbb{E} is injective, it follows that

$\mathbb{E}|_V$ is invertible and thus $|\det(\mathbb{E}|_V)| = 1$. But the characteristic polynomial of $\mathbb{E}|_V$ is a factor of the characteristic polynomial of \mathbb{E} , and since the constant term of the former polynomial is ± 1 , it is a factor of $q(x)$. It follows that $q(\mathbb{E}|_V) = 0$, which means $V \subseteq W$. \square

In order that an extension such as (12.1) shall be trivial, it is necessary that G_0 contain $\mathbb{Z}[\frac{1}{d}]$ as a subgroup. In order to decide that, the following more local proposition is sometimes useful. The condition on \mathcal{L} means that $\mathcal{L} \cong \mathbb{Z}^M$ and that \mathcal{L} spans \mathbb{Q}^M over \mathbb{Q} .

Proposition 12.2. *Let J_0 be a nonsingular $M \times M$ matrix with integer matrix elements, and let \mathcal{L} be a free abelian subgroup of rank M of \mathbb{Q}^M . Consider the additive subgroup*

$$(12.2) \quad G_0 = \bigcup_{n=0}^{\infty} J_0^{-n} \mathcal{L}$$

of \mathbb{Q}^M . Let $d \in \mathbb{N}$ be a number such that

$$(12.3) \quad E = dJ_0^{-1}$$

is a matrix with integer matrix elements. Assume that

(i) there is a prime factor f of the monic polynomial

$$\det(\lambda \mathbf{1} - E) = \frac{(-\lambda)^M}{\det J_0} \det\left(\frac{d}{\lambda} \mathbf{1} - J_0\right)$$

such that $|f(0)| = 1$.

It follows that

(ii) G_0 contains a subgroup isomorphic to $\mathbb{Z}[\frac{1}{d}]$

but (ii) does not imply (i) in general.

Remark 12.3. Let us exhibit a partial example showing that (ii) does not imply (i). Let

$$J_0 = \begin{pmatrix} 0 & 1 & 0 & \cdots & 0 & 0 \\ 0 & 0 & 1 & \cdots & 0 & 0 \\ 0 & 0 & 0 & \ddots & 0 & 0 \\ \vdots & \vdots & & \ddots & \ddots & \vdots \\ 0 & 0 & 0 & & 0 & 1 \\ d & 0 & 0 & \cdots & 0 & 0 \end{pmatrix}$$

and $\mathcal{L} = \mathbb{Z}^M$. Then $J_0^M = d\mathbf{1}$, so $G_0 = \bigcup_k J_0^{-Mk} \mathbb{Z}^M = \mathbb{Z}[\frac{1}{d}]^M$ and hence (ii) holds. But since

$$\bigcap_k E^k \mathbb{Z}^M = \bigcap_k E^{Mk} \mathbb{Z}^M = \bigcap_k d^{(M-1)k} \mathbb{Z}^M = 0$$

it follows from the equivalent form (iii) of (i) in the proof below that (i) does not hold.

Proof. We know from Proposition 12.1 that (i) is equivalent to

$$(iii) \quad \bigcap_{k=1}^{\infty} E^k \mathbb{Z}^M \neq 0.$$

We now argue that (iii) is equivalent to

$$(iv) \bigcap_{k=1}^{\infty} E^k \mathcal{L} \neq 0.$$

But since both \mathcal{L} and \mathbb{Z}^M are the free abelian groups generated by M points in \mathbb{Q}^M , and there is an element of $\text{GL}(\mathbb{Q}, M)$ transforming these M -tuples into each other, it follows that there is a natural number n such that

$$(12.4) \quad \mathcal{L} \subseteq \frac{1}{n} \mathbb{Z}^M \quad \text{and} \quad \mathbb{Z}^M \subseteq \frac{1}{n} \mathcal{L}.$$

Thus the equivalence of (iii) and (iv) follows by linearity. Next, put

$$(12.5) \quad H = \bigcap_{k \geq 0} d^k G_0.$$

Clearly, H is a subgroup of G_0 containing 0. We now show

$$(12.6) \quad \bigcap_k E^k \mathcal{L} \subseteq H.$$

But this follows from

$$\bigcap_k E^k \mathcal{L} = \bigcap_k d^k J_0^{-k} \mathcal{L} \subseteq \bigcap_k d^k G_0 = H.$$

But since (i) \Leftrightarrow (iv), it follows from (i) and (12.6) that $H \neq 0$. But if $g \in H$, then $d^{-k}g \in G_0$ for all k by (12.5). Thus G_0 contains a subgroup isomorphic to $\mathbb{Z} \left[\frac{1}{d} \right]$. \square

Classification of the AF-algebras \mathfrak{A}_L with $\text{rank}(K_0(\mathfrak{A}_L)) = 2$

Let us consider matrices of the form (5.47) with $N = 2$,

$$(13.1) \quad J = \begin{pmatrix} m_1 & 1 \\ m_2 & 0 \end{pmatrix},$$

where $m_1, m_2 \in \mathbb{N}$. We divide the discussion into two cases.

Case 1. The Perron–Frobenius eigenvalue λ is rational, and thus $\lambda \in \mathbb{N}$.

In this case one computes that J has the form

$$(13.2) \quad J = \begin{pmatrix} \lambda - k & 1 \\ k\lambda & 0 \end{pmatrix}, \quad k = 1, \dots, \lambda - 1,$$

and the spectrum is

$$(13.3) \quad \text{spec}(J) = \{-k, \lambda\}.$$

Referring to Theorem 7.5, we have $D = 1$, $N = 2$, and the triangular form (7.15) is (with $p_a(x) = \lambda x - 1$):

$$(13.4) \quad \begin{pmatrix} -k & k \\ 0 & \lambda \end{pmatrix}.$$

Hence the invariants of Theorem 7.8 are:

- (a) $N = 2$,
- (b) $\text{Prim}(k\lambda)$,
- (c) $\text{Prim}(k)$,
- (c)' $\text{Prim}(\lambda)$,
- (d) $D = 1$.

Furthermore, we will argue below that

$$(13.5) \quad \ker(\tau) \cong \mathbb{Z} \left[\frac{1}{k} \right], \quad \tau(K_0(\mathfrak{A})) = \mathbb{Z} \left[\frac{1}{\lambda} \right],$$

so $K_0(\mathfrak{A})$ is an extension of $\mathbb{Z} \left[\frac{1}{\lambda} \right]$ by $\mathbb{Z} \left[\frac{1}{k} \right]$:

$$(13.6) \quad 0 \longrightarrow \mathbb{Z} \left[\frac{1}{k} \right] \longrightarrow K_0(\mathfrak{A}) \longrightarrow \mathbb{Z} \left[\frac{1}{\lambda} \right] \longrightarrow 0.$$

To see this, one computes

$$\begin{aligned}
 (13.7) \quad \begin{pmatrix} \lambda - k & 1 \\ k\lambda & 0 \end{pmatrix}^{-n} &= \frac{1}{\lambda + k} \begin{pmatrix} 1 & 1 \\ k & -\lambda \end{pmatrix} \begin{pmatrix} \lambda^{-n} & 0 \\ 0 & (-k)^{-n} \end{pmatrix} \begin{pmatrix} \lambda & 1 \\ k & -1 \end{pmatrix} \\
 &= \frac{1}{\lambda + k} \begin{pmatrix} \lambda^{-n+1} - (-k)^{-n+1} & \lambda^{-n} - (-k)^{-n} \\ k\lambda^{-n+1} + \lambda(-k)^{-n+1} & k\lambda^{-n} + \lambda(-k)^{-n} \end{pmatrix} \\
 &= \frac{1}{\lambda + k} \begin{pmatrix} \lambda^{-n+1} - (-k)^{-n+1} & \lambda^{-n} - (-k)^{-n} \\ k\lambda(\lambda^{-n} - (-k)^{-n}) & k\lambda(\lambda^{-n-1} - (-k)^{-n-1}) \end{pmatrix}.
 \end{aligned}$$

Hence, using (13.7), one computes

$$\begin{aligned}
 (13.8) \quad g &= \begin{pmatrix} \lambda - k & 1 \\ k\lambda & 0 \end{pmatrix}^{-n} \begin{pmatrix} n_1 \\ n_2 \end{pmatrix} \\
 &= \frac{1}{\lambda + k} \left[(\lambda n_1 + n_2) \lambda^{-n} \begin{pmatrix} 1 \\ k \end{pmatrix} + (kn_1 - n_2) (-k)^{-n} \begin{pmatrix} 1 \\ -\lambda \end{pmatrix} \right],
 \end{aligned}$$

and thus, using (5.17),

$$(13.9) \quad \tau(g) = \left(1, \frac{1}{\lambda}\right) g = (\lambda n_1 + n_2) \lambda^{-n-1}.$$

This confirms (5.22): $\tau(K_0(\mathfrak{A})) = \mathbb{Z} \left(\frac{1}{\lambda}\right)$, and we see that $g \in \ker(\tau)$ if and only if $\lambda n_1 + n_2 = 0$, i.e., $n_2 = -\lambda n_1$, so $g \in \ker(\tau)$ if and only if

$$(13.10) \quad g = \frac{1}{\lambda + k} (kn_1 + \lambda n_1) (-k)^{-n} \begin{pmatrix} 1 \\ -\lambda \end{pmatrix} = n_1 (-k)^{-n} \begin{pmatrix} 1 \\ -\lambda \end{pmatrix}$$

for an $n_1 \in \mathbb{Z}$, $n \in \mathbb{N}$, which confirms $\ker(\tau) \cong \mathbb{Z} \left[\frac{1}{k}\right]$, so the sequence (13.6) is well defined and exact.

Now, using (13.8) we can prove

Proposition 13.1. *If $G = K_0(\mathfrak{A})$ is realized concretely in \mathbb{Q}^2 as above we have*

$$(13.11) \quad \mathbb{Z} \left[\frac{1}{\lambda}\right] \begin{pmatrix} 1 \\ k \end{pmatrix} + \mathbb{Z} \left[\frac{1}{k}\right] \begin{pmatrix} 1 \\ -\lambda \end{pmatrix} \subseteq G \subseteq \frac{1}{(\lambda + k, \lambda)} \mathbb{Z} \left[\frac{1}{\lambda}\right] \begin{pmatrix} 1 \\ k \end{pmatrix} + \frac{1}{(\lambda + k, k)} \mathbb{Z} \left[\frac{1}{k}\right] \begin{pmatrix} 1 \\ -\lambda \end{pmatrix},$$

where

$$(13.12) \quad (n_1, n_2) = \frac{n_1}{\text{gcd}(n_1, n_2^\infty)}$$

for $n_1, n_2 \in \mathbb{N}$, where $\text{gcd}(n_1, n_2^\infty)$ is the (unique) greatest common divisor of n_1 and n_2^m for large m . Furthermore an element $a \begin{pmatrix} 1 \\ k \end{pmatrix} + b \begin{pmatrix} 1 \\ -\lambda \end{pmatrix}$ of G is (nonzero) positive if and only if

$$(13.13) \quad a > 0.$$

In particular, the following conditions are equivalent:

$$(a) \quad G = \mathbb{Z} \left[\frac{1}{\lambda}\right] \begin{pmatrix} 1 \\ k \end{pmatrix} + \mathbb{Z} \left[\frac{1}{k}\right] \begin{pmatrix} 1 \\ -\lambda \end{pmatrix},$$

and

$$(b) \quad \text{Prim}(\lambda + k) \subseteq \text{Prim}(\lambda) \cap \text{Prim}(k).$$

G can also in general be characterized as the set of linear combinations of elements of \mathbb{Z}^2 and the elements

$$(13.14) \quad \frac{1}{\lambda + k} \begin{pmatrix} \lambda^{-n} - (-k)^{-n} \\ k\lambda^{-n} + (-k)^{-n}\lambda \end{pmatrix}$$

with integer coefficients, $n = 1, 2, \dots$

In the special case

$$(13.15) \quad \text{Prim}(\lambda) = \text{Prim}(k),$$

put

$$(13.16) \quad \lambda_0 = \prod \{p \mid p \in \text{Prim}(\lambda) = \text{Prim}(k)\}.$$

Then

$$(13.17) \quad G = \begin{pmatrix} \mathbb{Z} \left[\frac{1}{\lambda_0} \right] \\ \mathbb{Z} \left[\frac{1}{\lambda_0} \right] \end{pmatrix} \cong \mathbb{Z} \left[\frac{1}{\lambda_0} \right]^2.$$

Remark 13.2. Note that the condition (b) in Proposition 13.1 is equivalent to each of the conditions

- (c) $\text{Prim}(\lambda + k) \subseteq \text{Prim}(\lambda)$,
- (d) $\text{Prim}(\lambda + k) \subseteq \text{Prim}(k)$.

Clearly (b) \Rightarrow (c) and (b) \Rightarrow (d). For (c) \Rightarrow (b), use $k = (\lambda + k) - \lambda$, etc.

Proof. Setting $n_2 = -\lambda n_1$ in (13.8) we obtain

$$(13.18) \quad g = \frac{1}{\lambda + k} (kn_1 + \lambda n_1) (-k)^{-n} \begin{pmatrix} 1 \\ -\lambda \end{pmatrix} = n_1 (-k)^{-n} \begin{pmatrix} 1 \\ -\lambda \end{pmatrix}$$

and hence

$$(13.19) \quad \mathbb{Z} \left[\frac{1}{k} \right] \begin{pmatrix} 1 \\ -\lambda \end{pmatrix} \subseteq G..$$

Next setting $n_2 = kn_1$ in (13.8) we obtain similarly

$$(13.20) \quad g = \frac{1}{\lambda + k} (\lambda n_1 + kn_1) \lambda^{-n} \begin{pmatrix} 1 \\ k \end{pmatrix} = n_1 \lambda^{-n} \begin{pmatrix} 1 \\ k \end{pmatrix},$$

so

$$(13.21) \quad \mathbb{Z} \left[\frac{1}{\lambda} \right] \begin{pmatrix} 1 \\ k \end{pmatrix} \subseteq G.$$

We conclude that

$$(13.22) \quad \mathbb{Z} \left[\frac{1}{\lambda} \right] \begin{pmatrix} 1 \\ k \end{pmatrix} + \mathbb{Z} \left[\frac{1}{k} \right] \begin{pmatrix} 1 \\ -\lambda \end{pmatrix} \subseteq G.$$

Conversely, if $g \in G$ it follows from (13.8) that g has the form

$$(13.23) \quad g = a \begin{pmatrix} 1 \\ k \end{pmatrix} + b \begin{pmatrix} 1 \\ -\lambda \end{pmatrix},$$

where the pair a, b has the form

$$(13.24) \quad a = \frac{1}{\lambda + k} (\lambda n_1 + n_2) \lambda^{-n}, \quad b = \frac{1}{\lambda + k} (kn_1 - n_2) (-k)^{-n}$$

for suitable $n_1, n_2 \in \mathbb{Z}$, $n \in \mathbb{Z}$. But writing

$$a = \frac{\lambda^m}{\lambda + k} (\lambda n_1 + n_2) \lambda^{-(n+m)}$$

and choosing m large enough, it follows that

$$a \in \frac{1}{(\lambda + k, \lambda)} \mathbb{Z} \left[\frac{1}{\lambda} \right],$$

and using the same reasoning on b , the inclusion

$$(13.25) \quad G \subseteq \frac{1}{(\lambda + k, \lambda)} \mathbb{Z} \left[\frac{1}{\lambda} \right] \begin{pmatrix} 1 \\ k \end{pmatrix} + \frac{1}{(\lambda + k, \lambda)} \mathbb{Z} \left[\frac{1}{k} \right] \begin{pmatrix} 1 \\ -\lambda \end{pmatrix}$$

follows. Applying (5.17) and (5.34) to $\alpha = (1, 1/\lambda)$, it follows that $g = a \begin{pmatrix} 1 \\ k \end{pmatrix} + b \begin{pmatrix} 1 \\ -\lambda \end{pmatrix}$ is positive if and only if $a > 0$.

We have $(\lambda + k, k) = 1$ if and only if $\text{Prim}(\lambda + k) \subseteq \text{Prim}(k)$, and hence (b) \Rightarrow (a). But if (b) is not fulfilled, then $(\lambda + k, k) > 1$ or $(\lambda + k, \lambda) > 1$, and choosing $n_1 = 0$ (or $n_2 = 0$) in (13.8) we see that G contains elements that are not in $\mathbb{Z} \left[\frac{1}{\lambda} \right] \begin{pmatrix} 1 \\ k \end{pmatrix} + \mathbb{Z} \left[\frac{1}{k} \right] \begin{pmatrix} 1 \\ -\lambda \end{pmatrix}$. Thus (a) \Rightarrow (b).

Next, define

$$(13.26) \quad g(n_1, n_2, n) = \frac{1}{\lambda + k} \left[(\lambda n_1 + n_2) \lambda^{-n} \begin{pmatrix} 1 \\ k \end{pmatrix} + (k n_1 - n_2) (-k)^{-n} \begin{pmatrix} 1 \\ -\lambda \end{pmatrix} \right]$$

for $n \in \mathbb{N}$, $n_1, n_2 \in \mathbb{Z}$. Then

$$g(n_1, n_2, n) = n_1 g(1, 0, n) + n_2 g(0, 1, n)$$

and

$$g(1, 0, n+1) = g(0, 1, n),$$

so G is spanned over \mathbb{Z} by \mathbb{Z}^2 and the elements

$$(13.27) \quad \begin{aligned} g(0, 1, n) &= \frac{1}{\lambda + k} \left(\lambda^{-n} \begin{pmatrix} 1 \\ k \end{pmatrix} - (-k)^{-n} \begin{pmatrix} 1 \\ -\lambda \end{pmatrix} \right) \\ &= \frac{1}{\lambda + k} \begin{pmatrix} \lambda^{-n} - (-k)^{-n} \\ k \lambda^{-n} + (-k)^{-n} \lambda \end{pmatrix}. \end{aligned}$$

It remains to prove the last statement in the proposition. So assume $\text{Prim}(\lambda) = \text{Prim}(k)$ and define λ_0 by (13.16) as the product of the primes in this set. It follows that the matrix elements in the left column of

$$J = \begin{pmatrix} \lambda - k & 1 \\ k\lambda & 0 \end{pmatrix}$$

all are divisible by λ_0 and hence all matrix elements of J^{2n} are divisible by λ_0^n , i.e.,

$$\lambda_0^n \mathbb{Z}^2 \supseteq J^{2n} \mathbb{Z}^2,$$

and hence, applying $\lambda_0^{-n} J^{-2n}$ to both sides,

$$J^{-2n} \mathbb{Z}^2 \supseteq \lambda_0^{-n} \mathbb{Z}^2.$$

It follows that

$$(13.28) \quad G \supseteq \mathbb{Z} \left[\frac{1}{\lambda_0} \right] \mathbb{Z}^2 = \begin{pmatrix} \mathbb{Z} \left[\frac{1}{\lambda_0} \right] \\ \mathbb{Z} \left[\frac{1}{\lambda_0} \right] \end{pmatrix}.$$

Conversely, G is spanned over \mathbb{Z} by \mathbb{Z}^2 and the elements (13.14) for $n = 1, 2, \dots$.
But

$$(13.29) \quad \frac{1}{\lambda+k} \begin{pmatrix} \lambda^{-n} - (-k)^{-n} \\ k\lambda^{-n} + (-k)^{-n}\lambda \end{pmatrix} = \frac{1}{\lambda^n k^n} \frac{1}{\lambda+k} \begin{pmatrix} k^n - (-\lambda)^n \\ k^{n+1} + (-1)^n \lambda^{n+1} \end{pmatrix} \\ = \frac{(-1)^{n+1}}{\lambda^n k^n} \frac{1}{\lambda+k} \begin{pmatrix} \lambda^n - (-k)^n \\ -(\lambda^{n+1} - (-k)^{n+1}) \end{pmatrix}.$$

But since $\lambda = -k \pmod{\lambda+k}$, we have $\lambda^n = (-k)^n \pmod{\lambda+k}$, so the vector $\frac{1}{\lambda+k} \begin{pmatrix} \lambda^n - (-k)^n \\ -(\lambda^{n+1} - (-k)^{n+1}) \end{pmatrix}$ has integral components. It follows that the elements (13.14) are contained in $\mathbb{Z} \left[\frac{1}{\lambda_0} \right]^2$. Thus

$$(13.30) \quad G \subseteq \mathbb{Z} \left[\frac{1}{\lambda_0} \right].$$

Now, (13.28) and (13.30) finally establish (13.17). (The last argument was also used in [13, Remark after Proposition 5].) \square

In general, the sequence (13.6) does not split, i.e., there does not exist a well defined homomorphism $\psi: \mathbb{Z} \left[\frac{1}{\lambda} \right] \rightarrow K_0(\mathfrak{A})$ with $\tau \circ \psi = \text{id}$. (Well defined means for example $\psi(m\lambda^{-n}) = \psi((m\lambda)\lambda^{-n-1})$.) In general, the class of $K_0(\mathfrak{A})$ in $\text{Ext}(\mathbb{Z} \left[\frac{1}{\lambda} \right], \mathbb{Z} \left[\frac{1}{k} \right])$ depends on properties of the prime decompositions of λ and k , and seems to have to be treated on a case-by-case basis. There are, however, two special cases that behave nicely. The first of these is the last case in Proposition 13.1,

$$(13.31) \quad \text{Prim}(\lambda) = \text{Prim}(k).$$

Then

$$(13.32) \quad K_0(G) = \begin{pmatrix} \mathbb{Z} \left[\frac{1}{k} \right] \\ \mathbb{Z} \left[\frac{1}{k} \right] \end{pmatrix} = \begin{pmatrix} \mathbb{Z} \left[\frac{1}{\lambda} \right] \\ \mathbb{Z} \left[\frac{1}{\lambda} \right] \end{pmatrix}$$

with trace functional $(1, 1/\lambda)$. Since the dimension group is a complete invariant, the following Proposition ensues.

Proposition 13.3. *Let J_1, J_2 be 2×2 matrices of the form (13.1)–(13.2) and let the subindices 1, 2 refer to J_1, J_2 respectively.*

- (a) *If J_1, J_2 define isomorphic C^* -algebras, then $\text{Prim}(\lambda_1) = \text{Prim}(\lambda_2)$ and $\text{Prim}(k_1) = \text{Prim}(k_2)$.*
- (b) *If $\text{Prim}(k_1) = \text{Prim}(k_2) = \text{Prim}(\lambda_2) = \text{Prim}(\lambda_1)$, then J_1, J_2 define isomorphic algebras.*

In the latter case, the dimension group is

$$(13.33) \quad G \cong \mathbb{Z} \left[\left\{ \frac{1}{k} \mid k \in \text{Prim}(\lambda_1) \right\} \right]^2$$

with positivity determined as follows: $g = (g_1, g_2) \in G$ is positive if and only if $g_1 + \lambda_0 g_2 > 0$, where $\lambda_0 = \prod_{p \in \text{Prim}(\lambda_1)} p$.

Proof. As already remarked, (a) is a special case of Theorem 7.5 and [13, Theorem 10]. As for (b), Proposition 13.1 shows that

$$(13.34) \quad G_1 = G_2 = \mathbb{Z} \left[\frac{1}{\lambda_0} \right]^2$$

as unordered groups, with positive cones determined by

$$(13.35) \quad (G_i)_+ = \left\{ g = (g_1, g_2) \in G_i \mid g_1 + \frac{1}{\lambda_i} g_2 > 0 \right\}.$$

But then the map

$$(13.36) \quad (g_1, g_2) \mapsto \left(g_1, \frac{\lambda_i}{\lambda_0} g_2 \right)$$

defines an isomorphism of ordered groups $G \rightarrow G_i$ for $i = 1, 2$. Thus $(G_i, (G_i)_+)$, $i = 1, 2$, are both isomorphic to (G, G_+) , and Proposition 13.3 follows. \square

The second special case that behaves nicely is when condition (b) in Proposition 13.1 is fulfilled, i.e., $\text{Prim}(\lambda + k) \subseteq \text{Prim}(\lambda) \cap \text{Prim}(k)$. Let us first mention a simple algorithm to construct *all* pairs (λ, k) of positive integers with $1 \leq k \leq \lambda - 1$ satisfying these properties: One first picks such a pair (λ', k') with $\text{gcd}(\lambda', k') = 1$, then lets μ be the product of all the prime factors of $\lambda' + k'$, and then the pair

$$\lambda = n\mu\lambda', \quad k = n\mu k',$$

where n is an arbitrary positive integer, will have the property (b). One obtains all pairs (λ, k) having the property (b) in this way, since given one such pair one may divide by $\text{gcd}(\lambda, k)$ to obtain (λ', k') , and then get back to (λ, k) by the process above.

As a simple example of the procedure above, take $\lambda' = 2$ and $k' = 1$. This gives $\mu = 3$, so all pairs

$$\lambda = n \cdot 6, \quad k = n \cdot 3$$

are examples.

If (b) is fulfilled, there is an exact sequence

$$0 \longrightarrow \mathbb{Z} \left[\frac{1}{k} \right] \hookrightarrow G \xrightarrow{\tau} \mathbb{Z} \left[\frac{1}{\lambda} \right] \longrightarrow 0$$

which splits. This is because G has the form (a) in Proposition 13.1, and one verifies directly that the map

$$\psi: \mathbb{Z} \left[\frac{1}{\lambda} \right] \longrightarrow G: g \longmapsto \frac{\lambda g}{\lambda + k} \begin{pmatrix} 1 \\ k \end{pmatrix}$$

is a section (it is well defined since $\text{Prim}(\lambda + k) \subseteq \text{Prim}(\lambda)$). Hence we get a different criterion from that in Proposition 13.3:

Proposition 13.4. *Let J_1, J_2 be 2×2 matrices of the form (13.1)–(13.2) and let the subindices 1, 2 refer to J_1, J_2 respectively.*

If $\text{Prim}(k_1) = \text{Prim}(k_2)$ and $\text{Prim}(\lambda_1) = \text{Prim}(\lambda_2)$, and

$$\text{Prim}(\lambda_i + k_i) \subseteq \text{Prim}(\lambda_i) \cap \text{Prim}(k_i)$$

for $i = 1, 2$ (see Remark 13.2 after Proposition 13.1), then J_1, J_2 define isomorphic algebras. Furthermore in this case the dimension group is

$$G \cong \mathbb{Z} \left[\frac{1}{\lambda_1} \right] \oplus \mathbb{Z} \left[\frac{1}{k_1} \right]$$

with positivity determined by positivity of the first coordinate.

Proof. This follows from the discussion before the Proposition. \square

Example 13.5. If

$$J_1 = \begin{pmatrix} 6n_1 & 1 \\ 3n_1 & 0 \end{pmatrix} \quad J_2 = \begin{pmatrix} 6n_2 & 1 \\ 3n_2 & 0 \end{pmatrix}$$

where the positive integers n_1, n_2 contain the same prime factors, then the corresponding AF-algebras are isomorphic. The case $n_1 = 2, n_2 = 4$ is illustrated in Figure 17, below.

Remark 13.6. If

$$J = \begin{pmatrix} \lambda - k & 1 \\ \lambda k & 0 \end{pmatrix}$$

then the right Perron–Frobenius eigenvector v in (14.5) is $v = \begin{pmatrix} 1 \\ k \end{pmatrix}$ and hence

$$\langle \alpha | v \rangle = 1 + \frac{k}{\lambda} = \frac{\lambda + k}{\lambda}.$$

But if $\text{Prim}(\lambda + k) \subseteq \text{Prim} \lambda$, this number has a multiplicative inverse in $\mathbb{Z}[\frac{1}{\lambda}]$. Hence the split property used in the proof of Proposition 13.4 can also be deduced from Corollary 11.28.

Let us focus on an example of the use of Propositions 13.1 and 13.3: Consider the list of matrices in Table 2, below. It follows from Proposition 13.3(a) that the only candidates for nontrivial pairs defining isomorphic AF-algebras from this list are

$$(13.37) \quad \begin{pmatrix} 6 & 1 \\ 16 & 0 \end{pmatrix}, \quad \begin{pmatrix} 4 & 1 \\ 32 & 0 \end{pmatrix}$$

and

$$(13.38) \quad J = \begin{pmatrix} 7 & 1 \\ 78 & 0 \end{pmatrix}, \quad J' = \begin{pmatrix} 1 & 1 \\ 156 & 0 \end{pmatrix}.$$

The first of these pairs actually defines isomorphic algebras by Proposition 13.3(b). (This was already proved in [13, Proposition 5].) For the latter of these pairs the special criteria of Proposition 13.1 cannot be employed. But as $78 = 2 \cdot 3 \cdot 13$ and $156 = 2 \cdot 2 \cdot 3 \cdot 13$ we have $\text{gcd}(7, 78) = 1$ and $\text{gcd}(1, 156) = 1$, and it follows from Proposition 11.25 that $\text{deg } J' = 156 - \text{deg } J' = 1 = \text{deg } J = 78 - \text{deg } J$. But $m = \text{lcm}(78, 156) = 156$ and hence we may apply Theorem 11.10 to the pair J, J' . Using the formula in Remark 13.6 we see that

$$\langle \alpha | v \rangle = \frac{19}{13}, \quad \langle \alpha' | v' \rangle = \frac{25}{13},$$

and hence

$$\frac{\langle \alpha | v \rangle}{\langle \alpha' | v' \rangle} = \frac{19}{25} \notin \mathbb{Z}[\frac{1}{13}].$$

It follows from Theorem 11.10 that \mathfrak{A}_J and $\mathfrak{A}_{J'}$ are non-isomorphic.

Finally, note that the set of 2×2 matrices of the form (11.2), or (13.2), with $\lambda = m_2$, i.e., the matrices

$$\begin{pmatrix} \lambda - 1 & 1 \\ \lambda & 0 \end{pmatrix}$$

for $\lambda = 2, 3, 4, \dots$ all give rise to non-isomorphic algebras. This is proved in Section 2.

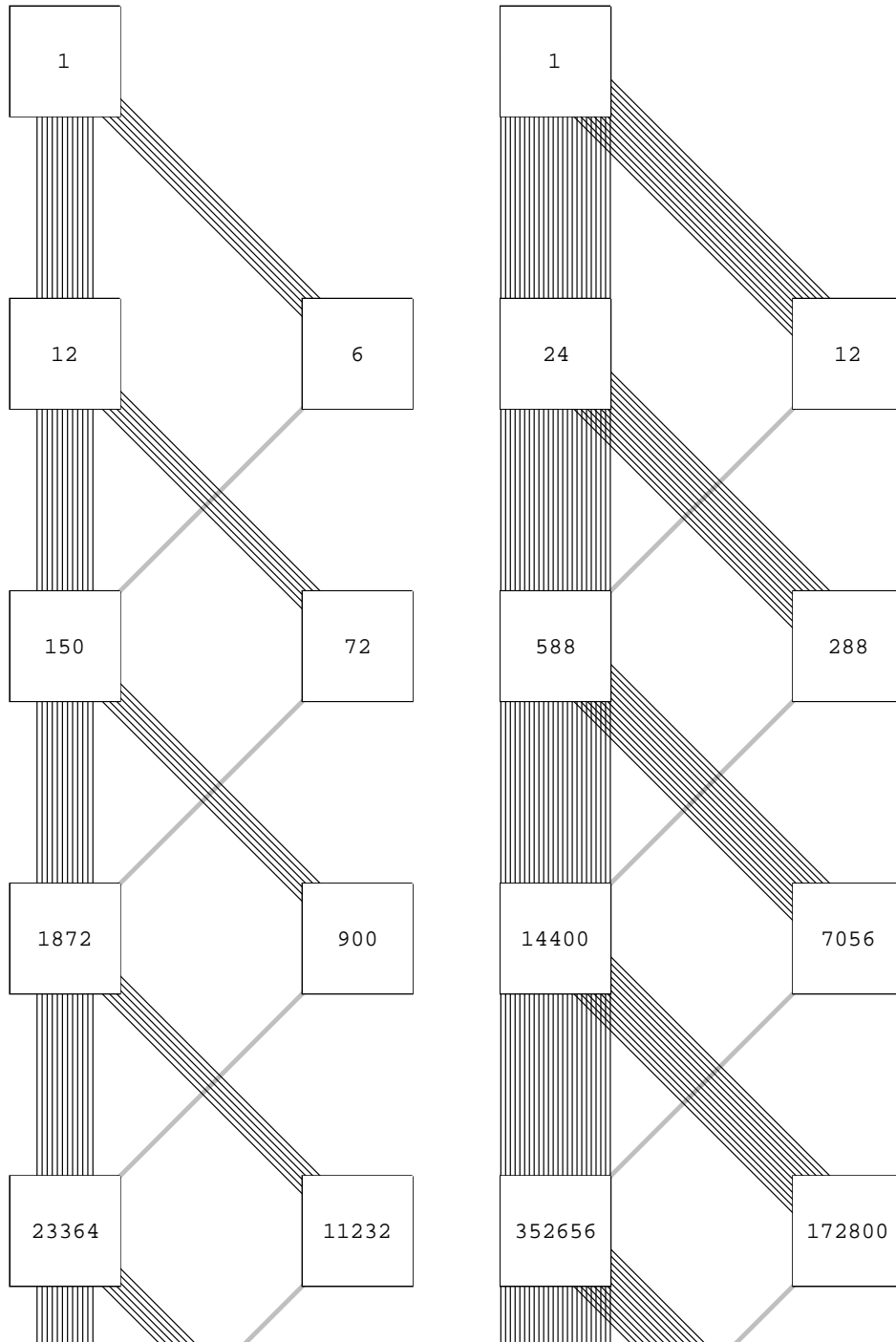

FIGURE 17. $L = \{1, \dots, 1, \underbrace{2, 2, 2, 2, 2, 2}_{12}\}$, first column = $(12 \ 6)^t$ (left); $L = \{1, \dots, 1, \underbrace{2, \dots, 2}_{24}, \underbrace{2}_{12}\}$, first column = $(24 \ 12)^t$ (right). See Example 13.5. These diagrams represent isomorphic algebras.

TABLE 2. Prim invariants for various \mathfrak{A}_L algebras with $\text{rank}(K_0(\mathfrak{A}_L)) = 2$.

Matrix (13.2): $\begin{pmatrix} \lambda-k & 1 \\ k \cdot \lambda & 0 \end{pmatrix}$	Block form (13.4): $\begin{pmatrix} -k & k \\ 0 & \lambda \end{pmatrix}$	Prim(k)	Prim(λ)
<u>$\lambda = 8$</u>			
$\begin{pmatrix} 7 & 1 \\ 8 & 0 \end{pmatrix}$	$\begin{pmatrix} -1 & 1 \\ 0 & 8 \end{pmatrix}$	\emptyset	$\{2\}$
$\begin{pmatrix} 6 & 1 \\ 16 & 0 \end{pmatrix}$	$\begin{pmatrix} -2 & 2 \\ 0 & 8 \end{pmatrix}$	$\{2\}$	$\{2\}$
$\begin{pmatrix} 5 & 1 \\ 24 & 0 \end{pmatrix}$	$\begin{pmatrix} -3 & 3 \\ 0 & 8 \end{pmatrix}$	$\{3\}$	$\{2\}$
$\begin{pmatrix} 4 & 1 \\ 32 & 0 \end{pmatrix}$	$\begin{pmatrix} -4 & 4 \\ 0 & 8 \end{pmatrix}$	$\{2\}$	$\{2\}$
$\begin{pmatrix} 3 & 1 \\ 40 & 0 \end{pmatrix}$	$\begin{pmatrix} -5 & 5 \\ 0 & 8 \end{pmatrix}$	$\{5\}$	$\{2\}$
$\begin{pmatrix} 2 & 1 \\ 48 & 0 \end{pmatrix}$	$\begin{pmatrix} -6 & 6 \\ 0 & 8 \end{pmatrix}$	$\{2, 3\}$	$\{2\}$
$\begin{pmatrix} 1 & 1 \\ 56 & 0 \end{pmatrix}$	$\begin{pmatrix} -7 & 7 \\ 0 & 8 \end{pmatrix}$	$\{7\}$	$\{2\}$
<u>$\lambda = 13$</u>			
$\begin{pmatrix} 7 & 1 \\ 6 \cdot 13 & 0 \end{pmatrix}$	$\begin{pmatrix} -6 & 6 \\ 0 & 13 \end{pmatrix}$	$\{2, 3\}$	$\{13\}$
$\begin{pmatrix} 1 & 1 \\ 12 \cdot 13 & 0 \end{pmatrix}$	$\begin{pmatrix} -12 & 12 \\ 0 & 13 \end{pmatrix}$	$\{2, 3\}$	$\{13\}$

Case 2. The Perron–Frobenius eigenvalue λ is irrational, and hence in a quadratic extension of \mathbb{Z} , since λ satisfies a monic quadratic equation.

In this case, the exact sequence (5.31) is

$$0 \longrightarrow 0 \longrightarrow K_0(\mathfrak{A}) \longrightarrow \mathbb{Z} \left[\frac{1}{\lambda} \right] \longrightarrow 0,$$

so $K_0(\mathfrak{A})$ equals $\mathbb{Z} \left[\frac{1}{\lambda} \right]$, in the sense of ordered groups. But since $(K_0(\mathfrak{A}), K_0(\mathfrak{A})_+)$ is a complete invariant, and the *ordered* group $\mathbb{Z}[\lambda]$ determines $1/\lambda$ uniquely when $1/\lambda$ is in a quadratic extension of \mathbb{Q} , it follows that the irrational number

$$\frac{1}{\lambda} = \frac{\sqrt{m_1^2 + 4m_2} - m_1}{2m_2}$$

is a complete invariant. But since the equation

$$1 - m_1x - m_2x^2 = 0$$

for $1/\lambda$ is irreducible, and $1/\lambda$ is characterized as the positive solution of this equation it follows that λ determines m_1, m_2 in this case. Conclusion:

Proposition 13.7. *If*

$$(13.39) \quad J = \begin{pmatrix} m_1 & 1 \\ m_2 & 0 \end{pmatrix}, \quad J' = \begin{pmatrix} m'_1 & 1 \\ m'_2 & 0 \end{pmatrix}$$

are matrices with $m_1, m_2, m'_1, m'_2 \in \mathbb{N}$ and at least one of the numbers $\sqrt{m_1^2 + 4m_2}$ or $\sqrt{m_1'^2 + 4m_2'}$ is irrational, then the AF-algebra \mathfrak{A}_J is isomorphic to $\mathfrak{A}_{J'}$ if and only if

$$(13.40) \quad m_1 = m'_1 \quad \text{and} \quad m_2 = m'_2.$$

Finally, recall that if $m_1 = 1, m_2 = m \in \mathbb{N}$, then \mathfrak{A}_J is the Pimsner–Voiculescu algebra associated with the continued fraction

$$(13.41) \quad \lambda = \frac{m_1 + \sqrt{m_1^2 + 4m_2}}{2} = m_1 + \frac{m_2}{\lambda} = m_1 + \frac{m_2}{m_1 + \frac{m_2}{m_1 + \frac{m_2}{m_1 + \dots}}};$$

see [75]. See Figure 2 for the special case $m_1 = m_2 = 1$.

Linear algebra of J

We have introduced several parameters related to C^* -isomorphism invariants on the AF-algebras \mathfrak{A}_L , $L = (L_1, \dots, L_d)$ such that $\gcd(L_i) = 1$. Those parameters compute out as shown in Table 3 for the examples in Figures 1–5 and 12. We have included the value of d from \mathcal{O}_d , and the Perron–Frobenius eigenvalue λ , in the table (we have shown in Example 5.3 that d is not an invariant in general). The actual invariants are $\mathbb{Z}[\frac{1}{\lambda}]$, D , N , $\text{Prim}(m_N/R_D)$, $\text{Prim}(R_D)$, while $\tau(v)$ is a restricted invariant (see Theorems 7.8 and 11.10).

Remark 14.1. It is to be stressed that the parameters are computed for examples (L_1, \dots, L_d) , subject to the restriction that the greatest common divisor is one, i.e., $\gcd(L_i) = 1$. It is immediate from Chapter 3 that the pair of AF-algebras \mathfrak{A}_L and \mathfrak{A}_{sL} computed from the two, (L_1, \dots, L_d) and (sL_1, \dots, sL_d) , are isomorphic. But, in a sense, the two parameters N and $\varphi_\tau = \lambda^{-1}p'_L(\frac{1}{\lambda})$ scale by s . Since

TABLE 3. Some parameters related to invariants for various \mathfrak{A}_L algebras.

Fig. #	Equation	d	λ	D	N	m_N	R_D	$\tau(v)$
1	$2x = 1$	2	$\lambda = 2$	1	1	2	2	1
2	$x + x^2 = 1$	2	$\lambda = \frac{1+\sqrt{5}}{2}$	2	2	1	1	$\frac{5-\sqrt{5}}{2} = \frac{\sqrt{5}}{\lambda}$
3	$2x^4 + x^5 + x^8 = 1$	4	$\lambda = a_3^{-1}$, $a_3 = 0.7549^*$	3	8	1	1	$4 + a_3^5 + 4a_3^8$ ≈ 4.6669
4	$x^2 + x^3 = 1$	2	$\lambda = a_3^{-1*}$	3	3	1	1	$2 + a_3^3$ ≈ 2.4302
5	$x^2 + x^3 + x^5 = 1$	3	$\lambda = a^{-1}$, $a = 0.6997$	5	5	1	1	$2 + a^3 + 3a^5$ ≈ 2.8459
	$x + x^5 = 1$	2	$\lambda = a_3^{-1*}$	3	5	1	1	$1 + 4a_3^5$ ≈ 1.9805
	$x + 4x^3 = 1$	5	$\lambda = 2$	1	3	4	2	2
	$3x^2 + 2x^3 = 1$	5	$\lambda = 2$	1	3	2	2	$\frac{9}{4}$
12	$x + 3x^3 + 2x^4 = 1$	6	$\lambda = 2$	1	4	2	2	$\frac{17}{8}$
12	$3x^2 + x^3 + 2x^4 = 1$	6	$\lambda = 2$	1	4	2	2	$\frac{19}{8}$
	$x + 2x^3 + 4x^4 = 1$	7	$\lambda = 2$	1	4	4	2	$\frac{9}{4}$
	$3x^2 + 4x^4 = 1$	7	$\lambda = 2$	1	4	4	2	$\frac{5}{2}$

* Note: $x^2 + x^3 - 1$ is a factor of both $2x^4 + x^5 + x^8 - 1$ and $x + x^5 - 1$; see lines 3, 4, 6.

$m_N = |\det J|$, m_N does not. To see this, note that the scaling $L \mapsto sL$, $s \in \mathbb{N}$, corresponds to a simple inflation of J , as illustrated by ($s = 2$):

$$\begin{pmatrix} m_1 & 1 & 0 \\ m_2 & 0 & 1 \\ m_3 & 0 & 0 \end{pmatrix} \mapsto \begin{pmatrix} 0 & 1 & 0 & 0 & 0 & 0 \\ m_1 & 0 & 1 & 0 & 0 & 0 \\ 0 & 0 & 0 & 1 & 0 & 0 \\ m_2 & 0 & 0 & 0 & 1 & 0 \\ 0 & 0 & 0 & 0 & 0 & 1 \\ m_3 & 0 & 0 & 0 & 0 & 0 \end{pmatrix},$$

and these matrices define isomorphic stable AF-algebras. (For the 6×6 matrix the maps in the inductive sequence are not injective.) In the last example, to get back from the inflated matrix to J , simply delete the rows numbered 1, 3, and 5 (shaded), and the columns numbered 2, 4, and 6.

Hence, to compute parameters for a general divisible (L_i) -system, first pass to (L'_i) where $L'_i = \frac{1}{\gcd(L_j)} L_i$, and then use the prescribed formulas (for the parameters) on the (L'_i) -system.

We next consider the following observation regarding the parameter $\tau(v)$.

Proposition 14.2 (Scaling Property for the Parameter). *Let (L_1, \dots, L_d) be given, and let $s \in \mathbb{Q}_+$. Let $\tau(v)$ and $\tau(v_s)$ be the respective numbers for L and sL , as follows: let $v \in \mathbb{R}^N$ satisfy $Jv = \lambda v$, $v_1 = 1$, where λ is the Perron–Frobenius eigenvalue for $\alpha J = \lambda \alpha$. Then*

$$(14.1) \quad \tau(v) = \lambda^{-1} p'_L \left(\frac{1}{\lambda} \right)$$

where

$$(14.2) \quad p_L(x) = \sum_{i=1}^d x^{L_i} - 1,$$

and the corresponding number for sL is

$$(14.3) \quad \tau(v_s) = s\tau(v).$$

Suppose $\deg(L) > 1$. Let the other roots of $p_L(x)$ be $\{a_i\}_{i=1}^{L_d-1}$. Then, by the assumptions, $|a_i^{-1}| < \lambda$, and

$$p'_L(e^{-\beta L}) = \prod_{i=1}^{L_d-1} (e^{-\beta L} - a_i).$$

Proof. Writing J in the form

$$(14.4) \quad J = \begin{pmatrix} m_1 & 1 & 0 & \cdots & 0 & 0 \\ m_2 & 0 & 1 & \cdots & 0 & 0 \\ \vdots & & \ddots & \ddots & \vdots & \vdots \\ m_{N-2} & 0 & 0 & \ddots & 1 & 0 \\ m_{N-1} & 0 & 0 & & 0 & 1 \\ m_N & 0 & 0 & \cdots & 0 & 0 \end{pmatrix},$$

note that then (14.2) becomes

$$p_L(x) = \sum_{j=1}^N m_j x^j - 1,$$

and the eigenvector v may be computed by directly solving $Jv = \lambda v$:

$$(14.5) \quad v = \begin{pmatrix} 1 \\ \lambda - m_1 \\ \lambda^2 - m_1\lambda - m_2 \\ \lambda^3 - m_1\lambda^2 - m_2\lambda - m_3 \\ \vdots \\ \lambda^{N-1} - m_1\lambda^{N-2} - \dots - m_{N-2}\lambda - m_{N-1} \end{pmatrix} \in \mathbb{R}^N.$$

Since $\tau(x) = \langle \alpha | x \rangle$, with $\alpha = (1, a, a^2, \dots, a^{N-1})$, and $a = \frac{1}{\lambda}$, we get

$$\begin{aligned} \tau(v) &= \langle \alpha | v \rangle \\ &= N - (N-1)m_1a - (N-2)m_2a^2 - \dots - 2m_{N-2}a^{N-2} - m_{N-1}a^{N-1} \\ &= Nm_Na^N + m_1a + 2m_2a^2 + \dots + (N-1)m_{N-1}a^{N-1} \\ &= ap'_L(a), \end{aligned}$$

where we used the fact that

$$m_1a + m_2a^2 + \dots + m_Na^N = 1.$$

We claimed in (14.1)–(14.2) that $\tau(v) = ap'_L(a)$, and this now follows. The scaling property (14.3) is immediate from this. \square

Corollary 14.3. *Let J, J' be two matrices specified as in (14.4), and suppose they have the same value for the rank N and the same Perron–Frobenius eigenvalue λ . Let v , resp. v' , be the right Perron–Frobenius eigenvectors (with $v_1 = v'_1 = 1$). Then*

$$v = v' \iff J = J'.$$

Proof. If $v = v'$, then recursion in (14.5) yields $m_i = m'_i$ for $i = 1, 2, \dots, N-1$. Since N and λ take the same values on J and J' , the *identity* (in each case),

$$\lambda^{N-1} - m_1\lambda^{N-2} - \dots - m_{N-2}\lambda - m_{N-1} = \frac{m_N}{\lambda},$$

shows that then also $m_N = m'_N$, and therefore, by (14.4), $J = J'$. The converse is clear. \square

Lattice points

Let $(L_i)_{i=1}^d$ be a standard system, and let \mathfrak{A}_L be the corresponding AF-algebra. We saw that the trace is unique and determined by the value of the L_i 's. It is clear that when (L_i) is given ($L_i > 0$ say), there is a unique β such that $\sum_{i=1}^d e^{-\beta L_i} = 1$. This means that $x_\beta := e^{-\beta}$ is a root of

$$p_L(x) = x^{L_1} + \cdots + x^{L_d} - 1.$$

But with the restrictions $L_i \in \mathbb{N}$, $L_1 \leq L_2 < \cdots \leq L_d$, it follows from Example 5.3, and, later, Chapter 16, that the L_i 's are *not* determined by β . We have already seen examples illustrating that, up to the obvious permutations, there is for fixed $0 < x < 1$ and d , a multiplicity of lattice points on the variety $(L_i) \subseteq \mathbb{R}^d$, $L_i > 0$ with Perron–Frobenius eigenvalue $1/x$. The pair of lattice points $(2, 3)$, $(1, 5)$ in Figure 18 are on the same curve. For $d = 2$, we know of no other pair of distinct lattice points over the 45° line lying on the same curve.

Example 15.1. Consider the AF-algebra of $x^2 + x^3 = 1$ in Figure 4. There $e^{-\beta} = a \approx 0.7549$ is the positive root and $p_\beta(x) := 1 - x^2 - x^3$ is the minimal polynomial. K_0 of this example is therefore given by (5.26), and $\ker(\tau) = 0$. But there is also an example for $N = 5$, $J_5 = \begin{pmatrix} 1 & 1 & 0 & 0 & 0 \\ 0 & 0 & 1 & 0 & 0 \\ 0 & 0 & 0 & 1 & 0 \\ 0 & 0 & 0 & 0 & 1 \\ 1 & 0 & 0 & 0 & 0 \end{pmatrix}$ with the same β (and therefore root $a = e^{-\beta}$). Now for this related example, there are infinitesimal elements, i.e., $\ker(\tau_5) \neq 0$ (in fact $\ker(\tau_5) \cong \mathbb{Z}^2$), and hence the corresponding two AF-algebras are non-isomorphic. Specifically, $\ker(\tau_5)$ may be computed from (5.29) where the restriction matrix J_0 is $\begin{pmatrix} 1 & 1 \\ -1 & 0 \end{pmatrix}$. Since $\det J_0 = 1$, it follows that $\ker(\tau_5) \cong \mathbb{Z}^2$, as claimed.

The examples $x^5 + x - 1$ and $x^3 + x^2 - 1$ show that we *must* at least add $N = N'$ as a condition for isomorphism, because these two have the same β . (In fact $x^5 + x - 1 = (x^3 + x^2 - 1)(x^2 - x + 1)$.) The triangular form $J_5 = \left(\begin{array}{c|c} J_0 & Q \\ \hline 0 & J_R \end{array} \right)$ from Theorem 7.5 which corresponds to this factorization is

$$J_0 \rightarrow \left(\begin{array}{cc|ccc} -1 & 1 & 1 & 0 & 0 \\ 1 & 0 & -1 & 0 & 0 \\ \hline 0 & 0 & 0 & 1 & 0 \\ 0 & 0 & 1 & 0 & 1 \\ 0 & 0 & 1 & 0 & 0 \end{array} \right) \leftarrow Q$$

$$J: \left(\begin{array}{cc|ccc} 0 & 0 & 0 & 1 & 0 \\ 0 & 0 & 1 & 0 & 1 \\ 0 & 0 & 1 & 0 & 0 \end{array} \right) \leftarrow J_R$$

and the three Prim-invariants from Theorem 7.8 are all \emptyset .

However, in Chapter 16, for $d \geq 5$, we will give other examples of multiple lattice points. (We also gave such examples in Example 5.3.) In those examples, for each of the cases $d = 5$ and $d = 6$, there are three such multiple points on the

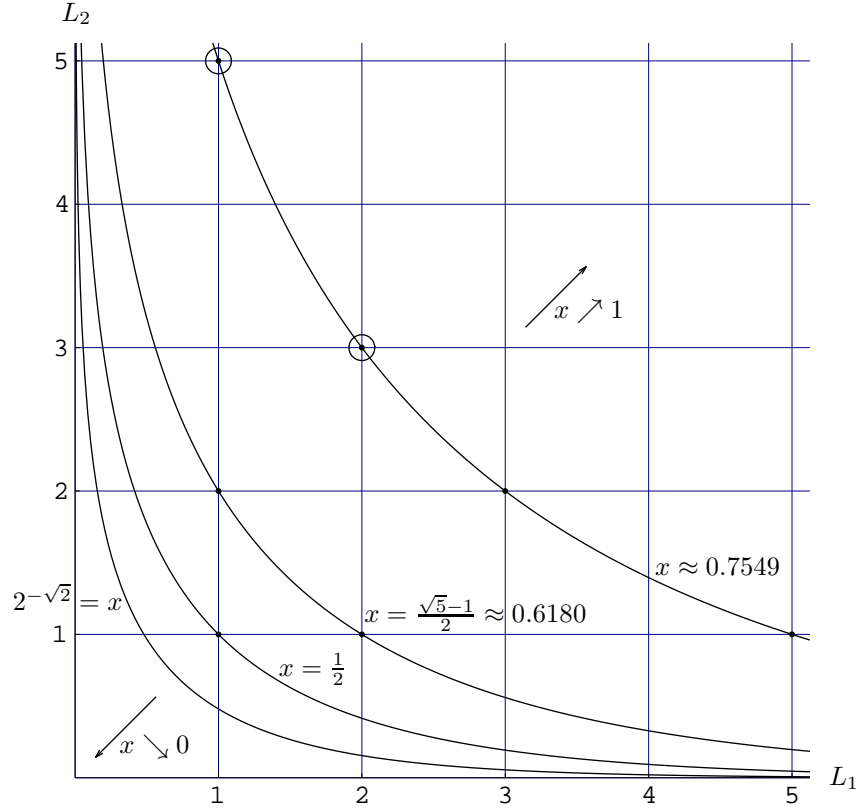

FIGURE 18. Examples from lattice points: $\frac{dL_2}{dL_1} = -x^{L_1-L_2}$.

$e^{-\beta} = \frac{1}{2}$ variety. There are others for different values of β , but none with $d = 2$. The value of d is different for the two in the above pair; and if it is further assumed that $l = L_1 + L_2$ be the same, convexity and symmetry show that there cannot be double points.

For $d = 2$, the picture is as shown in Figure 18. There is some non-uniqueness as follows: if

$$m_1 x^{L_1} + m_2 x^{L_2} + \dots + m_k x^{L_k} = 1$$

where $L_i, m_i \in \mathbb{N}$, then, if $Q(x)$ is any polynomial of the form $Q(x) = 1 + \sum_{m=1}^k n_m x^{L_m}$, where n_m are positive integers, $0 \leq n_m \leq L_m$, then $Q(x)(m_1 x^{L_1} + \dots + m_k x^{L_k} - 1) = 0$, which gives another polynomial of the form above. Even the added condition

$$\sum_i m_i = d$$

does not imply uniqueness, by Example 5.3 and Chapter 16.

Complete classification in the cases $\lambda = 2$, $N = 2, 3, 4$

The examples when the Perron–Frobenius eigenvalue $\lambda = 2$ entail some of the essential features of the dimension groups associated with the corresponding AF-algebras \mathfrak{A}_L .

The construction in the examples below is a special case of the following: Let $p(x) \in \mathbb{Z}[x]$ be given, and assume it is irreducible. Let $N \in \mathbb{N}$, and let $\mathcal{F}_N(p)$ be the set of $N \times N$ matrices over \mathbb{Z} of the form

$$(16.1) \quad J = \begin{pmatrix} m_1 & 1 & \cdots & 0 & 0 \\ m_2 & 0 & \ddots & 0 & 0 \\ \vdots & & \ddots & \ddots & \vdots \\ m_{N-1} & 0 & & 0 & 1 \\ m_N & 0 & \cdots & 0 & 0 \end{pmatrix}$$

with $m_N \geq 1$, and $m_i \geq 0$, such that $p(x)$ divides $p_J(x) = \sum_{i=1}^N m_i x^i - 1$. We saw that, for $p(x) = 2x - 1$, $x_N = \#\mathcal{F}_N(2x - 1)$ is finite for all $N = 2, 3, \dots$. An analogue of this holds true in general. If $p(x) = x^2 + x^3 - 1$ (see Example 5.3), then $\mathcal{F}_4(p) = \emptyset$, while $x_5(p) = \#\mathcal{F}_5(p) = 2$. The two elements of $\mathcal{F}_5(p)$ are

$$\begin{pmatrix} m_1 \\ m_2 \\ m_3 \\ m_4 \\ m_5 \end{pmatrix} : \begin{pmatrix} 1 \\ 0 \\ 0 \\ 0 \\ 1 \end{pmatrix}, \begin{pmatrix} 0 \\ 0 \\ 1 \\ 1 \\ 1 \end{pmatrix},$$

corresponding to isomorphic \mathfrak{A}_L 's. This approach is in general most useful if $p(x)$ has the form $\sum_{i=1}^D n_i x^i - 1$ where the n_i are nonnegative integers, $n_D \neq 0$ and $\gcd\{i \mid n_i \neq 0\} = 1$, because then we can say at the outset that the Perron–Frobenius eigenvalue of (16.1) is $1/a$, where a is the unique positive root of $p(x)$.

For each $N = 2, 3, 4, \dots$, there is only a finite number x_N of possibilities for the matrix J . Since the matrix J is of the form (16.1) they are described by the numbers m_i of the first column. They are given by the following algorithm: If $Q_1, \dots, Q_{N-1} \in \mathbb{Z}$, and $q(x) = 1 + Q_{N-1}x + \cdots + Q_1x^{N-1}$, then $p_L(x) = (2x - 1)q(x)$ has the form

$$p_L(x) = -1 + m_1x + \cdots + m_Nx^N$$

with $m_i \geq 0$, $m_N > 0$ if and only if $Q_1 > 0$ and

$$(16.2) \quad \left\{ \begin{array}{l} Q_1 \leq 2Q_2, \\ Q_2 \leq 2Q_3, \\ \vdots \\ Q_{N-2} \leq 2Q_{N-1}, \\ Q_{N-1} \leq 2. \end{array} \right.$$

This is proved by simple algebra. The numbers x_N are $x_2 = 2$, $x_3 = 6$, $x_4 = 26$, \dots . In a slightly more condensed form, the conditions are

$$0 < Q_1 \leq 2 \cdot Q_2 \leq 4 \cdot Q_3 \leq 8 \cdot Q_4 \leq \dots \leq 2^{N-2} \cdot Q_{N-1} \leq 2^{N-1}.$$

It follows that the specific cases may be summarized for $N = 2, 3$, and 4 (lexicographic order from (16.2)):

$$(16.3) \quad \begin{pmatrix} m_1 \\ m_2 \end{pmatrix} : \begin{pmatrix} 1 \\ 2 \end{pmatrix}, \begin{pmatrix} 0 \\ 4 \end{pmatrix}^*,$$

$$(16.4) \quad \begin{pmatrix} m_1 \\ m_2 \\ m_3 \end{pmatrix} : \begin{pmatrix} 1 \\ 1 \\ 2 \end{pmatrix}, \begin{pmatrix} 1 \\ 0 \\ 4 \end{pmatrix}, \begin{pmatrix} 0 \\ 3 \\ 2 \end{pmatrix}, \begin{pmatrix} 0 \\ 2 \\ 4 \end{pmatrix}, \begin{pmatrix} 0 \\ 1 \\ 6 \end{pmatrix}, \begin{pmatrix} 0 \\ 0 \\ 8 \end{pmatrix}^*,$$

and

$$(16.5) \quad \begin{pmatrix} m_1 \\ m_2 \\ m_3 \\ m_4 \end{pmatrix} : \begin{pmatrix} 1 \\ 1 \\ 1 \\ 2 \end{pmatrix}, \begin{pmatrix} 1 \\ 1 \\ 0 \\ 4 \end{pmatrix}, \begin{pmatrix} 1 \\ 0 \\ 3 \\ 2 \end{pmatrix}, \begin{pmatrix} 1 \\ 0 \\ 2 \\ 4 \end{pmatrix}, \begin{pmatrix} 1 \\ 0 \\ 1 \\ 6 \end{pmatrix}, \begin{pmatrix} 1 \\ 0 \\ 0 \\ 8 \end{pmatrix}, \begin{pmatrix} 0 \\ 3 \\ 1 \\ 2 \end{pmatrix}, \begin{pmatrix} 0 \\ 3 \\ 0 \\ 4 \end{pmatrix}^*, \begin{pmatrix} 0 \\ 2 \\ 3 \\ 2 \end{pmatrix},$$

$$\begin{pmatrix} 0 \\ 2 \\ 2 \\ 4 \end{pmatrix}, \begin{pmatrix} 0 \\ 2 \\ 1 \\ 6 \end{pmatrix}, \begin{pmatrix} 0 \\ 2 \\ 0 \\ 8 \end{pmatrix}^*, \begin{pmatrix} 0 \\ 1 \\ 5 \\ 2 \end{pmatrix}, \begin{pmatrix} 0 \\ 1 \\ 4 \\ 4 \end{pmatrix}, \begin{pmatrix} 0 \\ 1 \\ 3 \\ 6 \end{pmatrix}, \begin{pmatrix} 0 \\ 1 \\ 2 \\ 8 \end{pmatrix}, \begin{pmatrix} 0 \\ 1 \\ 1 \\ 10 \end{pmatrix}, \begin{pmatrix} 0 \\ 1 \\ 0 \\ 12 \end{pmatrix}^*,$$

$$\begin{pmatrix} 0 \\ 0 \\ 7 \\ 2 \end{pmatrix}, \begin{pmatrix} 0 \\ 0 \\ 6 \\ 4 \end{pmatrix}, \begin{pmatrix} 0 \\ 0 \\ 5 \\ 6 \end{pmatrix}, \begin{pmatrix} 0 \\ 0 \\ 4 \\ 8 \end{pmatrix}, \begin{pmatrix} 0 \\ 0 \\ 3 \\ 10 \end{pmatrix}, \begin{pmatrix} 0 \\ 0 \\ 2 \\ 12 \end{pmatrix}, \begin{pmatrix} 0 \\ 0 \\ 1 \\ 14 \end{pmatrix}, \begin{pmatrix} 0 \\ 0 \\ 0 \\ 16 \end{pmatrix}^*.$$

But inspection reveals that, of the two $N = 2$ cases (16.3), only the first one has L_i -values with greatest common divisor equal to one. For the six $N = 3$ cases (16.4), all but the last of them have this property. Finally, for the $N = 4$ examples (16.5), the property holds for all but the 8th, 12th, 18th and the last one. Note that the \mathfrak{A}_L 's associated to the last vector in each of the three sequences are all isomorphic, and isomorphic to the algebra defined by the constant 1×1 incidence matrix (2), i.e., the Glimm algebra of type 2^∞ illustrated in Figure 1. The algebras corresponding to the third and seventh vectors in the $N = 4$ sequence (16.5) are illustrated in Figure 12.

In order to distinguish the isomorphism classes of the remaining specimens, we will use the invariants developed in Chapters 6–12. Since $\lambda = 2$ in these cases,

we always have $\tau(K_0(\mathfrak{A}_L)) = \mathbb{Z} \left[\frac{1}{2} \right]$ and $D = 1$. Thus the invariants in Chapter 7 reduce to N , $\text{Prim}(m_N)$, and $\text{Prim}(Q_{N-1}) = \text{Prim}(m_N/2)$. It follows from Remark 11.15 that in these cases $m_N = 2$ if and only if $\ker \tau \cong \mathbb{Z}^{N-1}$, and then Corollary 11.13 can be used to distinguish some cases. Here $\alpha = (1, \frac{1}{2}, \frac{1}{4}, \dots, \frac{1}{2^{N-1}})$ by (5.17) and v is given by (14.5) with $\lambda = 2$. (The case $\lambda = m_N$ will be studied in detail in Chapter 17.) We will also use some secondary invariants derived from the group $G_0 = \ker \tau$, since of course any group invariant derived from G_0 is an invariant for \mathfrak{A}_L . Since G_0 is a natural \mathbb{Z} -module, the tensor product group $G_0 \otimes \mathbb{Z}_p$ (tensor products as \mathbb{Z} -modules) is a secondary invariant. For example $\mathbb{Z}_q \otimes \mathbb{Z}_p \cong \mathbb{Z}_{\gcd(q,p)}$, $\mathbb{Z} \otimes \mathbb{Z}_p \cong \mathbb{Z}_p$ and $\mathbb{Z} \left[\frac{1}{q} \right] \otimes \mathbb{Z}_p \cong \mathbb{Z}_{(p,q)}$ where $(p, q) = p/\gcd(p, q^\infty)$ is defined by (13.12). For our specimens, it will be useful to use $p = 2$, and using (5.41): $G_0 \cong \mathbb{Z}[x]/(p_0(x))$, we obtain $G_0 \otimes \mathbb{Z}_2 \cong \mathbb{Z}_2(x)/(p_{0,2}(x))$ where $p_{0,2}(x)$ is the polynomial obtained from $p_0(x)$ by reducing the coefficients modulo 2. Thus $G_0 \otimes \mathbb{Z}_2$ is the direct sum of a finite number of copies of \mathbb{Z}_2 , and this finite number is an invariant. See Corollary 8.9.

Then to work on the list (16.3)–(16.5).

Rank 2 ($N = 2$): By (16.3) there is only one specimen, $\begin{pmatrix} 1 \\ 2 \end{pmatrix}$.

Rank 3 ($N = 3$): By (16.4), there are five specimens, which can first be classified as follows:

Group number	Prim(m_3) Prim($m_3/2$)	
1	{2} \emptyset	$\begin{pmatrix} 1 \\ 1 \\ 2 \end{pmatrix}^{(a)}, \begin{pmatrix} 0 \\ 3 \\ 2 \end{pmatrix}^{(b)},$
2	{2} {2}	$\begin{pmatrix} 1 \\ 0 \\ 4 \end{pmatrix}^{(a)}, \begin{pmatrix} 0 \\ 2 \\ 4 \end{pmatrix}^{(b)},$
3	{2, 3} {3}	$\begin{pmatrix} 0 \\ 1 \\ 6 \end{pmatrix}.$

For **Group 1**, we may use Corollary 11.13. But this was done already in Example 11.29 with the result that these two specimens define non-isomorphic algebras. (Specimen (b) will be considered further in Example 18.2.)

For **Group 2**, we compute, using (8.26) in Corollary 8.9,

Group 2	Specimen	$p_0(x)$	$G_0 \otimes \mathbb{Z}_2$
(a)	$\begin{pmatrix} 1 \\ 0 \\ 4 \end{pmatrix}$	$2x^2 + x + 1$	\mathbb{Z}_2
(b)	$\begin{pmatrix} 0 \\ 2 \\ 4 \end{pmatrix}$	$2x^2 + 2x + 1$	0

and hence G_0 is non-isomorphic for the two examples. (Specimen (a) here has already been studied in Remark 9.3, and will again be considered in Example 18.1.)

We conclude that all the 5 specimens in the $N = 3$ case are mutually non-isomorphic.

Rank 4 ($N = 4$): Here we have 22 specimens which can be divided into 6 groups according to the invariants $\text{Prim}(m_4)$, $\text{Prim}(m_4/2)$:

Group number	$\text{Prim}(m_4)$ $\text{Prim}(m_4/2)$	
1	$\{2\}$ \emptyset	$\begin{pmatrix} 1 \\ 1 \\ 1 \\ 2 \end{pmatrix}^{(1)}$ $\begin{pmatrix} 1 \\ 0 \\ 3 \\ 2 \end{pmatrix}^{(2)}$ $\begin{pmatrix} 0 \\ 3 \\ 1 \\ 2 \end{pmatrix}^{(3)}$ $\begin{pmatrix} 0 \\ 2 \\ 3 \\ 2 \end{pmatrix}^{(4)}$ $\begin{pmatrix} 0 \\ 1 \\ 5 \\ 2 \end{pmatrix}^{(5)}$ $\begin{pmatrix} 0 \\ 0 \\ 7 \\ 2 \end{pmatrix}^{(6)}$
2	$\{2\}$ $\{2\}$	$\begin{pmatrix} 1 \\ 1 \\ 0 \\ 4 \end{pmatrix}^{(a)}$ $\begin{pmatrix} 1 \\ 0 \\ 2 \\ 4 \end{pmatrix}^{(b)}$ $\begin{pmatrix} 1 \\ 0 \\ 0 \\ 8 \end{pmatrix}^{(c)}$ $\begin{pmatrix} 0 \\ 2 \\ 2 \\ 4 \end{pmatrix}^{(d)}$ $\begin{pmatrix} 0 \\ 1 \\ 4 \\ 4 \end{pmatrix}^{(e)}$ $\begin{pmatrix} 0 \\ 1 \\ 2 \\ 8 \end{pmatrix}^{(f)}$ $\begin{pmatrix} 0 \\ 0 \\ 6 \\ 4 \end{pmatrix}^{(g)}$ $\begin{pmatrix} 0 \\ 0 \\ 4 \\ 8 \end{pmatrix}^{(h)}$
3	$\{2, 3\}$ $\{3\}$	$\begin{pmatrix} 1 \\ 0 \\ 1 \\ 6 \end{pmatrix}^{(a)}$ $\begin{pmatrix} 0 \\ 2 \\ 1 \\ 6 \end{pmatrix}^{(b)}$ $\begin{pmatrix} 0 \\ 1 \\ 3 \\ 6 \end{pmatrix}^{(c)}$ $\begin{pmatrix} 0 \\ 0 \\ 5 \\ 6 \end{pmatrix}^{(d)}$
4	$\{2, 3\}$ $\{2, 3\}$	$\begin{pmatrix} 0 \\ 0 \\ 2 \\ 12 \end{pmatrix}$
5	$\{2, 5\}$ $\{5\}$	$\begin{pmatrix} 0 \\ 1 \\ 1 \\ 10 \end{pmatrix}^{(a)}$ $\begin{pmatrix} 0 \\ 0 \\ 3 \\ 10 \end{pmatrix}^{(b)}$
6	$\{2, 7\}$ $\{7\}$	$\begin{pmatrix} 0 \\ 0 \\ 1 \\ 14 \end{pmatrix}$

For **Group 1**, we may apply Corollary 11.13. Using (5.17) with $e^{-\beta} = \frac{1}{2}$ and (14.5) together with $p_L(2) = 0$, we compute for two general matrices of the form (14.4) with $N = 4$ and $\lambda = 2$ that

$$\langle \alpha | v \rangle = \frac{1}{8} (4(m_1 + m_2) + 3m_3 + 2m_4).$$

For the 6 specimens in group 1 this leads to

$$\langle \alpha | v_i \rangle = \frac{13 + 2i}{8}$$

for $i = 1, 2, \dots, 6$. It follows that

$$\frac{\langle \alpha | v_i \rangle}{\langle \alpha | v_j \rangle} \notin \mathbb{Z} \left[\frac{1}{2} \right]$$

whenever $i \neq j$, $i, j = 1, \dots, 6$. We conclude from Corollary 11.13 that all these 6 specimens define mutually non-isomorphic algebras \mathfrak{A}_L , although each defines an exact sequence of the form

$$0 \longrightarrow \mathbb{Z}^3 \longrightarrow G \longrightarrow \mathbb{Z} \left[\frac{1}{2} \right] \longrightarrow 0.$$

In **Group 2** there are 8 specimens. Let us compute the polynomial $p_0(x) = p_L(x)/(2x-1)$ for these, and use the result to compute $G_0 \otimes \mathbb{Z}_2$, where $G_0 = \ker \tau = \mathbb{Z}[x]/(p_0(x))$, using (8.26) in Corollary 8.9. The result is exhibited in Table 4 on the next page.

It follows from Table 4 that we can group the 8 specimens into 3 subgroups with no isomorphism between the different subgroups:

Subgroup 1

$$(d): \begin{pmatrix} 0 \\ 2 \\ 2 \\ 4 \end{pmatrix}, \quad (g): \begin{pmatrix} 0 \\ 0 \\ 6 \\ 4 \end{pmatrix}, \quad (h): \begin{pmatrix} 0 \\ 0 \\ 4 \\ 8 \end{pmatrix}.$$

Here $\ker \tau \otimes \mathbb{Z}_2 = 0$, so $\ker \tau$ is a torsion-free abelian group of rank 3 such that all the elements are divisible by 2, and also $\ker(\tau) \subseteq \mathbb{Z} \left[\frac{1}{2} \right]^3$. It follows that

$$\ker \tau = \mathbb{Z} \left[\frac{1}{2} \right]^3.$$

Thus G is an extension

$$0 \longrightarrow \mathbb{Z} \left[\frac{1}{2} \right]^3 \longrightarrow G \longrightarrow \mathbb{Z} \left[\frac{1}{2} \right] \longrightarrow 0$$

in all three cases. But $\text{Ext} \left(\mathbb{Z} \left[\frac{1}{2} \right], \mathbb{Z} \left[\frac{1}{2} \right]^3 \right) = 0$ by [20, Proposition VI.2.1]. (If one assumes *a priori* that G is divisible by 2 this is trivial, but in the general case one proceeds as follows: It is clear that $\text{Ext} \left(\mathbb{Z} \left[\frac{1}{2} \right], \mathbb{Z} \left[\frac{1}{2} \right]^3 \right) \cong \text{Ext} \left(\mathbb{Z} \left[\frac{1}{2} \right], \mathbb{Z} \left[\frac{1}{2} \right] \right)^3$ (i.e., three copies). Assume that

$$(16.6) \quad 0 \longrightarrow \mathbb{Z} \left[\frac{1}{2} \right] \longrightarrow M \longrightarrow \mathbb{Z} \left[\frac{1}{2} \right] \longrightarrow 0$$

is an exact sequence of \mathbb{Z} -modules. Since $\mathbb{Z} \left[\frac{1}{2} \right] = \mathbb{Z}_{\{2\}}$ (localized in $\{2\}$), $\mathbb{Z} \left[\frac{1}{2} \right]$ will be \mathbb{Z} -flat. Take the tensor product of (16.6) with $\mathbb{Z} \left[\frac{1}{2} \right]$ over \mathbb{Z} to obtain

$$(16.7) \quad 0 \longrightarrow \mathbb{Z} \left[\frac{1}{2} \right] \longrightarrow M \otimes_{\mathbb{Z}} \mathbb{Z} \left[\frac{1}{2} \right] \longrightarrow \mathbb{Z} \left[\frac{1}{2} \right] \longrightarrow 0,$$

which has to be isomorphic to (16.6). But (16.7) splits by the initial remark.) Thus the three vectors in subgroup 1 define isomorphic algebras.

This can also be seen much more directly as follows: It follows directly from Corollary 11.6 that $G = \mathbb{Z} \left[\frac{1}{2} \right]^4$ for these three specimens (d,g,h) and the Perron-Frobenius eigenvalue $\lambda = 2$ in all three cases, so it follows from (5.17) and (5.34) that the three specimens are isomorphic.

Subgroup 2

$$(b): \begin{pmatrix} 1 \\ 0 \\ 2 \\ 4 \end{pmatrix}, \quad (c): \begin{pmatrix} 1 \\ 0 \\ 0 \\ 8 \end{pmatrix}.$$

TABLE 4. The specimens in Group 2 for Rank 4.

Group 2	Specimen	$p_0(x)$	$G_0 \otimes_{\mathbb{Z}} \mathbb{Z}_2$
(a)	$\begin{pmatrix} 1 \\ 1 \\ 0 \\ 4 \end{pmatrix}$	$1 + x + x^2 + 2x^3$	\mathbb{Z}_2^2
(b)	$\begin{pmatrix} 1 \\ 0 \\ 2 \\ 4 \end{pmatrix}$	$1 + x + 2x^2 + 2x^3$ $= (1 + x)(1 + 2x^3)$	\mathbb{Z}_2
(c)	$\begin{pmatrix} 1 \\ 0 \\ 0 \\ 8 \end{pmatrix}$	$1 + x + 2x^2 + 4x^3$	\mathbb{Z}_2
(d)	$\begin{pmatrix} 0 \\ 2 \\ 2 \\ 4 \end{pmatrix}$	$1 + 2x + 2x^2 + 2x^3$	0
(e)	$\begin{pmatrix} 0 \\ 1 \\ 4 \\ 4 \end{pmatrix}$	$1 + 2x + 3x^2 + 2x^3$ $= (1 + x)(1 + x + 2x^2)$	\mathbb{Z}_2^2
(f)	$\begin{pmatrix} 0 \\ 1 \\ 2 \\ 8 \end{pmatrix}$	$1 + 2x + 3x^2 + 4x^3$	\mathbb{Z}_2^2
(g)	$\begin{pmatrix} 0 \\ 0 \\ 6 \\ 4 \end{pmatrix}$	$1 + 2x + 4x^2 + 2x^3$	0
(h)	$\begin{pmatrix} 0 \\ 0 \\ 4 \\ 8 \end{pmatrix}$	$1 + 2x + 4x^2 + 4x^3$	0

In specimen (b), $p_0(x) = (1+x)(1+2x^2)$ so $\ker \tau$ is given by an extension

$$0 \longrightarrow \mathbb{Z} \left[\frac{1}{2} \right]^2 \longrightarrow \ker \tau \longrightarrow \mathbb{Z} \longrightarrow 0$$

(the right morphism is evaluation of the polynomial at -1 , where $p_0(-1) = 0$). By \mathbb{Z} being a free \mathbb{Z} -module, this extension automatically splits. In specimen (c), $p_0(x) = 1 + x + 2x^2 + 4x^3$ is irreducible, and we have an exact sequence

$$0 \longrightarrow \mathbb{Z} \longrightarrow \ker \tau \longrightarrow \mathbb{Z} \left[\frac{1}{2} \right]^2 \longrightarrow 0.$$

We will show that these specimens are non-isomorphic by using Corollary 11.22. Let J correspond to specimen (b) and J' to specimen (c). By Proposition 11.25 we have

$$\{h \in F' \mid 8h = 0\} = F'_3$$

and hence (11.84) is fulfilled:

$$\{g \in G' \mid 2^3 g \in \mathbb{Z}^N\} = G'_3.$$

One now computes $\langle \alpha \mid v \rangle = \frac{9}{4}$ and $\langle \alpha' \mid v' \rangle = \frac{5}{2}$, so

$$\frac{\langle \alpha \mid v \rangle}{\langle \alpha' \mid v' \rangle} = \frac{9}{10} \notin \mathbb{Z} \left[\frac{1}{2} \right].$$

It follows from Corollary 11.22 that there does not exist a unital morphism $\mathfrak{A}_J \rightarrow \mathfrak{A}_{J'}$, and in particular specimens (b) and (c) are non-isomorphic.

Subgroup 3

$$(a): \begin{pmatrix} 1 \\ 1 \\ 0 \\ 4 \end{pmatrix}, \quad (e): \begin{pmatrix} 0 \\ 1 \\ 4 \\ 4 \end{pmatrix}, \quad (f): \begin{pmatrix} 0 \\ 1 \\ 2 \\ 8 \end{pmatrix}.$$

Specimen (e) has the reducible polynomial

$$p_0(x) = 2x^3 + 3x^2 + 2x + 1 = (x+1)(2x^2 + x + 1)$$

so there is an exact diagram

$$(16.8) \quad \begin{array}{ccccccc} & & & 0 & & & \\ & & & \downarrow & & & \\ 0 & \longrightarrow & \mathbb{Z} & \longrightarrow & E & \longrightarrow & \mathbb{Z} \left[\frac{1}{2} \right] \longrightarrow 0. \\ & & & & \downarrow & & \\ & & & & \ker \tau & & \\ & & & & \downarrow & & \\ & & & & \mathbb{Z} & & \\ & & & & \downarrow & & \\ & & & & 0 & & \end{array}$$

The horizontal sequence is described in detail in the end of Example 18.1. The vertical sequence necessarily splits since \mathbb{Z} is free, i.e.,

$$G_0 = \ker \tau \cong \mathbb{Z} \oplus E.$$

Since $p_0(1) = 0$, evaluation at -1 gives a homomorphism $\ker(\tau) \rightarrow \mathbb{Z}$, which is the lower vertical map in the diagram. Specimens (a) and (f) have irreducible p_0 -polynomials, so there are no homomorphisms $G \rightarrow \mathbb{Z}$, and therefore these are non-isomorphic to specimen (e). But specimens (a) and (f) are mutually non-isomorphic by Example 11.26. Hence all three specimens (a,e,f) are mutually non-isomorphic.

Note also that for (e), it follows from Proposition 11.25 that $\{h \in F^{(e)} \mid 4h = 0\} = F_2^{(e)}$ and hence

$$\{g \in F^{(e)} \mid 4g = 0\} = G_2^{(e)}.$$

For this specimen we have

$$\langle \alpha^{(e)} \mid v^{(e)} \rangle = \left(1 \quad \frac{1}{2} \quad \frac{1}{4} \quad \frac{1}{8}\right) \begin{pmatrix} 1 \\ 2 \\ 3 \\ 2 \end{pmatrix} = 3$$

and since

$$\langle \alpha^{(a)} \mid v^{(a)} \rangle = 2 \quad \text{and} \quad \langle \alpha^{(f)} \mid v^{(f)} \rangle = \frac{13}{4},$$

it follows also directly from Corollary 11.22 and Remark 11.23 that these specimens all are non-isomorphic.

In **Group 3**, there are 4 specimens. We compute the polynomial $p_0(x) = p_L(x) / (2x - 1)$ for these, and use the result to compute $G_0 \otimes \mathbb{Z}_3$, where $G_0 = \ker \tau = \mathbb{Z}[x] / (p_0(x) \mathbb{Z}[x])$, using (8.26) in Corollary 8.9.

Group 3	Specimen	$p_0(x)$	$G_0 \otimes \mathbb{Z}_3$
(a)	$\begin{pmatrix} 1 \\ 0 \\ 1 \\ 6 \end{pmatrix}$	$1 + x + 2x^2 + 3x^3$	\mathbb{Z}_3^2
(b)	$\begin{pmatrix} 0 \\ 2 \\ 1 \\ 6 \end{pmatrix}$	$1 + 2x + 2x^2 + 3x^3$	\mathbb{Z}_3^2
(c)	$\begin{pmatrix} 0 \\ 1 \\ 3 \\ 6 \end{pmatrix}$	$1 + 2x + 3x^2 + 3x^3$	\mathbb{Z}_3
(d)	$\begin{pmatrix} 0 \\ 0 \\ 5 \\ 6 \end{pmatrix}$	$1 + 2x + 4x^2 + 3x^3$ $= (1 + x)(1 + x + 3x^2)$	\mathbb{Z}_3^2

Thus we see immediately that specimen (c) is non-isomorphic to the three others. Also, we see that specimen (d) permits a homomorphism from $\ker \tau$ into \mathbb{Z} , but not the two others, so it remains to consider the pair (a,b). But for both these specimens we have $m_4 = 6$ and $m_3 = 1$, so applying Proposition 11.25 we have

$$\{h \in F \mid 6h = 0\} = F_1$$

for both. But this means that $6\text{-deg } J = \text{deg } J = 1$ for both. But $\langle \alpha^{(a)} \mid v^{(a)} \rangle = \frac{19}{8}$ and $\langle \alpha^{(b)} \mid v^{(b)} \rangle = \frac{23}{8}$, and hence Theorem 11.10 implies that there cannot be a unital homomorphism from either of these specimens into the other. It follows that the four specimens in this group are mutually non-isomorphic.

Groups 4 and 6 have only one specimen each, so the basic invariants $\text{Prim}(m_4)$ and $\text{Prim}(m_4/2)$ suffice to separate this group from the others.

In **Group 5** there are two specimens,

$$(a): \begin{pmatrix} 0 \\ 1 \\ 1 \\ 10 \end{pmatrix}, \quad (b): \begin{pmatrix} 0 \\ 0 \\ 3 \\ 10 \end{pmatrix}.$$

For both of these $m_4 = 10$ and $m_3 \neq 0$ and m_3 is mutually prime with m_4 . Thus Proposition 11.25 implies that

$$10\text{-deg } J = \text{deg } J = 1$$

for both these specimens. But in this case $\langle \alpha^{(a)} | v^{(a)} \rangle = \frac{27}{8}$ and $\langle \alpha^{(b)} | v^{(b)} \rangle = \frac{29}{8}$, and it follows from Theorem 11.10 that there are no unital homomorphisms from one of these two into the other.

In summary, all the 22 permitted specimens in (16.5) are mutually non-isomorphic except for one group of 3 isomorphic specimens, namely the ones in Subgroup 1 of Group 2:

$$(16.9) \quad \begin{pmatrix} 0 \\ 2 \\ 2 \\ 4 \end{pmatrix}, \begin{pmatrix} 0 \\ 0 \\ 6 \\ 4 \end{pmatrix}, \begin{pmatrix} 0 \\ 0 \\ 4 \\ 8 \end{pmatrix}.$$

These specimens are illustrated in Figure 19.

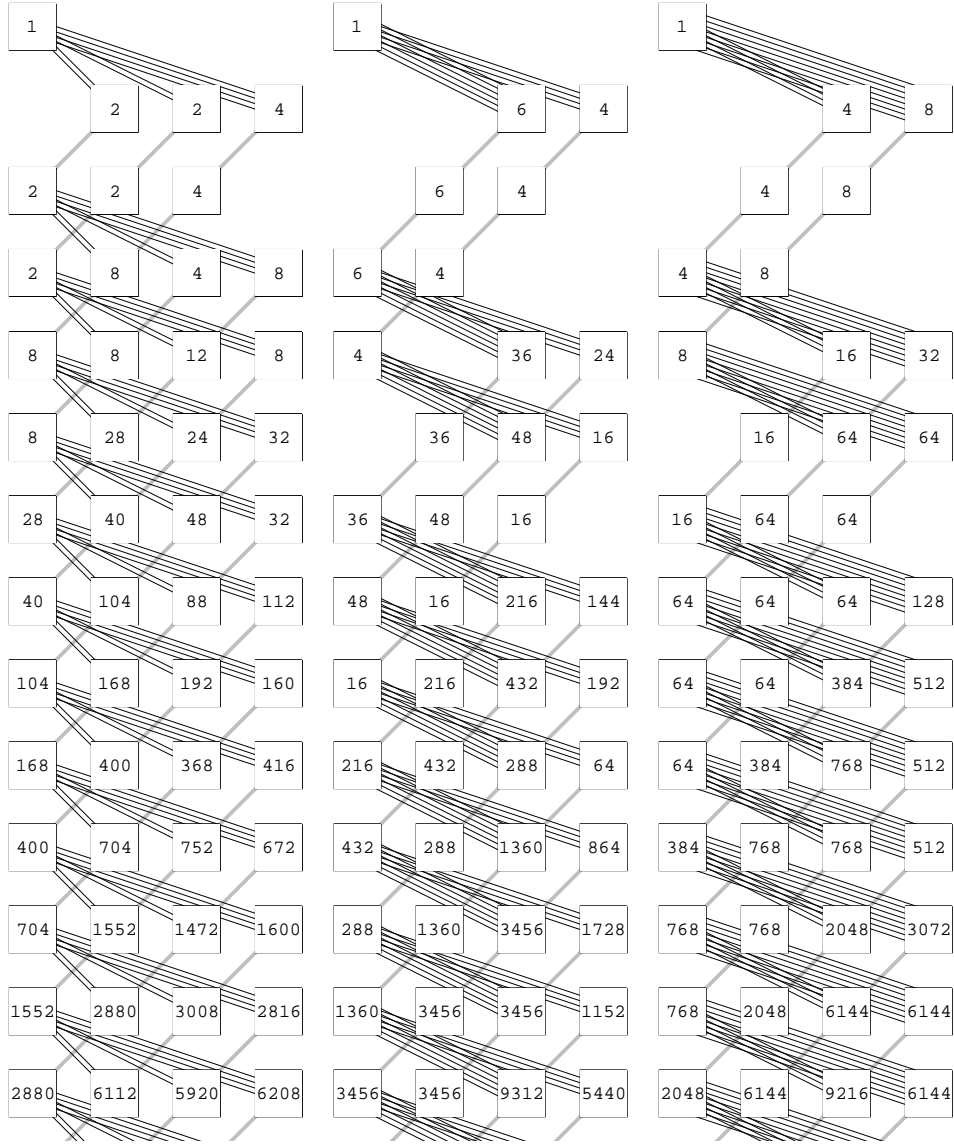

FIGURE 19. $L = \{2, 2, 3, 3, 4, 4, 4, 4\}$; first column = $(0 \ 2 \ 2 \ 4)^t$ (left); $L = \{3, 3, 3, 3, 3, 3, 4, 4, 4, 4\}$; first column = $(0 \ 0 \ 6 \ 4)^t$ (center); $L = \{3, 3, 3, 3, 4, 4, 4, 4, 4, 4, 4\}$; first column = $(0 \ 0 \ 4 \ 8)^t$ (right): The three isomorphic algebras in the final summary of Chapter 16 (see (16.9)).

Complete classification in the case $\lambda = m_N$

We will now continue the study of the case $\lambda = m_N$ begun in Corollary 11.13, Lemma 11.14 and Proposition 11.16. We will introduce a new invariant $I(J)$ in (17.12) and Corollary 17.6 below. In the case $N = 1$, the invariant always has the value 1 (Section 1), but in the case $N = 2$, the invariant separates all specimens in this class, so they are all non-isomorphic (Section 2). More interestingly, in the case $N = 3$, the pair $(\text{Prim } \lambda, I(J))$ turns out to be a *complete* invariant (Theorem 17.14), and this can be used to exhibit nontrivial pairs of 3×3 matrices in this class giving isomorphic algebras. It is curious that for $N = 3$, the equality $I(J) = I(J')$ forces λ to be unequal to λ' (unless $J = J'$; Proposition 17.13). For $N = 4$ we do exhibit an isomorphic pair with $\lambda = \lambda'$, and we present a proof of K.H. Kim and F. Roush that $(N, \text{Prim } \lambda, I(J))$ is a complete invariant in general for the class $\lambda = m_N$ (Theorem 17.18). In this class, it also turns out that $(N, \text{Prim } \lambda, I(J))$ is a complete invariant for *stable* isomorphism (see Corollary 17.21).

Lemma 17.1. *Let J be a matrix of the form (11.2), and assume that the Perron–Frobenius eigenvalue λ of J is equal to m_N . It follows that*

$$(17.1) \quad G := \bigcup_n J^{-n} \mathbb{Z}^N = \mathbb{Z}^N + \mathbb{Z} \left[\frac{1}{\lambda} \right] \mathbf{v},$$

where \mathbf{v} is the right Perron–Frobenius eigenvector given by (14.5).

Proof. Clearly $\mathbb{Z}^N \subseteq G$ and $\mathbf{v} \in \mathbb{Z}^N$, so $J^{-n} \mathbf{v} = \lambda^{-n} \mathbf{v} \in G$, and hence

$$(17.2) \quad \mathbb{Z}^N + \mathbb{Z} \left[\frac{1}{\lambda} \right] \mathbf{v} \subseteq G.$$

Since G is the smallest J^{-1} -invariant subgroup of \mathbb{Q}^N , in order to show the converse inclusion it suffices to show that

$$(17.3) \quad J^{-1} (\mathbb{Z}^N + \mathbb{Z} \left[\frac{1}{\lambda} \right] \mathbf{v}) \subseteq \mathbb{Z}^N + \mathbb{Z} \left[\frac{1}{\lambda} \right] \mathbf{v}.$$

But as $J^{-1} \mathbf{v} = \frac{1}{\lambda} \mathbf{v}$, it suffices to show that

$$(17.4) \quad J^{-1} \mathbb{Z}^N \subseteq \mathbb{Z}^N + \mathbb{Z} \left[\frac{1}{\lambda} \right] \mathbf{v}.$$

Then it suffices to show that the right column vector in J^{-1} in (5.49) is in $\mathbb{Z}^N + \mathbb{Z} \left[\frac{1}{\lambda} \right] \mathbf{v}$. But using $m_N = \lambda$ and (14.5) we see that this column vector has the form $\lambda^{-1} \mathbf{v} + \mathbf{m}$, where $\mathbf{m} \in \mathbb{Z}^N$. This proves (17.4) and thus Lemma 17.1 is proved. \square

Lemma 17.2. *Let J be a matrix of the form (11.2), and assume that $\lambda = m_N$. Let \mathbf{v} be the right Perron–Frobenius eigenvector of J normalized as in (14.5). It*

follows that \mathbf{v} has the form

$$(17.5) \quad \mathbf{v} = \begin{pmatrix} 1 \\ v_2 \\ \vdots \\ v_{N-1} \\ 1 \end{pmatrix}$$

where

$$(17.6) \quad v_{i+1} = \lambda v_i - m_i$$

for $i = 1, 2, \dots, N-1$.

Proof. This is an immediate consequence of (11.40) and (11.41) in the proof of Lemma 11.14. \square

Lemma 17.3. *Let J , $\lambda = m_N$, \mathbf{v} be as in Lemma 17.2 and define the $(N-1) \times N$ matrix $M_{\mathbf{v}}$ by*

$$(17.7) \quad M_{\mathbf{v}} = \begin{pmatrix} v_2 & -1 & 0 & \cdots & 0 & 0 \\ v_3 & 0 & -1 & & 0 & 0 \\ \vdots & \vdots & & \ddots & & \vdots \\ v_{N-1} & 0 & 0 & & -1 & 0 \\ 1 & 0 & 0 & \cdots & 0 & -1 \end{pmatrix}.$$

Then

$$(17.8) \quad G := \bigcup_n J^{-n} \mathbb{Z}^N = \left\{ x \in \mathbb{Z} \left[\frac{1}{\lambda} \right]^N \mid M_{\mathbf{v}} x \in \mathbb{Z}^{N-1} \right\}.$$

Proof. Let $\mathbf{v}^\perp = \{ \mathbf{y} \in \mathbb{Z}^N \mid \langle \mathbf{y} \mid \mathbf{v} \rangle = 0 \}$. We will also prove that

$$(17.9) \quad G = \left\{ \mathbf{x} \in \mathbb{Z} \left[\frac{1}{\lambda} \right]^N \mid \forall \mathbf{y} \in \mathbf{v}^\perp: \langle \mathbf{y} \mid \mathbf{x} \rangle \in \mathbb{Z} \right\}$$

by establishing the following relations between the right-hand sets of (17.1), (17.8) and (17.9):

$$(17.1)_{\mathbb{R}} \subseteq (17.9)_{\mathbb{R}} \subseteq (17.8)_{\mathbb{R}} \subseteq (17.1)_{\mathbb{R}}.$$

The first inclusion to the left is immediate, and since the vectors

$$(v_2, -1, 0, \dots, 0), (v_3, 0, -1, 0, \dots, 0), \dots, (1, 0, \dots, 0, -1)$$

are all in \mathbf{v}^\perp by (17.5), the second inclusion follows. But if $\mathbf{x} \in (17.8)_{\mathbb{R}}$, then

$$\begin{aligned} x_1 &\in \mathbb{Z} \left[\frac{1}{\lambda} \right] \\ x_2 &= v_2 x_1 + m_2 \\ x_3 &= v_3 x_1 + m_3 \\ &\vdots \\ &\vdots \\ x_{N-1} &= v_{N-1} x_1 + m_{N-1} \\ x_N &= x_1 + m_N = v_N x_1 + m_N \end{aligned}$$

where $m_2, \dots, m_N \in \mathbb{Z}$, and hence $\mathbf{x} = \mathbf{m} + x_1 \mathbf{v} \in (17.1)_{\mathbb{R}}$. \square

Lemma 17.4. *Let J, J' be as in Lemma 17.2, and assume that there is an isomorphism $\theta: G \rightarrow G'$ (and thus $N = N', \text{Prim}(\lambda) = \text{Prim}(\lambda')$). Let $\Lambda \in \text{GL}(N, \mathbb{Z}[\frac{1}{\lambda}])$ be the matrix in Proposition 11.7 implementing the isomorphism. It follows that*

$$(17.10) \quad \Lambda \mathbf{v} = \xi \mathbf{v}'$$

where ξ is an element of $\mathbb{Z}[\frac{1}{\lambda}]$ with multiplicative inverse (i.e., ξ is a product of powers of the primes in $\text{Prim}(\lambda)$).

Proof. By Lemma 17.1 we have

$$\begin{aligned} G &= \mathbb{Z}^N + \mathbb{Z}[\frac{1}{\lambda}] \mathbf{v}, \\ G' &= \mathbb{Z}^N + \mathbb{Z}[\frac{1}{\lambda}] \mathbf{v}', \end{aligned}$$

so

$$D_\lambda(G) = \mathbb{Z}[\frac{1}{\lambda}] \mathbf{v},$$

and

$$D_\lambda(G') = \mathbb{Z}[\frac{1}{\lambda}] \mathbf{v}'$$

(see (11.57) for the definition of D_λ). But θ must map $D_\lambda(G)$ onto $D_\lambda(G')$, from which the assertion follows. \square

Note that Lemma 17.4 immediately gives a strengthening of Corollary 11.13. But we will do better: see Lemma 17.9.

Corollary 17.5. *Let J, J' be matrices of the form (11.2) with $m_N = \lambda$ and $m_{N'} = \lambda'$. If there is a unital isomorphism $\mathfrak{A}_J \rightarrow \mathfrak{A}_{J'}$, then $N = N', \text{Prim}(\lambda) = \text{Prim}(\lambda') = \{p_1, \dots, p_n\}$, and there are integers m_1, \dots, m_n such that*

$$(17.11) \quad \frac{\langle \alpha | \mathbf{v} \rangle}{\langle \alpha' | \mathbf{v}' \rangle} = p_1^{m_1} p_2^{m_2} \cdots p_n^{m_n}.$$

Proof. We have $N = N'$ and $\text{Prim}(m_N) = \text{Prim}(m_{N'})$ by Theorem 7.8. From (17.10) and Proposition 11.7, it follows that

$$\langle \alpha | \mathbf{v} \rangle = \langle \alpha' | \Lambda \mathbf{v} \rangle = \langle \alpha' | \xi \mathbf{v}' \rangle = \xi \langle \alpha' | \mathbf{v}' \rangle.$$

\square

We will now give a useful alternative form of Corollary 17.5 by means of the number

$$(17.12) \quad I(J) = \sum_{i=1}^N v_i \lambda^{N-i} = \lambda^{N-1} + v_2 \lambda^{N-2} + \cdots + v_{N-1} \lambda + 1,$$

where $v_1 = 1, v_2, \dots, v_{N-1}, v_N = 1$ are the components of the right Perron-Frobenius eigenvector in Lemma 17.2. The next corollary says that $I(J)$ is an invariant in the context $\lambda = m_N$.

Corollary 17.6. *Let J, J' be matrices of the form (11.2) with $m_N = \lambda$ and $m_{N'} = \lambda'$. If \mathfrak{A}_J is isomorphic to $\mathfrak{A}_{J'}$ then*

$$(17.13) \quad I(J) = I(J').$$

Proof. Using Lemma 7.2 and (17.5) we have

$$\begin{aligned}\langle \alpha | \mathbf{v} \rangle &= 1 + v_2 \frac{1}{\lambda} + \cdots + v_{N-1} \frac{1}{\lambda^{N-2}} + \frac{1}{\lambda^{N-1}} \\ &= \frac{1}{\lambda^{N-1}} (\lambda^{N-1} + v_2 \lambda^{N-2} + \cdots + v_{N-1} \lambda + 1),\end{aligned}$$

and a similar expression is valid for $\langle \alpha' | \mathbf{v}' \rangle$. Combining this with (17.11) we find an element $\xi' \in \mathbb{Z} \left[\frac{1}{\lambda} \right]$ with a multiplicative inverse such that

$$\xi' (\lambda^{N-1} + v_2 \lambda^{N-2} + \cdots + v_{N-1} \lambda + 1) = (\lambda'^{N-1} + v'_2 \lambda'^{N-2} + \cdots + v'_{N-1} \lambda' + 1).$$

Now, we may find two disjoint subsets of $\{p_1, \dots, p_n\}$, say P_+ and P_- , such that

$$\xi' = \prod_{p \in P_+} p^{n(p)} \prod_{q \in P_-} q^{-n(q)},$$

where $n(p) \in \mathbb{N}$, $n(q) \in \mathbb{N}$. The relation above may be written

$$\begin{aligned}\prod_{p \in P_+} p^{n(p)} (\lambda^{N-1} + v_2 \lambda^{N-2} + \cdots + v_{N-1} \lambda + 1) \\ = \prod_{q \in P_-} q^{n(q)} (\lambda'^{N-1} + v'_2 \lambda'^{N-2} + \cdots + v'_{N-1} \lambda' + 1).\end{aligned}$$

Since the primes p_1, \dots, p_n are all distinct, and all of them are factors of both λ and λ' , and thus none of them are factors of the polynomials $(\cdots + 1)$ above, it follows that $P_+ = P_- = \emptyset$. Thus $\xi' = 1$. But this means

$$\lambda^{N-1} \langle \alpha | \mathbf{v} \rangle = \lambda'^{N-1} \langle \alpha' | \mathbf{v}' \rangle$$

and

$$\begin{aligned}(17.14) \quad I(J) &= \lambda^{N-1} + v_2 \lambda^{N-2} + \cdots + v_{N-1} \lambda + 1 \\ &= \lambda'^{N-1} + v'_2 \lambda'^{N-2} + \cdots + v'_{N-1} \lambda' + 1 \\ &= I(J').\end{aligned} \quad \square$$

Under some circumstances, Corollary 17.6 can be used to give more amenable conditions for isomorphism.

Corollary 17.7. *Let J, J' be matrices of the form (11.2) with $m_N = \lambda$ and $m'_{N'} = \lambda'$.*

If there is a unital isomorphism $\mathfrak{A}_J \rightarrow \mathfrak{A}_{J'}$ and $\lambda = \lambda'$, then

$$(17.15) \quad \langle \alpha | \mathbf{v} \rangle = \langle \alpha' | \mathbf{v}' \rangle.$$

If there is a unital isomorphism $\mathfrak{A}_J \rightarrow \mathfrak{A}_{J'}$ and λ' is an integer multiple of λ , then

$$(17.16) \quad \lambda = \lambda'.$$

Proof. The first statement follows from the formula

$$\langle \alpha | \mathbf{v} \rangle = \lambda^{-(N-1)} I(J)$$

in the beginning of the proof of Corollary 17.6, as well as from the corollary itself, and the fact that N is an isomorphism invariant (Theorem 7.8).

For the second statement, note that (17.13) implies

$$(17.17) \quad v_2 \lambda^{N-2} + \cdots + v_{N-1} \lambda = \lambda'^{N-1} - \lambda^{N-1} + (v'_2 \lambda'^{N-2} + \cdots + v'_{N-1} \lambda'),$$

and the expression in parentheses is positive. We have assumed that λ' is an integer multiple of λ , and if this multiple is > 1 we will show the contradiction

$$(17.18) \quad v_2\lambda^{N-2} + \cdots + v_{N-1}\lambda < \lambda'^{N-1} - \lambda^{N-1}.$$

This will prove the lemma. Since

$$(17.19) \quad v_2\lambda^{N-2} + \cdots + v_{N-1}\lambda \leq \lambda\lambda^{N-2} + \lambda^2\lambda^{N-3} + \cdots + \lambda^{N-2}\lambda \\ = (N-2)\lambda^{N-1}$$

by (14.5), (17.18) will follow if we can show that

$$(N-1)\lambda^{N-1} \leq \lambda'^{N-1} - \lambda^{N-1}$$

or

$$(N-1) < (\lambda'/\lambda)^{N-1}.$$

But as λ' is an integer multiple of λ , this says

$$(N-1) < 2^{N-1},$$

which is obvious when $N > 1$. \square

Lemma 17.8. *Adopt the assumptions and notation in Lemma 17.1. Then G has a direct sum decomposition*

$$(17.20) \quad G = \mathbb{Z}^{N-1} \oplus \mathbb{Z} \left[\frac{1}{\lambda} \right] \mathbf{v},$$

where \mathbb{Z}^{N-1} identifies with the elements of \mathbb{Z}^N with zero first coordinate. If $\alpha = (1, \frac{1}{\lambda}, \dots, \frac{1}{\lambda^{N-1}})$ and $\beta = (\frac{1}{\lambda}, \frac{1}{\lambda^2}, \dots, \frac{1}{\lambda^{N-1}})$, an element $\mathbf{x} \oplus \xi\mathbf{v}$ of G is positive if and only if $\langle \beta | \mathbf{x} \rangle + \xi \langle \alpha | \mathbf{v} \rangle > 0$.

Proof. Put $H = \mathbb{Z}^{N-1} \oplus \mathbb{Z} \left[\frac{1}{\lambda} \right] \mathbf{v}$. Since $v_1 = 1$, this sum is really direct, and it follows from (17.1) that $H \subseteq G$. Conversely, if $\mathbf{y} + \xi\mathbf{v} \in G$, define $\xi' = \xi + y_1 \in \mathbb{Z} \left[\frac{1}{\lambda} \right]$ and write $\mathbf{y} + \xi\mathbf{v} = (\mathbf{y} - y_1\mathbf{v}) + \xi'\mathbf{v}$. But $\mathbf{y} - y_1\mathbf{v} \in \mathbb{Z}^{N-1}$ since $v_1 = 1$, and hence $\mathbf{y} + \xi\mathbf{v} = (\mathbf{y} - y_1\mathbf{v}) + \xi'\mathbf{v} \in \mathbb{Z}^{N-1} + \mathbb{Z} \left[\frac{1}{\lambda} \right] \mathbf{v}$. Thus $G \subseteq H$ and $G = H$. Since $\mathbf{x} \in G$ is positive if and only if $\langle \alpha | \mathbf{x} \rangle > 0$ the last statement is clear. \square

Lemma 17.9. *Let J, J' be matrices of the form (11.2) with $\lambda = m_N$ and $\lambda' = m'_{N'}$, $\text{Prim}(\lambda) = \text{Prim}(\lambda')$, $N = N'$, and $I(J) = I(J')$, so that*

$$(17.21) \quad G = \mathbb{Z}^N + \mathbb{Z} \left[\frac{1}{\lambda} \right] \mathbf{v} = \mathbb{Z}^{N-1} \oplus \mathbb{Z} \left[\frac{1}{\lambda} \right] \mathbf{v}, \\ G' = \mathbb{Z}^N + \mathbb{Z} \left[\frac{1}{\lambda} \right] \mathbf{v}' = \mathbb{Z}^{N-1} \oplus \mathbb{Z} \left[\frac{1}{\lambda} \right] \mathbf{v}'$$

by Lemma 17.1 and Lemma 17.8. Then any unital order isomorphism $\theta: G \rightarrow G'$ has the form

$$(17.22) \quad \theta(\mathbf{x}, \xi\mathbf{v}) = \left(A\mathbf{x}, \left(\eta(\mathbf{x}) + \xi\lambda'^{N-1}\lambda^{-(N-1)} \right) \mathbf{v}' \right)$$

relative to the right decompositions, where

$$(17.23) \quad A \in \text{GL}(N-1, \mathbb{Z}),$$

$$(17.24) \quad \eta \in \text{Hom}(\mathbb{Z}^{N-1}, \mathbb{Z} \left[\frac{1}{\lambda} \right]),$$

$$(17.25) \quad \langle \beta | \mathbf{x} \rangle = \langle \beta' | A\mathbf{x} \rangle + \eta(\mathbf{x}) \langle \alpha' | \mathbf{v}' \rangle,$$

$$(17.26) \quad A\bar{\mathbf{v}} = \bar{\mathbf{v}}' \quad \text{and} \quad \eta(\bar{\mathbf{v}}) = \lambda'^{N-1}\lambda^{-(N-1)} - 1$$

where

$$(17.27) \quad \bar{\mathbf{v}} = \begin{pmatrix} v_2 \\ \vdots \\ v_{N-1} \\ 1 \end{pmatrix} \quad \text{and} \quad \bar{\mathbf{v}}' = \begin{pmatrix} v'_2 \\ \vdots \\ v'_{N-1} \\ 1 \end{pmatrix}.$$

Conversely, if (A, η) satisfies (17.23)–(17.26), then (17.22) defines a unital order isomorphism $G \rightarrow G'$.

Proof. Let $\Lambda \in \text{GL}(N, \mathbb{Z}[\frac{1}{\lambda}])$ be the matrix in Proposition 11.7 implementing the isomorphism. By Lemma 17.4, $\Lambda \mathbf{v} = \xi \mathbf{v}'$, and by the proof of Corollary 17.5,

$$\xi = \frac{\langle \alpha | \mathbf{v} \rangle}{\langle \alpha' | \mathbf{v}' \rangle} = \frac{\lambda^{-(N-1)} I(J)}{\lambda'^{-(N-1)} I(J')} = \lambda'^{N-1} \lambda^{-(N-1)},$$

and thus

$$(17.28) \quad \Lambda \mathbf{v} = \lambda'^{N-1} \lambda^{-(N-1)} \mathbf{v}'.$$

This shows that

$$\theta(\xi \mathbf{v}) = \xi \lambda'^{N-1} \lambda^{-(N-1)} \mathbf{v}'$$

for all $\xi \in \mathbb{Z}[\frac{1}{\lambda}]$. Furthermore we must have

$$(17.29) \quad \theta|_{\mathbb{Z}^{N-1}} = A \oplus \eta(\cdot) \mathbf{v}',$$

where $A \in M_{N-1}(\mathbb{Z})$ and $\eta \in \text{Hom}(\mathbb{Z}^{N-1}, \mathbb{Z}[\frac{1}{\lambda}])$. Now, (17.22) follows from (17.28) and (17.29). For θ to be onto, A must be surjective and hence $A \in \text{GL}(N, \mathbb{Z})$. The condition (11.14)(2) in Proposition 11.7 is equivalent to

$$\langle \beta | \mathbf{x} \rangle + \xi \langle \alpha | \mathbf{v} \rangle = \langle \beta' | A \mathbf{x} \rangle + \langle \alpha' | \eta(\mathbf{x}) \mathbf{v}' \rangle + \xi \lambda'^{N-1} \lambda^{-(N-1)} \langle \alpha' | \mathbf{v}' \rangle$$

for all $\mathbf{x} \oplus \xi \mathbf{v} \in \mathbb{Z}^{N-1} \oplus \mathbb{Z}[\frac{1}{\lambda}] \mathbf{v}$ and since $\lambda^{N-1} \langle \alpha | \mathbf{v} \rangle = I(J) = I(J') = \lambda'^{N-1} \langle \alpha' | \mathbf{v}' \rangle$, this is (17.25). Finally noting that

$$\begin{pmatrix} 1 \\ 0 \\ \vdots \\ 0 \end{pmatrix} = \mathbf{v} - \mathbf{v}',$$

(17.26) is a transcription of (11.14)(5):

$$\begin{aligned} \Lambda \mathbf{v} - \Lambda \bar{\mathbf{v}} &= \lambda'^{N-1} \lambda^{-(N-1)} \mathbf{v}' - (A \bar{\mathbf{v}}, \eta(\bar{\mathbf{v}}) \mathbf{v}') \\ &= \left(-A \bar{\mathbf{v}}, \left(-\eta(\bar{\mathbf{v}}) + \lambda'^{N-1} \lambda^{-(N-1)} \mathbf{v}' \right) \right). \end{aligned}$$

But since $\Lambda \begin{pmatrix} 1 \\ 0 \\ \vdots \\ 0 \end{pmatrix} = \begin{pmatrix} 1 \\ 0 \\ \vdots \\ 0 \end{pmatrix}$, this is equal to

$$\mathbf{v}' - \bar{\mathbf{v}}' = (-\bar{\mathbf{v}}', \mathbf{v}'),$$

which is equivalent to (17.26).

For the converse statement, one has to verify that if θ is defined by (17.22), then θ satisfies the conditions in Proposition 11.7, but this follows by the same computations as above. (Note that as $\theta(G) = G'$, the conditions (3) and (4) in Proposition 11.7 are automatic. To show $\theta(G) = G'$, note first that $\theta(\mathbb{Z}[\frac{1}{\lambda}] \mathbf{v}) = \mathbb{Z}[\frac{1}{\lambda}] \mathbf{v}'$, and next, since A is onto, there is for any $\mathbf{m} \in \mathbb{Z}^{N-1}$ an $\mathbf{n} \in \mathbb{Z}^{N-1}$ with

$A\mathbf{n} = \mathbf{m}$, but then $\theta(\mathbf{n} \oplus (-\eta(\mathbf{m})\mathbf{v})) = A\mathbf{v} \oplus 0 = \mathbf{m} \oplus 0$, thus θ is surjective. It is clearly injective.) \square

Note that Lemma 17.9 hints at a method of constructing unital order isomorphisms (A, η) . First find an $A \in \text{GL}(N-1, \mathbb{Z})$ satisfying $A\bar{\mathbf{v}} = \bar{\mathbf{v}}'$, and then solve (17.25) for $\eta(\mathbf{x})$. However, one then has to check (17.24) and the remaining condition in (17.26), and these conditions are very restrictive. This is illustrated by the following lemma.

Lemma 17.10. *Adopt the notation and general assumptions in Lemma 17.9. If (A, η) is a solution of the conditions (17.23)–(17.26), then*

$$(17.30) \quad \eta(\mathbb{Z}^{N-1}) \subseteq \left(\frac{\gcd(\lambda, \lambda')}{\lambda} \right)^{N-1} \mathbb{Z},$$

and thus one may without loss of generality replace (17.24) by

$$(17.31) \quad \eta \in \text{Hom} \left(\mathbb{Z}^{N-1}, \left(\frac{\gcd(\lambda, \lambda')}{\lambda} \right)^{N-1} \mathbb{Z} \right).$$

In particular, if $\lambda = \lambda'$, then

$$(17.32) \quad \eta \in \text{Hom}(\mathbb{Z}^{N-1}, \mathbb{Z}).$$

Proof. Note first that by the beginning of the proof of Lemma 17.7, $\langle \alpha' | \mathbf{v}' \rangle$ has the form

$$(17.33) \quad \langle \alpha' | \mathbf{v}' \rangle = \frac{(a\lambda + 1)}{\lambda'^{N-1}} = \frac{I(J')}{\lambda'^{N-1}},$$

where a is a positive integer. But it follows from (17.25) that

$$\begin{aligned} \eta(\mathbf{x}) &= \frac{(\langle \beta | \mathbf{x} \rangle - \langle \beta' | A\mathbf{x} \rangle)}{\langle \alpha' | \mathbf{v}' \rangle} \\ &= \frac{\lambda'^{N-1} (\langle \beta | \mathbf{x} \rangle - \langle \beta' | A\mathbf{x} \rangle)}{I(J')} \\ &\subseteq \frac{\lambda'^{N-1} \left(\frac{1}{\lambda^{N-1}} \mathbb{Z} + \frac{1}{\lambda'^{N-1}} \mathbb{Z} \right)}{I(J')} \\ &= \frac{\left(\left(\frac{\lambda'}{\lambda} \right)^{N-1} \mathbb{Z} + \mathbb{Z} \right)}{I(J')} \\ &= \frac{\gcd(\lambda, \lambda')^{N-1}}{\lambda^{N-1} I(J)} \mathbb{Z}. \end{aligned}$$

But on the other hand

$$\eta(\mathbf{x}) \in \mathbb{Z} \left[\frac{1}{\lambda} \right]$$

by (17.24), and since $I(J) = (a\lambda' + 1)$ is mutually prime with λ , (17.30) follows. The remaining statements in Lemma 17.10 are obvious. \square

Note that among the solutions of the relations in Lemma 17.9 one can always look for one of them with $\eta = 0$. Because of (17.26) such solutions only exist if

$\lambda = \lambda'$, and then A must satisfy

$$(17.34) \quad \begin{cases} A \in \mathrm{GL}(N-1, \mathbb{Z}) \\ \langle \beta | A = \langle \beta | \\ A\bar{\mathbf{v}} = \bar{\mathbf{v}}'. \end{cases}$$

Thus if $\lambda = \lambda'$, the existence of an A with the properties in (17.34) is a sufficient condition for isomorphism. We next formulate a rather complicated condition which is both sufficient and necessary for general λ, λ' .

Lemma 17.11. *Adopt the notation and general assumptions in Lemma 17.9. Then a necessary and sufficient condition that G and G' are unital order isomorphic is that there exists an integer $(N-1) \times (N-1)$ matrix $A = [a_{ij}]_{i,j=1}^N$ with the properties*

$$(17.35) \quad A \in \mathrm{GL}(N-1, \mathbb{Z}),$$

$$(17.36) \quad \lambda'^{N-1}\lambda^{1-i} - \sum_{j=2}^N a_{ji}\lambda'^{N-j} \in I(J)\mathbb{Z}\left[\frac{1}{\lambda}\right] \quad \text{for } i = 2, 3, \dots, N,$$

$$(17.37) \quad A\bar{\mathbf{v}} = \bar{\mathbf{v}}'.$$

Thus a necessary condition for isomorphism is that

$$(17.38) \quad \lambda'^{N-1}\lambda^{1-N} \in I(J)\mathbb{Z}\left[\frac{1}{\lambda}\right] + \mathbb{Z}.$$

Remark 17.12. Note that since all the terms on the left side of (17.36) are integers except λ^{1-i} , and $I(J)$ is mutually prime with λ and λ' , and $\mathbb{Z}\left[\frac{1}{\lambda}\right]$ is closed under division by λ , the condition (17.36) can be formulated in the following more user-friendly way:

$$(17.39) \quad \lambda^{i-1} \sum_{j=2}^N a_{ji}\lambda'^{N-j} \in \lambda'^{N-1} + I(J)\mathbb{Z}$$

for $i = 2, 3, \dots, N$.

Proof. We know that the conditions (17.23)–(17.26) in Lemma 17.9 are necessary and sufficient. But with A given, one may use (17.25) to define η ,

$$\begin{aligned} \eta(\mathbf{x}) &= \frac{\langle \beta | \mathbf{x} \rangle - \langle \beta' | A\mathbf{x} \rangle}{\langle \alpha' | \mathbf{v}' \rangle} \\ &= \frac{\lambda'^{N-1}(\langle \beta | \mathbf{x} \rangle - \langle \beta' | A\mathbf{x} \rangle)}{I(J')} \end{aligned}$$

and since $I(J') = I(J)$ is relatively prime to both λ and λ' , we see that (17.36) is necessary and sufficient for (17.24) by putting $\mathbf{x} = \mathbf{e}_2, \mathbf{e}_3, \dots, \mathbf{e}_N$. Finally if η is defined as above we have

$$\begin{aligned} \eta(\bar{\mathbf{v}}) &= \frac{\lambda'^{N-1} \langle \beta | \bar{\mathbf{v}} \rangle - \lambda'^{N-1} \langle \beta' | \bar{\mathbf{v}}' \rangle}{I(J)} \\ &= \frac{\lambda'^{N-1} (\langle \alpha | \mathbf{v} \rangle - 1) - \lambda'^{N-1} (\langle \alpha' | \mathbf{v}' \rangle - 1)}{I(J)} \\ &= \frac{\lambda'^{N-1} \lambda^{-(N-1)} I(J) - I(J)}{I(J)} \\ &= \lambda'^{N-1} \lambda^{-(N-1)} - 1, \end{aligned}$$

so the last condition in (17.26) is fulfilled.

Finally, (17.38) follows by putting $i = N$ in (17.36). \square

We will now apply this theory to more specific examples.

1. The case $N = 1$

Here one has $\lambda = m_N$ automatically, and the corresponding C^* -algebra \mathfrak{A}_L is the UHF-algebra of Glimm type λ^∞ [47]. Thus the algebras corresponding to λ and λ' are isomorphic if and only if $\text{Prim}(\lambda) = \text{Prim}(\lambda')$. (Note that $I(J) = 1$ in all these cases, so this invariant does not separate isomorphism classes.)

2. The case $N = 2$

Here it follows from (13.2) that the possible J 's with $N = 2$ and $\lambda = m_N$ are

$$(17.40) \quad J = \begin{pmatrix} \lambda - 1 & 1 \\ \lambda & 0 \end{pmatrix}$$

for $\lambda = 2, 3, \dots$. By Lemma 17.2, $\mathbf{v} = \begin{pmatrix} 1 \\ 1 \end{pmatrix}$, and by (17.12),

$$(17.41) \quad I(J) = \lambda + 1.$$

It follows from Corollary 17.6 that *all* the algebras corresponding to (17.40) for $\lambda = 2, 3, 4, 5, \dots$ are pairwise non-isomorphic.

3. The case $N = 3$

Using Lemma 17.2 one observes that if $\lambda \in \{2, 3, \dots\}$ is given and $\lambda = m_3$, then J has the form

$$(17.42) \quad J = \begin{pmatrix} \lambda - v_2 & 1 & 0 \\ \lambda v_2 - 1 & 0 & 1 \\ \lambda & 0 & 0 \end{pmatrix} \quad \text{with} \quad \mathbf{v} = \begin{pmatrix} 1 \\ v_2 \\ 1 \end{pmatrix}$$

where $1 \leq v_2 \leq \lambda$. Using (17.12) one computes

$$I(J) = \lambda^2 + v_2\lambda + 1.$$

Hence an immediate corollary of Corollary 17.6 is:

Proposition 17.13. *If J, J' are matrices of the form (17.42) with $\lambda = \lambda'$ and $N = 3$, then \mathfrak{A}_J and $\mathfrak{A}_{J'}$ are isomorphic if and only if $J = J'$. The same is true if one λ is an integer multiple of the other.*

Proof. The last statement follows from Lemma 17.7, (17.16). \square

Let us now look at the example

$$\lambda = 48 = 2^4 \cdot 3, \quad \lambda' = 54 = 2 \cdot 3^3.$$

Then one computes that $I(J) = I(J')$ for exactly the following four pairs:

$$\begin{array}{c|cccc} v_2 & 15 & 24 & 33 & 42 \\ \hline v'_2 & 2 & 10 & 18 & 26 \end{array}$$

In general the solutions of (17.39) together with (17.35) and (17.37) in Lemma 17.11 may be found as follows.

Let $A = \begin{pmatrix} a & b \\ c & d \end{pmatrix} = \begin{pmatrix} a_{22} & a_{23} \\ a_{32} & a_{33} \end{pmatrix}$. Then (17.37) is fulfilled if and only if

$$\begin{aligned} b &= v'_2 - av_2, \\ d &= 1 - cv_2, \end{aligned}$$

and then (17.35) holds if and only if

$$\det A = a - cv'_2 = \pm 1,$$

and it follows that the conjunction of (17.35) and (17.37) is valid if and only if

$$(17.43) \quad A = \begin{pmatrix} cv'_2 \pm 1 & v'_2 - cv_2v'_2 \mp v_2 \\ c & 1 - cv_2 \end{pmatrix}$$

for an integer c . To determine this integer, we use (17.39) to deduce (for $i = 2, 3$):

$$(17.44) \quad c\lambda(v'_2\lambda' + 1) \in (\mp\lambda + \lambda')\lambda' + I(J)\mathbb{Z},$$

$$(17.45) \quad cv_2\lambda^2(v'_2\lambda' + 1) \in (v'_2 \mp v_2)\lambda^2\lambda' + \lambda^2 - \lambda'^2 + I(J)\mathbb{Z},$$

where

$$(17.46) \quad I(J) = \lambda^2 + v_2\lambda + 1 = \lambda'^2 + v'_2\lambda' + 1 = I(J').$$

Now, let us note that (17.45) actually follows from (17.44), with the same c . This is because (17.44) implies that

$$(17.47) \quad \begin{aligned} c\lambda(v_2\lambda)(v'_2\lambda' + 1) &\subseteq v_2\lambda(\mp\lambda + \lambda')\lambda' + I(J)v_2\lambda\mathbb{Z} \\ &\subseteq v_2\lambda(\mp\lambda + \lambda')\lambda' + I(J)\mathbb{Z}. \end{aligned}$$

But note that

$$\begin{aligned} D &:= v_2\lambda(\mp\lambda + \lambda')\lambda' - ((v'_2 \mp v_2)\lambda^2\lambda' + \lambda^2 - \lambda'^2) \\ &= v_2\lambda\lambda'^2 - v'_2\lambda^2\lambda' - \lambda^2 + \lambda'^2. \end{aligned}$$

As $I(J) = \lambda^2 + v_2\lambda + 1 = \lambda'^2 + v'_2\lambda' + 1 = I(J')$ we have that

$$\lambda^2 - \lambda'^2 = v'_2\lambda' - v_2\lambda,$$

and hence

$$\begin{aligned} D &= v_2\lambda\lambda'^2 - v'_2\lambda^2\lambda' - v'_2\lambda' + v_2\lambda \\ &= v_2\lambda(\lambda'^2 + 1) - v'_2\lambda'(\lambda^2 + I) \\ &= v_2\lambda I(J') - v_2\lambda v'_2\lambda' - v'_2\lambda' I(J) + v'_2\lambda' v_2\lambda \\ &\in I(J)\mathbb{Z}. \end{aligned}$$

Thus (17.45) follows from (17.44), i.e., the two conditions (17.44) and (17.45) are equivalent to (17.44) alone. But now observe that

$$v'_2\lambda' + 1 = I(J') - \lambda'^2,$$

and hence (17.44) is equivalent to

$$-c\lambda\lambda'^2 \in (\mp\lambda + \lambda')\lambda' + I(J)\mathbb{Z}.$$

Since $\lambda\lambda'^2$ is relatively prime to $I(J)$, it follows from the Euclidean algorithm within \mathbb{Z} that this relation always has a solution c in \mathbb{Z} ! Thus we have proved:

Theorem 17.14. *If J, J' are matrices of the form (17.42), the following conditions are equivalent.*

- (a) \mathfrak{A}_J and $\mathfrak{A}_{J'}$ are isomorphic.
 (b) $\text{Prim}(\lambda) = \text{Prim}(\lambda')$ and $I(J) = \lambda^2 + v_2\lambda + 1 = \lambda'^2 + v'_2\lambda' + 1 = I(J')$.

Proof. The necessity of the conditions was established in Theorem 7.8 and Corollary 17.6. The sufficiency follows from Lemma 17.11 as argued before the theorem. \square

Remark 17.15. It follows from the argument that the $A \in \text{GL}(2, \mathbb{Z})$ and the $\eta \in \text{Hom}(\mathbb{Z}^{N-1}, \mathbb{Z}[\frac{1}{\lambda}])$ corresponding to the isomorphism can and must be taken to be

$$A = \begin{pmatrix} cv'_2 \pm 1 & v'_2 - cv_2v'_2 \mp v_2 \\ c & 1 - cv_2 \end{pmatrix},$$

where c is any solution of

$$c\lambda\lambda'^2 \in (\pm\lambda - \lambda')\lambda' + I(J)\mathbb{Z}$$

and η is then defined by (17.25).

In particular the four pairs mentioned after Proposition 17.13 define isomorphic algebras. For example, the algebra defined by

$$J = \begin{pmatrix} 33 & 1 & 0 \\ 719 & 0 & 1 \\ 48 & 0 & 0 \end{pmatrix} \quad \text{with } \lambda = 48 \text{ and } \mathbf{v} = \begin{pmatrix} 1 \\ 15 \\ 1 \end{pmatrix}$$

is isomorphic to

$$J' = \begin{pmatrix} 52 & 1 & 0 \\ 107 & 0 & 1 \\ 54 & 0 & 0 \end{pmatrix} \quad \text{with } \lambda' = 54 \text{ and } \mathbf{v}' = \begin{pmatrix} 1 \\ 2 \\ 1 \end{pmatrix}.$$

Here $I(J) = I(J') = 3025$, and the Euclidean algorithm gives

$$c = -313308 = 1292 \pmod{3025}$$

and thus one A that can be used is

$$A = \begin{pmatrix} 2585 & -38773 \\ 1292 & -19379 \end{pmatrix}.$$

4. The case $N \geq 4$

In this section we prove that Theorem 17.14 remains valid also in the general $\lambda = m_N$ case, i.e., $\{N, \text{Prim } \lambda, I(J)\}$ is a complete invariant. If A is a matrix in $M_{N-1}(\mathbb{Z})$ of the form

$$(17.48) \quad A = (\mathbf{a}_2 \quad \mathbf{a}_3 \quad \cdots \quad \mathbf{a}_N)$$

in terms of column vectors $\mathbf{a}_2, \dots, \mathbf{a}_N$, then an easy computation shows that $A\mathbf{v} = \mathbf{v}'$ as in (17.37) if and only if

$$(17.49) \quad \mathbf{a}_N = \mathbf{v}' - v_2\mathbf{a}_2 - v_3\mathbf{a}_3 - \cdots - v_{N-1}\mathbf{a}_{N-1}.$$

Thus condition (17.35) says that

$$(17.50) \quad \det(\mathbf{a}_2 \quad \mathbf{a}_3 \quad \cdots \quad \mathbf{a}_{N-1} \quad \mathbf{v}') = \pm 1,$$

and what remains is to choose $\mathbf{a}_2, \mathbf{a}_3, \dots, \mathbf{a}_{N-1}$ such that (17.39) is satisfied. For example, try

$$(17.51) \quad A = \begin{pmatrix} a_2 & 0 & \cdots & 0 & v'_2 - a_2 v_2 \\ 0 & a_3 & & 0 & v'_3 - a_3 v_3 \\ \vdots & & \ddots & & \vdots \\ 0 & 0 & & a_{N-1} & v'_{N-1} - a_{N-1} v_{N-1} \\ c_2 & c_3 & \cdots & c_{N-1} & 1 - c_2 v_2 - c_3 v_3 - \cdots - c_{N-1} v_{N-1} \end{pmatrix}.$$

Fixing c_2, c_3, \dots, c_{N-1} , one may now choose $a_{N-1}, a_{N-2}, \dots, a_2$ successively such that the determinant of the lower right $k \times k$ matrix is 1 for $k = 2, 3, \dots, N-1$. This leads to the recursion relations

$$(17.52) \quad \begin{aligned} a_{N-1} &= 1 + c_{N-1} v'_{N-1}, \\ a_{N-2} &= 1 + c_{N-2} a_{N-1} v'_{N-2}, \\ a_{N-3} &= 1 + c_{N-3} a_{N-2} a_{N-1} v'_{N-3}, \\ &\vdots \\ &\vdots \\ a_2 &= 1 + c_2 a_3 a_4 \cdots a_{N-1} v'_2. \end{aligned}$$

Inserting this in (17.39) gives a way of determining suitable values of c_2, \dots, c_{N-1} as in the $N = 3$ case, but we have by now already made several arbitrary choices which we did not need to do in the $N = 3$ case, and it is not quite clear that this approach leads to the goal. There is, however, one case where it does, namely if $\lambda = \lambda'$. Then one may simply choose $c_2 = c_3 = \cdots = c_{N-1} = 0$, and so $a_2 = a_3 = \cdots = a_{N-1} = 1$ and

$$(17.53) \quad A = \begin{pmatrix} 1 & 0 & \cdots & 0 & v'_2 - v_2 \\ 0 & 1 & & 0 & v'_3 - v_3 \\ \vdots & & \ddots & & \vdots \\ 0 & 0 & & 1 & v'_{N-1} - v_{N-1} \\ 0 & 0 & \cdots & 0 & 1 \end{pmatrix}.$$

Since $\lambda = \lambda'$, (17.39) is automatically satisfied, and we have

Theorem 17.16. *Let J, J' be matrices of the form (11.2), and assume that $\lambda = m_N = \lambda' = m'_N$. Then the following three conditions are equivalent:*

- (a) \mathfrak{A}_J and $\mathfrak{A}_{J'}$ are isomorphic;
- (b) $N = N'$ and $I(J) = I(J')$;

and

- (c) $N = N'$ and $\langle \alpha | \mathbf{v} \rangle = \langle \alpha' | \mathbf{v}' \rangle$.

Proof. This follows from the remarks before the theorem, Lemma 17.11, Corollary 17.6, and the formula

$$(17.54) \quad \langle \alpha | \mathbf{v} \rangle = I(J) / \lambda^{N-1}. \quad \square$$

Example 17.17. The present example shows that Proposition 17.13 does not extend to the case $N = 4$, i.e., isomorphism does not imply $\lambda \neq \lambda'$, and it also shows that Theorem 17.16 is not merely concerned with the empty set.

The example is

$$(17.55) \quad J = \begin{pmatrix} 1 & 1 & 0 & 0 \\ 2 & 0 & 1 & 0 \\ 11 & 0 & 0 & 1 \\ 3 & 0 & 0 & 0 \end{pmatrix}, \quad J' = \begin{pmatrix} 0 & 1 & 0 & 0 \\ 8 & 0 & 1 & 0 \\ 2 & 0 & 0 & 1 \\ 3 & 0 & 0 & 0 \end{pmatrix}.$$

Here $\lambda = \lambda' = 3$, and

$$(17.56) \quad \mathbf{v} = \begin{pmatrix} 1 \\ 2 \\ 4 \\ 1 \end{pmatrix}, \quad \mathbf{v}' = \begin{pmatrix} 1 \\ 3 \\ 1 \\ 1 \end{pmatrix}.$$

See Figure 20. Using the unique decomposition

$$(17.57) \quad \begin{pmatrix} 1 \\ 0 \\ 0 \\ 0 \end{pmatrix} = \frac{\mathbf{v}}{\langle \alpha | \mathbf{v} \rangle} + \mathbf{w},$$

where $\langle \alpha | \mathbf{w} \rangle = 0$, one sees that the n 'th row vector in the left diagram in Figure 20 behaves asymptotically like

$$(17.58) \quad 3^n \frac{\mathbf{v}^t}{\langle \alpha | \mathbf{v} \rangle} = \frac{27}{58} \cdot 3^n \cdot (1, 2, 4, 1),$$

and the n 'th row vector in the right diagram in Figure 20 behaves asymptotically like

$$(17.59) \quad \frac{27}{58} \cdot 3^n \cdot (1, 3, 1, 1).$$

(The latter matrix has an eigenvalue $-2.769\dots$, which is negative and close to 3 in absolute value, therefore the slow and oscillatory convergence to the asymptotic behaviour indicated by the figure.) One can now check that the conditions in Lemma 17.9 are fulfilled with

$$(17.60) \quad A = \begin{pmatrix} 1 & 0 & 1 \\ 0 & 1 & -3 \\ 0 & 0 & 1 \end{pmatrix}, \quad \eta = 0.$$

In fact, since $\lambda = \lambda' = 3$ and $\eta = 0$ it suffices to check (17.34), and that is straightforward. Thus the two AF-algebras \mathfrak{A}_J and $\mathfrak{A}_{J'}$ are isomorphic, showing that Proposition (17.13) does not extend to $N = 4$. Computing the matrix Λ in Proposition 11.7 for this example, one finds

$$(17.61) \quad \Lambda = \begin{pmatrix} 1 & 0 & 0 & 0 \\ 0 & 1 & 0 & 1 \\ 0 & 0 & 1 & -3 \\ 0 & 0 & 0 & 1 \end{pmatrix}.$$

We are now ready to state and give the proof of the main result in this chapter.

Theorem 17.18. (K.H. Kim and F. Roush) *Let J, J' be matrices of the form (11.2) satisfying the standard requirements there, and assume that $\lambda = m_N$ and $\lambda' = m'_{N'}$. Then the following conditions are equivalent.*

- (a) \mathfrak{A}_J and $\mathfrak{A}_{J'}$ are isomorphic.
- (b) $N = N'$, $\text{Prim}(\lambda) = \text{Prim}(\lambda')$, and $I(J) = I(J')$.

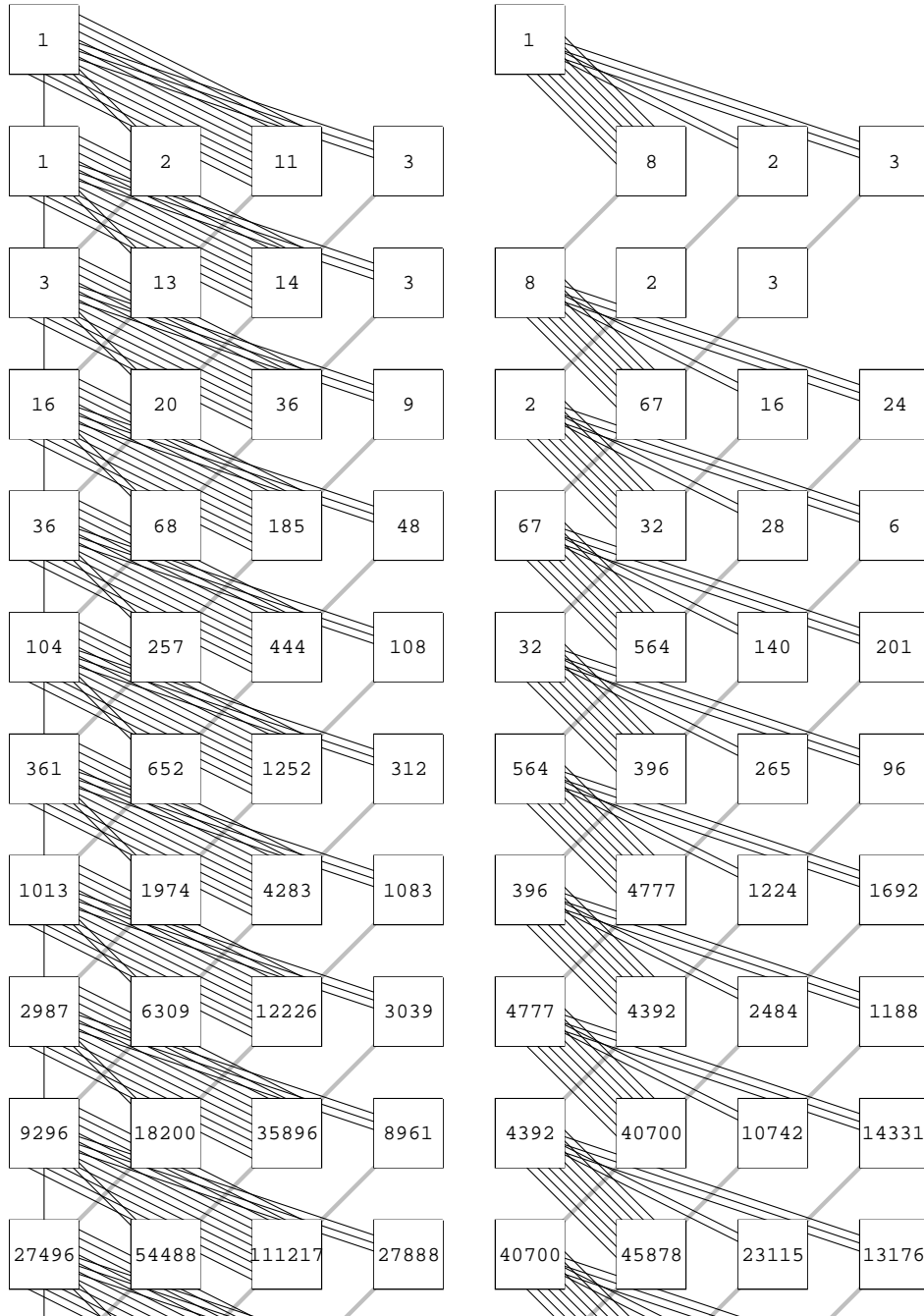

FIGURE 20. $L = \{1, 2, 2, 3, 3, 3, 3, 3, 3, 3, 3, 3, 3, 3, 3, 3, 4, 4, 4\}$, first column = $(1 \ 2 \ 11 \ 3)^t$ (left); $L = \{2, 2, 2, 2, 2, 2, 2, 2, 3, 3, 4, 4, 4\}$, first column = $(0 \ 8 \ 2 \ 3)^t$ (right). See (17.55)–(17.61). These diagrams represent isomorphic AF-algebras.

We will establish later, in Corollary 17.21, that these conditions are also equivalent to stable isomorphism of \mathfrak{A}_J and $\mathfrak{A}_{J'}$.

In order to prove this theorem, we will need some elementary facts about

$$(17.62) \quad \mathcal{S}_n = \{\mathbf{x} \in \mathbb{Z}^n \setminus \{0\} \mid \gcd \mathbf{x} = 1\},$$

where n is a natural number, and $\gcd \mathbf{x}$ is the greatest common divisor of the components of \mathbf{x} . If $\mathbf{x} \in \mathbb{Z}^n$ we write $\langle \mathbf{x} \mid$ if we think about \mathbf{x} as a row vector and $\mid \mathbf{x} \rangle$ if we consider \mathbf{x} as the column vector which is the transpose of $\langle \mathbf{x} \mid$. Thus, by the Euclidean algorithm,

$$(17.63) \quad \mathcal{S}_n = \{\mid \mathbf{x} \rangle \in \mathbb{Z}^n \mid \exists \langle \mathbf{t} \mid \in \mathbb{Z}^n \ni \langle \mathbf{t} \mid \mathbf{x} \rangle = 1\}.$$

Note that $\mathrm{GL}(n, \mathbb{Z})$ (i.e., the group of matrices in $M_n(\mathbb{Z})$ with determinant ± 1) acts on $\mid \mathcal{S}_n \rangle$ by multiplication from the left. The reason is that if $\mathbf{x} \in \mathcal{S}_n$, there is a $t \in \mathbb{Z}^n$ with $\langle \mathbf{t} \mid \mathbf{x} \rangle = 1$, and hence $\langle \mathbf{t} \mid A^{-1}A \mid \mathbf{x} \rangle = 1$, so $A\mathbf{x} \in \mathcal{S}_n$. We next argue that

$$(17.64) \quad \text{The action of } \mathrm{GL}(n, \mathbb{Z}) \text{ on } \mathcal{S}_n \text{ is transitive.}$$

Proof. By [68, Theorem II.1], there exists for any $\mid \alpha \rangle \in \mid \mathcal{S}_n \rangle$ a matrix $A_\alpha \in \mathrm{GL}(n, \mathbb{Z})$ such that the first column of A_α is $\mid \alpha \rangle$: this means $\mid \alpha \rangle = A_\alpha \mid \mathbf{e}_1 \rangle$. But if $\mid \beta \rangle \in \mid \mathcal{S}_n \rangle$, this means $A_\alpha A_\beta^{-1} \mid \beta \rangle = \mid \alpha \rangle$ and transitivity follows. \square

Now, let us prove

Lemma 17.19. *If $\alpha^{(1)}, \alpha^{(2)}, \mathbf{v}_1, \mathbf{v}_2 \in \mathcal{S}_n$, the following conditions (17.65) and (17.66) are equivalent if $n \geq 3$.*

$$(17.65) \quad \text{There is an } A \in \mathrm{GL}(n, \mathbb{Z}) \text{ such that } \langle \alpha^{(1)} \mid A = \langle \alpha^{(2)} \mid \text{ and } A \mid \mathbf{v}_1 \rangle = \mid \mathbf{v}_2 \rangle.$$

$$(17.66) \quad \langle \alpha^{(1)} \mid \mathbf{v}_2 \rangle = \langle \alpha^{(2)} \mid \mathbf{v}_1 \rangle.$$

(The implication (17.65) \Rightarrow (17.66) is true for all n , but the converse implication may fail for $n = 2$.)

Proof. (Due to K.H. Kim and F. Roush.) If (17.65) holds, then

$$\langle \alpha^{(1)} \mid \mathbf{v}_2 \rangle = \langle \alpha^{(1)} \mid A \mid \mathbf{v}_1 \rangle = \langle \alpha^{(2)} \mid \mathbf{v}_1 \rangle.$$

If, conversely, (17.66) holds, first choose matrices $U, V \in \mathrm{GL}(n, \mathbb{Z})$ with

$$\langle \alpha^{(1)} \mid U = \langle \mathbf{e}_1 \mid, \quad V \mid \mathbf{v}_1 \rangle = \mid \mathbf{e}_1 \rangle.$$

This is possible by (17.64). It follows from Lemma 17.20, below, that there exists a matrix $B \in \mathrm{GL}(n, \mathbb{Z})$ such that the first column in B is $U^{-1} \mid \mathbf{v}_2 \rangle$ and the first row in B is $\langle \alpha^{(2)} \mid V^{-1}$. For this, we note that $U^{-1} \mid \mathbf{v}_2 \rangle \in \mid \mathcal{S}_n \rangle$ and $\langle \alpha^{(2)} \mid V^{-1} \in \langle \mathcal{S}_n \mid$, and the first component of $U^{-1} \mid \mathbf{v}_2 \rangle$ is $\langle \mathbf{e}_1 \mid U^{-1} \mid \mathbf{v}_2 \rangle = \langle \alpha^{(1)} \mid UU^{-1} \mid \mathbf{v}_2 \rangle = \langle \alpha^{(1)} \mid \mathbf{v}_2 \rangle = \langle \alpha^{(2)} \mid \mathbf{v}_1 \rangle = \langle \alpha^{(2)} \mid V^{-1}V \mid \mathbf{v}_1 \rangle = \langle \alpha^{(2)} \mid V^{-1} \mid \mathbf{e}_1 \rangle =$ the first component of $\langle \alpha^{(2)} \mid V^{-1}$. Now put

$$A = UBV.$$

Then

$$\langle \alpha^{(1)} \mid A = \langle \alpha^{(1)} \mid UBV = \langle \mathbf{e}_1 \mid BV = \langle \alpha^{(2)} \mid V^{-1}V = \langle \alpha^{(2)} \mid,$$

and

$$A \mid \mathbf{v}_1 \rangle = UBV \mid \mathbf{v}_1 \rangle = UB \mid \mathbf{e}_1 \rangle = UU^{-1} \mid \mathbf{v}_2 \rangle = \mid \mathbf{v}_2 \rangle. \quad \square$$

Thus, we have to prove

Lemma 17.20. *Let α, β be vectors in \mathcal{S}_n with $\alpha_1 = \beta_1$, and assume that $n \geq 3$. Then there exists a matrix $V \in \mathrm{GL}(n, \mathbb{Z})$ such that the first column in B is $|\alpha\rangle$ and the first row is $\langle\beta|$.*

Proof. (Due to K.H. Kim and F. Roush.) We will use the fact that row, respectively column, operations on a matrix can be effectuated by multiplying from the left, respectively right, by matrices in $\mathrm{GL}(n, \mathbb{Z})$. For example, interchanging the first two rows in A corresponds to multiplying A from the left by $\begin{pmatrix} 0 & 1 \\ 1 & 0 \end{pmatrix} \oplus \mathbb{1}_{n-2}$, and adding μ times row 2 to row 1 corresponds to left-multiplying by $\begin{pmatrix} 1 & \mu \\ 0 & 1 \end{pmatrix} \oplus \mathbb{1}_{n-2}$. The corresponding column operations follow by taking the transpose. If now $A \in \mathrm{GL}(n, \mathbb{Z})$ is a matrix of the form

$$A = \left(\begin{array}{c|ccc} \alpha_1 & \beta_2 & \cdots & \beta_n \\ \hline \alpha_2 & * & & * \\ \vdots & & & \\ \alpha_n & * & & * \end{array} \right),$$

let $\gamma_1 = \mathrm{gcd}(\beta_2, \dots, \beta_n)$, and choose $\rho_2, \rho_3, \dots, \rho_n$ such that $\rho_2\beta_2 + \cdots + \rho_n\beta_n = \gamma_1$. Let U_1 be a matrix in $\mathrm{GL}(n-1, \mathbb{Z})$ with first column $\begin{pmatrix} \rho_2 \\ \vdots \\ \rho_n \end{pmatrix}$ (it exists by [68, Theorem II.1]). Now multiply by A from the left to obtain

$$A \left(\begin{array}{c|ccc} 1 & 0 & \cdots & 0 \\ \hline 0 & & & \\ \vdots & & & \\ 0 & & & \end{array} \begin{array}{c} \\ U_1 \\ \\ \end{array} \right) = A \left(\begin{array}{c|ccc} 1 & 0 & \cdots & 0 \\ \hline 0 & \rho_2 & & * \\ \vdots & \vdots & & \\ 0 & \rho_n & & * \end{array} \right) = \left(\begin{array}{c|cccc} \alpha_1 & \gamma_1 & \gamma_2 & \cdots & \gamma_{n-1} \\ \hline \alpha_2 & * & & & * \\ \alpha_3 & & & & \\ \vdots & & & & \\ \alpha_n & * & & & * \end{array} \right),$$

where the remaining elements $\gamma_2, \dots, \gamma_{n-1}$ on the first row are linear combinations of β_2, \dots, β_n , and thus multiples of γ_1 . By subtracting integer multiples of the second column from the remaining columns, one finally finds a matrix $U \in \mathrm{GL}(n, \mathbb{Z})$ such that

$$AU = \left(\begin{array}{c|cccc} \alpha_1 & \gamma_1 & 0 & \cdots & 0 \\ \hline \alpha_2 & * & & & * \\ \alpha_3 & & & & \\ \vdots & & & & \\ \alpha_n & * & & & * \end{array} \right).$$

Putting $\gamma_2 = \gcd(\alpha_2, \dots, \alpha_n)$ and transposing all these operations, one finds a $V \in \text{GL}(n, \mathbb{Z})$ such that

$$VAU = \left(\begin{array}{c|cccc} \alpha_1 & \gamma_1 & 0 & \cdots & 0 \\ \hline \gamma_2 & & * & & * \\ 0 & & & & \\ \vdots & & & & \\ 0 & & * & & * \end{array} \right),$$

where $\gcd(\gamma_2, \alpha_1) = 1$. Thus, if we can prove Lemma 17.20 for this kind of matrices, the general Lemma 17.20 follows by multiplying from the left and right by the inverses V^{-1}, U^{-1} . This reduces the proof of Lemma 17.20 to the case

$$\alpha_3 = \alpha_4 = \cdots = \alpha_n = 0 = \beta_3 = \beta_4 = \cdots = \beta_n,$$

and $\gcd(\alpha_1, \alpha_2) = \gcd(\beta_1, \beta_2) = 1$ where still $\alpha_1 = \beta_1$. But to this end one can use the matrix

$$\begin{pmatrix} \alpha_1 & \beta_2 & 0 & 0 & \cdots & 0 \\ \alpha_2 & 1 & x & 0 & \cdots & 0 \\ 0 & 1 & y & 0 & \cdots & 0 \\ 0 & 0 & 0 & 1 & & 0 \\ \vdots & \vdots & \vdots & & \ddots & \vdots \\ 0 & 0 & 0 & 0 & \cdots & 1 \end{pmatrix}.$$

The determinant is $\alpha_1(y-x) - \alpha_2\beta_2y$, but as $\gcd(\alpha_1, \alpha_2\beta_2) = 1$, this can be made equal to 1 by choosing the integers $(y-x)$ and $(-y)$ by the Euclidean algorithm. This ends the proof of Lemma 17.20, and thus of Lemma 17.19. Note that if $n = 2$ the proof above does not work: One must choose an integer x such that

$$\begin{vmatrix} \alpha_1 & \beta_2 \\ \alpha_2 & x \end{vmatrix} = \alpha_1x - \alpha_2\beta_2 = \pm 1$$

when $\alpha_1, \alpha_2, \beta_2$ are given with $\gcd(\alpha_1, \alpha_2) = 1 = \gcd(\alpha_1, \beta_2)$, and this is clearly impossible in general. \square

Proof of Theorem 17.18. (Due to K.H. Kim and F. Roush.) If J, J' are matrices of the form (11.2) with $\lambda = m_N$ and $\lambda' = m'_{N'}$, then $N = N'$ and $\text{Prim}(\lambda) = \text{Prim}(\lambda')$ by Theorem 7.8, and then $I(J) = I(J')$ by Corollary 17.6. This proves (a) \Rightarrow (b). The converse implication follows in the cases $N = 1, 2, 3$ by Theorem 17.14 and the discussion around (17.41), so we may assume $N \geq 4$ from now on. Assuming (b) it follows from Lemma 17.11 and Remark 17.12 that \mathfrak{A}_J and $\mathfrak{A}_{J'}$ are isomorphic if and only if there exists a matrix $A \in \text{GL}(N-1, \mathbb{Z})$ such that

$$(17.67) \quad \langle \beta' | A = \langle \beta | \quad \text{mod } I(J) \mathbb{Z}^{N-1}$$

where we now define

$$(17.68) \quad \beta' = \lambda'^{N-1} (\lambda'^{N-2}, \lambda'^{N-3}, \dots, \lambda', 1)$$

and

$$(17.69) \quad \beta = \lambda^{N-1} (\lambda^{N-2}, \lambda^{N-3}, \dots, \lambda, 1)$$

and

$$(17.70) \quad A|\bar{\mathbf{v}} = |\bar{\mathbf{v}}'.$$

Now, one checks that

$$(17.71) \quad \langle \beta' | \bar{\mathbf{v}}' \rangle = \lambda^{N-1} (\lambda'^{N-2} c'_2 + \cdots + \lambda' c'_{N-1} + 1) = \lambda^{N-1} I(J) - \lambda^{N-1} \lambda'^{N-1}$$

and

$$(17.72) \quad \langle \beta | \bar{\mathbf{v}} \rangle = \lambda'^{N-1} I(J) - \lambda'^{N-1} \lambda^{N-1},$$

and thus

$$(17.73) \quad \langle \beta' | \bar{\mathbf{v}}' \rangle = \langle \beta | \bar{\mathbf{v}} \rangle + (\lambda^{N-1} - \lambda'^{N-1}) I(J) = \langle \beta | \bar{\mathbf{v}} \rangle \pmod{I(J)}.$$

Now we cannot apply Lemma 17.19 directly on $\alpha^{(1)} = \beta'$, $\alpha^{(2)} = \beta$, $\mathbf{v}_1 = \bar{\mathbf{v}}$, $\mathbf{v}_2 = \bar{\mathbf{v}}'$, for two reasons: we do not have $\beta, \beta' \in \mathcal{S}_n$, and the condition (17.66) is only fulfilled modulo $I(J)$. But let us remedy this by modifying β, β' as follows: First add an integer multiple of $I(J)(0, 0, \dots, 1)$ to β' to obtain a new β' , called $\beta^{(1)'}$, such that $\langle \beta^{(1)'} | \bar{\mathbf{v}}' \rangle = \langle \beta | \bar{\mathbf{v}} \rangle$. This is possible since the last component of $\bar{\mathbf{v}}'$ is 1 by (17.27). Now modify the new $\beta^{(1)'}$ to $\beta^{(2)'}$ by adding integer multiples of the vector $I(J)(0, 0, \dots, 0, -1, v'_{N-1})$ to $\beta^{(1)'}$ until the second-to-last component contains none of the prime factors in $\text{Prim}(\lambda) = \text{Prim}(\lambda')$. This is possible since $I(J)$ is relatively prime to λ and λ' . Then $\langle \beta^{(2)'} | \bar{\mathbf{v}}' \rangle = \langle \beta^{(1)'} | \bar{\mathbf{v}}' \rangle$ since $(0, 0, \dots, 0, -1, v'_{N-1})$ is orthogonal to $\bar{\mathbf{v}}'$ and $\beta^{(2)'} \in \mathcal{S}_n$. Finally, modify β to $\beta^{(2)}$ by adding multiples of $I(J)(0, 0, \dots, 0, -1, v_{N-1})$ until the second-to-last component is relatively prime to the first $N-3$ components. Then $\langle \beta^{(2)} | \bar{\mathbf{v}} \rangle = \langle \beta | \bar{\mathbf{v}} \rangle$ and hence

$$\langle \beta^{(2)'} | \bar{\mathbf{v}}' \rangle = \langle \beta | \bar{\mathbf{v}} \rangle.$$

But since $N-1 \geq 3$ we may now apply Lemma 17.19 to find an $A \in \text{GL}(N-1, \mathbb{Z})$ such that

$$\langle \beta^{(2)'} | A = \langle \beta^{(2)} | \quad \text{and} \quad A|\bar{\mathbf{v}} = |\bar{\mathbf{v}}'.$$

But since

$$\langle \beta^{(2)'} | = \langle \beta' | \pmod{I(J) \mathbb{Z}^{N-1}}$$

and

$$\langle \beta^{(2)} | = \langle \beta | \pmod{I(J) \mathbb{Z}^{N-1}},$$

it follows that

$$\langle \beta' | A = \langle \beta | \pmod{I(J) \mathbb{Z}^{N-1}}.$$

Thus (17.67) and (17.70) are fulfilled and Theorem 17.18 is proved. \square

Let us end this chapter by mentioning that the equivalent conditions (a) and (b) again are equivalent to the condition that \mathfrak{A}_J and $\mathfrak{A}_{J'}$ are stably isomorphic, i.e., to that $\mathfrak{A}_J \otimes \mathcal{K}(\mathcal{H})$ is isomorphic to $\mathfrak{A}_{J'} \otimes \mathcal{K}(\mathcal{H})$, where $\mathcal{K}(\mathcal{H})$ is the C^* -algebra of compact operators on a separable Hilbert space \mathcal{H} . This is due to the very special position of $[\mathbb{1}]$ in $K_0(\mathfrak{A}_J)$, and this property has no general analogue: For example, it is impossible to find an automorphism of $\mathbb{Z}[\frac{1}{2}]$ mapping 1 into 3.

Corollary 17.21. *Let J, J' be matrices of the form (11.2) satisfying the standard requirement there, and assume that $\lambda = m_N$ and $\lambda' = m'_{N'}$. Then the following three conditions are equivalent.*

- (a) *The triples $(K_0(\mathfrak{A}_J), K_0(\mathfrak{A}_J)_+, [\mathbb{1}])$ and $(K_0(\mathfrak{A}_{J'}), K_0(\mathfrak{A}_{J'})_+, [\mathbb{1}])$ are isomorphic, i.e., the dimension groups are isomorphic by an isomorphism mapping $[\mathbb{1}]$ into $[\mathbb{1}]$.*

- (b) *The dimension groups $(K_0(\mathfrak{A}_J), K_0(\mathfrak{A}_J)_+)$ and $(K_0(\mathfrak{A}_{J'}), K_0(\mathfrak{A}_{J'})_+)$ are isomorphic.*
- (c) $N = N'$, $\text{Prim}(\lambda) = \text{Prim}(\lambda')$, and $I(J) = I(J')$.

Proof. The equivalence (a) \Leftrightarrow (c) is Theorem 17.18, and (a) \Rightarrow (b) is trivial. Thus it suffices to show that (b) \Rightarrow (c), so assume (b). Then one establishes $N = N'$ and $\text{Prim}(\lambda) = \text{Prim}(\lambda')$ exactly as in Theorem 7.8, and it remains to establish $I(J) = I(J')$. For this one notes that Proposition 11.7 remains true in the context of nonunital isomorphism with the exception that the condition 5 is just removed, and condition 2 is replaced by

$$\langle \alpha' | \Lambda = \mu \langle \alpha |,$$

where μ is a positive scalar. But since μ induces an automorphism on the range $\mathbb{Z}[\frac{1}{\lambda}] = \mathbb{Z}[\frac{1}{\lambda'}]$ of the trace, it follows that μ is an invertible element of the ring $\mathbb{Z}[\frac{1}{\lambda}]$. Now the Lemmas 17.1–17.3 do not involve $[\mathbb{1}]$ and are still valid, and then Lemma 17.4 is valid with the same proof. Now the equation in the proof of Corollary 17.5 becomes

$$\langle \alpha | \mathbf{v} \rangle = \mu^{-1} \langle \alpha' | \Lambda \mathbf{v} \rangle = \mu^{-1} \langle \alpha' | \xi \mathbf{v}' \rangle = \mu^{-1} \xi \langle \alpha' | \mathbf{v}' \rangle,$$

so Corollary 17.5 is still valid. The proof that $I(J) = I(J')$ is now exactly as in the proof of Corollary 17.6. \square

Further comments on two examples from Chapter 16

We now consider two sub-examples with $N = 3$, $d = 5$. Although the groups $K_0(\mathfrak{A}_L)$ and $K_0(\mathfrak{A}_{L'})$ have the same rank, we will show directly in Examples 18.1 and 18.2 that they are non-isomorphic. The details also serve to illustrate what goes into the computation of some particular inductive limit which is not immediately transparent.

The two algebras corresponding to $x + 4x^3 = 1$ and $3x^2 + 2x^3 = 1$ are the two with stabilized diagrams

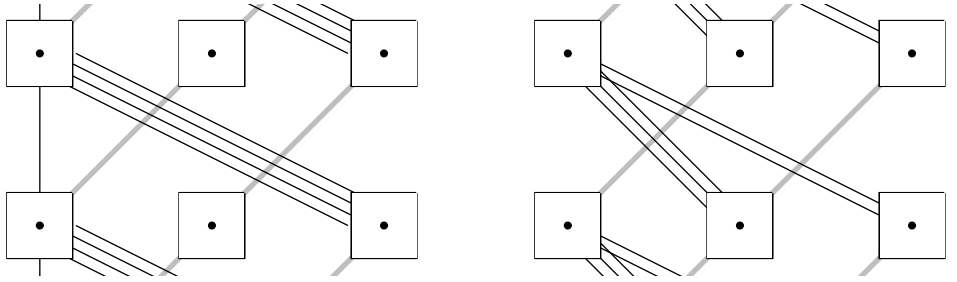

i.e., with incidence matrices

$$J_1 = \begin{pmatrix} 1 & 1 & 0 \\ 0 & 0 & 1 \\ 4 & 0 & 0 \end{pmatrix}, \quad J_2 = \begin{pmatrix} 0 & 1 & 0 \\ 3 & 0 & 1 \\ 2 & 0 & 0 \end{pmatrix}.$$

The two examples above both have $\beta = \ln 2$, and $\text{rank}(K_0(\mathfrak{A}_L)) = 3$ (and $d = 5$), but the two dimension groups are actually non-isomorphic since the $\text{Prim}(Q)$ invariants are different; see the $N = 3$ case in Chapter 16. We will, however, establish this the hard way in Examples 18.1 and 18.2 by showing that the respective $\ker(\tau)$ -groups in the two examples are non-isomorphic.

Example 18.1. This is an elaboration on Remark 9.3.

$$J_1 = \begin{pmatrix} 1 & 1 & 0 \\ 0 & 0 & 1 \\ 4 & 0 & 0 \end{pmatrix}$$

The Frobenius eigenvalue is 2 (see (5.8)) and the corresponding normalized left eigenvector α is

$$\alpha = \left(1, \frac{1}{2}, \frac{1}{4}\right)$$

by (5.17). J_1 has eigenvalues 2 and $\lambda_{\pm} = \frac{-1 \pm \sqrt{-7}}{2}$, $|\lambda_{\pm}| < 2$; J_1 leaves the subspace orthogonal to $\alpha = (1, \frac{1}{2}, \frac{1}{4})$ invariant. This is spanned by the vectors

$$e_1 = \begin{pmatrix} 1 \\ -2 \\ 0 \end{pmatrix}, \quad e_2 = \begin{pmatrix} 0 \\ 1 \\ -2 \end{pmatrix},$$

and one computes that the matrix of the restriction of J to this subspace is

$$J_0 = \begin{pmatrix} -1 & 1 \\ -2 & 0 \end{pmatrix}.$$

We may compute the iterated inverses J_0^{-n} by straightforward spectral theory, and if we put

$$\mu = (1 - i\sqrt{7})/4$$

the result is

$$J_0^{-n} = \begin{pmatrix} -1 & 1 \\ -2 & 0 \end{pmatrix}^{-n} = \frac{1}{(-2)^n} \frac{1}{\mu - \bar{\mu}} \begin{pmatrix} \frac{1}{\mu^{n-1}} - \frac{1}{\bar{\mu}^{n-1}} & -\frac{\bar{\mu}}{\mu^{n-1}} + \frac{\mu}{\bar{\mu}^{n-1}} \\ \frac{1}{\mu^n} - \frac{1}{\bar{\mu}^n} & -\frac{\bar{\mu}}{\mu^n} + \frac{\mu}{\bar{\mu}^n} \end{pmatrix}.$$

The eigenvector of J_1 with eigenvalue 2 is

$$e_0 = \begin{pmatrix} 1 \\ 1 \\ 2 \end{pmatrix}.$$

Thus, if

$$\Delta = (e_0 \ e_1 \ e_2) = \begin{pmatrix} 1 & 1 & 0 \\ 1 & -2 & 1 \\ 2 & 0 & -2 \end{pmatrix},$$

then

$$\Delta^{-1} J_1 \Delta = \begin{pmatrix} 2 & 0 & 0 \\ 0 & -1 & 1 \\ 0 & -2 & 0 \end{pmatrix}$$

and

$$\Delta^{-1} J_1^{-n} \Delta = (\Delta^{-1} J_1 \Delta)^{-n} = \left(\begin{array}{c|cc} 2^{-n} & 0 & 0 \\ \hline 0 & & \\ 0 & & J_0^{-n} \end{array} \right).$$

Thus

$$J_1^{-n} = \Delta \left(\begin{array}{c|cc} 2^{-n} & 0 & 0 \\ \hline 0 & & \\ 0 & & J_0^{-n} \end{array} \right) \Delta^{-1}.$$

We have

$$\Delta^{-1} = \frac{1}{8} \begin{pmatrix} 4 & 2 & 1 \\ 4 & -2 & -1 \\ 4 & 2 & -3 \end{pmatrix}.$$

Thus the dimension group, as a subgroup of \mathbb{R}^3 ($N = 3$), is

$$\bigcup_{n=0}^{\infty} \frac{1}{8} \begin{pmatrix} 1 & 1 & 0 \\ 1 & -2 & 1 \\ 2 & 0 & -2 \end{pmatrix} \left(\begin{array}{c|cc} 2^{-n} & 0 & 0 \\ \hline 0 & & \\ 0 & & J_0^{-n} \end{array} \right) \begin{pmatrix} 4 & 2 & 1 \\ 4 & -2 & -1 \\ 4 & 2 & -3 \end{pmatrix} \mathbb{Z}^3$$

(where the union is increasing), i.e., $\bigcup_n M_n \mathbb{Z}^3$ when M_n is the product matrix. The range of the trace on K_0 is α applied to this set (the range of the trace on \mathfrak{A}_L is gotten by intersecting with $[0, 1]$). We have

$$\begin{aligned} & \alpha \frac{1}{8} \begin{pmatrix} 1 & 1 & 0 \\ 1 & -2 & 1 \\ 2 & 0 & -2 \end{pmatrix} \begin{pmatrix} 2^{-n} & 0 & 0 \\ 0 & * & * \\ 0 & * & * \end{pmatrix} \begin{pmatrix} 4 & 2 & 1 \\ 4 & -2 & -1 \\ 4 & 2 & -3 \end{pmatrix} \\ &= \frac{1}{4} (1 \ 0 \ 0) \begin{pmatrix} 2^{-n} & 0 & 0 \\ 0 & * & * \\ 0 & * & * \end{pmatrix} \begin{pmatrix} 4 & 2 & 1 \\ 4 & -2 & -1 \\ 4 & 2 & -3 \end{pmatrix} \\ &= (2^{-n-2} \ 0 \ 0) \begin{pmatrix} 4 & 2 & 1 \\ * & * & * \\ * & * & * \end{pmatrix} \\ &= (2^{-n} \ 2^{-n+1} \ 2^{-n-2}), \end{aligned}$$

i.e., $\alpha M_n = (2^{-n} \ 2^{-n-1} \ 2^{-n-2})$, and applying this to \mathbb{Z}^3 we reconfirm that the range of the trace is the set of all dyadic rationals. The range of the trace on the m 'th term in

$$\mathbb{Z}^3 \longrightarrow \mathbb{Z}^3 \longrightarrow \dots$$

is

$$\begin{aligned} 2^{-m+1} \langle \alpha | \mathbb{Z}^3 \rangle &= 2^{-m+1} (1, \frac{1}{2}, \frac{1}{4}) \mathbb{Z}^3 \\ &= 2^{-m+1} \mathbb{Z}. \end{aligned}$$

Now, the infinitesimal elements of the m 'th \mathbb{Z}^3 are the elements of the kernel of $\alpha J_1^{-m+1} = 2^{-m+1} \alpha$, i.e., the elements of the kernel of α , that is elements of \mathbb{Z}^3 of the form

$$\begin{pmatrix} n_1 \\ n_2 \\ -4n_1 - 2n_2 \end{pmatrix} = n_1 e_1 + (2n_1 + n_2) e_2,$$

where $n_1, n_2 \in \mathbb{Z}$. Thus

$$J_1^{-n} \begin{pmatrix} n_1 \\ n_2 \\ -4n_1 - 2n_2 \end{pmatrix} = \Delta \left(\begin{array}{c|cc} 2^{-n} & 0 & 0 \\ \hline 0 & & J_0^{-n} \\ 0 & & \end{array} \right) \begin{pmatrix} 0 \\ n_1 \\ 2n_1 + n_2 \end{pmatrix}.$$

Thus the dimension group of \mathfrak{A}_L is an extension

$$0 \hookrightarrow G_0 \hookrightarrow K_0(\mathfrak{A}_L) \xrightarrow{\tau} \mathbb{Z} \left[\frac{1}{2} \right] \longrightarrow 0,$$

where $G_0 = \ker \tau$ is the group of infinitesimal elements. It is rather complicated to describe G_0 in the matrix formalism above, so let us instead use the algebraic description in (5.41), that is,

$$G_0 \cong \mathbb{Z}[x] / p_0(x) \mathbb{Z}[x],$$

where

$$p_0(x) = \frac{p_L(x)}{p_a(x)} = \frac{x + 4x^3 - 1}{2x - 1} = 2x^2 + x + 1.$$

Now, embed \mathbb{Z} in G_0 as the group H generated by $1 \pmod{p_0(x)}$ (note that $n1 \neq 0 \pmod{p_0(x)}$ for all $n \in \mathbb{Z} \setminus \{0\}$, so this is really an embedding). We argue that

$$G_0 / H \cong \mathbb{Z} \left[\frac{1}{2} \right].$$

We have

$$\begin{aligned} G_0/H &= (\mathbb{Z}[x]/p_0(x)\mathbb{Z}[x])/\mathbb{Z}1 \\ &= (\mathbb{Z}[x]/(2x^2+x+1)\mathbb{Z}[x])/\mathbb{Z}1 \\ &= \mathbb{Z}[x]/((2x^2+x+1)\mathbb{Z}[x]+1\mathbb{Z}) \end{aligned}$$

as abelian groups. Let $(p(x))$ denote the residue class of the polynomial p in G_0/H .

Let

$$u_0 = (x) = (-2x^2) = 2u_1,$$

where $u_1 = (-x^2)$. Since

$$(2x^{n+1} + x^n + x^{n-1}) = 0,$$

we obtain

$$(x^n) = -(x^{n-1}) + 2(-x^{n+1})$$

for $n = 1, 2, \dots$. It follows by induction that the elements (x^n) are divisible by 2 for $n = 1, 2, \dots$ (this is not true for $n = 0$ by a use of Lemma 9.2.) Furthermore, we can find monic polynomials p_n of degree $n+1$ such that the sequence $u_n = (p_n(x))$ has the property

$$u_{n+1} = 2u_n$$

for all n . But then $\{1, p_0(x) = x, p_1(x) = -x^2, \dots, p_{2k-1}(x) = -x^2 + x^3 - \dots - x^{2k}, p_{2k}(x) = x^2 - x^3 + \dots - x^{2k+1}, \dots\}$ span all of $\mathbb{Z}[x]$, so u_0, u_1, \dots span all of G_0/H . It follows that

$$G_0/H \cong \mathbb{Z}[\frac{1}{2}].$$

Thus G_0 is an extension of the form

$$0 \longrightarrow \mathbb{Z} \longrightarrow G_0 \longrightarrow \mathbb{Z}[\frac{1}{2}] \longrightarrow 0.$$

In conclusion we have the exact diagram

$$\begin{array}{ccccccc} & & & & 0 & & \\ & & & & \downarrow & & \\ & & & & \mathbb{Z} & & \\ & & & & \downarrow & & \\ 0 & \longrightarrow & G_0 & \longrightarrow & K_0(\mathfrak{A}_L) & \xrightarrow{\tau} & \mathbb{Z}[\frac{1}{2}] \longrightarrow 0. \\ & & & & \downarrow & & \\ & & & & \mathbb{Z}[\frac{1}{2}] & & \\ & & & & \downarrow & & \\ & & & & 0 & & \end{array}$$

Example 18.2.

$$J_2 = \begin{pmatrix} 0 & 1 & 0 \\ 3 & 0 & 1 \\ 2 & 0 & 0 \end{pmatrix}$$

Again the Frobenius eigenvalue is 2 and the normalized solution of

$$\alpha J_2 = 2\alpha$$

is

$$\alpha = (1, \frac{1}{2}, \frac{1}{4}).$$

J_2 has eigenvalues $2, -1, -1$. With e_1, e_2 as before, J_2 leaves the subspace spanned by e_1 and e_2 invariant, and the matrix of the restriction is

$$\begin{pmatrix} -2 & 1 \\ -1 & 0 \end{pmatrix}.$$

The determinant is 1, and one computes that

$$e_1 + e_2 = \begin{pmatrix} 1 \\ -1 \\ -2 \end{pmatrix}$$

is the unique eigenvector with eigenvalue -1 . Using

$$f_1 = e_1 + e_2 = \begin{pmatrix} 1 \\ -1 \\ -2 \end{pmatrix}$$

and

$$f_2 = e_2 = \begin{pmatrix} 0 \\ 1 \\ -2 \end{pmatrix}$$

as basis instead, one computes that the matrix is

$$\begin{pmatrix} -1 & 1 \\ 0 & -1 \end{pmatrix}$$

and hence

$$\begin{pmatrix} -1 & 1 \\ 0 & -1 \end{pmatrix}^{-n} = (-1)^n \begin{pmatrix} 1 & n \\ 0 & 1 \end{pmatrix}$$

for $n = 0, 1, 2, \dots$. The right eigenvector of J_2 with eigenvalue 2 is

$$f_0 = \begin{pmatrix} 1 \\ 2 \\ 1 \end{pmatrix}.$$

Thus, if

$$\Delta = (f_0 \ f_1 \ f_2) = \begin{pmatrix} 1 & 1 & 0 \\ 2 & -1 & 1 \\ 1 & -2 & -2 \end{pmatrix},$$

then

$$\Delta^{-1} J_2 \Delta = \begin{pmatrix} 2 & 0 & 0 \\ 0 & -1 & 1 \\ 0 & 0 & -1 \end{pmatrix}$$

and

$$\Delta^{-1} J_2^{-n} \Delta = (\Delta^{-1} J_2 \Delta)^{-n} = \begin{pmatrix} 2^{-n} & 0 & 0 \\ 0 & (-1)^n & (-1)^n n \\ 0 & 0 & (-1)^n \end{pmatrix}.$$

Thus

$$J_2^{-n} = \Delta \begin{pmatrix} 2^{-n} & 0 & 0 \\ 0 & (-1)^n & (-1)^n n \\ 0 & 0 & (-1)^n \end{pmatrix} \Delta^{-1}.$$

We have

$$\Delta^{-1} = \frac{1}{9} \begin{pmatrix} 4 & 2 & 1 \\ 5 & -2 & -1 \\ -3 & 3 & -3 \end{pmatrix}.$$

Thus the dimension group as a subgroup of \mathbb{R}^3 is

$$\bigcup_{n=0}^{\infty} \frac{1}{9} \begin{pmatrix} 1 & 1 & 0 \\ 2 & -1 & 1 \\ 1 & -2 & -2 \end{pmatrix} \begin{pmatrix} 2^{-n} & 0 & 0 \\ 0 & (-1)^n & (-1)^n n \\ 0 & 0 & (-1)^n \end{pmatrix} \begin{pmatrix} 4 & 2 & 1 \\ 5 & -2 & -1 \\ -3 & 3 & -3 \end{pmatrix} \mathbb{Z}^3.$$

The range of the trace is $\alpha = (1, \frac{1}{2}, \frac{1}{4})$ applied to this set, which is

$$\bigcup_{n=0}^{\infty} \frac{1}{4} (1 \ 0 \ 0) \begin{pmatrix} 2^{-n} & 0 & 0 \\ * & * & * \\ * & * & * \end{pmatrix} \begin{pmatrix} 4 & 2 & 1 \\ * & * & * \\ * & * & * \end{pmatrix} \mathbb{Z}^3 = \bigcup_{n=0}^{\infty} (2^{-n} \ 2^{-n+1} \ 2^{-n-2}) \mathbb{Z}^3,$$

which is not unexpectedly the set of dyadic rationals. Since the determinant of the matrix $\begin{pmatrix} -1 & 1 \\ 0 & -1 \end{pmatrix}$ (or $\begin{pmatrix} -2 & 1 \\ -1 & 0 \end{pmatrix}$) is 1, this matrix defines a 1—1 map on the infinitesimal elements, so the group of infinitesimal elements is isomorphic to \mathbb{Z}^2 . Thus $K_0(\mathfrak{A}_L)$ is an extension

$$0 \hookrightarrow \mathbb{Z}^2 \hookrightarrow K_0(\mathfrak{A}_L) \xrightarrow{\tau} \mathbb{Z} \left[\frac{1}{2} \right] \longrightarrow 0.$$

We see that the dimension groups of the two examples 18.1 and 18.2 are non-isomorphic, so the algebras are non-isomorphic.

ACKNOWLEDGEMENTS. The authors are grateful to A. Kishimoto, K.-H. Kim, M. Laca, A. Laudal, and F. Roush for very helpful discussions, to B. Treadway and C. Wehr for excellent typesetting, and to B. Treadway for graphics production and programming, and for useful suggestions. We are especially thankful to Kim and Roush for permitting us to publish their proof of Theorem 17.18 via Lemmas 17.19 and 17.20, which they provided after seeing a preprint version of this memoir. The referee kindly offered suggestions as to how the subject could better be presented to a wider audience.

Bibliography

1. J.A. Ball and V. Vinnikov, *Functional models for representations of the Cuntz algebra*, preprint, 2002, Virginia Polytechnic Institute and State University.
2. ———, *Lax-Phillips scattering and conservative linear systems: A Cuntz-algebra multidimensional setting*, preprint, 2002, Virginia Polytechnic Institute and State University.
3. B. Blackadar, *K-theory for Operator Algebras*, MSRI Publication Series, vol. 5, Springer-Verlag, New York–Heidelberg–Berlin–Tokyo, 1986.
4. J.-B. Bost and A. Connes, *Hecke algebras, type III factors and phase transitions with spontaneous symmetry breaking in number theory*, *Selecta Math. (N.S.)* **1** (1995), 411–457.
5. M. Boyle and D. Handelman, *Algebraic shift equivalence and primitive matrices*, *Trans. Amer. Math. Soc.* **336** (1993), 121–149.
6. O. Bratteli, *Inductive limits of finite dimensional C^* -algebras*, *Trans. Amer. Math. Soc.* **171** (1972), 195–234.
7. ———, *AF-algebras and Bratteli diagrams*, *Lectures on Operator Algebras* (R. Bhat, G.A. Elliott, and P. Fillmore, eds.), *Fields Institute Monographs*, vol. 13, American Mathematical Society, Providence, 1999, pp. 175–180.
8. O. Bratteli, G.A. Elliott, and R.H. Herman, *On the possible temperatures of a dynamical system*, *Comm. Math. Phys.* **74** (1980), 281–285.
9. O. Bratteli and P.E.T. Jorgensen, *Endomorphisms of $\mathcal{B}(\mathcal{H})$, II: Finitely correlated states on \mathcal{O}_N* , *J. Funct. Anal.* **145** (1997), 323–373.
10. ———, *Isometries, shifts, Cuntz algebras and multiresolution wavelet analysis of scale N* , *Integral Equations Operator Theory* **28** (1997), 382–443.
11. ———, *Iterated function systems and permutation representations of the Cuntz algebra*, *Mem. Amer. Math. Soc.* **139** (1999), no. 663.
12. ———, *Wavelets through a Looking Glass: The World of the Spectrum*, *Applied and Numerical Harmonic Analysis*, Birkhäuser, Boston, 2002.
13. O. Bratteli, P.E.T. Jorgensen, K.H. Kim, and F. Roush, *Non-stationarity of isomorphism between AF algebras defined by stationary Bratteli diagrams*, *Ergodic Theory Dynam. Systems* **20** (2000), 1639–1656.
14. ———, *Decidability of the isomorphism problem for stationary AF-algebras and the associated ordered simple dimension groups*, *Ergodic Theory Dynam. Systems* **21** (2001), 1625–1655, corrigendum: **22** (2002), 633.
15. ———, *Computation of isomorphism invariants for stationary dimension groups*, *Ergodic Theory Dynam. Systems* **22** (2002), 99–127.
16. O. Bratteli, P.E.T. Jorgensen, and G.L. Price, *Endomorphisms of $\mathcal{B}(\mathcal{H})$* , *Quantization, Non-linear Partial Differential Equations, and Operator Algebra* (W. Arveson, T. Branson, and I. Segal, eds.), *Proc. Sympos. Pure Math.*, vol. 59, American Mathematical Society, Providence, 1996, pp. 93–138.
17. O. Bratteli and A. Kishimoto, *Trace scaling automorphisms of certain stable AF algebras, II*, *Q. J. Math.* **51** (2000), 131–154.
18. O. Bratteli and D.W. Robinson, *Operator Algebras and Quantum Statistical Mechanics*, 2nd ed., vol. I, Springer-Verlag, Berlin–New York, 1987.
19. ———, *Operator Algebras and Quantum Statistical Mechanics*, 2nd ed., vol. II, Springer-Verlag, Berlin–New York, 1996.
20. H.P. Cartan and S. Eilenberg, *Homological Algebra*, Princeton University Press, Princeton, New Jersey, 1956.
21. M. Choda, *Shifts on the hyperfinite II_1 -factor*, *J. Operator Theory* **17** (1987), 223–235.

22. ———, *Endomorphisms and automorphisms for factor inclusions*, Quantum and Non-Commutative Analysis (Kyoto, 1992), Math. Phys. Stud., vol. 16, Kluwer Acad. Publ., Dordrecht, 1993, pp. 291–304.
23. ———, *Canonical $*$ -endomorphisms and simple C^* -algebras*, J. Operator Theory **33** (1995), 235–248.
24. A. Connes, *Une classification des facteurs de type III*, Ann. Sci. Ecole Norm. Sup. (4) **6** (1973), 133–252.
25. ———, *Periodic automorphisms of hyperfinite factors of type II_1* , Acta Sci. Math. **39** (1977), 39–66.
26. J. Cuntz, *Simple C^* -algebras generated by isometries*, Comm. Math. Phys. **57** (1977), 173–185.
27. ———, *Automorphisms of certain simple C^* -algebras*, Quantum Fields—Algebras, Processes (Bielefeld, 1978) (L. Streit, ed.), Springer-Verlag, Vienna–New York, 1980, pp. 187–196.
28. X. Dai and D.R. Larson, *Wandering vectors for unitary systems and orthogonal wavelets*, Mem. Amer. Math. Soc. **134** (1998), no. 640.
29. K.R. Davidson, *C^* -algebras by Example*, Fields Institute Monographs, vol. 6, American Mathematical Society, Providence, 1996.
30. J. Dixmier, *On some C^* -algebras considered by Glimm*, J. Funct. Anal. **1** (1967), 182–203.
31. S. Doplicher and J.E. Roberts, *Duals of compact Lie groups realized in the Cuntz algebras and their actions on C^* -algebras*, J. Funct. Anal. **74** (1987), 96–120.
32. E.G. Effros, *Dimensions and C^* -algebras*, CBMS Regional Conf. Ser. in Math., vol. 46, Conference Board of the Mathematical Sciences, Washington, 1981.
33. E.G. Effros, D. Handelman, and Chao Liang Shen, *Dimension groups and their affine representations*, Amer. J. Math. **102** (1980), 385–407.
34. G.A. Elliott, *On the classification of inductive limits of sequences of semisimple finite-dimensional algebras*, J. Algebra **38** (1976), 29–44.
35. D.E. Evans, *On \mathcal{O}_N* , Publ. Res. Inst. Math. Sci. **16** (1980), 915–927.
36. ———, *Gauge actions on \mathcal{O}_A* , J. Operator Theory **7** (1982), 79–100.
37. D.E. Evans and J.D. Gould, *Dimension groups and embeddings of graph algebras*, Internat. J. Math. **5** (1994), 291–327.
38. D.E. Evans and Y. Kawahigashi, *Quantum Symmetries on Operator Algebras*, Oxford Mathematical Monographs, Oxford Science Publications, The Clarendon Press, Oxford University Press, New York, 1998.
39. D.E. Evans and A. Kishimoto, *Trace scaling automorphisms of certain stable AF algebras*, Hokkaido Math. J. **26** (1997), 211–224.
40. R. Exel, *KMS states for generalized gauge actions on Cuntz-Krieger algebras (An application of the Ruelle-Perron-Frobenius Theorem)*, preprint, 2001, Universidade Federal de Santa Catarina, arXiv:math.OA/0110183.
41. R. Exel and M. Laca, *Cuntz-Krieger algebras for infinite matrices*, J. Reine Angew. Math. **512** (1999), 119–172.
42. ———, *The K -theory of Cuntz-Krieger algebras for infinite matrices*, K -Theory **19** (2000), 251–268.
43. R. Exel and A. Vershik, *C^* -algebras of irreversible dynamical systems*, preprint, 2002, Universidade Federal de Santa Catarina, Russian Academy of Sciences, arXiv:math.OA/0203185.
44. G. Frobenius, *Über Matrizen aus positiven Elementen*, Sitzungsber. Preuß. Akad. Wiss. Physikal.-Math. Kl. (1908), 471–476, (1909), 514–518.
45. C. Frougny and B.M. Solomyak, *Finite beta-expansions*, Ergodic Theory Dynam. Systems **12** (1992), 713–723.
46. F.R. Gantmacher, *Applications of the Theory of Matrices*, Interscience Publishers, New York–London, 1959.
47. J. Glimm, *On a certain class of operator algebras*, Trans. Amer. Math. Soc. **95** (1960), 318–340.
48. K.R. Goodearl and D.E. Handelman, *Classification of ring and C^* -algebra direct limits of finite-dimensional semisimple real algebras*, Mem. Amer. Math. Soc. **69** (1987), no. 372.
49. Frederick M. Goodman, Pierre de la Harpe, and Vaughan F.R. Jones, *Coxeter graphs and towers of algebras*, Springer-Verlag, New York, 1989.
50. D. Handelman, *Positive matrices and dimension groups affiliated to C^* -algebras and topological Markov chains*, J. Operator Theory **6** (1981), 55–74.

51. ———, *Spectral radii of primitive integral companion matrices and log concave polynomials*, Symbolic Dynamics and Its Applications (New Haven, CT, 1991) (P. Walters, ed.), Contemp. Math., vol. 135, American Mathematical Society, Providence, 1992, pp. 231–237.
52. R.H. Herman, I.F. Putnam, and C.F. Skau, *Ordered Bratteli diagrams, dimension groups and topological dynamics*, Internat. J. Math. **3** (1992), 827–864.
53. M. Izumi, *Subalgebras of infinite C^* -algebras with finite Watatani indices, I: Cuntz algebras*, Comm. Math. Phys. **155** (1993), 157–182.
54. P.E.T. Jorgensen, *Ruelle operators: Functions which are harmonic with respect to a transfer operator*, Mem. Amer. Math. Soc. **152** (2001), no. 720.
55. Y. Katayama, K. Matsumoto, and Y. Watatani, *Simple C^* -algebras arising from β -expansions of real numbers*, Ergodic Theory Dynam. Systems **18** (1998), 937–962.
56. M. Keane, *Strongly mixing g -measures*, Invent. Math. **16** (1972), 309–324.
57. K.H. Kim and F.W. Roush, *Williams’s conjecture is false for reducible subshifts*, J. Amer. Math. Soc. **5** (1992), 213–215.
58. K.H. Kim and F.W. Roush, *The Williams conjecture is false for irreducible subshifts*, Ann. of Math. (2) **149** (1999), 545–558; short version in Electronic Research Announcements of the American Mathematical Society **3** (1997), 105–109 (electronic).
59. A. Kishimoto and A. Kumjian, *Simply stably projectionless C^* -algebras arising as crossed products*, Canad. J. Math. **48** (1996), 980–996.
60. ———, *Crossed products of Cuntz algebras by quasi-free automorphisms*, Operator algebras and their applications (Waterloo, ON, 1994/1995) (P.A. Fillmore and J.A. Mingo, eds.), Fields Institute Communications, vol. 13, American Mathematical Society, Providence, 1997, pp. 173–192.
61. W. Krieger, *On dimension functions and topological Markov chains*, Invent. Math. **56** (1980), 239–250.
62. M. Laca, *Semigroups of $*$ -endomorphisms, Dirichlet series and phase transitions*, J. Funct. Anal. **152** (1998), 330–378.
63. D. Lind and B. Marcus, *An Introduction to Symbolic Dynamics and Coding*, Cambridge University Press, Cambridge, 1995.
64. S. Mac Lane, *Homology*, Die Grundlehren der mathematischen Wissenschaften, vol. 114, Springer-Verlag, Berlin–New York, 1967.
65. D.K. Maslen and D.N. Rockmore, *The Cooley-Tukey FFT and group theory*, Notices Amer. Math. Soc. **48** (2001), 1151–1160.
66. D. Mundici and G. Panti, *The equivalence problem for Bratteli diagrams*, version 1, Mathematical Report n. 259, University of Siena, 1993; version 2, preprint, 1998.
67. E. Nelson, *Topics in dynamics, I: Flows*, Mathematical Notes, Princeton University Press, Princeton, New Jersey, 1969.
68. M. Newman, *Integral Matrices*, Pure and Applied Mathematics, vol. 45, Academic Press, New York–London, 1972.
69. D. Olesen and G.K. Pedersen, *Some C^* -dynamical systems with a single KMS state*, Math. Scand. **42** (1978), 111–118.
70. V. Ostrovskiy and Yu. Samoilenko, *Introduction to the Theory of Representations of Finitely Presented $*$ -Algebras, I: Representations by bounded operators*, Reviews in Mathematics and Mathematical Physics, vol. 11, part 1, Harwood Academic Publishers, Gordon & Breach, address unknown, 1999.
71. W. Parry, *On the β -expansions of real numbers*, Acta Math. Acad. Sci. Hungar. **11** (1960), 401–416.
72. ———, *Skew products of shifts with a compact Lie group*, J. London Math. Soc. (2) **56** (1997), 395–404.
73. W. Parry and M. Pollicott, *The Livsic cocycle equation for compact Lie group extensions of hyperbolic systems*, J. London Math. Soc. (2) **56** (1997), 405–416.
74. O. Perron, *Zur Theorie der Matrizes*, Math. Ann. **64** (1907), 248–263.
75. M. Pimsner and D. Voiculescu, *Imbedding of the irrational rotation algebra into an AF-algebra*, J. Operator Theory **4** (1980), 201–210.
76. R.T. Powers, *Representations of uniformly hyperfinite algebras and their associated von Neumann rings*, Ann. of Math. (2) **86** (1967), 138–171.
77. ———, *An index theory for semigroups of $*$ -endomorphisms of $\mathcal{B}(\mathcal{H})$ and type II₁ factors*, Canad. J. Math. **40** (1988), 86–114.

78. J. Renault, *A Groupoid Approach to C^* -algebras*, Lecture Notes in Mathematics, vol. 793, Springer-Verlag, Berlin–Heidelberg–New York, 1980.
79. A. Rényi, *Representations for real numbers and their ergodic properties*, Acta Math. Acad. Sci. Hungar. **8** (1957), 477–493.
80. M. Rørdam, F. Larsen, and N.J. Laustsen, *An Introduction to K -theory for C^* -algebras*, Cambridge University Press, Cambridge, 2000.
81. D. Ruelle, *The thermodynamic formalism for expanding maps*, Comm. Math. Phys. **125** (1989), 239–262.
82. D. Ruelle, *Dynamical zeta functions and transfer operators*, Notices Amer. Math. Soc. **49** (2002), 887–895.
83. P.W. Shor, *Polynomial-time algorithms for prime factorization and discrete logarithms on a quantum computer*, SIAM J. Comput. **26** (1997), 1484–1509.
84. ———, *Polynomial-time algorithms for prime factorization and discrete logarithms on a quantum computer*, SIAM Rev. **41** (1999), 303–332.
85. E. Størmer, *The even CAR-algebra*, Comm. Math. Phys. **16** (1970), 136–137.
86. Ş. Strătilă, *Modular Theory in Operator Algebras*, Editura Academiei Republicii Socialiste Romania, Bucharest, and Abacus Press, Tunbridge Wells, 1981.
87. A. Török, *AF-algebras with unique trace*, Acta Sci. Math. (Szeged) **55** (1991), 129–139.
88. Y. Ueda and Y. Watatani, *A relation between certain interpolated Cuntz algebras and interpolated free group factors*, Proc. Amer. Math. Soc. **128** (2000), 1397–1404.
89. A.M. Veršik, *Uniform algebraic approximation of shift and multiplication operators*, Soviet Math. Dokl. (1) **24** (1981), 97–100, translation of Докл. Акад. Наук СССР **259** (1981), 526–529 (Russian).
90. ———, *A theorem on periodical Markov approximation in ergodic theory*, Ergodic Theory and Related Topics (Vitte, 1981) (H. Michel, ed.), Mathematical Research, vol. 12, Akademie-Verlag, Berlin, 1982, pp. 195–206.
91. J.B. Wagoner, *Strong shift equivalence theory and the shift equivalence problem*, Bull. Amer. Math. Soc. (N.S.) **36** (1999), 271–296.
92. Y. Watatani, *Index for C^* -subalgebras*, Mem. Amer. Math. Soc. **83** (1990), no. 424.
93. R.F. Williams, *Classification of subshifts of finite type*, Ann. of Math. (2) **98** (1973), 120–153, errata, *ibid.* **99** (1974), 380–381.
94. P. Wojtaszczyk, *A Mathematical Introduction to Wavelets*, London Mathematical Society Student Texts, vol. 37, Cambridge University Press, Cambridge, 1997.

List of Figures

1	$d = 2; L_1 = 1, L_2 = 1; \beta = \ln 2.$	24
2	$d = 2; L_1 = 1, L_2 = 2; \beta = -\ln((\sqrt{5} - 1)/2).$ Then the Bratteli diagram is given by the Fibonacci sequence. Detail on the right shows the multi-indices for each node in the top five rows.	25
3	$d = 4; L = \{4, 4, 5, 8\};$ first matrix column = $(0\ 0\ 0\ 2\ 1\ 0\ 0\ 1)^t;$ $\beta = -\ln x$ where $x = (-2 + \sqrt[3]{100 + 12\sqrt{69}} + \sqrt[3]{100 - 12\sqrt{69}})/6 \approx 0.7549$ solves $2x^4 + x^5 + x^8 = 1.$ (Actually x solves $x^2 + x^3 = 1.$) See the $n = 5$ case in Example 5.3.	26
4	$d = 2; L = \{2, 3\};$ first matrix column = $(0\ 1\ 1)^t;$ $\beta = -\ln x$ where $x > 0$ solves $x^2 + x^3 = 1.$ Detail on the right shows the multi-indices for each node in the top five rows. See the proof of Lemma 4.6.	27
5	$d = 3; L = \{2, 3, 5\};$ first matrix column = $(0\ 1\ 1\ 0\ 1)^t;$ $\beta = -\ln x$ where $x > 0$ solves $x^2 + x^3 + x^5 = 1.$	28
6	Illustration of procedure in proof of Lemma 4.6, with $d = 3,$ $L = \{1, 2, 4\}.$ Compare with Figure 7 and Example 4.7.	31
7	$d = 3; L = \{1, 2, 4\};$ first matrix column = $(1\ 1\ 0\ 1)^t.$ Compare with Figure 6 and Example 4.7.	32
8	$L = \{2, 2, 3\};$ levels 1–4. Compare Figures 8, 9, and 10 with Figure 11.	33
9	$L = \{2, 2, 3\};$ levels 5–6.	34
10	$L = \{2, 2, 3\};$ level 7.	35
11	$d = 3; L = \{2, 2, 3\};$ first matrix column = $(0\ 2\ 1)^t.$ Compare with Figures 8, 9, and 10.	36
12	$d = 6; L = \{1, 3, 3, 3, 4, 4\}$ (left), $L = \{2, 2, 2, 3, 4, 4\}$ (right). These define non-isomorphic algebras (see Chapter 16).	39
13	Incidence matrix.	40
14	$L = \{5, 5, 6, 6, 7\}$ (top left), $\{3, 5, 6, 7\}$ (bottom left), and $\{3, 3, 7\}$ (right), illustrating the $n = 4$ case in Example 5.3. These represent isomorphic algebras.	53

- 15 $L = \{1, 1, 1, 1, \underbrace{2, \dots, 2}_{32}\}$, first column = $(4 \ 32)^t$ (left);
 $L = \{1, 1, 1, 1, 1, 1, \underbrace{2, \dots, 2}_{16}\}$, first column = $(6 \ 16)^t$ (right). See
 (10.11). These diagrams represent isomorphic algebras. 89
- 16 The (nonexistent) matrices ψ_n in the proof of Observation 11.2
 (example with $k = 3$). 94
- 17 $L = \{\underbrace{1, \dots, 1}_{12}, 2, 2, 2, 2, 2\}$, first column = $(12 \ 6)^t$ (left);
 $L = \{\underbrace{1, \dots, 1}_{24}, \underbrace{2, \dots, 2}_{12}\}$, first column = $(24 \ 12)^t$ (right). See
 Example 13.5. These diagrams represent isomorphic algebras. 123
- 18 Examples from lattice points: $\frac{dL_2}{dL_1} = -x^{L_1-L_2}$. 130
- 19 $L = \{2, 2, 3, 3, 4, 4, 4, 4\}$; first column = $(0 \ 2 \ 2 \ 4)^t$ (left);
 $L = \{3, 3, 3, 3, 3, 3, 4, 4, 4, 4\}$; first column = $(0 \ 0 \ 6 \ 4)^t$ (center);
 $L = \{3, 3, 3, 3, 4, 4, 4, 4, 4, 4, 4, 4\}$; first column = $(0 \ 0 \ 4 \ 8)^t$
 (right): The three isomorphic algebras in the final summary of
 Chapter 16 (see (16.9)). 140
- 20 $L = \{1, 2, 2, 3, 3, 3, 3, 3, 3, 3, 3, 3, 4, 4, 4\}$, first column
 = $(1 \ 2 \ 11 \ 3)^t$ (left); $L = \{2, 2, 2, 2, 2, 2, 2, 2, 3, 3, 4, 4, 4\}$, first
 column = $(0 \ 8 \ 2 \ 3)^t$ (right). See (17.55)–(17.61). These diagrams
 represent isomorphic AF-algebras. 154

List of Tables

1	Parameters for Examples A and B in (11.5)–(11.6).	91
2	Prim invariants for various \mathfrak{A}_L algebras with $\text{rank}(K_0(\mathfrak{A}_L)) = 2$.	124
3	Some parameters related to invariants for various \mathfrak{A}_L algebras.	126
4	The specimens in Group 2 for Rank 4.	136

List of Terms and Symbols

Term or Symbol	Usage	Page
AF-algebra		vi, ix, x, xi, 21
Bratteli diagram		x, 23, 37, 38, 54
dimension group		vii, x, 45
matrix units		29
Perron–Frobenius theorem		38
$\#_j(\alpha) = \#\{\alpha_i \mid \alpha_i = j\}$	count	22
$[\mathbb{1}]$	unit in $K_0(\mathfrak{A}_L)$	48
$a := \lambda^{-1} = e^{-\beta}$	inverse Perron–Frobenius eigenvalue	62
$\mathfrak{A}_L = \mathfrak{A}_J = \mathcal{O}_d^{\sigma^L}(0)$	the AF-algebra with symbol list $L = \{L_1, \dots, L_d\}$ and matrix J	xi, 19, 20
$A_n := \{(\alpha) \mid \alpha \in L^{-1}(n) \cup E_n\}$	family of projections	30
$\mathfrak{A}_n = \bigoplus_{k=0}^{L_d-1} \mathfrak{A}^{(n,k)}$	direct sum decomposition of \mathfrak{A}_n	37
$D(\mathfrak{A}_L) =$ $(K_0(\mathfrak{A}_L), K_0(\mathfrak{A}_L)_+, [\mathbb{1}])$	dimension group	xii, 45, 48, 49, 85
$\mathcal{D}_d \cong C(\prod_1^\infty \mathbb{Z}_d) =$ $C^*(s_\alpha s_\alpha^* \mid \alpha \in \prod_1^\infty \mathbb{Z}_d)$	abelian subalgebra of diagonal elements	xi, 8, 19
deg	scaling degree	48, 96, 98, 99
$\det(t\mathbb{1} - J) = t^N - m_1 t^{N-1} -$ $m_2 t^{N-2} - \dots - m_{N-1} t - m_N$	characteristic polynomial of J	58
$D_n(G) = \bigcap_i n^i G$	the elements of G infinitely divisible by n	105, 143
$e_j := x^j p_a(x)$	basis for $\{\alpha\}^\perp \cap \mathbb{Z}^N$	64
$E_n = \{\gamma \mid \gamma = (\alpha i) \text{ where}$ $L(\alpha) < n \text{ and } L(\alpha) + L_i > n\}$	complementary set of projections	30
$E_n(m) =$ $\{\gamma \in E_n \mid L(\gamma) = n + m\}$	indexed complementary set of projections	37

$\text{Ext}(\tau(K_0(\mathfrak{A}_L)), \ker \tau)$	the Ext-functor	85
Ext-groups		86
\mathbb{F}_d	free group on d generators	13
$F_L := G_L/\mathbb{Z}^N$	a torsion group quotient	92, 104, 109
$f_m(x) := m_1 + m_2x + \cdots + m_Nx^{N-1} = q_m(x)p_a(x) + r_m(x)$	characteristic polynomial	62, 62, 63
$G = K_0(\mathfrak{A}_L)$	K_0 group	141
$G_0 = \ker \tau \cong \mathbb{Z}[x]/(p_0(x))$	kernel of trace $\tau =$ infinitesimal elements in G	45, 49, 74, 77, 77, 78, 78, 113, 133, 135, 136, 137, 138, 162
$g_i = \begin{cases} J^{-i}e_N & \text{if } i = 1, 2, \dots \\ e_{i+N} & \text{if } i = 1 - N, \dots, -1, 0 \end{cases}$		81
$G_i := J^{-i}\mathbb{Z}^N$	indexed subgroups in G_J	95
$G_J = \bigcup_n J^{-n}\mathbb{Z}^N$	inductive limit group	95
$(G(L), (\sigma_L)_*)$	shift dynamical system	55
$\text{grade}(s_\alpha s_\gamma^*) = L(\alpha)$ if $L(\alpha) = L(\gamma)$	grade function on monomials	23
$\mathcal{H} = \int_\Omega^\oplus \mathcal{H}(x) d\mu(x)$	direct integral of Hilbert spaces	5, 6, 7, 12
\mathcal{H}_-	closed linear span in $\ell^2(\mathbb{F}_d)$ of the vectors $\{\lambda(s^{-1})\xi_e \mid s \in \mathbb{S}_d\}$	15, 17
\mathcal{H}_{Ω_0}	cyclic subspace of the representation of \mathcal{O}_d induced from the state $\omega_{(p)}(s_\alpha s_\gamma^*) = p_\alpha \delta_{\alpha\gamma}$	15, 15, 17
\mathcal{H}_{ω_p}	Hilbert space of the state ω_p	xii
$I(J) = \sum_{i=1}^N v_i \lambda^{N-i} = \lambda^{N-1} \langle \alpha v \rangle$	invariant	xii, 143

$J = J_m = J_L =$	matrix with integer entries m_i with $m_N \neq 0$ and $\gcd\{i \mid m_i \neq 0\} = 1$	51, 58, 61, 87, 90, 127, 131
$\begin{pmatrix} m_1 & 1 & 0 & \cdots & 0 & 0 \\ m_2 & 0 & 1 & \cdots & 0 & 0 \\ \vdots & & \ddots & \ddots & \vdots & \vdots \\ m_{N-2} & 0 & & \ddots & 1 & 0 \\ m_{N-1} & 0 & 0 & & 0 & 1 \\ m_N & 0 & 0 & \cdots & 0 & 0 \end{pmatrix}$		
$J_0 =$	matrix of form similar to J	77, 80
$\begin{pmatrix} q_1 & 1 & 0 & \cdots & 0 & 0 \\ q_2 & 0 & 1 & \cdots & 0 & 0 \\ \vdots & & \ddots & \ddots & \vdots & \vdots \\ q_{M-2} & 0 & & \ddots & 1 & 0 \\ q_{M-1} & 0 & 0 & & 0 & 1 \\ q_M & 0 & 0 & \cdots & 0 & 0 \end{pmatrix}$		
$J_L = \left(\begin{array}{c c} J_0 & Q \\ \hline 0 & J_D \end{array} \right)$	triangular representation of matrix J	61, 66, 67, 76
$J^{-1} = \left(\begin{array}{c c} J_0^{-1} & -J_0^{-1}QJ_R^{-1} \\ \hline 0 & J_R^{-1} \end{array} \right)$	triangular representation of J^{-1}	66
$\langle k \mid \alpha \rangle = \sum_{i=1}^N k_i a^{i-1} = f_k(a)$	inner product	63
$K_0(\mathfrak{A}_L)$	the K_0 group of \mathfrak{A}_L (see G)	xii, 45, 47, 49, 72, 80, 85, 85, 111
$K_0(\mathfrak{A}_L)_+ = \{0\} \cup \{v \in K_0(\mathfrak{A}_L) \mid \langle \alpha \mid v \rangle > 0\}$	positive elements of $K_0(\mathfrak{A})$	45, 49
$\ker \tau$	kernel of $\tau =$ infinitesimal elements of G	xii, 49, 66, 68, 77, 80, 85, 111, 162, 165
$L = \{L_1, \dots, L_d\}$	list of symbols	xii
$L(\alpha) = \sum_{j=1}^d \#_j(\alpha) L_j = \sum_{m=1}^k L_{\alpha_m}$	weight function	22, 29
\mathcal{L}	inductive limit lattice	74, 83
\mathcal{L}_k	lattice with index	xii, 83
$L^{-1}(n) = \{\alpha \mid L(\alpha) = n\}$	projections with specified L -number	29
$M_d = M_d(\mathbb{C})$	algebra of $d \times d$ complex matrices	12

m -deg	m -scaling degree	48, 96, 99
$M_f = \int_{\Omega}^{\oplus} f(x) \mathbb{1}_{\mathcal{H}(x)} d\mu(x)$	representation of f in \mathcal{H}	10
$m_N = \det J $		110, 141
\mathcal{O}_d	the Cuntz algebra	xi, 3, 6, 12, 18, 19
$\mathcal{O}_d^{\sigma^L}(n) = \mathcal{O}_d^{\sigma}(n) = \{x \in \mathcal{O}_d \mid \sigma_t^{(L)}(x) = e^{int}x\}$	spectral subspaces	20
$\mathcal{O}_d^{\mathbb{T}} = \text{UHF}_d$	fixed-point algebra of the gauge action of \mathbb{T}	19
$\mathcal{O}_d^{\mathbb{T}^d} = \text{GICAR}_d$	\mathbb{T}^d -gauge-invariant elements of \mathcal{O}_d	19
$\mathcal{P} = \left\{ \sum_{k=1}^d n_k L_k \mid n_k \in \mathbb{N} \cup \{0\} \right\}$	semigroup generated by L_1, \dots, L_d	38
$p_0(x) = \sum_{j=1}^M q_j x^j - 1$	q_M times the characteristic polynomial of J_0^{-1}	77, 136, 138
$p_a(x) = x^D p_{\lambda}\left(\frac{1}{x}\right)$	minimal polynomial of inverse of Perron–Frobenius eigenvalue a	63
$p^{\alpha} = p_{\alpha_1} p_{\alpha_2} \cdots p_{\alpha_k}$	monomials	23
$p_j = e^{-\beta L_j}$	probability weights	xii, 13, 23
$p_{\lambda}(x) = x^D p_a\left(\frac{1}{x}\right), a = \frac{1}{\lambda}$	minimal polynomial of Perron–Frobenius eigenvalue λ	63
$p_L(x) = \sum_{j=1}^N m_j x^j - 1 = p_0(x) p_a(x)$	$ \det J $ times the characteristic polynomial of J^{-1}	49, 51, 76, 127, 128, 129, 131
$\text{Prim}(n)$	the set of prime factors of n	xii, 67, 105, 107, 108, 116, 133, 139
$\text{Prim}(m_N)$	the set of prime factors of $m_N = \det J $	67
$\text{Prim}(Q_{N-D})$	the set of prime factors of Q_{N-D}	67
$\text{Prim}(R_D)$	the set of prime factors of $R_D = \det J_R $	67
$q_m(x) = \sum_{k=1}^{N-D} Q_k x^{k-1}$	special polynomial	63
rank	rank of an abelian group	105, 107
$r_m(x) = \sum_{k=1}^D R_k x^{k-1}$	residue polynomial	63, 64
s_i	generators of \mathcal{O}_d	xi

$s_\alpha = s_{\alpha_1} s_{\alpha_2} \cdots s_{\alpha_n}$	monomial in \mathcal{O}_d	9, 22
\mathbb{S}_d	free semigroup	15
S_i	operators representing s_i	5, 13
S_i^*	adjoint operators of S_i	5
$S_\alpha = S_{\alpha_1} S_{\alpha_2} \cdots S_{\alpha_n}$	monomial of operators	9, 13
\mathbb{T}^d	the d -torus	18
$U = \sum_{i=1}^d S_i T_i^* = \int_{\Omega}^{\oplus} U(x) d\mu(x)$	intertwining unitary having decomposition	10, 11
$\text{UHF}_d \cong \otimes_1^{\infty} M_d$	uniformly hyperfinite C^* -algebra	13
$v = \begin{pmatrix} 1 \\ \lambda - m_1 \\ \lambda^2 - m_1\lambda - m_2 \\ \lambda^3 - m_1\lambda^2 - m_2\lambda - m_3 \\ \vdots \\ \lambda^{N-1} - \dots - m_{N-2}\lambda - m_{N-1} \end{pmatrix}$	Perron–Frobenius right eigenvector: $Jv = \lambda v$	xiii, 40, 90, 128, 142
$\mathcal{V}_N := \{f(x) \in \mathbb{Z}[x] \mid \deg f \leq N-1\} \cong \mathbb{Z}^N$	representation of special elements of G	62, 62
$x_i = g_i \pmod{\mathbb{Z}^N}$	generators of the group $F_J := G_J / \mathbb{Z}^N$	81, 104, 109
$\mathbb{Z}[\frac{1}{\lambda}]$	ring generated by 1 and $\frac{1}{\lambda}$	121, 141
$\mathbb{Z}_d = \{1, \dots, d\}$	set of d elements	xii
\mathbb{Z}^N	rank- N integer lattice	62
$\alpha = (\alpha_1 \alpha_2 \dots \alpha_n)$	multi-index	9
$\alpha = (1, a, a^2, \dots, a^{N-1}) = (1, e^{-\beta}, e^{-2\beta}, \dots, e^{-(N-1)\beta})$	Perron–Frobenius left eigenvector: $\langle \alpha J = \lambda \langle \alpha $	xiii, 46, 47, 50, 62, 90, 145, 147,
$\beta = (a, a^2, \dots, a^{N-1}) = (\frac{1}{\lambda}, \frac{1}{\lambda^2}, \dots, \frac{1}{\lambda^{N-1}})$	foreshortened vector	145, 147
λ	Perron–Frobenius eigenvalue of J	xii, 29, 40, 58, 61
$\Lambda = \left(\theta \begin{pmatrix} 1 \\ 0 \\ \vdots \\ 0 \end{pmatrix}, \theta \begin{pmatrix} 0 \\ 1 \\ \vdots \\ 0 \end{pmatrix}, \dots, \theta \begin{pmatrix} 0 \\ 0 \\ \vdots \\ 1 \end{pmatrix} \right)$	matrix implementing isomorphism θ between dimension groups: $\theta(g) = \Lambda g$	97, 98, 143, 153

$\xi: \Lambda \mathbf{v} = \xi \mathbf{v}'$	element of $\mathbb{Z} \left[\frac{1}{\lambda} \right]$ with multiplicative inverse	143
σ	right shift on Ω	3
σ_i	sections of σ	3
$\sigma_t^L(s_j) = \exp(itL_j) s_j =$ $\sigma(e^{itL_1}, \dots, e^{itL_d})(s_j)$	one-parameter group σ^L of *-automorphisms of \mathcal{O}_d	xii, 18, 22
(σ^L, β) -KMS state	also β -KMS state	xii, 13, 18
τ	trace on $K_0(\mathfrak{A}_L)$	48
$\tau(g) = \langle \alpha g \rangle$	trace on $K_0(\mathfrak{A}_L)$ or on \mathfrak{A}_L	46
$\tau(v) = \langle \alpha v \rangle$	inner product of left and right Perron–Frobenius vectors	xiii, 144
$\omega = \omega_p$	state given by p (see p_j)	xii
$\omega(s_\alpha s_\gamma^*) = \delta_{\alpha\gamma} e^{-\beta \sum_{k=1}^{ \alpha } L_{\alpha_k}}$	KMS state	18
$\Omega = \prod_1^\infty \mathbb{Z}_d$	product space	3, 13
$\Omega_i = \sigma_i(\Omega)$	partition of the product space Ω into clopen sets	3
Ω_0	cyclic vector	15, 17