

# On the groupoid of transformations of rigid structures on surfaces \*

Louis Funar

Răzvan Gelca

*Institut Fourier BP 74*

*Department of Mathematics, 2072 East Hall*

*University of Grenoble I*

*University of Michigan*

*38402 Saint-Martin-d'Hères cedex, France*

*Ann Arbor MI 48109, USA*

*e-mail: funar@fourier.ujf-grenoble.fr*

*e-mail: rgelca@math.lsa.umich.edu*

## Abstract

We prove that the 2-groupoid of transformations of rigid structures on surfaces has a finite presentation, establishing a result first conjectured by Moore and Seiberg. We also show that a finite dimensional, unitary, cyclic topological quantum field theory gives rise to a representation of this 2-groupoid.

AMS Classification: 57 N 10, 57 M 25, 16 A 46.

Keywords: Mapping class groups, rigid structures, duality groupoid, DAP decompositions, TQFT.

## Contents

<b>1</b>	<b>Introduction</b>	<b>2</b>
<b>2</b>	<b>2-groupoids</b>	<b>3</b>
2.1	Algebraic definitions . . . . .	3
2.2	The geometric point of view . . . . .	6
<b>3</b>	<b>The Moore-Seiberg equations</b>	<b>7</b>
3.1	Main results . . . . .	7
3.2	Topological interpretation of the generators and relations . . . . .	8
3.3	The 2-complex $\Gamma$ . . . . .	9

---

\*First version: November 9, 1997. This version: June 30, 1999. This preprint is available electronically at <http://www-fourier.ujf-grenoble.fr/~funar>

<b>4</b>	<b>Proof that Moore-Seiberg equations are sufficient</b>	<b>11</b>
4.1	Elements of Cerf theory . . . . .	11
4.2	The groupoid of markings . . . . .	14
4.3	Reduction to fundamental moves and relations . . . . .	15
4.4	Overmarkings . . . . .	25
4.5	Rigid structures . . . . .	30
<b>5</b>	<b>TQFT and representations of the duality groupoid</b>	<b>32</b>
5.1	Three-dimensional TQFT's . . . . .	32
5.2	Representations of the mapping class group and TQFT . . . . .	33
5.3	Proof of Theorem 3.2 . . . . .	34

# 1 Introduction

Three dimensional topological quantum field theories (TQFT's) give rise to representations of the mapping class groups of closed surfaces. TQFT's with corners give rise to representations of a related object, the 2-groupoid of transformations of rigid structures. Rigid structures (also called DAP-decompositions in [9, 12, 28]) are decompositions of surfaces into disks, annuli and pairs of pants, together with additional information for keeping track of twistings.

The 2-groupoid of transformations of rigid structures appeared for the first time in the works of physicists studying 2-dimensional conformal field theories. Specifically G. Moore and N. Seiberg (see [23]) worked with this groupoid and conjectured a presentation of it. In an unpublished preprint [28], K. Walker sketched some ideas for the proof that the presentation given by Moore and Seiberg is complete. As Walker pointed out, the Moore-Seiberg equations represent compatibility conditions that the basic data of a TQFT with corners must satisfy. Based on Walker's point of view, several TQFT's with corners have been constructed so far [9, 12, 13]. In a TQFT with corners the quantum invariants of 3-manifolds are computed from an initial amount of information, by making use of the axioms. Of course this initial amount of information, called basic data, must satisfy the above mentioned compatibility conditions. Hence the necessity for a rigorous proof of the fact that the Moore-Seiberg equations are complete. This is the purpose of the present paper. In addition to this we also show how a maximal TQFT (i.e. one that has an underlying theory with corners), gives rise in a canonical way to a representation of the 2-groupoid.

The idea of the proof is to apply the Cerf theoretic techniques used by A. Hatcher and W. Thurston [17] for obtaining a presentation of the mapping class group of a surface. Let us mention that an explicit presentation for the mapping class group was derived afterwards by B. Wajnryb (see [29, 5]) and a more symmetric (but infinite) presentation was given by S. Gervais ([14]).

The proof given below is done in three steps. First we exhibit a presentation for the groupoid of transformations of markings (maximal collections of non-isotopic simple closed curves in the interior of a surface). Then we explain how this presentation produces a presentation of the groupoid of overmarkings (collection of curves cutting a surface in disks, annuli and pairs of pants). Finally, we use Walker's approach to solve the case of rigid structures. The last

part of the paper describes the construction of the canonical representations of the 2-groupoid that arise from TQFT's for which the mapping class group acts in a homogeneous manner. We mention that our initial result for the case of the complex associated to cut systems was obtained independently in [16], using the same methods. After this paper appeared in preprint form we learned about the work of Bakalov and Kirillov Jr. [2] in which a different proof for the main result is given. Although their proof is still based on the Hatcher-Thurston ideas, the authors avoided the direct use of Cerf's theory and use instead results from [15] about cut systems.

Before proceeding with the details of the paper, we want to make some remarks. The 2-groupoid of transformations of rigid structures is a universal object containing the mapping class groups of all surfaces. One can think of it as playing the role of the tower of the mapping class groups of surfaces, a notion suggested by A.Grothendieck in his "Esquisse d'un programme". A more precise connection with Grothendieck's program is the relationship between the Teichmuller tower of (orbifold) fundamental groupoids of the moduli spaces of punctured curves and our 2-groupoid (which should be a quotient of the former). The basepoints in the moduli spaces are chosen in simply connected neighborhoods of infinity, corresponding to the maximal semistable degeneracy curves. In the context of topological quantum field theory, instead of considering a series of representations of mapping class groups, we consider the representation of this single but more complicated algebraic object. Notice that this groupoid as a natural central extension related to those of the mapping class groups (see [22]). The representations arising from the most interesting TQFTs are rather representations of the latter extension.

**Acknowledgements.** Part of this work when the first author visited Columbia University, whose support and hospitality are kindly acknowledged. We are thankful to Ch. Frohman, S.Gervais, T. Kitano, P. Lochak, V. Sergiescu, L. Schneps, J. Stasheff, A.Voronov and the referee for useful comments and discussions.

## 2 2-groupoids

### 2.1 Algebraic definitions

A 1-groupoid is by definition a category whose morphisms are isomorphisms. We extend this to an object having both the features of a 2-category and of a groupoid, and which we will call a 2-groupoid.

**Definition 2.1** *A 2-groupoid  $C$  is a category with the following properties:*

1. *The collection of objects  $\mathcal{O}(C)$  is a category itself, which is a 1-groupoid with an associative composition law denoted by  $\otimes$ , which gives  $\mathcal{O}(C)$  the structure of a (strict) tensor category. This means that the objects in  $\mathcal{O}(C)$  are the homomorphism sets  $Hom^0(u, v)$  of some other category  $C^0$  having an associative multiplication. The composition  $Hom^0(u, v) \times Hom^0(v, w) \rightarrow Hom^0(u, w)$  is our tensor structure  $\otimes$  at the level of  $\mathcal{O}(C)$ .*
2. *On the collection of morphisms one has a composition  $\circ$  which makes it into a groupoid, and a tensor multiplication*

$$\otimes : Hom(X, X') \otimes Hom(Y, Y') \longrightarrow Hom(X \otimes Y, X' \otimes Y'),$$

*induced by  $\otimes$  on  $\mathcal{O}(C)$  and compatible with the composition. Notice that the Hom on  $C$  is like a 2-Hom of  $C^0$ .*

The example we had in mind when considering this definition was that of the 2-groupoid of transformations of rigid structures on surfaces. Recall that a DAP-decomposition of a surface  $\Sigma$  is a decomposition of the surface into a finite number of elementary surfaces: disks, annuli, and pairs of pants, determined by a collection of disjoint simple closed curves in the interior of  $\Sigma$ . A rigid structure consists of a DAP-decomposition together with the following additional structure:

1. an ordering of the elementary surfaces;
2. for each elementary surface  $\Sigma_0$  a numbering of its boundary components, by 1 if  $\Sigma_0$  is a disk, 1 and 2 if  $\Sigma_0$  is an annulus, and 1, 2 and 3 if  $\Sigma_0$  is a pair of pants;
3. a parametrization of each boundary component  $C$  of  $\Sigma_0$  by  $S^1 = \{z; |z| = 1\}$  (the parameterization being compatible with the orientation of  $\Sigma_0$  under the convention “first out”) such that the parameterizations coming from two neighboring elementary surfaces are one the complex conjugate of the other;
4. fixed disjoint embedded arcs in  $\Sigma_0$  joining  $e^{i\epsilon}$  (where  $\epsilon > 0$  is small) on the  $j$ -th boundary component to  $e^{-i\epsilon}$  on the  $j + 1$ -st (modulo the number of boundary components of  $\Sigma_0$ ) (these arcs are called seams).
5. an ordering of elementary surfaces in the DAP-decomposition according to topological type.

Rigid structures are considered up to isotopy. In this setting the category  $C^0$  is given by circles (with some additional structure), and rigid structures on surfaces are homomorphisms (in  $C^0$ ) between their boundary. The exterior composition on  $C^0$  is given by the disjoint union. These are related both to the PROPs formalism and to that of the modular operads.

**Definition 2.2** *The (full) duality groupoid  $\mathcal{D}$  – also called the groupoid of transformations of rigid structures on surfaces – consists of:*

1. *A collection of objects  $(\Sigma, r)$ , which are the rigid two dimensional cobordisms. Here  $\Sigma$  is a surface, with boundary  $\partial\Sigma$  endowed with a fixed splitting  $\partial\Sigma = \partial_+\Sigma \cup \partial_-\Sigma$  of the boundary components and two labelings of each connected component in  $\partial_+\Sigma$  and  $\partial_-\Sigma$ , and  $r$  is the rigid structure on  $\Sigma$ .*
2. *The collection of morphisms between two given objects  $(\Sigma, r)$  and  $(\Sigma', r')$  is the set of all pairs  $\lambda = (\varphi, c)$ , where  $\varphi : \Sigma \rightarrow \Sigma'$  is a homeomorphism preserving the boundary splitting (and thus  $\Sigma = \Sigma'$ ) and  $c : \varphi(r) \rightarrow r'$  is a change of the rigid structure. We factor out by the following equivalence relation:*
  - (a)  $(\varphi, c) \sim (\varphi', c)$  if  $\varphi$  and  $\varphi'$  are isotopic;
  - (b)  $(\varphi, c) \sim (\varphi', c')$  if  $c' = c\varphi_*(\varphi'_*)^{-1}$ , where  $\varphi_*$  is the map induced by the homeomorphism  $\varphi$  at the level of rigid structures.
3. *The natural composition of morphisms, and a tensor product operation such that*
  - (a) *At the level of the objects the (incomplete) tensor product is given by:  $(\Sigma, r) \otimes (\Sigma', r') = (\Sigma \otimes \Sigma', r \otimes r')$ , where  $\Sigma \otimes \Sigma'$  is the boundary connected sum of  $\Sigma$  and  $\Sigma'$ , identifying the last  $k$  connected components of  $\partial_-\Sigma$  with the first  $k$  connected components of  $\partial_+\Sigma'$  (here one should think that the boundary components are ordered lexicographically according to the ordering of basic surfaces and to that of boundary components within one*

elementary surface). One labels in a canonical way the connected components of  $\partial_+(\Sigma \otimes \Sigma')$  (which is the union of the unglued components of  $\partial_+\Sigma$  and  $\partial_+\Sigma'$ ), and likewise the components of  $\partial_-(\Sigma \otimes \Sigma')$ . The number  $k$  is a parameter of the tensor product. Further  $r \otimes r'$  is the natural rigid structure induced by the gluing.

(b) On the level of morphisms, the tensor product induces maps:

$$\text{Hom}((\Sigma, r), (\Sigma', r')) \otimes \text{Hom}((\tilde{\Sigma}, \tilde{r}), (\tilde{\Sigma}', \tilde{r}')) \longrightarrow \text{Hom}((\Sigma, r) \otimes \tilde{\Sigma}, \tilde{r}), (\Sigma', r') \otimes (\tilde{\Sigma}', \tilde{r}'))$$

Returning to the general definition of a 2-groupoid, we emphasize that the first tensor product stands for the operation of gluing surfaces (which should be thought of as cobordisms between one dimensional manifolds), while the second is induced by the first at the level of morphisms. In fact all operations one can imagine at the topological level have natural counterparts in the groupoid setting. For instance capping off boundary circles with disks, or identifying two boundary circles induce maps at the homomorphism level. These maps correspond to the connected sum either with a disk or with a cylinder, and thus come from the tensor structure.

Another versions for the duality groupoid can be constructed by using only some of the possible gluings along boundaries, for instance by asking the common boundary contain only one circle, or  $\partial_-\Sigma = \partial_+\Sigma'$ . In all these cases the presentation theorem below has immediate reformulations, without introducing other generators or relations.

Remark that one has an embedding of the tower of mapping class groups  $\mathcal{M}_{*,*}$ , of surfaces with boundary, in the groupoid  $\mathcal{D}$ . This map associates to an element  $\varphi$  of the  $\mathcal{M}(\Sigma)$  the element  $(1, \varphi_*) \in \text{Hom}((\Sigma, r), (\Sigma, r'))$ , where  $\varphi_*$  transforms the rigid structure  $r$  into  $\varphi(r)$ .

Observe also that all morphisms of the groupoid have representatives of the form  $(1, c)$ , and also that not all of these representatives come from elements of the mapping class group. In fact a necessary and sufficient condition for  $(1, c)$  to be in the image of the mapping class group is that the transformation  $c$  preserves the combinatorial configuration (i.e. the dual graph of the pants decomposition) of the rigid structure. In that case the rigid structures  $r$  and  $r'$  define uniquely (up to isotopy) a homeomorphism  $\varphi$  such that  $c = \varphi_*$ .

Let us explain what the presentation of a 2-groupoid should be. Assume for simplicity that  $\mathcal{O}(C)$  is an Abelian category having direct sums.

**Definition 2.3** *A system of generators for the 2-groupoid  $C$  consists of a collection of elements  $x_i \in \text{Hom}(U_i, V_i)$ ,  $U_i, V_i \in \mathcal{O}(C)$ ,  $i \in I$ , such that:*

1. Each  $U \in \mathcal{O}(C)$  can be written as

$$U = \bigoplus_{j=1}^n \bigotimes_{k=1}^{m_j} U_{i_{jk}}, \text{ where } i_{jk} \in I, n, m_j \in \mathbf{Z}.$$

2. Each  $x \in \text{Hom}(U, V)$  can be written as

$$x = \bigoplus_j \bigotimes_k \circ_{l=0}^m x_{i_{jkl}}$$

where  $\circ$  is the usual composition of morphism (subject to the source=target condition)  $U = \bigoplus_j \bigotimes_k U_{i_{jk0}}$ ,  $V = \bigoplus_j \bigotimes_k V_{i_{jkm}}$ , and each of the  $x_{i_{jkl}}$  is either equal to the identity morphism, or is one of the generators.

**Definition 2.4** A presentation of a 2-groupoid  $C$  is given by the system of generators  $x_i \in \text{Hom}(U_i, V_i)$ , and a system of relations  $r_j \in \text{Hom}(Z_j, W_j)$  that can be written in terms of the  $x_i$ 's.

The 2-groupoid with presentation  $\langle x_i, i \mid r_j, j \rangle$  can be constructed abstractly in the following way. Fix the set of objects  $\mathcal{O}(C)$ . For  $U, V \in \mathcal{O}(C)$  define

$$\text{Hom}_0(U, V) = \bigoplus_j \bigotimes_k \circ_l \text{Hom}_{00}(U_{ijkl}, V_{ijkl}),$$

where  $\text{Hom}_{00}(U_i, V_i)$  is the set of those maps constructed from the  $x_j$  with the same source and target.

Set  $\text{RHom}(U, V) \subset \text{Hom}_0(U, V)$  for the subset of those  $\varphi$  which can be written as  $\alpha \circ \psi \circ \beta$  with  $\psi$  of the form

$$\psi = \bigoplus_j \bigotimes_k \psi_{ijk},$$

where, for each  $j$ , some of the elements  $\psi_{ijk}$  are relations  $r_l$  and the others are identity morphisms. The set  $\text{Hom}(U, V) = \text{Hom}_0(U, V) / \text{RHom}(U, V)$  is by definition the set of morphisms between  $U$  and  $V$ .

The main purpose of this paper is to prove that the Moore-Seiberg equations give a presentation of the 2-groupoid  $\mathcal{D}$ .

## 2.2 The geometric point of view

Let us discuss an analogous situation. One can define a group presentation  $G = \langle x_i, i \mid r_j, j \rangle$  geometrically as follows. Fix a basepoint, and for each generator  $x_i$  a loop, then attach a 2-cell on each loop made up from a word  $r_j$ . The space  $X_G = \bigvee_{x_i} S^1 \bigcup_{r_j} D^2$  has the fundamental group equal to  $G$ .

Let us go one step further, to the presentation of a 1-groupoid  $C$ . Consider a presentation of a 1-groupoid  $C$  given by  $\langle x_i, i \mid r_j, j \rangle$ , where  $x_i \in \text{Hom}(s(x_i), t(x_i))$ ,  $s, t$  being the source and target maps. Construct a 2-complex  $X_C$  in the same vein, by identifying the set  $F$  of final objects with a set of 0-cells and by choosing a 1-cell connecting  $a$  and  $b$  in  $F$ , for each  $x_i$  such that  $s(x_i) = a, t(x_i) = b$ . Attach a 2-cell on a loop representing  $r_j$ , for each  $j$ . The fundamental groupoid  $\pi_1(X_C, F)$  with base points in  $F$  is the 1-groupoid of the given presentation. Notice that relation  $r_j$  with  $s(r_j) \neq t(r_j)$  add further identifications in  $F$ , to enable us to attach 2-cells.

Consider now a 2-groupoid  $C$ , with generators and relations  $x_i$  and  $r_i$ . Like before, identify the final objects of  $\mathcal{O}(C)$  with the set of 0-cells, and add a 1-cell between  $s(x_i)$  and  $t(x_i)$  for each generator  $x_i$ . Next let  $K^1$  be the 1-complex obtained as closure of this structure under the tensor product, meaning that each edge  $x_i$  induces the attachment of other edges, denoted by  $x_i \otimes 1_a$  (respectively  $1_a \otimes x_i$ ), between  $s(x_i) \otimes a$  and  $t(x_i) \otimes a$ . These correspond to elements  $x_i \otimes 1_a \in \text{Hom}(s(x_i) \otimes a, t(x_i) \otimes a)$ . Recall that  $1_a$  is the identity element in the group  $\text{Hom}(a, a)$ .

Attach to  $K^1$  2-cells along the loops associated to the relations  $r_j$ , and take the  $\otimes$ -closure  $K^2$ , meaning that once a 2-cell is attached on the vertices  $u_i$  and edges  $e_i$  then all its translated copies on the vertices  $u_i \otimes a$  and edges  $e_i \otimes 1_a$  (respectively  $a \otimes u_i$  and  $1_a \otimes e_i$ ) are also 2-cells. Finally, add the DC-cells that come from the tensor structure. These cells are defined as follows. Assume that we have  $a \in \text{Hom}(x, x')$  and  $y \in \text{Hom}(y, y')$ . Consider the four vertices  $x \otimes y, x' \otimes y, x \otimes y'$  and the edges  $a \otimes 1_y, 1_{x'} \otimes b, 1_x \otimes b$  and  $a \otimes 1_{y'}$  relating these vertices. Attach a 2-cell on the

square made off the edges and call it a DC-cell (disjoint commutativity). The relations expressed by these cells are the obvious  $(a \otimes 1_y)(1_{x'} \otimes b) = (1_x \otimes b)(a \otimes 1_{y'})$ . Call  $X_C$  the new 2-complex. The tensor multiplication gives a multiplicative structure on the groupoid of paths in  $X_C$ . When adding the 2-cells one obtain a tensor multiplication on the fundamental groupoid  $\pi_1(X_C, \mathcal{O}(C))$ , and the 2-groupoid obtained this way is isomorphic to  $C$ .

### 3 The Moore-Seiberg equations

#### 3.1 Main results

This section contains the main results of the paper.

**Theorem 3.1** *The duality 2-groupoid  $\mathcal{D}$  has the 2-groupoid presentation with:*

*Generators  $T_1, R, B_{23}, F, S, A, D, P$  and their inverses.*

*Relations (Moore-Seiberg equations)*

*1. at the level of a pair of pants:*

a)  $T_1 B_{23} = B_{23} T_1, T_2 B_{23} = B_{23} T_3, T_3 B_{23} = B_{23} T_2$ , where  $T_2 = R T_1 R^{-1}$  and  $T_3 = R^{-1} T_1 R$ ,

b)  $B_{23}^2 = T_1 T_2^{-1} T_3^{-1}$ ,

c)  $R^3 = 1$ ,

d)  $R B_{23} R^2 B_{23} R B_{23} R^2 = B_{23} R B_{23} R^2 B_{23}$ ,

*2. relations defining inverses:*

a)  $P^{(12)} F^2 = 1$ ,

b)  $T_3^{-1} B_{23}^{-1} S^2 = 1$ ,

*3. relations coming from "triangle singularities":*

a)  $P^{(13)} R^{(2)} F^{(12)} R^{(2)} F^{(23)} R^{(2)} F^{(12)} R^{(2)} F^{(23)} R^{(2)} F^{(12)} = 1$ ,

b)  $T_3^{(1)} F B_{23}^{(1)} F B_{23}^{(1)} F B_{23}^{(1)} = 1$ ,

c)  $B_{23}^{-1} T_3^{-2} S T_3^{-1} S T_3^{-1} S = 1$ ,

d)  $R^{(1)} (R^{(2)})^{-1} F S^{(1)} F B_{23}^{(2)} B_{23}^{(1)} = F S^{(2)} T_3^{(2)} (T_1^{(2)})^{-1} B_{23}^{(2)} F$ ,

*4. relations coming from the symmetric groups:*

a)  $P^2 = 1$ ,

b)  $P^{(23)} P^{(12)} P^{(23)} = P^{(12)} P^{(23)} P^{(12)}$ .

*5. relations involving annuli and disks:*

a)  $A^{(12)} D^{(23)} = A^{(23)} D^{(12)}$ ,

b)  $A^{(12)} D_3^{(13)} = A^{(13)} D_3^{(13)} F$ ,

c)  $A^{(12)} A^{(23)} = A^{(23)} A^{(12)}$

d)  $SD = DS$ .

We used the convention that superscripts tell us on which factors of the tensor product the move acts. Here the tensor structure is implicit.

It was proved in [10] that any topological invariant of 3-manifolds determines a unique maximal associated TQFT. In the terminology of [28] and [13] this is a TQFT with corners. Notice that a TQFT gives rise to a representation  $\rho_* : \mathcal{M}_* \rightarrow \text{End}(W_*)$ .

When considered on a torus, that is when capping the 1-holed torus with a disk, relations 2.b) and 3.c) give rise to the well known morphism from  $SL(2, C)$  into the groupoid of moves acting on the torus, which groupoid contains the mapping class group of the torus, as a maximal group. If on a sphere with four holes we factor out by the twists around the holes, i.e. if we consider the groupoid of moves on a fourth punctured sphere, then relations 2.a) and 3.b) give rise to another morphism from  $SL(2, C)$  into the groupoid of the 4-holed sphere. This latter morphism is used in the classification of 2-bridge knots.

**Theorem 3.2** *Assume that the TQFT is finite dimensional, unitary, cyclic and has a unique vacuum (see section 5 for complete definitions). Then  $\rho_*$  extends canonically to a representation of the the full duality groupoid  $\mathcal{D}$ . In particular all maximal TQFT representations verify the Moore-Seiberg equations.*

On the other direction Kohno (see [19, 20]) used the data coming from conformal field theory to construct representations of the tower of mapping class groups (and in fact of the duality groupoid). He proves then that these determine topological invariants for 3-manifolds (which actually extend to a TQFT).

### 3.2 Topological interpretation of the generators and relations

The generators written above can be explicitly viewed in the topological picture of the groupoid, so that the relations become tautological. We have:

1. Moves on rigid structures on a pair of pants, which are the three twists  $T_j$  around the boundary circles, the knob twisting  $B_{23}$  and the cyclic permutation  $R$  of the numbering of the boundary components.
2. The move  $F$  on a sphere with 4 holes decomposed into two pairs of pants. The decomposition curve is transformed as such that the new curve does not intersect the seams that the old one did, and intersects each of the other two seams exactly once. The numberings of the pairs of pants transform such that the decomposition curve remains labeled by 1 and the boundary curve labeled by 2 of the first pair of pants becomes the the curve labeled by 3 of the first pair of pants.
3. The move  $S$  on the 1-holed torus.  $S$  changes the rigid structure as the element  $\begin{bmatrix} 0 & -1 \\ 1 & 0 \end{bmatrix}$  of the mapping class group.
4. The move  $P$  which transposes the numberings of two pairs of pants, two annuli or two disks. Using the groupoid structure,  $P$  generates the whole permutation group of numberings.
5. Moves  $D$  and  $A$  which correspond to contracting annuli and disks. Their inverses consist of expansions of disks or annuli.



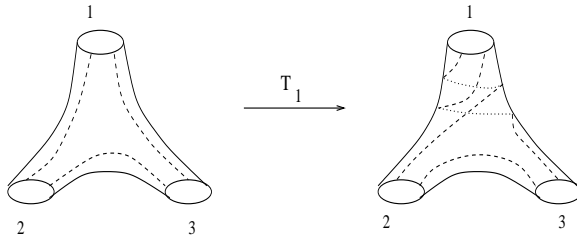

Figure 1:  $T_1$

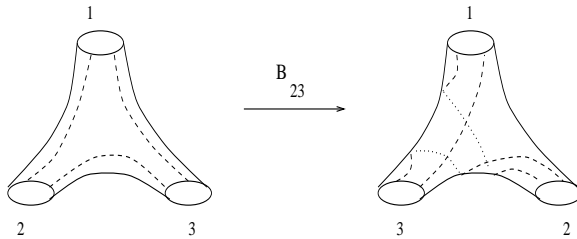

Figure 2:  $B_{23}$

These elementary moves are described in Fig. 1-5. In these figures the convention is that the circles of the DAP-decomposition are drawn as plain curves, every curve being labeled by a number in each elementary surface that it bounds, the seams are pictured as dashed curves, and each pair of pants carries an encircled number, these numbers defining the ordering of elementary surfaces. If one element of this data is absent this means that it can be chosen arbitrarily in the given situation. Note that the relations given in Theorem 3.1 can be easily verified pictorially.

Let us stress out that moves represent changes of rigid structures and not homeomorphisms. The first group of relations are identical with the ones giving the presentation of  $\mathcal{M}_{0,[3]}$ , (the extended mapping class group of the 3-holed sphere, in which is allowed to interchange the boundary components). However, the moves  $F$ ,  $A$  and  $D$  do not have analogues at the level of homeomorphisms.

### 3.3 The 2-complex $\Gamma$

For the proof of Theorem 3.1 we will adapt the Harer-Hatcher-Thurston technique to the present situation. To this end we construct a family of 2-complexes, related by the tensor product.

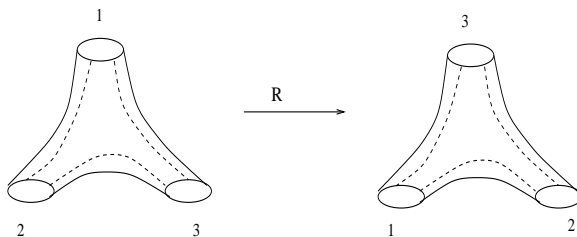

Figure 3:  $R$

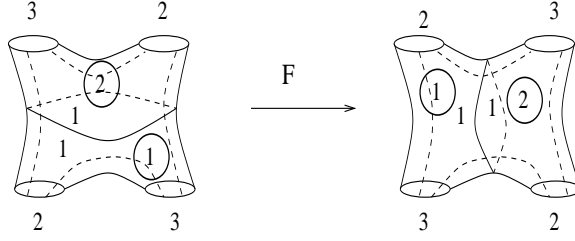

Figure 4:  $F$

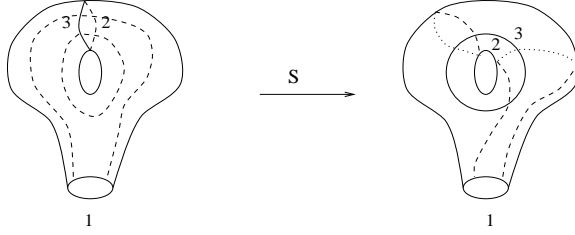

Figure 5:  $S$

**Definition 3.3** *The complex  $\Gamma(\Sigma)$  is obtained as follows:*

1. *Its vertices are the various rigid structures on  $\Sigma$ .*
2. *Two vertices are related by an edge if there is one transformation of type  $B_{23}, T_1, R, F, S, P, D, A$  which relates the respective rigid structures.*
3. *The first set of 2-cells is given by the Moore-Seiberg equations: each equation gives a circuit on the 1-skeleton and we attach a 2-disk on it.*
4. *The second set of 2-cells are the DC-cells which represent the commutation relation between two moves whose supports are sub-surfaces with disjoint interiors.*
5. *The third set of relations correspond to relations among the permutations in the ordering of the elementary surfaces in the DAP-decomposition.*

We observe that when talking about the moves  $F, S, \dots$  we already make use of the tensor structure on the duality groupoid, because these moves are defined on sub-surfaces and are extended by identity outside the support. Hence it makes sense to consider the union  $\Gamma = \bigcup_{\Sigma} \Gamma(\Sigma)$ . The set of vertices has a multiplicative structure, the tensor product of the groupoid, and the fundamental groupoid  $\pi_1(\Gamma)$  is nothing but the 2-groupoid with presentation given by the Moore-Seiberg equations. Thus Theorem 3.1 follows from

**Theorem 3.4** *The complex  $\Gamma(\Sigma)$  is connected and simply connected. The mapping class group  $\mathcal{M}(\Sigma)$  acts freely on it.*

The proof is reminiscent of [17]. We consider first simpler structures which mimic the construction of  $\Gamma(\Sigma)$ . Thus we start with the groupoid of markings, then add overmarkings and eventually come to the last object. The cases of

markings and overmarkings are solved with techniques of Cerf theory, and simple algebraic topology arguments yield the result for rigid structures. The proof of this result will be done in detail in Chapter 4.

## 4 Proof that Moore-Seiberg equations are sufficient

### 4.1 Elements of Cerf theory

Following [17], given a surface we call *marking* a finite collection of disjoint simple closed curves lying in the interior of the surface, that decompose the surface into pairs of pants. Thus markings are obtained from rigid structures by forgetting the annuli, disks, seams and numberings. Of course for a surface to admit a marking it must be different from a sphere, torus, disk or annulus.

Let  $\Sigma$  be a given surface. We want to find a presentation of the groupoid of transformations of markings on  $\Sigma$ . For this we will use Cerf theory [8], in an analogous way it was used in [17] for the study of the mapping class group.

For each marking there exists a Morse height function  $f : \Sigma \rightarrow \mathbf{R}$ , such that the decomposition curves are connected components of level sets of  $f$ . The space  $\mathcal{F}$  of height functions has a stratification

$$\mathcal{F} = \mathcal{F}^0 \cup \mathcal{F}^1 \cup \mathcal{F}^2 \cup \mathcal{F}^3 \cup \dots$$

where  $\mathcal{F}^k$  are strata of codimension  $k$ .

In particular  $\mathcal{F}^0$  is the set of Morse functions (i.e. functions with finitely many critical points, all Morse and at different heights), and is a dense open subset of  $\mathcal{F}$ , and  $\mathcal{F}^1 = \mathcal{F}_\alpha^1 \cup \mathcal{F}_\beta^1$ , with  $\mathcal{F}_\alpha^1$  having finitely many critical points, all Morse and at different heights, except for one which is a birth-death (i.e. the height function looks locally like  $f(x, y) = \pm x^3 \pm y^2$ ), and  $\mathcal{F}_\beta^1$  having finitely many critical points, all Morse and at different heights, except for a pair of Morse points which are at the same height.

We will make use of the two results in Cerf theory given in the sequel.

**Theorem 4.1** *Any two Morse functions  $f_0$  and  $f_1$  can be joined by a path of height functions  $(f_t)_{t \in [0,1]}$ , with the property that all  $f_t$  are Morse except for finitely many, and for these exceptional functions the path crosses  $\mathcal{F}^1$  transversely.*

A path having the property described in the theorem is called a good path. For a better understanding it is customary to sketch the graph of a path, namely to trace the critical points of the functions  $f_t$ ,  $t \in [0, 1]$ . An example of a graph for a good path is given in Fig. 6.

The second theorem tells us how a homotopy of paths crosses the codimension two stratum.

**Theorem 4.2** *If  $(f_t)_t$  is a closed good path in  $\mathcal{F}$ , then there exists a homotopy  $(f_{t,u})_u$  from it to the constant path such that  $f_{t,u_0}$  is good for every  $u_0$ , except for the following isolated singularities:*

- a). *crossing (two crossings are cancelled or introduced),*
- b). *birth-death (two birth-death points are canceled or introduced),*

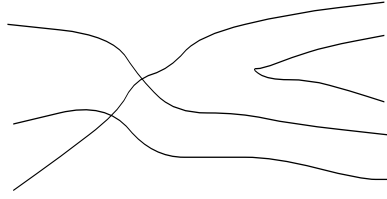

Figure 6: Example of a graph

- c). *triangle* (three non-degenerate critical points lie at the same level),
- d). *beak singularity* (a birth-death point crosses a non-degenerate critical point),
- e). *swallow tail*,
- f). *two birth-death or crossing points occur simultaneously*.

These singularities are shown graphically in Fig. 7.

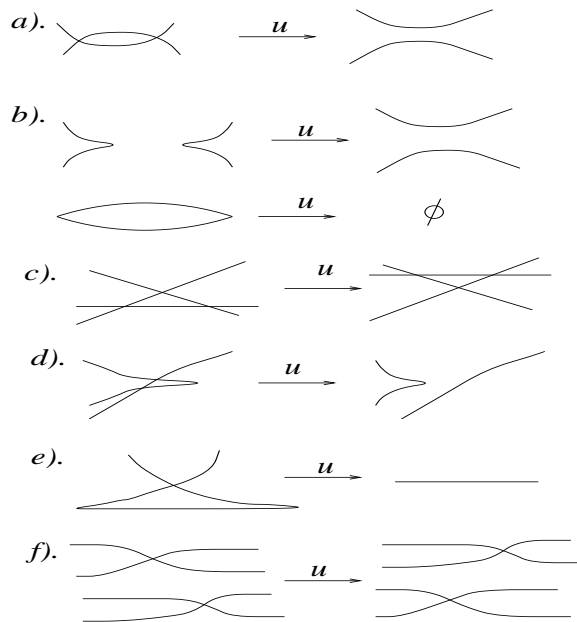

Figure 7: Singularities

Given two markings, associate to them Morse functions that determine them. One can pass from one function to the other along a good path. The only case when the marking can change is when one crosses the codimension one stratum. The marking does not change at a beak point, nor at a crossing point if any of the critical points that cross has index different from 1. Hence the only interesting points are the crossings of saddle points. To understand what happens in this case, let us restrict our attention to the semi-local picture containing these points, namely to the pairs of pants determined by the marking that contain the two points. If the pairs of pants are disjoint, then the marking remains unchanged after the crossing.

If the pairs where the crossing occurs share some boundary components, we have the situations described in Fig. 8. Here and below to encode the crossings, rather than using the associated trivalent graph, as it was done in [17], we will use the ascending-descending manifold model, which is more suggestive in this situation. Let us recall that the ascending (unstable) manifold is the submanifold on which the quadratic function that gives the local model of the singularity is positive definite, and the descending (stable) manifold is the submanifold on which the quadratic function is negative definite. In the case of index one singularities on a surface both these submanifolds are one-dimensional. On the left hand column of Fig. 8 we represented the descending manifold model viewed from above, and one should imagine the two descending manifolds exchanging heights when the crossing occurs.

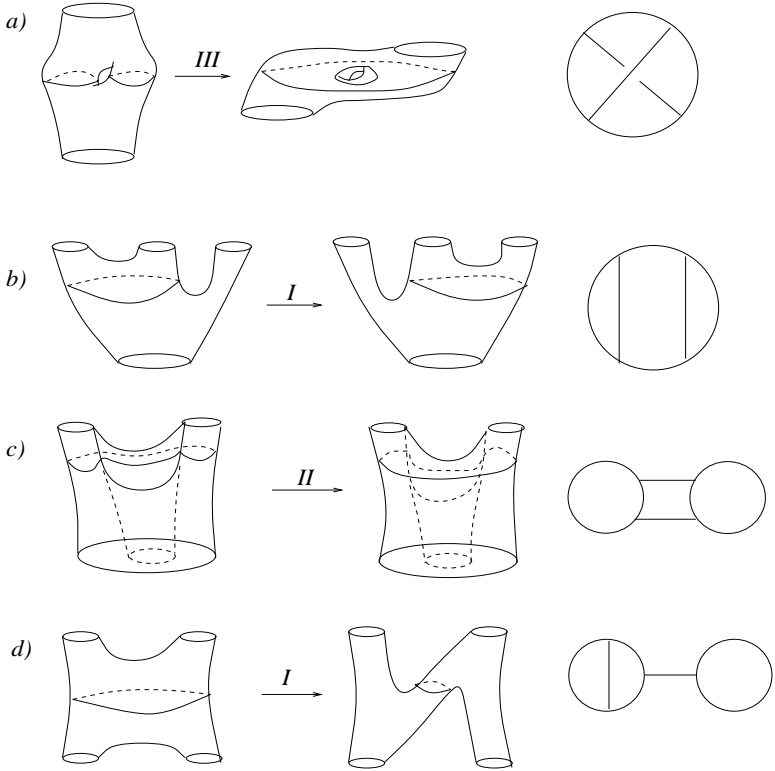

Figure 8: Crossings

These four types of crossings give rise to the four moves of Hatcher and Thurston [17]. Recall that *IV* is obtained by capping off one boundary component of the torus by using a disk, in the move *III*. Consequently any two markings can be transformed one into the other by applying finitely many moves like these.

To find the relations that these moves satisfy, we will rely on the second theorem. Since beak points do not interfere with markings, the only singularities that produce relations between moves are a), which expresses the fact that each move is its own inverse, f), which gives the disjoint commutativity between moves that occur far away from each other, and the triangle singularity. The latter produces the most interesting relations, which we will describe below.

## 4.2 The groupoid of markings

Looking at the combinatorics of the circles below the singularity, and of the arcs connecting them, determined by the descending manifolds, there are 20 possible configurations. These configurations are described in Fig. 9. In this figure the second column consists of descending manifold models which by changing  $f$  to  $-f$  are the ascending manifold models corresponding to the descending manifold models from the first column. Because of this symmetry, there are only 10 relations between Hatcher-Thurston moves arising from these singularities. In these pictures the descending manifolds are at different heights and the exchanges in heights correspond to crossings. A particular choice of heights specifies the vertex at which one begins tracing the boundary of the cell, thus it suffices to make one choice for each diagram.

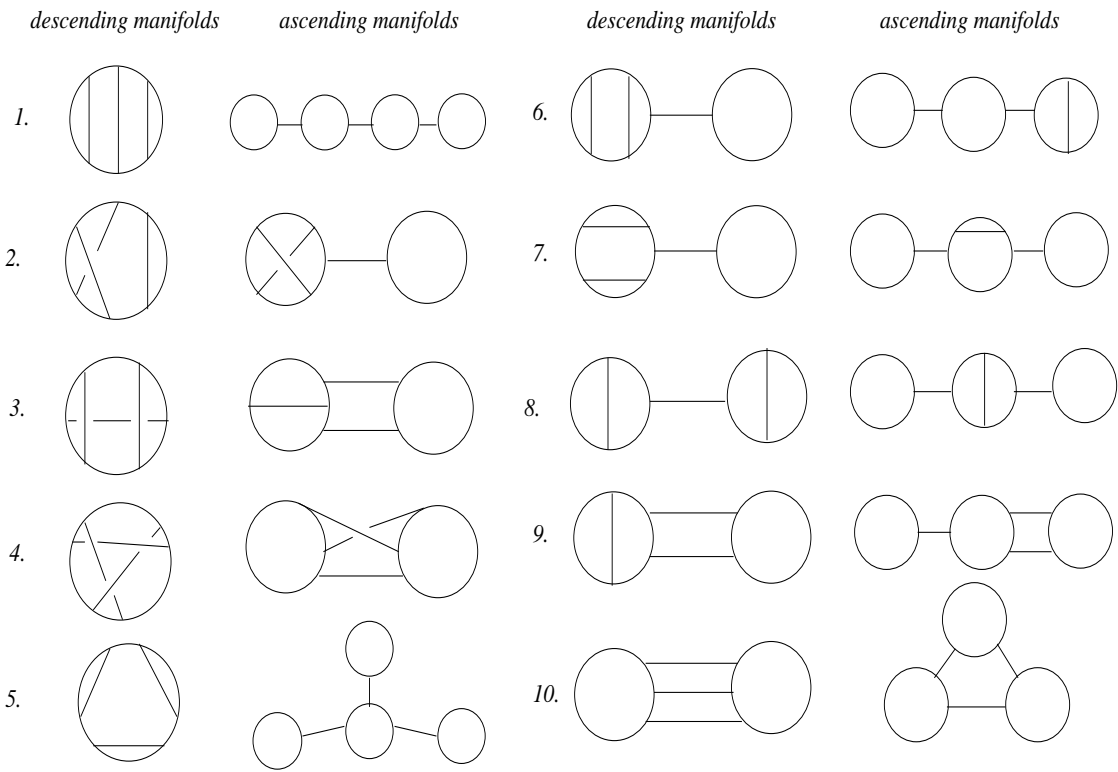

Figure 9: Triangle singularities

It is not hard to see that the configurations 1), 6), 7) and 8) give rise to the same relation. So there are seven distinct relations coming from triangle singularities. They are described in Fig. 10– 16. For clarity let us stress out that relations 1,5,9 and 10 hold on a sphere with five holes, while relations 2,3 and 4 hold on a torus with three holes.

In the CW-complex setting, let us consider the 2-complex  $\tilde{\Gamma}_0(\Sigma)$  defined as follows. The vertices of  $\tilde{\Gamma}_0(\Sigma)$  are all possible markings on the surface  $\Sigma$ , and there is an edge between two vertices if there exists a transformation of type *I*, *II*, *III* or *IV* relating the respective markings. The first set of 2-cells are the seven types of cells described in Fig.10– 16. To these we add the cells that express disjoint commutativity, called DC-cells, which come from crossing singularities.

**Proposition 4.1** *The 2-complex  $\tilde{\Gamma}_0(\Sigma)$  is connected and simply connected.*

*Proof:* This is a consequence of the two theorems from Cerf theory we cited previously, and the geometric interpretation given to markings.  $\square$

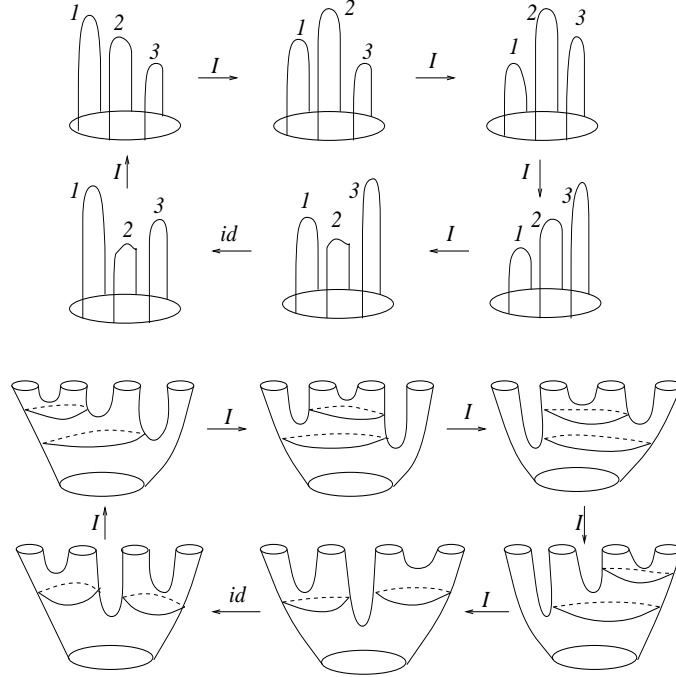

Figure 10: Relation 1

### 4.3 Reduction to fundamental moves and relations

As it is customary in topological quantum field theory, we will denote the move  $I$  by  $F$  and the move  $IV$  by  $S$ . The other two moves can be reduced to these two as seen in Fig. 17.

Regarding the relations between the moves, recall that Moore and Seiberg [23] predicted a much smaller number of equations. The reduction to these is the content of the following proposition.

**Proposition 4.2** *Each of the cells arising from triangle singularities can be decomposed into some of the four fundamental cells described in Fig. 18 and the commutativity DC-cells.*

Some remarks before we proceed with the proof. We have to show that each of the seven cells from above decomposes as a union of fundamental cells. As stated, this is not quite true, since we must add some other cells, the DC-cells, which express the disjoint commutativity between  $F$  and  $S$ . Roughly speaking two operations (like  $F$  and  $S$ ) with disjoint supports commute with each other. The squares expressing the commutation are the DC-cells. The reason we need to consider these DC-cells is the fact that we didn't take into account the tensorial structure for the moment and are thereby working with a fixed surface.

*Proof:* The decompositions are presented in Fig. 20 through Fig. 28.

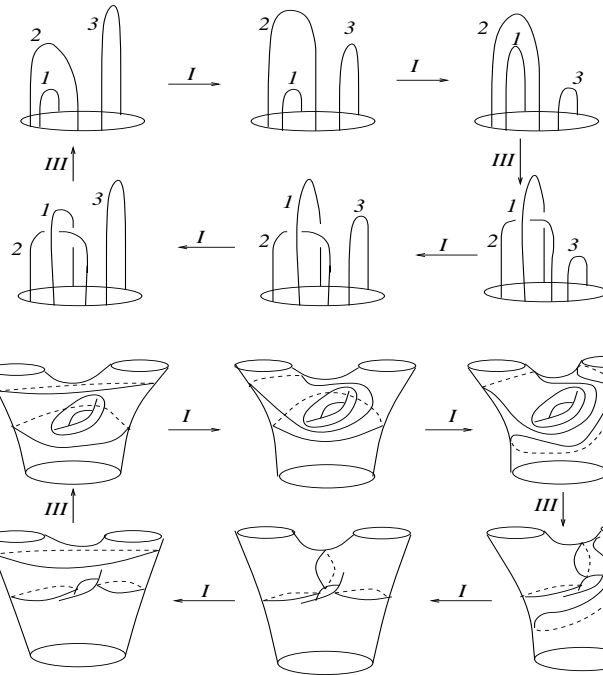

Figure 11: Relation 2

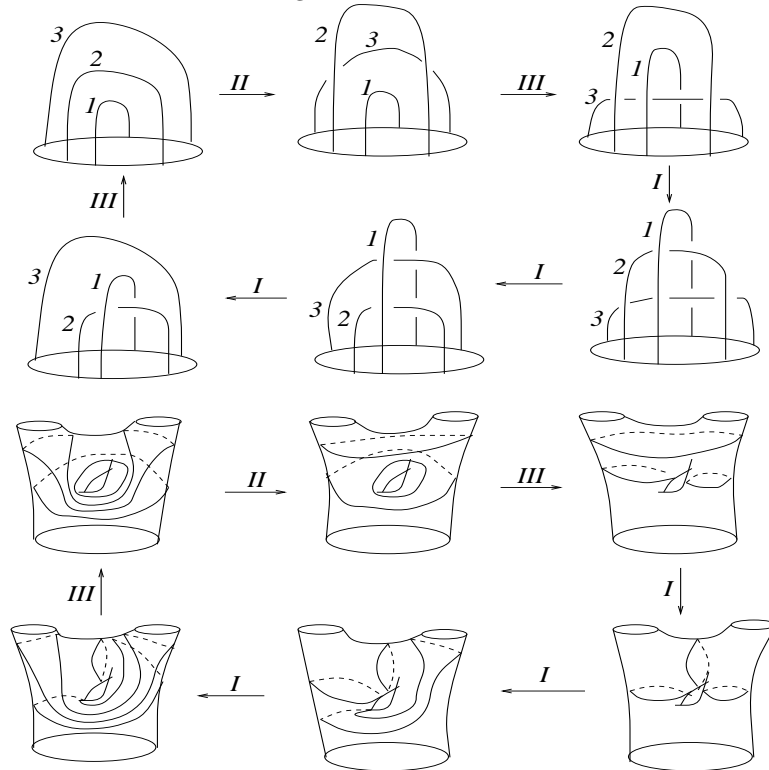

Figure 12: Relation 3



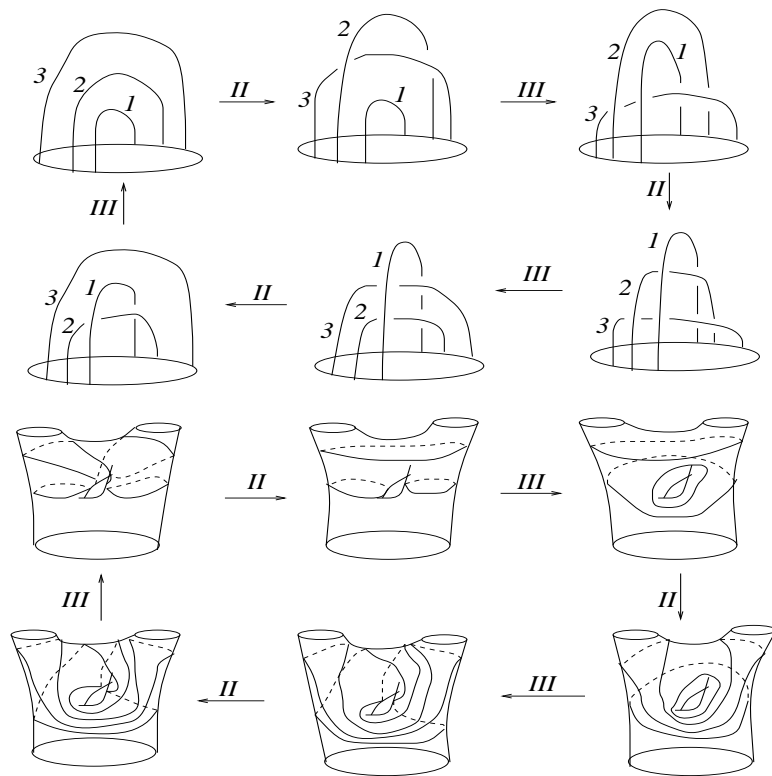

Figure 13: Relation 4

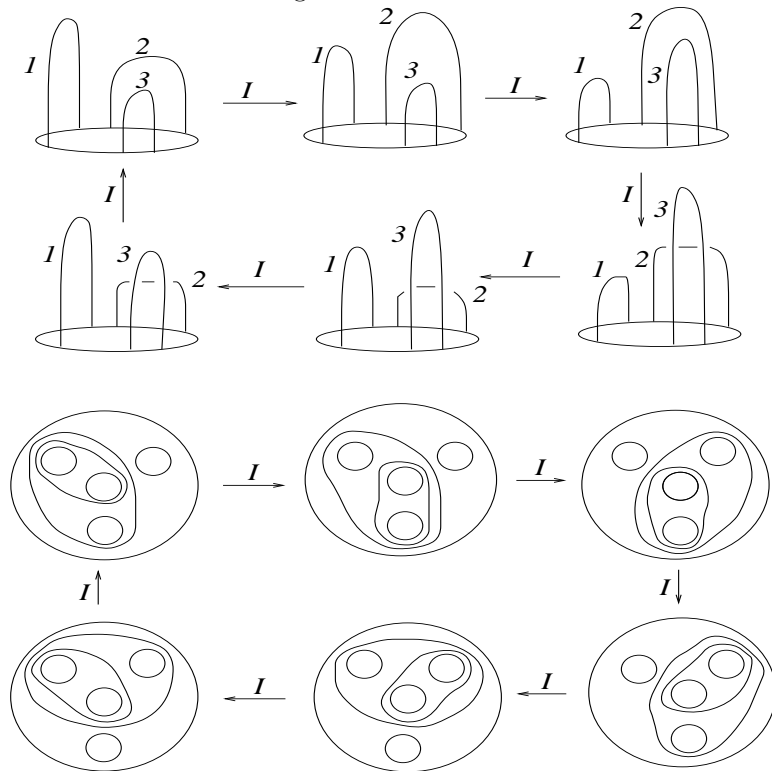

Figure 14: Relation 5

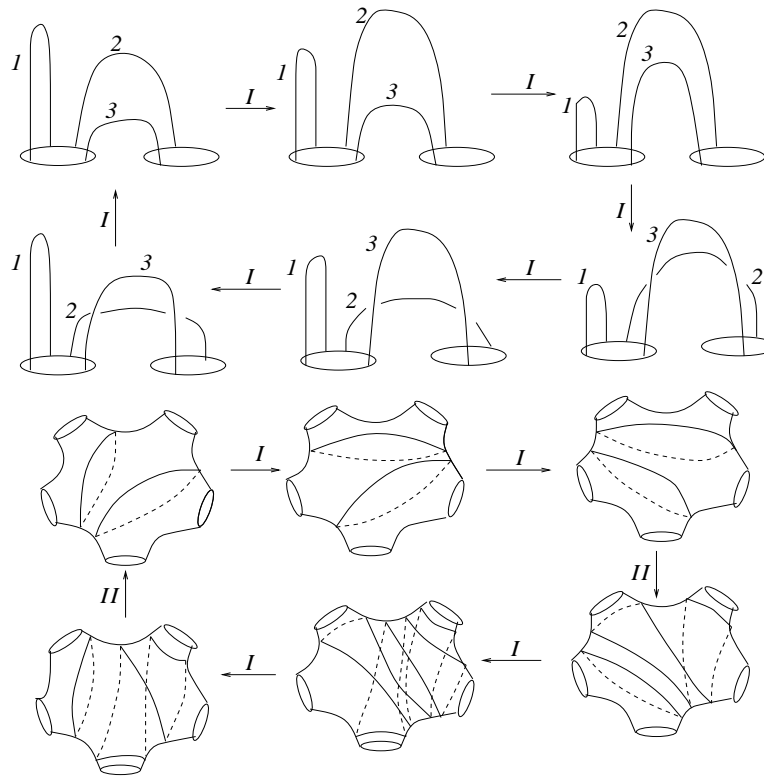

Figure 15: Relation 9

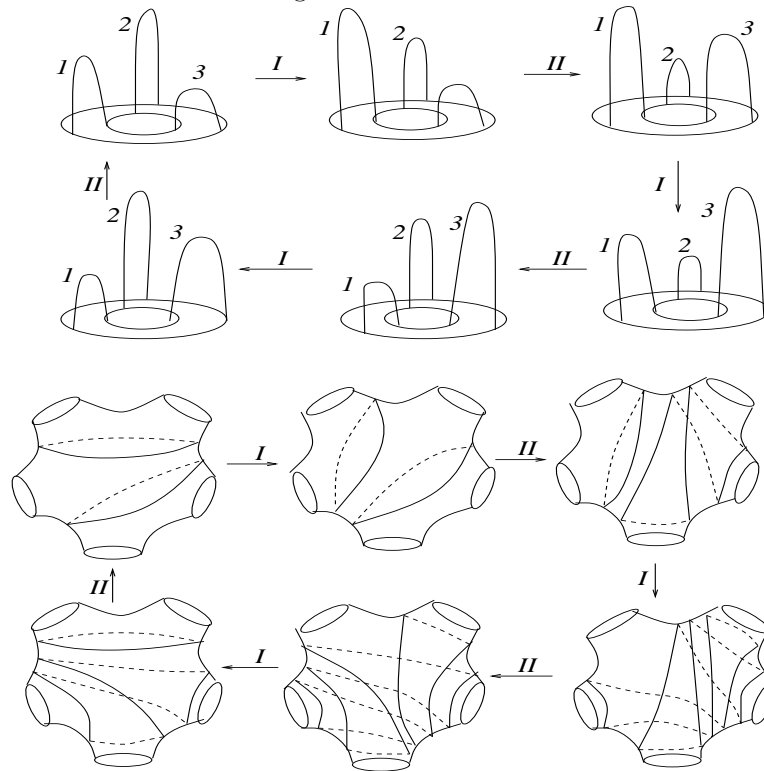

Figure 16: Relation 10

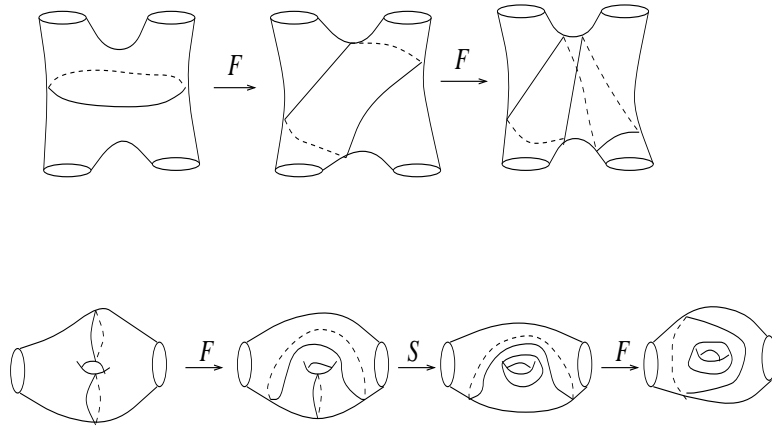

Figure 17: Reduction of II and III to  $F$  and  $S$

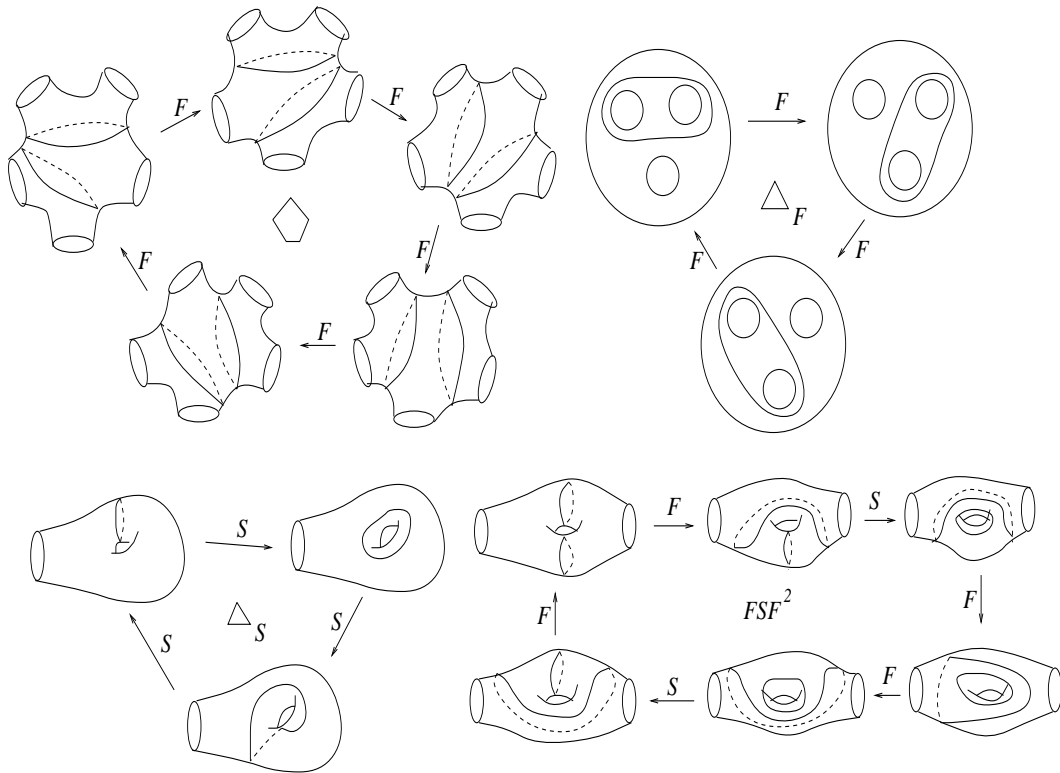

Figure 18: Fundamental cells

Let us point out that, as shown in Fig. 19, the possibility of decomposing the cells into fundamental cells does not depend on the way we expand the moves *II*, *III* (the cells in Fig. 19 provide a homotopy between the two ways to expand the moves).

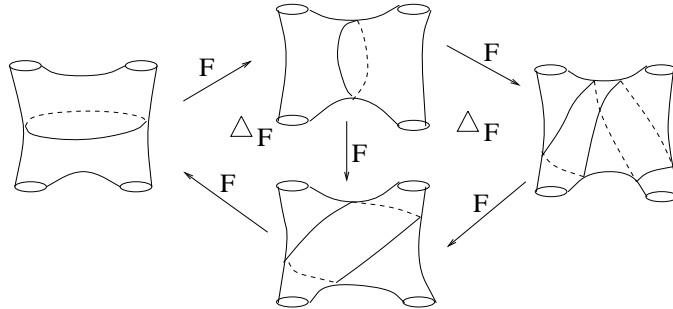

Figure 19: Decomposition of  $F^2$

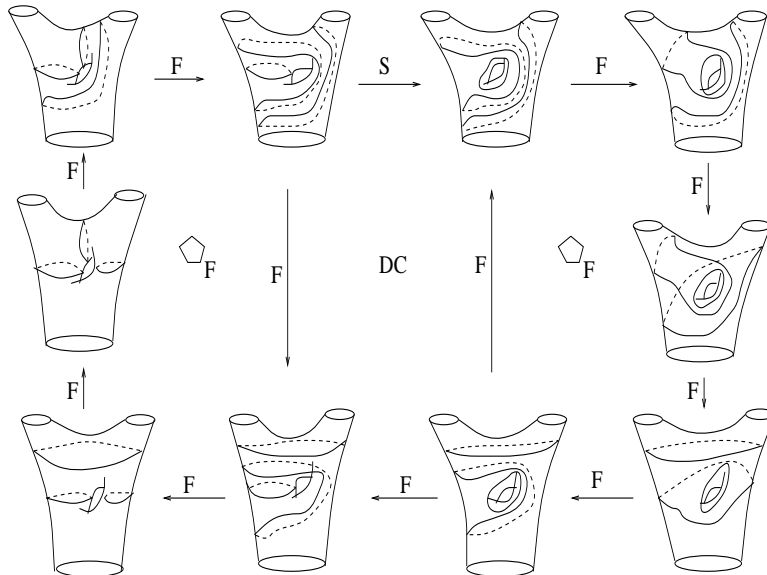

Figure 20: Decomposition of cell 2

Let us consider now a CW-complex of dimension 2, encoding all the informations about markings and transformations. The vertices of the complex  $\Gamma_0(\Sigma)$  are all possible markings on the surface  $\Sigma$  (with or without boundary). There is an edge (unambiguously denoted  $F$  or  $S$ ) between two vertices if the corresponding transformation  $F$  (respectively  $S$ ) relates the respective markings. To this complex we attach the 2-cells described in Fig. 18 and the DC-cells.

**Proposition 4.3** *The complex  $\Gamma_0(\Sigma)$  is connected and simply-connected.*

*Proof:* The result is a consequence of Proposition 1.3 and Proposition 4.2. More precisely, from Proposition 3.1 we get that  $\tilde{\Gamma}_0(\Sigma)$  is connected and simply connected. The connectedness of  $\Gamma_0(\Sigma)$  follows since each move of type *II* or *III* is a composition of  $F$  and  $S$ . Notice that the decompositions are not unique. However, two different

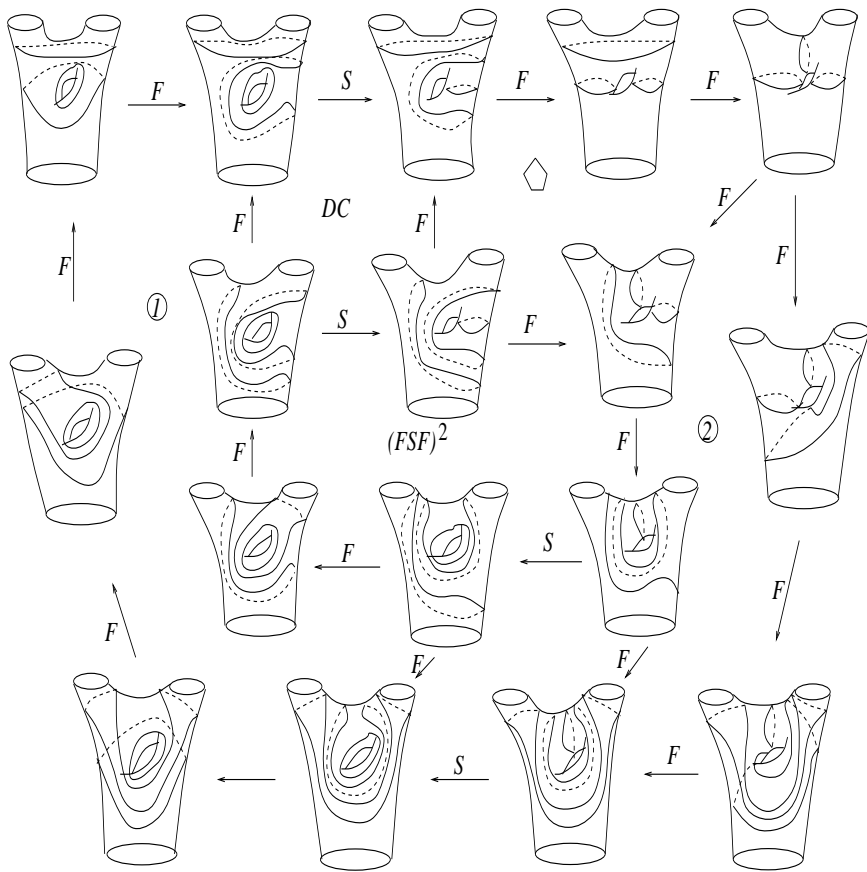

Figure 21: Decomposition of cell 3

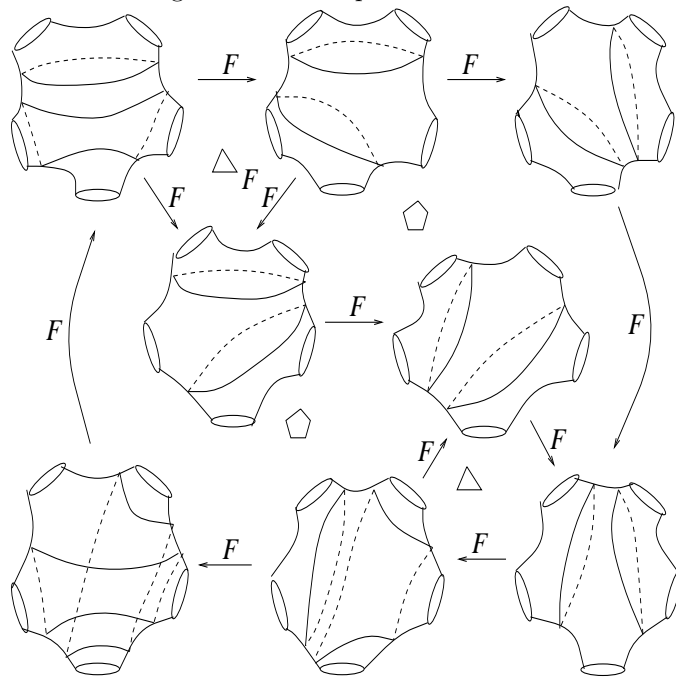

Figure 22: Auxiliary cell for decomposition of cell 3

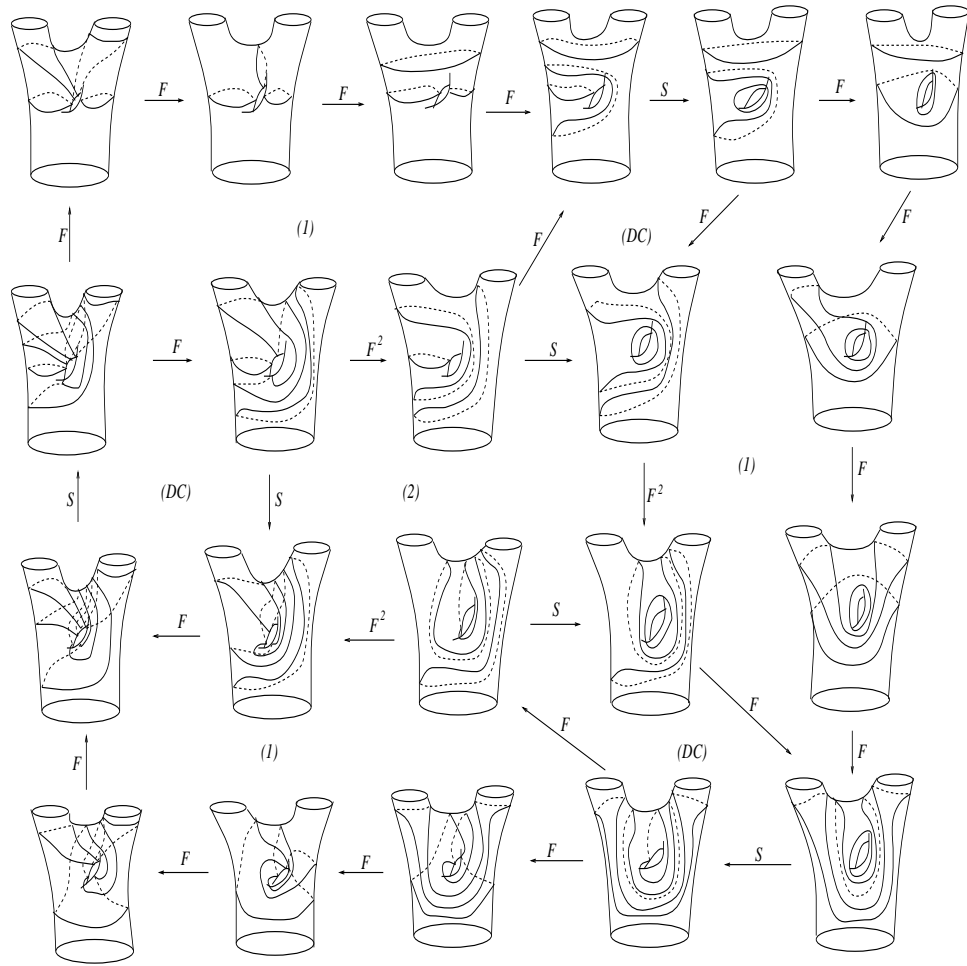

Figure 23: Decomposition of cell 4

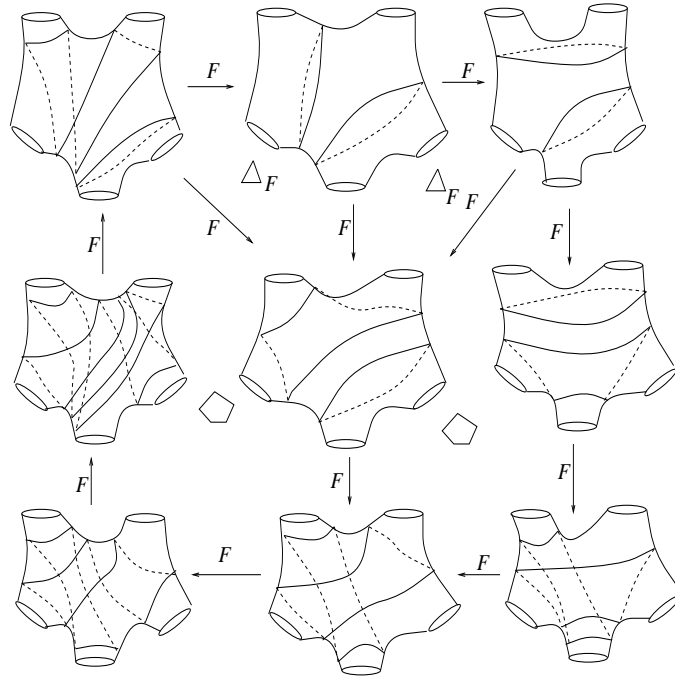

Figure 24: Auxiliary cell for decomposition of cell 4

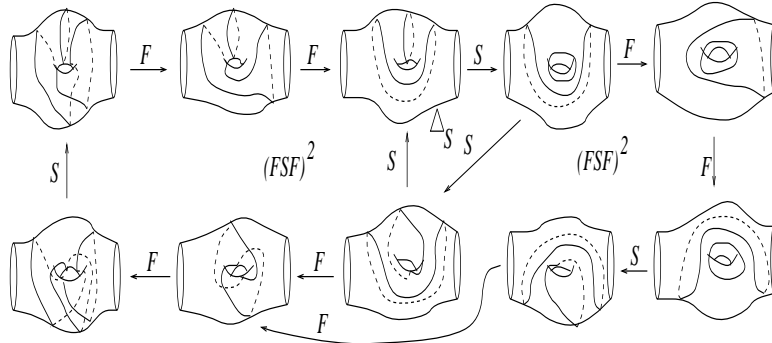

Figure 25: Auxiliary cell for decomposition of cell 4

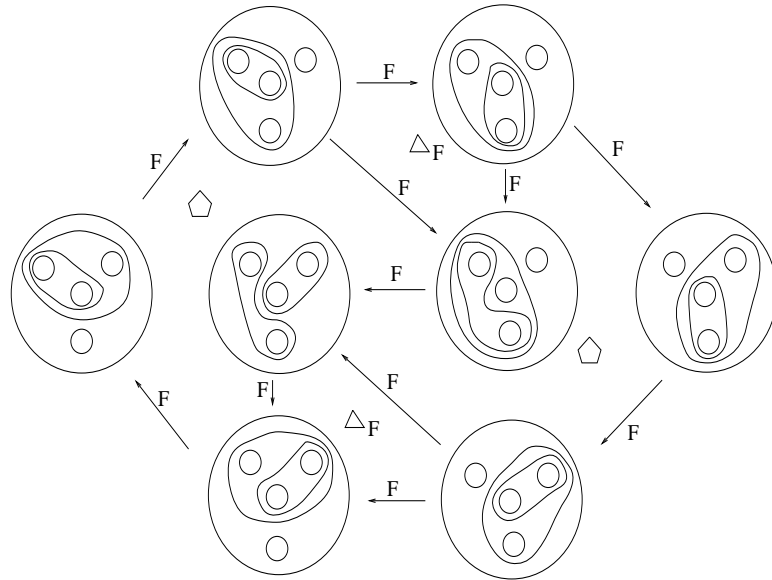

Figure 26: Decomposition of cell 5

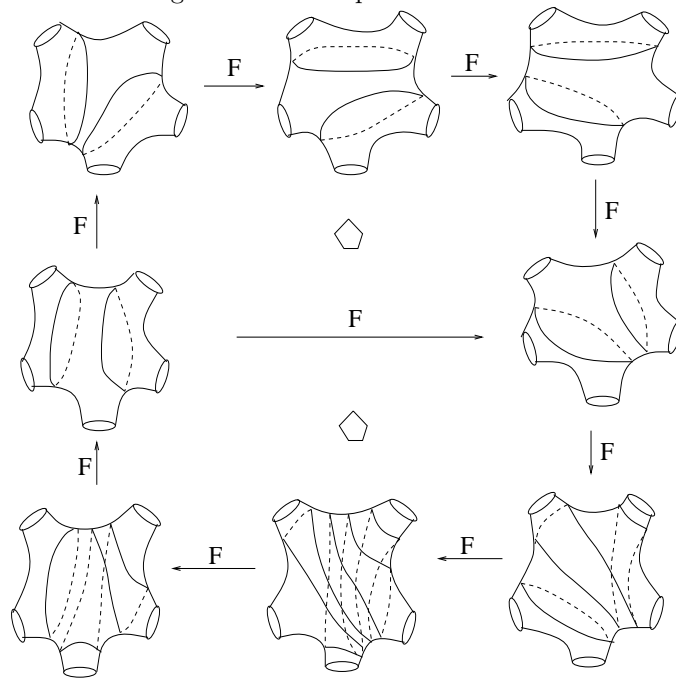

Figure 27: Decomposition of cell 9



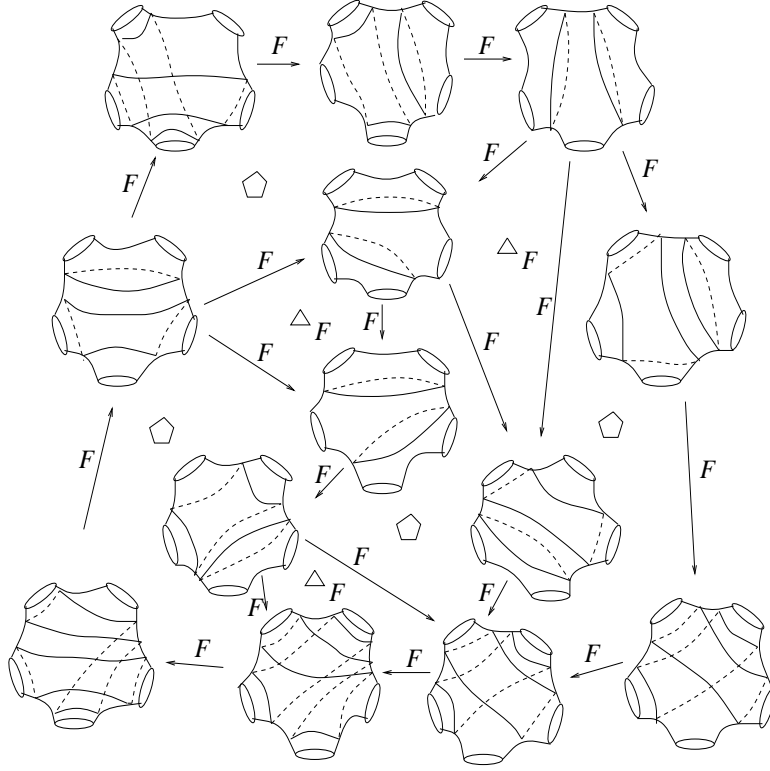

Figure 28: Decomposition of cell 10

decompositions can be homotoped one into the other via  $F$ -triangles and hexagonal  $(FSF)^2$ -cells respectively (see Fig. 19). Also note that the DC-cells made from arbitrary moves  $I, II, III, IV$  decompose into DC-cells for  $F$  and  $S$  according to the move decomposition. Furthermore the 2-cells in  $\tilde{\Gamma}_0(\Sigma)$  are replaced by their counterparts from  $\Gamma_0(\Sigma)$ , when the respective edges in  $\tilde{\Gamma}_0(\Sigma)$  are decomposed. The latter decompose in  $\Gamma_0(\Sigma)$  as unions of fundamental cells and DC-cells. This proves the proposition.  $\square$

#### 4.4 Overmarkings

Following Walker [28] we call a finite collection of disjoint simple closed curves lying in the interior of a surface an overmarking. Such a family of curves decomposes the surface into disks, annuli and pairs of pants, decomposition which is also called a DAP-decomposition.

Given a fixed surface, we want to exhibit a set of generators and relations for the groupoid of transformations of overmarkings. A decomposition containing only disks and pairs of pants is determined by the level sets of a Morse function. The disks are semi-local models of points of index 0 and 2, and the pairs of pants are semi-local models of points of index 1. By adding annuli one adds circles that are isotopic to the given circles.

Like before, two decompositions can be transformed one into the other along a good path, hence the elementary moves come from crossings of critical points, and by introducing (expanding) or eliminating (contracting) a finite number of annuli. In addition to the moves described in the previous section, one has the moves described in Fig. 29,

where we note that the first comes from a birth or death point.

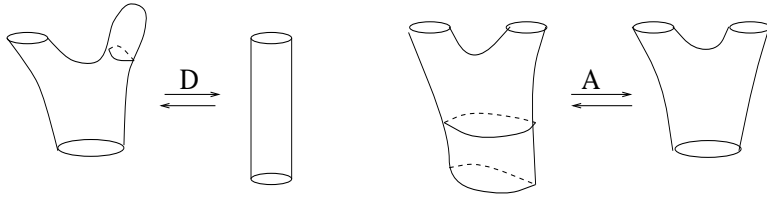

Figure 29: Birth-death move

The new 2-cells are the ones produced by birth-death singularities (Fig. 30. a), b)), swallow tail singularity (Fig. 30. c)), and disjoint commutativity.

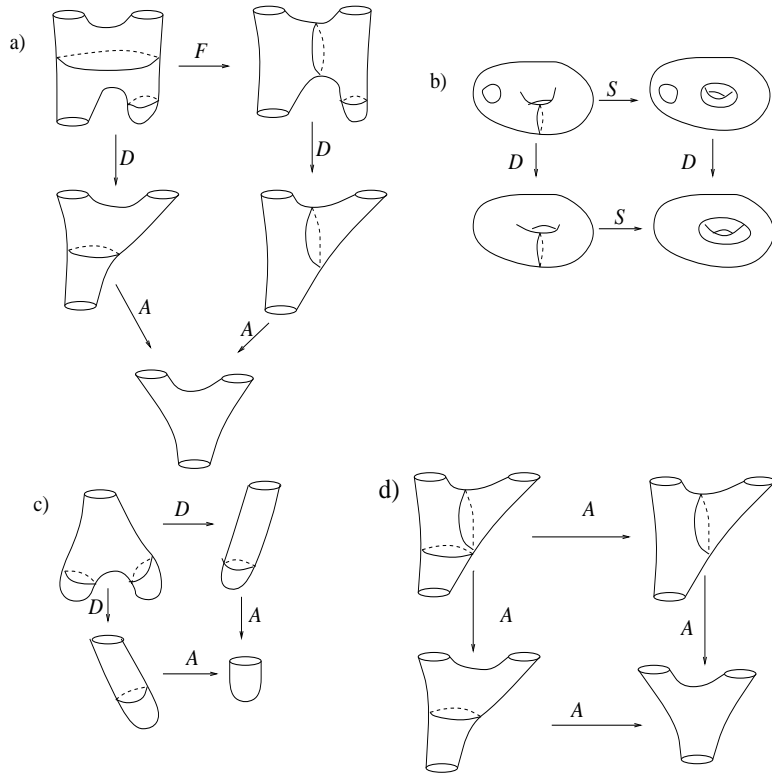

Figure 30: Birth-death cells

Consider now the groupoid of overmarkings and its associated 2-complex  $\Gamma_1(\Sigma)$ . Remark that the groupoid is defined for any surface  $\Sigma$ , without restrictions. Here the vertices are the overmarkings, the edges correspond to the moves  $F, S, D, A$  between two interrelated overmarkings and the 2-cells are four fundamental cells from the previous section, together with those from figure 30 and all the DC-cells made out of the four elementary moves. As a consequence of the above discussion and Proposition 4.3 we get

**Proposition 4.4** *The 2-complex  $\Gamma_1(\Sigma)$  is connected and simply connected.*

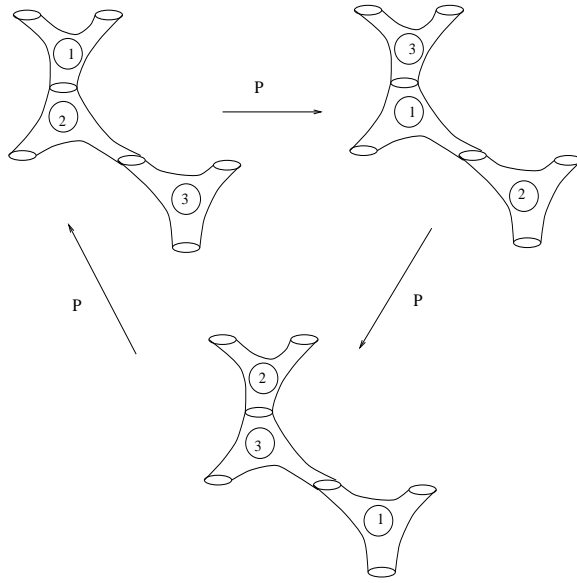

Figure 31: An example of a permutation cell

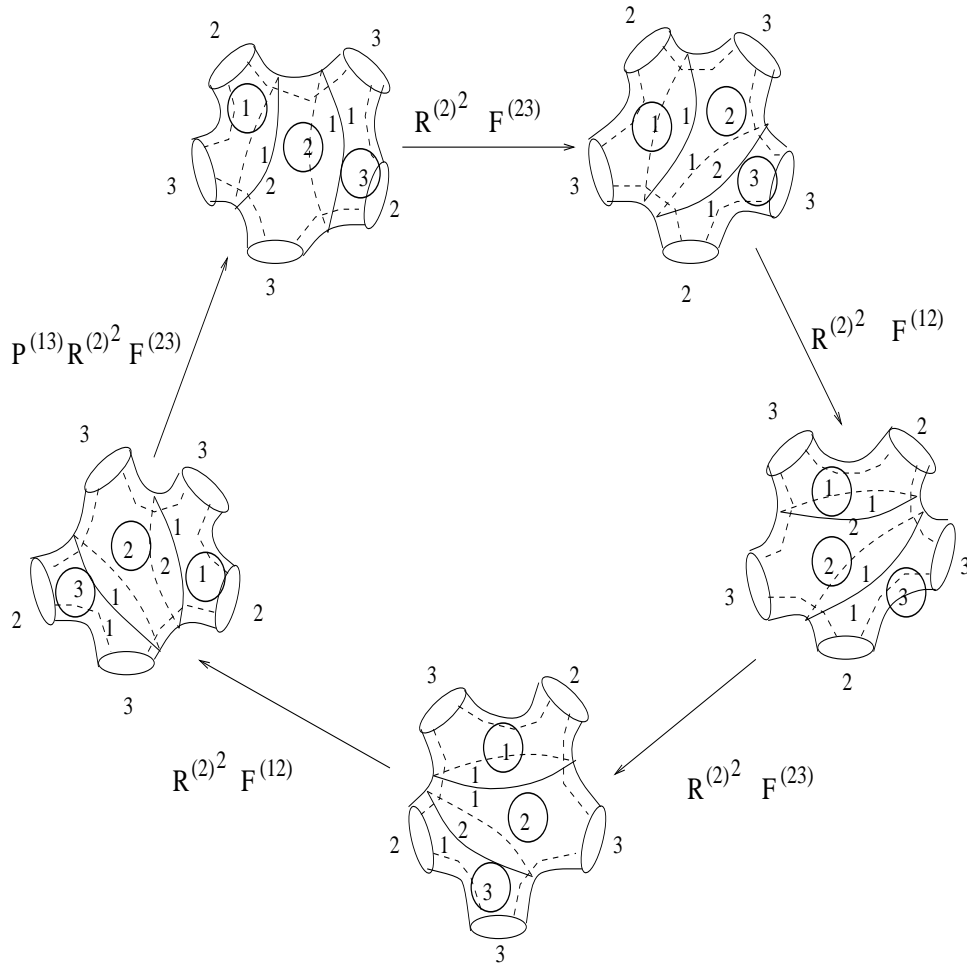

Figure 32: The pentagon

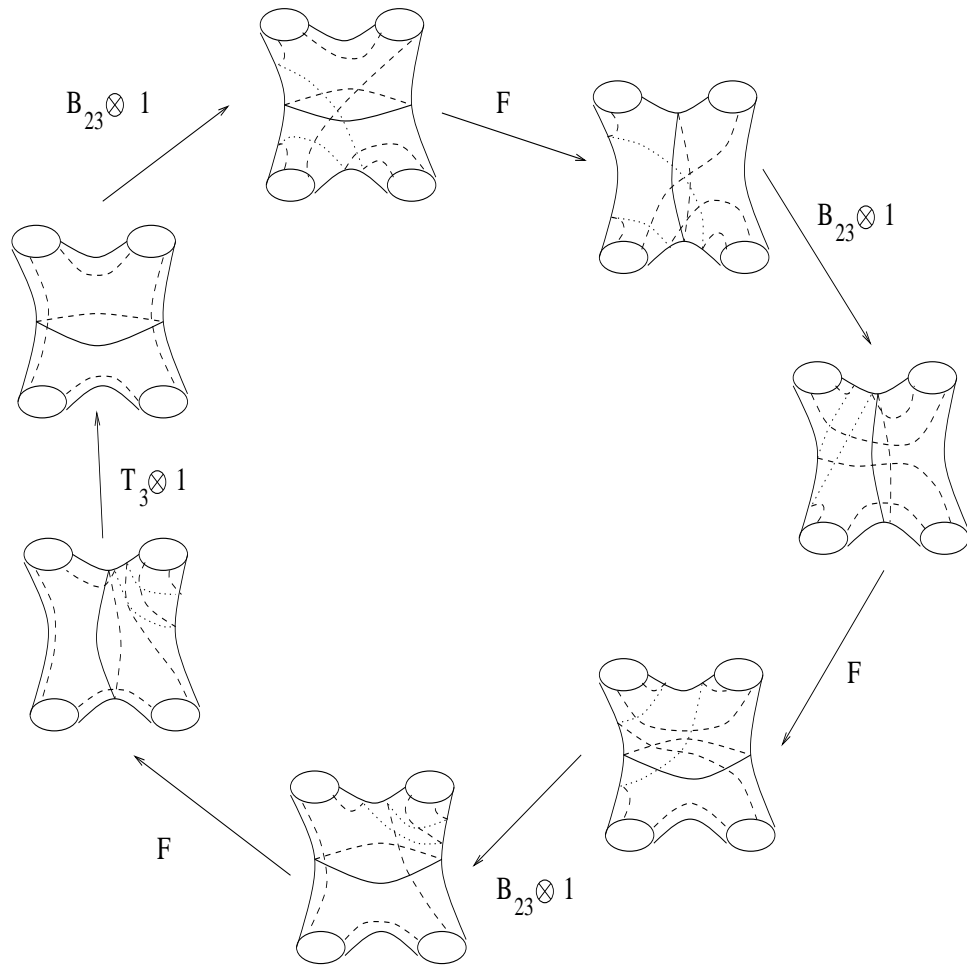

Figure 33: The  $F$ -triangle

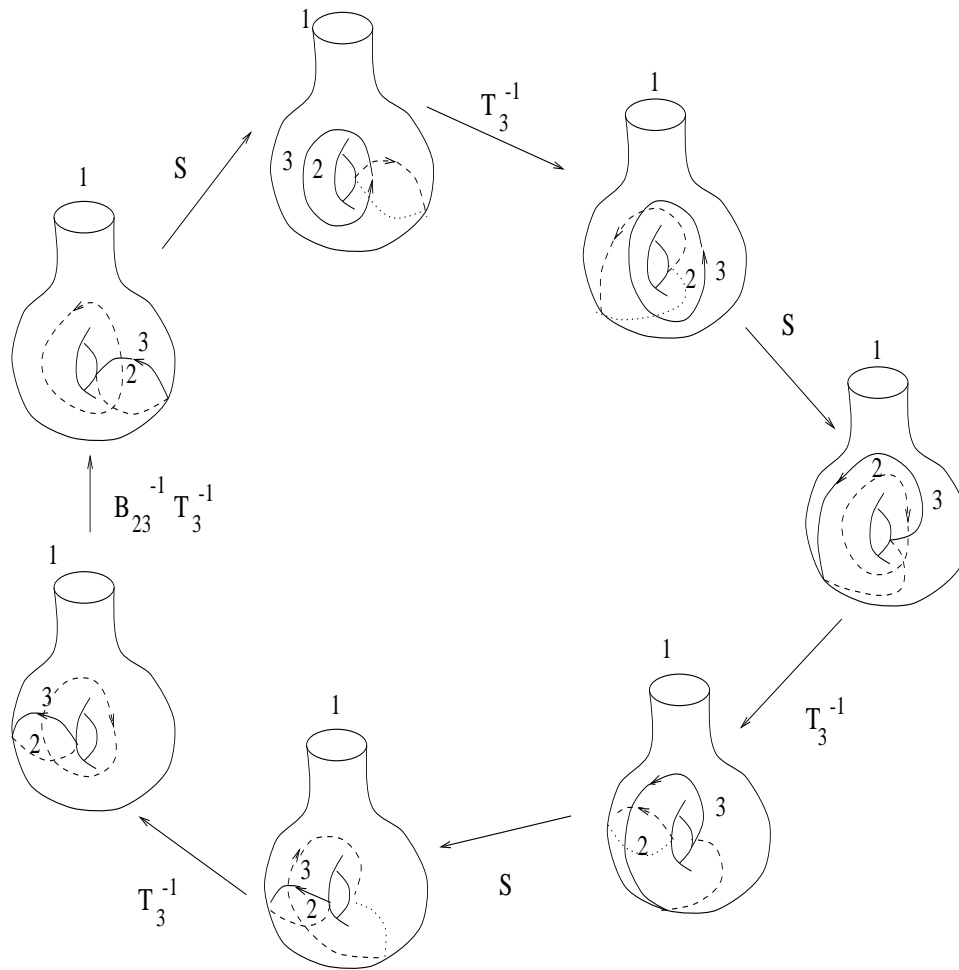

Figure 34: The  $S$ -triangle

## 4.5 Rigid structures

Let us proceed with the proof of Theorem 3.5. Fix a surface  $\Sigma$  and consider the 2-complex  $\Gamma(\Sigma)$  defined in Section 3. Recall that a rigid structure consists of the following data:

1. An overmarking  $\alpha$  inducing a DAP-decomposition of  $\Sigma$ .
2. Seams on the elementary surfaces of the DAP-decomposition.
3. Numberings of the boundary components of these elementary surfaces.
4. An ordering (segregated according to the topological type) of the surfaces in the DAP-decomposition.

The 2-cells of  $\Gamma(\Sigma)$  consist of:

1. One cell for each cycle of moves of type  $P$  when there is a corresponding cell in the group of permutations (see Fig. 31).
2. A cell for each relation 1.a)-1.d). from Theorem 3.1.
3. A cell for relations 2.a) and 2.b) in Theorem 3.1, defining inverses.
4. For each fundamental cell in the complex of overmarkings one lifting of this cell at the level of rigid structures. This means that we consider some labeling of one vertex and one system of seams and then keep tracking the labeling and the seams all over the boundary cell, possibly using the operators  $P$  and  $R$  which permute the numberings, and the twisting operators to change the seams configuration.
5. The DC-cells.
6. Four cells, each of which represents a lifting of one of the cells made up from  $D$  and  $A$ . This means that we add seams and numberings to the cells from Fig 30.

The liftings of the four fundamental cells are shown in Fig. 32 through Fig. 35. Note that in Fig. 34 we have drawn only the closed seam. The other seam is completely determined up to a twist around the boundary component labeled by 1, thus can be ignored.

To conclude the proof of the theorem consider the canonical map  $f : \Gamma(\Sigma) \rightarrow \Gamma_1(\Sigma)$  which forgets about the seams and numberings is cellular and has the following properties:

1.  $f^{-1}(z)$  is connected and simply connected for any 0-cell or 1-cell  $z$  of  $\Gamma_1(\Sigma)$ ,
2. for any 2-cell  $y$  of  $\Gamma_1(\Sigma)$  there exists a 2-cell  $x$  in  $\Gamma(\Sigma)$  such that  $f(x) = y$ .

Since  $\Gamma_1(\Sigma)$  is connected and simply connected, standard results in algebraic topology (see also [2, 28]) imply that  $\Gamma(\Sigma)$  is connected and simply connected as well.

The action of the mapping class group is given by  $f(\Sigma, r) = (\Sigma, f(r))$ , where  $f(r)$  is the image of the rigid structure  $r$  through the homeomorphism  $f$ . Since a homeomorphism is determined up to isotopy by the image of the rigid structure, the action is free. This ends the proof of Theorem 3.5.  $\square$

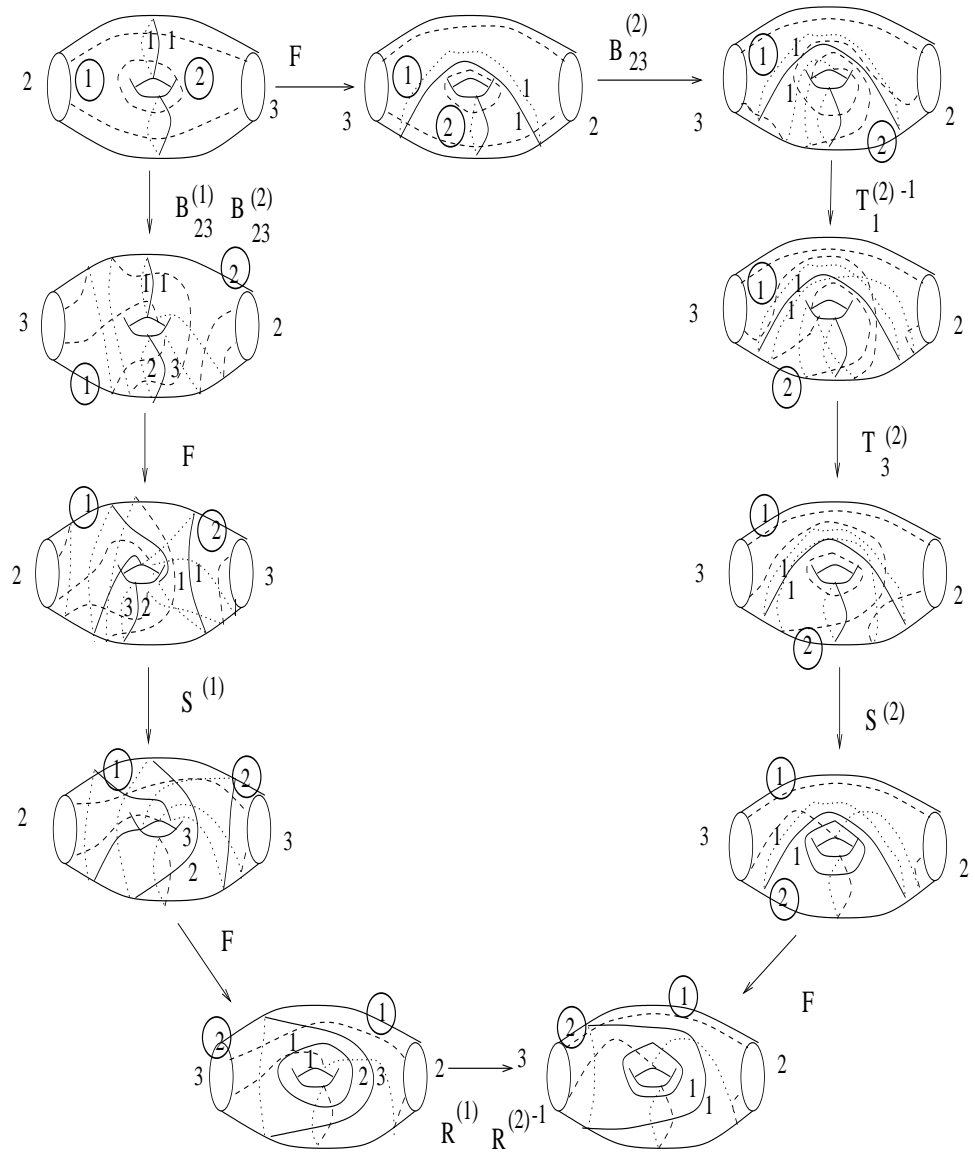

Figure 35: The  $(FSF)^2$ -cell

## 5 TQFT and representations of the duality groupoid

### 5.1 Three-dimensional TQFT's

For the sake of completeness we include some basic definitions concerning topological quantum field theories, and refer to [27] for an extensive treatment. Our presentation follows the lines developed in [10], and for simplicity we skip the case of TQFT's with anomaly, which are defined for 3-manifolds with an additional structure ( $p_1$ -structure in [7] or a 2-framing with Atiyah's terminology). The latter are related to a  $\mathbf{Z}$ -extension of our duality groupoid, which corresponds to the central extensions from [22]. It is worth mentioning that, although the case of the extended groupoid is analogous to the case of the non-extended one, all "interesting" TQFT's are extended, i.e. they arise for manifolds with additional structure. The situation is entirely similar to the description of highest weight representations of  $Diff(S^1)$ : there are no highest weight representations of  $Vect(S^1)$  but there exist interesting representations (e. g. Verma modules) for the unique central extension, namely the Virasoro algebra. This makes the presence of a central charge necessary. We think that the same phenomenon holds for the duality groupoid: if one asks the theory to have a unique cyclic vacuum vector (corresponding to the cyclic vector of a Verma module), and one also requires the theory to be unitary (i.e. to have positive energy) then we must consider a somewhat canonical central extension, which gives rise to a  $p_1$ -structure for 3-manifolds (which is the analogue of the central charge of the Virasoro algebra). The philosophy behind this correspondence is a principle known by the conformal field theory community, which basically says that *representations of the tower of mapping class groups (meaning unitary finite dimensional representations of the duality groupoid giving rise to a TQFT) correspond to representations of the Virasoro algebra*. If one implication is more or less understood, since physicists constructed CFT associated to all highest weight (positive energy) irreducible representations of the Virasoro algebra in both the discrete and the continuous series, and thus derived TQFTs via the monodromy of conformal blocks, the other implication is more difficult. We point out the references [1, 21, 3] where an action of the Virasoro algebra is implicitly carried by the moduli space of curves with local parameters around the punctures. Detailed proofs and constructions of the conformal blocks coming from the highest weight representations are given in [1, 3, 25, 26]. From this data (usually called CFT) we can construct the TQFT in 3-dimensions (see for instance [11]).

**Definition 5.1** *A TQFT in dimension 3 is a representation of the category of oriented 3-dimensional cobordisms into the category of hermitian vector spaces  $V$ .*

In other words a TQFT is a functor assigning to each oriented surface  $\Sigma$  a hermitian vector space  $W(\Sigma)$ . Then to each cobordism  $M$  between the surfaces  $\partial_+ M$  and  $\partial_- M$  one associates a linear map  $Z(M) : W(\partial_+ M) \rightarrow W(\partial_- M)$ . This data is subject to the following conditions:

1. If  $\bar{\Sigma}$  is the surface with the orientation reversed then

$$W(\bar{\Sigma}) = W(\Sigma)^*.$$

2. If  $\cup$  denotes here disjoint union, then the following quantum rule holds:

$$W(\Sigma_1 \cup \Sigma_2) = W(\Sigma_1) \otimes W(\Sigma_2).$$



3. If the cobordism  $M \circ N$  is the composition of the cobordisms  $M$  and  $N$  then

$$Z(M \circ N) = Z(M) \circ Z(N).$$

4. We assume that the ground field of the theory is  $\mathbf{C}$ , and thus we put  $W(\emptyset) = \mathbf{C}$ . The theory is called *reduced* if  $W(S^2) = \mathbf{C}$  holds, and we will restrict ourselves to reduced theories in the sequel.
5. We ask the theory to be topological, which means that  $Z(M)$  and  $W(\Sigma)$  depend only on the topological type of the manifolds.

The spaces  $W_g = W(\Sigma_g)$  associated to a surface of genus  $g$  are also called *conformal blocks* in genus  $g$ . The *monodromy* of the theory is the series of mapping class group representations defined as follows. Assume that  $\Sigma_g$  is a fixed standard surface of genus  $g$ . For any  $\varphi \in \mathcal{M}_g$  consider the mapping cylinder  $C(\varphi)$ , and set

$$\rho_g(\varphi) = Z(C(\varphi)) \in \text{End}(W_g).$$

The theory is *finite dimensional* if all conformal blocks are finite dimensional. Also the theory is said to be *cyclic* if for each  $g$  there is one orbit of the mapping class group  $\mathcal{M}_g x_g$  which spans linearly  $W_g$ . It is easy to show that in this case we can take  $x_g$  to be equal to the vector  $w_g = Z(H_g, id) \in W(\Sigma_g)$  associated by the TQFT to the standard handlebody  $H_g$  (the identification of its boundary is by the identity map). This vector is called the *vacuum* vector in genus  $g$ .

It is shown in [10] that any topological invariant  $I$  for closed 3-manifolds defines a series of representations of the mapping class group which extends canonically to a TQFT. This is the maximal TQFT associated to the invariant  $I$ . An important fact to be mentioned is that the maximal TQFT is always cyclic. Notice that the maximal TQFT is uniquely defined, but the same invariant for closed manifolds can arise from several distinct TQFT's. Starting with a certain invariant of closed manifolds, which is the restriction of a TQFT,  $Z_0$ , and using the method described above, one derives another TQFT,  $Z$  which is cyclic and contains basically the same topological information.

As an example, the  $sl_2(\mathbf{C})$ -TQFT described by Kirby and Melvin [18] is not cyclic (and therefore not maximal). The BHMV theories ([6, 7]) give rise to the same invariants for closed manifolds, and are maximal by construction. Notice that, in particular, all TQFT's which are not cyclic induce representations of the mapping class group which are not irreducible.

## 5.2 Representations of the mapping class group and TQFT

We know that any TQFT determines a series of representations of  $\mathcal{M}_g$ . The converse is also true since the latter determines the TQFT. We assume from now on that the TQFT,  $Z$  is cyclic.

A cyclic TQFT has more structure hidden in the conformal blocks: for instance using the connected sum of 3-manifolds along the boundary we derive that there is a natural (injective) homomorphism

$$W_g \otimes W_h \hookrightarrow W_{g+h},$$

induced by  $w_{g+h} = w_g \otimes w_h$ . Call the sequence  $v_g \in W_g$  a sequence of *vacuum vectors* for the representations  $\rho_g$  if  $v_{g+h} = v_g \otimes v_h$  and  $\rho_g(\mathcal{M}_g^+)v_g = v_g$ , for any  $g$ . Here  $\mathcal{M}_g^+$  denotes the mapping class group elements which arise from

homeomorphisms of  $\Sigma_g$  extending over the handlebody  $H_g$ . The TQFT is said to have *an unique vacuum* if the vector  $v_1$  which is  $\rho_g(\mathcal{M}_1^+)$  is unique and therefore equal to  $w_1$  (up to a scalar).

Let us point out that the spaces  $W_g$  are naturally endowed with a hermitian form  $\langle, \rangle: W_g \otimes W_g \rightarrow \mathbf{C}$ , given by

$$\langle X, Y \rangle = Z(X \cup \overline{Y}).$$

Here  $X, Y \in W_g$  are linear combinations of elements  $(H_g, \varphi) = \rho_g(\varphi)w_g \in W_g$ . This follows from the fact that the theory is cyclic. It suffices then to consider the case  $X = (H_g, \varphi_1)$  and  $Y = (H_g, \varphi_2)$ , where  $\varphi_j \in \mathcal{M}_g$ . The right hand side is the invariant of the manifold  $X \cup \overline{Y}$ , obtained by gluing two handlebodies  $H_g \cup \varphi_1 \varphi_2^{-1} \overline{H_g}$ , where  $H_g$  is the standard handlebody of genus  $g$ .

The TQFT is *non-degenerate* if the hermitian form  $\langle, \rangle$  is non-degenerate for all genera  $g$ . Obviously we can replace  $W(\Sigma_g)$  by  $W_g / \ker \langle, \rangle$  in order to make the theory non-degenerate, without really changing its topological content. In particular the invariants of closed manifolds are the same in both TQFT's. A TQFT is called *unitary* if the non-degenerate form  $\langle, \rangle$  is positive definite. In this case the mapping class groups act on  $W_g$  by unitary operators since the hermitian form is  $\mathcal{M}_g$ -invariant. The unitarity of the main examples of TQFT's, e.g. the  $SU(n)$ -TQFT, is the key point in many applications, for instance in obtaining the lower bounds for the genus of a knot.

We can now recover the invariant  $Z$  associated to closed 3-manifolds from the representations  $\rho_*$  and the hermitian form. The relationship between the representation and the invariant arising in the  $SU(2)$ -TQFT was obtained in [24]. Specifically we have the following result from [10]:

**Propositon 5.1** *Let  $M = H_g \cup_\varphi \overline{H_g}$  be a Heegaard splitting of the manifold  $M$ , where  $\varphi$  denotes the gluing homeomorphism. Then*

$$Z(M) = d^{-g} \langle \rho_g(\varphi)w_g, \overline{w_g} \rangle,$$

where  $d = \langle \rho_1(\iota)w_1, \overline{w_1} \rangle$  is a normalization factor,  $\iota$  being the gluing map associated to the standard Heegaard splitting of  $S^3$  into two solid tori (i.e. we choose the standard basis in the homology of the torus and  $\iota = \begin{bmatrix} 0 & -1 \\ 1 & 0 \end{bmatrix} \in SL_2(\mathbf{Z}).$ )

### 5.3 Proof of Theorem 3.2

The proof of the theorem consists basically of the construction of the representation of the 2-groupoid. We outline first the structure of a cyclic unitary TQFT with an unique vacuum, along the lines of [10].

We define the primary conformal blocks  $W_{j,k}^i$  as follows. Let  $r$  be a rigid structure on the surface  $\Sigma_g$ , made from the pants decomposition  $c$ , the seams and the various numberings. On each trinion, the set of three seams connecting the boundary components can be uniquely identified with the boundary of the neighborhood of the graph  $Y$  embedded in the pants. More precisely,  $Y$  is the graph topologically isomorphic to the letter  $Y$  and it is properly embedded in the trinion. Let us then consider one such graph for each trinion and then their union is a 3-valent graph  $\Gamma$  of genus  $g$  (possibly with some additional leaves). The graph  $\Gamma$  encodes all the informations carried by the set of seams. Notice that this is naturally embedded in the surface  $\Sigma_g$  and thus there is a natural cyclic order on the edges around each vertex. In the language of [10] we have a rigid structure, in fact equivalent to those considered in this paper.

The label set  $A$  is the set of eigenvalues and their inverses for of the Dehn twists  $T_{c_j}$  around the curves  $c_j$  in the pants decomposition. Fix a vertex  $v$  in the graph  $\Gamma$  whose adjacent edges are  $e_1, e_2, e_3$  which are dual to the curves  $c_1, c_2, c_3$  bounding a pair of pants  $p$ . Let us consider a vector  $w_g(i_1, i_2, i_3) \in W_g$  such that  $\rho_g(T_{c_\alpha})$  has  $w_g(i, j, k)$  an eigenvector of eigenvalue  $i_j$  if  $\alpha = j$  and 1 otherwise. The span  $W(i_1, i_2, i_3)$  of the orbit of the  $w_g(i_1, i_2, i_3)$  by those elements of  $\rho_g(\mathcal{M}_g)$  which come from homeomorphisms of  $\mathcal{M}_g$  which have the support on the trinion  $p$ . It was proved in [10] that  $W(i, j, k)$  does not depend of the choice of the vertex  $v$ , the rigid structure and the genus of the surface  $\Sigma_g$ . Moreover, with the convention of adding orientations to the edges of  $\Gamma$  such that on each vertex there are two incoming and one outgoing edge, one obtains this way a well-defined space denoted  $W_{i_2 i_3}^{i_1}$ . Of course one should add possible leaves to the graph, labeled all by 1, which correspond to capping of the surface with disks. These correspond to the moves of type  $D$ .

We define now graphical rules of associating vector spaces to (partially labeled) graphs. Consider an oriented trivalent graph whose edges are labeled. Each internal vertex has two incoming edges and one outgoing edge. Consider the counter-clockwise cyclic order of the incident edges of a vertex. If we label the edges by elements of the set  $A$  there is a non-ambiguous way to associate to each internal vertex a vector space  $W_{\lambda\mu}^\nu$  such that  $\nu$  is the label of the outgoing edge, and the triple  $(\lambda, \mu, \nu)$  is cyclicly ordered. We associate to the whole labeled graph  $\Gamma$  the tensor product of all spaces associated to vertices. Finally if the graph has some of its edges with fixed labels, take the sum of all the spaces obtained by the above construction, over all possible labelings of the remaining edges and call this space  $W(\Gamma)$ . Remark that these conventions make sense for an arbitrary trivalent graph.

For a closed (oriented) surface  $\Sigma_g$  of genus  $g$ , endowed with the rigid structure  $r$  we consider the subjacent pants decomposition. We associate to the rigid structure the trivalent graph  $\Gamma \subset \Sigma_g$ , whose regular neighborhood contains all seams. Notice that the rigid structure may contain an overmarking instead of a pants decompositions. Then all the circles which bound (equivalently all the leaves in the graph  $\Gamma$ ) are labeled by the unit 1. In [10] it is proved that:

**Proposition 5.2** *For a TQFT,  $Z$  which is unitary, cyclic and has unique vacuum the conformal blocks decompose in terms of the primary conformal blocks  $W_{jk}^i$ . This means that there exists a set of labels  $A$  and a set of vector spaces  $W_{jk}^i$  with the property that for a rigid structure  $r$  and a choice of a basis in each vector space  $W_{jk}^i$  (i.e. we fix the internal symmetries) there exists a canonical isomorphisms  $\Phi(\sigma) : W_g \rightarrow W(\Gamma)$ .*

Returning to the proof, consider two rigid structures  $\sigma$  and  $\sigma'$  such that  $\sigma = \varphi\sigma'$  for some  $\varphi \in \mathcal{M}_g$ . It follows that the endomorphism of  $W_g$  given by  $\Phi(\sigma)\Phi(\sigma')^{-1}$  is equal to  $\rho_g(\varphi)$ . For two arbitrary rigid structures  $\sigma$  and  $\sigma'$ , there exists a unique element  $[\sigma, \sigma']$  of the duality groupoid sending  $\sigma$  into  $\sigma'$ . We associate to this element  $[\sigma, \sigma']$  the isomorphisms of vector spaces  $\Phi([\sigma, \sigma']) = \Phi(\sigma')^{-1}\Phi(\sigma) : W(\Gamma) \rightarrow W(\Gamma')$ . We define in this way a representation of the 2-groupoid. The only remark to add is that this map is local, that is if  $\sigma$ , and  $\sigma'$  are identical out of the rigid structures  $\sigma_0$  and respectively  $\sigma'_0$  on some subsurface then  $\Phi([\sigma, \sigma']) = \Phi([\sigma_0, \sigma'_0]) \otimes 1$ , where 1 acts on the other factors of the tensor product, not coming from the subsurface. This proves the theorem.

As a final remark, the representation of the duality groupoid for the case of the BHMV topological quantum field theory [6, 7] was given in [12]. The fact that the topological quantum field theory from [18] is not cyclic produces a sign

obstruction for constructing a representation of the duality groupoid in this case. One can construct a representation of an extension of this groupoid obtained by adding auxiliary structure on the boundary of 3-manifolds [13].

## References

- [1] B. Arbarello, C. De Concini, V. Kac, C. Procesi, Moduli spaces of curves and representation theory, *Commun. Math. Phys.*, 117(1988), 1-36.
- [2] B. Bakalov and A. Kirillov Jr., On the Lego-Teichmuller game, preprint, mathGT/9809057, 33p.
- [3] A. Beilinson and V. Schechtman. Determinant bundles and Virasoro algebras, *Commun. Math. Phys.*,118(1988), 651-701.
- [4] J. Birman. *Braids, links and mapping class groups*, Ann. Math. Studies, Princeton Univ. Press, no. 82, 1974.
- [5] J. Birman and B. Wajnryb. Errata: The presentation of the mapping class group, *Israel J. Math.*, 88(1994), 425-427.
- [6] C. Blanchet, N. Habegger, G. Masbaum and P. Vogel. Three-manifold invariants derived from the Kauffman bracket, *Topology*, 31(1992),685-699.
- [7] C. Blanchet, N. Habegger, G. Masbaum and P. Vogel. Topological Quantum Field Theories derived from the Kauffman bracket, *Topology*, 34(1995), 883-927.
- [8] J. Cerf. La stratification naturelle des espaces de fonctions différentiables réelles et le théorème de la pseudo-isotopie, *Publ. I.H.E.S.* 39(1970), 185-353.
- [9] Ch. Frohman, J. Kania-Bartoszyńska,  $SO(3)$  topological quantum field theory, *Commun. Anal. Geom.* 4(1996), 589-679.
- [10] L. Funar. 2+1-D Topological Quantum Field Theory and 2-D Conformal Field Theory, *Commun. Math. Phys.*, 171(1995), 405-458.
- [11] L. Funar. TQFT for general Lie algebras and applications to open 3-manifolds, *J.Math.Sciences, Univ. of Tokyo*, 7(1997), 121-181.
- [12] R. Gelca. Topological quantum field theory with corners based on the Kauffman bracket, *Comment. Math. Helv.*, 72(1997), 216-243.
- [13] R. Gelca. The  $SL(2,C)$  Topological Quantum Field Theory with corners, *J. Knot Theory Ramifications*, 7(1998), 893-906.
- [14] S. Gervais. Presentations and central extensions of mapping class groups, *Trans. A.M.S.*, 348(1996), 3097-3132.
- [15] J. Harer. The second homology group of the mapping class group of an orientable surface, *Inventiones Math.*, 72((1983), 221-237.
- [16] A. Hatcher, P. Lochak and L. Schneps. On the Teichmuller tower of mapping class groups, *J.Reine Angew. Math.*, (to appear).
- [17] A. Hatcher and W. Thurston. A presentation for the mapping class group of a closed orientable surface, *Topology*, 19(1980), 221-237.

- [18] R. Kirby and P. Melvin. The 3-manifold invariant of Witten and Reshetikhin-Turaev for  $sl_2(\mathbf{C})$ , *Inventiones Math.*, 105(1991), 473-545.
- [19] T. Kohno. Topological invariants for 3-manifolds using representations of mapping class groups I, *Topology*, 31(1992), 203-230.
- [20] T. Kohno. Topological invariants for 3-manifolds using representations of mapping class groups II, *Contemporary Math.*, vol. 175, 1994, 193-217.
- [21] M. Kontsevich. Virasoro algebra and Teichmüller spaces. *Funct. An. Appl.*, 21(1987), 156-157.
- [22] G. Masbaum and J. Roberts. On central extensions of mapping class groups, *Math. Annalen*, 302(1995), 131-150.
- [23] G. Moore and N. Seiberg. Classical and quantum field theory, *Commun. Math. Phys.*, 123(1989), 177-254.
- [24] J. Roberts. Skeins and mapping class groups, *Math. Proc. Cambridge Phil. Soc.*, 115(1994), 53-77.
- [25] A. Tsuchiya and Y. Kanie. Vertex operators in two dimensional conformal field theory on  $P^1$  and monodromy representations of braid groups, *Adv. Studies Pure Math., Tokyo*, vol.16, 1988, 297-372.
- [26] A. Tsuchiya, K. Ueno and Y. Yamada. Conformal field theory on universal family of stable curves with gauge symmetries, *Adv. Studies Pure Math., Tokyo*, vol.19, 1989, 459-566.
- [27] V. Turaev. *Quantum invariants of knots and 3-manifolds*, vol.18. de Gruyter Studies in Math., 1994.
- [28] K. Walker. Chern-Simons-Witten invariants of 3-manifolds, *preprint*, 1991.
- [29] B. Wajnryb. A simple presentation of the mapping class group of an orientable surface, *Israel J. Math.*, 45(1983), 157-174.
- [30] E. Witten. Quantum field theory and the Jones polynomial, *Commun. Math. Phys.*, 121(1989), 351-399.