

Billiards and two-dimensional problems of optimal resistance

A. Yu. Plakhov*

Abstract

A body moves in a medium composed of noninteracting point particles; interaction of particles with the body is absolutely elastic. It is required to find the body's shape minimizing or maximizing resistance of the medium to its motion. This is the general setting of optimal resistance problem going back to Newton.

Here, we restrict ourselves to the two-dimensional problems for rotating (generally non-convex) bodies. The main results of the paper are the following. First, to any compact connected set with piecewise smooth boundary $B \subset \mathbb{R}^2$ we assign a measure ν_B on $\partial(\text{conv}B) \times [-\pi/2, \pi/2]$ generated by the billiard in $\mathbb{R}^2 \setminus B$ and characterize the set of measures $\{\nu_B\}$. Second, using this characterization, we solve various problems of minimal and maximal resistance of rotating bodies by reducing them to special Monge-Kantorovich problems.

Mathematics subject classifications: 49K30, 49Q10

Key words and phrases: bodies of minimal and maximal resistance, billiards, Newton's aerodynamic problem, Monge-Kantorovich problem, optimal mass transportation

1 Introduction

A body moves in a homogeneous medium consisting of point particles. The medium is very rare, so that mutual interaction of particles can be neglected.

*Department of Mathematics, Aveiro University, Aveiro 3810, Portugal

The particles interact with the body in the absolutely elastic manner; each particle performs several (maybe zero) collisions and moves freely afterwards. It is required to find a body, out of a given class of bodies, such that resistance of the medium to the body's motion is minimal.

This is the general setting of minimal resistance problem. In order to specify it, one needs to determine the class of bodies, the kind of motion (for example, translational motion or a combination of translational and rotational motion), and the state of medium (the particles may rest as well as perform thermal motion). The problem can be stated not only in \mathbb{R}^3 , but also in spaces of other dimensions; besides, the problems of *maximal* resistance can be considered as well.

This problem goes back to Newton; he considered the class of convex axially symmetric bodies of fixed length along the symmetry axis and fixed maximal cross section orthogonal to this axis. A body of the class moves in a medium of particles at rest, the velocity being parallel to the symmetry axis. The solution of this problem is a body whose boundary is composed of front and rear flat disks and a smooth strictly convex lateral surface [1].

Since then, the problem has been studied by many mathematicians, including Euler and Legendre; among other results, there were found solutions in various classes of axisymmetric convex bodies. Since the early 1990th, there have been obtained new interesting results related to the minimization problem in classes of non-symmetric and/or non-convex bodies [2]-[10]. It was proved, in particular, that in the class of convex (generally non-symmetric) bodies of fixed length and width the solution exists and does not coincide with Newton's one [2, 3, 4, 7, 5]. The solution was obtained numerically [10]. There was found analytically the solution in the more restricted class of convex bodies with developable lateral surface [6]. Also, there were obtained solutions in some classes of non-convex bodies satisfying the so-called *single impact assumption* meaning that each particle collides with the body at most once [8, 9]. Further, it was shown that generically, in classes of non-convex bodies where multiple collisions are allowed, infimum of resistance is zero, that is, there exist almost perfectly streamlined bodies [11, 12]. This result is based on the study of some special billiards in unbounded regions in \mathbb{R}^3 . It is essentially three-dimensional: for the two-dimensional analogue of the problem, infimum is positive [12].

The problems involving rotational motion of bodies and/or thermal motion of particles are more relevant to real life. Some of them, concerning classes of *convex* bodies, are solved in [13] and [14], for the case of slowly uni-

formly rotating convex bodies of fixed volume and the case of translational motion of axially symmetric convex bodies in media of positive temperature, respectively. As applied to classes of *non-convex* bodies, these problems seem to be more difficult: to calculate resistance, one needs to know the relation between the initial and final velocity of each particle interacting with the body; in the case of multiple collisions the calculation may turn out to be very involved. Nevertheless, as will be shown below, these difficulties can be overcome. Here, we restrict ourselves to the two-dimensional case; the three-dimensional case is postponed to the future.

In what follows, instead of a body moving in a medium, we shall consider a flux of particles falling on the body. The body may rest and may rotate around a fixed point. This picture is equivalent to the initial one and usually is more convenient.

Our approach is as follows. Each body (a compact connected subset of \mathbb{R}^2 with piecewise smooth boundary) is limited by a curve composed of a "convex part" and a number of "cavities". Each particle, interacting with the body, either reflects only once from the convex part of curve, or, otherwise, gets into a cavity, makes there a series of reflections, and eventually gets out of the cavity and leaves the body forever. Define the angles of "getting in" and "getting out" by φ and φ^+ ; to any cavity one assigns a measure describing the joint distribution of φ and φ^+ . Resistance of the body is determined by these *measures generated by the cavities*, therefore characterization of these measures is a key question for a wide range of problems of minimal and maximal resistance.

This characterization is the main issue of the present work: we determine closure, in the weak topology, of the set of measures generated by cavities. The proof of this result is based on construction of a family of cavities of special form and on a detailed analysis of billiard dynamics in such cavities. We then apply this result to the problem of optimal *mean resistance* for the classes of (generally non-convex) bodies containing or being contained in a given convex bounded set K . The bodies are subject to slow uniform motion. By mean resistance, we understand the time averaged value of resistance. The problem reduces to some special one-dimensional Monge-Kantorovich problems of optimal mass transfer; solving them, one finds that infimum and supremum of mean resistance are equal to 0.9878... and to 1.5, respectively, where resistance of K is taken to be 1.

The paper is organized as follows. In section 2, to each body B one assigns a measure ν_B : the linear combination of a measure generated by the convex

part of its boundary and measures generated by the cavities. The main theorem, consisting in characterization of the set of measures ν_B , is stated and then applied to the problem of optimal mean resistance for rotating bodies. In section 3 the auxiliary result, consisting in characterization of the set of measures generated by cavities, is formulated. Basing on this result, we prove the main theorem. Finally, in section 4, the auxiliary result is proved.

2 Main theorem

2.1 Statement of main theorem

Let $B \subset \mathbb{R}^2$ be a compact connected subset of Euclidean space \mathbb{R}^2 with piecewise smooth boundary. The last means that B is determined by a finite number of relations $f_i(x) \geq 0$, $f_i \in C^1(\mathbb{R}^2)$, besides $\nabla f_i(x) \neq 0$, whenever $f_i(x) = 0$, and the vectors $\nabla f_i(x)$ and $\nabla f_j(x)$ are not collinear, whenever $f_i(x) = 0$, $f_j(x) = 0$, $i \neq j$.

Consider the billiard in $\mathbb{R}^2 \setminus B$. Consider a billiard particle whose trajectory intersects the convex hull of B , $\text{conv}B$. Initially the particle moves freely in $\mathbb{R}^2 \setminus B$ with a unit velocity v . Let x be the point of first intersection of the particle with $\partial(\text{conv}B)$; denote by n_x the unit outer normal vector to $\partial(\text{conv}B)$ at x and denote by $\varphi \in [-\pi/2, \pi/2]$ the angle between n_x and $-v$. Let us agree that the angle is counted from n_x to $-v$ clockwise. Thus, to each particle motion one assigns a value $(x, \varphi) \in \partial(\text{conv}B) \times [-\pi/2, \pi/2]$.

After intersecting $\partial(\text{conv}B)$, the particle moves inside $\text{conv}B \setminus B$, elastically reflecting off the boundary ∂B , then intersects $\partial(\text{conv}B)$ again and moves freely afterwards. It may also happen that at some moment the particle gets into a singular point of the boundary ∂B , or its trajectory touches the boundary, or it makes an infinite number of reflections on a finite time interval, or the particle will stay inside $\text{conv}B$ forever. The set of values (x, φ) , for which one of these events happens, has zero measure (see., e.g., [16]) and therefore will be excluded from our consideration. Note that by this agreement, the cases $\varphi = \pi/2$ and $-\pi/2$ are excluded, therefore the particle intersects $\partial(\text{conv}B)$ two times: when getting *in* and when getting *out*.

Let $x^+ = x_B^+(x, \varphi)$ be the point of second intersection. Denote by $\varphi^+ = \varphi_B^+(x, \varphi) \in [-\pi/2, \pi/2]$ the angle between the normal n_{x^+} and the velocity of final free motion v^+ . Like φ , the angle φ^+ is measured from n_{x^+} to v^+ clockwise.

Note that the set $\partial(\text{conv}B) \setminus \partial B$ is a union of a finite or countable (maybe empty) family of mutually disjoint open intervals, $\partial(\text{conv}B) \setminus \partial B = I_1 \cup I_2 \cup \dots$. The set $\text{conv}B \setminus B$ is decomposed into several connected components; denote by Ω_i the closure of the connected component containing I_i , $i \geq 1$. All the sets Ω_i are different.

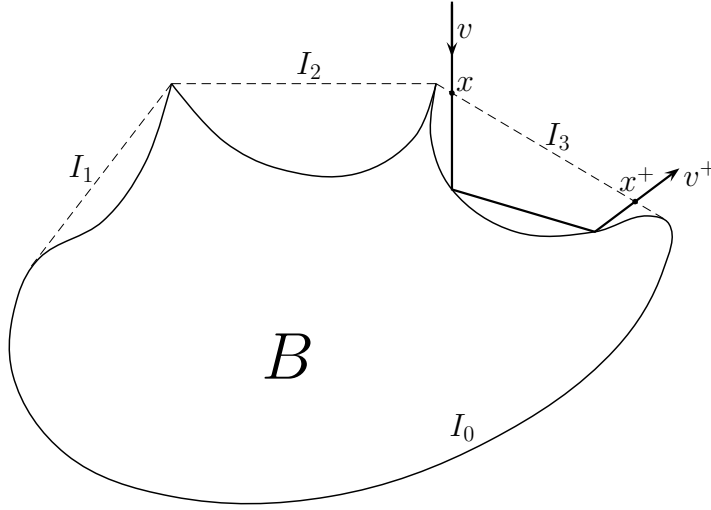

Designate by $I_0 := \partial(\text{conv}B) \cap \partial B$ the *convex part* of the boundary ∂B ; thus, one has

$$\partial(\text{conv}B) = I_0 \cup I_1 \cup I_2 \cup \dots$$

If the point of first intersection x belongs to I_0 then $x^+ = x$, $\varphi^+ = -\varphi$, and the time interval of staying of the particle within $\text{conv}B$ reduces to a point. If, otherwise, x belongs to an interval I_i , $i \geq 1$ then the intersection of the particle trajectory with $\text{conv}B$ entirely belongs to Ω_i and x^+ belongs to the same interval I_i . In both cases one has $n_{x^+} = n_x$.

Define a Borel measure $\mu = \mu_{\text{conv}B}$ on the set $\partial(\text{conv}B) \times [-\pi/2, \pi/2]$ by $d\mu(x, \varphi) = \cos \varphi dx d\varphi$, where dx is the element of length on $\partial(\text{conv}B)$. Consider the mapping $\mathcal{T}_B : (x, \varphi) \mapsto (x^+, \varphi^+)$. It is a one-to-one mapping of a full measure subset of $\partial(\text{conv}B) \times [-\pi/2, \pi/2]$ onto itself; moreover, the following holds:

T1 \mathcal{T}_B preserves the measure μ ;

T2 $\mathcal{T}_B = \mathcal{T}_B^{-1}$.

Actually, the conditions T1 and T2 are derived from the fact that a bil-

liard dynamical system preserves the Liouville measure and is invariant with respect to time inversion.

The sets $I_i \times [-\pi/2, \pi/2]$ are invariant with respect to the mapping \mathcal{T}_B ; denote by \mathcal{T}_B^i the restriction of \mathcal{T}_B to $I_i \times [-\pi/2, \pi/2]$. The restriction of μ to $I_i \times [-\pi/2, \pi/2]$ will be also designated by μ . Each mapping \mathcal{T}_B^i transforms a subset of full measure of $I_i \times [-\pi/2, \pi/2]$ onto itself and also satisfies T1 and T2.

Denote by $|\partial(\text{conv}B)|$ the length of the curve $\partial(\text{conv}B)$, by $|I_i|$, the length of I_i , $i = 1, 2, \dots$, and by $|I_0|$, the length of I_0 : $|I_0| = |\partial(\text{conv}B)| - \sum_{i \geq 1} |I_i|$. Denote also $\kappa_i = |I_i|/|\partial(\text{conv}B)|$; one has $\sum_i \kappa_i = 1$. Define Borel measures ν_B, ν_B^i on the square $Q := [-\pi/2, \pi/2] \times [-\pi/2, \pi/2]$ as follows: for any measurable set $A \subset Q$,

$$\nu_B(A) := \frac{1}{|\partial(\text{conv}B)|} \mu \left(\{(x, \varphi) \in \partial(\text{conv}B) \times [-\pi/2, \pi/2] : (\varphi, \varphi_B^+(x, \varphi)) \in A\} \right),$$

$$\nu_B^i(A) := \frac{1}{|I_i|} \mu \left(\{(x, \varphi) \in I_i \times [-\pi/2, \pi/2] : (\varphi, \varphi_B^+(x, \varphi)) \in A\} \right).$$

These definitions imply that $\nu_B = \sum_i \kappa_i \nu_B^i$.

Note that the measures ν_B, ν_B^i remain unchanged under translations, rotations and similarity transformations of B . The total measures are $\nu_B(Q) = \nu_B^i(Q) = 2$ for any i .

Define the Borel measure λ on $[-\pi/2, \pi/2]$ by $d\lambda(\varphi) = \cos \varphi d\varphi$, denote by $\pi^1, \pi^2 : Q \rightarrow [-\pi/2, \pi/2]$ the projections $\pi^1(\varphi, \varphi^+) = \varphi$, $\pi^2(\varphi, \varphi^+) = \varphi^+$, and denote by $\pi^{\text{diag}} : Q \rightarrow Q$ the symmetry with respect to the diagonal $\varphi = \varphi^+$: $\pi^{\text{diag}}(\varphi, \varphi^+) = (\varphi^+, \varphi)$. Denote by \mathcal{M} the set of Borel measures ν on Q such that

A1 both orthogonal projections of ν to the coordinate axes coincide with λ ; that is, $\pi_{\#}^1 \nu = \lambda = \pi_{\#}^2 \nu$;

A2 the measure ν is symmetric with respect to the diagonal $\varphi = \varphi^+$; that is, $\pi_{\#}^{\text{diag}} \nu = \nu$.

The measures ν_B, ν_B^i satisfy the conditions A1 and A2; that is,

$$\nu_B, \nu_B^i \in \mathcal{M}.$$

This property can be easily derived from the conditions T1 and T2 for the mappings T_B and T_B^i ; see also [13].

Note that there exists a unique measure $\nu^0 \in \mathcal{M}$ whose support belongs to the diagonal $\varphi = -\varphi^+$. If $|I_0| > 0$ then one has $\nu_B^0 = \nu^0$. Moreover, if B is convex then the family $\{I_i\}$ contains a unique element I_0 , therefore $\nu_B = \nu^0$.

Let us give a mechanical interpretation of the measures ν_B and ν_B^i . A two-dimensional body B at rest is situated in a medium of non-interacting identical point particles, moving in all possible directions. The medium is uniform and isotropic, that is, its density is constant and velocities of particles, contained in any space region at any time instant, are uniformly distributed on the unit circumference. When colliding with the body, the particles are elastically reflected by it. For any particle, interacting with the body, mark φ and φ^+ , the angles of "getting in" and "getting out" at the moments of intersection with $\partial(\text{conv}B)$. The measure ν_B describes the normalized joint distribution over φ and φ^+ of the number of particles that have been interacted with the body during a fixed time interval. The normalizing factor is chosen in such a way that the normalized total number of particles that have been interacted with the body equals 2. The measures ν_B^i describe the normalized joint distribution over φ and φ^+ of the number of particles that first intersected I_i during a fixed time interval. The normalizing factor is chosen in such a way that the normalized total number of particles that first intersected I_i during this time interval equals 2.

Any measure ν_B belongs to \mathcal{M} . In the present paper we are interested in an inverse question: *is it true that any measure from \mathcal{M} can be approximated by measures ν_B ?* The positive answer to this question is given by the following theorem.

Let K_1 and K_2 be compact convex sets such that $K_1 \subset K_2$ and $\text{dist}(\partial K_1, \partial K_2) > 0$. Denote by \mathcal{B}_{K_1, K_2} the class of compact connected sets B with piecewise smooth boundary such that $K_1 \subset B \subset K_2$.

Theorem 1. *The set $\{\nu_B, B \in \mathcal{B}_{K_1, K_2}\}$ is everywhere dense in \mathcal{M} in the weak topology, that is, for any $\nu \in \mathcal{M}$ there exists a family of sets $\{B_\varepsilon, \varepsilon > 0\} \subset \mathcal{B}_{K_1, K_2}$ such that for any continuous function $f : Q \rightarrow \mathbb{R}$,*

$$\lim_{\varepsilon \rightarrow +0} \int_Q f d\nu_{B_\varepsilon} = \int_Q f d\nu.$$

2.2 Applications of main theorem

Let us illustrate on examples that this theorem is useful when solving problems of minimization and maximization of aerodynamic resistance.

Example 1 On a rotating body in \mathbb{R}^2 is incident a flux of point particles. Density of the flux is constant; all the particles have an equal velocity. When

colliding with the body, the particles are reflected by it according to the law of elastic reflection. The particles do not mutually interact. The body is fixed at some point and rotates around it with a constant angular velocity. The rotation velocity is small: at each moment, the linear velocity of any point of the body is much less than the flux velocity. Thus, when considering interaction of the body with any individual particle, one can neglect the effect of rotation.

The force of pressure of the flux on the body is a periodic vector-valued function with the period equal to the period of the body rotation. The mean value of this function — let it call *mean resistance* — is a vector parallel to the flux velocity. It is required to find infimum of mean resistance

- (a) in the class of *convex* bodies of given area;
- (b) in the class of (generally *non-convex*) bodies of given area.

Denote by B the set occupied by the body at the zero instant. The mean resistance is equal (up to a factor proportional to the medium density and to the squared flux velocity) to

$$\bar{R}(B) = |\partial(\text{conv}B)| \cdot \mathcal{F}(\nu_B), \quad (1)$$

where

$$\mathcal{F}(\nu) = \iint_Q (1 + \cos(\varphi - \varphi^+)) d\nu(\varphi, \varphi^+). \quad (2)$$

(a) If B is convex then $\nu_B = \nu^0$ and $\text{conv}B = B$, hence $\bar{R}(B) = |\partial B| \cdot \mathcal{F}(\nu^0)$. Thus, the minimal resistance problem reduces to an isoperimetric problem: find a convex set B with fixed area S and minimal perimeter ∂B . The solution is a circle $B^{(r)}$ of radius $r = \sqrt{S/\pi}$; minimal resistance equals $\bar{R}(B^{(r)}) = 2\sqrt{\pi S} \cdot \mathcal{F}(\nu^0)$. Note that

$$\mathcal{F}(\nu^0) = \iint_Q (1 + \cos(\varphi - \varphi^+)) d\nu^0(\varphi, \varphi^+) = \int_{-\pi/2}^{\pi/2} (1 + \cos 2\varphi) \cos \varphi d\varphi = 8/3.$$

- (b) In the non-convex case the problem is solved in three steps.
 - (i) Find

$$\inf_{\nu \in \mathcal{M}} \mathcal{F}(\nu);$$

this is a one-dimensional *Monge-Kantorovich mass transport problem* with the cost function $c(\varphi, \varphi^+) = 1 + \cos(\varphi - \varphi^+)$ and with both marginal measures

equal to λ . It was solved in [13]; the minimizing measure ν_* satisfies the relation

$$\frac{\mathcal{F}(\nu_*)}{\mathcal{F}(\nu^0)} = 0.9878\dots$$

(ii) Using theorem 1, by diagonal method choose a sequence of sets B'_n such that $B^{(r)} \subset B'_n \subset B^{(r+\frac{1}{n})}$ and the sequence of measures $\nu_{B'_n}$ weakly converges to ν_* .

(iii) Make similarity transformations $B_n = k_n B'_n$ in such a way that the areas of all obtained sets B_n are equal to S . The obtained sequence of sets is a solution of the minimization problem.

Indeed, whatever the set B of area S , the length $\partial(\text{conv}B)$ is not less than the perimeter of a circle of area S , that is, $|\partial(\text{conv}B)| \geq |\partial B^{(r)}| = 2\sqrt{\pi S}$; moreover, $\mathcal{F}(\nu_B) \geq \mathcal{F}(\nu_*)$. Hence, $\bar{R}(B) \geq 2\sqrt{\pi S} \cdot \mathcal{F}(\nu_*)$.

On the other hand, one has $\lim_{n \rightarrow \infty} k_n = 1$ and $|\partial B^{(r)}| \leq |\partial(\text{conv}B'_n)| \leq |\partial B^{(r+1/n)}|$, hence $\lim_{n \rightarrow \infty} |\partial(\text{conv}B_n)| = |\partial B^{(r)}|$. Further, one has $\lim_{n \rightarrow \infty} \mathcal{F}(\nu_{B_n}) = \mathcal{F}(\nu_*)$. This implies that $\lim_{n \rightarrow \infty} \bar{R}(B_n) = 2\sqrt{\pi S} \cdot \mathcal{F}(\nu_*)$.

The ratio of least resistance for *non-convex* bodies of fixed area to least resistance for *convex* bodies of the same area equals

$$\frac{\lim_{n \rightarrow \infty} \bar{R}(B_n)}{\bar{R}(B^{(r)})} = \frac{\mathcal{F}(\nu_*)}{\mathcal{F}(\nu^0)} = 0.9878\dots$$

Thus, the gain is approximately 1.22%.

Example 2 Like in the previous example, consider the functional of mean resistance $\bar{R}(B)$ (1,2). The following problems are under consideration:

(a) find $\inf \bar{R}(B)$ in the class of sets B containing a given convex bounded set K ;

(b) find $\sup \bar{R}(B)$ in the class of sets B contained in a given convex bounded set K with nonempty interior.

The problem (a) is solved in the same way as the problem (b) of the previous example; one constructs a sequence of sets B_n^* such that the sequence $\nu_{B_n^*}$ weakly converges to ν_* and, moreover, $K \subset B_n^* \subset (1 + 1/n)K$. Here and in what follows, $\kappa K := \{\kappa x : x \in K\}$ designates the set obtained from K by the homothety with center at the origin and ratio κ . The sequence B_n^* minimizes resistance; the following relations hold: $\lim_{n \rightarrow \infty} |\partial(\text{conv}B_n^*)| = |\partial K|$ and $\lim_{n \rightarrow \infty} \mathcal{F}(\nu_{B_n^*}) = \mathcal{F}(\nu_*)$. On the other hand, one has $\bar{R}(K) =$

$|\partial K| \cdot \mathcal{F}(\nu^0)$, hence

$$\frac{\lim_{n \rightarrow \infty} \bar{R}(B_n^*)}{\bar{R}(K)} = 0.9878\dots$$

Now, consider the problem (b). Let us first note that there exists a unique measure $\nu^* \in \mathcal{M}$ whose support belongs to the diagonal $\varphi = \varphi^+$. One has $\mathcal{F}(\nu^*) = \int_{-\pi/2}^{\pi/2} 2 \cos \varphi d\varphi = 4$. This measure maximizes the functional \mathcal{F} :

$$\max_{\nu \in \mathcal{M}} \mathcal{F}(\nu) = \mathcal{F}(\nu^*) = 4.$$

Further, one constructs a sequence of sets B_n^* such that $\nu_{B_n^*}$ weakly converges to ν^* and $(1 - 1/n)K \subset B_n^* \subset K$. This sequence maximizes resistance: one has $\lim_{n \rightarrow \infty} |\partial(\text{conv} B_n^*)| = |\partial K|$, $\lim_{n \rightarrow \infty} \mathcal{F}(\nu_{B_n^*}) = \mathcal{F}(\nu^*)$, therefore

$$\frac{\lim_{n \rightarrow \infty} \bar{R}(B_n^*)}{\bar{R}(K)} = 1.5.$$

Thus, there are constructed two sequences of sets approximating K and providing solutions for the problems of minimal and maximal resistance. The limit value of resistance for the first sequence is 1.22% less than resistance of K , and for the second sequence, 50% more. Note in passing that boundaries of the sets of both sequences approximate boundary of the limit set, ∂K , in C^0 , but not in C^1 .

Like in these examples, one can put other problems of resistance minimization and maximization for two-dimensional bodies performing translational and/or rotational motion in rarefied medium, and reduce these problems to special one-dimensional problems of Monge-Kantorovich mass transfer. In this approach, of importance are the assumptions that the medium is rarefied enough, so that mutual interaction of particles can be neglected, and that the collisions of particles with the body are absolutely elastic. The particles may rest, and may perform chaotic thermal motion. The body's rotation may be uniform or non-uniform. The velocity of rotational motion may be small as compared to the velocity of translational motion, and may be comparable to it. Many problems of this kind reduce to minimization or maximization problems for functionals similar to (2). The functionals are defined on \mathcal{M} , and the cost function is determined by a particular problem under consideration. The work in this direction is in progress. Another important task is generalization of this approach to the three-dimensional case.

3 Auxiliary result

In this section, an auxiliary statement, theorem 2, is formulated, and basing on this statement, theorem 1 is derived.

3.1 Statement of the auxiliary result

Let $\Omega \subset \mathbb{R}^2$ be a compact set with piecewise smooth boundary. Denote by dx the element of length on $\partial\Omega$ and define the Borel measure $\mu = \mu_\Omega$ on $\partial\Omega \times [-\pi/2, \pi/2]$ by $d\mu(x, \varphi) = \cos \varphi dx d\varphi$. The billiard in Ω generates the mapping $T = T_\Omega$ in the following way. Let $x \in \partial\Omega$ be a regular point of the boundary and let $-\pi/2 < \varphi < \pi/2$. Find the unit vector v such that the angle between $-n_x$ and v is φ ; recall that n_x designates the unit outer normal vector to $\partial\Omega$ at x and that the angle is counted from $-n_x$ to v clockwise. From x , launch a ray in the direction v , denote by x' the point of first intersection of the ray with $\partial\Omega$ and, if x' is a regular point of the boundary, reflect the vector v off the boundary according to the law of absolutely elastic reflection. The reflected vector equals $v' = v - 2(v, n_{x'})n_{x'}$. Denote by φ' the angle that v' makes with $-n_{x'}$; the angle is counted from $-n_{x'}$ to v' clockwise. By definition, $T(x, \varphi) = (x', \varphi')$. It is well known that T is a one-to-one correspondence between two full measure subsets of $\partial\Omega \times [-\pi/2, \pi/2]$ and preserves the measure μ .

For further convenience, introduce the notation $T^n(x, \varphi) =: (x_n(x, \varphi), \varphi_n(x, \varphi))$, $n = 1, 2, \dots$. Let $I \subset \partial\Omega$ be a Borel subset of $\partial\Omega$ of positive one-dimensional Hausdorff measure, $|I| > 0$. For any $(x, \varphi) \in I \times [-\pi/2, \pi/2]$, denote by $n(x, \varphi) = n_{\Omega, I}(x, \varphi)$ the smallest positive integer n such that $x_n(x, \varphi) \in I$. Define the mapping $\mathcal{T}_{\Omega, I}$ by $\mathcal{T}_{\Omega, I}(x, \varphi) := (x_{n(x, \varphi)}(x, \varphi), -\varphi_{n(x, \varphi)}(x, \varphi))$. In other words, we launch a billiard particle from the point $x \in I$ at the angle φ and wait until it reflects off I again. Fix the point of the second reflection x^+ and the angle φ^+ of the particle's motion just before the reflection. By definition, $\mathcal{T}_{\Omega, I}(x, \varphi) = (x^+, \varphi^+)$.

The mapping $\mathcal{T}_{\Omega, I}$ preserves the measure μ and, by Poincaré recurrence theorem, represents a one-to-one correspondence between two full measure subsets of $I \times [-\pi/2, \pi/2]$.

Denote $\mathcal{T}_{\Omega, I}^+(x, \varphi) =: (x_{\Omega, I}^+(x, \varphi), \varphi_{\Omega, I}^+(x, \varphi))$ (in what follows we shall, as a rule, omit the subscripts of the functions x^+, φ^+). Define the Borel measure $\nu_{\Omega, I}$ on $Q = [-\pi/2, \pi/2] \times [-\pi/2, \pi/2]$ as follows. For any measurable set

$A \subset Q$, put

$$\nu_{\Omega, I}(A) = \frac{1}{|I|} \mu(\{(x, \varphi) : (\varphi, \varphi_{\Omega, I}^+(x, \varphi)) \in A\}).$$

Recalling the definition of sets Ω_i , I_i , $i \geq 1$, mappings \mathcal{T}_B^i and measures ν_B^i , one sees that $\mathcal{T}_B^i = \mathcal{T}_{\Omega_i, I_i}$ and $\nu_B^i = \nu_{\Omega_i, I_i}$.

It is easy to see that the measure $\nu_{\Omega, I}$ satisfies the conditions A1 and A2 and hence belongs to \mathcal{M} . We are interested in an inverse problem: show that any measure $\nu \in \mathcal{M}$ can be approximated by measures of the form $\nu_{\Omega, I}$.

Denote by \mathcal{S} the set of pairs (Ω, I) such that $\Omega \subset \mathbb{R}^2$ is a compact set with piecewise smooth boundary, $I \subset \partial\Omega$ is a line segment, and Ω lies on one side of the straight line containing I (see the picture below). The auxiliary result is as follows.

Theorem 2. *The set $\{\nu_{\Omega, I}, (\Omega, I) \in \mathcal{S}\}$ is everywhere dense in \mathcal{M} in the weak topology, that is, for any measure $\nu \in \mathcal{M}$ there exists a family of pairs $\{(\Omega(r), I(r)), r \geq 1\} \subset \mathcal{S}$ such that for every continuous function $f : Q \rightarrow \mathbb{R}$,*

$$\lim_{r \rightarrow +\infty} \int_Q f d\nu_{\Omega(r), I(r)} = \int_Q f d\nu.$$

Note that in [15] there was obtained a particular case of this theorem; namely, it was proved that ν^* can be approximated by measures $\nu_{\Omega, I}$, $(\Omega, I) \in \mathcal{S}$. Recall that $\nu^* \in \mathcal{M}$ and the support of ν^* belongs to the diagonal $\varphi = \varphi^+$. This result allows one to solve the mean resistance *maximization* problem for slowly rotating bodies. Moreover, in [15] there was obtained a three-dimensional analogue of this result, which allows one to solve the three-dimensional maximization problem.

3.2 Derivation of main theorem

Here theorem 1 is derived from theorem 2.

Denote by \mathcal{S}' the set of pairs $(\Omega, I) \in \mathcal{S}$ such that for some positive a and b ,

$$I = [-a, a] \times \{-b\} \quad \text{and} \quad \Omega \cap (\mathbb{R} \times (-\infty, 0)) = [-a, a] \times [-b, 0)$$

(see the figure below). The following lemma holds.

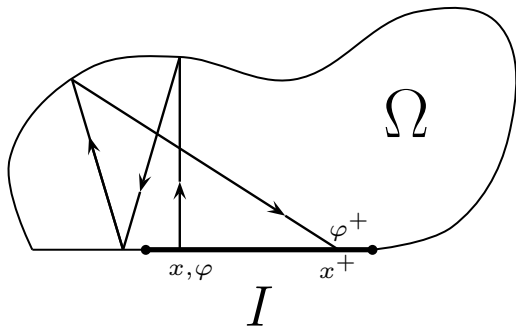

An example of a pair $(\Omega, I) \in \mathcal{S}$

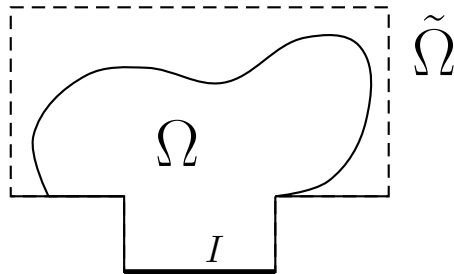

An example of a pair $(\Omega, I) \in \mathcal{S}'$

Lemma 1. *For any $(\Omega, I) \in \mathcal{S}$ there exists a sequence $\{(\Omega^{[n]}, I^{[n]})\}$, $n = 1, 2, \dots\} \subset \mathcal{S}'$ such that the sequence of measures $\nu_{\Omega^{[n]}, I^{[n]}}$ weakly converges to $\nu_{\Omega, I}$.*

The proof of this lemma is not difficult and is placed in Appendix.

It follows from theorem 2 and lemma 1 that the set of measures $\{\nu_{\Omega, I}, (\Omega, I) \in \mathcal{S}'\}$ is everywhere dense in \mathcal{M} in the weak topology.

Let K_1 and K_2 be compact convex sets, $K_1 \subset K_2$, $\text{dist}(\partial K_1, \partial K_2) > 0$, and let $(\Omega, I) \in \mathcal{S}'$ be an arbitrary pair. To prove theorem 1, it suffices to show that the measure $\nu_{\Omega, I}$ is a weak limit of measures of the form ν_B , $B \in \mathcal{B}_{K_1, K_2}$.

Denote $\tilde{\Omega}_{a,b,c} = ([-a, a] \times [-b, 0]) \cup ((-c, c) \times [0, c])$. Obviously, there exist positive values a, b, c such that $a \leq c$, $I = [-a, a] \times \{-b\}$, and $\Omega \subset \tilde{\Omega}_{a,b,c}$. We shall use the shorthand notation $\tilde{\Omega}_{a,b,c} = \tilde{\Omega}$. Later on, we shall also use the sets $\tilde{\Omega}^C = \tilde{\Omega}_{a,b,c}^C := (-c, c) \times [-b, c)$, $\tilde{\Omega}^l = \tilde{\Omega}_{a,b,c}^l := (-c, -a) \times [-b, 0)$, and $\tilde{\Omega}^r = \tilde{\Omega}_{a,b,c}^r := (a, c) \times [-b, 0)$ (see the figure below). One has $\tilde{\Omega}^C = \tilde{\Omega} \cup \tilde{\Omega}^l \cup \tilde{\Omega}^r$; the sets $\tilde{\Omega}$, $\tilde{\Omega}^l$, $\tilde{\Omega}^r$ are mutually disjoint. We shall also designate by V an isometry of general form. Thus, the composition of a homothety with ratio k and center at the origin and an isometry V , applied to a set $B \in \mathbb{R}^2$, has the form VkB . For brevity, sets of this form will be referred to as *copies* of B .

Consider a convex polygon K_0 such that $K_1 \subset K_0 \subset K_2$ and $\text{dist}(\partial K_0, \partial K_1) > 0$, and fix $\varepsilon > 0$. Our goal is to construct a set of mutually disjoint copies of Ω contained in $K_0 \setminus K_1$ in such a way that the corresponding copies of I are contained in the boundary ∂K_0 and fill it all, except possibly for a set of common length at most ε . Then the set B_ε , obtained from K_0 by set-theoretic subtracting that set of copies of Ω , will be defined. Making ε arbitrarily small, one will be able to make the measure ν_{B_ε} arbitrarily close (in variation) to $\nu_{\Omega, I}$.

On the figure, an intermediate result of this procedure is shown: the set-theoretic difference of K_0 and a union of copies of Ω associated with one side of K_0 .

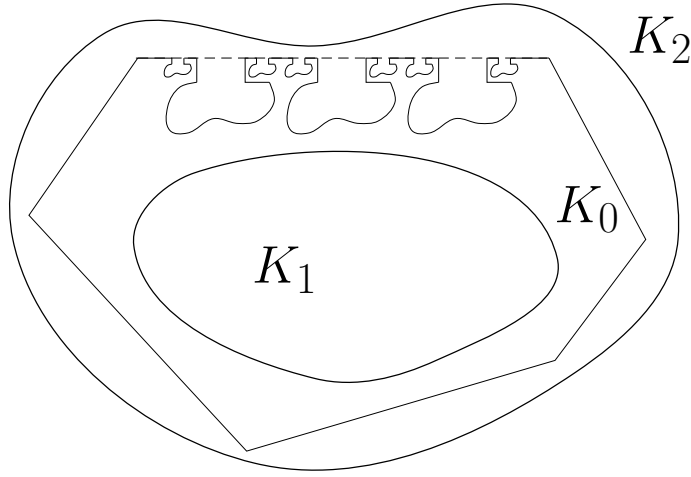

The construction itself is simple, but its description is rather cumbersome. Let the polygon K_0 have m sides; designate them by L_i , $i = 1, \dots, m$. On each segment L_i , put two points at the distance $\varepsilon/(4m)$ from its endpoints; the segment L_i^ε limited by these points has the length $|L_i| - \varepsilon/(2m)$. Denote by $\Pi_{i, \delta, \varepsilon}$ the closed rectangle that belongs to K_0 , has a side coincident with L_i^ε , and another side of length δ orthogonal to L_i^ε . Choose $\delta > 0$ in such a way that the rectangles $\Pi_{i, \delta, \varepsilon}$, $i = 1, \dots, m$ do not mutually intersect and do not intersect with K_1 .

Fix i and let $\Pi^1 := \Pi_{i, \delta, \varepsilon}$. Select a ratio $k^1 > 0$ and a finite number of isometries V_j^1 , $j = 1, \dots, q_1$ in such a way that the sets $V_j^1 k^1 \tilde{\Omega}^C$ do not mutu-

ally intersect, the union of their closures $\overline{\cup_j V_j^1 k^1 \tilde{\Omega}^C}$ is a rectangle containing L_i^ε and being contained in Π^1 , and all the segments $V_j^1 k^1 I$ belong to L_i^ε .

Denote $\Pi^2 := \cup_j V_j^1 k^1 (\tilde{\Omega}_l \cup \tilde{\Omega}_r)$. Select a ratio $k^2 > 0$ and a finite number of isometries V_j^2 , $j = 1, \dots, q_2$ in such a way that the sets $V_j^2 k^2 \tilde{\Omega}^C$ do not mutually intersect, the set $\overline{\cup_j V_j^2 k^2 \tilde{\Omega}^C}$ is a union of rectangles containing $L_i^\varepsilon \cap \Pi^2$ and being contained in Π^2 , and all the segments $V_j^2 k^2 I$ belong to L_i^ε .

Continuing this process, one obtains infinite sequences of sets Π^1, Π^2, \dots , isometries $\{V_j^1\}, \{V_j^2\}, \dots$, and numbers k_1, k_2, \dots . The lengths

$$r_n := \left| L_i^\varepsilon \setminus \left((\cup_j V_j^1 k^1 I) \cup \dots \cup (\cup_j V_j^n k^n I) \right) \right|, \quad n = 1, 2, \dots$$

form a decreasing geometric progression with ratio $1 - a/c$. Note that if $a = c$, one has $r_1 = 0$, so the process terminates on the first step.

Choose n in such a way that $r_n \leq \varepsilon/(2m)$ and consider all the sets $V_j^1 k^1 \Omega$, $j = 1, \dots, q_1$; $V_j^2 k^2 \Omega$, $j = 1, \dots, q_2$; \dots ; $V_j^n k^n \Omega$, $j = 1, \dots, q_n$, as well as the segments $V_j^1 k^1 I$, $j = 1, \dots, q_1$; $V_j^2 k^2 I$, $j = 1, \dots, q_2$; \dots ; $V_j^n k^n I$, $j = 1, \dots, q_n$. For further convenience, rename these sets and segments according to $\Omega_{l,j}^i$ and $I_{l,j}^i$, $i = 1, \dots, m$, $l = 1, \dots, n$, $j = 1, \dots, q_{li}$. The superscript i enumerates the sides of K_0 , the subscript l corresponds to the "rank" of the set on the i th side, and the subscript j enumerates identical sets of rank l on the i th side. The sets $\Omega_{l,j}^i$ do not mutually intersect and are copies of Ω , so the related measures are identical, $\nu_{\Omega_{l,j}^i, I_{l,j}^i} = \nu_{\Omega, I}$. Besides, each segment $I_{l,j}^i$ belongs to ∂K_0 . Denote by $|I_{l,j}^i|$ its length, denote $\kappa_{l,j}^i = |I_{l,j}^i|/|\partial K_0|$ and let $\kappa_0 = 1 - \sum_{i,j,l} \kappa_{l,j}^i$ be the part of the polygon's boundary free of these segments; one has $\kappa_0 \leq \varepsilon/|\partial K_0|$.

Consider the set

$$B_\varepsilon = \overline{K_0 \setminus (\cup_{i,j,l} \Omega_{l,j}^i)};$$

the bar means closure. One has $K_1 \subset B_\varepsilon \subset K_2$, hence $B_\varepsilon \in \mathcal{B}_{K_1, K_2}$. Further, one has $\text{conv} B_\varepsilon = K_0$; the set $\partial(\text{conv} B_\varepsilon) \setminus \partial B_\varepsilon$ is a union of a finite number of disjoint intervals $\cup_{i,j,l} I_{l,j}^i$. One has

$$\nu_{B_\varepsilon} = \kappa_0 \nu^0 + \sum_{i,j,l} \kappa_{l,j}^i \nu_{\Omega_{l,j}^i, I_{l,j}^i}.$$

Taking into account that $\sum_{i,j,l} \kappa_{l,j}^i = 1 - \kappa_0$ and $\nu_{\Omega_{l,j}^i, I_{l,j}^i} = \nu_{\Omega, I}$, one obtains that $\nu_{B_\varepsilon} = \kappa_0 \nu^0 + (1 - \kappa_0) \nu_{\Omega, I}$. As $\varepsilon \rightarrow 0$, one has $\kappa_0 \rightarrow 0$, therefore ν_{B_ε} converges in variation, and hence in the weak topology, to $\nu_{\Omega, I}$. This proves theorem 1.

4 Proof of the auxiliary result

4.1 A preparatory lemma

Let σ be a permutation of the set $\{1, \dots, m\}$, $m \geq 2$. Denote $\theta_i^m = \arcsin(-1 + 2i/m)$, $i = 0, 1, \dots, m$. The points $\theta_1^m, \dots, \theta_{m-1}^m$ divide the segment $[-\pi/2, \pi/2]$ into smaller segments $\Theta_i^m := [\theta_{i-1}^m, \theta_i^m]$ of equal measure λ : $\lambda(\Theta_i^m) = 2/m$, $i = 1, \dots, m$. Recall that λ is defined by $d\lambda(\varphi) = \cos \varphi d\varphi$. Define the mapping $\varphi_\sigma : [-\pi/2, \pi/2] \rightarrow [-\pi/2, \pi/2]$ as follows: φ_σ preserves the measure λ and rearranges the segments Θ_i^m , $i = 1, \dots, m$, according to the permutation σ ; the restriction of φ_σ to each segment Θ_i^m monotonically decreases and maps it bijectively (up to a set of zero measure) to $\Theta_{\sigma(i)}^m$, if $\sigma(i) \neq i$, and is identity mapping, if $\sigma(i) = i$. The mapping φ_σ is given, up to a set of zero measure, by the following formulas:

$$\text{if } \varphi \in \Theta_i^m, \quad \sigma(i) \neq i \quad \text{then } \varphi_\sigma(\varphi) = \arcsin \left(-2 + 2 \frac{i + \sigma(i) - 1}{m} - \sin \varphi \right);$$

$$\text{if } \varphi \in \Theta_i^m, \quad \sigma(i) = i \quad \text{then } \varphi_\sigma(\varphi) = \varphi.$$

The mapping φ_σ induces a Borel measure ν^σ on Q : for any measurable set $A \subset Q$ one has

$$\nu^\sigma(A) := \lambda(\{\varphi : (\varphi, \varphi_\sigma(\varphi)) \in A\}).$$

The measure ν^σ satisfies the condition A1; if, additionally, $\sigma^2 = \text{id}$ then it also satisfies A2. Thus, the set $\{\nu^\sigma : \sigma^2 = \text{id}\}$ belongs to \mathcal{M} . Later on, we will need the following lemma.

Lemma 2. *The set $\{\nu^\sigma : \sigma^2 = \text{id}, \sigma(1) \neq m\}$ is everywhere dense in \mathcal{M} in the weak topology.*

Its proof is not difficult and is put in appendix.

The condition $\sigma(1) \neq m$ is quite technical and will be used below when proving corollary 1.

4.2 Definition of a reflector

Denote $e_\varphi = (\sin \varphi, \cos \varphi)$. Let $\varphi_1, \varphi_2 \in (-\pi/2, \pi/2)$, $\varphi_1 \neq \varphi_2$; consider two rays te_{φ_1} , $t \geq 0$ and te_{φ_2} , $t \geq 0$. These rays make angles φ_1 and φ_2 with the

vector $e_0 = (0, 1)$, the angle being counted clockwise from e_0 . Let $x^{(1)}$ and $x^{(2)}$ be the points of intersection of these rays with the unit circumference $|x - e_0| = 1$. Let $O = (0, 0)$ denote the origin. Draw two parabolas, p_1 and p_2 , with common focus at O and with a common axis parallel to $x^{(2)} - x^{(1)}$; require, moreover, that the parabola p_1 contains $x^{(1)}$, the parabola p_2 contains $x^{(2)}$, and the intersection of convex sets bounded by these parabolas contains the segment $[x^{(1)}, x^{(2)}]$.

Let $\delta \geq 0$. Consider the straight lines l_0 , l_+ and l_- given by the formulas $(x, e_0) = 0$, $(x, e_{-\delta}) + \delta \sin \delta = 0$ and $(x, e_\delta) + \delta \sin \delta = 0$, respectively. Let us denote by $R(\varphi_1, \varphi_2, \delta)$ and call $(\varphi_1, \varphi_2, \delta)$ -*reflector* the convex set bounded by parabolas p_1 , p_2 and lines l_0 , l_+ , and l_- , that is

$$R(\varphi_1, \varphi_2, \delta) = \left\{ x : (x, e_0) \geq 0, (x, e_{-\delta}) + \delta \sin \delta \geq 0, (x, e_\delta) + \delta \sin \delta \geq 0, \right.$$

$$\left. |x| - |x^{(1)}| \leq \left(x - x^{(1)}, \frac{x^{(2)} - x^{(1)}}{|x^{(2)} - x^{(1)}|} \right), |x| - |x^{(2)}| \leq \left(x - x^{(2)}, \frac{x^{(1)} - x^{(2)}}{|x^{(1)} - x^{(2)}|} \right) \right\}. \quad (3)$$

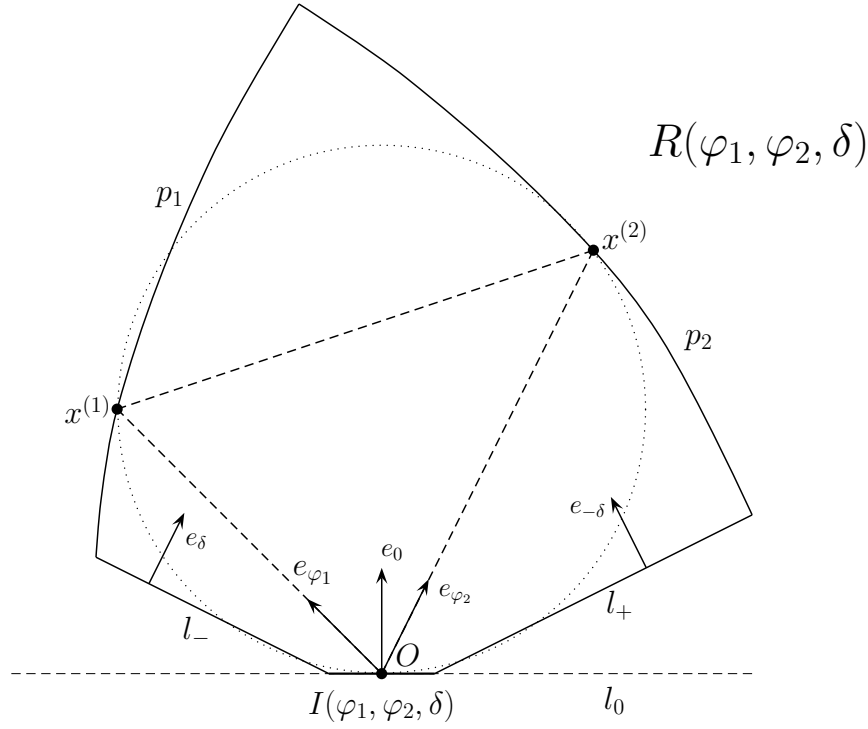

Let us call the set $I(\varphi_1, \varphi_2, \delta) := \partial R(\varphi_1, \varphi_2, \delta) \cap l_0$ *base* of the reflector, and the set $\kappa I(\varphi_1, \varphi_2, \delta)$, $0 < \kappa < 1$, κ -*base* of the reflector; for δ small enough, these sets coincide with $[-\delta, \delta] \times \{0\}$ and $[-\kappa\delta, \kappa\delta] \times \{0\}$, respectively. The point O is called *center* of the reflector. In the particular case $\delta = 0$, the reflector $R(\varphi_1, \varphi_2) := R(\varphi_1, \varphi_2, 0)$ is the set bounded by p_1 , p_2 , and l_0 . Denote also $I(\varphi_1, \varphi_2) := I(\varphi_1, \varphi_2, 0)$. Any copy of the reflector, that is, any set of the form $VkR(\varphi_1, \varphi_2, \delta)$, where V is a generic isometry and $k > 0$, will also be called $(\varphi_1, \varphi_2, \delta)$ -reflector, the sets $VkI(\varphi_1, \varphi_2, \delta)$ and $Vk\kappa I(\varphi_1, \varphi_2, \delta)$ will be called *base* and κ -*base* of this reflector, respectively, and the point VkO will be called *center* of the reflector.

Note that $R(\varphi_1, \varphi_2, \delta) = R(\varphi_2, \varphi_1, \delta)$ and $R(\varphi_1, \varphi_2) = R(\varphi_2, \varphi_1)$.

Later on, we will need one more definition. Adding the left and right hand sides of the inequalities in (3), one gets $2|x| \leq |x^{(1)}| + |x^{(2)}| + |x^{(2)} - x^{(1)}|$. The right hand side of this inequality is perimeter of the triangle with vertices O , $x^{(1)}$, and $x^{(2)}$, inscribed in the unit circumference. It does not exceed the perimeter of an equilateral triangle inscribed in the same circumference. This implies that $2|x| \leq 3\sqrt{3}$. Define the set $T(\delta) = \{x : 0 \leq (x, e_0) < 3\sqrt{3}/2, (x, e_{-\delta}) + \delta \sin \delta \geq 0, (x, e_\delta) + \delta \sin \delta \geq 0\}$, the trapezium bounded from below by l_0 , l_+ , and l_- , and from above, by a straight line parallel to l_0 . It follows from the construction that $R(\varphi_1, \varphi_2, \delta) \subset T(\delta)$ for any φ_1 and φ_2 .

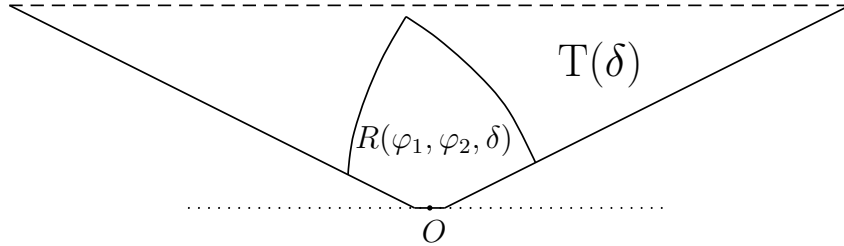

Consider the billiard in $R(\varphi_1, \varphi_2)$. Suppose that a billiard particle is initially located at a regular point of the boundary, $x = (\xi, 0) \in I(\varphi_1, \varphi_2)$, and has velocity e_φ , $-\pi/2 < \varphi < \pi/2$, and during the subsequent motion reflects first from p_1 , then from p_2 , and for the third time, from an interior point of $I(\varphi_1, \varphi_2)$. Denote by $x^+ = (\xi^+, 0)$ the point of third reflection and denote by $-e_{\varphi^+}$, $-\pi/2 < \varphi^+ < \pi/2$ the particle's velocity just before the

third reflection. The set of values $(\xi, \varphi, \varphi_1, \varphi_2)$ such that the mentioned order of reflections takes place is denoted by \mathcal{A} . The set $\mathcal{A} \subset \mathbb{R}^4$ is open and contains the points of kind $(0, \varphi_1, \varphi_1, \varphi_2)$, $\varphi_1 \neq \varphi_2$; hence it is nonempty. Denote by $\tilde{\xi}^+$, $\tilde{\varphi}^+$ the mappings that send $(\xi, \varphi, \varphi_1, \varphi_2) \in \mathcal{A}$ to ξ^+ , φ^+ , respectively, and define the mapping $\tilde{T} : \mathcal{A} \rightarrow \mathbb{R}^2$ by $\tilde{T}(\xi, \varphi, \varphi_1, \varphi_2) = (\tilde{\xi}^+(\xi, \varphi, \varphi_1, \varphi_2), \tilde{\varphi}^+(\xi, \varphi, \varphi_1, \varphi_2))$. Recalling the definition of functions $x_{\Omega, I}^+$, $\varphi_{\Omega, I}^+$ given in section 3.1, one concludes that $(\tilde{\xi}^+(\xi, \varphi, \varphi_1, \varphi_2), 0) = x_{R(\varphi_1, \varphi_2), I(\varphi_1, \varphi_2)}^+(x, \varphi)$, $\tilde{\varphi}^+(\xi, \varphi, \varphi_1, \varphi_2) = \varphi_{R(\varphi_1, \varphi_2), I(\varphi_1, \varphi_2)}^+(x, \varphi)$, where $x = (\xi, 0)$.

The mapping \tilde{T} is infinitely differentiable; besides, one has

$$\tilde{\xi}^+(0, \varphi, \varphi_1, \varphi_2) = 0, \quad \tilde{\varphi}^+(0, \varphi_1, \varphi_1, \varphi_2) = \varphi_2.$$

Indeed, a particle gets out of the common focus O of the parabolas p_1 and p_2 , then reflects from p_1 and moves in parallel to the common axis of p_1 and p_2 ; finally, it reflects from p_2 and gets into the common focus O . If, besides, the initial velocity equals e_{φ_1} then after reflections at the points $x^{(1)}$ and $x^{(2)}$ it returns to O with velocity $-e_{\varphi_2}$.

Lemma 3. *For any $\varphi_1, \varphi_2 \in (-\pi/2, \pi/2)$, $\varphi_1 \neq \varphi_2$ holds*

$$(a) \quad \left. \frac{\partial \tilde{\varphi}^+}{\partial \varphi} \right|_{\substack{\xi=0 \\ \varphi=\varphi_1}} (\xi, \varphi, \varphi_1, \varphi_2) = -\frac{\cos \varphi_1}{\cos \varphi_2};$$

$$(b) \quad \left| \left. \frac{\partial \tilde{\xi}^+}{\partial \xi} \right|_{\substack{\xi=0 \\ \varphi=\varphi_1}} (\xi, \varphi, \varphi_1, \varphi_2) \right| = 1.$$

Proof. Fix the values $-\pi/2 < \varphi_1 < \varphi_2 < \pi/2$; the case $\varphi_1 > \varphi_2$ is completely analogous. Put $A = x^{(1)}$, $B = x^{(2)}$. Note that on the figure below there are drawn the angles $\varphi_1 < 0$, $\varphi_2 > 0$.

A particle that gets out of O with velocity $e_{\varphi_1 + \Delta\varphi}$, with $\Delta\varphi$ sufficiently small, first reflects from p_1 at a point $\tilde{x}^{(1)} = A'$, then reflects from p_2 at a point $\tilde{x}^{(2)} = B'$, and finally returns to O , the velocity just before returning being $e_{\varphi_2 + \Delta\varphi^+}$. Thus, one has $\varphi_2 + \Delta\varphi^+ = \tilde{\varphi}^+(0, \varphi_1 + \Delta\varphi, \varphi_1, \varphi_2)$. Put $\Delta\varphi < 0$, then $\Delta\varphi^+ > 0$. On the figure, there is shown the circumference $|x - e_0| = 1$. Note that the points A and B belong to the circumference, but A' and B' , generally, do not.

For our convenience, introduce two additional points L_1, L_2 lying on the line l_0 , one to the left and another to the right of O . One can put, for example, $L_1 = (-\xi_0, 0)$, $L_2 = (\xi_0, 0)$, where $\xi_0 > 0$. One has

$$\angle AOB = \varphi_2 - \varphi_1;$$

$\angle BOL_2 = \pi/2 - \varphi_2$; moreover, the angles $\angle OAB$ and $\angle BOL_2$ are inscribed in the same arc and hence are equal, therefore

$$\angle OAB = \pi/2 - \varphi_2.$$

Further, $\angle AOL_1 = \varphi_1 + \pi/2$; the angles $\angle ABO$ and $\angle AOL_1$ are inscribed in the same arc and hence are equal; therefore,

$$\angle ABO = \varphi_1 + \pi/2.$$

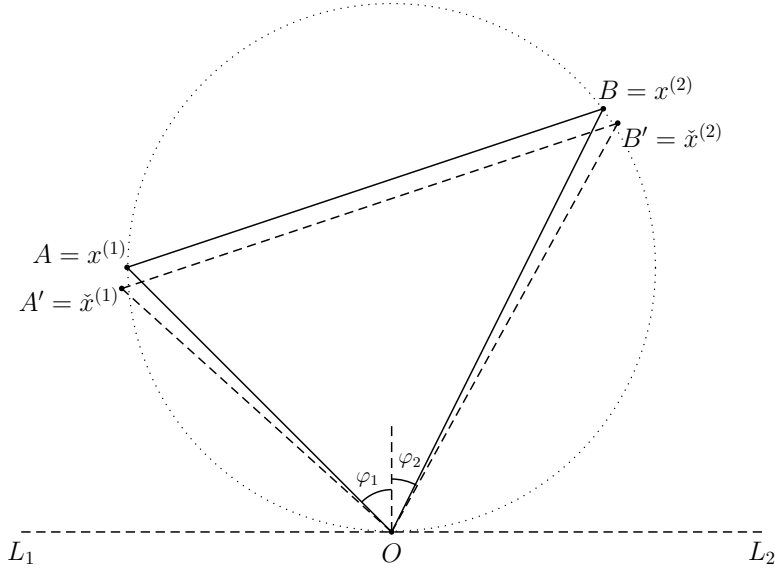

The law of sines implies that

$$\frac{|OA|}{|OB|} = \frac{\sin \angle ABO}{\sin \angle OAB} = \frac{\cos \varphi_1}{\cos \varphi_2}. \quad (4)$$

By the elastic reflection law, the inner normal to $\partial R(\varphi_1, \varphi_2)$ at A makes the angle $\frac{1}{2}\angle OAB = \pi/4 - \varphi_2/2$ with the straight line OA ; hence the tangent to $\partial R(\varphi_1, \varphi_2)$ at A makes the angle $\pi/4 + \varphi_2/2$ with OA . This implies that

$$\angle OAA' = \frac{\pi}{4} + \frac{\varphi_2}{2} + O(\Delta\varphi);$$

besides

$$\angle OA'A = \pi - \angle OAA' - \angle AOA' = \frac{3\pi}{4} - \frac{\varphi_2}{2} + O(\Delta\varphi).$$

(Note that $\angle AOA' = -\Delta\varphi$). Applying the law of sines to the triangle OAA' , one gets

$$\frac{\sin \angle OA'A}{|OA|} = \frac{\sin \angle AOA'}{|AA'|},$$

hence

$$\frac{\sin (3\pi/4 - \varphi_2/2 + O(\Delta\varphi))}{|OA|} = \frac{-\Delta\varphi (1 + O(\Delta\varphi))}{|AA'|}, \quad \Delta\varphi \rightarrow 0. \quad (5)$$

Further, two different particles starting at the focus O , after reflecting off the parabola p_1 move in parallel, that is, the straight lines AB and $A'B'$ are parallel. Denote the distance between them by Δx . One has

$$\begin{aligned} \Delta x &= |AA'| \cdot \sin \angle A'AB = |AA'| \cdot \sin (\angle OAA' + \angle OAB) = \\ &= |AA'| \cdot \sin (3\pi/4 - \varphi_2/2 + O(\Delta\varphi)), \quad \Delta\varphi \rightarrow 0. \end{aligned}$$

Taking account of (5), one obtains

$$\Delta x = -|OA| \cdot \Delta\varphi \cdot (1 + O(\Delta\varphi)), \quad \Delta\varphi \rightarrow 0. \quad (6)$$

Next, considering the triangle OBB' in an analogous way and taking into account that $\Delta\varphi^+ > 0$, one obtains

$$\Delta x = |OB| \cdot \Delta\varphi^+ \cdot (1 + O(\Delta\varphi)), \quad \Delta\varphi \rightarrow 0. \quad (7)$$

From (6) and (7) one gets

$$\frac{\Delta\varphi^+}{\Delta\varphi} = -\frac{|OA|}{|OB|} \cdot (1 + O(\Delta\varphi)), \quad \Delta\varphi \rightarrow 0;$$

taking the limit in this equality as $\Delta\varphi \rightarrow 0$ and using (4), one obtains

$$\frac{\partial \tilde{\varphi}^+}{\partial \varphi}(\xi = 0, \varphi = \varphi_1, \varphi_1, \varphi_2) = -\frac{\cos \varphi_1}{\cos \varphi_2}. \quad (8)$$

The statement (a) of lemma is proved.

Further, one has $\tilde{\xi}^+(0, \varphi, \varphi_1, \varphi_2) = 0$; hence for any φ one has

$$\frac{\partial \tilde{\xi}^+}{\partial \varphi}(0, \varphi, \varphi_1, \varphi_2) = 0. \quad (9)$$

The restriction of \tilde{T} to the subspace $\{\varphi_1 = \text{const}, \varphi_2 = \text{const}\}$ preserves the measure $d\mu(\xi, \varphi) = \cos \varphi d\xi d\varphi$, that is, $\cos \tilde{\varphi}^+ d\tilde{\xi}^+ d\tilde{\varphi}^+ = \cos \varphi d\xi d\varphi$, and using that $d\tilde{\xi}^+ d\tilde{\varphi}^+ = \left| \frac{D(\tilde{\xi}^+, \tilde{\varphi}^+)}{D(\xi, \varphi)} \right| d\xi d\varphi$, one obtains

$$\cos \tilde{\varphi}^+(\xi, \varphi, \varphi_1, \varphi_2) \cdot \left| \frac{D(\tilde{\xi}^+, \tilde{\varphi}^+)}{D(\xi, \varphi)} \right| = \cos \varphi. \quad (10)$$

Taking into account that

$$\frac{D(\tilde{\xi}^+, \tilde{\varphi}^+)}{D(\xi, \varphi)} = \frac{\partial \tilde{\xi}^+}{\partial \xi} \frac{\partial \tilde{\varphi}^+}{\partial \varphi} - \frac{\partial \tilde{\xi}^+}{\partial \varphi} \frac{\partial \tilde{\varphi}^+}{\partial \xi}$$

and using (8) and (9), one gets

$$\left| \frac{D(\tilde{\xi}^+, \tilde{\varphi}^+)}{D(\xi, \varphi)} \right|_{(\xi=0, \varphi=\varphi_1, \varphi_1, \varphi_2)} = \left| \frac{\partial \tilde{\xi}^+}{\partial \xi}(0, \varphi_1, \varphi_1, \varphi_2) \right| \cdot \frac{\cos \varphi_1}{\cos \varphi_2}.$$

Substituting this value into (10) and using that $\tilde{\varphi}^+(0, \varphi_1, \varphi_1, \varphi_2) = \varphi_2$, one obtains

$$\left| \frac{\partial \tilde{\xi}^+}{\partial \xi}(0, \varphi_1, \varphi_1, \varphi_2) \right| = 1; \quad (11)$$

thus, the statement (b) of lemma is also proved. Using an additional geometric argument, the formula (11) could be made more precise: $\frac{\partial \tilde{\xi}^+}{\partial \xi}(\xi = 0, \varphi = \varphi_1, \varphi_1, \varphi_2) = 1$, but we will not need this specification in the future. \square

Let f be a function of $x, \varphi, \varphi_1, \varphi_2, \delta$. In the following lemma, by $O(f)$ we mean a generic function of the same variables such that $O(f)/f$ is bounded over all admissible values of the variables.

Let $-\pi/2 < \Phi_1 < \Phi_2 < \pi/2$, $0 < \Phi_0 < \Phi_2 - \Phi_1$.

Lemma 4. *There exist positive constants $c = c(\Phi_0, \Phi_1, \Phi_2)$ and $c_0 = c_0(\Phi_0, \Phi_1, \Phi_2)$ such that*

(a) *if $\varphi_1, \varphi_2 \in [\Phi_1, \Phi_2]$, $|\varphi_2 - \varphi_1| \geq \Phi_0$, $|x| \leq \delta(1 - c\delta - c|\varphi - \varphi_1|)$ then*

$$\varphi_{R(\varphi_1, \varphi_2, \delta), I(\varphi_1, \varphi_2, \delta)}^+(x, \varphi) - \varphi_2 = -\frac{\cos \varphi_1}{\cos \varphi_2} (\varphi - \varphi_1) + O(\delta) + O((\varphi - \varphi_1)^2); \quad (12)$$

(b) *if, moreover, $\delta < c_0$, $|\varphi - \varphi_1| < c_0$ then*

$$n_{R(\varphi_1, \varphi_2, \delta), I(\varphi_1, \varphi_2, \delta)}(x, \varphi) = 3. \quad (13)$$

Thus, the lemma states that a billiard particle that starts moving at a point of a reflector's base, under the given restrictions on the initial position x , on the initial direction of motion φ , and on the reflector's parameters, after two reflections from p_1 and p_2 will return to the reflector's base and the direction of motion of the returning particle φ^+ will satisfy the relation (12).

Proof. The set $\{(0, \varphi_1, \varphi_1, \varphi_2) : \varphi_1, \varphi_2 \in [\Phi_1, \Phi_2], |\varphi_2 - \varphi_1| \geq \Phi_0\}$ is compact and belongs to the open set \mathcal{A} ; hence there exist positive values $\Delta\xi$ and $\Delta\varphi$ such that the compact set $\mathcal{A}(\Delta\xi, \Delta\varphi, \Phi_0, \Phi_1, \Phi_2) := \{(\xi, \varphi, \varphi_1, \varphi_2) : |\xi| \leq \Delta\xi, |\varphi - \varphi_1| \leq \Delta\varphi; \varphi_1, \varphi_2 \in [\Phi_1, \Phi_2], |\varphi_2 - \varphi_1| \geq \Phi_0\}$ also belongs to \mathcal{A} .

For $(\xi, \varphi, \varphi_1, \varphi_2) \in \mathcal{A}(\Delta\xi, \Delta\varphi, \Phi_0, \Phi_1, \Phi_2)$ holds

$$\begin{aligned} & \tilde{\varphi}^+(\xi, \varphi, \varphi_1, \varphi_2) - \tilde{\varphi}^+(0, \varphi_1, \varphi_1, \varphi_2) = \\ & = [\tilde{\varphi}^+(\xi, \varphi, \varphi_1, \varphi_2) - \tilde{\varphi}^+(0, \varphi, \varphi_1, \varphi_2)] + [\tilde{\varphi}^+(0, \varphi, \varphi_1, \varphi_2) - \tilde{\varphi}^+(0, \varphi_1, \varphi_1, \varphi_2)] = \\ & = \frac{\partial \tilde{\varphi}^+}{\partial \xi} \cdot \xi + \frac{\partial \tilde{\varphi}^+}{\partial \varphi}(0, \varphi_1, \varphi_1, \varphi_2) \cdot (\varphi - \varphi_1) + \frac{\partial^2 \tilde{\varphi}^+}{\partial \varphi^2} \cdot \frac{(\varphi - \varphi_1)^2}{2}. \end{aligned}$$

According to statement (a) of lemma 3, one has $\frac{\partial \tilde{\varphi}^+}{\partial \varphi}(0, \varphi_1, \varphi_1, \varphi_2) = -\frac{\cos \varphi_1}{\cos \varphi_2}$. Moreover, using that $\tilde{\varphi}^+(0, \varphi_1, \varphi_1, \varphi_2) = \varphi_2$ and that the functions $\frac{\partial \tilde{\varphi}^+}{\partial \xi}$, $\frac{\partial^2 \tilde{\varphi}^+}{\partial \varphi^2}$ are bounded on the set $\mathcal{A}(\Delta\xi, \Delta\varphi, \Phi_0, \Phi_1, \Phi_2)$, and introducing the shorthand notation $\tilde{\varphi}^+(\xi, \varphi, \varphi_1, \varphi_2) = \tilde{\varphi}^+$, one obtains

$$\tilde{\varphi}^+ - \varphi_2 = -\frac{\cos \varphi_1}{\cos \varphi_2} (\varphi - \varphi_1) + O(\xi) + O((\varphi - \varphi_1)^2). \quad (14)$$

Further, one has

$$\tilde{\xi}^+(\xi, \varphi, \varphi_1, \varphi_2) - \tilde{\xi}^+(0, \varphi, \varphi_1, \varphi_2) = \frac{\partial \tilde{\xi}^+}{\partial \xi}(0, \varphi, \varphi_1, \varphi_2) \cdot \xi + \frac{\partial^2 \tilde{\xi}^+}{\partial \xi^2} \cdot \frac{\xi^2}{2},$$

$$\frac{\partial \tilde{\xi}^+}{\partial \xi}(0, \varphi, \varphi_1, \varphi_2) = \frac{\partial \tilde{\xi}^+}{\partial \xi}(0, \varphi_1, \varphi_1, \varphi_2) + \frac{\partial^2 \tilde{\xi}^+}{\partial \xi \partial \varphi} \cdot (\varphi - \varphi_1).$$

According to statement (b) of lemma 3, $|\frac{\partial \tilde{\xi}^+}{\partial \xi}(0, \varphi_1, \varphi_1, \varphi_2)| = 1$. Taking into account that $\tilde{\xi}^+(0, \varphi, \varphi_1, \varphi_2) = 0$ and the values $\frac{\partial^2 \tilde{\xi}^+}{\partial \xi^2}, \frac{\partial^2 \tilde{\xi}^+}{\partial \xi \partial \varphi}$ are bounded on $\mathcal{A}(\Delta \xi, \Delta \varphi, \Phi_0, \Phi_1, \Phi_2)$, and using the shorthand notation $\tilde{\xi}^+(\xi, \varphi, \varphi_1, \varphi_2) = \tilde{\xi}^+$, one gets

$$\tilde{\xi}^+ = \xi (\pm 1 + O(\xi) + O(\varphi - \varphi_1)). \quad (15)$$

It follows from (14) that for some constant $c_0 > 0$ the following holds: if $|\xi|, |\varphi - \varphi_1| < c_0$ then $|\varphi|, |\tilde{\varphi}^+| < \pi/2 - c_0$. From (15) it follows that for some constant $c > 0$ the following holds: if $|\xi| \leq \delta(1 - c\delta - c|\varphi - \varphi_1|)$ then $|\tilde{\xi}^+| < \delta$. These facts imply that for $\delta < c_0$ the following holds true: if $|\xi| \leq \delta(1 - c\delta - c|\varphi - \varphi_1|)$ and $|\varphi - \varphi_1| < c_0$ then $|\tilde{\xi}^+| < \delta$ and $|\varphi|, |\tilde{\varphi}^+| < \pi/2 - c_0$.

The last conclusion means that under the chosen restrictions on the initial data ξ, φ , a billiard particle in $R(\varphi_1, \varphi_2)$ starts moving at some point on the base $I(\varphi_1, \varphi_2)$ and after two reflections off p_1 and p_2 returns to the base, besides the distances from the initial and final points to the origin O are less than δ and the directions of initial and final motion make with the base angles more than δ . This implies that this motion is at the same time a billiard motion in $R(\varphi_1, \varphi_2, \delta)$, that is, $(\tilde{\xi}^+, 0) = x_{R(\varphi_1, \varphi_2, \delta), I(\varphi_1, \varphi_2, \delta)}^+(x, \varphi)$, $\tilde{\varphi}^+ = \varphi_{R(\varphi_1, \varphi_2, \delta), I(\varphi_1, \varphi_2, \delta)}^+(x, \varphi)$, and $n_{R(\varphi_1, \varphi_2, \delta), I(\varphi_1, \varphi_2, \delta)}(x, \varphi) = 3$ (recall that $x = (\xi, 0)$). Thus, (13) is proved.

Taking into account the above-mentioned and using (14), one concludes that (12) is true locally, for $\delta < c_0, |\varphi - \varphi_1| < c_0$; hence it is also true globally, for all admissible values of $x, \varphi, \varphi_1, \varphi_2, \delta$. \square

4.3 Definition of a pair (Ω, I)

Consider a permutation σ of $\{1, \dots, m\}$ such that $\sigma^2 = \text{id}$ and $\sigma(1) \neq m$. Fix $r > 1$ and $\delta > 0$, and put $I = [-1/2, 1/2] \times \{0\}$. In this section we shall define a set $\Omega = \Omega(\sigma, r, \delta)$ such that $\partial\Omega$ contains I , and in the next section we shall prove that $\nu_{\Omega(\sigma, r, \delta), I}$ weakly converges to ν^σ as $r \rightarrow \infty, r\delta \rightarrow 0$.

Recall that by definition, $\theta_i = \theta_i^m = \arcsin(-1 + 2i/m)$, $\Theta_i = \Theta_i^m = [\theta_{i-1}, \theta_i]$, $i = 0, 1, \dots, m$, and $e_\varphi = (\sin \varphi, \cos \varphi)$. Denote $P_i = r e_{\theta_i}$; the points P_i lie on the upper half-circumference of radius r with the center

$O = (0, 0)$. Denote by \mathcal{Q} the polygon $P_0P_1 \dots P_mP_0$. Denote by n_i the unit outer normal to $\partial\mathcal{Q}$ at some point of $[P_{i-1}, P_i]$; one has $n_i = e_{(\theta_{i-1}+\theta_i)/2}$.

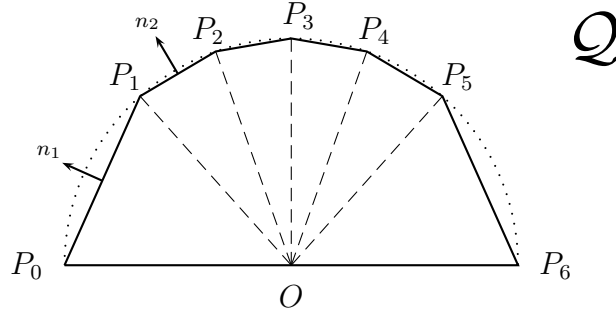

Fix the values $i, j \in \{1, \dots, m\}$, $i \neq j$, and a point $x \in [P_{i-1}, P_i]$. Denote by θ the angle the vector x makes with e_0 ; thus, $x = |x|e_\theta$, $\theta \in \Theta_i$. Denote by φ_{ij} the bijective mapping from Θ_i to Θ_j that monotonically decreases and preserves the measure λ . Put $\theta' = \varphi_{ij}(\theta)$; one easily sees that $\sin \theta_j - \sin \theta' = \sin \theta - \sin \theta_{i-1}$. Take the vector $x' = x'(x) \in [P_{j-1}, P_j]$ that forms the angle θ' with e_0 ; thus, $x' = |x'|e_{\theta'}$. Denote by $\varphi_1 = \varphi_1(x)$ and $\varphi_2 = \varphi_2(x)$ the angles the vectors x and $x - x'$, respectively, form with n_i ; these angles are counted from n_i clockwise; in particular, one has $\varphi_1 = \theta - (\theta_{i-1} + \theta_i)/2$. Finally, define the reflector $R_{ij}^k[x] = R_{ij}^k[x, r, \delta]$ by

$$R_{ij}^k[x] = V_x k R(\varphi_1, \varphi_2, \delta),$$

where $0 < k < 1$ and V_x is the isometry taking the point O to the point x , and the vector e_0 , to the vector n_i . Note that for fixed m and under the condition that x belongs to the broken line $P_0P_1 \dots P_m$, the value x uniquely defines r , and hence the isometry V_x .

Let us give an example explaining the meaning of the above definition. Consider the billiard in the set $\mathcal{Q} \cup R_{ij}^{k_1}[x] \cup R_{ji}^{k_2}[x']$: the union of the polygon and two reflectors; the ratios k_1 and k_2 being taken small enough, so that the reflectors do not intersect. If a particle starts at O with the initial velocity e_θ , then in the subsequent motion it passes through x , makes two reflections off the boundary of the first reflector, then moves along the straight line joining the points x and x' , makes two more reflections off the boundary of the second reflector, and finally returns to O , the velocity just before the

return being $-e_{\theta'}$ (see the figure below).

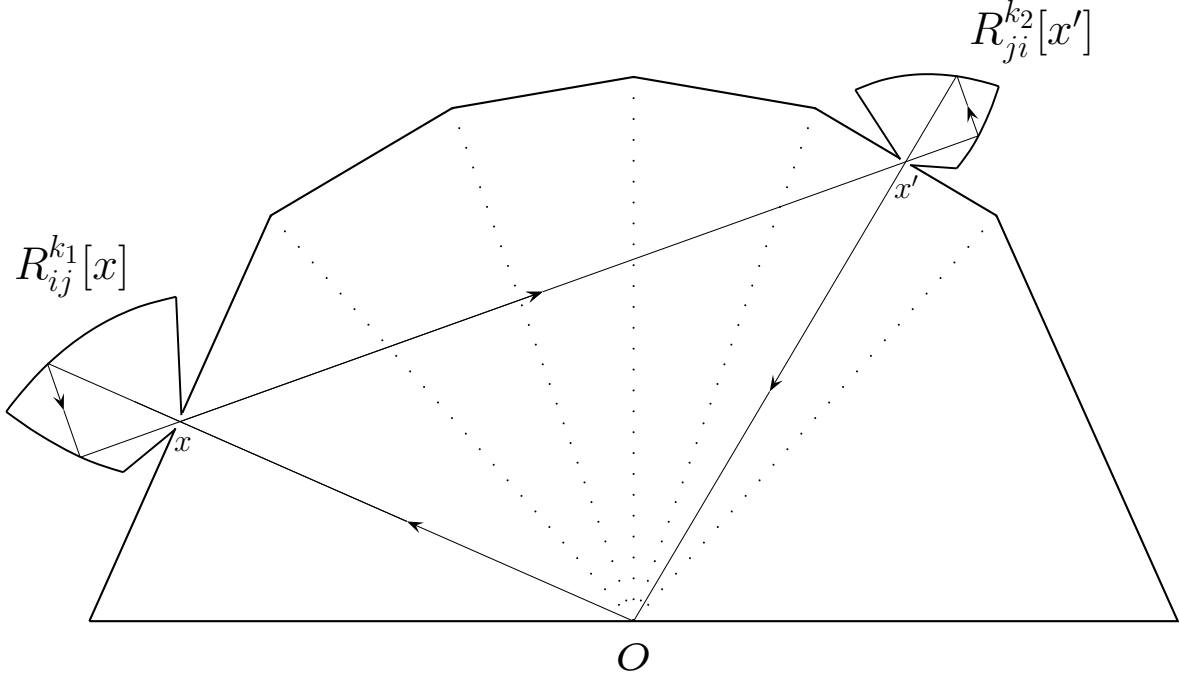

Note that there exist values $\check{\Phi}_1 = \Phi_1(i, j)$ and $\check{\Phi}_2 = \Phi_2(i, j)$ such that $-\pi/2 < \check{\Phi}_1 < \check{\Phi}_2 < \pi/2$ and for any $x \in [P_{i-1}, P_i]$, $\varphi_1(x)$ and $\varphi_2(x)$ belong to $[\check{\Phi}_1, \check{\Phi}_2]$. If, in addition, (i, j) does not coincide with one of the pairs $(1, m)$, $(m, 1)$ then there exists a value $\check{\Phi}_0 = \Phi_0(i, j)$ such that $0 < \check{\Phi}_0 < \check{\Phi}_2 - \check{\Phi}_1$ and for any $x \in [P_{i-1}, P_i]$, $|\varphi_2(x) - \varphi_1(x)| \geq \check{\Phi}_0$. Note in passing that the measure preserving function φ_{ij} was chosen to be monotone decreasing just to make it possible to choose $\check{\Phi}_1$ and $\check{\Phi}_2$; if it were defined as monotone increasing then for $|i - j| = 1$ it would not be possible to separate the functions $\varphi_1(x)$ and $\varphi_2(x)$ from $-\pi/2$ and $\pi/2$. Note also that the condition $\sigma(1) \neq m$, stated in lemma 2, guarantees that the pair $(i, \sigma(i))$ does not coincide with one of the pairs $(1, m)$, $(m, 1)$.

Denote by $\Omega_{(i)} = \Omega_{(i)}(r) = \{\rho e_{\theta} : \rho \in [0, r], \theta \in \Theta_i\}$ the circular sector bounded by the radii OP_{i-1} and OP_i . For any pair of values $i \neq j$, the set $\Omega_{(i,j)} = \Omega_{(i,j)}(r, \delta)$ is defined as union of the triangle $OP_{i-1}P_i$ and a finite

set of reflectors of the form $R_{ij}^{k_l}[x_q^l]$, where $x_q^l \in [P_{i-1}, P_i]$ and $0 < k_l < 1$. The detailed definition is given in the two next paragraphs. The reflectors do not mutually intersect and are contained in the angle $\angle P_{i-1}OP_i := \{\rho e_\theta : \rho \geq 0, \theta \in \Theta_i\}$; besides, the set $\partial\Omega_{(i,j)} \cap [P_{i-1}, P_i]$ is a union of segments of common length at most 1. The last property can be formulated in a slightly different manner: the collection of points of $[P_{i-1}, P_i]$ that do not belong to bases of the mentioned reflectors has common length at most 1. The set $\Omega = \Omega(\sigma, r, \delta)$ is defined as the union

$$\Omega = \left(\cup_{\sigma(i)=i} \Omega_{(i)} \right) \cup \left(\cup_{\sigma(i) \neq i} \Omega_{(i, \sigma(i))} \right). \quad (16)$$

Obviously, $\partial\Omega$ contains I , and Ω lies on one side of the straight line l_0 containing I ; hence $(\Omega, I) \in \mathcal{S}$.

Let us give a detailed description of $\Omega_{(i,j)}$. The trapezium $T(\delta)$, defined in section 4.2, will be briefly referred to as T . Denote by Λ_1^0 the isosceles triangle with the base $[P_{i-1}, P_i]$ and the angle δ at the base. Denote by x_1^0 the midpoint of the segment $[P_{i-1}, P_i]$ and consider the trapezium $T_1^0 := V_{x_1^0} k_0 T$, where k_0 is the greatest value, not exceeding 1, such that T_1^0 is contained in Λ_1^0 . The set $\Lambda_1^0 \setminus T_1^0$ is a union of three triangles; two of them have bases belonging to $[P_{i-1}, P_i]$; denote these triangles by Λ_1^1 and Λ_2^1 . Designate by x_1^1 and x_2^1 the midpoints of their bases and consider trapezia $T_1^1 = V_{x_1^1} k_1 T$ and $T_2^1 = V_{x_2^1} k_1 T$, where k_1 is the greatest value, not exceeding 1, such that $T_1^1 \subset \Lambda_1^1$ and $T_2^1 \subset \Lambda_2^1$.

Continuing this process, one obtains the sequence of numbers k_l , triangles $\Lambda_1^l, \dots, \Lambda_{2^l}^l$, points $x_1^l, \dots, x_{2^l}^l$, and trapezia $T_1^l, \dots, T_{2^l}^l$, $l = 0, 1, 2, \dots$ (see the figure below). These trapezia do not mutually intersect; the numbers k_l form a decreasing geometric progression. The set $J_l = [P_{i-1}, P_i] \setminus \cup_{q=1}^{2^l} T_q^{l-1}$ is a union of 2^l intervals, besides the one-dimensional Lebesgue measures $|J_l|$ of J_l , $l = 1, 2, \dots$ form a decreasing geometric progression. Choose l_0 such that $|J_{l_0}| < 1$. Denote by $\Lambda_{(i)}$ the triangle $OP_{i-1}P_i$ and let

$$\Omega_{(i,j)} = \Lambda_{(i)} \cup \left(\cup_{l=0}^{l_0} \cup_{q=1}^{2^l} R_{ij}^{k_l}[x_q^l] \right).$$

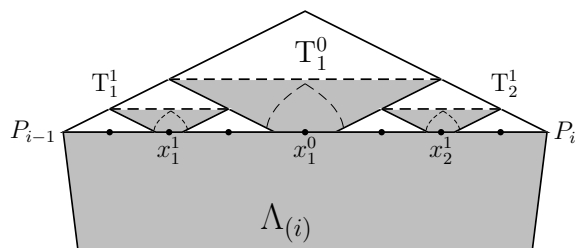

At last, Ω is defined by the formula (16). Each reflector constituting the subset $\Omega_{(i, \sigma(i))}$ will be called *i-reflector* of the set Ω .

On the figure below, the pair of sets $(\Omega = \Omega(\sigma, r, \delta), I)$ is shown, where $\sigma = \begin{pmatrix} 1 & 2 & 3 & 4 & 5 \\ 1 & 4 & 3 & 2 & 5 \end{pmatrix}$, $r = 2.5$, $\delta = 0.4$.

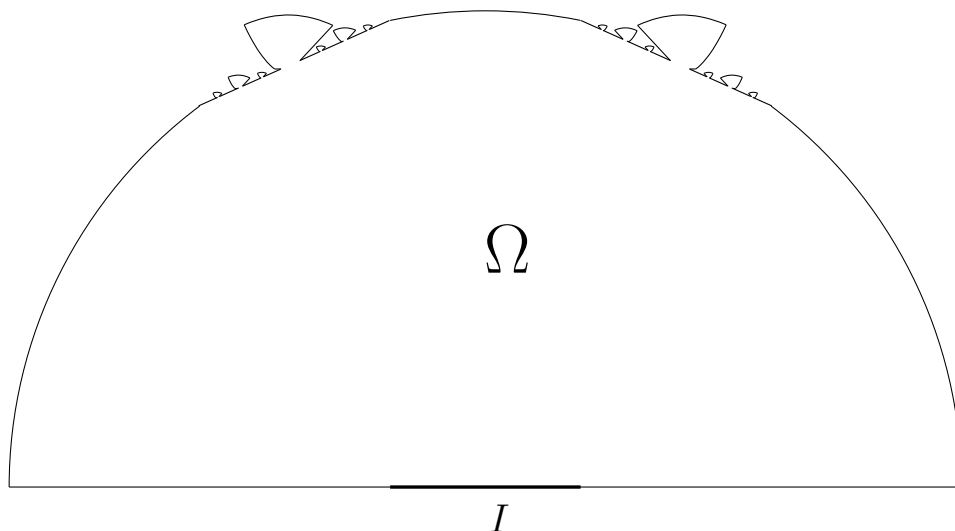

In the particular case where $\sigma = \text{id}$, that is, $\sigma(i) = i$ for any i , the set $\Omega = \Omega(\text{id}, r, \delta)$ takes an especially simple form: it is just the upper half-circle of radius r .

Note that there exist values Φ_0, Φ_1, Φ_2 , not depending on r and δ , such

that $-\pi/2 < \Phi_1 < \Phi_2 < \pi/2$, $0 < \Phi_0 < \Phi_2 - \Phi_1$, and for any $(\varphi_1, \varphi_2, \delta)$ -reflector, being a constituent of Ω , holds $\varphi_1, \varphi_2 \in [\Phi_1, \Phi_2]$, $|\varphi_2 - \varphi_1| \geq \Phi_0$. It suffices to put $\Phi_1 = \min_{i \neq j} \Phi_1(i, j)$, $\Phi_2 = \max_{i \neq j} \Phi_2(i, j)$, $\Phi_0 = \min\{\Phi_0(i, j) : i \neq j, (i, j) \neq (1, m), (m, 1)\}$.

From existence of the mentioned values and from lemma 4 it follows

Corollary 1. *If x, φ are such that x belongs to the $(1 - c\delta - c|\varphi - \varphi_1|)$ -base of some $(\varphi_1, \varphi_2, \delta)$ -reflector constituting $\Omega(\sigma, r, \delta)$ then*

$$\varphi_{\check{R}, \check{I}}^+(x, \varphi) - \varphi_2 = -\frac{\cos \varphi_1}{\cos \varphi_2} (\varphi - \varphi_1) + O(\delta) + O((\varphi - \varphi_1)^2). \quad (17)$$

Here \check{R} denotes this reflector, \check{I} , its base. If, in addition, $\delta < c_0$ and $|\varphi - \varphi_1| < c_0$ then

$$n_{\check{R}, \check{I}}(x, \varphi) = 3. \quad (18)$$

Here c, c_0 are positive values that depend only on σ .

Like in lemma 4, here we denote by $O(f)$ a generic function of $x, \varphi, \varphi_1, \varphi_2, \delta, r$ such that $O(f)/f$ is bounded over all admissible values of the arguments.

4.4 Proof of convergence $\nu_{\Omega, I} \rightarrow \nu^\sigma$

Consider a positive function $\delta = \delta(r) = o(1/r)$, $r \rightarrow +\infty$. Recall that $n_{\Omega, I}(x, \varphi)$ designates the number of reflections from $\partial\Omega$ (including the last reflection from I) the particle getting out of $x \in I$ in the direction φ has to make before returning to I . Define the function $n_\sigma : I \times [-\pi/2, \pi/2] \rightarrow \mathbb{R}$ by the relations $n_\sigma(x, \varphi) = 5$, if $\varphi \in \Theta_i$, $\sigma(i) \neq i$, and $n_\sigma(x, \varphi) = 2$, if $\varphi \in \Theta_i$, $\sigma(i) = i$. Thus, n_σ does not depend on the argument x : $n_\sigma(x, \varphi) = n_\sigma(\varphi)$. At the endpoints of Θ_i , the definition may turn out to be ambiguous; correct it by redefining n_σ at these points. Denote $\Omega(r) := \Omega(\sigma, r, \delta(r))$; that is, $\Omega(r)$ is a one parameter family of sets depending on r . Recall that $(\Omega(r), I) \in \mathcal{S}$.

The following lemma is basic.

Lemma 5. *One has convergence in measure*

$$\lim_{r \rightarrow +\infty} n_{\Omega(r), I} = n_\sigma, \quad (19)$$

$$\lim_{r \rightarrow +\infty} \varphi_{\Omega(r), I}^+ = \varphi_\sigma. \quad (20)$$

In other words, the lemma states that for large r , all the particles getting in Ω through I , except for a small part of them, after one or four reflections get out through I , besides the relation between the angles of getting in and getting out is close to the one given by φ_σ .

Proof. Fix i . It suffices to prove that there exists a family of sets $A_r \subset I \times \Theta_i$ such that their measures converge to zero: $\lim_{r \rightarrow +\infty} \mu(A_r) = 0$ and

$$\text{for } (x, \varphi) \in (I \times \Theta_i) \setminus A_r \text{ holds } n_{\Omega(r), I}(x, \varphi) = n_\sigma(\varphi) \quad (21)$$

and

$$\lim_{r \rightarrow +\infty} \sup_{(x, \varphi) \in (I \times \Theta_i) \setminus A_r} |\varphi_{\Omega(r), I}^+(x, \varphi) - \varphi_\sigma(\varphi)| = 0. \quad (22)$$

Consider the cases $\sigma(i) = i$ and $\sigma(i) \neq i$ separately.

(a) Let $\sigma(i) = i$. In this case the relations (21) and (22) may be re-written in the form

$$1) \text{ for } (x, \varphi) \in (I \times \Theta_i) \setminus A_r \text{ holds } n_{\Omega(r), I}(x, \varphi) = 2;$$

$$2) \lim_{r \rightarrow +\infty} \sup_{(x, \varphi) \in (I \times \Theta_i) \setminus A_r} |\varphi_{\Omega(r), I}^+(x, \varphi) - \varphi| = 0.$$

It follows from simple geometric argument that if a billiard particle in $\Omega(r)$ is initially placed at $x = (\xi, 0) \in I$ and has velocity e_φ , $\varphi \in (\theta_{i-1} + \arcsin \frac{1}{2r}, \theta_i - \arcsin \frac{1}{2r}) \subset \Theta_i$ then the first reflection point $x' = re_\theta$ belongs to the arc $\overset{\frown}{P_{i-1}P_i} = \{re_\theta : \theta \in \Theta_i\}$. The second reflection occurs at a point $x^+ = (\xi^+, 0)$, the velocity before the second reflection being $-e_{\varphi^+}$. By using simple geometric argument, related to the triangle with vertices x , x' , and x^+ , one comes to the relation

$$\frac{1}{\xi} - \frac{1}{\xi^+} = \frac{2 \sin \theta}{r}.$$

It implies that if $|\xi| < 1/(2 + 4/r)$ then $|\xi^+| < 1/2$, that is, the second reflection point x^+ belongs to I . Denoting

$$A_r = \left(\left[-\frac{1}{2}, -\frac{1}{2+4/r} \right] \cup \left[\frac{1}{2+4/r}, \frac{1}{2} \right] \right) \times \left(\left[\theta_{i-1}, \theta_{i-1} + \arcsin \frac{1}{2r} \right] \cup \left[\theta_i - \arcsin \frac{1}{2r}, \theta_i \right] \right),$$

one concludes that for $(x, \varphi) \in (I \times \Theta_i) \setminus A_r$, 1) holds true; besides, one has $\varphi^+ = \varphi_{\Omega(r), I}^+(x, \varphi)$. One obviously has $\lim_{r \rightarrow +\infty} \mu(A_r) = 0$.

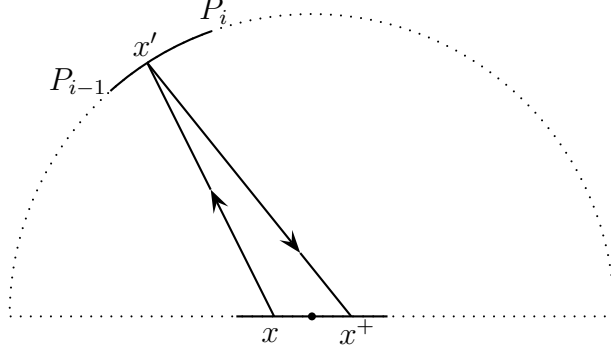

Further, from geometric argument related to the same triangle it follows that $|\varphi^+ - \varphi| < 2 \arctan \frac{1}{2r} = o(1)$, $r \rightarrow +\infty$. Thus, 2) is also proved.

(b) Let $\sigma(i) = j \neq i$. All the estimates below are true for $r \rightarrow +\infty$ and are uniform with respect to x and φ . The assertions stated here are true for sufficiently large values of r , and therefore for sufficiently small $\delta = \delta(r)$.

Let $\phi(r) := \sup \angle LPO$, the supremum being taken over all points $L \in I$ and over all points P contained in the broken line $P_0P_1 \dots P_m$. Denote $\kappa(r) = 1 - c\delta(r) - c\phi(r)$, where c is the constant defined in corollary 1. Obviously, $\kappa(r) = 1 + O(r)$. Denote by $[P_{i-1}, P_i]'$ the union of $\kappa(r)$ -bases of the i -reflectors that have centers located at distances more than 1 from both points P_{i-1}, P_i . One has $[P_{i-1}, P_i]' \subset [P_{i-1}, P_i]$, besides the length of $[P_{i-1}, P_i] \setminus [P_{i-1}, P_i]'$ is $O(1)$. The set $[P_{j-1}, P_j]'$ is defined analogously.

Consider the set $A_r^{(1)}$ of values $(x, \varphi) \in I \times \Theta_i$ such that the ray, getting out of the point x in the direction φ , intersects the broken line $P_0P_1 \dots P_m$ at a point that does not belong to $[P_{i-1}, P_i]'$. Thus, the point of intersection x' belongs to a set of Lebesgue measure $O(1)$. Denote by φ' the angle the vector e_φ forms with n_i . (Recall that n_i is the unit outer normal to ∂Q at a point of $[P_{i-1}, P_i]$). For any fixed x' , the value φ' is contained in an interval of length $O(1/r)$. Thus, measure μ of the set of points (x', φ') is $O(1/r)$. Taking into account that the mapping $(x, \varphi) \rightarrow (x', \varphi')$ preserves the measure μ , one concludes that $\mu(A_r^{(1)}) = O(1/r)$, $r \rightarrow +\infty$.

A billiard particle with initial data $(x, \varphi) \in (I \times \Theta_i) \setminus A_r^{(1)}$ at some mo-

ment intersects the $\kappa(r)$ -base of an i -reflector, makes two reflections off its boundary, then, according to corollary 1, intersects the base again and leaves the reflector. At the moment of leaving, its velocity forms an angle $O(1/r)$ with the ray AB that is defined as follows: the point A is the center of this i -reflector, θ is such that $\frac{OA}{|OA|} = e_\theta$; $\theta^+ = \varphi_\sigma(\theta)$, the point B belongs to the broken line $P_0P_1 \dots P_m$ and $\frac{OB}{|OB|} = e_{\theta^+}$.

Let x'' be the point at which the particle intersects the line $\partial Q = P_0P_1 \dots P_mP_0$ again (for the third time), and let φ'' be the angle the velocity of the particle forms with n_j at the moment of intersection. Denote by $A_r^{(2)}$ the set of values $(x, \varphi) \in (I \times \Theta_i) \setminus A_r^{(1)}$ such that $x'' \notin [P_{j-1}, P_j]'$. Again, it is true that x'' belongs to a set of Lebesgue measure $O(1)$ and for any fixed x'' , the value φ'' belongs to an interval of length $O(1/r)$. It follows that measure of the set of points (x'', φ'') is $O(1/r)$, and taking into account that the mapping $(x, \varphi) \rightarrow (x'', \varphi'')$ preserves the measure μ , one concludes that $\mu(A_r^{(2)}) = O(1/r)$, $r \rightarrow +\infty$.

Consider an element $(x, \varphi) \in (I \times \Theta_i) \setminus (A_r^{(1)} \cup A_r^{(2)})$; the corresponding billiard particle reflects two times off the boundary of an i -reflector, then reflects two times off the boundary of a j -reflector, and for the fifth time, reflects at a point $x^+ \in [-r, r] \times \{0\}$. Denote by $-e_{\varphi^+}$ the velocity just before the fifth reflection. The set of elements (x, φ) such that $x^+ \notin I$ is designated by $A_r^{(3)}$.

Let us introduce some auxiliary notation. Mark by letter L the point $x = (\xi, 0)$, and by letter L^+ , the point $x^+ = (\xi^+, 0)$. Mark by letters A and B' , respectively, the centers of those i - and j -reflectors that contain the reflection points. The first of them is a $(\varphi_1, \varphi_2, \delta)$ -reflector, and the second, a (ψ_1, ψ_2, δ) -reflector; thereby the values φ_1 , φ_2 , ψ_1 , ψ_2 are determined. Recall that the angle θ is such that $\frac{OA}{|OA|} = e_\theta$; $\theta^+ := \varphi_\sigma(\theta)$; and the point $B \in [P_{j-1}, P_j]$ is such that $\frac{OB}{|OB|} = e_{\theta^+}$. Further, define $d\theta^+$ in such a way that $\frac{OB'}{|OB'|} = e_{\theta^+ + d\theta^+}$; define $d\theta$ in such a way that $\varphi_\sigma(\theta + d\theta) = \theta^+ + d\theta^+$, and denote by $A' \in [P_{i-1}, P_i]$ the point such that $\frac{OA'}{|OA'|} = e_{\theta + d\theta}$. On the figure below, the case $i < j$, $\xi > 0$ is shown; these relations imply that $d\theta < 0$ and $d\theta^+ > 0$. The last inequalities are used in the geometric reasoning given below. The cases where $i > j$ and/or $\xi < 0$ can be considered analogously.

One easily sees that the values φ_1 and φ_2 , defined above, are the angles the rays AO and AB , respectively, form with the normal $-n_i$, and the values ψ_1 and ψ_2 are the angles the rays $B'O$ and $B'A'$, respectively, form with $-n_j$.

Remind that throughout this paper, the angles are counted clockwise from the normal vector to the ray. Therefore, on the figure below one has $\varphi_1 > 0$, $\varphi_2 < 0$, $\psi_1 < 0$, $\psi_2 > 0$.

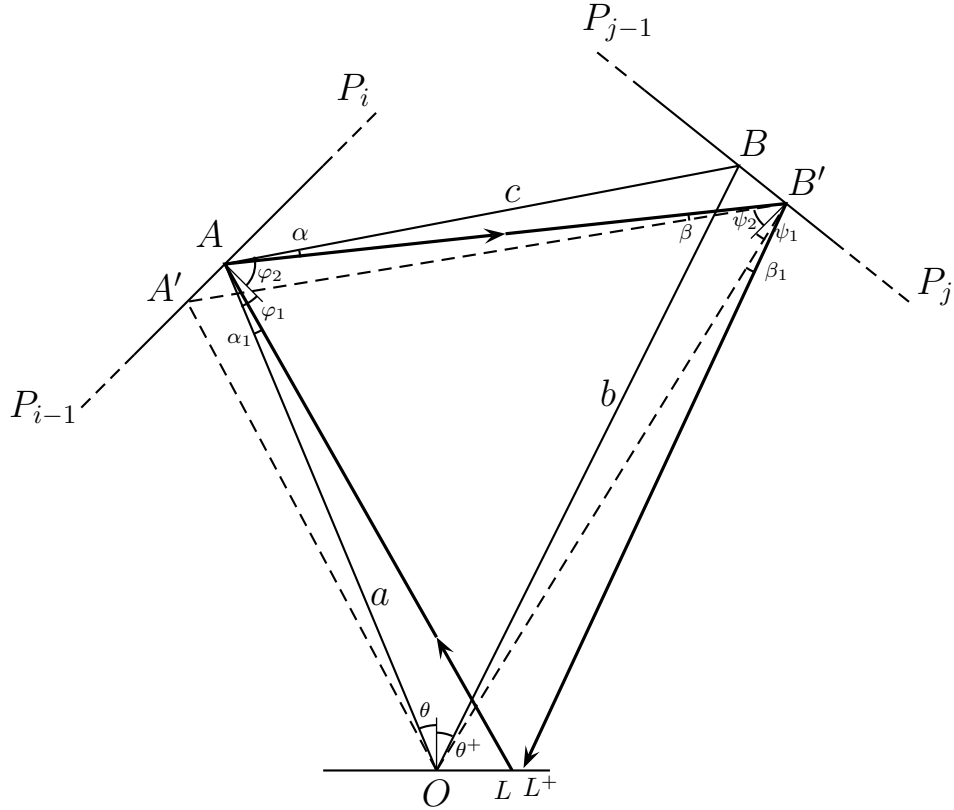

Designate $a = |OA|$, $b = |OB|$, $c = |AB|$. Recalling the definition of the set $A_r^{(1)}$ and taking into account that $|AB| > |AP_i|$, one concludes that $c \geq 1$. Designate also $dx = |AA'|$, $dx^+ = |BB'|$; $\alpha = \angle BAB'$, $\beta = \angle AB'A'$; $\alpha_1 = \angle OAL$, $\beta_1 = \angle OB'L^+$.

Recall that $|OL| \leq 1/2$, the value a is of order r , direction of the ray LA does not coincide with direction of the billiard trajectory, but rather deviates from it, the difference being $O(\delta/r)$. Thus, $\varphi = \theta + \alpha_1 + O(\delta/r)$. Further, the difference between the direction of AB' and the true direction of the billiard particle is $O(\delta/c)$. Besides, $\alpha_1 = O(1/r)$. The billiard particle intersects

the $\kappa(r)$ -base of the i -reflector, makes two reflections off its boundary, then intersects the base again and leaves the reflector, the angles at the moments of the first and second intersection being $\tilde{\varphi} = \varphi_1 - \alpha_1 + O(\delta/r)$ and $\tilde{\varphi}^+ = \varphi_2 + \alpha + O(\delta/c)$, respectively. Applying corollary 1, one gets $\tilde{\varphi}^+ - \varphi_2 = -\frac{\cos \varphi_1}{\cos \varphi_1} (\tilde{\varphi} - \varphi_1) + O(\delta) + O((\tilde{\varphi} - \varphi_1)^2)$, hence

$$\alpha + O(\delta/c) = -\frac{\cos \varphi_1}{\cos \varphi_2} (-\alpha_1 + O(\delta/r)) + O(\delta) + O(1/r^2),$$

therefore

$$\alpha_1 \cos \varphi_1 = \alpha \cos \varphi_2 + o(1/r). \quad (23)$$

This implies that $\alpha = O(1/r)$, hence $dx^+ = O(c/r)$ and $d\theta^+ = O(c/r^2)$. The last equality implies that $d\theta = O(c/r^2)$, therefore $dx = O(c/r)$ and $\beta = O(1/r)$. After leaving the i -reflector, the particle gets into the j -reflector through its $\kappa(r)$ -base, makes the third and fourth reflections off its boundary, and then gets out of this reflector; the angles at the moment of getting in and getting out are $\check{\varphi} = \psi_2 + \beta + O(\delta/c)$ and $\check{\varphi}^+ = \psi_1 - \beta_1 + O(\delta/r)$, respectively. Applying corollary 1 again, one comes to the formula $\check{\varphi}^+ - \psi_1 = -\frac{\cos \psi_2}{\cos \psi_1} (\check{\varphi} - \psi_2) + O(\delta) + O((\check{\varphi} - \psi_2)^2)$, hence

$$-\beta_1 + O(\delta/r) = -\frac{\cos \psi_2}{\cos \psi_1} (\beta + O(\delta/c)) + O(\delta) + O(1/r^2),$$

therefore

$$\beta_1 \cos \psi_1 = \beta \cos \psi_2 + o(1/r). \quad (24)$$

The function φ_σ preserves the measure λ and monotonically decreases on Θ_i , hence

$$-\cos \theta d\theta = \cos \theta^+ d\theta^+ (1 + o(1)). \quad (25)$$

Finally, simple trigonometric relations for the triangles shown on the figure imply the following (asymptotic as $r \rightarrow +\infty$) equalities (just for the purpose of completeness, we put below the formulas (23)–(25)):

$$\alpha_1 = \xi \frac{\cos \theta}{a} (1 + o(1)); \quad \alpha = \alpha_1 \frac{\cos \varphi_1}{\cos \varphi_2} + o(1/r); \quad dx^+ = \alpha \frac{c}{\cos \psi_2} (1 + o(1));$$

$$d\theta^+ = dx^+ \frac{\cos \psi_1}{b} (1 + o(1)); \quad -d\theta = d\theta^+ \frac{\cos \theta^+}{\cos \theta} (1 + o(1)); \quad dx = -d\theta \frac{a}{\cos \varphi_1} (1 + o(1));$$

$$\beta = dx \frac{\cos \varphi_2}{c} (1 + o(1)); \quad \beta_1 = \beta \frac{\cos \psi_2}{\cos \psi_1} + o(1/r); \quad \xi^+ = \beta_1 \frac{b}{\cos \theta^+} (1 + o(1)).$$

Making successive substitutions (from the bottom to the top) in these formulas, one obtains

$$\xi^+ = \xi(1 + o(1)) + \frac{o(1)}{\cos \theta} + \frac{o(1)}{\cos \theta^+}.$$

This relation can be rewritten in the form

$$|\xi^+| \leq |\xi| (1 + \alpha(r)) + \frac{\alpha(r)}{\cos \theta} + \frac{\alpha(r)}{\cos \theta^+},$$

where $\alpha(r)$ is a positive function going to zero as $r \rightarrow +\infty$. Taking into account that $\varphi = \theta + O(1/r)$, $\varphi^+ = \theta^+ + O(1/r)$, select a constant c such that $|\varphi - \theta| \leq c/r$, $|\varphi^+ - \theta^+| \leq c/r$. Define the three sets $A'_r, A''_r, A'''_r \subset (I \times \Theta_i) \setminus (A_r^{(1)} \cup A_r^{(2)})$ as follows: A'_r is the set of pairs $x = (\xi, 0)$, φ such that $|\xi| \geq (1/2 - 2\sqrt{\alpha(r)})/(1 + \alpha(r))$; A''_r is the set of (x, φ) such that $|\varphi| \geq \arccos \sqrt{\alpha(r)} - c/r$; A'''_r is the set of (x, φ) such that $|\varphi^+| \geq \arccos \sqrt{\alpha(r)} - c/r$. It is not difficult to check that the measure of each of these sets goes to zero as $r \rightarrow +\infty$. Moreover, if (x, φ) does not belong to these sets then $|\xi^+| < 1/2$, therefore $x^+ \in I$. This implies that $A_r^{(3)} \subset A'_r \cup A''_r \cup A'''_r$ and therefore $\lim_{r \rightarrow +\infty} \mu(A_r^{(3)}) = 0$.

Denote $A_r = A_r^{(1)} \cup A_r^{(2)} \cup A_r^{(3)}$; one has $\lim_{r \rightarrow +\infty} \mu(A_r) = 0$. If $(x, \varphi) \in (I \times \Theta_i) \setminus A_r$ then there are four reflections at points $\partial\Omega$ that do not belong to I , and the fifth reflection, at a point of I ; therefore, one has $\varphi^+ = \varphi_{\Omega(r), I}^+(x, \varphi)$ and $n_{\Omega(r), I}(x, \varphi) = 5$. Thus, (21) is proved.

It follows from the equations $\varphi^+ = \theta^+ + o(1)$, $\theta^+ = \varphi_\sigma(\theta)$, $\theta = \varphi + o(1)$ that $\varphi^+ = \varphi_\sigma(\varphi) + o(1)$, $r \rightarrow +\infty$; therefore, (22) is also proved. \square

From lemma 5 it follows

Corollary 2. *As $r \rightarrow +\infty$, $\nu_{\Omega(r), I}$ weakly converges to ν^σ .*

Proof. Indeed, (20) implies that the mapping $(\varphi, \varphi_{\Omega(r), I}^+(x, \varphi))$ from $I \times [-\pi/2, \pi/2]$ to Q , as $r \rightarrow +\infty$, converges in measure to the mapping $(\varphi, \varphi_\sigma(\varphi))$, hence $f(\varphi, \varphi_{\Omega(r), I}^+(x, \varphi))$ converges in measure to $f(\varphi, \varphi_\sigma(\varphi))$ for any continuous function $f : Q \rightarrow \mathbb{R}$. This implies that

$$\lim_{r \rightarrow +\infty} \iint_{I \times [-\pi/2, \pi/2]} f(\varphi, \varphi_{\Omega(r), I}^+(x, \varphi)) d\mu(x, \varphi) = \iint_{I \times [-\pi/2, \pi/2]} f(\varphi, \varphi_\sigma(\varphi)) d\mu(x, \varphi).$$

Using the relations $\iint_{I \times [-\pi/2, \pi/2]} f(\varphi, \varphi_{\Omega, I}^+(x, \varphi)) d\mu(x, \varphi) = \iint_Q f(\varphi, \varphi^+) d\nu_{\Omega, I}(\varphi, \varphi^+)$ and $\iint_{I \times [-\pi/2, \pi/2]} f(\varphi, \varphi_\sigma(\varphi)) d\mu(x, \varphi) = \iint_Q f(\varphi, \varphi^+) d\nu^\sigma(\varphi, \varphi^+)$, which arise from the definitions of measures $\nu_{\Omega, I}$, ν^σ and hold true for arbitrary f and $(\Omega, I) \in \mathcal{S}$, one gets

$$\lim_{r \rightarrow +\infty} \int_Q f d\nu_{\Omega(r), I} = \int_Q f d\nu^\sigma.$$

Corollary is proved. □

According to lemma 2, any measure from \mathcal{M} can be approximated by measures of the kind ν^σ , where $\sigma^2 = \text{id}$, $\sigma(1) \neq m$, and according to corollary 2, any such measure ν^σ can be approximated by measures of the kind $\nu_{\Omega(r), I}$ where $(\Omega(r), I) \in \mathcal{S}$. This proves theorem 2.

Appendix

Proof of lemma 1

Let $(\Omega, I) \in \mathcal{S}$. Taking into account that the measure $\nu_{\Omega, I}$ is invariant with respect to isometries applied simultaneously to Ω and to I , one can assume, without loss of generality, that I coincides with the segment $[-a, a] \times \{0\}$, $a > 0$, and $\Omega \subset \mathbb{R} \times [0, +\infty)$. Define the sets $\Omega^{[n]}$, $I^{[n]}$ by

$$\Omega^{[n]} = \Omega \cup ([-a, a] \times [-1/n, 0]), \quad I^{[n]} = [-a, a] \times \{-1/n\}.$$

Define the mapping $\mathcal{T}_{(n)}$ in the following way. Consider billiard in the rectangle $[-a, a] \times [-1/n, 0]$. From a point $x \in I_n$ let out a particle with initial velocity $(\sin \varphi, \cos \varphi)$, $-\pi/2 < \varphi < \pi/2$. After several (maybe none) reflections off vertical sides of the rectangle, the particle reflects off I at a point $x^{(n)}(x, \varphi)$, its velocity before the reflection being $(\sin \varphi^{(n)}(x, \varphi), \cos \varphi^{(n)}(x, \varphi))$. Thereby, the mapping $\mathcal{T}_{(n)} : (x, \varphi) \mapsto (x^{(n)}(x, \varphi), \varphi^{(n)}(x, \varphi))$ is determined; it is defined and takes values on full measure subsets of $I^{[n]} \times [-\pi/2, \pi/2]$ and preserve the measure μ . It is not difficult to see that the mappings $\mathcal{T}_{\Omega^{[n]}, I^{[n]}}$ and $\mathcal{T}_{\Omega, I}$ are interconnected in the following way:

$$\mathcal{T}_{\Omega^{[n]}, I^{[n]}} = \mathcal{T}_{(n)}^{-1} \mathcal{T}_{\Omega, I} \mathcal{T}_{(n)}.$$

Let $B_n = \{(x, \varphi) \in I^{[n]} \times [-\pi/2, \pi/2] : \varphi^{(n)}(x, \varphi) = \varphi\}$. It is easy to see that $B_n \subset \{(x, \varphi) : x = (\xi, -1/n), -a \leq \xi \leq a, -\pi/2 \leq \varphi \leq -\arctan n(a + \xi) \text{ or } \arctan n(a - \xi) \leq \varphi \leq \pi/2\}$; this implies that $\mu(B_n) = o(1)$, $n \rightarrow \infty$, where $d\mu(x, \varphi) = \cos \varphi dx d\varphi$. Put $B'_n = \mathcal{T}_{\Omega^{[n]}, I^{[n]}}^{-1}(B_n)$.

Let $A \subset Q = [-\pi/2, \pi/2] \times [-\pi/2, \pi/2]$ be an arbitrary measurable set. Denote $D_A = \{(x, \varphi) : (\varphi, \varphi_{\Omega, I}^+(x, \varphi)) \in A\}$ and $D_A^{(n)} = \{(x, \varphi) : (\varphi, \varphi_{\Omega^{[n]}, I^{[n]}}^+(x, \varphi)) \in A\}$. One has

$$D_A^{(n)} \Delta \left(\mathcal{T}_{(n)}^{-1}(D_A) \right) \subset B_n \cup B'_n,$$

where Δ means symmetric difference of sets. Hence $|\mu(D_A^{(n)}) - \mu(D_A)| \leq \mu(B_n \cup B'_n) \leq 2\mu(B_n)$; this implies

$$\nu_{\Omega^{[n]}, I^{[n]}}(A) = \nu_{\Omega, I}(A) + o(1),$$

the estimate $o(1)$ being uniform over all A . This means that the sequence of measures $\nu_{\Omega^{[n]}, I^{[n]}}$ converges in variation, and hence weakly, to $\nu_{\Omega, I}$.

4.5 Proof of lemma 2

Let us previously prove an auxiliary statement.

Lemma 6. *Let $A = (a_{ij})_{i,j=1}^m$ be a symmetric matrix, a_{ij} being nonnegative integers. Denote $n_i = \sum_{j=1}^m a_{ij}$. There exist matrices $B_{ij} = (b_{ij}^{\mu\nu})_{\mu,\nu}$, $i, j = 1, \dots, m$ of order $n_i \times n_j$ such that $B_{ij}^T = B_{ji}$, $\sum_{\mu=1}^{n_i} \sum_{\nu=1}^{n_j} b_{ij}^{\mu\nu} = a_{ij}$ and the block matrix $B = (B_{ij})$ contains precisely one "1" in each row and each column, other elements of B being zeros.*

Note 1. *It may happen that for some values $i = i_1, i_2, \dots$ and for any j , holds $a_{ij} = 0$. For these values of i , one has $n_i = 0$ and the matrices B_{ij} and B_{ji} for any j have the order $0 \times n_j$ and $n_j \times 0$, respectively, that is, they are empty sets. In this case the matrix B coincides with the block matrix $B' = (B_{ij})$, where the rows with indices $i = i_1, i_2, \dots$ and columns with indices $j = i_1, i_2, \dots$ are crossed out.*

Proof. Apply induction by m . Let the lemma be proved for $m - 1$. When applying it to the matrix $\tilde{A} = (a_{ij})_{i,j=2}^m$, one obtains that there exists a block matrix $\tilde{B} = (\tilde{B}_{ij})_{i,j=2}^m$ satisfying the condition of lemma. Note that the order

of \tilde{B}_{ij} is $\tilde{n}_i \times \tilde{n}_j$, where $\tilde{n}_i = \sum_{j=2}^m a_{ij} = n_i - a_{i1}$. Define the matrices B_{ij} as follows.

(a) Let $B_{11} = \text{diag} \{ \underbrace{1, \dots, 1}_{a_{11}}, 0, \dots, 0 \}$.

(b) Let $b_{12}^{a_{11}+1,1} = \dots = b_{12}^{a_{11}+a_{12},a_{12}} = 1; b_{13}^{a_{11}+a_{12}+1,1} = \dots = b_{13}^{a_{11}+a_{12}+a_{13},a_{13}} = 1; \dots; b_{1m}^{a_{11}+\dots+a_{1,m-1}+1,1} = \dots = b_{1m}^{a_{11}+\dots+a_{1m},a_{1m}} = 1$; other elements of the matrices B_{1j} , $j = 2, \dots, m$ are zeros. Thus, in each matrix B_{1j} , on the diagonal, whose first element belongs to the first column and the $(a_{11} + a_{12} + \dots + a_{1,j-1} + 1)$ th row, the first a_{1j} elements equal 1, and the remaining elements on this diagonal and all the elements outside the diagonal equal zero. Thus, the matrices B_{1j} , $j = 2, \dots, m$ are defined. The matrices B_{i1} , $i = 2, \dots, m$ are defined by the condition $B_{i1} = B_{1i}^T$.

(c) For $i \geq 2$, $j \geq 2$ define the matrix B_{ij} as follows. For $\mu \leq a_{1i}$ or $\nu \leq a_{1j}$ let $b_{ij}^{\mu\nu} = 0$, and for $\mu \geq a_{1i} + 1$, $\nu \geq a_{1j} + 1$ let $b_{ij}^{\mu\nu} = \tilde{b}_{ij}^{\mu-a_{1i}, \nu-a_{1j}}$. Thus, in the obtained matrix B_{ij} , the right lower corner coincides with the matrix \tilde{B}_{ij} , and all the remaining elements are equal to zero. The number of rows of this matrix equals $a_{1i} + \tilde{n}_i = n_i$, and the number of columns, $a_{1j} + \tilde{n}_j = n_j$. It is also not difficult to verify that $\sum_{\mu\nu} b_{ij}^{\mu\nu} = a_{ij}$ and that each row and each column of the obtained block matrix $B = (B_{ij})_{i,j=1}^m$ contains precisely one number "1". \square

Now, let us proceed to the proof of lemma 2.

Consider an arbitrary measure $\nu \in \mathcal{M}$. Let $n \in \mathbb{N}$; consider the partition of the square Q to n^2 smaller squares $Q_{ij}^n = \Theta_i^n \times \Theta_j^n$; $Q = \cup_{i,j=1}^n Q_{ij}^n$. Let us show that for all $n \in \mathbb{N}$, $1 \leq i, j \leq n$ one can choose rational non-negative numbers c_{ij}^n in such a way that $c_{ij}^n = c_{ji}^n$, for any i $\sum_j c_{ij}^n = 2/n$ and $n^2 \cdot \max_{i,j} |\nu(Q_{ij}^n) - c_{ij}^n|$ tends to 0 as $n \rightarrow \infty$.

Indeed, for $i > j$ choose values c_{ij}^n in such a way that $|c_{ij}^n - \nu(Q_{ij}^n)| \leq n^{-4}$; for $i < j$ put $c_{ij}^n = c_{ji}^n$; finally, for $i = j$ put $c_{ii}^n = 2/n - \sum_{j \neq i} c_{ij}^n$. One has $\sum_{j=1}^n \nu(Q_{ij}^n) = \nu(\Theta_i^n \times [-\pi/2, \pi/2]) = \lambda(\Theta_i^n) = 2/n$, hence $\nu(Q_{ii}^n) = 2/n - \sum_{j \neq i} \nu(Q_{ij}^n)$. This implies that $|c_{ii}^n - \nu(Q_{ii}^n)| = |\sum_{j \neq i} (c_{ij}^n - \nu(Q_{ij}^n))| \leq (n-1) \cdot n^{-4} < n^{-3}$. Therefore $|\max_{i,j} (\nu(Q_{ij}^n) - c_{ij}^n)| < n^{-3}$.

Any sequence of measures ν_n , satisfying the conditions $\nu_n(Q_{ij}^n) = c_{ij}^n$, $1 \leq i, j \leq n$, weakly converges to ν . Indeed, for any continuous function $f : Q \rightarrow \mathbb{R}$ holds

$$\int_Q f d\nu_n - \int_Q f d\nu = \sum_{i,j=1}^n \left(\int_{Q_{ij}^n} f d\nu_n - \int_{Q_{ij}^n} f d\nu \right) =$$

$$\begin{aligned}
&= \sum_{i,j=1}^n (f(x_{ij}^n) c_{ij}^n - f(\tilde{x}_{ij}^n) \nu(Q_{ij}^n)) = \\
&= \sum_{i,j=1}^n f(x_{ij}^n) (c_{ij}^n - \nu(Q_{ij}^n)) + \sum_{i,j=1}^n (f(x_{ij}^n) - f(\tilde{x}_{ij}^n)) \nu(Q_{ij}^n), \quad (26)
\end{aligned}$$

where $x_{ij}^n, \tilde{x}_{ij}^n \in Q_{ij}^n$. Taking into account that $|f(x_{ij}^n) - f(\tilde{x}_{ij}^n)| \leq \max_{i,j} \sup_{x', x'' \in Q_{ij}^n} |f(x') - f(x'')| \rightarrow 0$ as $n \rightarrow \infty$ and that $n^2 \cdot \max_{i,j} |\nu(Q_{ij}^n) - c_{ij}^n| \rightarrow 0$ as $n \rightarrow \infty$, one concludes that the expression in (26) tends to zero as $n \rightarrow \infty$.

Thus, to finish the proof of lemma, it suffices to show that for any $n \in \mathbb{N}$ there exist a positive integer m and a permutation σ_n of $\{1, \dots, m\}$ such that $\sigma_n^2 = \text{id}$, $\nu^{\sigma_n}(Q_{ij}^n) = c_{ij}^n$ and $\sigma_n(1) \neq m$.

Fix n and find a positive integer N such that all values $a_{ij} := N \cdot c_{ij}^n$ are integer. Obviously, the matrix $A = (a_{ij})_{i,j=1}^n$ is symmetric and for any i $\sum_{j=1}^n a_{ij} = 2N/n \in \mathbb{N}$. According to lemma 6, there exist square matrices B_{ij} of order $2N/n$ such that $B_{ij}^T = B_{ji}$, the sum of elements of each matrix B_{ij} equals a_{ij} , and composed of them block matrix $B = (B_{ij})$ has precisely one unit in each row and each column, and all the remaining elements are zeros.

Consider block matrices D_{ij} of double size, obtained from B_{ij} by substitution of elements with 2×2 matrices: zeros are substituted with $\begin{pmatrix} 0 & 0 \\ 0 & 0 \end{pmatrix}$, and units, with $\begin{pmatrix} 1 & 0 \\ 0 & 1 \end{pmatrix}$. The matrices D_{ij} have order $4N/n$, holds $D_{ij}^T = D_{ji}$, the sum of elements in each matrix D_{ij} equals $2a_{ij}$, and the block matrix $D = (D_{ij})$ composed of D_{ij} has precisely one unit in each column and each row, and all remaining elements are zeros.

The order of D is $4N$. Let $m = 4N$ and denote by d_{ij} , $i, j = 1, \dots, m$, the elements of D . The peculiarity of D , as compared to B , is that the equality $d_{1m} = 0$ is guaranteed. Define the mapping $\sigma = \sigma_n : \{1, \dots, m\} \rightarrow \{1, \dots, m\}$ in such a way that for any i , $d_{i\sigma(i)} = 1$. The so defined mapping σ_n is a permutation; since the matrix D is not symmetric, one concludes that $\sigma_n^2 = \text{id}$, and since $d_{1m} \neq 1$, one concludes that $\sigma_n(1) \neq m$. Besides, the following holds true: $\nu^{\sigma_n}(Q_{ij}^n) = N^{-1} \sum_{\mu, \nu} b_{ij}^{\mu\nu} = c_{ij}^n$. Lemma is proved.

Acknowledgements

This work was supported by *Centre for Research on Optimization and Control* (CEOC) from the "Fundação para a Ciência e a Tecnologia" (FCT), cofinanced by the European Community Fund FEDER/POCTI.

References

- [1] I. Newton, *Philosophiae naturalis principia mathematica* 1686.
- [2] G. Buttazzo and B. Kawohl. *On Newton's problem of minimal resistance*. Math. Intell. **15**, 7–12 (1993).
- [3] F. Brock, V. Ferone, and B. Kawohl. *A symmetry problem in the calculus of variations*. Calc. Var. **4**, 593–599 (1996).
- [4] G. Buttazzo, V. Ferone, and B. Kawohl. *Minimum problems over sets of concave functions and related questions*. Math. Nachr. **173**, 71–89 (1995).
- [5] G. Buttazzo and P. Guasoni, *Shape optimization problems over classes of convex domains*, J. Convex Anal. **4**, No.2, 343-351 (1997).
- [6] T. Lachand-Robert and M. A. Peletier. *Newton's problem of the body of minimal resistance in the class of convex developable functions*. Math. Nachr. **226**, 153–176 (2001).
- [7] T. Lachand-Robert, M. A. Peletier. *An example of non-convex minimization and an application to Newton's problem of the body of least resistance*. Ann. Inst. H. Poincaré, Anal. Non Lin. **18**, 179–198 (2001).
- [8] M. Comte and T. Lachand-Robert. *Newton's problem of the body of minimal resistance under a single-impact assumption*. Calc. Var. Partial Differ. Equ. **12**, 173–211 (2001).
- [9] M. Comte and T. Lachand-Robert. *Existence of minimizers for Newton's problem of the body of minimal resistance under a single-impact assumption*. J. Anal. Math. **83**, 313–335 (2001).
- [10] T. Lachand-Robert and E. Oudet. *Minimizing within convex bodies using a convex hull method*. SIAM J. Optim. **16**, 368–379 (2006).

- [11] A. Yu. Plakhov. *Newton's problem of a body of minimal aerodynamic resistance*, Dokl. Akad. Nauk **390**, N°3, 314–317 (2003).
- [12] A. Yu. Plakhov. *Newton's problem of the body of minimal resistance with a bounded number of collisions*, Russ. Math. Surv. **58** N°1, 191-192 (2003).
- [13] A. Yu. Plakhov. *Newton's problem of the body of minimum mean resistance*, Sbornik: Mathematics **195**, N°7-8, 1017-1037 (2004).
- [14] A. Yu. Plakhov and Delfim F. M. Torres. *Newton's aerodynamic problem in media of chaotically moving particles*, Sbornik: Mathematics **196**, N°5-6, 885-933 (2005).
- [15] A. Yu. Plakhov. *Billiards in unbounded domains reversing the direction of motion of a particle*, Russ. Math. Surv. **61** N°1, 179-180 (2006).
- [16] S. Tabachnikov, *Billiards*, Paris: Société Mathématique de France (1995).