

Bounded Submodules of Modules

Markus Schmidmeier

Mathematical Sciences, Florida Atlantic University, Boca Raton, Florida 33431-0991

E-mail address: markus@math.fau.edu

Abstract

Let m, n be positive integers such that $m \leq n$. We consider all pairs (B, A) where B is a finite dimensional T^n -bounded $k[T]$ -module and A is a submodule of B which is T^m -bounded. They form the objects of the submodule category $\mathcal{S}_m(k[T]/T^n)$ which is a Krull-Schmidt category with Auslander-Reiten sequences. The case $m=n$ deals with submodules of $k[T]/T^n$ -modules and has been studied well. In this manuscript we determine the representation type of the categories $\mathcal{S}_m(k[T]/T^n)$ also for the cases where $m < n$: It turns out that there are only finitely many indecomposables in $\mathcal{S}_m(k[T]/T^n)$ if either $m < 3$, $n < 6$, or $(m, n) = (3, 6)$; the category is tame if (m, n) is one of the pairs $(3, 7)$, $(4, 6)$, $(5, 6)$, or $(6, 6)$; otherwise, $\mathcal{S}_m(k[T]/T^n)$ has wild representation type. Moreover, in each of the finite or tame cases we describe the indecomposables and picture the Auslander-Reiten quiver.

Keywords: Auslander-Reiten sequences, subgroups of Abelian groups, representation type, invariant subspaces

MSC (2000): 16G70 (primary); 20K27, 16G60, 15A21 (secondary)

For a ring Λ , the *submodule category* $\mathcal{S}(\Lambda)$ has as objects all pairs $(A \subseteq B)$ where B is a finite length Λ -module and A a submodule of B . The morphisms from $(A \subseteq B)$ to $(A' \subseteq B')$ are given by the Λ -linear maps $f: B \rightarrow B'$ which map A into A' . For m a natural number, the category $\mathcal{S}_m(\Lambda)$ of *bounded* submodules is the full subcategory of $\mathcal{S}(\Lambda)$ of all pairs $(A \subseteq B)$ for which $\text{rad}^m A = 0$ holds.

Categories of type $\mathcal{S}_m(\Lambda)$ are exact Krull-Schmidt categories, so every object has a decomposition as a direct sum of indecomposables; this decomposition is unique up to isomorphism and reordering. Aim is the classification of the indecomposable objects in the case where $\Lambda = k[T]/T^n$. The following theorem describes the complexity of this classification problem. It complements known results for the situation where $m = n$.

Theorem 1. *Let $m \leq n$ be positive integers and k be a field.*

1. *The category $\mathcal{S}_m(k[T]/T^n)$ is representation finite if $n < 6$, or if $m < 3$, or if $(m, n) = (3, 6)$.*
2. *The category $\mathcal{S}_m(k[T]/T^n)$ has tame infinite representation type in case (m, n) is one of the pairs $(3, 7)$, $(4, 6)$, $(5, 6)$, or $(6, 6)$.*
3. *Otherwise the category $\mathcal{S}_m(k[T]/T^n)$ is of wild representation type.*

First we relate our results to Birkhoff's problem on the classification of subgroup embeddings and list further related results. We observe that the objects in $\mathcal{S}_m(k[T]/T^n)$ are just the possible configurations of a vectorspace together with a subspace that is invariant under the action of a nilpotent endomorphism. Next we present our methods: Homological algebra, in particular Auslander-Reiten theory, and covering theory. Finally, we investigate the submodule category $\mathcal{S}_m(k[T]/T^n)$ in each of the following cases: (1) $m = 1$; (2) $m = 2$; (3) $m = n - 1$; (4) $m = 3$, $n = 5$; (5) $m = 3$, $n = 6$, which is the largest among the representation finite cases; (6) $m = 3$, $n = 7$, where we comment on Birkhoff's family of indecomposables; (7) $m = 3$, $n = 8$ with a discussion of the wild cases; and (8) $m = 4$, $n = 6$ with a discussion of $\mathcal{S}_4(k[T]/T^6)$ as a subcategory of $\mathcal{S}(k[T]/T^6)$.

A COMMENT ON BIRKHOFF'S PROBLEM

There is a corresponding problem where $\Lambda = \mathbb{Z}/p^n$, so the objects in the category $\mathcal{S}(\mathbb{Z}/p^n)$ are the pairs $(A \subseteq B)$ where B is a finite abelian p^n -bounded group and A a subgroup of B . These subgroup embeddings have attracted a lot of attention since Birkhoff's work in 1934. He observes in [B, Corollary 15.1] that the number of isomorphism types of embeddings $(A \subseteq B)$ where $B = \mathbb{Z}/p^6 \oplus \mathbb{Z}/p^4 \oplus \mathbb{Z}/p^2$ tends to infinity with p . In fact, if B is generated by three elements x, y, z of order p^6, p^4, p^2 , and if A_λ is the subgroup of B generated by $u = p^2x + py + z$ and $v = p^2y + \lambda pz$ for some parameter $\lambda = 0, \dots, p - 1$, as pictured below, then the pairs $(A_\lambda \subseteq B)_\lambda$ form a family of indecomposable and pairwise nonisomorphic objects in $\mathcal{S}_4(\mathbb{Z}/p^6)$. This is the first such family in the sense that $n = 6$ is minimal. However, $m = 4$ is not minimal; in Corollary 15 we show that there is a family $(C_\lambda \subseteq D)$ indexed by $\lambda \in k$ of indecomposable and pairwise nonisomorphic objects in the category in $\mathcal{S}_3(k[T]/T^7)$, and hence a corresponding family in $\mathcal{S}_3(\mathbb{Z}/p^7)$, given by the following diagram.

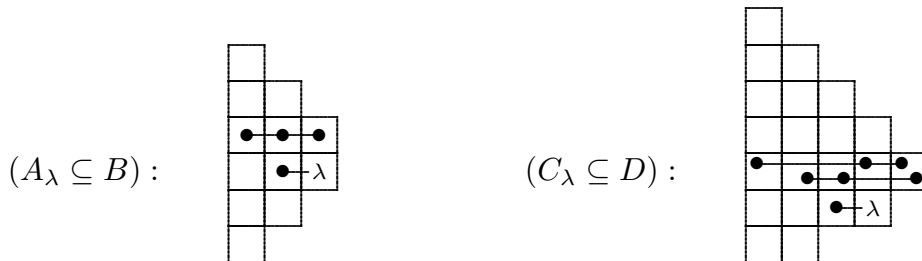

Thus, D has five generators x_1, \dots, x_5 of order p^7, p^6, p^4, p^3 , and p , and the subgroup C_λ is generated by $u_1 = p^4x_1 + px_4 + x_5$, $u_2 = p^3x_2 + p^2x_3 + x_5$, and $u_3 = p^3x_3 + p^2\lambda x_4$.

Let us mention some further results. For the representation finite cases, the classification of the indecomposables has been completed in [4] in case $m = n \leq 5$ and in [9] in case (m, n) is one of the pairs $(3, 5)$, $(3, 6)$, or $(2, n)$ for some n . A detailed analysis of the category $\mathcal{S}(k[T]/T^6)$ is given in [6]. The categories $\mathcal{S}_4(\mathbb{Z}/p^8)$ and $\mathcal{S}_5(\mathbb{Z}/p^{10})$ are presented as examples of infinite and of wild type in [1, Examples 8.2.5 and 8.2.6].

AN EQUIVALENT PROBLEM: INVARIANT SUBSPACES OF A VECTOR SPACE

We consider all triples $(V; U, f)$ where V is a finite dimensional vector space over a field k , $f : V \rightarrow V$ a k -linear map and U a subspace of V which is invariant under

the action of f . The morphisms from $(V; U, f)$ to $(V'; U', f')$ are given by k -linear maps $h : V \rightarrow V'$ which preserve the subspace, that is, $h(U) \subseteq U'$ holds, and which commute with the action of f : $hf' = fh$.

$$\begin{array}{ccc}
 f|_U \begin{array}{c} \circlearrowleft \\ U \end{array} & \xrightarrow{h|_{U,U'}} & \begin{array}{c} \circlearrowleft \\ U' \end{array} f'|_{U'} \\
 \text{incl} \downarrow & & \downarrow \text{incl} \\
 f \begin{array}{c} \circlearrowleft \\ V \end{array} & \xrightarrow{h} & \begin{array}{c} \circlearrowleft \\ V' \end{array} f'
 \end{array}$$

Assuming that the map f acts nilpotently, then the triple $(V; U, f)$ has two isomorphism invariants, namely the nilpotency indices m and n of the action of f on U and on V , respectively. Denote by $\mathcal{S}(m', n')$ the category of all triples for which the nilpotency indices satisfy $m \leq m'$ and $n \leq n'$.

Lemma 2. *The categories $\mathcal{S}(m, n)$ and $\mathcal{S}_m(k[T]/T^n)$ are equivalent.*

Proof: The action of the variable T in $k[T]/T^n$ is given by f . ✓

SOME HOMOLOGICAL PROPERTIES

Let Λ be an artin algebra, or more general, a locally bounded associative k -algebra over a local commutative artinian ring k . Then Λ may not have a unit element but it is assumed that there is a complete set $\{e_i : i \in I\}$ of pairwise orthogonal primitive idempotents such that each of the indecomposable projective modules $e_i\Lambda$ and Λe_i has finite length (see for example [3]).

Many properties of the category $\mathcal{S}_m(\Lambda)$ of bounded submodules are obtained from a corresponding category $\mathcal{H}_m(\Lambda)$ of morphisms between bounded modules, similar to the interplay between $\mathcal{S}(\Lambda)$ and $\mathcal{H}(\Lambda)$ studied in [7]. The objects in $\mathcal{H}_m(\Lambda)$ are the Λ -linear homomorphisms $(f: A \rightarrow B)$ where B is a finite length Λ -module and A a finite length $\Lambda/\text{rad}^m\Lambda$ -module; homomorphisms in this category of homomorphisms are given by the commutative diagrams. Thus $\mathcal{H}_m(\Lambda)$ is equivalent to the category of modules over the triangular matrix ring $T = \begin{pmatrix} \Lambda/\text{rad}^m\Lambda & \Lambda/\text{rad}^m\Lambda \\ 0 & \Lambda \end{pmatrix}$. With the exact structure inherited from T -mod, the category $\mathcal{S}_m(\Lambda)$ of $\text{rad}^m\Lambda$ -bounded submodules becomes a *full exact subcategory of a module category*; it is *closed under subobjects and extensions*. As all objects in $\mathcal{H}_m(\Lambda)$ have finite length, it follows that with $\mathcal{H}_m(\Lambda)$ also $\mathcal{S}_m(\Lambda)$ is a *Krull-Schmidt category*.

The category $\mathcal{S}_m(\Lambda)$ has Auslander-Reiten sequences: Let $(f: A \rightarrow B)$ be an object in $\mathcal{H}_m(\Lambda)$, and let $e' : \text{Ker } f \rightarrow I$ be an injective envelope and $e : A \rightarrow I$ be an extension of e' to A . Then the two canonical maps

$$(A \xrightarrow{f} B) \longrightarrow (\text{Im } f \subseteq B) \quad \text{and} \quad (A \xrightarrow{\begin{pmatrix} f \\ e \end{pmatrix}} B \oplus I) \longrightarrow (A \xrightarrow{f} B)$$

modulo the kernel of f and modulo I , respectively, are a minimal left approximation and a minimal right approximation of $(f: A \rightarrow B)$ in $\mathcal{S}_m(\Lambda)$. The existence of Auslander-Reiten sequences follows from [2, Theorem 2.4].

We describe the indecomposable projective and the indecomposable injective objects in $\mathcal{S}_m(\Lambda)$.

Proposition 3. *Let P be an indecomposable projective Λ -module and I an indecomposable injective Λ -module.*

1. *The module $(0 \subseteq P)$ is a projective object in $\mathcal{S}_m(\Lambda)$ with sink map the inclusion map $(0 \subseteq \text{rad } P) \rightarrow (0 \subseteq P)$.*
2. *The module $(P/\text{rad}^m P \subseteq P/\text{rad}^m P)$ is a projective object in $\mathcal{S}_m(\Lambda)$; the inclusion map $(\text{rad } P/\text{rad}^m P \subseteq P/\text{rad}^m P) \rightarrow (P/\text{rad}^m P \subseteq P/\text{rad}^m P)$ is a sink map.*
3. *The module $(0 \subseteq I)$ is a (relatively) injective object in $\mathcal{S}_m(\Lambda)$ with source map the inclusion map $(0 \subseteq I) \rightarrow (\text{soc } I \subseteq I)$.*
4. *The module $(\text{soc}^m I \subseteq I)$ is injective in $\mathcal{S}_m(\Lambda)$ and a source map is given by the canonical map $(\text{soc}^m I \subseteq I) \rightarrow (\text{soc}^m I/\text{soc } I \subseteq I/\text{soc } I)$.*
5. *Each projective and each injective indecomposable representation in $\mathcal{S}_m(\Lambda)$ has this form.*

Proof: The modules $(0 \subseteq P)$ and $(P/\text{rad}^m P \subseteq P/\text{rad}^m P)$ are indecomposable projective modules in the category $\mathcal{H}_m(\Lambda)$, and each indecomposable projective module in this category has this form. Also the sink maps are in fact sink maps in the category $\mathcal{H}_m(\Lambda)$.

The module $(0 \subseteq I)$ is (relatively) injective in the category $\mathcal{S}(\Lambda)$, and hence in $\mathcal{S}_m(\Lambda)$, and the source map is as specified.

The module $(\text{soc}^m I \subseteq I)$ is injective in $\mathcal{H}_m(\Lambda)$ and hence in $\mathcal{S}_m(\Lambda)$. The source map in $\mathcal{S}_m(\Lambda)$ is obtained by taking the composition of the source map $(\text{soc}^m I \subseteq I) \rightarrow (\text{soc}^m I \rightarrow I/\text{soc } I)$ in $\mathcal{H}_m(\Lambda)$ with the left approximation $(\text{soc}^m I \rightarrow I/\text{soc } I) \rightarrow (\text{soc}^m I/\text{soc } I \subseteq I/\text{soc } I)$ in $\mathcal{S}_m(\Lambda)$.

It remains to verify the last assertion for injective modules. Let $(A \subseteq B)$ in $\mathcal{S}_m(\Lambda)$ be an indecomposable relatively injective module, and let $u: A \rightarrow I$ and $w: B/A \rightarrow J$ be injective envelopes in the category $\Lambda\text{-mod}$. Since $\text{rad}^m A = 0$, the map $u: A \rightarrow I$ restricts to a map $u': A \rightarrow \text{soc}^m I$. Also, since I is an injective Λ -module, u extends to a map $u'': B \rightarrow I$. This morphism maps A into $\text{soc}^m I$ and hence gives rise to a cokernel map $u''': B/A \rightarrow I/\text{soc}^m I$. Then $v = \begin{pmatrix} u'' \\ \text{can} \circ w \end{pmatrix}: B \rightarrow I \oplus J$ makes the upper part of the following diagram commutative.

$$\begin{array}{ccccccccc}
0 & \longrightarrow & A & \longrightarrow & B & \xrightarrow{\text{can}} & B/A & \longrightarrow & 0 \\
& & u' \downarrow & & \downarrow v & & \downarrow \begin{pmatrix} u''' \\ w \end{pmatrix} & & \\
0 & \longrightarrow & \text{soc}^m I & \xrightarrow{\begin{pmatrix} \iota \\ 0 \end{pmatrix}} & I \oplus J & \xrightarrow{\begin{pmatrix} \text{can} & 0 \\ 0 & 1 \end{pmatrix}} & I/\text{soc}^m I \oplus J & \longrightarrow & 0 \\
& & \downarrow & & \downarrow & & \downarrow & & \\
& & \text{soc}^m I/A & \xrightarrow{f} & (I \oplus J)/\text{Im } v & \longrightarrow & X & \longrightarrow & 0
\end{array}$$

The row at the bottom is the cokernel sequence. Since $\begin{pmatrix} u''' \\ w \end{pmatrix}$ is a monomorphism, so is f , by the snake lemma. Hence the first two columns of the diagram define a short exact sequence in the category $\mathcal{S}_m(\Lambda)$:

$$0 \longrightarrow (A \subseteq B) \longrightarrow (\text{soc}^m I \subseteq I \oplus J) \longrightarrow (\text{soc}^m I/A \subseteq (I \oplus J)/\text{Im } v) \longrightarrow 0$$

By assumption, the object $(A \subseteq B)$ is relatively injective, and hence this sequence is split exact. Thus, $(A \subseteq B)$ is isomorphic to one of the indecomposable summands of the middle term, by the Krull-Remak-Schmidt theorem. This is to say that $(A \subseteq B)$ is isomorphic to one of the indecomposable injective modules in our list. \checkmark

Example 1. In case $\Lambda = k[T]/T^n$, there are the following indecomposable projective and injective modules. The object $Y = (0 \subseteq \Lambda)$ is projective and relatively injective, $P = (\Lambda/\text{rad}^m \Lambda \subseteq \Lambda/\text{rad}^m \Lambda)$ is projective, and $I = (\text{rad}^{n-m} \Lambda \subseteq \Lambda)$ is injective in $\mathcal{S}_m(\Lambda)$. As usual in this manuscript, given an object $(A \subseteq B)$ in $\mathcal{S}_m(k[T]/T^n)$, we picture each generator of the Λ -module B by a column of boxes and the image of each generator of A in B by a dot or a dotted line:

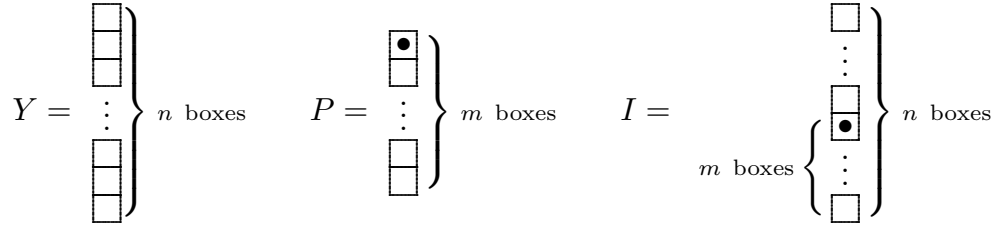

Clearly, the modules P and I are isomorphic in case $m = n$.

An indecomposable object is called *stable* if there is no projective or injective module in its orbit under the Auslander-Reiten translation. The following result provides an overview for our findings in this manuscript.

Theorem 4. *The table below specifies the stable part of the Auslander-Reiten quiver for each of the categories $\mathcal{S}_m(k[T]/T^n)$ which have finite or tame representation type.*

$m = 6$					\mathbb{E}_8		
5				$\mathbb{Z}\mathbb{E}_8/\tau^6$	\mathbb{E}_8		
4			$\mathbb{Z}\mathbb{E}_6/\tau^3\sigma$	$\mathbb{Z}\mathbb{E}_7/\tau^6$	$\mathbb{Z}\tilde{\mathbb{E}}_8 \vee \mathcal{T}_{5,3,2}$		
3		$\mathbb{Z}\mathbb{D}_4/\tau^2\rho$	$\mathbb{Z}\mathbb{D}_4/\tau^3\sigma$	$\mathbb{Z}\mathbb{D}_6/\tau^5$	$\mathbb{Z}\mathbb{E}_8/\tau^{10}$	$\mathbb{Z}\tilde{\mathbb{E}}_8 \vee \mathcal{T}_{5,3,2}$	
2	$\mathbb{Z}\mathbb{A}_2/\tau^{\frac{3}{2}}\sigma$	$\mathbb{Z}\mathbb{A}_1/\tau^2$	$\mathbb{Z}\mathbb{A}_4/\tau^{\frac{5}{2}}\sigma$	$\mathbb{Z}\mathbb{A}_3/\tau^3\sigma$	$\mathbb{Z}\mathbb{A}_6/\tau^{\frac{7}{2}}\sigma$	$\mathbb{Z}\mathbb{A}_5/\tau^4\sigma$	$\mathbb{Z}\mathbb{A}_8/\tau^{\frac{9}{2}}\sigma$
1	\emptyset	\emptyset	\emptyset	\emptyset	\emptyset	\emptyset	\emptyset
	$n = 2$	3	4	5	6	7	8

For D a Dynkin or a Euclidean diagram, τ denotes the translation $\tau : \mathbb{Z}D \rightarrow \mathbb{Z}D, (\ell, d) \mapsto (\ell - 1, d)$; the map σ is an automorphism of order two on $\mathbb{Z}D$ which is induced by an automorphism of order two on the underlying Dynkin diagram $D = \mathbb{A}_n, \mathbb{D}_4, \text{ or } \mathbb{E}_6$; similarly, ρ is the map on $\mathbb{Z}\mathbb{D}_4$ induced from the rotation on \mathbb{D}_4 . By $\mathcal{T}_{a,b,c}$ we denote a family of tubular components of the Auslander-Reiten quiver; the family is indexed by $\mathbb{P}_1(k)$, the set of simple $k[T]$ -modules, up to isomorphism; all tubes have circumference one, with the exception of three tubes of circumference $a, b, \text{ and } c$. The symbol \mathbb{E}_8 indicates a tubular category of type \mathbb{E}_8 .

We use covering theory to obtain information about the indecomposable objects and about the shape of the Auslander-Reiten quiver, in particular for the representation finite and tame categories of type $\mathcal{S}_m(k[T]/T^n)$.

The category $\mathcal{S}_m(k[T]/T^n)$ is just the category of representations of the quiver

$$Q: \begin{array}{c} \alpha \circlearrowright \\ \downarrow \iota \\ \beta \circlearrowright \end{array}$$

which satisfy the relations $\alpha\iota = \iota\beta$, $\alpha^m = 0$, $\beta^n = 0$, and the extra condition that the map ι is a monomorphism. The Galois covering of Q is the quiver \tilde{Q} .

$$\tilde{Q}: \begin{array}{ccccccc} \dots & \xleftarrow{\alpha_0} & 0' & \xleftarrow{\alpha_1} & 1' & \xleftarrow{\alpha_2} & 2' & \xleftarrow{\alpha_3} & \dots \\ & & \downarrow \iota_0 & & \downarrow \iota_1 & & \downarrow \iota_2 & & \\ \dots & \xleftarrow{\beta_0} & 0 & \xleftarrow{\beta_1} & 1 & \xleftarrow{\beta_2} & 2 & \xleftarrow{\beta_3} & \dots \end{array}$$

Let \mathbb{A}_∞ be the double infinite linear quiver, it has vertex set \mathbb{Z} and for each $i \in \mathbb{Z}$, there is an arrow $\alpha_i: (i-1) \leftarrow i$. By (α^n) we denote the ideal generated by all compositions of n arrows. The associative k -algebra $k\mathbb{A}_\infty/\alpha^n$ is locally bounded, more precisely it is serial in the sense that each indecomposable module has a unique composition series, which has length at most n . Then the category $\mathcal{S}_m(k\mathbb{A}_\infty/\alpha^n)$ of α^m -bounded submodules of $k\mathbb{A}_\infty/\alpha^n$ -modules consists of those representations of \tilde{Q} which satisfy the commutativity relations $\alpha_i\iota_{i-1} = \iota_i\beta_i$, the nilpotency relations $\alpha^m = 0$ and $\beta^n = 0$ for all compositions of m and n arrows α_i and β_j , respectively, and the extra condition that all the maps ι_i are monomorphisms.

There are two functors defined on $\mathcal{S}_m(k\mathbb{A}_\infty/\alpha^n)$. The *shift* maps an object $M = ((M'_i)_i \xrightarrow{(\iota_i)_i} (M_i)_i)$ to $M[1] = ((M'_{i-1})_i \xrightarrow{(\iota_{i-1})_i} (M_{i-1})_i)$ and is a selfequivalence on $\mathcal{S}_m(k\mathbb{A}_\infty/\alpha^n)$. The *covering functor* $F: \mathcal{S}_m(k\mathbb{A}_\infty/\alpha^n) \rightarrow \mathcal{S}_m(k[T]/T^n)$ assigns to M the module $F_M = \left(\bigoplus_i M'_i \xrightarrow{\iota} \bigoplus_i M_i \right)$ where ι is the diagonal map given by the ι_i , and the action of T on $\bigoplus_i M'_i$ and on $\bigoplus_i M_i$ is given by the maps for the arrows α_i and β_i , respectively. Obviously, F is invariant under the shift: $F_{M[1]} \cong F_M$.

Example 2. We picture the projective and the injective indecomposable representations in the category $\mathcal{S}_m(k\mathbb{A}_\infty/\alpha^n)$. It follows from Proposition 3 that there are three orbits under the shift of projective or injective indecomposables: The modules $P[i]$, pictured below by their dimension type, are indecomposable projective and not relatively injective, the $I[i]$ are injective, and the $Y[i]$ projective and relatively injective. The index i is chosen such that the leftmost (and in the case of $P[i]$ the rightmost) nonzero entry in the bottom row is at position i in \tilde{Q} .

$$P[i] = \begin{array}{ccccccc} \dots & 0 & 0 & 1 & \dots & 1 & 0 & 0 & \dots \\ \dots & 0 & 0 & 1 & \dots & 1 & 0 & 0 & \dots \end{array} \quad I[i] = \begin{array}{ccccccc} \dots & 0 & 0 & 1 & \dots & 1 & 0 & \dots & 0 & 0 & 0 & \dots \\ \dots & 0 & 0 & 1 & \dots & 1 & 1 & \dots & 1 & 0 & 0 & \dots \end{array} \quad Y[i] = \begin{array}{ccccccc} \dots & 0 & 0 & 0 & 0 & \dots & 0 & 0 & 0 & 0 & \dots \\ \dots & 0 & 0 & 1 & 1 & \dots & 1 & 1 & 0 & 0 & \dots \end{array}$$

$\underbrace{\hspace{10em}}_{m \text{ ones}} \quad \underbrace{\hspace{10em}}_{n \text{ ones}} \quad \underbrace{\hspace{10em}}_{n \text{ ones}}$

Observe that the covering functor preserves projective and injective objects: With the notation from Example 1 we have $F_{P[i]} = P$, $F_{I[i]} = I$ and $F_{Y[i]} = Y$.

Definition. The *support* of $M \in \mathcal{S}_m(k\mathbb{A}_\infty/\alpha^n)$ is the full subcategory $\text{supp } M$ of \tilde{Q} given by all points x with $M_x \neq 0$. We say that $\mathcal{S}_m(k\mathbb{A}_\infty/\alpha^n)$ is *locally support finite* if for all points x the union is a finite set.

$$\bigcup \left\{ \text{supp } M : M \in \text{ind } \mathcal{S}_m(k\mathbb{A}_\infty/\alpha^n) \text{ such that } M_x \neq 0 \right\}$$

We recall the following result from [6, §2]:

Theorem 5.

1. *The covering functor F induces a one-to-one correspondence between the orbits under the shift of the isoclasses of indecomposable objects in $\mathcal{S}_m(k\mathbb{A}_\infty/\alpha^n)$ and the isoclasses of indecomposable objects in $\mathcal{S}_m(k[T]/T^n)$.*
2. *The covering functor preserves Auslander-Reiten sequences and induces a one-to-one map from the factor of the Auslander-Reiten quiver for $\mathcal{S}_m(k\mathbb{A}_\infty/\alpha^n)$ modulo the shift into the Auslander-Reiten quiver for $\mathcal{S}_m(k[T]/T^n)$.*
3. *If the category $\mathcal{S}_m(k\mathbb{A}_\infty/\alpha^n)$ is locally support finite then the one-to-one maps in 1. and 2. are bijective.*
4. *For $M, N \in \mathcal{S}_m(k\mathbb{A}_\infty/\alpha^n)$ the following formula holds.*

$$\text{Hom}_{\mathcal{S}_m(k[T]/T^n)}(FM, FN) = \bigoplus_{i \in \mathbb{Z}} \text{Hom}_{\mathcal{S}_m(k\mathbb{A}_\infty/\alpha^n)}(M[i], N) \quad \checkmark$$

Notation. Given $m < n$, let $\mathcal{S}_m(n)$ be an abbreviation for $\mathcal{S}_m(k\mathbb{A}_\infty/\alpha^n)$. In order to compute the indecomposables in $\mathcal{S}_m(n)$ and to determine the Auslander-Reiten quiver for $\mathcal{S}_m(n)$, we will usually consider some full subquiver Q^+ of \tilde{Q} , for example

$$Q^+ : \begin{array}{ccccccc} \bullet & \leftarrow & \bullet & \leftarrow & \bullet & \leftarrow & \dots \\ \downarrow & \swarrow & \downarrow & \swarrow & \downarrow & \swarrow & \dots \\ \bullet & \leftarrow & \bullet & \leftarrow & \bullet & \leftarrow & \dots \\ 0 & & 1 & & 2 & & \dots \end{array}$$

and form the factor algebra B^+ of the path algebra kQ^+ modulo the ideal given by the commutativity relations $\alpha_i \iota_{i-1} = \iota_i \beta_i$ and the nilpotency relations $\alpha^n = 0$ and $\beta^m = 0$. By S_i, P_i, I_i and S'_i, P'_i, I'_i we denote the simple, projective, and injective indecomposable B^+ -modules corresponding to the points i and i' , respectively. Depending on the index i , the objects in kQ -mod given by P'_i and $P[i]$ may or may not coincide, and similarly for P_i and $Y[i]$ and for I_i and $I[i]$. In order to detect which B^+ -modules correspond to objects in $\mathcal{S}_m(n)$, the following easy result will be useful.

Lemma 6. *The following assertions are equivalent for $M \in \text{mod } B^+$.*

1. $M \in \mathcal{S}_m(n)$
2. All maps $M(\iota_i)$ are monomorphisms.

3. $\text{Hom}_{B^+}(S'_i, M) = 0$ for all $i \in \mathbb{Z}$. ✓

We can now consider the various choices for m and n .

THE CASE $m = 1$.

For each of the categories $\mathcal{S}_1(n)$ and $\mathcal{S}_1(k[T]/T^n)$ we determine the indecomposable representations and obtain the Auslander-Reiten quiver.

Let M be an indecomposable object in $\mathcal{S}_1(n)$. We may assume that the vector spaces M_i are all zero for $i < 0$ and that $M_0 \neq 0$; otherwise replace M by a translate under the shift. Thus, M is a representation of the following subquiver of Q such that $M_0 \neq 0$.

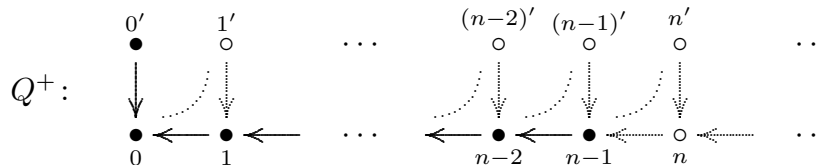

In $\mathcal{S}_1(n)$ the arrows in the upper row in \tilde{Q} represent the zero map, so the commutativity relations degenerate to zero relations as indicated. Moreover, any composition of n horizontal arrows is zero. Let B^+ be the factor algebra of kQ^+ modulo these relations. We are going to show that M has support in the solid part of Q^+ , which forms a diagram of Dynkin type \mathbb{A}_n . Consider the left hand part of the Auslander-Reiten quiver for B^+ . As usual in this manuscript, we display dimension vectors in such a way that the two leftmost entries represent the positions 0 and $0'$.

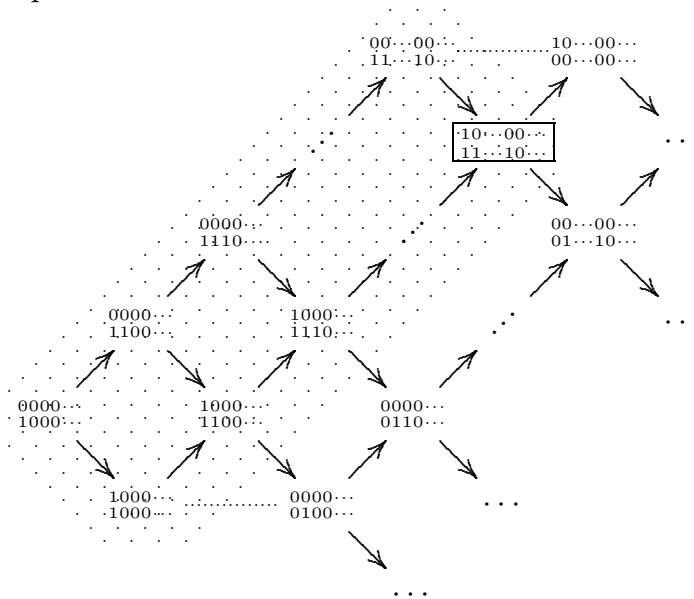

The module in the box is $I[0]$. Since $M_0 \neq 0$, there is a nonzero morphism $M \rightarrow I[0]$, and hence M is one of the $2n$ indecomposable and pairwise nonisomorphic modules in the picture which have a path to $I[0]$. Note that the module S'_0 occurs as an irreducible successor of $I[0]$, so no module of type S'_i has a nonzero map to M and hence each of the $2n$ modules is in $\mathcal{S}_1(n)$, by Lemma 6. The $2n$ predecessors of $I[0]$ form the fundamental

domain \mathcal{D} for the shift in $\mathcal{S}_1(n)$, as indicated by the shaded region: Each indecomposable object M in $\mathcal{S}_1(n)$ occurs in exactly one of the sets $\mathcal{D}[i]$. Here the index is given by $i = \min\{j : M_j \neq 0\}$.

In order to determine the Auslander-Reiten structure for $\mathcal{S}_1(n)$, we compute the source map for each object M in \mathcal{D} . We have already seen that the source map for $I[0] = (\text{soc } I_0 \subseteq I_0)$ is the map $(\text{soc } I_0 \subseteq I_0) \rightarrow (0 \subseteq I_0/\text{soc } I_0)$. We claim that otherwise, the source map $M \rightarrow N$ in B^+ -mod is also the source map in the category $\mathcal{S}_1(n)$: Clearly, N is an object in $\mathcal{S}_1(n)$, and the factorization property for a source map holds: Take an indecomposable module T which occurs in $\mathcal{D}[i]$, say, and a nonisomorphism $t: M \rightarrow T$. If $i \geq 0$ then $\text{Hom}_{\mathcal{S}}(M, T) = \text{Hom}_{B^+}(M, T)$ and t factors through N ; if $i < 0$ then there is no nonzero map in $\text{Hom}_{\mathcal{S}}(M, T)$ since $\text{Hom}_{B^+}(M[-i], T[-i]) = 0$. Thus, in any case, t factors through N .

The modules on the upper diagonal in \mathcal{D} coincide with those in the diagonal underneath \mathcal{D} , up to the shift and with the exception of the last one, $Y[0]$. However, the module $\text{rad } Y[1]$ does occur in the diagonal underneath \mathcal{D} and we can restore the missing irreducible morphism as $\text{rad } Y[1] \rightarrow Y[1]$, obtaining the upper diagonal in the domain $\mathcal{D}[1]$. Attaching all the fundamental domains $\mathcal{D}[i]$ to each other we obtain the Auslander-Reiten quiver for $\mathcal{S}_1(n)$; it is repetitive, up to the shift, as expected. For example, if $n = 3$ we obtain:

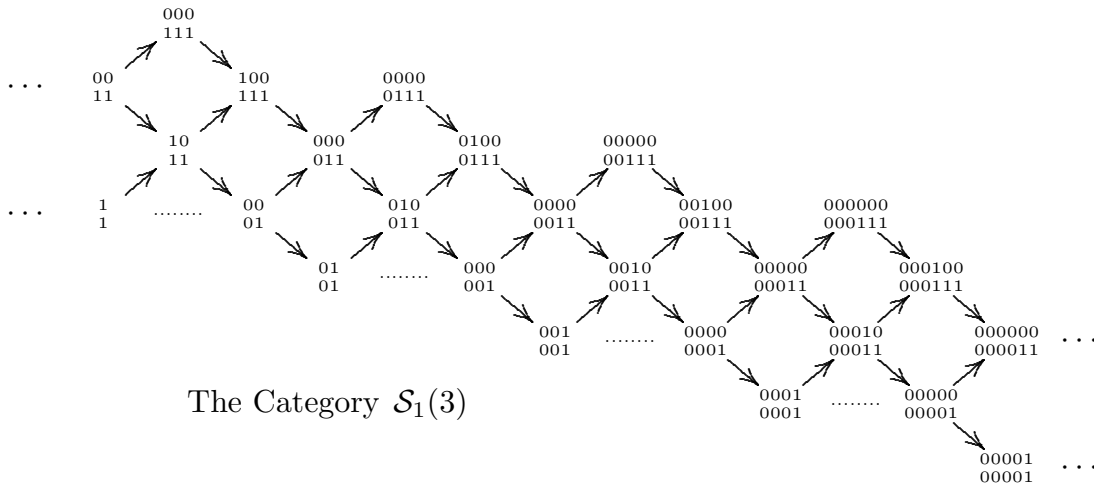

We will usually picture only one copy of the fundamental domain:

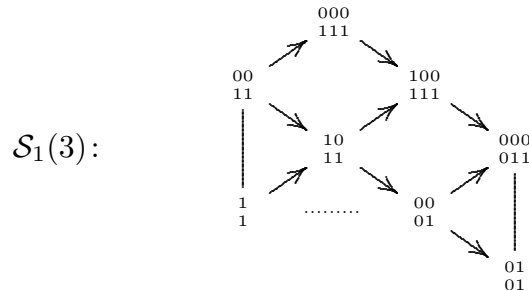

For the corresponding categories of type $\mathcal{S}_1(k[T]/T^n)$ we use covering theory to obtain:

Proposition 7. *Let $m = 1$. The category $\mathcal{S}_m(k[T]/T^n)$ has $2n$ indecomposables; they are of the form $(0 \subseteq k[T]/T^i)$ or $(T^{i-1}k[T]/T^i \subseteq k[T]/T^i)$ for some $1 \leq i \leq n$. The Auslander-Reiten quiver for $\mathcal{S}_m(k[T]/T^n)$ has the shape of a bounded tube with one coray and two rays, or conversely. The Auslander-Reiten translation shifts objects along a helix; the two orbits are finite and nonperiodic of length 1 and $2n - 1$. The examples below are obtained from the Auslander-Reiten quivers for $\mathcal{S}_1(n)$ by identifying the objects modulo the shift. ✓*

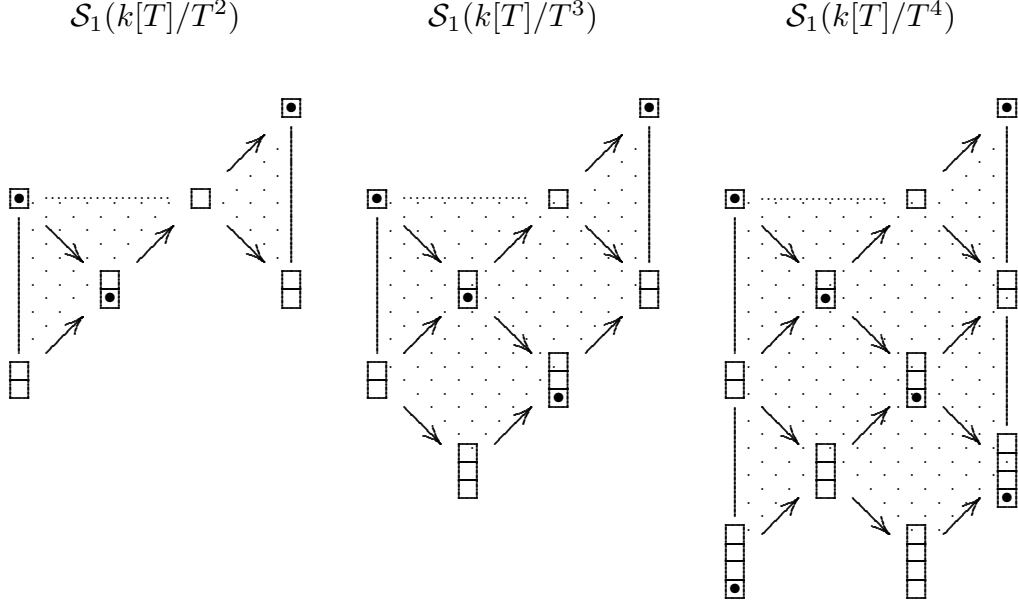

THE CASE $m = 2$.

We determine the indecomposables in the categories $\mathcal{S}_2(n)$ and $\mathcal{S}_2(k[T]/T^n)$. There is a subtle difference in the orbit structure of the Auslander-Reiten quivers, depending on whether n is even or odd.

Consider the following quiver

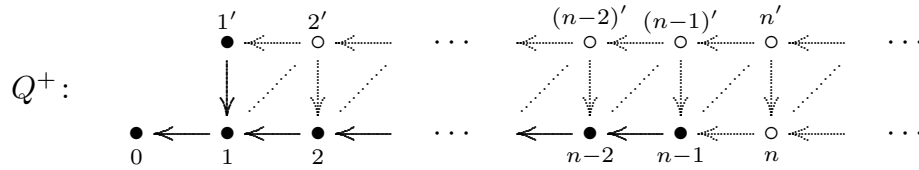

and the corresponding algebra B^+ given by the usual commutativity and nilpotence relations. We will see that with one exception, the indecomposables in $\mathcal{S}_2(n)$, up to the shift, correspond to the representations of Q^+ which have support in the Dynkin diagram \mathbb{D}_{n+1} indicated by the solid dots and lines. The correspondence is given by mapping the B^+ -module M to the representation M^* of \tilde{Q} , as follows.

$$\begin{array}{ccc}
 M: & M'_1 \xleftarrow{a_2} M'_2 \xleftarrow{\quad} \cdots & M^*: & M_0 \xleftarrow{j_1 b_1} M'_1 \xleftarrow{a_2} M'_2 \xleftarrow{\quad} \cdots \\
 & \downarrow j_1 \quad \downarrow j_2 & & \downarrow 1 \quad \downarrow j_1 \quad \downarrow j_2 \\
 & M_0 \xleftarrow{b_1} M_1 \xleftarrow{b_2} M_2 \xleftarrow{\quad} \cdots & & M_0 \xleftarrow{b_1} M_1 \xleftarrow{b_2} M_2 \xleftarrow{\quad} \cdots
 \end{array}$$

The following Lemma is easy to verify.

Lemma 8. *The following statements are equivalent for a module $M \in \mathcal{S}_2(n)$ which is such that $M_i = 0$ for $i < 0$.*

1. *The map j_0 is an isomorphism.*
2. *$M \cong N^*$ for some B^+ -module N .*
3. *There is no nonzero map $M \rightarrow Y[0]$.* ✓

The left hand part of the Auslander-Reiten quiver for B^+ has the following form; an object M is represented by the dimension vector of the corresponding object M^* in $\mathcal{S}_2(n)$.

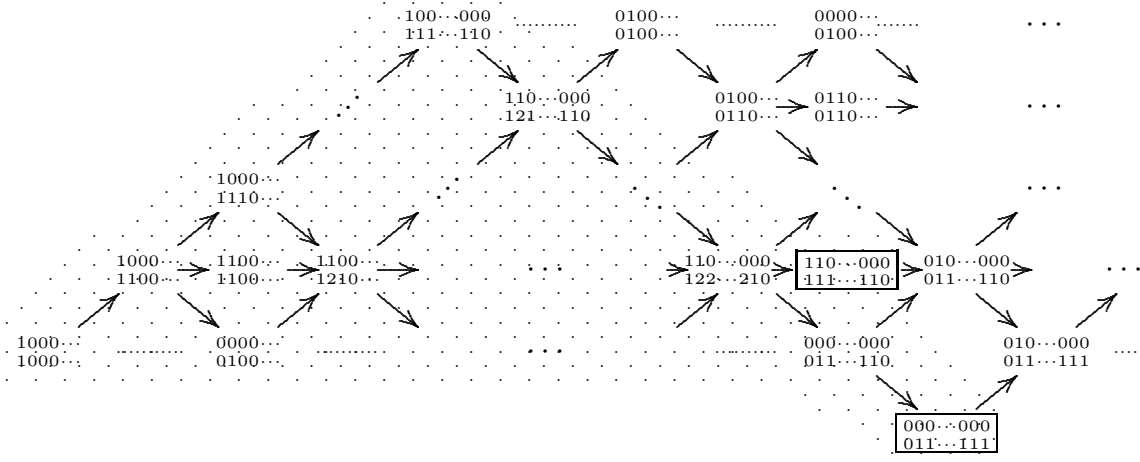

The boxed modules are $I[0]$ and $Y[1]$ and the shaded area will be the fundamental domain \mathcal{D} . Note that in case that n is odd, the positions of the predecessor of $Y[1]$ and of $I[0]$ have to be exchanged. This is due to the operation of Gabriel's Frobenius permutation: If $n + 1$ is even, then the projective modules P_i corresponding to the point i in the Dynkin diagram \mathbb{D}_{n+1} occur in the same τ -orbits as the injective module I_i for this point; if $n + 1$ is odd, the modules P'_1 and $I_0 = I[0]$ are in the same orbit, and so are P_0 and I'_1 (which is at the position of the successor of $Y[1]$ in the Auslander-Reiten quiver of the Dynkin diagram).

Next, we determine the indecomposable representations of $\mathcal{S}_m(n)$, up to the shift. Let M be an indecomposable representation such that $M_i = 0 = M_{i'}$ for all $i < 0$, and such that $M_0 \neq 0$. If j_0 is an isomorphism, then M is a B^+ -module and has a non-zero map to the injective representation $I[0]$. If j_0 is not an isomorphism, then $M[1]$ is a B^+ -module, and the factor $N := (M/\text{Im}(j_i)_i)[1]$ has a non-zero map to $Y[1]$. Thus, the set \mathcal{D} of predecessors of either $I[0]$ or $Y[1]$ as indicated by the shaded region in the above diagram, contains a full set of representatives for the indecomposable representations of $\mathcal{S}_m(n)$, up to the shift. Conversely, \mathcal{D} consists only of objects in $\mathcal{S}_2(n)$ since no module of dimension type $\begin{matrix} \dots & 010 & \dots \\ \dots & 000 & \dots \end{matrix}$ has a nonzero map into one of the indecomposables in \mathcal{D} . In conclusion, \mathcal{D} consists of those indecomposables M in $\mathcal{S}_2(n)$ which satisfy the following three conditions. (1) $M_i = 0$ for $i < 0$, (2) $M(\iota_0)$ is an isomorphism, (3) if $M_0 = 0$ then $M(\iota_1)$ is not an isomorphism. It follows that \mathcal{D} is a fundamental domain for the shift and we read off that \mathcal{D} contains $1 + 2 + \dots + (n - 1) + n + (n - 2) + 2 = n(n + 1)/2 + n = \frac{n}{2}(n + 3)$ indecomposable objects.

Note that the modules in the antidiagonal on the right hand side of \mathcal{D} are exactly the shifted copies of the modules on the diagonal on the left hand side within \mathcal{D} . Thus, in order to obtain the Auslander-Reiten quiver for $\mathcal{S}_2(n)$, one verifies as in the case where $m = 1$ that each of the source maps of a module in \mathcal{D} in the category B^+ -mod is also a source map in the category $\mathcal{S}_2(n)$.

The Auslander-Reiten quiver for $\mathcal{S}_2(n)$ is obtained by “attaching” the shifted copies $\mathcal{D}[i]$ of the fundamental domain to each other, as above in the case $m = 1$. In the two examples below, the dashed line separates the modules in \mathcal{D} from those in $\mathcal{D}[1]$.

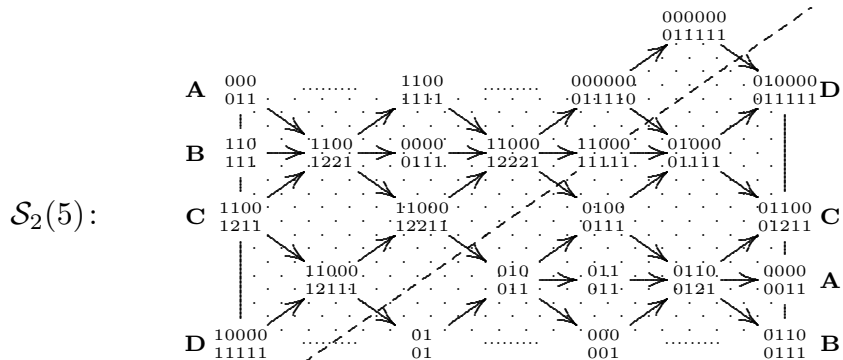
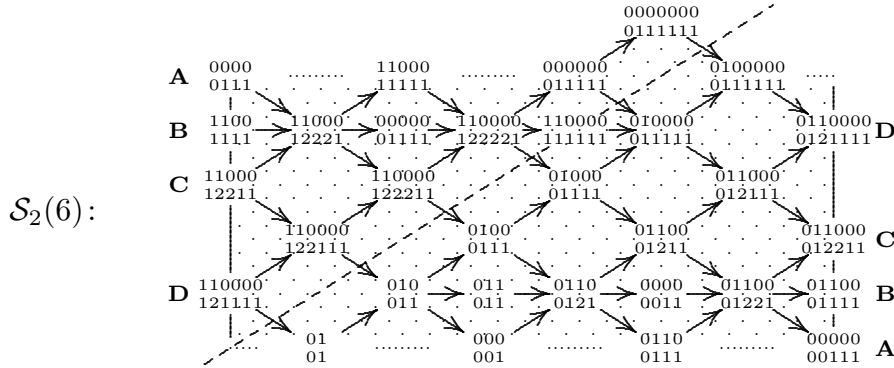

In order to obtain the Auslander-Reiten quiver for $\mathcal{S}_2(k[T]/T^n)$, identify the modules on the left edge with their shifted copies on the right. The type of this identification depends on whether n is even or odd, and is indicated by the letters A–D. We conclude:

Proposition 9. *For $m = 2$ and $n > 2$, the category $\mathcal{S}_m(k[T]/T^n)$ has $\frac{n}{2}(n + 3)$ indecomposable representations, namely the following:*

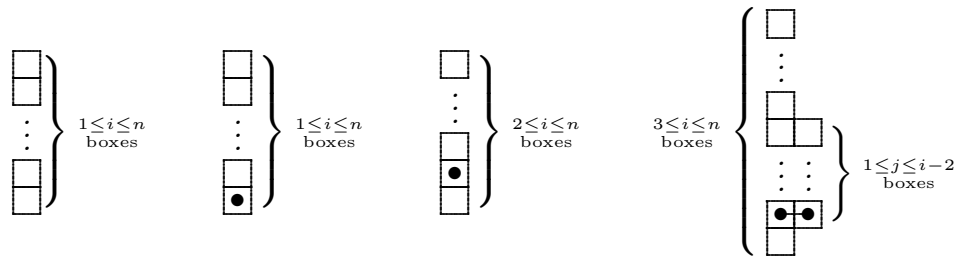

In case n is even, there are stable modules on the boundary of the Auslander-Reiten quiver. The stable part of this quiver has type $\mathbb{Z}\mathbb{A}_n/\tau^{(n+1)/2}\sigma$, where σ is the quiver automorphism

of the Dynkin diagram \mathbb{A}_n of order two, and hence for each stable representation M , the formula $M \cong \tau^{n+1}(M)$ holds. There are two orbits attached to the stable part, one contains $n - 1$ modules between P and I ; the other one consists only of the projective injective representation Y .

In case n is odd, there are no stable modules on the boundary of the Auslander-Reiten quiver. The stable part has type $\mathbb{Z}\mathbb{A}_{n-2}/\tau^{(n+1)/2}\sigma$; each module M on the central axis satisfies $M \cong \tau^{\frac{n+1}{2}}(M)$, each stable module satisfies $M \cong \tau^{n+1}(M)$. There is a non-stable τ -orbit of length $2n$ containing the projective representation P and the injective representation I ; attached to this orbit is the projective injective module Y . \checkmark

Here are two examples for illustration.

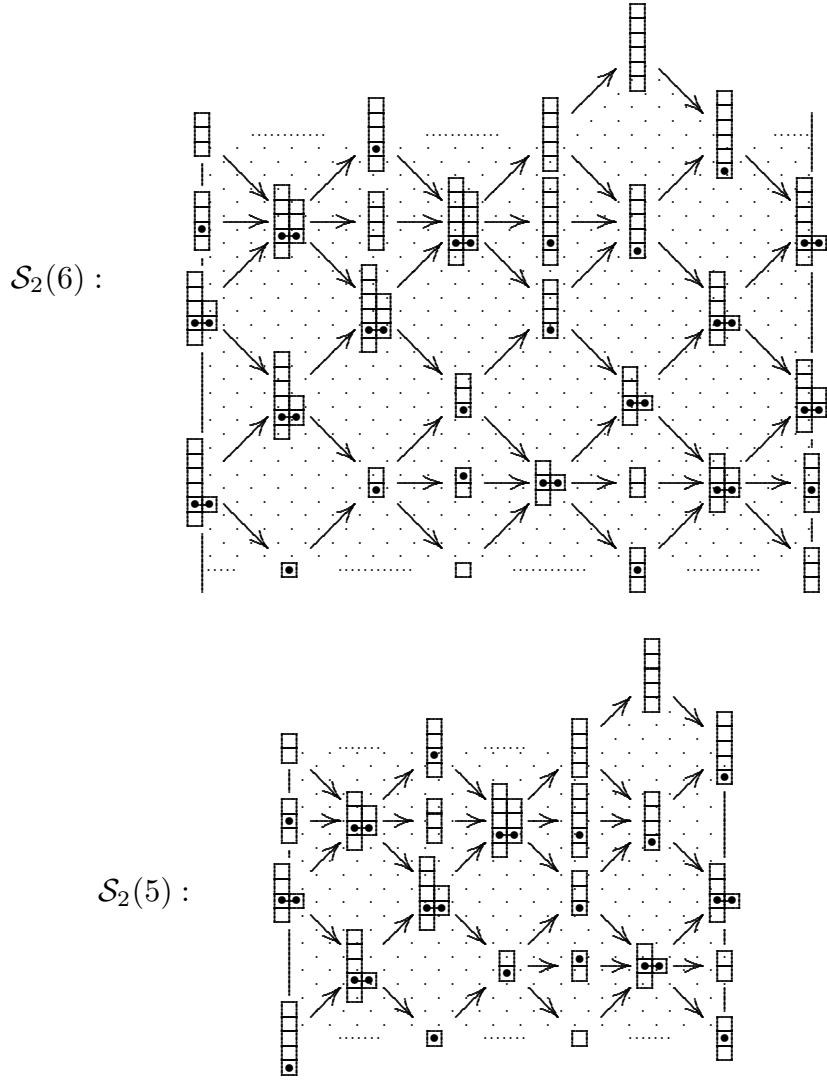

THE CASE $m = n - 1$

There are seven more pairs $m < n$ left for which the category $\mathcal{S}_m(k[T]/T^n)$ has finite or tame type. In this section we are dealing with the three cases where $m = n - 1$. We

have observed above that in the category $\mathcal{S}(k[T]/T^n)$ the modules P and I are isomorphic objects. This projective injective module is the only indecomposable object which is not in the category $\mathcal{S}_{n-1}(k[T]/T^n)$.

Lemma 10. *Let $m = n - 1$. The category $\mathcal{S}_m(n)$ is the full subcategory of $\mathcal{S}(n)$ consisting of all indecomposables in $\mathcal{S}(n)$ with the exception of the projective injective modules $I[i]$, $i \in \mathbb{Z}$. The Auslander-Reiten quiver for $\mathcal{S}_m(n)$ is obtained as the full subquiver of the Auslander-Reiten quiver for $\mathcal{S}(n)$ given by deleting the points corresponding to the $I[i]$.*

Proof: Any representation $M \in \mathcal{S}(n)$ for which the subspace is not annihilated by α^{n-1} admits an embedding of the projective-injective representation $I[i]$ in $\mathcal{S}(n)$, for some i ; this embedding is split exact. For the proof of the second assertion, consider an Auslander-Reiten sequence in $\mathcal{S}(n)$ which contains one of the modules $I[i]_{\mathcal{S}(n)}$ as a summand of the middle term. Here we write $I[i]_{\mathcal{S}(n)} = (I_i \subseteq I_i)$ for I_i the injective $k\mathbb{A}_\infty^\infty/\alpha^n$ -module corresponding to the point i .

$$0 \longrightarrow (\text{rad } I_i \subseteq I_i) \xrightarrow{\begin{pmatrix} a_i \\ c_i \end{pmatrix}} \begin{matrix} (I_i \subseteq I_i) \\ \oplus \\ (\text{rad } I_i / \text{soc } I_i \subseteq I_i / \text{soc } I_i) \end{matrix} \xrightarrow{\begin{pmatrix} b_i & d_i \end{pmatrix}} (I_i / \text{soc } I_i \subseteq I_i / \text{soc } I_i) \longrightarrow 0$$

Note that the module $(\text{rad } I_i \subseteq I_i)$ is just the object $I[i]$ in the category $\mathcal{S}_m(n)$ and the map c_i is its source map. Similarly, $(I_i / \text{soc } I_i \subseteq I_i / \text{soc } I_i)$ is the object $P[i + 1]$ in $\mathcal{S}_m(n)$ and d_i is its sink map. In conclusion, the Auslander-Reiten quiver for $\mathcal{S}_m(n)$ is obtained from the Auslander-Reiten quiver for $\mathcal{S}(n)$ by deleting the points corresponding to the projective injective modules and the arrows representing the above maps a_i and b_i . \checkmark

Example. Assume $m = 3$ and $n = 4$. The Auslander-Reiten quiver for $\mathcal{S}_3(4)$ is obtained from the Auslander-Reiten quiver for $\mathcal{S}(4)$ by deleting the points corresponding to the projective and injective modules. (We are not deleting the modules of type $Y[i]$ at the bottom which are projective and relatively injective.)

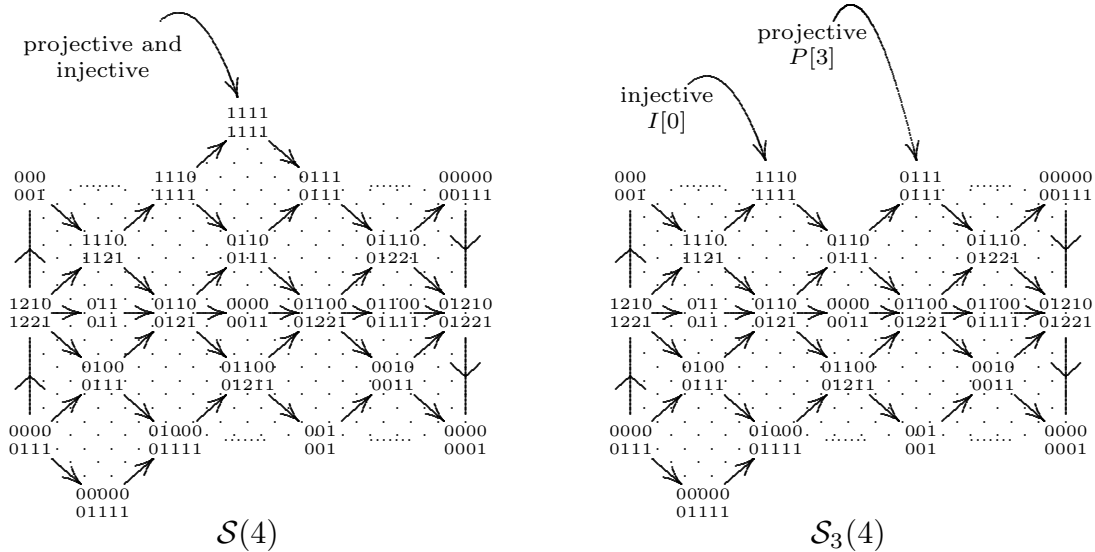

Using covering theory, one obtains the analog of Lemma 10 for categories of type $\mathcal{S}_{n-1}(k[T]/T^n)$.

Example. The Auslander-Reiten quiver for $\mathcal{S}_3(k[T]/T^4)$ is obtained by identifying the left border with the right along the arrows in the above diagram. By deleting the projective injective module in $\mathcal{S}(k[T]/T^4)$, the stable type of the category is reduced from $\mathbb{Z}\mathbb{E}_6/\sigma\tau^3$ to $\mathbb{Z}\mathbb{D}_4/\sigma'\tau^3$ where σ and σ' are automorphisms of order two for the Dynkin diagrams \mathbb{E}_6 and \mathbb{D}_4 , respectively. Thus, in the Auslander-Reiten quiver for $\mathcal{S}_3(k[T]/T^4)$, there is a stable orbit of period three in the middle with a stable orbit of period six above and below it. On the outside of this second orbit is a nonstable orbit, also of length six, which has the projective injective module Y attached to it. This part of the quiver can be realized as a Moebius band in three dimensions. However, there is a second stable orbit of period three, also attached to the orbit in the middle. This “balcony” cannot be realized in three dimensions.

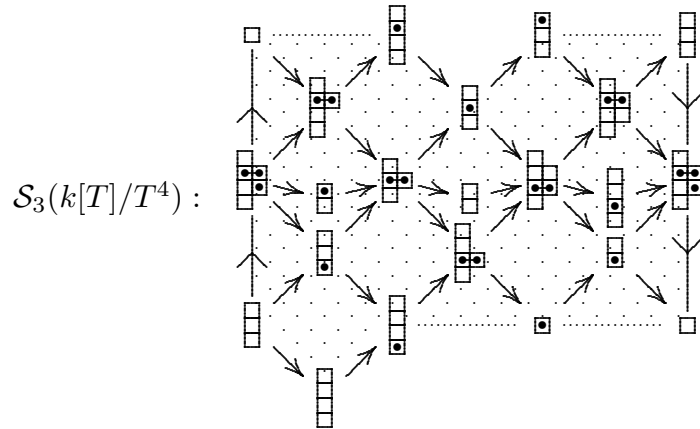

THE CASE $m = 3, n = 5$.

In this example, we obtain the Auslander-Reiten quiver for $\mathcal{S}_3(5)$ from the Auslander-Reiten quiver of the path algebra of the following quiver with commutativity and nilpotence relations as indicated. We omit the details as the process appears similar to the cases where $m = 2$, and even easier than the case $m = 3$ and $n = 7$ below.

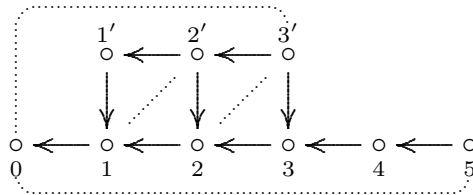

Proposition 11. *The category $\mathcal{S}_3(k[T]/T^5)$ has 37 indecomposable objects, up to isomorphism. The Auslander-Reiten quiver has five stable orbits, four of length 5 and one of length 10; the stable type is $\mathbb{Z}\mathbb{D}_6/\tau^5\sigma$ where σ permutes the two short branches of the Dynkin diagram \mathbb{D}_6 and hence creates the long orbit in the Auslander-Reiten quiver. Attached to this long orbit is a nonstable orbit from P to I of length 6; the projective injective module Y is attached to the short orbit corresponding to the endpoint of the long branch of the diagram \mathbb{D}_6 .*

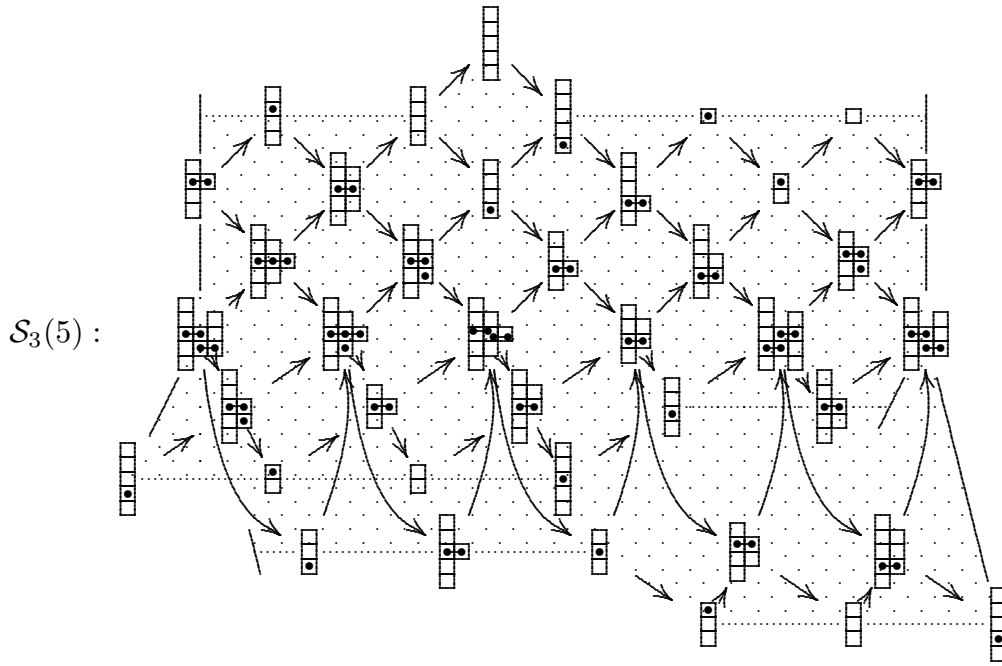

CASE $m = 3, n = 6$.

One obtains the indecomposables in, and the Auslander-Reiten quiver for the category $\mathcal{S}_3(6)$ from the Auslander-Reiten quiver for the path algebra of the following quiver, with the relations as indicated. Again, we omit the proof.

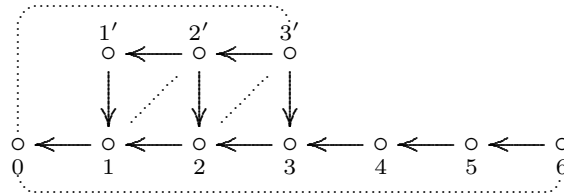

Proposition 12. *The category $\mathcal{S}_3(k[T]/T^6)$ has 84 indecomposable objects and hence is the largest among the categories of type $\mathcal{S}_m(k[T]/T^n)$ which are representation finite. The stable part of the Auslander-Reiten quiver has type $\mathbb{Z}\mathbb{E}_8/\tau^{10}$. There is a nonstable orbit of length 3 from P to I attached to the orbit for the endpoint of the branch in the Dynkin diagram \mathbb{E}_8 of length 2; and the module Y is attached to the orbit for the endpoint of the branch of length 4.*

Two indecomposable objects appear to be of particular interest as they are the only ones (in any of the representation finite categories of type $\mathcal{S}_m(k[T]/T^n)$) for which the submodule is a free module of rank 2. Let X_1 be the module on the intersection of the ray starting at P and the coray ending at I , and put $X_2 = \tau^5 X_1 = \tau^{-5} X_1$. The two modules are pictured as follows.



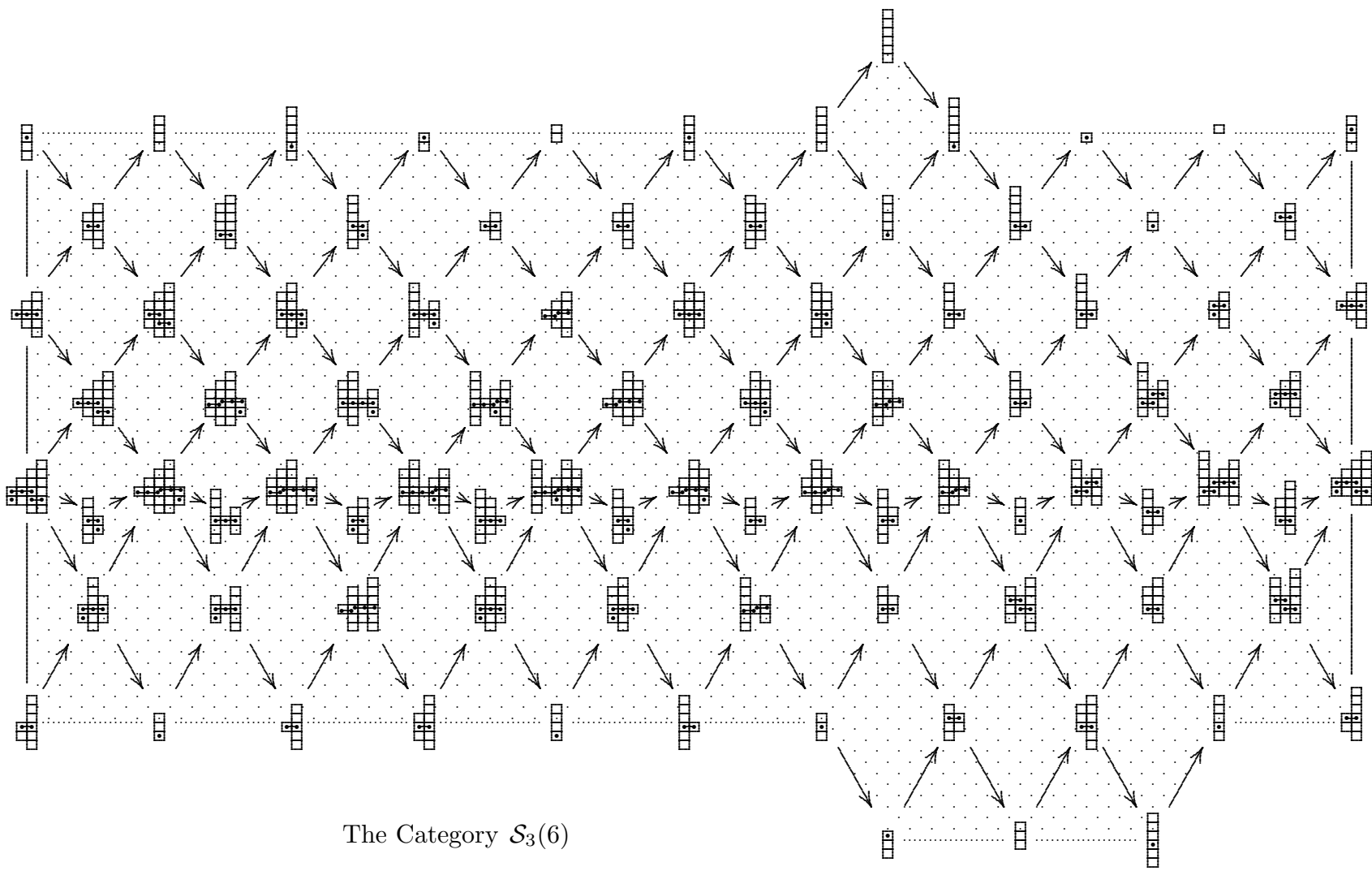

The Category $\mathcal{S}_3(6)$

Both X_1 and X_2 have as submodule two copies of $k[T]/T^3$. In X_1 the copies are shifted against each other, in X_2 they are not. In fact, $\mathcal{S}_3(k[T]/T^6)$ is the only representation finite category in which the indecomposable summands of the submodule are not all pairwise nonisomorphic. Besides X_1 and X_2 , there are six more such indecomposables in $\mathcal{S}_3(k[T]/T^6)$ where the subgroup is isomorphic to $2 \cdot k[T]/T^3 \oplus k[T]/T$; note that this is the subgroup of the modules in the radical family in $\mathcal{S}_3(k[T]/T^7)$. Concerning the total spaces, there are three indecomposable modules for which the total space has isomorphic indecomposable summands, and which live in a representation finite category of type $\mathcal{S}_m(k[T]/T^n)$. Two of them, Z_1 and Z_2 , have two isomorphic summands of type $k[T]/T^3$ and $k[T]/T^6$, respectively, which are not shifted against each other. Both occur on the central orbit in $\mathcal{S}_3(k[T]/T^6)$. The third one, Z_3 from $\mathcal{S}_4(k[T]/T^5)$, has two summands of type $k[T]/T^5$ that are shifted against each other.

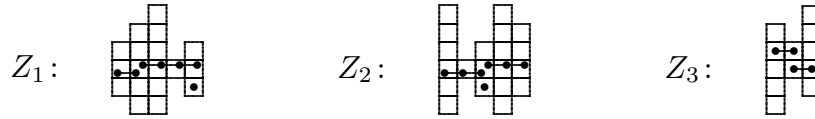

THE CASE $m = 3, n = 7$.

The category $\mathcal{S}_3(k[T]/T^7)$ is the first of two categories of tame infinite representation type considered in detail in this manuscript. The indecomposable objects occur either in a stable family of tubes of tubular type $(5, 3, 2)$ or in a connecting component. We use the indecomposables of dimension type given by the radical vector of the tubular family to obtain a second minimal family of subgroup embeddings, as indicated in the introduction.

First consider the covering category $\mathcal{S}_3(7)$. Let B_0 be the algebra given by the following quiver and the commutativity relation as indicated.

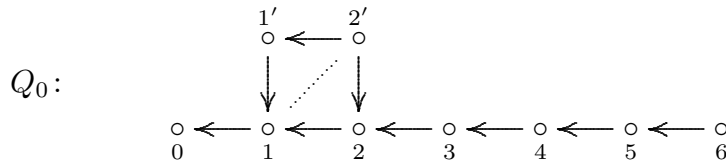

This algebra is tame concealed of type $\tilde{\mathbb{E}}_8$, according to the list of Happel and Vossiek [5, A.2], and hence the Auslander-Reiten quiver consists of a preprojective component \mathcal{P} , a family \mathcal{T}_0 of tubes, and a preinjective component \mathcal{I}_0 . With three exceptions, the tubes are homogeneous and contain representations of dimension type a multiple of $\begin{smallmatrix} 2320000 \\ 2454321 \end{smallmatrix}$. For later use we picture the mouth for each of the remaining three big tubes of circumference 2, 3 and 5.

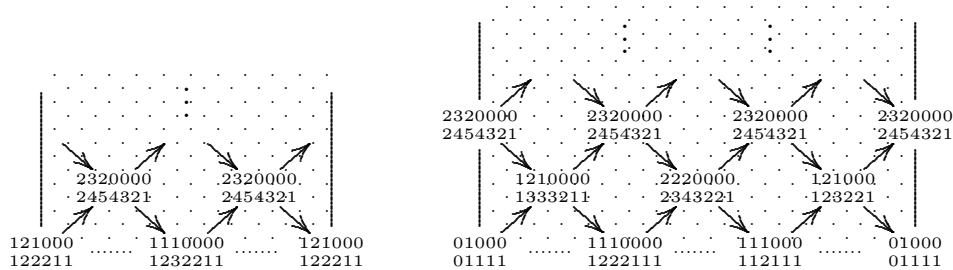

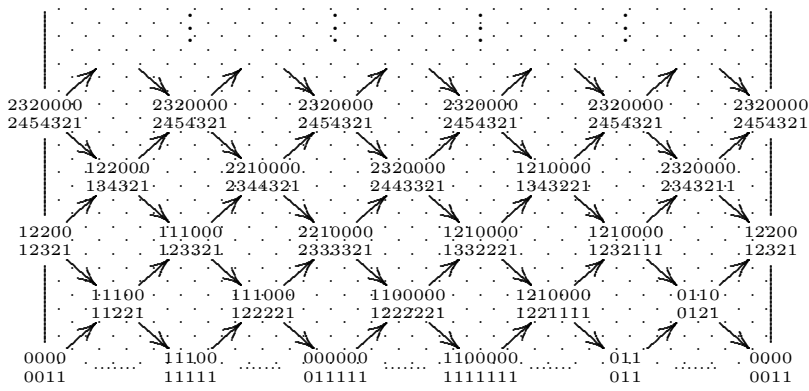

It turns out that the preinjective component \mathcal{I}_0 contains the radicals of the modules $P[3]$ and $Y[1]$. Consider the corresponding iterated one point extension algebra B_1 given by the following quiver Q_1 and the indicated relations.

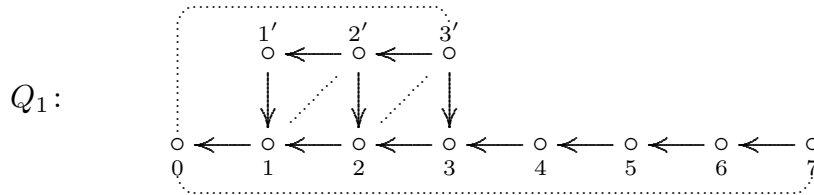

We picture a part of the component \mathcal{I}_1 obtained from \mathcal{I}_0 by inserting the two rays for $P[3]$ and $Y[1]$. From this component we are going to obtain the connecting component \mathcal{U} for $\mathcal{S}_3(7)$.

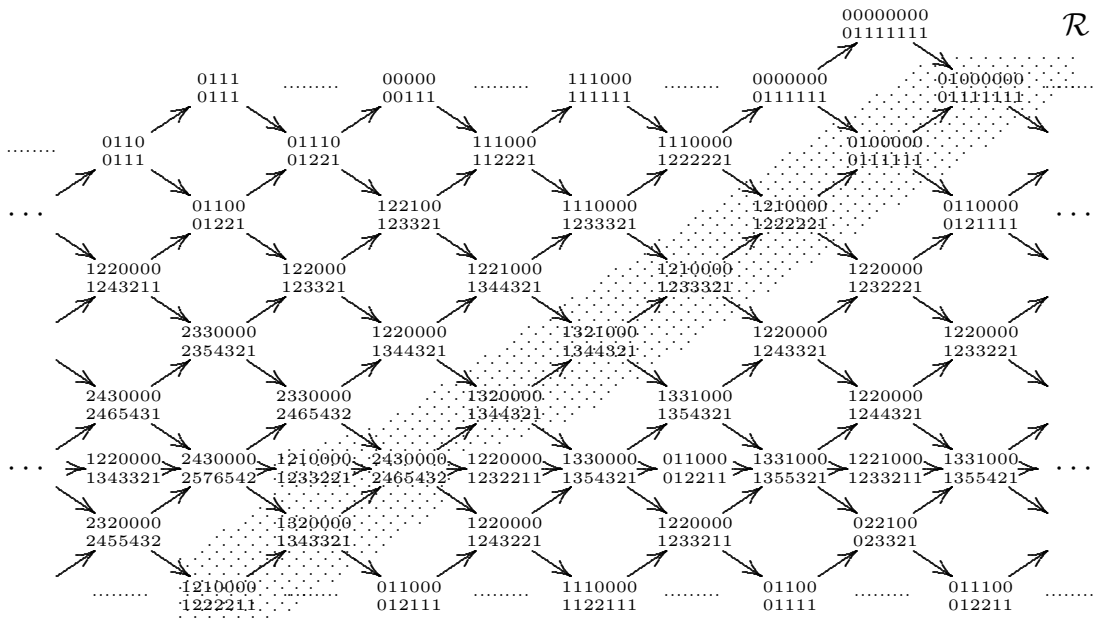

The diagram actually pictures part of the connecting component \mathcal{U} as we have already deleted the module S'_2 which occurs as $\tau^{-1}Y[1]$ (in \mathcal{I}_1) in the upper right corner. Due to the presence of S'_2 , not all modules in \mathcal{I}_1 are in $\mathcal{S}_3(7)$, but certainly those in the shaded region \mathcal{R} (which forms a slice) and those on the left of \mathcal{R} are. Each module M in $\mathcal{S}_3(7)$

which lies in \mathcal{R} or which admits a path from \mathcal{R} has no nonzero morphism into the module $Y[1]$ and hence is a module over the algebra B_2 given by the quiver Q_2 and the relations as indicated. Namely, if $\text{Hom}(M, Y[1]) = 0$, then also $\text{Hom}((0 \subseteq (M_i/\text{Im } M(\iota_i))), Y[1]) = 0$ and hence $M(\iota_1)$ is an isomorphism and M a B_2 -module, as seen in Lemma 8.

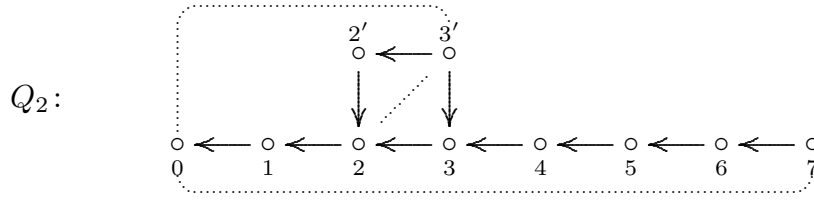

Note that by deleting the point 0 in Q_2 we get back the quiver Q_0 , up to a shift. Let \bar{I}_0 be the socle factor of the B_2 -module I_0 . Then $\bar{I}_0[-1]$ occurs in the preprojective component \mathcal{P} for B_0 . The component $\mathcal{P}[1]$ with the corresponding coextension becomes the preprojective component \mathcal{P}_2 for B_2 . Thus, the Auslander-Reiten quiver for B_2 consists of this preprojective component \mathcal{P}_2 , the tubular family $\mathcal{T} = \mathcal{T}_0[1]$, and the preinjective component $\mathcal{I}_0[1]$. Since the modules S'_2 and S'_3 occur in $\mathcal{I}_0[1]$, all modules in \mathcal{P}_2 and in \mathcal{T} are objects in $\mathcal{S}_3(7)$. The shaded region \mathcal{R} above occurs as a slice in \mathcal{P}_2 . Let \mathcal{U} consist of the left hand part of \mathcal{I}_0 and the right hand part of \mathcal{P}_2 , with the two copies of \mathcal{R} identified. We observe that the injective module $I[1]$ occurs as $\tau^{-5}Z$ where Z is the irreducible successor of $Y[1]$. Hence \mathcal{U} has stable type $\mathbb{Z}\tilde{\mathbb{E}}_8$ and there are two nonstable τ -orbits of length ten and one attached, as sketched above.

We claim that $\mathcal{D} = \mathcal{U} \vee \mathcal{T}$ forms a fundamental domain for $\mathcal{S}_3(7)$, modulo the shift $M \mapsto M[1]$. Clearly, \mathcal{D} consists of pairwise nonisomorphic modules since they are pairwise nonisomorphic as B_1 -modules. As $\mathcal{D}' = \mathcal{P} \vee \mathcal{T}_0 \vee \mathcal{U}$ contains the injective $I[0]$ and the relatively injective $Y[1]$ but no unextended radicals of projective $\mathcal{S}_3(7)$ representations, it follows that every indecomposable in $\mathcal{S}_3(7)$ has a translate in \mathcal{D}' . Moreover, each module in \mathcal{P} occurs in some category $\mathcal{T}[i]$ or $\mathcal{U}[i]$, as indicated below. For example, the three wings in $\mathcal{P} \cap \mathcal{T}[-1]$ occur in the three big tubes in $\mathcal{T}[-1]$.

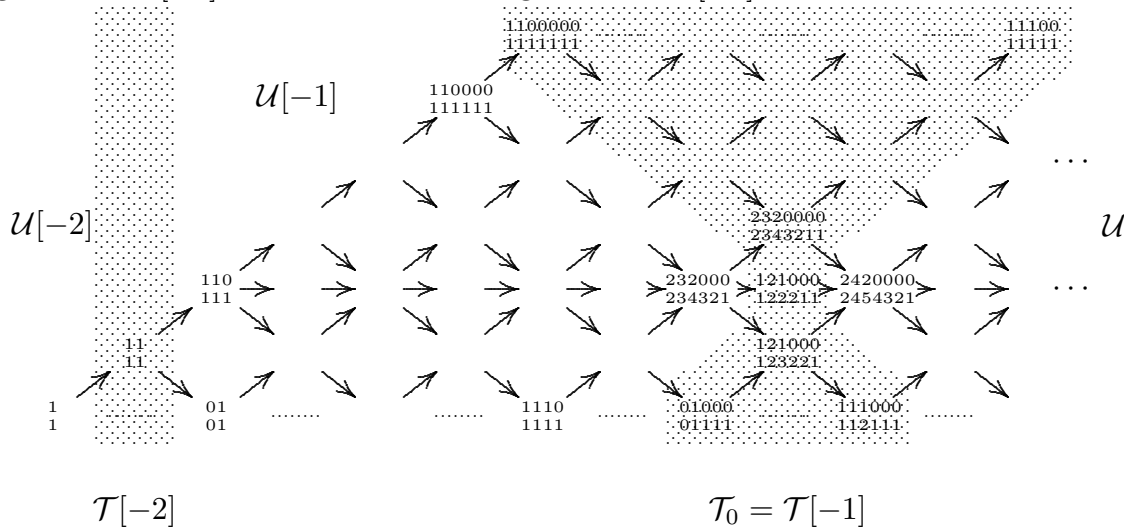

We show that \mathcal{D} consists of components of the Auslander-Reiten quiver for $\mathcal{S}_3(7)$. The source maps in \mathcal{D} are as follows: If $M \in \mathcal{D}$ has a path into \mathcal{R} then the source map

$M \rightarrow N$ is a source map in the category $B_1\text{-mod}$, otherwise it is a source map in $B_2\text{-mod}$. Let $B_* = B_1$ or $B_* = B_2$ for the first and second case, respectively. In each case, $M \rightarrow N$ is a source map in the category $\mathcal{S}_3(7)$: Let $T \in \mathcal{D}[i]$ be an indecomposable object and $t: M \rightarrow T$ a nonisomorphism. If $i = 0$ and $T \in B_*\text{-mod}$, then t factors through N (this includes the case that $B_* = B_1$ and T is a B_2 -module). Otherwise, T has a path into \mathcal{R} and M has not, so $\text{Hom}_{B_1}(M, T) = 0$. If $i > 0$ then T is a module over an iterated one point extension algebra B^+ for B_* and the component for M in the Auslander-Reiten quiver for $B_*\text{-mod}$ is also a component for the Auslander-Reiten quiver for B^+ (since all radicals of projective indecomposable objects have been extended). Again, t factors through N . Finally, if $i < 0$ then $\text{Hom}_{\mathcal{S}}(M, T) = \text{Hom}_{B^+}(M[-i], T[-i]) = 0$ since $T[-i]$ is a B_1 -module and M a module over an iterated one point extension algebra B^+ . Hence the Auslander-Reiten quiver for $\mathcal{S}_3(7)$ is as pictured below.

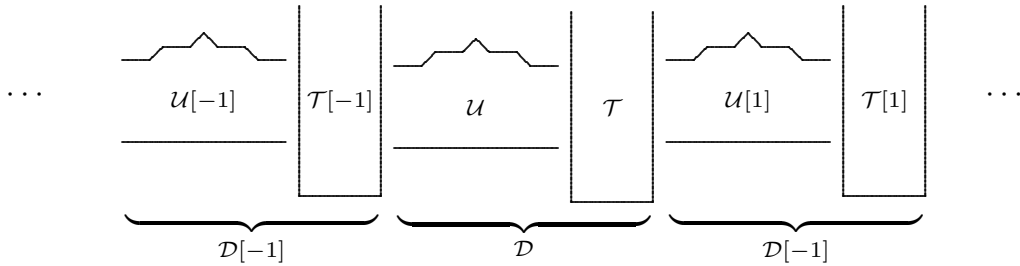

Proposition 13. (Separation properties of $\mathcal{S}_3(7)$)

1. Let $\mathcal{P}_T[i] = \bigvee_{j < i} (\mathcal{T}[j] \vee \mathcal{U}[j+1])$ and $\mathcal{I}_T[i] = \bigvee_{j > i} (\mathcal{U}[j] \vee \mathcal{T}[j])$. Then $\mathcal{T}[i]$ separates $\mathcal{P}_T[i]$ from $\mathcal{I}_T[i]$ in the sense that

$$\text{Hom}(\mathcal{T}[i], \mathcal{P}_T[i]) = \text{Hom}(\mathcal{I}_T[i], \mathcal{T}[i]) = \text{Hom}(\mathcal{I}_T[i], \mathcal{P}_T[i]) = 0$$

and that for every map $f \in \text{Hom}(M, N)$ where $M \in \mathcal{P}_T[i]$ and $N \in \mathcal{I}_T[i]$, and for every tube \mathcal{T}_γ in $\mathcal{T}[i]$ the map f factors through a sum of objects in \mathcal{T}_γ .

2. If $\mathcal{P}_U[i] = \bigvee_{j < i} (\mathcal{U}[j] \vee \mathcal{T}[j])$ and $\mathcal{I}_U[i] = \bigvee_{j > i} (\mathcal{T}[j-1] \vee \mathcal{U}[j])$ then $\mathcal{U}[i]$ separates $\mathcal{P}_U[i]$ from $\mathcal{I}_U[i]$ in the sense that

$$\text{Hom}(\mathcal{U}[i], \mathcal{P}_U[i]) = \text{Hom}(\mathcal{I}_U[i], \mathcal{U}[i]) = \text{Hom}(\mathcal{I}_U[i], \mathcal{P}_U[i]) = 0$$

holds and that for every map $f \in \text{Hom}(M, N)$ where $M \in \mathcal{P}_U[i]$ and $N \in \mathcal{I}_U[i]$ and for every slice \mathcal{R} in $\mathcal{U}[i]$ the map f factors through a sum of objects in \mathcal{R} .

Proof: First we determine the minimal left and right approximations for certain objects in $\mathcal{S}_3(7)$ in $B_2\text{-mod}$. Suppose that $M \in \mathcal{S}_3(7)$ has support in the set $\{i \mid i \leq 7\} \cup \{i' \mid i \leq 3\}$. Then the map

$$\begin{array}{ccc}
 \begin{array}{ccccccc}
 M'_{-1} & \xleftarrow{a_0} & M'_0 & \xleftarrow{a_1} & M'_1 & \xleftarrow{a_2} & M'_2 \leftarrow \dots \\
 j_{-1} \downarrow & & \downarrow j_0 & & \downarrow j_1 & & \downarrow j_2 \\
 M_{-1} & \xleftarrow{b_0} & M_0 & \xleftarrow{b_1} & M_1 & \xleftarrow{b_2} & M_2 \leftarrow \dots
 \end{array} & \longrightarrow & \begin{array}{ccccccc}
 0 & \leftarrow & M_0 & \xleftarrow{b_1} & M_1 & \xleftarrow{j_2 b_2} & M'_2 \leftarrow \dots \\
 & & \downarrow 1 & & \downarrow 1 & & \downarrow j_2 \\
 0 & \leftarrow & M_0 & \xleftarrow{b_1} & M_1 & \xleftarrow{b_2} & M_2 \leftarrow \dots
 \end{array}
 \end{array}$$

is a minimal left approximation for M in B_2 -mod. Similarly, if M has support in $\{i|i \geq 0\} \cup \{i'|i' \geq 0\}$ and if j_0 and j_1 are isomorphisms, then the inclusion

$$\begin{array}{ccccccc}
 \cdots & \leftarrow & M'_3 & \leftarrow & 0 & \leftarrow & \cdots & \leftarrow & 0 & \leftarrow & 0 \\
 & & \downarrow & & \downarrow & & \downarrow & & \downarrow & & \\
 \cdots & \leftarrow & M_3 & \leftarrow & M_4 & \leftarrow & \cdots & \leftarrow & M_7 & \leftarrow & 0
 \end{array}
 \longrightarrow
 \begin{array}{ccccccc}
 \cdots & \leftarrow & M'_3 & \leftarrow & M'_4 & \leftarrow & \cdots & \leftarrow & M'_7 & \leftarrow & M'_8 \\
 & & \downarrow & & \downarrow & & \downarrow & & \downarrow & & \\
 \cdots & \leftarrow & M_3 & \leftarrow & M_4 & \leftarrow & \cdots & \leftarrow & M_7 & \leftarrow & M_8
 \end{array}$$

is a minimal right approximation for M in B_2 -mod.

For the proof of the first assertion, we assume that $i = 0$. Then $\mathcal{T}[0]$ is the tubular family for B_2 . The statement about the nonexistence of homomorphisms follows from the corresponding statement about preprojective, regular, and preinjective B_2 -modules and the fact that the minimal left approximation of an object in $\mathcal{P}_T[0]$ is a preprojective B_2 -module and the minimal right approximation of an object in $\mathcal{I}_T[0]$ is a preinjective B_2 -module. If $f \in \text{Hom}(M, N)$ and \mathcal{T}_γ a tube in $\mathcal{T}[0]$, then f factors through both the minimal left approximation for M and the minimal right approximation for N and hence through \mathcal{T}_γ .

For the second assertion we use the fact that the minimal left approximation for an object in $\mathcal{P}_U[1]$ is a preprojective or regular B_2 -module, that the minimal right approximation for an object in $\mathcal{I}_U[0]$ is regular or preinjective, that the minimal right approximation for an object in $\mathcal{U}[1]$ is preinjective as a B_2 -module and that the minimal left approximation for a module in $\mathcal{U}[0]$ is preprojective. Each claim about the nonexistence of homomorphisms follows for either $i = 0$ or $i = 1$. To show the last assertion, let $f \in \text{Hom}(M, N)$ where $M \in \mathcal{P}_U[0]$ and $N \in \mathcal{I}_U[0]$, and let \mathcal{R} be a slice in $\mathcal{U}[0]$. Since the minimal left approximation for M is a preprojective B_2 -module, f factors through a preprojective B_2 -module. Using the property of source maps in B_2 -mod, we obtain that f factors through some slice in $\mathcal{U}[0]$ which we may assume to be on the right hand side of \mathcal{R} (where all objects are preprojective B_2 -modules); and using the property of sink maps in \mathcal{U} it follows that f actually factors through \mathcal{R} . \checkmark

Note that all modules in \mathcal{U} and in \mathcal{T} are modules over some finite dimensional algebra, and hence $\mathcal{S}_3(7)$ is locally support finite. Theorem 5 above yields the following information about the corresponding category $\mathcal{S}_3(k[T]/T^7)$.

Theorem 14. *The category $\mathcal{S}_3(k[T]/T^7)$ consists of a $\mathbb{P}_1(k)$ -family of stable tubes of type $(5, 3, 2)$ and of a connecting component \mathcal{U} of stable orbit type $\mathbb{Z}\tilde{\mathbb{E}}_8$ with two nonstable orbits of length 10 and 1 attached. Homomorphisms in the infinite radical of \mathcal{T} factor through any slice in \mathcal{U} , and maps in the infinite radical of \mathcal{U} factor through any of the tubes in \mathcal{T} . \checkmark*

The two nonstable orbits in \mathcal{U} and the mouths of the big tubes are pictured below.

The indecomposables on the mouth of the homogeneous tubes which do not involve

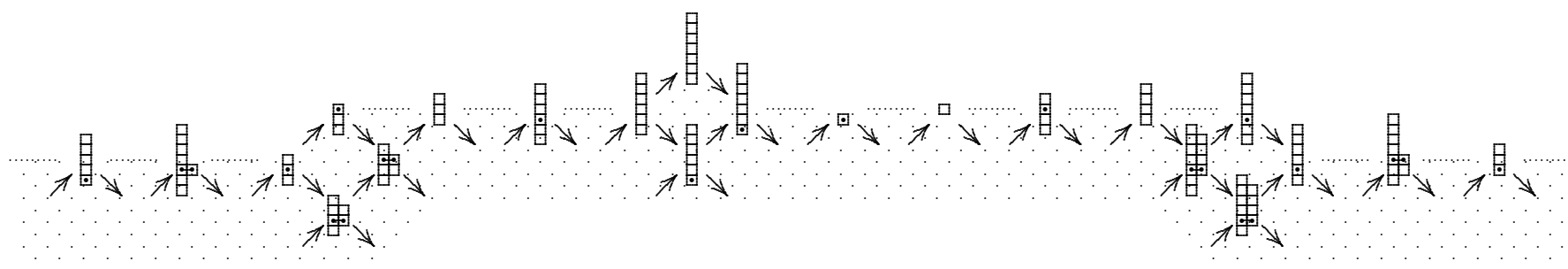

The Nonstable Modules in the Connecting Component in $\mathcal{S}_3(k[T]/T^7)$

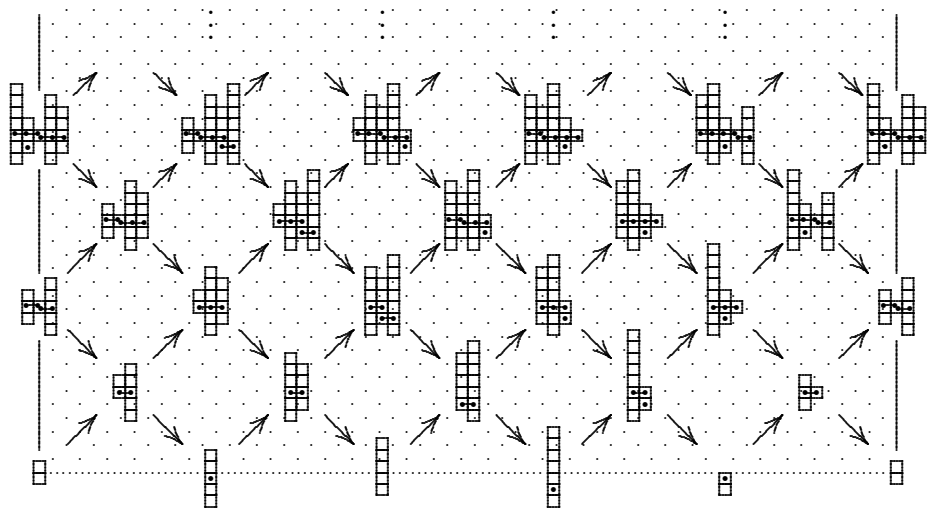

The Tube of Circumference Five in $\mathcal{S}_3(k[T]/T^7)$

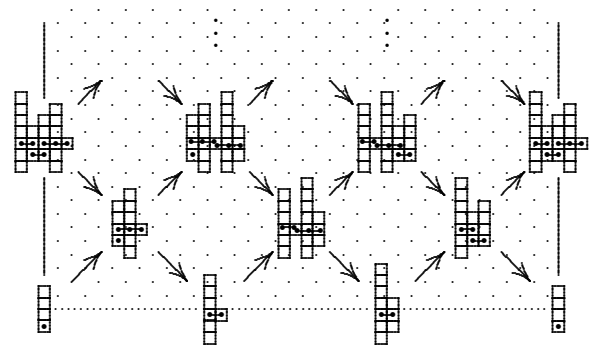

The Tube of Circumference Three in $\mathcal{S}_3(k[T]/T^7)$

any field extensions have the following type

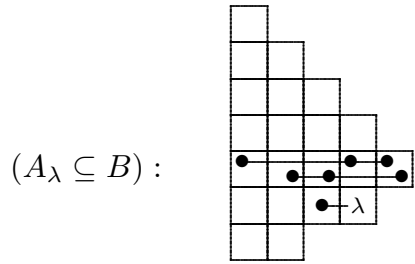

where $\lambda \in k \setminus \{0, -1\}$. For $\lambda = \infty$ we obtain the last module in the fifth row in the tube of circumference five; for $\lambda = 0$, $(A_\lambda \subseteq B)$ is the second module in the third row in the tube of circumference three; and for $\lambda = -1$ one obtains the first module in the second row in the tube of circumference two below. The isomorphism is as follows.

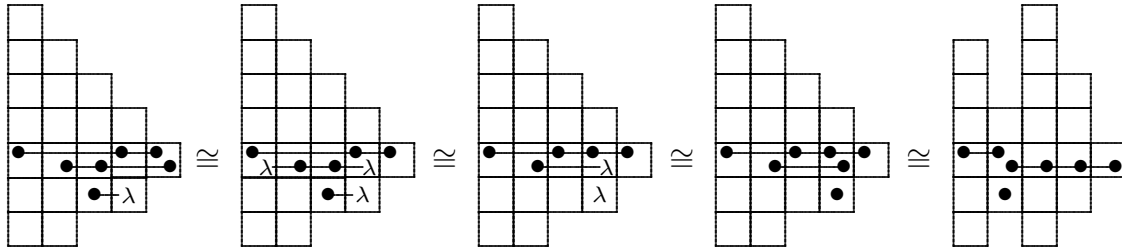

(The first isomorphism is given by subtracting the first generator of the subgroup from the second; if the big group has generators x_7, x_6, x_4, x_3, x_1 , then the second isomorphism is obtained by replacing x_6 by $x'_6 = x_6 + \lambda T x_7$ and x_3 by $x'_3 = x_3 + \lambda^{-1} T x_4$; for the third isomorphism we multiply the second and the third generator of the subgroup by λ^{-1} and replace x'_6 by $x''_6 = \lambda^{-1} x'_6$; the last isomorphism is just a rearrangement of the columns.)

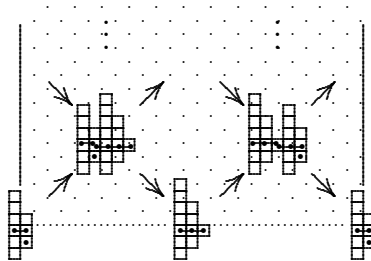

The Tube of Circumference Two in $\mathcal{S}_3(k[T]/T^7)$

In particular, the objects $(A_\lambda \subseteq B)$ pictured above are indecomposable and pairwise nonisomorphic for $\lambda \in k \cup \{\infty\}$. We deduce the corresponding information about the subgroup embeddings $(C_\lambda \subseteq D)$ studied in the introduction.

Corollary 15. *For $\lambda \in \{0, \dots, p-1\}$, the subgroup embeddings $(C_\lambda \subseteq D)$ in the introduction are indecomposable and pairwise nonisomorphic objects in $\mathcal{S}_3(\mathbb{Z}/p^7)$.*

Proof: Consider the layer functors $L_i : \mathcal{S}_3(\mathbb{Z}/p^7) \rightarrow \text{mod } \mathbb{Z}/p^7$ defined by

$$L_2(A \subseteq B) = (p^4 B \cap p^{-2} 0_B) + (p^2 B \cap p^{-1} 0_B) \quad \text{and}$$

$$L_i(A \subseteq B) = p^{2-i}(L_2(A \subseteq B)) \quad \text{for } i \neq 2.$$

For each i , the i -th layer $L_i = L_i(A \subseteq B)$ is a subgroup of B , and the sequence $(L_i)_i$ defines a filtration for B , as follows.

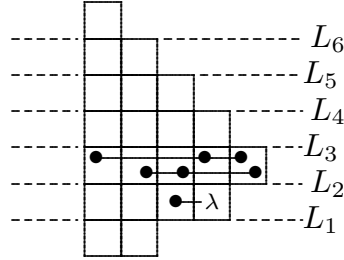

The vectorspaces $M_i = L_i/L_{i-1}$ and $M'_i = A \cap L_i/A \cap L_{i-1}$ together with the linear maps obtained from the multiplication by p define a \mathbb{Z}/p -linear representation of \tilde{Q} . In fact, the composition of this construction with the covering functor gives rise to an additive functor $\mathcal{S}_3(\mathbb{Z}/p^7) \rightarrow \mathcal{S}_3((\mathbb{Z}/p)[T]/T^7)$ which maps the subgroup embeddings $(C_\lambda \subseteq D)$ from the introduction to the above objects $(A_\lambda \subseteq B)$ in $\mathcal{S}_3((\mathbb{Z}/p)[T]/T^7)$. Since the objects $(A_\lambda \subseteq B)$ are indecomposable and pairwise nonisomorphic for $\lambda \in \mathbb{Z}/p$, so are the subgroup embeddings $(C_\lambda \subseteq D)$. \checkmark

THE CASES $m = 3, n \geq 8$.

For $m \geq 4$ and $n \geq 7$ or for $m \geq 3$ and $n \geq 8$, the categories $\mathcal{S}_m(n)$ and $\mathcal{S}_m(k[T]/T^n)$ have wild representation type. In [8], it is shown that $\mathcal{S}_4(k[T]/T^7)$ in fact is controlled k -wild with a single control object. Here we show the following result.

Proposition 16. *For $n \geq 8$, the categories $\mathcal{S}_3(n)$ and $\mathcal{S}_3(k[T]/T^n)$ have wild representation type. Moreover, the category $\mathcal{S}_3(n)$ is even strictly wild in the sense that any finite dimensional k -algebra can be realized as the endomorphism ring of an object in $\mathcal{S}_3(n)$.*

Proof: The algebra B_0 given by the quiver

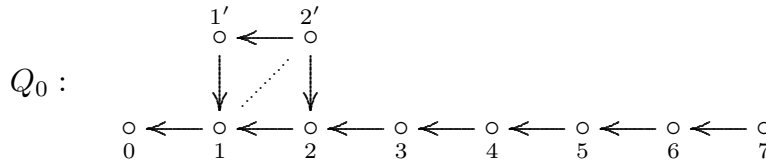

with the commutativity relation as indicated is tilted from a wild hereditary algebra of type $\tilde{\mathbb{E}}_8$ by using a preprojective tilting module, and hence has wild representation type. Indeed, the tilting functor is defined by forming the pushout of the commutative square. The simple B_0 -modules S'_1 and S'_2 occur in the preinjective component and hence the category $\mathcal{S}_3(n)$ contains as a full subcategory the category of regular B_0 -modules (which is equivalent to the category of regular $k\tilde{\mathbb{E}}_8$ -modules). Since any finite dimensional k -algebra can be realized as the endomorphism ring of some regular B_0 -module, it can also be realized as the endomorphism ring of an object in $\mathcal{S}_3(n)$. \checkmark

THE CASE $m = 4, n = 6$.

The category $\mathcal{S}_4(k[T]/T^6)$ has tame infinite representation type, and the Auslander-Reiten quiver consists of a family of tubes and a connecting component, similar to the situation in $\mathcal{S}_3(k[T]/T^7)$. We also consider $\mathcal{S}_4(k[T]/T^6)$ as a subcategory of $\mathcal{S}(k[T]/T^6)$.

First we investigate the covering category $\mathcal{S}_4(6)$. We will see that the Auslander-Reiten quiver has the following global structure.

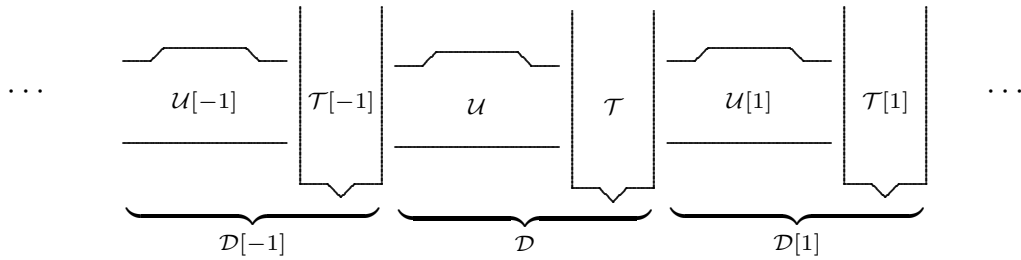

Here, \mathcal{T} consists of a $\mathbb{P}_1(k)$ -family of tubes \mathcal{T} of type $(5, 3, 2)$; all the tubes in \mathcal{T} are stable with the exception of the big tube which contains the projective injective module $Y[2]$. The connecting component \mathcal{U} has stable part of type $\mathbb{Z}\tilde{\mathbb{E}}_8$, to which a non-stable orbit of length six is attached.

It turns out that most indecomposables in $\mathcal{S}_4(6)$ have a translate under the shift which is a module over the following algebra B given by the quiver Q and the relations as indicated.

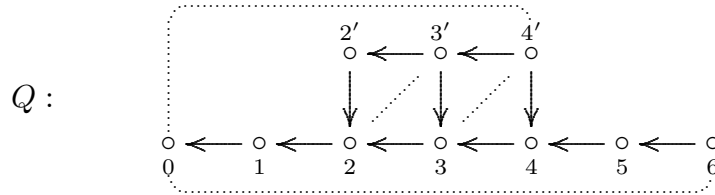

First we show that the Auslander-Reiten quiver of B has the following structure.

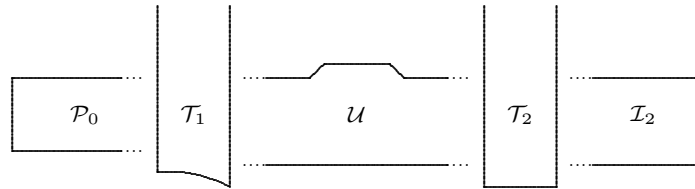

Let Q_0 be the full subquiver obtained from Q by deleting the points $4'$ and 6 , and let B_0 be the algebra given by Q_0 and the commutativity relation as indicated. This algebra is tame concealed of tubular type $(4, 3, 2)$, and as $\text{rad } P_6$ occurs on the mouth of the big tube, and $\text{rad } P_4'$ is preinjective, it follows that the preprojective component \mathcal{P}_0 of B_0 forms a preprojective component for B . We will picture this component later. Here is the mouth of the 4-tube for B_0 .

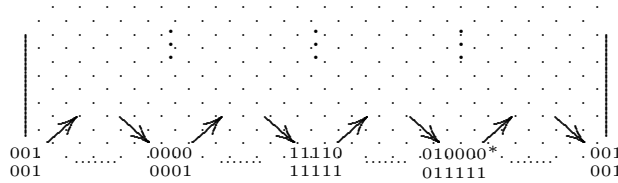

Let B_1 be the algebra obtained from B_0 by a one-point extension at $\text{rad } P_6$ which is the module labelled by a $*$ in the above diagram. Thus, B_1 is the pathalgebra of the quiver

Q_1 obtained from Q by deleting the point $4'$, with the induced relations. This algebra B_1 is tame domestic, and according to [5, Theorem 4.9.2], its module category consists of the following subcategories: (a) the preprojective component \mathcal{P}_0 , (b) a tubular family \mathcal{T}_1 of type $(5, 3, 2)$, obtained from the tubular family for B_0 by a ray insertion in the 4-tube, and (c) a preinjective component \mathcal{I}_1 . The tubular family separates \mathcal{P}_0 from \mathcal{I}_1 .

The component \mathcal{I}_1 contains the module $\text{rad } P[4]$ as a τ -successor of $I[0]$, so when we insert a ray at $\text{rad } P[4]$ we obtain a component of B -modules; this is the component \mathcal{U} which we picture here.

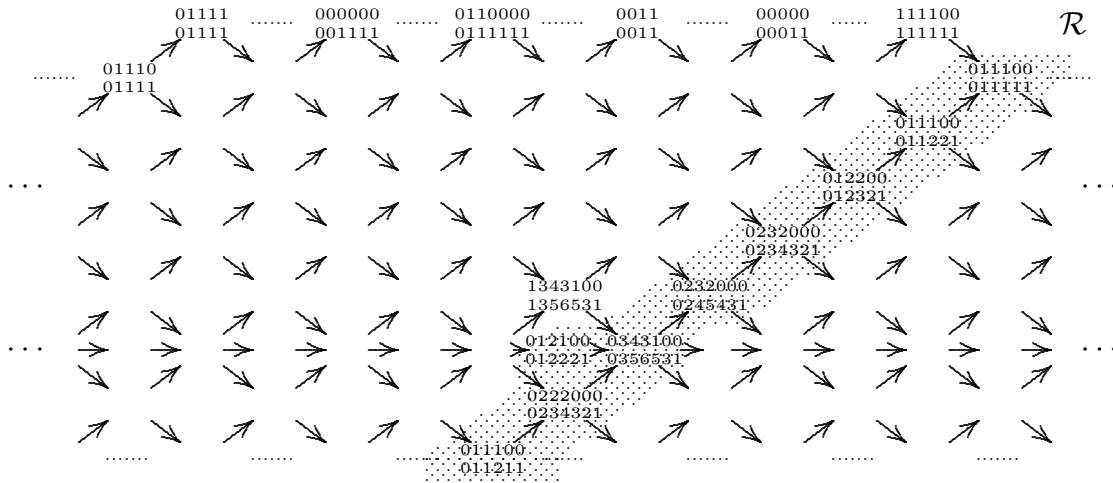

The modules in the shaded region \mathcal{R} and on the right hand side of it have no nonzero maps into $I[0]$ and hence are modules over the algebra B_2 , which is given by the quiver Q_2 obtained from Q by deleting the point 0 , and by the two commutativity relations. It turns out that \mathcal{R} forms a slice in the preprojective component for B_2 ; it follows that the right hand part of \mathcal{U} is just the right hand part of this component.

The algebra B_2 is tame concealed of tubular type $(5, 3, 2)$; besides the modules in the preprojective component \mathcal{P}_2 , there is a family of tubes \mathcal{T}_2 and a preinjective component \mathcal{I}_2 . The tubular family separates \mathcal{P}_2 from \mathcal{I}_2 , and hence — when considered a tubular family of B -modules — it separates \mathcal{P}_0 , \mathcal{T}_1 , and \mathcal{U} from \mathcal{I}_2 . This finishes our description of the Auslander-Reiten quiver for B .

Note that none of the objects of type $Y[i]$ in $\mathcal{S}_4(6)$ occurs as a B -module, so we have to perform another — final — extension. Consider the mouth of the big tube in \mathcal{T}_2 , which contains the module $\text{rad } Y[2]$, labelled by a star.

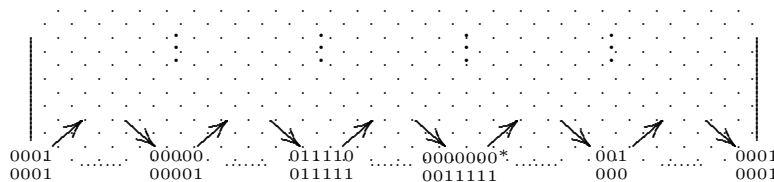

Let B' denote the algebra obtained from B by a one-point extension at $\text{rad } Y[2]$.

The Auslander-Reiten quiver for B' has the following structure.

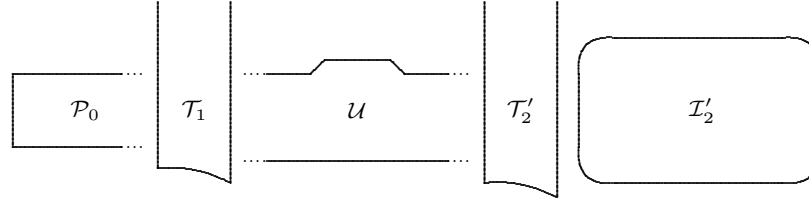

Since $\mathcal{D}' = \mathcal{P}_0 \vee \mathcal{T}_1 \vee \mathcal{U} \vee \mathcal{T}'_2$ contains the injective representation $I[0]$ and the relatively injective presentation $Y[2]$ but no unextended radicals of projective representations, it follows that every indecomposable in $\mathcal{S}_4(6)$ has a translate in \mathcal{D}' with respect to the shift.

We observe that the simple module S'_2 occurs at the mouth of the big tube in \mathcal{T}'_2 while the simple modules S'_3 and S'_4 lie in \mathcal{I}'_2 . Thus, all the modules in $\mathcal{P}_0 \vee \mathcal{T}_1 \vee \mathcal{U} \vee \mathcal{T}'_2$ are representations of $\mathcal{S}_4(6)$, with the exception of the modules in the ray starting at S'_2 . Let \mathcal{E} be the tube obtained from the nonstable tube \mathcal{E}' in \mathcal{T}'_2 by deleting the ray starting at S'_2 .

Lemma 17.

1. The tube \mathcal{E} is a connected component of the Auslander-Reiten quiver of $\mathcal{S}_4(6)$.
2. Let \mathcal{T} be the family of tubes obtained from \mathcal{T}_2 by replacing the nonstable tube by \mathcal{E} . Then $\mathcal{D} = \mathcal{U} \vee \mathcal{T}$ is a fundamental domain for the shift in $\mathcal{S}_4(6)$.

Proof: 1. After the ray deletion, the tube consists only of objects in $\mathcal{S}_4(6)$. We show that all source maps are source maps in $\mathcal{S}_4(6) \cap B'$ -mod. Consider the subgraph of \mathcal{E}' where V_i, V_{i+1} are on the ray starting at S'_2 .

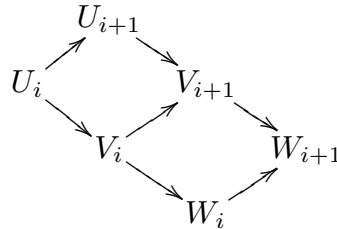

Then the map $V_i \rightarrow W_i$ is a left approximation for V_i in $\mathcal{S}_4(6)$, and the map $f: U_i \rightarrow U_{i+1} \oplus W_i$, being the composition of the source map with the left approximation, is a source map in the category B' -mod $\cap \mathcal{S}_4(6)$. We will see later that — as in the case of the category $\mathcal{S}_3(7)$ — f in fact is a source map in $\mathcal{S}_4(6)$.

Here is the mouth of the 5-tube in \mathcal{T} , after this operation.

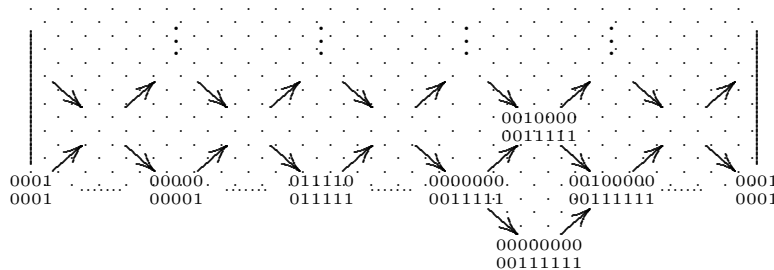

2. We observe that the modules in \mathcal{T}_1 are contained in $\mathcal{T}[-1]$; and the only representations of $\mathcal{T}[-1]$ which are not in \mathcal{T}_1 lie in the coray ending at $Y[1]$. To finish the proof one checks that each representation in \mathcal{P}_0 has a translate in \mathcal{D} . Here we picture \mathcal{P}_0 and indicate for each representation to which category $\mathcal{T}[i]$ or $\mathcal{U}[i]$ it belongs. \checkmark

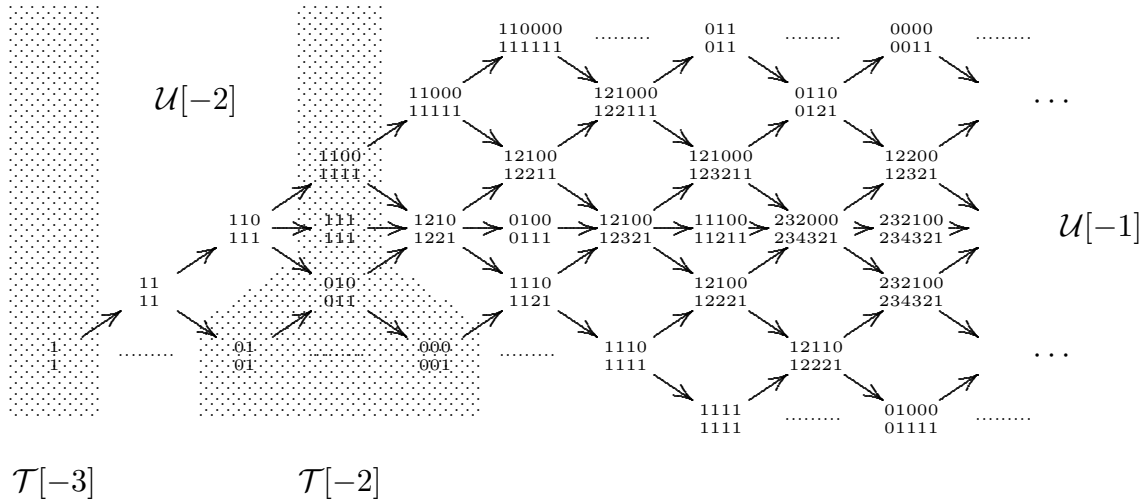

The Auslander-Reiten sequences in \mathcal{U} and in \mathcal{T} actually are Auslander-Reiten sequences in the category $\mathcal{S}_4(6)$: Let B^+ be obtained from the algebra B' by forming iterated one point extensions at radicals of projective $\mathcal{S}_4(6)$ -modules. Such radicals occur only in the category \mathcal{I}'_2 , so the components \mathcal{U} and \mathcal{T}'_2 are components of the Auslander-Reiten quiver for B^+ . The argument in the first statement in Lemma 17 yields that \mathcal{U} and \mathcal{T} (which is $\mathcal{T}'_2 \cap \mathcal{S}_4(6)$) consist of Auslander-Reiten sequences in $\mathcal{S}_4(6) \cap B^+ \text{-mod}$. It follows, as in the case $m = 1$, that they are Auslander-Reiten sequences in $\mathcal{S}_4(6)$.

The category $\mathcal{S}_4(6)$ has separation properties similar to those for $\mathcal{S}_3(7)$. The result corresponding to Proposition 13 can be shown as in the section on $\mathcal{S}_3(7)$, or by using the separation properties in the big category $\mathcal{S}(6)$ studied in [6].

Using covering theory, we obtain the following conclusion for $\mathcal{S}_4(k[T]/T^6)$.

Proposition 18. *The category $\mathcal{S}_4(k[T]/T^6)$ consists of:*

- *A $\mathbb{P}_1(k)$ family of tubes \mathcal{T} of type $(5, 3, 2)$. All tubes are stable with the exception of the tube of circumference five pictured below which contains one nonstable module Y .*
- *The connecting component \mathcal{U} which has stable orbit type \mathbb{E}_8 and a nonstable orbit of length 6 from P to I .*

Moreover, homomorphisms in the infinite radical of \mathcal{T} factor through any slice in \mathcal{U} , and homomorphisms in the infinite radical of \mathcal{U} factor through any of the tubes in \mathcal{T} . \checkmark

Let us now consider $\mathcal{S}_4(k[T]/T^6)$ as a full subcategory of $\mathcal{S}(k[T]/T^6)$, this is a tubular category of tubular type $(6, 3, 2)$, so each indecomposable occurs in a tube and the set of tubes is indexed by a rational angle $\gamma \in \mathbb{Q}/\mathbb{Z}$ and an irreducible polynomial in $\mathbb{P}_1(k)$ (see [6]). All tubes are stable with the exception of the tube \mathcal{T}_0^6 of circumference six in the family of index $\gamma = 0 + \mathbb{Z}$. We will need the modules X and Z below which occur as first

term and as endterm of the Auslander-Reiten sequence which contains $P = I$ as summand of the middle term and which forms part of the mouth of \mathcal{T}_0^6 .

$$0 \longrightarrow \begin{array}{|c|} \hline \square \\ \hline \bullet \\ \hline \square \\ \hline \square \\ \hline \square \\ \hline \end{array} \longrightarrow \begin{array}{|c|} \hline \square \\ \hline \bullet \\ \hline \square \\ \hline \square \\ \hline \square \\ \hline \end{array} \oplus \begin{array}{|c|} \hline \square \\ \hline \bullet \\ \hline \square \\ \hline \square \\ \hline \square \\ \hline \end{array} \longrightarrow \begin{array}{|c|} \hline \square \\ \hline \bullet \\ \hline \square \\ \hline \square \\ \hline \square \\ \hline \end{array} \longrightarrow 0$$

Each indecomposable object $(A \subseteq B)$ for which A has a summand of type $k[T]/T^5$ admits a monomorphism from Z and has a map into X which is an epimorphism on the subspaces. Note that the subspaces in X and in Z are shifted against each other by one box. It follows that $(A \subseteq B)$ occurs either on the ray starting at Z or on the coray ending at X or in a tubular family of index $\gamma \neq 0 + \mathbb{Z}$. Conversely, the stable tubes of index $\gamma = 0 + \mathbb{Z}$ form the stable tubes in the family of tubes \mathcal{T} in $\mathcal{S}_4(k[T]/T^6)$ above. And the nonstable tube in \mathcal{T} is obtained from the nonstable tube in \mathcal{T}_0^6 by deleting $P = I$ and the modules on the ray starting at Z and the modules on the coray ending at X , as follows.

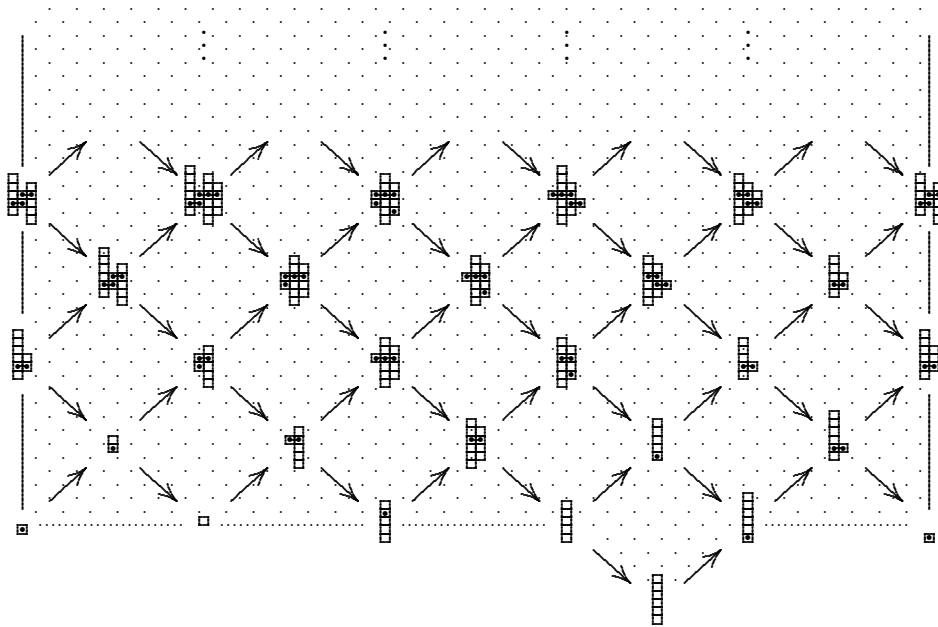

The Tube of Circumference Five in $\mathcal{S}_4(k[T]/T^6)$

The inclusion map $Z \rightarrow X$ factors over some module in each of the tubes with index $\gamma \neq 0 + \mathbb{Z}$. Thus, each tube with $\gamma \neq 0 + \mathbb{Z}$ has a module on its mouth which has $k[T]/T^5$ as summand of the subspace — with one possible exception: The Auslander-Reiten sequence in $\mathcal{S}(k[T]/T^6)$ (involving the modules I and P from $\mathcal{S}_4(k[T]/T^6)$)

$$0 \longrightarrow \begin{array}{|c|} \hline \square \\ \hline \bullet \\ \hline \square \\ \hline \square \\ \hline \square \\ \hline \end{array} \longrightarrow \begin{array}{|c|} \hline \square \\ \hline \bullet \\ \hline \bullet \\ \hline \bullet \\ \hline \square \\ \hline \square \\ \hline \end{array} \longrightarrow \begin{array}{|c|} \hline \square \\ \hline \bullet \\ \hline \square \\ \hline \square \\ \hline \square \\ \hline \end{array} \longrightarrow 0$$

has the property that the sequence of subspaces is not split exact, and it is the only Auslander-Reiten sequence with this property in which a summand of type $k[T]/T^4$ in the

subspace is involved. This sequence occurs on the mouth of the tube $\mathcal{T}_{1/2}^6$ of circumference six and index $\gamma = \frac{1}{2} + \mathbb{Z}$, and hence $\mathcal{T}_{1/2}^6 \cap \mathcal{S}_4(k[T]/T^6)$ consists of all modules on the wing bounded by the mouth of the tube, the ray starting at the endterm and the coray ending at the first term of the above sequence. There are three indecomposables in $\mathcal{T}_{1/2}^3 \cap \mathcal{S}_4(k[T]/T^6)$ which form an Auslander-Reiten sequence along the mouth and a single module in $\mathcal{T}_{1/2}^2 \cap \mathcal{S}_4(k[T]/T^6)$. This wing triple of size $(6, 2, 1)$ forms the diamond shaped center piece of the connecting component \mathcal{U} , as pictured below.

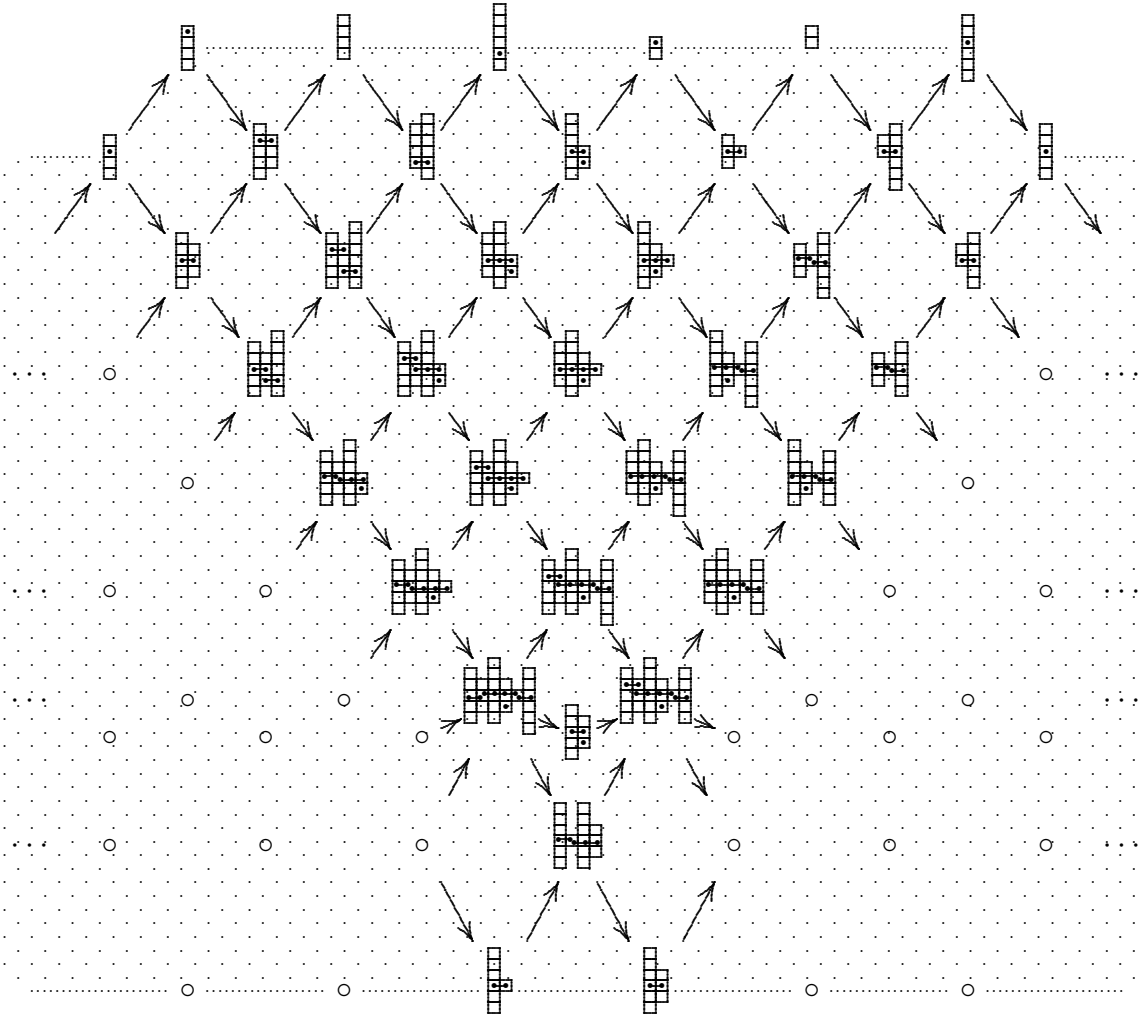

The Diamond in the Connecting Component in $\mathcal{S}_4(k[T]/T^6)$

Of particular interest is the module on the intersection of the ray starting at P and the coray ending at I . It is the only indecomposable object in $\mathcal{S}_4(k[T]/T^6)$ in which the subgroup has two summands of type $k[T]/T^4$ which are shifted against each other.

We conclude with the remark that the connecting component \mathcal{U} is in fact made up from many more and smaller diamonds. For example, for each fraction of type $\gamma = \frac{1}{n}$ or of type $\gamma = \frac{n-1}{n}$, the tubular family in $\mathcal{S}(k[T]/T^6)$ of index $\gamma + \mathbb{Z}$ intersected with

$\mathcal{S}_4(k[T]/T^6)$ consists exactly of three wings of size $(5, 2, 1)$. These wing triples are aligned in \mathcal{U} according to their index. For example, the irreducible predecessor of P (pictured on the left) occurs in the wing of sidelength five from $\mathcal{T}_{1/3}^6$ and the irreducible successor of I (pictured on the right) occurs in the wing of length five in $\mathcal{T}_{2/3}^6$.

References

- [1] D. M. Arnold: *Abelian Groups and Representations of Finite Partially Ordered Sets*, Springer CMS Books in Mathematics (2000).
- [2] M. Auslander and S. O. Smalø: *Almost Split Sequences in Subcategories*, Journal of Algebra 69 (1981), 426-454.
- [3] D. Happel: *Triangulated Categories in the Representation Theory of Finite Dimensional Algebras*, London Mathematical Society Lecture Notes series **119**, Cambridge University Press, Cambridge, 1988.
- [4] F. Richman and E. A. Walker: *Subgroups of p^5 -Bounded Groups*, in: Trends in Mathematics, Birkhäuser 1999, 55–73.
- [5] C. M. Ringel: *Tame Algebras and Integral Quadratic Forms*, Springer LNM 1099 (1984).
- [6] C. M. Ringel and M. Schmidmeier: *Submodules of Modules over a Uniserial Ring*, manuscript (2004), 1–24.
- [7] C. M. Ringel and M. Schmidmeier: *The Auslander-Reiten Translation in Submodule Categories*, manuscript (2004), 1–25.
- [8] C. M. Ringel and M. Schmidmeier: *Subgroup Categories of Wild Representation Type*, manuscript (2004), 1–10.
- [9] W. Rump: *Irreduzible und Unzerlegbare Darstellungen Klassischer Ordnungen*, Bayreuther Mathematische Schriften **32** (1990), viii+405pp.