

Non-orientable 3-manifolds of complexity up to 7

Gennaro AMENDOLA

Bruno MARTELLI

November 13, 2018

Abstract

We classify all closed non-orientable \mathbb{P}^2 -irreducible 3-manifolds with complexity up to 7, fixing two mistakes in our previous complexity-up-to-6 classification. We show that there is no such manifold with complexity less than 6, five with complexity 6 (the four flat ones and the filling of the Gieseking manifold, which is of type Sol), and three with complexity 7 (one manifold of type Sol, and the two manifolds of type $\mathbb{H}^2 \times \mathbb{R}$ with smallest base orbifolds).

MSC (2000): 57M27 (primary), 57M20, 57M50 (secondary).

Keywords: 3-manifolds, non-orientable, complexity, enumeration.

Introduction

It has been experimented in various contexts that non-orientable 3-manifolds are much more sporadic than orientable ones. First of all, among the 8 three-dimensional geometries, only 5 have non-orientable representatives. Then, among cusped hyperbolic manifolds of complexity up to 7, only 1260 of 6075 are non-orientable, as shown in the Callahan-Hildebrand-Weeks census [5]. Here we show that, among *closed* \mathbb{P}^2 -irreducible manifolds of complexity up to 7, only 8 of 318 are non-orientable.

The complexity we refer to is the one defined by Matveev [11, 12]. As shown in [9], the complexity $c(M)$ of a closed \mathbb{P}^2 -irreducible M distinct from $S^3, \mathbb{R}\mathbb{P}^3, L_{3,1}$ equals the minimum number of tetrahedra needed to triangulate M . Closed non-orientable \mathbb{P}^2 -irreducible manifolds of complexity up to 6 were classified in [2] using only theoretical arguments. The arguments were correct, except for two mistakes in recognizing the geometries of the resulting manifolds: we fix them at the end of Section 1. (Namely, it is not true that all manifolds with complexity $c = 6$ are flat, and that there is one non-geometric manifold with $c = 7$, as asserted in [2].)

The main result of this paper, stated in Theorem 1.1 below, is the classification of all closed non-orientable \mathbb{P}^2 -irreducible manifolds with complexity $c \leq 7$. The contribution of this result to the census of all manifolds with $c \leq 9$ is summarized

in Table 1. Theorem 1.1 is stated and proved in Section 1. The proof of a lemma is deferred to Section 2 and some facts on I -bundles over surfaces and on $\mathbb{H}^2 \times \mathbb{R}$ -manifolds are collected in the Appendix.

Theorem 1.1 has been proved independently by Burton [3] using the computer program *Regina* [4]. More than that, Burton has classified all minimal triangulations with at most 7 tetrahedra.

Acknowledgements We thank Maria Rita Casali and Sergej Matveev for describing to us the Sol-manifold missing in our previous list [2].

1 Main statement

We recall that there are 8 important 3-dimensional geometries, six of them concerning Seifert manifolds. The geometry of a Seifert manifold is determined by two invariants of any of its fibrations, namely the Euler characteristic χ^{orb} of the base orbifold and the Euler number e of the fibration, according to Table 2. The two non-Seifert geometries are the hyperbolic and the Sol ones. We refer to [15] for definitions.

The complete list of closed *orientable* irreducible manifolds of complexity $c \leq 9$ is available from [16] and summarized in the first half of Table 1. The second half of Table 1 is recovered from the next result.

Theorem 1.1. *There are no non-orientable \mathbb{P}^2 -irreducible manifolds with complexity $c \leq 5$. There are 5 such manifolds with $c = 6$: they are the 4 flat ones and the torus bundle (of type Sol) with monodromy $\begin{pmatrix} 1 & 1 \\ 1 & 0 \end{pmatrix}$. There are 3 such manifolds with $c = 7$: they are the torus bundle (of type Sol) with monodromy $\begin{pmatrix} 2 & 1 \\ 1 & 0 \end{pmatrix}$, and the two non-orientable Seifert manifolds (of type $\mathbb{H}^2 \times \mathbb{R}$) defined by*

$$(\mathbb{RP}^2, (2, 1), (3, 1)) \quad \text{and} \quad (\bar{D}, (2, 1), (3, 1)) .$$

Concerning the statement of Theorem 1.1, we denote by \bar{D} the orbifold given by the disc with mirrored boundary. Moreover, well-definition of the two non-orientable Seifert manifolds of type $\mathbb{H}^2 \times \mathbb{R}$ is proved in [14, pages 15 and 90]. Using the notations of [14], the two manifolds are respectively

$$\{0; (0, 0, 0, 1); (2, 1), (3, 1)\} \quad \text{and} \quad \{0; (n_1, 1); (2, 1), (3, 1)\} .$$

Remark 1.2. The non-orientable \mathbb{P}^2 -irreducible manifolds with $c \leq 7$ are the “simplest” ones in each geometry: the Gieseking manifold (the cusped hyperbolic manifold with smallest volume 1.0149... [1] and smallest complexity 1 [5]) is the punctured torus bundle with monodromy $\begin{pmatrix} 1 & 1 \\ 1 & 0 \end{pmatrix}$. Therefore the Sol-manifold with $c = 6$

	0	1	2	3	4	5	6	7	8	9
orientable										
lens	3	2	3	6	10	20	36	72	136	272
other elliptic			1	1	4	11	25	45	78	142
flat							6			
Nil							7	10	14	15
$\widetilde{\mathrm{SL}}_2\mathbb{R}$								39	162	514
Sol								5	9	23
$\mathbb{H}^2 \times \mathbb{R}$									2	
hyperbolic										4
non-trivial JSJ								4	35	185
total orientable	3	2	4	7	14	31	74	175	436	1155
non-orientable										
flat							4			
$\mathbb{H}^2 \times \mathbb{R}$								2		?
Sol							1	1		?
total non-orientable							5	3		?

Table 1: The number of \mathbb{P}^2 -irreducible manifolds of given complexity (up to 9) and geometry (empty boxes contain 0).

	$\chi^{\mathrm{orb}} > 0$	$\chi^{\mathrm{orb}} = 0$	$\chi^{\mathrm{orb}} < 0$
$e = 0$	$\mathbb{S}^2 \times \mathbb{R}$	\mathbb{E}^3	$\mathbb{H}^2 \times \mathbb{R}$
$e \neq 0$	\mathbb{S}^3	Nil	$\widetilde{\mathrm{SL}}_2\mathbb{R}$

Table 2: The six Seifert geometries.

is the (unique) filling (with a solid Klein bottle) of the Gieseking manifold. The two Sol-manifolds with $c \leq 7$ are the only torus bundles over S^1 whose monodromy A is hyperbolic with $|\text{tr } A| \leq 2$, see Proposition A.6 in the Appendix. The two $\mathbb{H}^2 \times \mathbb{R}$ -manifolds with $c = 7$ have the smallest possible base hyperbolic orbifold, having volume $-2\pi\chi^{\text{orb}} = \pi/3$, see Proposition B.1 in the Appendix.

The main ingredient in the proof of Theorem 1.1 is the known list of all *orientable* irreducible manifolds with $c \leq 9$, available from [16], and the following lemma, which holds for manifolds of any complexity.

Lemma 1.3. *Let M be a closed non-orientable \mathbb{P}^2 -irreducible manifold, and \widetilde{M} be its orientable double covering. We have $c(\widetilde{M}) \leq 2 \cdot c(M) - 5$.*

The proof of Lemma 1.3 is deferred to Section 2. The rest of this section is devoted to the proof of Theorem 1.1.

Geometric decomposition We denote since now by T and K respectively the torus and the Klein bottle. Let M be a closed \mathbb{P}^2 -irreducible manifold. We recall that M has a unique *geometric decomposition* along embedded tori and Klein bottles, defined as follows: take the set of tori and Klein bottles of the JSJ decomposition, and substitute each element of this set bounding an I -bundle over T or K with the core T or K . In contrast to the JSJ, the geometric decomposition has two nice properties: it decomposes M into *blocks* with finite volume, and it remains geometric when lifted to finite coverings of M . See Corollaries A.3 and A.4 in the Appendix.

Seifert blocks Let now M be closed non-orientable and \widetilde{M} be its orientable double-covering. As we said, the geometric decomposition of M lifts to the one of \widetilde{M} . Let N be a block of the decomposition of M . Its pre-image in \widetilde{M} is amphichiral, *i.e.* it admits an orientation-reversing involution. Let us fix an orientation on \widetilde{M} . The pre-image of N consists of two blocks or one block, depending on whether N is orientable or not. If N is Seifert, its pre-image has Euler number zero [13]. (If it consists of two blocks \widetilde{N}_1 and \widetilde{N}_2 , we mean that $e(\widetilde{N}_1) = -e(\widetilde{N}_2)$). In particular, if the whole M is itself Seifert, both M and \widetilde{M} are either flat or of type $\mathbb{H}^2 \times \mathbb{R}$.

Orientable coverings of small complexity The following result, together with Lemma 1.3 and Proposition 1.5 below, will easily imply Theorem 1.1.

Proposition 1.4. *Let M be a closed non-orientable \mathbb{P}^2 -irreducible manifold. If its orientable double-covering \widetilde{M} has complexity $c(\widetilde{M}) \leq 9$, then one of the following occurs:*

- $c(\widetilde{M}) = 6$, and both \widetilde{M} and M are flat;
- $c(\widetilde{M}) = 7$, and both \widetilde{M} and M are Sol torus bundles over S^1 , with monodromies $\begin{pmatrix} 2 & 1 \\ 1 & 1 \end{pmatrix}$ and $\begin{pmatrix} 1 & 1 \\ 1 & 0 \end{pmatrix}$;
- $c(\widetilde{M}) = 8$, both \widetilde{M} and M are of type $\mathbb{H}^2 \times \mathbb{R}$, and
 - \widetilde{M} is $(S^2, (2, 1), (3, 1), (2, -1), (3, -1))$,
 - M is either $(\mathbb{RP}^2, (2, 1), (3, 1))$ or $(\bar{D}, (2, 1), (3, 1))$;
- $c(\widetilde{M}) = 9$, and both \widetilde{M} and M are Sol torus bundles over S^1 , with monodromies $\begin{pmatrix} 5 & 2 \\ 2 & 1 \end{pmatrix}$ and $\begin{pmatrix} 2 & 1 \\ 1 & 0 \end{pmatrix}$.

Proof. We denote by D , A , and S respectively the disc, the annulus, and the Möbius strip. Since M is \mathbb{P}^2 -irreducible, the orientable double-covering \widetilde{M} is irreducible. Now, an orientable irreducible manifold with complexity $c \leq 9$ has one of the following geometric decompositions [16]:

- (i) it is itself Seifert or Sol;
- (ii) it decomposes along one T into two Seifert blocks, each fibering over D with two singular fibers;
- (iii) it decomposes along one K into one Seifert block fibering over D with two singular fibers;
- (iv) it decomposes along one or two K 's into one Seifert block, which fibers either over D with 3 singular fibers of type $(2,1)$, or over S or A with one singular fiber of type $(2,1)$;
- (v) it is one of the 4 smallest hyperbolic manifolds known.

Cases (ii-v) occur only for $c \geq 7$. Note that the JSJ decomposition used in [16] should be translated into the geometric one by replacing each block of type $(D, (2, 1), (2, 1))$ with a K , thus getting cases (iii) and (iv). Cases (iv-v) only occur for $c = 9$.

Suppose \widetilde{M} is of type (i). If it is Seifert, since $e(\widetilde{M}) = 0$, it is either flat or of type $\mathbb{H}^2 \times \mathbb{R}$. If \widetilde{M} is flat, we are done. Suppose it is of type $\mathbb{H}^2 \times \mathbb{R}$. There are only two such manifolds in the list: they both have $c = 8$ and they are

$$(S^2, (2, 1), (3, 1), (2, -1), (3, -1)) \quad \text{and} \quad (\mathbb{RP}^2, (3, 1), (3, -1)).$$

In both cases we have $\chi^{\text{orb}}(\widetilde{M}) = -1/3$. Therefore $\chi^{\text{orb}}(M) = -1/6$. Now, Proposition B.1, proved in the Appendix, shows that there are two possible M 's. They have the same double cover, as required.

If \widetilde{M} is Sol, then M is Sol too. By Corollary A.6, proved in the Appendix, both \widetilde{M} and M are torus bundles over S^1 with some monodromies A^2 and A . From linear algebra we get $\text{tr}(A^2) = (\text{tr} A)^2 - 2 \det A = (\text{tr} A)^2 + 2$. The orientable manifolds in the list [16] satisfy $3 \leq |\text{tr}(A^2)| \leq 8$. The only possible values for $\text{tr}(A^2)$ are then 3 and 6 (namely, A^2 is $\begin{pmatrix} 2 & 1 \\ 1 & 0 \end{pmatrix}$ or $\begin{pmatrix} 5 & 2 \\ 2 & 1 \end{pmatrix}$), so $|\text{tr} A| \in \{1, 2\}$. By Corollary A.6, there is only one non-orientable manifold for each such value of $|\text{tr} A|$, hence we get two manifolds, with monodromies $\begin{pmatrix} 1 & 1 \\ 1 & 0 \end{pmatrix}$ and $\begin{pmatrix} 2 & 1 \\ 1 & 0 \end{pmatrix}$.

We are left to prove that \widetilde{M} cannot be of types (ii-v). Suppose it is of type (ii). Then \widetilde{M} is the union of two Seifert manifolds $\widetilde{N}_i = (D, (p_i, q_i), (r_i, s_i))$, with $r_i > 2$ and $i \in \{1, 2\}$. By what said above, the geometric decomposition of M consists of either one block homeomorphic to both \widetilde{N}_1 and \widetilde{N}_2 , or of two blocks N_1 and N_2 , with \widetilde{N}_i covering N_i . If the first possibility holds, there is an involution $\tau : \widetilde{M} \rightarrow \widetilde{M}$ exchanging \widetilde{N}_1 and \widetilde{N}_2 and giving M as a quotient. That τ restricts to an orientation-preserving order-2 involution on the torus T separating \widetilde{N}_1 and \widetilde{N}_2 . Therefore τ acts like $\pm I$ on $H_1(T)$, thus preserving simple closed curves (up to isotopy). On the other side, τ sends a fiber of \widetilde{N}_1 to a fiber of \widetilde{N}_2 , but these fibers give non-isotopic curves on T , and we get a contradiction. If the second possibility holds, we have $e(\widetilde{N}_1) = e(\widetilde{N}_2) = 0$, hence $p_i = r_i > 2$ for $i = 1, 2$. But no manifold with $c \leq 9$ in the list [16] has these parameters.

If \widetilde{M} is of type (iii), it is decomposed along a single K . But a manifold whose decomposition contains an odd number of K 's is not the double covering of a non-orientable one, see Corollary A.5. Finally, \widetilde{M} cannot be of type (iv) because the unique Seifert block has Euler number $e = 1/2 \neq 0$. And it cannot be of type (v), because the deck involution would be an isometry, but there is no orientation-reversing isometry of the 4 smallest closed hyperbolic manifolds known giving a manifold [7]. \square

Spines and complexity We briefly recall some definitions from [12]. A compact 2-dimensional polyhedron P is *simple* if the link of every point in P is contained in the 1-skeleton K of the tetrahedron. A point having the whole of K as a link is called a *vertex*. The set $V(P)$ of the vertices of P consists of isolated points, so it is finite. A compact polyhedron $P \subset M$ is a *spine* of the closed manifold M if $M \setminus P$ is an open ball. The *complexity* $c(M)$ of a closed 3-manifold M is then defined as the minimal number of vertices of a simple spine of M . It turns out [12, 9] that if M is \mathbb{P}^2 -irreducible and distinct from $S^3, \mathbb{R}\mathbb{P}^3, L_{3,1}$ then it has a *minimal* spine (*i.e.* a spine with $c(M)$ vertices) which is *special*. A spine P is special when it is the

2-skeleton of the dual of a 1-vertex triangulation of M . Its singular set $S(P)$ is a connected 4-valent graph.

Manifolds with marked boundary We now recall some definitions from [9], which we will use to prove Proposition 1.5 below. A θ -graph in the torus T is a trivalent graph $\theta \subset T$ whose complement in T is an open disc. Let M be a connected (possibly non-orientable) compact 3-manifold with (possibly empty) boundary consisting of tori. By associating to each component of ∂M a θ -graph, we get a *manifold with marked boundary* (one can also define markings on Klein bottles, see [9]). A simple polyhedron $P \subset M$ which intersects ∂M in the union of the markings and such that $M \setminus (P \cup \partial M)$ is an open ball is a *skeleton* for the marked M . When M is closed, a skeleton is just a spine.

Given two marked M, M' and a homeomorphism ψ between one component of ∂M and one of $\partial M'$ which preserves the markings, one can glue M and M' and get a new marked manifold N , which is called an *assembling* of M and M' . Two skeleta P, P' of M, M' glue via ψ to a skeleton Q of N . Spines of plenty of manifolds can be constructed in this way, and by controlling the number of their vertices one gets many strict upper bounds for complexity [10]. Here, we need the following one.

Proposition 1.5. *Every flat non-orientable manifold has complexity $c \leq 6$. The torus bundles with monodromy $\begin{pmatrix} 1 & 1 \\ 1 & 0 \end{pmatrix}$ and $\begin{pmatrix} 2 & 1 \\ 1 & 0 \end{pmatrix}$ have respectively $c \leq 6$ and $c \leq 7$. The closed non-orientable manifolds*

$$(\mathbb{RP}^2, (2, 1), (3, 1)) \quad \text{and} \quad (\bar{D}, (2, 1), (3, 1))$$

have complexity $c \leq 7$.

Proof. Spines of flat manifolds with 6 vertices are constructed in [2, Section 3]. The upper bound for torus bundles M with monodromy $A \in \text{GL}_2(\mathbb{Z})$ given in [10] works also in the non-orientable case, and it gives $c(M) \leq \max\{\|A\| + 5, 6\}$. From the definition of the norm $\|A\|$ in [10] one easily gets $\|\begin{pmatrix} k & 1 \\ 1 & 0 \end{pmatrix}\| \leq k$ for $k > 0$, as required.

Finally, by Proposition A.1 proved in the Appendix, each of the two Seifert manifolds is the result of gluing $N = (D, (2, 1), (3, 1))$ to $T \tilde{\times} I$ with an appropriate map. A skeleton for N such that the marking θ contains a loop γ isotopic to the fiber is constructed in [2, Page 170] and also shown in Fig. 1-left: it has 4 vertices. A skeleton with 3 vertices of a marked $T \tilde{\times} I$ is shown in Fig. 1-right. The marking θ' contains two loops γ'_1, γ'_2 isotopic to the two distinct fibrations of $T \tilde{\times} I$. Therefore it is possible to assemble N and $T \tilde{\times} I$ sending γ either to γ'_1 or to γ'_2 , and the two assemblings give the two Seifert manifolds above. \square

We can finally prove Theorem 1.1.

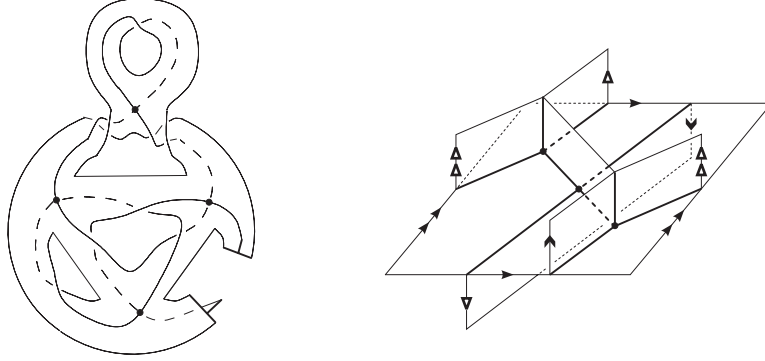

Figure 1: A skeleton for $(D, (2, 1), (3, 1))$ with 4 vertices (left) and one for $T \times I$ with 3 vertices (right).

Proof of 1.1. Let M be a closed non-orientable \mathbb{P}^2 -irreducible manifold. Then its orientable double cover \widetilde{M} is irreducible. Lemma 1.3 gives $c(\widetilde{M}) \leq 2c(M) - 5$. If $c(M) \leq 5$, we get $c(\widetilde{M}) \leq 10 - 5 = 5$, which is impossible by Proposition 1.4. If $c(M) = 6$, we get $c(\widetilde{M}) \leq 12 - 5 = 7$. By Proposition 1.4, the manifold M is either flat or a torus bundle with monodromy $\begin{pmatrix} 1 & 1 \\ 1 & 0 \end{pmatrix}$. Now, note that Lemma 1.3 does not guarantee the converse, namely that all such manifolds have $c = 6$. But Proposition 1.5 gives $c \leq 6$ on them, hence $c = 6$, as required.

If $c(M) = 7$, we get $c(\widetilde{M}) \leq 14 - 5 = 9$. By Proposition 1.4 (and by what said above), the manifold M is either a torus bundle with monodromy $\begin{pmatrix} 2 & 1 \\ 1 & 0 \end{pmatrix}$ or one of the two Seifert manifolds of type $\mathbb{H}^2 \times \mathbb{R}$. Again, each such manifold has $c \leq 7$ by Proposition 1.5, and we are done. \square

Errata We now fix two mistakes present in our previous paper [2]. First, it is stated there that closed non-orientable \mathbb{P}^2 -irreducible manifolds of complexity 6 are flat, because the torus bundle with monodromy $\begin{pmatrix} 1 & 1 \\ 1 & 0 \end{pmatrix}$ was not recognized as a Sol manifold in [2, Section 3, page 169]. Second, an example of closed non-orientable \mathbb{P}^2 -irreducible manifold M with complexity 7 having non-trivial JSJ is shown in [2, Section 3, page 170]. It would consist of two Seifert blocks, one being the non-orientable I -bundle $T \times I$ over T . As shown in Proposition A.1 here, every gluing of $T \times I$ with a Seifert manifold is itself Seifert. Therefore the JSJ of M is indeed trivial (actually, M is one of the two manifolds of type $\mathbb{H}^2 \times \mathbb{R}$ having $c = 7$).

2 Stiefel-Whitney surfaces

This section is devoted to the proof of Lemma 1.3. We start with some preliminary results.

Stiefel-Whitney surfaces A closed non-orientable manifold M has a non-trivial first Stiefel-Whitney class $w_1 \in H^1(M; \mathbb{Z}/2\mathbb{Z})$. A surface $\Sigma \subset M$ which is Poincaré dual to w_1 is usually called a *Stiefel-Whitney surface* [6]. It has odd intersection with a transverse loop γ if and only if γ is orientation-reversing. It is easy to prove that Σ is orientable. Note that there are infinitely many non-isotopic Stiefel-Whitney surfaces in M .

We will now show that, fixed a special spine P of M , there is exactly one Stiefel-Whitney surface contained in P . The embedding $P \subset M$ induces an isomorphism $H_2(P; \mathbb{Z}/2\mathbb{Z}) \cong H_2(M; \mathbb{Z}/2\mathbb{Z})$. Using cellular homology, a representative for a cycle in $H_2(P; \mathbb{Z}/2\mathbb{Z})$ is a subpolyhedron consisting of some faces, an even number of them (whence 0 or 2) incident to each edge of P . Such a subpolyhedron is a surface near the edges it contains, and it is also a surface near the vertices (because the link of a vertex does not contain two disjoint circles). Thus every $\mathbb{Z}/2\mathbb{Z}$ -homology class is represented by a unique surface in P : in particular there is a unique Stiefel-Whitney surface $\Sigma(P)$ inside P .

Remark 2.1. Let P be a special spine of a non-orientable closed M , and $\Sigma = \Sigma(P)$ be the Stiefel-Whitney surface contained in P . Let $\tilde{\Sigma} \subset \tilde{P} \subset \tilde{M}$ be the pre-images of $\Sigma \subset P \subset M$ in the orientable double-cover \tilde{M} . Both Σ and $\tilde{\Sigma}$ are orientable. Here $\tilde{M} \setminus \tilde{P}$ consists of two balls, and $\tilde{\Sigma}$ consists precisely of all faces of \tilde{P} that are adjacent to both these balls. Making a hole on one face contained in $\tilde{\Sigma}$ one gets a \tilde{P}' whose complement in \tilde{M} is a single ball, *i.e.* a simple spine of \tilde{M} .

By Remark 2.1, if P is a minimal spine of M with v vertices, there is a spine \tilde{P}' for \tilde{M} with $2v$ vertices. This gives $c(\tilde{M}) \leq M$. But \tilde{P}' has a hole in a face $F \subset \tilde{\Sigma}$, which can be enlarged with a collapse, eventually deleting the whole F and killing all the vertices adjacent to F . The number of such vertices killed depends on the choice of F in $\tilde{\Sigma}$. The rest of this section is devoted to the proof that there is one face $F \subset \tilde{\Sigma}$ incident to at least 5 distinct vertices. Using such an F , we get a simple spine for \tilde{M} with $2v - 5$ vertices at most, hence proving Lemma 1.3.

Length of a face Let F be a face of a special spine P . We denote by $\text{lgh}(F)$ the number of vertices of P adjacent to F , counted with multiplicity.

Lemma 2.2. *Let P be a special spine of a closed non-orientable \mathbb{P}^2 -irreducible M . Let $\tilde{\Sigma}$ and \tilde{P} be the pre-images of $\Sigma = \Sigma(P)$ and P in \tilde{M} . There exists a face $F \subset \tilde{\Sigma}$ with $\text{lgh}(F) \geq 5$.*

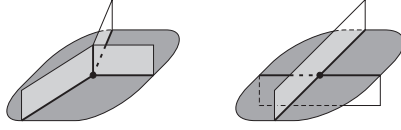

Figure 2: The spine \tilde{P} near a 3-valent (left) and a 4-valent (right) vertex of $S(\tilde{P}) \cap \tilde{\Sigma}$.

Proof. The average value of $\text{lgh}(F)$ on the faces in $\tilde{\Sigma}$ is s/f , where f is the number of faces of \tilde{P} contained in $\tilde{\Sigma}$ and $s = \sum_{F \subset \tilde{\Sigma}} \text{lgh}(F)$. We prove that $s/f > 4$, thus getting a face F with $\text{lgh}(F) \geq 5$. Let n_3 be the number of pairs of 3-valent vertices of $\tilde{G} = S(\tilde{P}) \cap \tilde{\Sigma}$ and n_4 be the number of 4-valent ones. The graph \tilde{G} has $2n_3 + n_4$ vertices and $\frac{3(2n_3) + 4n_4}{2} = 3n_3 + 2n_4$ edges, so $\chi(\tilde{\Sigma}) = (2n_3 + n_4) - (3n_3 + 2n_4) + f$. Hence f is equal to $\chi(\tilde{\Sigma}) + n_3 + n_4$. Moreover, the sum s is equal to $6n_3 + 4n_4$, so the average value s/f is

$$\frac{s}{f} = \frac{6n_3 + 4n_4}{\chi(\tilde{\Sigma}) + n_3 + n_4}.$$

Now, Σ is orientable and non-separating (because $M \setminus P$ is a ball), and M is \mathbb{P}^2 -irreducible, so we get $\chi(\tilde{\Sigma}) = 2\chi(\Sigma) \leq 0$. Therefore, we have $s/f \geq 4$, with $s/f = 4$ if and only if $\chi(\tilde{\Sigma}) = 0$ and $n_3 = 0$. But in the last case $\tilde{\Sigma}$ would be a torus, and \tilde{P} would be the union of a torus with two discs, hence \tilde{M} would have genus ≤ 1 . This gives a contradiction, since both \tilde{M} and M would be elliptic or of type $\mathbb{S}^2 \times \mathbb{R}$. \square

The polyhedron \tilde{P} near $\tilde{\Sigma}$ Let P be a minimal spine of a closed non-orientable \mathbb{P}^2 -irreducible M . Lemma 2.2 guarantees the existence of a face of length at least 5 in the pre-image $\tilde{\Sigma}$ of $\Sigma(P)$. Unfortunately, such a face might not be embedded, and hence might be incident to less than 5 vertices.

We now study the properties of non-embedded faces in $\tilde{\Sigma}$. To do that, we need to draw the spine \tilde{P} near the surface $\tilde{\Sigma}$. The graph $\tilde{G} = S(\tilde{P}) \cap \tilde{\Sigma}$ has vertices with valence 3 and 4, and \tilde{P} appears near them as shown in Fig. 2. By Remark 2.1, the surface $\tilde{\Sigma}$ is orientable, then we can choose a transverse orientation and give each edge e of \tilde{G} a black or grey color, depending on whether \tilde{P} locally lies on the positive or on the negative side of $\tilde{\Sigma}$ near e . A 3-valent vertex is adjacent to edges with the same color, and a 4-valent vertex is adjacent to two opposite grey edges and two opposite black ones. Now, the regular neighborhood $\mathcal{N}(\tilde{G})$ of \tilde{G} in \tilde{P} can be immersed into \mathbb{R}^3 so that $\tilde{\Sigma} \cap \mathcal{N}(\tilde{G})$ is “horizontal”. The polyhedron $\mathcal{N}(\tilde{G})$ is determined unambiguously by that immersed graph and also the regular neighborhood $\mathcal{N}(\tilde{\Sigma})$ of $\tilde{\Sigma}$ in \tilde{P} is, because it is obtained from $\mathcal{N}(\tilde{G})$ by adding discs

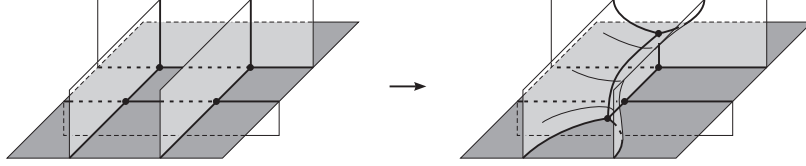

Figure 3: A move contradicting the assumption that the number of vertices of P contained in Σ is minimal.

to the “horizontal” S^1 's in the boundary of $\mathcal{N}(\tilde{G})$.

Lemma 2.3. *Let P be a minimal spine of a closed non-orientable \mathbb{P}^2 -irreducible M . Then each edge in $G = S(P) \cap \Sigma$ and $\tilde{G} = S(\tilde{P}) \cap \tilde{\Sigma}$ has different endpoints.*

Proof. Suppose that there exists an edge e of G joining a vertex v of P to itself. The closure \bar{e} of e is then a loop in Σ . We prove that \bar{e} bounds an embedded disc $D \subset P$ with $\text{lgh}(D) = 1$, which is absurd because P is minimal [12]. If v is 4-valent and the two germs of e near v are opposite, the disc D lies in $P \setminus \Sigma$. If not, the two germs are “consecutive” near v . Since Σ is orientable, the neighborhood of \bar{e} in Σ is an annulus, hence \bar{e} bounds a disc $D \subset \Sigma$. The same result for \tilde{G} follows. \square

Lemma 2.4. *Let P be a minimal spine of a closed non-orientable \mathbb{P}^2 -irreducible M . There is no embedded face F of P with $\partial F \subset \tilde{\Sigma}$ and $\text{lgh}(F) \leq 3$. If moreover $\Sigma(P)$ contains the minimum number of vertices (among minimal spines P of M), then there is no embedded square $F \subset \tilde{\Sigma} \subset \tilde{P}$ with the following shape:*

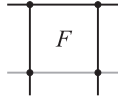

Proof. By Lemma 2.3, two consecutive vertices in $\partial F \subset \tilde{\Sigma}$ project to two distinct vertices in Σ . Therefore, if $\text{lgh}(F) \leq 3$ all vertices of ∂F project to distinct vertices of P , hence F projects to an embedded face with $\text{lgh} \leq 3$, in contrast to minimality of P [12]. Suppose now F is a square as above. Opposite vertices of ∂F have distinct valency, hence they project to distinct vertices of Σ . Therefore, the projection of F is an embedded square in Σ , and the move shown in Fig. 3 transforms P into another minimal P' , but with $\Sigma(P')$ containing one vertex less than $\Sigma(P)$, a contradiction. \square

Lemma 2.5. *Let P be a minimal spine of a closed non-orientable \mathbb{P}^2 -irreducible M . Then each face $F \subset \tilde{\Sigma} \subset \tilde{P}$ is not incident twice to an edge of $\tilde{G} = S(\tilde{P}) \cap \tilde{\Sigma}$.*

Proof. Suppose by contradiction that there is a face $F \subset \tilde{\Sigma} \subset \tilde{P}$ incident twice to an edge e of \tilde{G} . Inside the closure of F , there is a loop λ intersecting $S(\tilde{P})$ transversely in one point of e . The regular neighborhood of λ in $\tilde{\Sigma}$ is transversely orientable (because $\tilde{\Sigma}$ is orientable), hence λ bounds a disc D in $\tilde{M} \setminus \tilde{P}$ and intersects $S(\tilde{P})$ transversely in 1 point. If we project λ to Σ , we get a loop λ which bounds a disc (the projection of D) in $M \setminus P$ and intersects $S(P)$ transversely in 1 point: this contradicts the minimality of P [12]. \square

We can finally prove Lemma 1.3.

Proof of 1.3. Let P be a minimal spine of M , such that $\Sigma = \Sigma(P)$ contains the minimum possible number of vertices (among minimal spines of M). Let $\tilde{\Sigma} \subset \tilde{P} \subset \tilde{M}$ be the pre-images of $\Sigma \subset P \subset M$. By what said in Remark 2.1 and below, if we prove that $\tilde{\Sigma}$ contains a face incident to 5 *distinct* vertices at least we are done. Let F be a face of P contained in $\tilde{\Sigma}$ such that $\text{lgh}(F)$ is maximal. By Lemma 2.2, we have $\text{lgh}(F) \geq 5$. If F is embedded, we are done. If instead F is not embedded, we will show that there are only a finite (small) number of configurations of $\tilde{\Sigma}$ near F , and for each case we will find a face incident to 5 distinct vertices in $\tilde{\Sigma}$ (or get a contradiction).

So, from now on, we can suppose F is not embedded. As we said above, if F is incident to at least 5 *distinct* vertices, we are done. So we are left to deal with the case where F is incident to at most 4 distinct vertices. By Lemma 2.5, F cannot be incident twice to an edge of the graph $\tilde{G} = S(\tilde{P}) \cap \tilde{\Sigma}$, so F can be incident only once to a 3-valent vertex and either once or twice to a 4-valent one of \tilde{G} . Since F is not embedded, it is incident twice to at least one 4-valent vertex. We conclude the proof with a case-by-case argument.

If $\text{lgh}(F) \geq 9$, since F is incident to each vertex at most twice, our F would be incident to 5 different vertices of \tilde{P} , a contradiction. If instead $\text{lgh}(F) = 8$, our F is incident to 4 different 4-valent vertices twice, so $S(\tilde{P}) = \tilde{G} = \partial F$ (because $S(\tilde{P})$ is connected) and \tilde{P} has 4 vertices, hence \tilde{M} is elliptic [12, 16], a contradiction.

If $\text{lgh}(F) = 7$, our F is incident to 4 different vertices: twice to 3 of them (which are 4-valent), and once to another one. If we consider the unfolded version of F , we have a heptagon with six vertices identified in pairs. Up to symmetry, there are 4 different configurations for the pairing of the vertices adjacent to F (recall that Lemma 2.3 forbids edges in ∂F with coinciding endpoints). They are shown in Fig. 4. As we have done above, the black or grey color given to each edge depends on whether \tilde{P} locally lies on the positive or on the negative side of $\tilde{\Sigma}$ near the edge. Recall that all the v_i 's are 4-valent, so the two consecutive edges going out from a v_i have different colors. In each case, using orientability of $\tilde{\Sigma}$, one finds two edges in the boundary of the unfolded version of F that map to the same edge of \tilde{P} , contradicting Lemma 2.5.

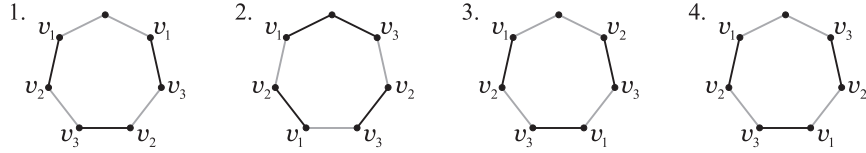

Figure 4: The four different configurations for the pairing of the vertices adjacent to F , if $\text{lgh}(F) = 7$.

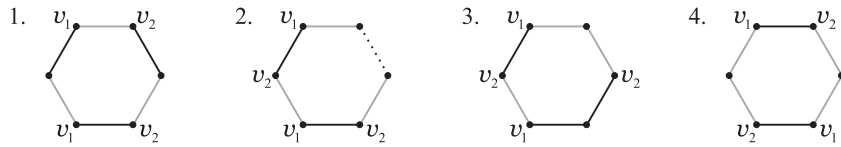

Figure 5: Four different configurations when $\text{lgh}(F) = 6$.

Now, we consider the case where $\text{lgh}(F) = 6$. As above, if F is incident to 3 different 4-valent vertices twice, we have that $S(\tilde{P}) = \partial F$ (because $S(\tilde{P})$ is connected) and \tilde{P} has 3 vertices, hence \tilde{M} is elliptic: a contradiction. So, if we consider the unfolded version of F , we have a hexagon with four vertices identified in pairs (recall that F is incident to at most 4 distinct vertices). Using Lemmas 2.3 and 2.5 as above, we end up with 4 possible configurations, shown in Fig. 5. The corresponding portions of \tilde{G} adjacent to F are shown in Fig. 6. Each case is forbidden: let us show why. Cases 1, 2, and 4 lead to an embedded face F' with $\text{lgh}(F') = 2$, bounded by the loop $l_1 \cup l_2$ (where $F' \subset \tilde{\Sigma}$ in case 1, and $F' \not\subset \tilde{\Sigma}$ in cases 2 and 4), in contrast with Lemma 2.4. Concerning Case 3, the edges l' and l'' are different, hence one of the two faces incident to l' is incident to 5 different vertices (namely v_1, v_2, v', v'' , and the other endpoint of l'), so we are done.

Finally, we consider the case where $\text{lgh}(F) = 5$. The unfolded version of F is a pentagon with two or four vertices identified in pairs, and using Lemmas 2.3 and 2.5 we restrict ourselves to the two configurations drawn in Fig. 7, yielding the two cases shown in Fig. 8. Case 1 leads to an embedded face F' (bounded by the loop $l_1 \cup l_2$ and non-contained in $\tilde{\Sigma}$) with $\text{lgh}(F') = 2$, in contrast with Lemma 2.4. Case 2 is slightly more complicated. Consider the face F' shown in Fig. 8-right. If two of the three l^* 's coincide, we are done: in fact, either F' is incident to 5 distinct vertices, or $\text{lgh}(F') > 5$ (but $\text{lgh}(F)$ is maximal), or F' is an embedded triangle (contradicting Lemma 2.4), see Fig. 9. If instead the three l^* 's are different, either F' is incident to 5 distinct vertices or it is a square as in Fig. 10. But such a square is excluded

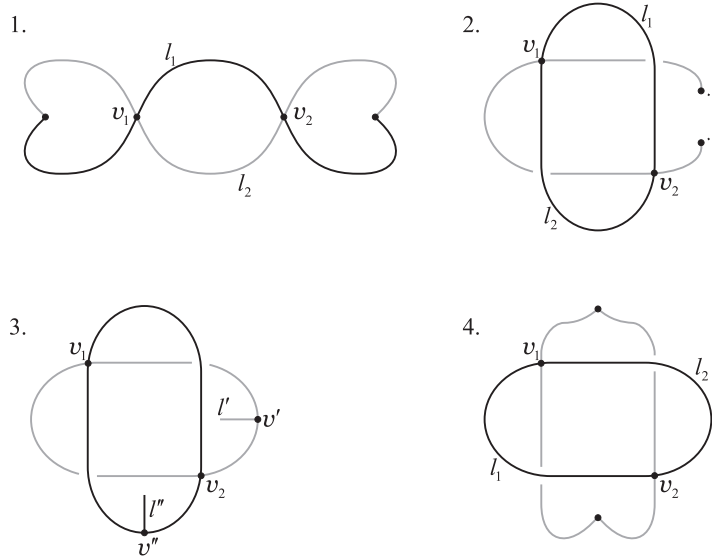

Figure 6: The four cases for \tilde{G} if $\text{lgh}(F) = 6$.

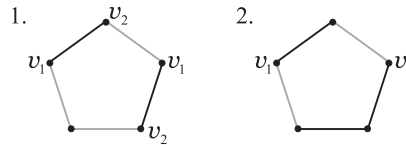

Figure 7: Two configurations when $\text{lgh}(F) = 5$. In case 1 four vertices are identified in pairs, while in case 2 only two vertices are identified together.

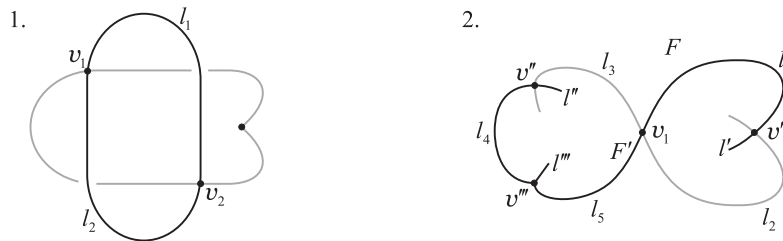

Figure 8: The two cases if $\text{lgh}(F) = 5$.

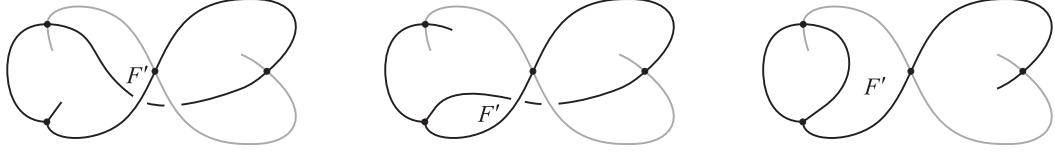

Figure 9: The three configurations of \tilde{G} if two of the three l^* 's coincide, when $\text{lgh}(F) = 5$.

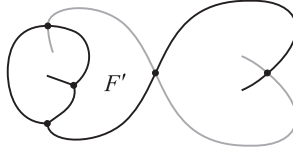

Figure 10: The (forbidden) configuration of \tilde{G} if $\text{lgh}(F') = 4$.

by Lemma 2.4, and we are done. □

A On I -bundles over tori and Klein bottles

Set $I = [-1, 1]$. In this appendix, we classify the I -bundles over the torus T and the Klein bottle K . We denote by D , A , and S respectively the disc, the annulus, and the Möbius strip. Recall that there are two S^1 -bundles $A \times S^1$ and $A \tilde{\times} S^1$ over A , and analogously two S^1 -bundles $S \times S^1$ and $S \tilde{\times} S^1$ over S . We denote by \bar{A} the annulus with one mirror boundary and by \dot{D} , \ddot{D} respectively the disc with one or two mirror segments in its boundary. Therefore each \bar{A} and \dot{D} has one true boundary component, while \ddot{D} has two. By mirroring one boundary component of $A \times S^1$ or $A \tilde{\times} S^1$ we get the two Seifert manifolds over the orbifold \bar{A} (we denote them by $\bar{A} \times S^1$ and $\bar{A} \tilde{\times} S^1$). Moreover, there is only one Seifert manifold over the orbifold \ddot{D} : we denote it by $\ddot{D} \times S^1$.

Proposition A.1. *There are, up to homeomorphism, two I -bundles $T \times I$ and $T \tilde{\times} I$ over T , and three I -bundles $K \times I$, $K \tilde{\times} I$, $K \tilde{\tilde{\times}} I$ over K . We have $\partial(T \tilde{\times} I) \cong T$, $\partial(K \tilde{\times} I) \cong T$, and $\partial(K \tilde{\tilde{\times}} I) \cong K$. They have the following Seifert fibrations:*

- $T \times I$ fibers as $A \times S^1$,
- $T \tilde{\times} I$ fibers as $S \times S^1$ and as $\bar{A} \times S^1$,

- $K \times I$ fibers as $A \times S^1$ and as $\bar{D} \times S^1$,
- $K \times I$ fibers as $S \times S^1$ and as $(D, (2, 1), (2, 1))$,
- $K \times I$ fibers as $\bar{A} \times S^1$ and as $(\bar{D}, (2, 1))$.

If M is an I -bundle over K or T different from $K \times I$, every fibration of one component of ∂M extends to a Seifert fibration of M .

Proof. The set of I -bundles over a closed surface X up to fiber-preserving homeomorphisms is in 1-1 correspondence with the orbits of $H^1(X; \mathbb{Z}/2\mathbb{Z})$ under the action of the mapping class group of X . If $X = T$, we have $H^1(T; \mathbb{Z}/2\mathbb{Z}) = \mathbb{Z}/2\mathbb{Z} \times \mathbb{Z}/2\mathbb{Z}$, and using Dehn twists one sees that there are two orbits $\{(0, 0)\}$ and $\{(1, 0), (0, 1), (1, 1)\}$, giving respectively the product $T \times I$ and a non-orientable I -bundle, which we denote by $T \times I$. If $X = K$, we have $H_1(K; \mathbb{Z}) = \langle a, b \mid a + b = b + a, 2a = 0 \rangle = \mathbb{Z}/2\mathbb{Z} \times \mathbb{Z}$ and $H^1(K; \mathbb{Z}/2\mathbb{Z}) = \text{Hom}(\mathbb{Z}/2\mathbb{Z} \times \mathbb{Z}, \mathbb{Z}/2\mathbb{Z}) = \mathbb{Z}/2\mathbb{Z} \times \mathbb{Z}/2\mathbb{Z}$ again. The mapping class group of K is homeomorphic to $\mathbb{Z}/2\mathbb{Z} \times \mathbb{Z}/2\mathbb{Z}$ and is generated by two automorphisms ϕ and ψ whose action on $H_1(K, \mathbb{Z})$ is given by

$$\phi(a) = a, \quad \phi(b) = -b \quad \text{and} \quad \psi(a) = a, \quad \psi(b) = a + b.$$

(See the Appendix of [9] for a proof of this fact.) Therefore the orbits on $H^1(K; \mathbb{Z}/2\mathbb{Z})$ are $\{(0, 0)\}$, $\{(0, 1)\}$, and $\{(1, 0), (1, 1)\}$, giving respectively the (non-orientable) product $K \times I$, the orientable $K \times I$, and another non-orientable manifold which we denote by $K \times I$.

Each such I -bundle can be described as a cube I^3 with the opposite lateral faces appropriately identified, so that the horizontal $I^2 \times \{0\}$ closes up to the zero-section. The Seifert fibrations are then quotients of the two fibrations of I^3 given by $I \times \{p\} \times \{q\}$ and $\{p\} \times I \times \{q\}$. We leave the details as an exercise for the reader.

Finally, let N be an I -bundle, and let a component of ∂N be fibered. If N is a product, the fibration extends trivially. If $N = K \times I$, the boundary $\partial N \cong K$ admits only two non-isotopic fibrations, each of which extends to one of the two Seifert fibrations of N . If $N = T \times I$, let T_0 be the zero-section. Fix generators (μ, λ) for $H_1(T_0; \mathbb{Z})$ so that the I -bundle is determined by $\alpha \in H^1(T_0; \mathbb{Z}/2\mathbb{Z})$ with $\alpha(\mu) = 1$, $\alpha(\lambda) = 0$. Take also generators (μ', λ') for $H_1(\partial N; \mathbb{Z})$ which project to $(2\mu, \lambda)$. With respect to these generators, every $\begin{pmatrix} m & n \\ p & q \end{pmatrix} \in \text{GL}_2(\mathbb{Z})$ with even n gives an automorphism of T_0 that extends to an automorphism of N , acting as $\begin{pmatrix} m & n/2 \\ 2p & q \end{pmatrix}$ on ∂N . Via such automorphisms, an element of $H_1(\partial N; \mathbb{Z})$ is equivalent to either μ' or λ' . Therefore, every given fibration of ∂N is equivalent to one of the two fibrations induced by the two Seifert fibrations described above. \square

The following corollary says that the two “strange” I -bundles $T \times I$ and $K \times I$ do not occur near a Seifert block.

Corollary A.2. *Let M be a closed \mathbb{P}^2 -irreducible manifold, and let X be a K or a T of the geometric decomposition of M . If X is adjacent to a Seifert block, its regular neighborhood is either a product or $K \times I$.*

Proof. The neighborhood is an I -bundle N over X . By Proposition A.1, if N is not a product or $K \times I$, then ∂N is connected and the fibration of the adjacent Seifert block extends to N , a contradiction. \square

Corollary A.3. *Let M be a closed \mathbb{P}^2 -irreducible manifold with non-trivial geometric decomposition. Every Seifert block has hyperbolic base orbifold and finite volume.*

Proof. Suppose a Seifert block has $\chi^{\text{orb}} \geq 0$. If $\chi^{\text{orb}} > 0$, the base orbifold is either D with one cone point at most, or \dot{D} . In those cases, the block is the solid torus or the solid Klein bottle, which is impossible. If instead $\chi^{\text{orb}} = 0$, the base orbifold is one of $A, \bar{A}, S, \bar{D}, \dot{D}$ with one point with cone angle π , or D with two points with cone angle π . There are two distinct Seifert fibrations over the orbifolds A, \bar{A} , and S , and one fibration over the other ones. By Proposition A.1, the total space of every such fibration is homeomorphic to an I -bundle over K or T . But no such block can occur in a geometric decomposition. Finally, note that the only blocks of the JSJ decomposition with infinite volumes are flat. \square

The following fact is not true for JSJ decompositions.

Corollary A.4. *Let $\widetilde{M} \rightarrow M$ be a finite covering of closed \mathbb{P}^2 -irreducible manifolds. The pre-image of the geometric decomposition of M is the geometric decomposition of \widetilde{M} .*

Proof. A Seifert manifold with $\chi^{\text{orb}} < 0$ has a unique fibration [15]. Therefore, using Corollary A.3, we get that a non-trivial decomposition is geometric if and only if every Seifert block has $\chi^{\text{orb}} < 0$ and the fibrations do not extend to any K or T . Both conditions lift from M to \widetilde{M} , hence we are done. \square

Corollary A.5. *Let M be a non-orientable closed \mathbb{P}^2 -irreducible manifold, whose geometric decomposition is made of Seifert blocks. The geometric decomposition of M contains an even number of K 's.*

Proof. By Corollary A.2, the neighborhood of a K in the geometric decomposition of M is either homeomorphic to $K \times I$ or to the orientable $K \times I$, giving rise respectively to one T or two K 's in the decomposition of \widetilde{M} . \square

The following result is needed in the proof of Proposition 1.4.

Corollary A.6. *A non-orientable manifold of Sol geometry is a torus bundle over S^1 , with some monodromy $A \in \mathrm{GL}_2(\mathbb{Z})$ with $\det A = -1$. Two such manifolds with monodromies A, A' such that $|\mathrm{tr} A| = |\mathrm{tr} A'| \in \{1, 2\}$ are homeomorphic.*

Proof. A manifold M of Sol geometry fibers over a 1-orbifold, with T 's and K 's as fibers. If the 1-orbifold is a segment (with two reflector endpoints), then M is the gluing of two I -bundles over T or K along their connected boundaries. Since M is non-orientable, one I -bundle is either $T \times I$ or $K \times I$, but in both cases M is Seifert by Proposition A.1, a contradiction. If instead the 1-orbifold is S^1 , then M is a (T or K)-bundle over S^1 . But K -bundles over S^1 are flat [14], hence it is a T -bundle, as required.

Suppose now we have two non-orientable manifolds with monodromies A and A' with $|\mathrm{tr} A| = |\mathrm{tr} A'| \in \{1, 2\}$. When $\det = -1$, we have $\begin{pmatrix} a & b \\ c & d \end{pmatrix}^{-1} = \begin{pmatrix} -d & b \\ c & -a \end{pmatrix}$. Therefore we can suppose $\mathrm{tr} A = \mathrm{tr} A' \in \{1, 2\}$. Taking $B \in \left\{ \begin{pmatrix} 1 & 0 \\ \pm 1 & 1 \end{pmatrix}, \begin{pmatrix} 1 & \pm 1 \\ 0 & 1 \end{pmatrix} \right\}$ one sees that $B^{-1} \begin{pmatrix} a & b \\ c & d \end{pmatrix} B \in \left\{ \begin{pmatrix} a \pm b & b \\ * & d \mp b \end{pmatrix}, \begin{pmatrix} a \mp c & * \\ c & d \pm c \end{pmatrix} \right\}$. Using this, we can suppose both A and A' have non-negative entries in the diagonal. Therefore, if $\mathrm{tr} A = 1$ we get one 0 entry in the diagonal and we easily get $A \sim A'$, whereas if $\mathrm{tr} A = 2$ we either get one 0 entry in the diagonal or $\begin{pmatrix} 1 & 1 \\ 2 & 1 \end{pmatrix}$, which is also easily transformed into one having a 0 entry in the diagonal. In both cases we get $A \sim A'$ and we are done. \square

B On manifolds of type $\mathbb{H}^2 \times \mathbb{R}$

We prove here the following result.

Proposition B.1. *The two closed manifolds of type $\mathbb{H}^2 \times \mathbb{R}$ with smallest base orbifold are*

$$(\mathbb{RP}^2, (2, 1), (3, 1)) \quad \text{and} \quad (\bar{D}, (2, 1), (3, 1)).$$

Their base orbifold has volume $\pi/3$.

Proof. The two manifolds above have $\chi^{\mathrm{orb}} = -\frac{1}{6}$, hence volume $\frac{2\pi}{6} = \frac{\pi}{3}$. We want to prove that every other manifold M of type $\mathbb{H}^2 \times \mathbb{R}$ has $\chi^{\mathrm{orb}} < -\frac{1}{6}$, so let us suppose by contradiction that M is a manifold of type $\mathbb{H}^2 \times \mathbb{R}$ with $\chi^{\mathrm{orb}} \geq -\frac{1}{6}$.

Let us first consider the case where the base orbifold of M is S^2 with some k points with cone angles $\frac{2\pi}{p_1}, \dots, \frac{2\pi}{p_k}$. Since $\chi^{\mathrm{orb}} = 2 - \sum(1 - \frac{1}{p_i}) < 0$, we have $k \geq 3$. Suppose $k = 3$. Then $\chi^{\mathrm{orb}} = 2 - \sum(1 - \frac{1}{p_i}) = \sum \frac{1}{p_i} - 1$. By our hypothesis $0 > \sum \frac{1}{p_i} - 1 \geq -\frac{1}{6}$, hence

$$(p_1, p_2, p_3) \in \{(2, 3, h) \mid h \geq 7\} \cup \{(3, 3, k) \mid 4 \leq k \leq 6\} \cup \{(2, 4, l) \mid 5 \leq l \leq 12\}.$$

We have that (the orientable) M is $(S^2, (p_1, q_1), (p_2, q_2), (p_3, q_3))$, with Euler number $e = \sum_i \frac{q_i}{p_i} = 0$. Therefore we get $q_1 p_2 p_3 + q_2 p_3 p_1 + q_3 p_1 p_2 = 0$, hence $p_i | p_{i+1} p_{i+2}$ cyclically for $i = 1, 2, 3$. The only triple (p_1, p_2, p_3) fulfilling this requirement is $(2, 4, 8)$. But q_3 is odd, hence $4q_1 + 2q_2 + q_3 \neq 0$ gives $e \neq 0$ in that case: a contradiction.

If $k = 4$, we have $\chi^{\text{orb}} = \sum \frac{1}{p_i} - 2$, hence $0 > \sum \frac{1}{p_i} - 2 \geq -\frac{1}{6}$. Therefore $(p_1, p_2, p_3, p_4) = (2, 2, 2, 3)$. Then $M = (S^2, (2, 1), (2, 1), (2, 1), (3, q))$ giving $e \neq 0$ again. If $k \geq 5$, then $\chi^{\text{orb}} \leq 2 - \frac{5}{2} = -\frac{1}{2}$, and we are done.

If the orbifold is $\mathbb{R}P^2$ or \bar{D} with some k points with cone angles $\frac{2\pi}{p_1}, \dots, \frac{2\pi}{p_k}$, we have $\chi^{\text{orb}} = 1 - \sum (1 - \frac{1}{p_i})$. Since $0 > \chi^{\text{orb}} \geq -\frac{1}{6}$, we get $k = 2$ and $(p_1, p_2) = (2, 3)$, hence M is one of the two listed above. Finally, if the surface underlying the base orbifold has $\chi \leq 0$, we get $\chi^{\text{orb}} \leq -\frac{1}{2}$. \square

References

- [1] C. ADAMS, *The non-compact hyperbolic 3-manifold of minimal volume*, Proc. Amer. Math. Soc. **100** (1987), 601-606.
- [2] G. AMENDOLA – B. MARTELLI, *Non-orientable 3-manifolds of small complexity*, Topology Appl. **133** (2003), 157-178.
- [3] B. BURTON, *Structures of small closed non-orientable 3-manifold triangulations*, Math.GT/0311113,
- [4] ———, *Regina (normal surface and 3-manifold topology software)*, available from <http://regina.sourceforge.net>
- [5] P. J. CALLAHAN – M. V. HILDEBRAND – J. R. WEEKS, *A census of cusped hyperbolic 3-manifolds*. Mathematics of Computation **68** (1999), 321-332.
- [6] J. C. GÓMEZ-LARRAÑAGA – W. HEIL – V. NÚÑEZ, *Stiefel-Whitney surfaces and decompositions of 3-manifolds into handlebodies*, Topology Appl. **60** (1995), 267-280.
- [7] C. D. HODGSON – J. R. WEEKS, *Symmetries, isometries and length spectra of closed hyperbolic three-manifolds*, Experiment. Math. **3** (1994), 261-274.
- [8] B. MARTELLI – C. PETRONIO, *Three-manifolds having complexity at most 9*, Experiment. Math. **10** (2001), 207-237.
- [9] ———, *A new decomposition theorem for 3-manifolds*, Illinois J. Math. **46** (2002), no. 3, 755–780.
- [10] ———, *Complexity of geometric 3-manifolds*, Math.GT/0303249, to appear in Geom. Dedicata

- [11] S. V. MATVEEV, *The theory of the complexity of three-dimensional manifolds*, Akad. Nauk Ukrain. SSR Inst. Mat. Preprint, **13** (1988), 32 pp.
- [12] ———, *Complexity theory of three-dimensional manifolds*, Acta Appl. Math. **19** (1990), 101-130.
- [13] W. D. NEUMANN – F. RAYMOND, *Seifert manifolds, plumbing, μ -invariant and orientation reversing maps*, Algebraic and geometric topology (Proc., Santa Barbara, 1977), Lecture Notes in Math., vol. 664, Springer, Berlin, 1978, pp. 163–196.
- [14] P. ORLIK, *Seifert manifolds*, vol. 291, Springer-Verlag, Berlin, 1972, Lecture Notes in Mathematics.
- [15] P. SCOTT, *The geometries of 3-manifolds*, Bull. London Math. Soc. **15** (1983), 401-487.
- [16] <http://www.dm.unipi.it/~pages/petronio/>

Dipartimento di Matematica
Università di Pisa
Via F. Buonarroti 2
56127 Pisa, Italy
amendola@mail.dm.unipi.it
martelli@mail.dm.unipi.it