

All strongly-cyclic branched coverings of (1, 1)-knots are Dunwoody manifolds

Alessia Cattabriga Michele Mulazzani

Abstract

We show that every strongly-cyclic branched covering of a $(1, 1)$ -knot is a Dunwoody manifold. This result, together with the converse statement previously obtained by Grasselli and Mulazzani, proves that the class of Dunwoody manifolds coincides with the class of strongly-cyclic branched coverings of $(1, 1)$ -knots. As a consequence, we obtain a parametrization of $(1, 1)$ -knots by 4-tuples of integers. Moreover, using a representation of $(1, 1)$ -knots by the mapping class group of the twice punctured torus, we provide an algorithm which gives the parametrization of all torus knots in \mathbf{S}^3 .

Mathematics Subject Classification 2000: Primary 57M12, 57N10; Secondary 57M25.

Keywords: $(1, 1)$ -knots, cyclic branched coverings, Heegaard diagrams, Dunwoody manifolds, torus knots, cyclically presented groups.

1 Introduction

In order to investigate the relations between cyclic branched coverings of knots in \mathbf{S}^3 and manifolds admitting cyclically presented fundamental groups, M. J. Dunwoody introduced in [6] a class of 3-manifolds depending on six integer parameters. As proved in [7], all these manifolds turn out to be strongly-cyclic coverings of lens spaces (possibly \mathbf{S}^3), branched over $(1, 1)$ -knots. Moreover, it has been shown in [10] that every n -fold strongly-cyclic branched covering of a $(1, 1)$ -knot admits a genus n Heegaard diagram encoding a cyclic presentation for the fundamental group. This result has been improved in [3], obtaining a constructive algorithm which, starting from

a representation of $(1, 1)$ -knots through the elements of the mapping class group of the twice punctured torus, explicitly gives the cyclic presentations.

In this paper we prove that all strongly-cyclic branched coverings of $(1, 1)$ -knots are actually Dunwoody manifolds. As a consequence, the class of Dunwoody manifolds coincides with the class of strongly-cyclic branched coverings of $(1, 1)$ -knots.

We also obtain, as a further consequence, a parametrization of all $(1, 1)$ -knots (with the exception of the “core” knot $\{P\} \times \mathbf{S}^1 \subset \mathbf{S}^2 \times \mathbf{S}^1$, which admits no strongly-cyclic branched coverings) by means of four of the six Dunwoody parameters. Moreover, we give an algorithm that allows us to find the parametrization of all torus knots in \mathbf{S}^3 .

We refer to [9, 2] for details on knot theory and cyclic branched coverings of knots, and to [8] for details on cyclic presentations of groups.

2 Strongly-cyclic branched coverings of $(1, 1)$ -knots and Dunwoody manifolds

An n -fold cyclic covering of a 3-manifold N^3 branched over a knot $K \subset N^3$ is called *strongly-cyclic* if the branching index of K is n (i.e., the fiber of each point of K contains a single point). So the homology class of a meridian loop m around K is mapped by the associated monodromy $\omega : H_1(N^3 - K) \rightarrow \mathbb{Z}_n$ to a generator of \mathbb{Z}_n (up to equivalence we can always suppose $\omega[m] = 1$).

Observe that a cyclic branched covering of a knot K in \mathbf{S}^3 is always strongly-cyclic and uniquely determined, up to equivalence, since $H_1(\mathbf{S}^3 - K) \cong \mathbb{Z}$. Obviously, this property is no longer true for a knot in a more general 3-manifold. Also, if p is a prime number, any p -fold cyclic branched covering of a knot K is automatically strongly-cyclic.

In this paper we deal with strongly-cyclic branched coverings of $(1, 1)$ -knots, which are knots in lens spaces (possibly in \mathbf{S}^3).

A knot K in a 3-manifold N^3 is called a $(1, 1)$ -knot if there exists a Heegaard splitting of genus one

$$(N^3, K) = (H, A) \cup_{\varphi} (H', A'),$$

where H and H' are solid tori, $A \subset H$ and $A' \subset H'$ are properly embedded trivial arcs, and $\varphi : (\partial H', \partial A') \rightarrow (\partial H, \partial A)$ is an attaching homeomorphism (see Figure 1). Obviously, N^3 turns out to be a lens space $L(p, q)$ (including $\mathbf{S}^3 = L(1, 0)$).

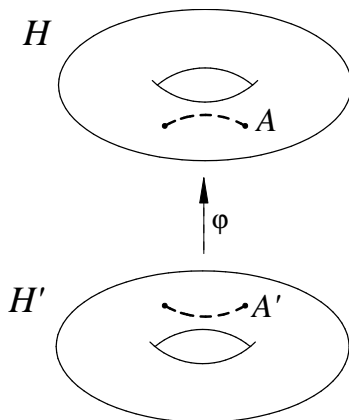

Figure 1: A $(1, 1)$ -decomposition.

It is well known that the family of $(1, 1)$ -knots contains all torus knots and all two-bridge knots in \mathbf{S}^3 . Several topological properties of $(1, 1)$ -knots have recently been investigated (see references in [4]).

Proposition 1. *A $(1, 1)$ -knot $K \subset L(p, q)$ with $(1, 1)$ -decomposition $(L(p, q), K) = (H, A) \cup_{\varphi} (H', A')$ is completely determined, up to equivalence, by $\varphi(\beta')$, where β' is the boundary of a meridian disk $D' \subset H'$ which does not intersect A' . Moreover, if $(L(p, q), \bar{K}) = (H, A) \cup_{\bar{\varphi}} (H', A')$ is a decomposition of a $(1, 1)$ -knot \bar{K} such that $\bar{\varphi}(\beta')$ is isotopic to $\varphi(\beta')$ in $\partial H - \partial A$, then \bar{K} is equivalent to K .*

Proof. The first statement follows from the fact that two properly embedded trivial arcs in a ball B , with the same endpoints, are isotopic rel ∂B . The second statement is straightforward. \square

An algebraic representation of $(1, 1)$ -knots has been developed in [3] and [4], where it is shown that there is a natural surjective map

$$\psi \in PMCG_2(\partial H) \mapsto K_{\psi} \in \mathcal{K}_{1,1}$$

from the pure mapping class group of the twice punctured torus $PMCG_2(\partial H)$ to the class $\mathcal{K}_{1,1}$ of all $(1, 1)$ -knots. Using this representation, the necessary and sufficient conditions for the existence and uniqueness of an n -fold strongly-cyclic branched covering of a $(1, 1)$ -knot have been obtained (see [3]).

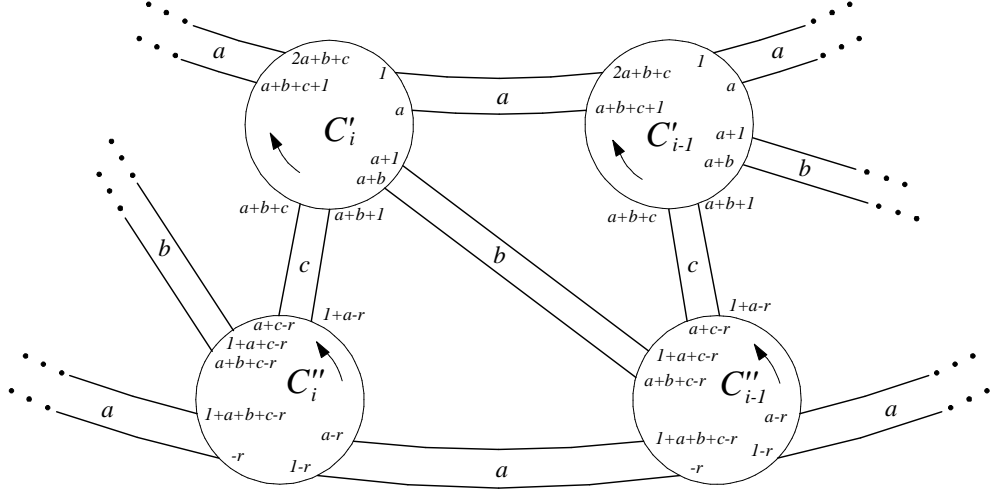

Figure 2: The diagram $D(a, b, c, n, r, s)$, for $a + b + c > 0$.

The family of Dunwoody manifolds has been introduced in [6] by a class of trivalent regular planar graphs (called *Dunwoody diagrams*), depending on six integers a, b, c, n, r, s , such that $n > 0$, $a, b, c \geq 0$. For certain values of the parameters, called *admissible*, the Dunwoody diagrams $D(a, b, c, n, r, s)$ turn out to be Heegaard diagrams, hence defining a wide class of closed, orientable 3-manifolds $M(a, b, c, n, r, s)$ with cyclically presented fundamental groups, called *Dunwoody manifolds*.

More precisely, an admissible Dunwoody diagram $D(a, b, c, n, r, s)$ is an open Heegaard diagram of genus n , with cyclic symmetry of order n . It contains n internal circles C'_1, \dots, C'_n , and n external circles C''_1, \dots, C''_n , each having $d = 2a + b + c$ vertices. These circles represent the first system of curves of the Heegaard splitting. If $d > 0$, as shown in Figure 2, the circle C'_i (resp. C''_i) is connected to the circle C'_{i+1} (resp. C''_{i+1}) by a parallel arcs, to the circle C''_i by c parallel arcs and to the circle C''_{i-1} by b parallel arcs, for every $i = 1, \dots, n$ (subscripts mod n). If $d = 0$ (i.e., $a = b = c = 0$), there are no arcs connecting the circles, and the diagram (called *trivial*) contains other n circles C_1, \dots, C_n , as depicted in Figure 3.

We denote by \mathcal{E} the set of arcs when $d > 0$, or the set of curves C_1, \dots, C_n when $d = 0$. Obviously, \mathcal{E} represents the second system of curves of the Heegaard splitting. To reconstruct the splitting, the circle C'_i must be glued to the circle C''_{i+s} , so that, when $d > 0$, equally labelled vertices are identified

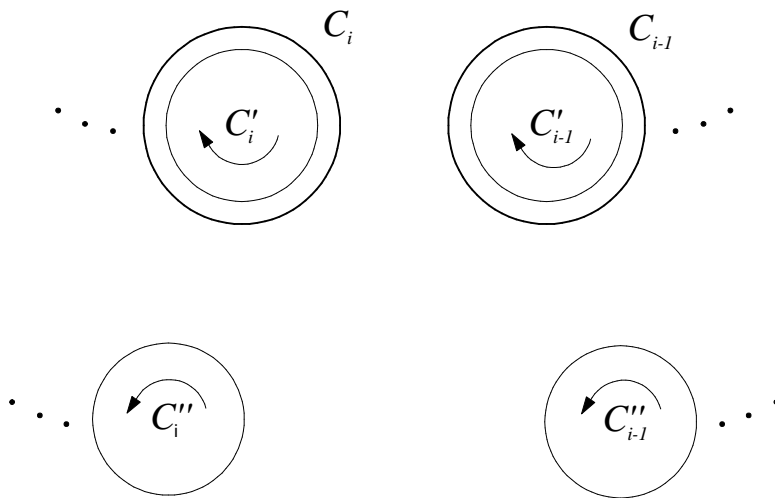

Figure 3: The diagram $D(0, 0, 0, n, r, s)$.

together. Observe that the parameters r and s can be considered mod d and n respectively, and we can suppose $r = 0$ when $d = 0$. Since the identification rule and the diagram are invariant with respect to an obvious cyclic action of order n , the Dunwoody manifold $M(a, b, c, r, n, s)$ admits a cyclic symmetry of order n . Of course, $M(a, b, c, 1, r, 0)$ is homeomorphic to a lens space or to \mathbf{S}^3 , since it admits a genus one Heegaard splitting. Moreover, the trivial case $M(0, 0, 0, n, 0, s)$ is homeomorphic to the connected sum of n copies of $\mathbf{S}^2 \times \mathbf{S}^1$, for all n and s .

A characterization of all Dunwoody manifolds as strongly-cyclic branched coverings of $(1, 1)$ -knots is given by the following result.

Proposition 2. [7] *The Dunwoody manifold $M(a, b, c, n, r, s)$ is the n -fold strongly-cyclic covering of the lens space $M(a, b, c, 1, r, 0)$ (possibly \mathbf{S}^3), branched over a $(1, 1)$ -knot only depending on the integers a, b, c, r .*

An interesting example of a Dunwoody manifold is $M(1, 1, 1, 3, 2, 1)$, which is homeomorphic to $\mathbf{S}^1 \times \mathbf{S}^1 \times \mathbf{S}^1$. It is well known that this manifold cannot be a cyclic branched covering of any knot in \mathbf{S}^3 , but turns out to be a 3-fold cyclic covering of $\mathbf{S}^2 \times \mathbf{S}^1 \cong M(1, 1, 1, 1, 2, 0)$, branched over a $(1, 1)$ -knot, which will be referred to as $K(1, 1, 1, 2)$.

In the next section we prove the converse of Proposition 2. As a consequence, the class of Dunwoody manifolds coincides with the class of strongly-

cyclic branched coverings of $(1, 1)$ -knots.

3 Main result

Now we establish the main result of this paper.

Theorem 3. *Every strongly-cyclic branched covering of a $(1, 1)$ -knot is a Dunwoody manifold.*

Proof. Let $K \subset L(p, q)$ be a $(1, 1)$ -knot and let $(L(p, q), K) = (H, A) \cup_{\varphi} (H', A')$ be a $(1, 1)$ -decomposition of K . Let β (resp. β') be a meridian of ∂H (resp. $\partial H'$) that bounds a disc in H (resp. H') not intersecting A (resp. A'). The system of curves $(\beta, \varphi(\beta'))$ on $T = \partial H$ defines a genus one Heegaard diagram of $L(p, q)$, which does not intersect $\partial A = \{N, S\}$. Let H_{φ} be the open Heegaard diagram on \mathbb{R}^2 obtained by cutting T along β , and considering S as the point at the infinity of $\mathbf{S}^2 = \mathbb{R}^2 \cup \{S\}$. The diagram consists of two canonical circles C' and C'' , corresponding to β , and a closed curve or a set of arcs with endpoints on the canonical circles, which corresponds to $\varphi(\beta')$ and will be denoted by \mathcal{E} . Suppose that one of the following holds:

- (1) H_{φ} is the diagram depicted in Figure 4 a);
- (2) H_{φ} is the diagram depicted in Figure 4 b);
- (3) there exist integers a, b, c , with $a, b, c \geq 0$ and $a + b + c > 0$, such that H_{φ} is the diagram depicted in Figure 5.

In the first case, K is the core knot $\{P\} \times \mathbf{S}^1 \subset \mathbf{S}^2 \times \mathbf{S}^1$, where P is a point of \mathbf{S}^2 . Therefore, from [3, Cor. 2], we have $H_1(\mathbf{S}^2 \times \mathbf{S}^1 - K) = \langle \alpha, \gamma \mid \gamma \rangle \cong \mathbb{Z}$, where α and γ are the curves on T depicted in Figure 6. So, by [3, Th. 4], there exists no strongly-cyclic branched covering of K .

In the second case, K is the trivial knot in $\mathbf{S}^2 \times \mathbf{S}^1$. Therefore, by [3, Cor. 2], we have $H_1(\mathbf{S}^2 \times \mathbf{S}^1 - K) = \langle \alpha, \gamma \mid \emptyset \rangle \cong \mathbb{Z} \oplus \mathbb{Z}$. So, by [3, Th. 4], there exist exactly n n -fold strongly-cyclic branched coverings of K , depending on the choice of $\omega(\alpha) \in \mathbb{Z}_n$, where $\omega : H_1(\mathbf{S}^2 \times \mathbf{S}^1 - K) \rightarrow \mathbb{Z}_n$ is the monodromy map of the covering such that $\omega(\gamma) = 1$. If we denote by $C_{n,s}(K)$ the n -fold strongly-cyclic branched covering of K such that $\omega(\alpha) = s$, we have $C_{n,s}(K) = M(0, 0, 0, n, 0, s)$. Actually, as previously observed, $C_{n,s}(K)$ is homeomorphic to the connected sum of n copies of $\mathbf{S}^2 \times \mathbf{S}^1$, for all n, s .

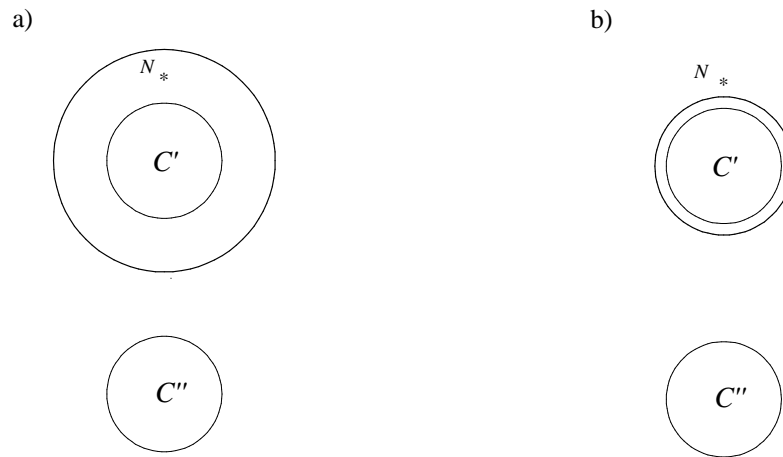

Figure 4:

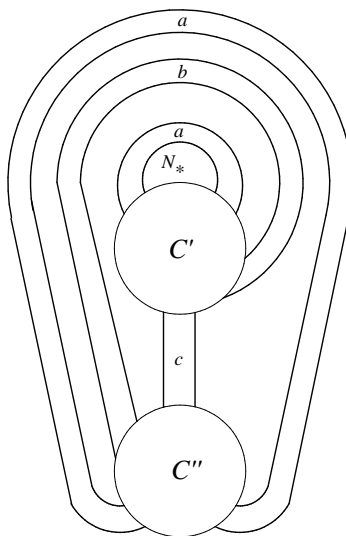

Figure 5:

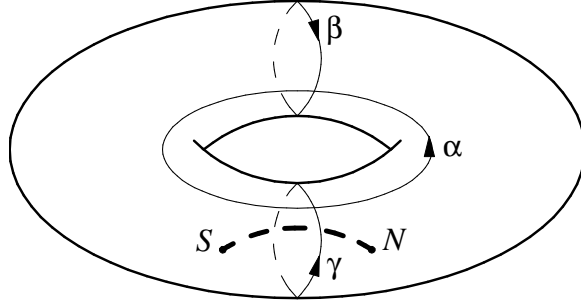

Figure 6:

Let us consider the third case. If $f : M \rightarrow L(p, q)$ is an n -fold strongly-cyclic branched covering of K , then the $(1, 1)$ -decomposition of K lifts to a genus n Heegaard splitting for M (see [10]). Since $\omega(\gamma) = 1$, up to equivalence, then the lifting of H_φ is the Dunwoody diagram $D(a, b, c, n, r, s)$, where $s = \omega(\alpha)$. In other words, M is the Dunwoody manifold $M(a, b, c, n, r, s)$.

By Proposition 1, to prove the theorem it is enough to show that H_φ is equivalent, up to Singer moves fixing N , to one of the three diagrams discussed above.

Denote by D' and D'' the disks of \mathbb{R}^2 bounded by C' and C'' , respectively. Moreover, let \mathcal{A}' (resp. \mathcal{A}'') be the set of arcs of \mathcal{E} with both the endpoints on C' (resp. C''), and denote by \mathcal{B} the remaining arcs of \mathcal{E} . Of course, $|\mathcal{A}'| = |\mathcal{A}''|$. An arc $e \in \mathcal{A}'$ (resp. \mathcal{A}'') is called *trivial* if the closed curve $e \cup e'$, where e' is one of the two arcs of C' (resp. C'') with the same endpoints of e , bounds a disc containing neither N nor D'' (resp. D'). As illustrated in Figure 7, each trivial arc can be removed by a Singer move of type IB (see [11]). So, up to equivalence, we can suppose that H_φ contains no trivial arcs. Observe that this assumption implies that $e \cup e'$ bounds a disc in \mathbb{R}^2 containing the point N , for every $e \in \mathcal{A}' \cup \mathcal{A}''$. In fact, if there exists a non trivial arc e of \mathcal{A}' (resp. of \mathcal{A}'') such that $e \cup e'$ bounds a disk D in \mathbb{R}^2 not containing N , then D contains D'' (resp. D') and therefore there exists a trivial arc in \mathcal{A}'' (resp. \mathcal{A}').

In order to simplify the proof, let us consider the planar graph Γ obtained from H_φ by collapsing the disks D' and D'' to their centers, that we still indicate by C' and C'' , respectively. Of course, the arcs of \mathcal{A}' and \mathcal{A}'' become loops in Γ bounding disks all containing N .

We say that two elements of \mathcal{E} are *parallel* if they are isotopic rel

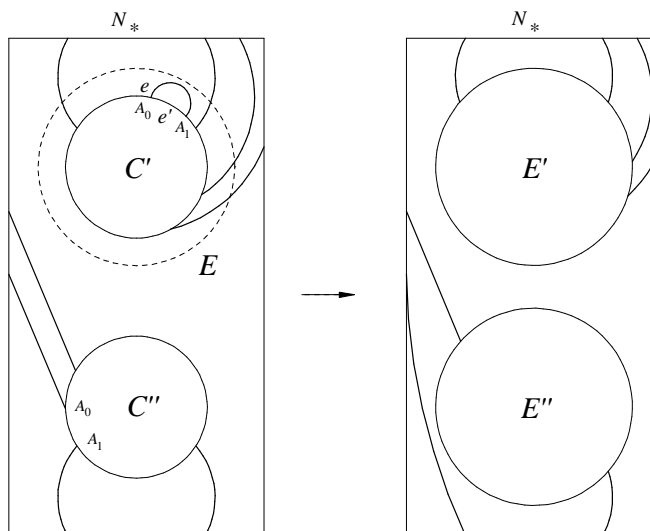

Figure 7: Singer move of type IB.

$\{C', C'', N\}$. It is easy to see that any two elements of \mathcal{A}' (resp. of \mathcal{A}'') are parallel. In fact, if the disk bounded by a loop of \mathcal{A}' (resp. \mathcal{A}'') contains C'' (resp. C'), then all the disks bounded by the loops of \mathcal{A}' (resp. \mathcal{A}'') contain C'' (resp. C'). Otherwise, each loop of \mathcal{A}'' (resp. \mathcal{A}') bounds a disk not containing N . As regards the elements of \mathcal{B} , we note that two different arcs $g, g' \in \mathcal{B}$ are parallel if and only if the closed curve $g \cup g'$ bounds a disc $D_{g,g'}$ not containing N . It is not difficult to see that there are at most two isotopy classes. For, if $g, g', g'' \in \mathcal{B}$ are different arcs such that g is not parallel to either g' or g'' , then $N \in D_{g,g'}$ and $N \in D_{g,g''}$. Moreover, either $D_{g',g''} = (D_{g,g'} - D_{g,g''}) \cup g''$ or $D_{g',g''} = (D_{g,g''} - D_{g,g'}) \cup g'$. In both cases $N \notin D_{g',g''}$ and therefore g' is parallel to g'' .

If $\mathcal{A}' = \mathcal{A}'' = \mathcal{B} = \emptyset$, \mathcal{E} consists of a closed curve C . So, up to isotopy in $\mathbb{R}^2 - N$, we can suppose that C is a standard circle. There are two possibilities, depending on whether the point N is contained inside or outside C . But, in both cases, since C is a curve of a Heegaard diagram, C' is inside C if and only if C'' is outside C . So, up to a possible exchange between C' and C'' , the two possibilities are those depicted in Figure 8, which are the same as in Figure 4.

If $\mathcal{A}' \cup \mathcal{A}'' \cup \mathcal{B} \neq \emptyset$, we can consider the graph Γ' obtained from Γ by taking only one element for each isotopy class of arcs. So Γ' is a graph embedded

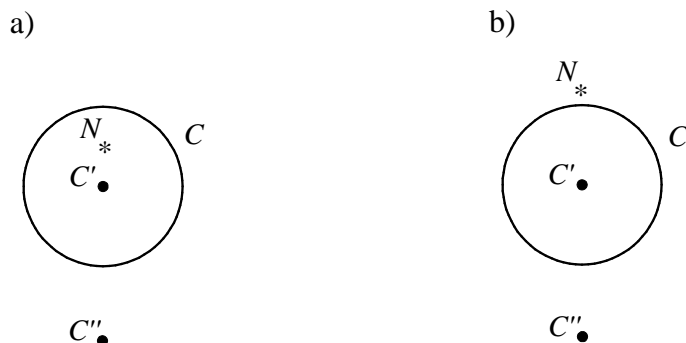

Figure 8:

in $\mathbb{R}^2 - N$ with two vertices, a loop in each vertex if $\mathcal{A}' \neq \emptyset$, and one or two edges linking the vertices if $\mathcal{B} \neq \emptyset$. If $\mathcal{A}' \neq \emptyset$, one of the two loops is contained in the disk bounded by the other, since both of the disks bounded by the loops contain N . Up to isotopy in $\mathbb{R}^2 - N$ and to a possible exchange between C' and C'' , they are as in Figure 9. The other edges of Γ' , if any, must be contained in the annulus bounded by the two loops. So, up to an isotopy of $\mathbb{R}^2 - N$, which can be chosen as the identity outside C'' , they are as in Figure 10. Of course, the same configuration of these edges holds when $\mathcal{A}' = \emptyset$.

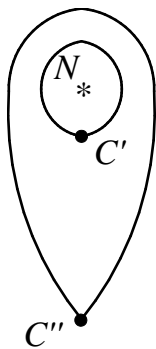

Figure 9:

So H_φ is the diagram depicted in Figure 5, where a, b, c are the cardinalities of the isotopy classes. \square

By Theorem 3 and Proposition 2 we have:

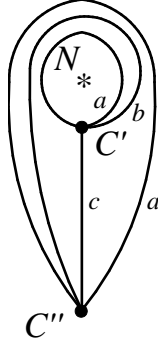

Figure 10:

Corollary 4. *The class of Dunwoody manifolds coincides with the class of strongly-cyclic branched coverings of $(1, 1)$ -knots.*

4 $(1, 1)$ -knots parametrization

As a consequence of the proof of Theorem 3, any $(1, 1)$ -knot K , with the sole exception of the core knot $\{P\} \times \mathbf{S}^1 \subset \mathbf{S}^2 \times \mathbf{S}^1$ (which admits no strongly-cyclic branched coverings), has a $(1, 1)$ -decomposition which can be represented by an admissible Dunwoody diagram $D(a, b, c, 1, r, 0)$, for suitable integers $a, b, c \geq 0$ and r . In this case, we set $K = K(a, b, c, r)$, and we have that the Dunwoody manifold $M(a, b, c, n, r, s)$ is an n -fold strongly-cyclic branched covering of the lens space $M(a, b, c, 1, r, 0)$ (possibly homeomorphic to \mathbf{S}^3), branched over the $(1, 1)$ -knot $K(a, b, c, r)$.

Examples. By [7, Theorem 8], the two-bridge knot with Schubert parametrization $(2a+1, 2r)$ is the $(1, 1)$ -knot $K(a, 0, 1, r)$. The trivial knot in $\mathbf{S}^2 \times \mathbf{S}^1$ is $K(0, 0, 0, 0)$ and the trivial knot in $L(p, q)$ (including $L(1, 0) \cong \mathbf{S}^3$) is $K(0, 0, p, q)$.

Note that a different parametrization of $(1, 1)$ -knots, which involves four parameters for the knot and two additional parameters for the ambient space, can be found in [5].

Now we describe an algorithm that gives the parametrization $K(a, b, c, r)$ of all torus knots in \mathbf{S}^3 .

Given a closed simple curve $\delta \in \partial H$, denote by $t_\delta \in PMCG_2(\partial H)$ the

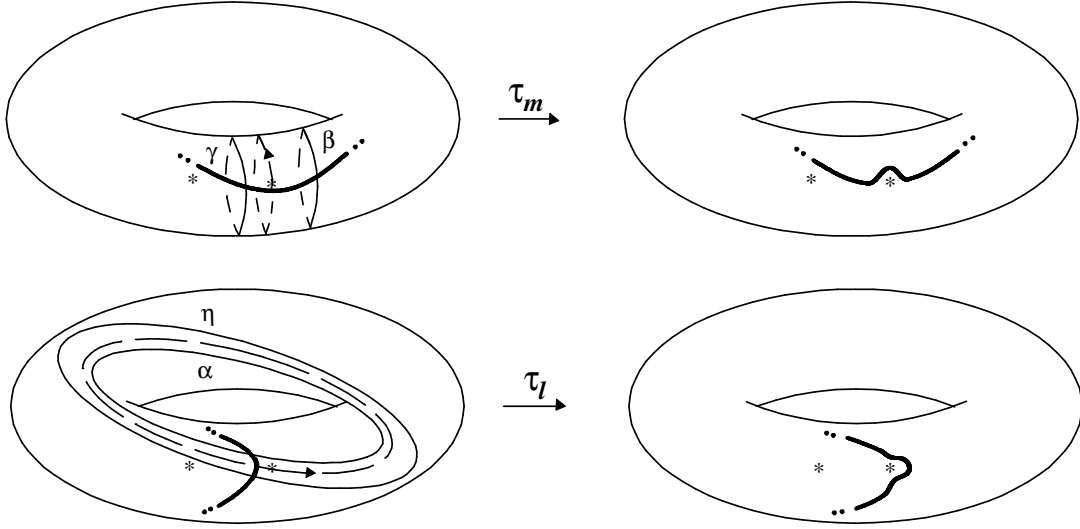

Figure 11: Action of τ_m and τ_l .

right-hand Dehn twist along δ . Moreover, let $\tau_m = t_\beta t_\gamma^{-1}$ and $\tau_l = t_\eta t_\alpha^{-1}$, where $\beta, \gamma, \alpha, \eta$ are the curves depicted in Figure 11. The effect of τ_m and τ_l is to slide one puncture, for example N , along the dashed curves depicted in Figure 11, i.e. along a meridian and a longitude of the torus, respectively.

As shown in [4], for every $1 < k < h$, the torus knot $\mathbf{t}(k, h) \subset \mathbf{S}^3$ is the $(1, 1)$ -knot K_ψ with:

$$\psi = \prod_{j=0}^{h-1} (\tau_l^{-1} \tau_m^{\varepsilon_{h-j}}) t_\beta t_\alpha t_\beta, \quad (1)$$

where¹ $\varepsilon_{h-j} = \lfloor (j+1)k/h \rfloor - \lfloor (j+2)k/h \rfloor$. Since $k < h$, we have $\varepsilon_{h-j} \in \{-1, 0\}$, for all j .

In order to find the parameters a, b, c, r for $\mathbf{t}(k, h)$, it is enough to illustrate how the Heegaard diagram $D(0, 0, 0, 1, 0, 0)$ is modified by the initial application of $t_\beta t_\alpha t_\beta$ and by the successive applications of the elements τ_l^{-1} and $\tau_l^{-1} \tau_m^{-1}$ composing ψ , according to (1). In this way we construct a Heegaard diagram $D(a, b, c, 1, r, 0)$ representing $\mathbf{t}(k, h)$.

Actually, during the process, the Heegaard diagrams involved at each step are diagrams which can be obtained by performing a certain num-

¹ $\lfloor x \rfloor$ denotes the integral part of x .

ber $z' \in \mathbb{Z}$ of Dehn twists along the curve γ to a standard Dunwoody diagram $D(a', b', c', 1, r', 0)$ (see Figure 12). We will call this diagram $D_{z'}(a', b', c', 1, r', 0)$. These types of diagrams are depicted in Figure 12, where an arc labelled k denotes k parallel arcs. Obviously, $D_0(a', b', c', 1, r', 0) = D(a', b', c', 1, r', 0)$.

Observe that, at the end of the process, we can reduce z' to zero, since $K_{t, \psi}$ and K_ψ are equivalent knots.

Proposition 5. *Let $\mathbf{t}(k, h) \subset \mathbf{S}^3$ be a torus knot and ψ be its representation described in (1). Then $\mathbf{t}(k, h) = K(a, b, c, r)$ where $(a, b, c, r) = (a_h, b_h, c_h, r_h)$ is the final step of the following algorithm, applied for $i = h - j = 1, \dots, h$:*

$$- (a_0, b_0, c_0, r_0) = (0, 0, 1, 0) \text{ and } z_0 = 0;$$

- for $i = 1, \dots, h$:

$$\begin{cases} a_i = a_{i-1} + v \\ b_i = r_{i-1} - 2w - ud \\ c_i = d - b_i \\ r_i = a_{i-1} + v + w \\ z_i = u - \varepsilon_i \end{cases}$$

where:

$$w = \begin{cases} a_{i-1} + b_{i-1} + c_{i-1} & \text{if } z_{i-1} < -1 - \varepsilon_i \\ a_{i-1} + c_{i-1} & \text{if } z_{i-1} = -1 - \varepsilon_i, \\ a_{i-1} & \text{if } z_{i-1} > -1 - \varepsilon_i \end{cases}$$

$$v = \begin{cases} -(b_{i-1} + c_{i-1})(z_{i-1} + 1 + \varepsilon_i) - b_{i-1} & \text{if } z_{i-1} < -1 - \varepsilon_i \\ 0 & \text{if } z_{i-1} = -1 - \varepsilon_i, \\ (b_{i-1} + c_{i-1})(z_{i-1} + 1 + \varepsilon_i) - c_{i-1} & \text{if } z_{i-1} > -1 - \varepsilon_i \end{cases}$$

and $u = \lfloor (r_{i-1} - 2w)/d \rfloor$, with $d = 2a_{i-1} + b_{i-1} + c_{i-1}$.

The proof of Proposition 5 will be given at the end of this section. Now we give some examples and applications.

Remark 6. Given an admissible Dunwoody diagram $D(a, b, c, 1, r, 0)$, with $a + b + c > 0$, we fix an orientation on the arcs of \mathcal{E} that induces an orientation on the corresponding curve of the Heegaard diagram in such a way that the vertex on C' labelled 1 is the first endpoint of the corresponding edge. Let $p_{a,b,c,r}$ be the number of arcs of \mathcal{B} oriented from C' to C'' minus the number

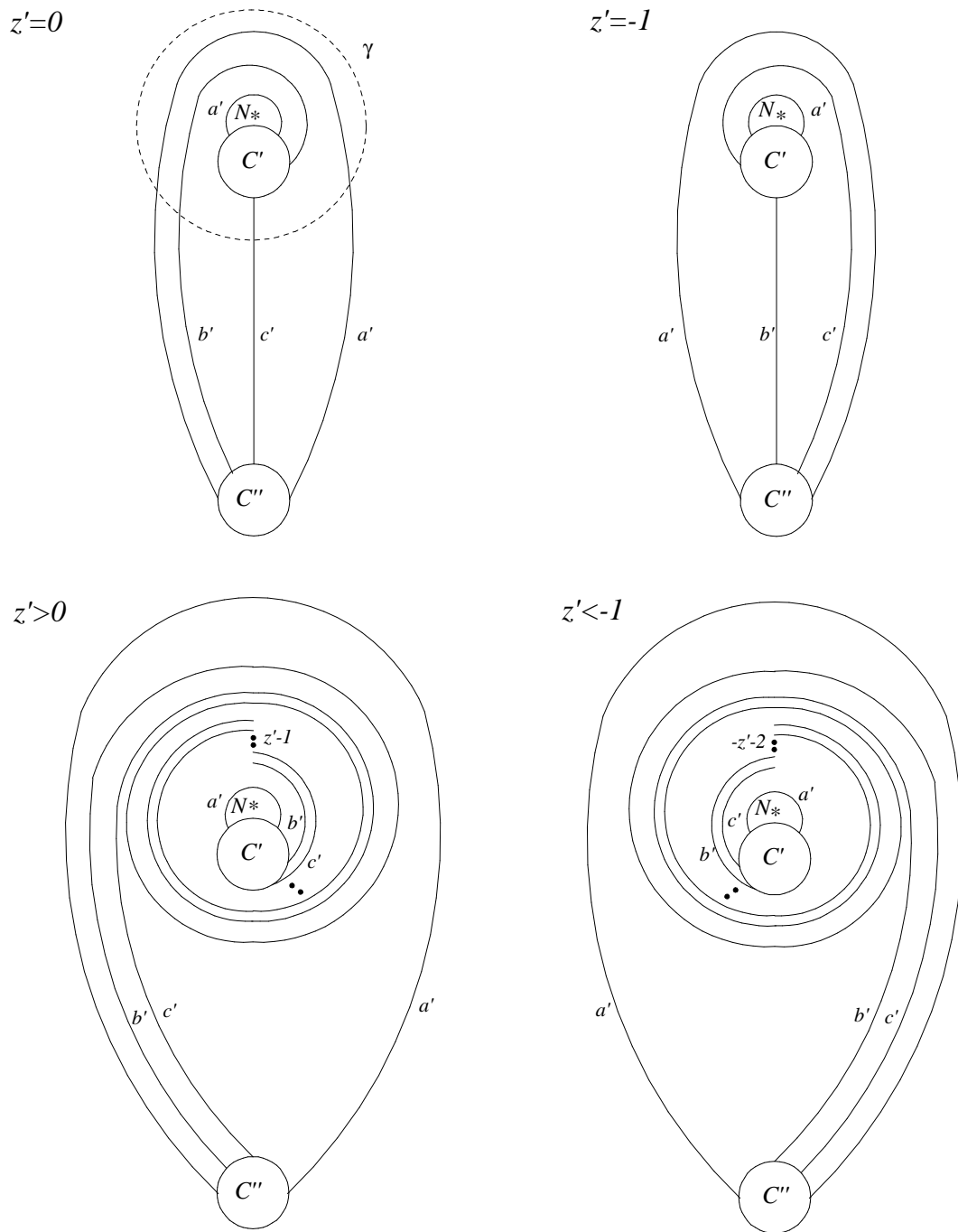

Figure 12: The Heegaard diagram $D_{z'}(a', b', c', 1, r', 0)$.

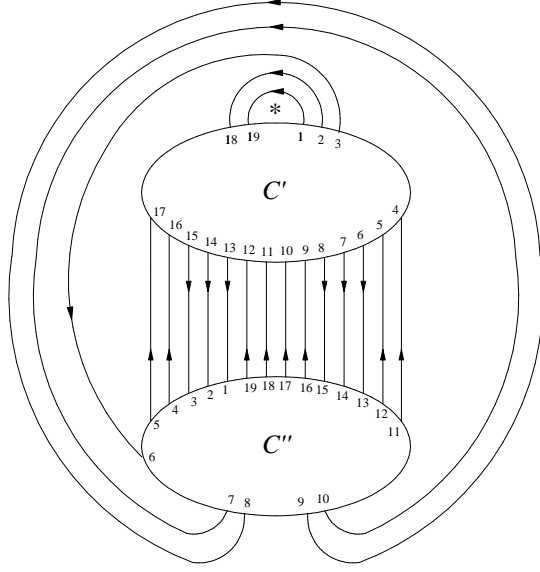

Figure 13: $D(2, 1, 14, 1, 11, 0)$.

of arcs oriented from C'' to C' , and let $q_{a,b,c,r}$ be the number of arcs of \mathcal{E} oriented from right to left minus the number of arcs oriented from left to right (see [7, p. 385]). If $K(a, b, c, r)$ is a $(1, 1)$ -knot in \mathbf{S}^3 , then the n -fold cyclic branched covering of $K(a, b, c, r)$ is the Dunwoody manifold $M(a, b, c, r, n, s)$, where $s = -p_{a,b,c,r}q_{a,b,c,r}$. In fact, by Proposition 2, there exists a unique $s \pmod n$ such that $M(a, b, c, n, r, s)$ is the n -fold cyclic covering of $M(a, b, c, 1, r, 0) \cong \mathbf{S}^3$, branched over $K(a, b, c, r)$. Moreover, by [7], s must satisfy the condition $q_{a,b,c,r} + sp_{a,b,c,r} \equiv 0 \pmod n$ and we have $p_{a,b,c,r} = \pm 1$.

Example. Let us consider $\mathbf{t}(5, 8)$. By (1), a representation of $\mathbf{t}(5, 8)$ is given by $\psi = \tau_l^{-1}\tau_m^{-1}\tau_l^{-1}(\tau_l^{-1}(\tau_m^{-1}\tau_l^{-1})^2)t_\beta t_\alpha t_\beta$. Then, by Proposition 5, we have $\mathbf{t}(5, 8) = K(2, 1, 14, 11)$. Moreover, from the diagram $D(2, 1, 14, 1, 11, 0)$ depicted in Figure 13, we get $p_{2,1,14,11} = -1$ and $q_{2,1,14,11} = 5$. So, by Remark 6, the n -fold cyclic branched covering of $\mathbf{t}(5, 8)$ is the Dunwoody manifold $M(2, 1, 14, n, 11, 5)$, for all $n > 1$.

As an application, we explicitly determine the parametrization of $\mathbf{t}(k, ck + 1)$ as well as the Dunwoody representation of its cyclic branched coverings.

Corollary 7. *For every $c > 0$ and $k > 1$, the torus knot $\mathbf{t}(k, ck + 1)$ is $K(1, k - 2, 2kc - 2c - k + 1, k)$. Moreover, the n -fold cyclic branched covering of $\mathbf{t}(k, ck + 1)$ is the Dunwoody manifold $M(1, k - 2, 2kc - 2c - k + 1, n, k, k)$, for all $n > 1$.*

Proof. By (1), $\mathbf{t}(k, ck + 1)$ is represented by $\psi = (\tau_l^{-c} \tau_m^{-1})^k \tau_l^{-1} t_\beta t_\alpha t_\beta$. Applying Proposition 5 and Remark 6 we get the statement. \square

Observe that Corollary 7 agrees with the result obtained in [1] with different techniques.

Proof of Proposition 5. As shown in Figure 14, the application of $t_\beta t_\alpha t_\beta$ to $D(0, 0, 0, 1, 0, 0)$ gives the diagram $D(0, 0, 1, 1, 0, 0)$.

In order to simplify the notations in the figures, we set $(a_{i-1}, b_{i-1}, c_{i-1}, r_{i-1}) = (a', b', c', r')$ and $z_{i-1} = z'$. To obtain the parameters a, b, c and r , we consider the application of $\tau_l^{-1} \tau_m^{\varepsilon_i}$ to $D_{z'}(a', b', c', 1, r', 0)$.

Let us first consider the case $\varepsilon_i = 0$. We recall that the effect of τ_l^{-1} is to slide N along the longitude of the torus, illustrated by the dashed line in Figure 11, in the opposite direction to the arrow. This curve will always be represented on a Heegaard diagram by a dashed arc connecting an internal point of the arc on C' , with endpoints labelled d and 1 (according to the orientation), with the corresponding point on C'' . The number of intersections of the longitude with the arcs of a given diagram depends on r' . Let w be the value of r' such that the number of these intersections is minimal. Then, as illustrated in Figure 15, we have:

$$w = \begin{cases} a' + b' + c' & \text{if } z' < -1 \\ a' + c' & \text{if } z' = -1 \\ a' & \text{if } z' > -1 \end{cases}.$$

In this figure, and in the following ones, an arc labelled f denotes f parallel arcs, and we take the convention that a label of a vertex is the label corresponding to the endpoint of the first of the f parallel arcs.

First of all, we consider the case $r' = w$. In this case the longitude has $a' + v$ intersections, and the action of τ_l^{-1} is illustrated in Figure 16. We obtain $(a_i, b_i, c_i, r_i) = (a' + v, d - w, w, a' + v + w)$ and $z_i = -1$, which is the same result of the statement when $r' = w \neq 0$ (in this case $-d \leq r' - 2w = -w < 0$ and so $u = -1$). If $r' = w = 0$, we have $u = 0$, and therefore the statement

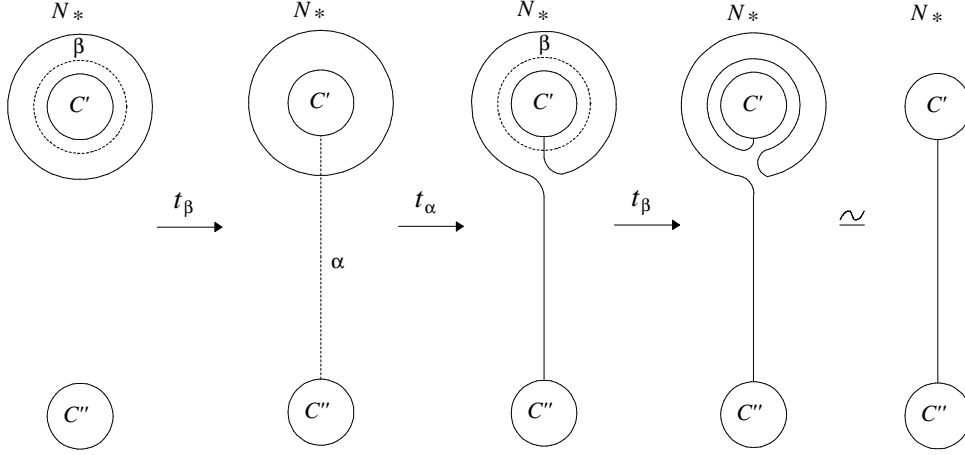

Figure 14: Action of $t_\beta t_\alpha t_\beta$ on $D(0, 0, 0, 1, 0, 0)$.

gives $(a_i, b_i, c_i, r_i) = (a' + v, 0, d, a' + v)$ and $z_i = 0$; but it is easy to check that $D_0(a' + v, 0, d, 1, a' + v, 0) = D_{-1}(a' + v, d, 0, 1, a' + v, 0)$.

When $r' > w$ or $r' < w$, the result of the application of τ_i^{-1} is depicted in Figure 17. In both cases, the further $|r' - w|$ intersections determine $|r' - w|$ trivial arcs on C'' . The j -th of these arcs has endpoints on C'' labelled $a' + v + d + j$ and $a' + v + d + 2(r' - w) - j + 1$ if $w < r'$, and labelled $a' + v + j$ and $a' + v + 2(w - r') - j + 1$ if $w > r'$. Each time we eliminate a trivial arc e , we glue together the two arcs whose endpoints on C' have the same label as the endpoints of e on C'' . In Figure 17, the black points indicate which arcs are glued together. After the elimination of all the trivial arcs, we obtain, as above, $a_i = a' + v$ and $r_i = a' + v + w$, while the value of the other three parameters depends on the quotient of the division of $|r' - 2w|$ by d . Suppose that $r' > w$, then we have two cases:

- (1) if $r' - w < w$, we obtain $b_i = d - w + r' - w = d + r' - 2w$, $c_i = w - (r' - w) = 2w - r'$ and $z_i = -1$;
- (2) if $r' - w \geq w$, after the elimination of the first w trivial arcs, we obtain the diagram depicted in Figure 18. During the elimination of the remaining $r' - 2w$ arcs, each time we eliminate d arcs the parameter z' increases by one. Therefore, if u is the integer defined by $u = \lfloor (r' - 2w)/d \rfloor$, we have $b_i = r' - 2w - ud$, $c_i = (u + 1)d - (r' - 2w)$ and $z_i = u$.

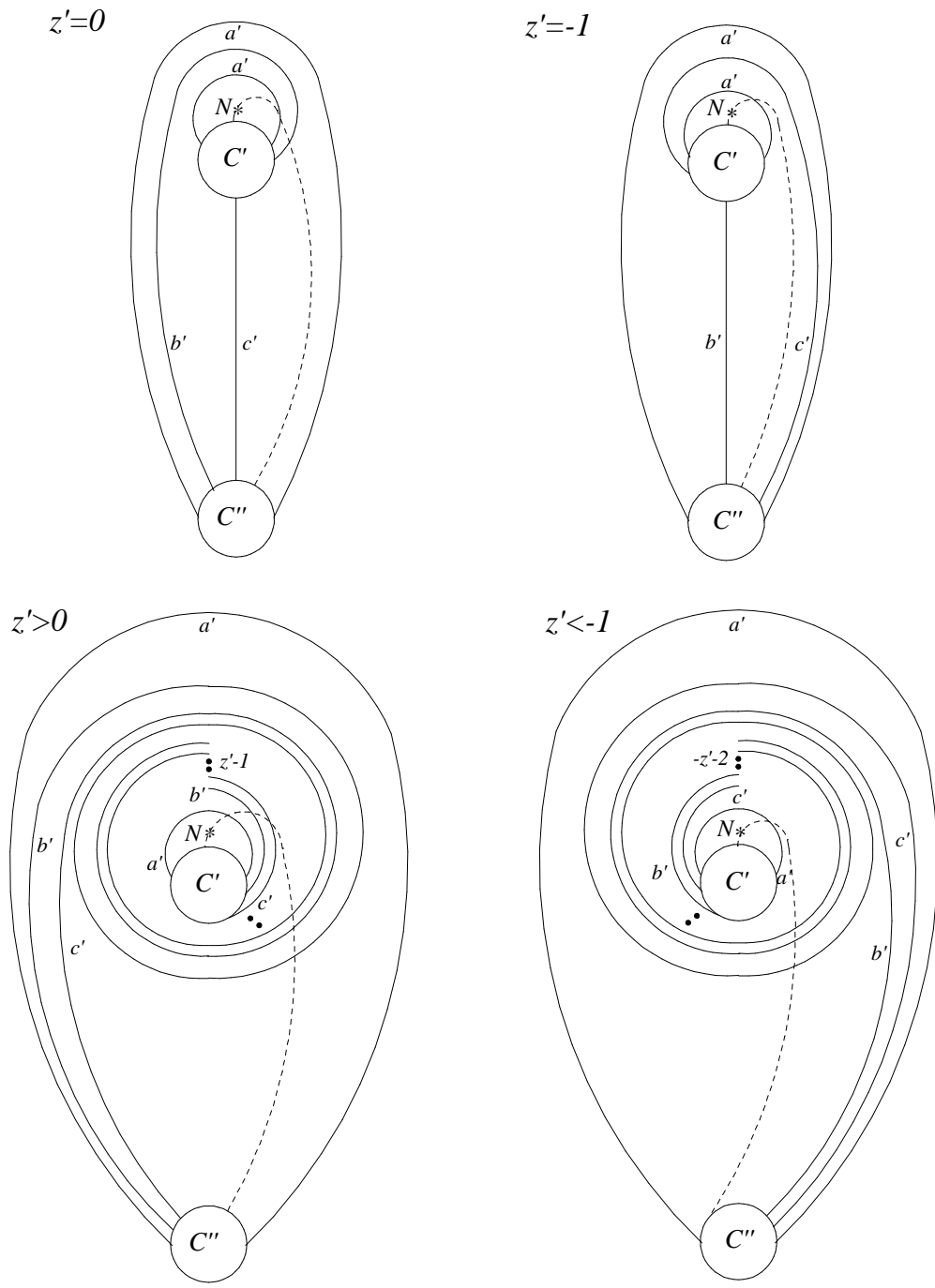

Figure 15: The parameter w .

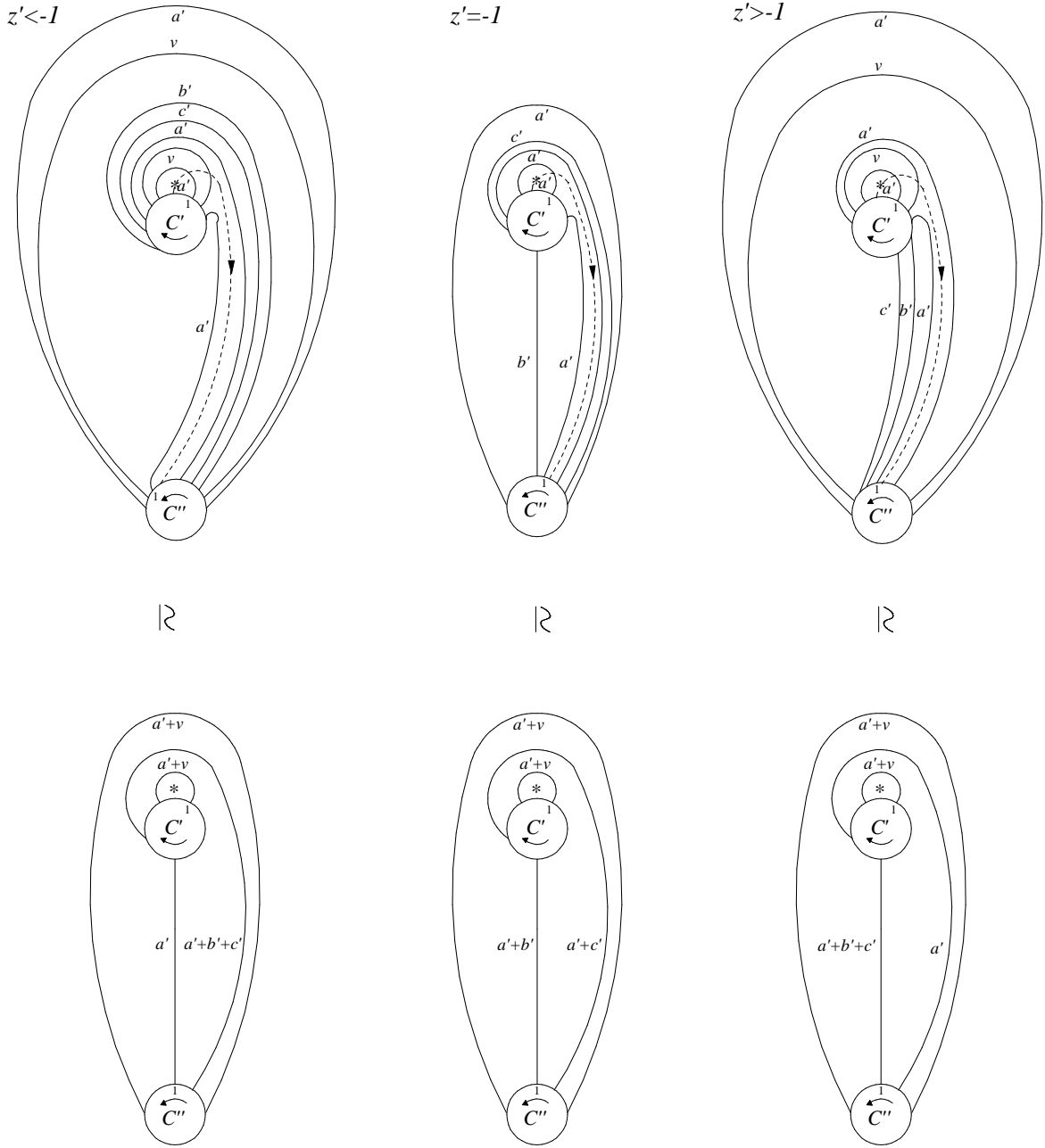

Figure 16: Action of τ_l^{-1} on $D_{z'}(a', b', c', 1, r', 0)$ for $r' = w$.

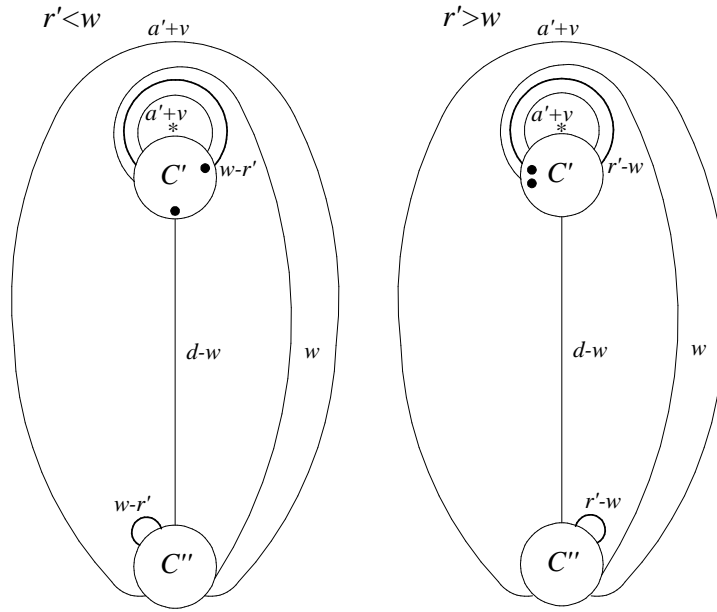

Figure 17: Action of τ_l^{-1} on $D_{z'}(a', b', c', 1, r', 0)$ for $r' < w$ and $r' > w$.

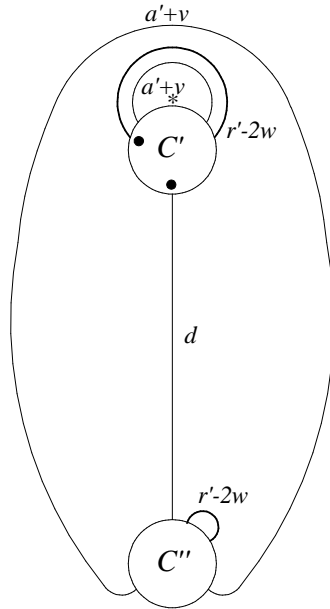

Figure 18: Action of τ_l^{-1} in the case $r' - w \geq w$.

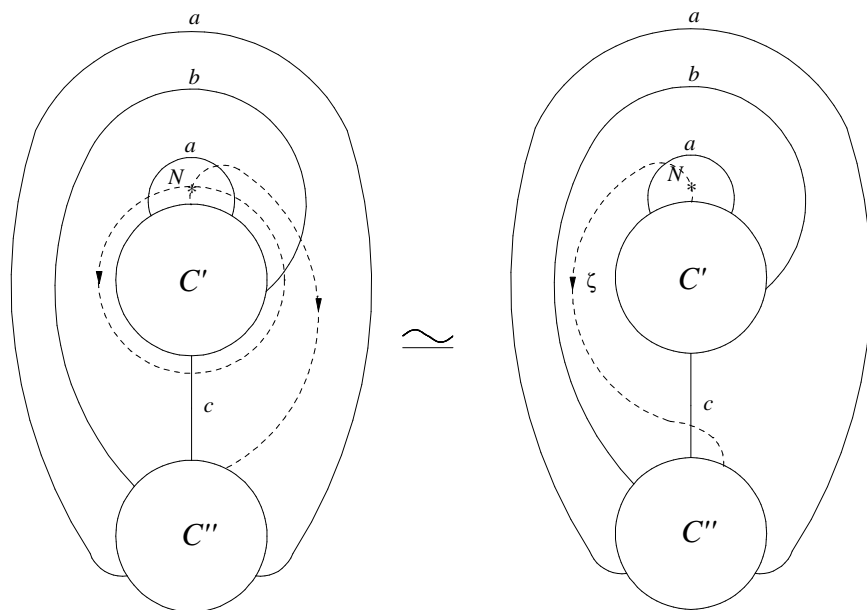

Figure 19: Action of $\tau_l^{-1}\tau_m^{-1}$.

Analysing the case $r' < w$ in an analogous way, we complete the case $\varepsilon_i = 0$.

In the case $\varepsilon_i = -1$ we examine the action of $\tau_l^{-1}\tau_m^{-1}$. This can be done in a similar way as before, since, as depicted in Figure 19, the action of $\tau_l^{-1}\tau_m^{-1}$ is equivalent to an action that moves N along the longitude ζ . \square

Acknowledgements

Work performed under the auspices of the G.N.S.A.G.A. of I.N.d.A.M. (Italy) and the University of Bologna, funds for selected research topics.

References

- [1] H. AYDIN, I. GULTEKIN and M. MULAZZANI. Torus knots and Dunwoody manifolds. *Siberian Math. J.* **45** (2004), 1-6.
- [2] G. BURDE and H. ZIESCHANG. *Knots*. De Gruyter Stud. Math. no. 5 (de Gruyter, 1985).

- [3] A. CATTABRIGA and M. MULAZZANI. Strongly-cyclic branched coverings of $(1,1)$ -knots and cyclic presentations of groups. *Math. Proc. Cambridge Philos. Soc.* **135** (2003), 137-146.
- [4] A. CATTABRIGA and M. MULAZZANI. $(1,1)$ -knots via the mapping class group of the twice punctured torus. *Adv. Geom.* (2004), to appear, arXiv:math.GT/0205138.
- [5] D. H. CHOI and K. H. KO. Parametrizations of 1-bridge torus knots. *J. Knot Theory Ramifications* **12** (2003), 463-491.
- [6] M. J. DUNWOODY. Cyclic presentations and 3-manifolds. In: *Groups-Korea '94. Proceedings of the International Conference* (de Gruyter, 1995), 47-55.
- [7] L. GRASSELLI and M. MULAZZANI. Genus one 1-bridge knots and Dunwoody manifolds. *Forum Math.* **13** (2001), 379-397.
- [8] D. L. JOHNSON. *Topics in the theory of group presentations*. London Math. Soc. Lecture Note Ser. no. 42 (Cambridge Univ. Press, 1980).
- [9] A. KAWAUCHI. *A Survey of Knot Theory* (Birkhäuser, 1996).
- [10] M. MULAZZANI. Cyclic presentation of groups and cyclic branched coverings of $(1,1)$ -knots. *Bull. Korean Math. Soc.* **40** (2003), 101-108.
- [11] J. SINGER. Three-dimensional manifolds and their Heegaard diagrams. *Trans. Amer. Math. Soc.* **35** (1933), 88-111.

ALESSIA CATTABRIGA, Department of Mathematics, University of Bologna, Italy. E-mail: cattabri@dm.unibo.it

MICHELE MULAZZANI, Department of Mathematics and C.I.R.A.M., University of Bologna, Italy. E-mail: mulazza@dm.unibo.it