

The Dynamics of Group Codes: Dual Abelian Group Codes and Systems

G. David Forney, Jr., *Fellow, IEEE*, and Mitchell D. Trott, *Member, IEEE*

Abstract—Fundamental results concerning the dynamics of abelian group codes (behaviors) and their duals are developed. Duals of sequence spaces over locally compact abelian groups may be defined via Pontryagin duality; dual group codes are orthogonal subgroups of dual sequence spaces. The dual of a complete code or system is finite, and the dual of a Laurent code or system is (anti-)Laurent. If \mathcal{C} and \mathcal{C}^\perp are dual codes, then the state spaces of \mathcal{C} act as the character groups of the state spaces of \mathcal{C}^\perp . The controllability properties of \mathcal{C} are the observability properties of \mathcal{C}^\perp . In particular, \mathcal{C} is (strongly) controllable if and only if \mathcal{C}^\perp is (strongly) observable, and the controller memory of \mathcal{C} is the observer memory of \mathcal{C}^\perp . The controller granules of \mathcal{C} act as the character groups of the observer granules of \mathcal{C}^\perp . Examples of minimal observer-form encoder and syndrome-former constructions are given. Finally, every observer granule of \mathcal{C} is an “end-around” controller granule of \mathcal{C} .

Index Terms—Group codes, group systems, linear systems, behavioral systems, duality, controllability, observability.

I. INTRODUCTION

A GROUP CODE is a set of sequences that has a group property under a componentwise group operation [15], [29]. For example, if G is any group and $G^{\mathbb{Z}}$ is the direct product group whose elements are the bi-infinite sequences with components in G , then any subgroup \mathcal{C} of $G^{\mathbb{Z}}$ is a group code.

A group code may be regarded as the behavior of a behavioral group system, in the sense of Willems [46], [47], [48], [49]. It has been shown in [15], [28], [29] that many of the fundamental properties of linear codes and systems depend only on their group structure. Most importantly, a group code or system has naturally-defined minimal state spaces.

In this paper we study dual group codes and systems. Our motivation is the importance of duality in the study of linear codes and systems. (For brevity, we will usually say “code” rather than “code or system/behavior.”)

Our first problem is to define the dual \mathcal{C}^\perp of a group code \mathcal{C} . For this purpose we use Pontryagin duality, a rather general

notion of duality that applies to abelian topological groups. A closed abelian group code \mathcal{C} in a sequence space \mathcal{W} may then be characterized as the set of all sequences in \mathcal{W} that are orthogonal to all sequences in the dual code \mathcal{C}^\perp —i.e., \mathcal{C} may be characterized by a set of constraints (“checks”).

An immediate consequence of this definition is that the dual of a complete code, namely a closed subgroup of a complete sequence space such as $G^{\mathbb{Z}}$, is a finite code, namely a code all of whose sequences are finite. On the other hand, the dual of a Laurent code is (anti-)Laurent.

We derive fundamental duality relations between the dynamics of \mathcal{C} and the dynamics of \mathcal{C}^\perp . For example, the state spaces of \mathcal{C} act as the character groups of the state spaces of \mathcal{C}^\perp , and the observability properties of \mathcal{C} are the controllability properties of \mathcal{C}^\perp . (Here observability is defined as in [28] as a property of a code, not of a state space representation as in [47].)

More precisely, we decompose the dynamics of a group code into observer granules, in a decomposition dual to the controller granule decomposition of [15].

Our original goal was to construct a minimal observer-form encoder and a minimal syndrome-former/state observer for \mathcal{C} based on its observability structure. This is straightforward in many particular cases, but surprisingly difficult in general. Fagnani and Zampieri [10] have succeeded in providing such constructions for group codes over general finite nonabelian groups in a purely algebraic setting. Therefore we merely present some general principles and examples of minimal observer-form encoder and syndrome-former/state observer constructions.

Finally, we show algebraically that every observer granule is isomorphic to an “end-around” controller granule. As corollaries, we obtain purely algebraic proofs of many of our results.

We should say that our restriction to abelian groups does not appear to us to be essential, except to allow the use of Pontryagin duality. More general notions of duality of nonabelian groups exist (see, e.g., [3]), but are beyond us. Most of the results of this paper do not appear to depend on the abelian property. (We show that \mathcal{C} has abelian dynamics if and only if \mathcal{C} is normal in its output sequence space; however, normality appears to us to be no more fundamental than abelianness.) It is striking that the syndrome-former construction of [10], like the minimal encoder construction of [15], applies to codes over (finite) nonabelian groups and makes no use of duality, although it employs the observability structure that we develop here.

Manuscript received xxxxxx yy, 2000; revised zzzzzz ww, 2004. Parts of the material of this paper were presented at the 1993 IEEE International Symposium on Information Theory, San Antonio, TX, Jan. 1993; the 1993 IEEE Workshop on Coding, System Theory and Symbolic Dynamics, Mansfield, MA, Oct. 1993; the 1994 IEEE Workshop on Information Theory, Moscow, June 1994, and the 34th Conference on Decision and Control, New Orleans, LA, Dec. 1995.

G. D. Forney is with the Laboratory for Information and Decision Systems, Massachusetts Institute of Technology, Cambridge, MA 02139 USA.

M. D. Trott is with the Hewlett-Packard Laboratories, Palo Alto, CA 94304 USA.

Communicated by F. R. Kschischang, Associate Editor for Coding Theory. Digital Object Identifier 10.1109/TIT.2004.xxxxxx

Section 2 briefly introduces Pontryagin duality. Section 3 discusses dual sequence spaces of several important types, namely complete, finite and Laurent. Section 4 discusses dual group codes, proves that projections and subcodes are duals, gives dual definitions of wide-sense controllability and observability, and presents some examples of dual group codes. Section 5 develops various results about dual state spaces. Section 6 is concerned with dual notions of finite memory, including strong controllability and observability. Section 7 develops observability decompositions into granules dual to the controllability decompositions of [15], [29]. Section 8 gives examples of the construction of minimal observer-form encoders, state observers and syndrome-formers. Section 9 presents the end-around theorem and some corollaries. Section 10 is a brief conclusion.

II. PONTYAGIN DUALITY

Our treatment is based on Pontryagin duality, which applies to topological groups. Pontryagin's original treatise [35] remains an excellent reference. For a more modern exposition, see any book on Fourier (harmonic) analysis on groups; *e.g.*, Rudin [39] or Hewitt and Ross [20].

A topological group is a group that is also a topological space, such that the group and topological properties are consistent. We do not expect the reader to have much background in topology. We are not much interested in the topology of individual symbol alphabets; we usually think of them as being finite or at least discrete and/or compact, although we make more general statements when they appear to be warranted. However, topology does turn out to be important when considering codes whose sequences are defined on infinite index sets, even with finite symbol groups. For an introduction to topology, see, *e.g.*, [25] or [40].

All topological groups in this paper will be assumed to be metric spaces; *i.e.*, to have a topology induced by a distance function. Group homomorphisms will be assumed to be continuous, and group isomorphisms will be assumed also to be homeomorphisms. A subgroup of a topological group is itself a topological group under the induced subspace topology, but is considered to be a topological subgroup only if it is closed.

In this section we review the two basic dualities of Pontryagin duality theory: character group duality and orthogonal subgroup duality. Sequence space duality is defined in terms of the former, and code/system duality in terms of the latter. We also introduce some additional fundamental duality principles: direct product/direct sum duality, sum/intersection duality, quotient group duality, and adjoint duality.

A. Character group duality

A *character* of a (topological) group G is a (continuous) homomorphism

$$h: G \rightarrow \mathbb{R}/\mathbb{Z}$$

from G into the additive circle group ("1-torus") \mathbb{R}/\mathbb{Z} (or equivalently into the complex unit circle under multiplication, to which \mathbb{R}/\mathbb{Z} is isomorphic).

The **character group** of G , denoted by G^\wedge , is the set of all characters of G , with group operation defined by

$$(h_1 \circ h_2)(g) = h_1(g) + h_2(g).$$

Obviously $h_1 \circ h_2 = h_2 \circ h_1$, so G^\wedge is abelian, and we may use additive notation; *i.e.*, the sum of two characters h_1, h_2 is $h_1 + h_2$. The identity of G^\wedge is the zero (or principal) character 0, defined by $0(g) = 0$ for all $g \in G$. The inverse of $h \in G^\wedge$ is the character $-h$ defined by $(-h)(g) = -h(g)$. The characters of a group G are by definition unique, in the sense that no two characters h_1, h_2 have equal values $h_1(g), h_2(g)$ for all $g \in G$.

When G is locally compact abelian (LCA), the fundamental Pontryagin duality theorem holds:

Theorem 2.1 (Pontryagin duality): Given an LCA group G ,

- (a) its character group G^\wedge is LCA;
- (b) the character group of G^\wedge is naturally isomorphic to G : $G^{\wedge\wedge} \cong G$.

The natural isomorphism of this theorem associates $g \in G$ with the character $\phi_g \in G^{\wedge\wedge}$ defined by $\phi_g(h) = h(g)$ for all $h \in G^\wedge$. The theorem says that the character group of G^\wedge is precisely the set of all such characters: $G^{\wedge\wedge} = \{\phi_g : g \in G\}$. In this sense, we may say that G acts as the character group of G^\wedge , and write $G^{\wedge\wedge} = G$ and $g(h) = h(g)$.

Characters thus define a generalized inner product, called a *pairing*, from $G^\wedge \times G$ into \mathbb{R}/\mathbb{Z} , which we write as follows:

$$\langle h, g \rangle = h(g) = g(h).$$

A pairing satisfies the "bihomomorphic" relationships

$$\begin{aligned} \langle 0, g \rangle = \langle h, 0 \rangle &= 0; \\ \langle h_1 + h_2, g \rangle &= \langle h_1, g \rangle + \langle h_2, g \rangle; \\ \langle h, g_1 + g_2 \rangle &= \langle h, g_1 \rangle + \langle h, g_2 \rangle. \end{aligned}$$

We say that $h \in G^\wedge$ and $g \in G$ are **orthogonal** if $\langle h, g \rangle = 0$.

The *character table* of G (or of G^\wedge) is the "matrix"

$$\langle G^\wedge, G \rangle = \{ \langle h, g \rangle \mid h \in G^\wedge, g \in G \}.$$

The "rows" and "columns" of this matrix are the "vectors"

$$\begin{aligned} \langle h, G \rangle &= \{ \langle h, g \rangle \mid g \in G \}; \\ \langle G^\wedge, g \rangle &= \{ \langle h, g \rangle \mid h \in G^\wedge \}, \end{aligned}$$

which explicitly specify the characters $h: G \rightarrow \mathbb{R}/\mathbb{Z} \in G^\wedge$ and $g: G^\wedge \rightarrow \mathbb{R}/\mathbb{Z} \in G$, respectively. The rows are distinct and form a group under row addition that is naturally isomorphic to G^\wedge ; similarly, the columns are distinct and form a group that is naturally isomorphic to G .

The elementary LCA groups in Pontryagin duality theory are the real numbers \mathbb{R} , the integers \mathbb{Z} , the circle group \mathbb{R}/\mathbb{Z} , and the finite cyclic groups $\mathbb{Z}_m = \mathbb{Z}/m\mathbb{Z}$, which may be identified with the finite subgroups $(m^{-1}\mathbb{Z})/\mathbb{Z}$ of \mathbb{R}/\mathbb{Z} . The following table gives the corresponding character groups and pairings:

G	G^\wedge	$\langle h, g \rangle$
\mathbb{R}	\mathbb{R}	$hg \bmod \mathbb{Z}$ (in \mathbb{R}/\mathbb{Z})
\mathbb{Z}	\mathbb{R}/\mathbb{Z}	hg (in \mathbb{R}/\mathbb{Z})
\mathbb{Z}_m	\mathbb{Z}_m	hg (in \mathbb{Z}_m)

Note that in the cases of \mathbb{R} and \mathbb{Z}_m , the character group G^\wedge is isomorphic to G ; however, in these cases we caution that the isomorphism is not a “natural” one. Moreover, the case of \mathbb{Z} and \mathbb{R}/\mathbb{Z} shows that G and G^\wedge need not even have the same cardinality.

The fact that $\mathbb{Z}^\wedge = \mathbb{R}/\mathbb{Z}$ illustrates an important general result: the character group of a discrete group is compact and *vice versa* [39]. Since a finite group with the discrete topology is both discrete and compact, the character group of a finite group is finite; e.g., $(\mathbb{Z}_m)^\wedge \cong \mathbb{Z}_m$.

B. Finite direct product duality

Let \mathcal{I} denote a discrete index set, which throughout this section will be finite. We will often think of \mathcal{I} as an ordered time axis, such as a finite subinterval of \mathbb{Z} . A set indexed by \mathcal{I} such as $\mathbf{w} = \{w_k \in G_k, k \in \mathcal{I}\}$ will correspondingly be called a *sequence*.

Given a finite set of LCA *symbol groups* $\{G_k, k \in \mathcal{I}\}$ indexed by \mathcal{I} , their **direct product** is defined as the Cartesian product set of all sequences $\mathbf{w} = \{w_k \in G_k, k \in \mathcal{I}\}$, denoted by

$$\mathcal{W} = \prod_{k \in \mathcal{I}} G_k.$$

The group operation of \mathcal{W} is defined componentwise, using the symbol group operations. If all G_k are equal to a common group G , then we write $\mathcal{W} = G^\mathcal{I}$. If $|\mathcal{I}| = n$, then we may alternatively write $\mathcal{W} = G^n$.

The finite direct product \mathcal{W} is equipped with the natural product topology [39]. If all G_k are compact (resp. locally compact), then the finite direct product $\mathcal{W} = \prod_k G_k$ is compact (resp. locally compact) [39]. If all G_k are discrete (resp. finite), then \mathcal{W} is discrete (resp. finite).

As expected, the character group of a finite direct product group is the direct product of the symbol character groups:

Theorem 2.2 (Finite direct product duality): The character group of a finite direct product $\mathcal{W} = \prod_{k \in \mathcal{I}} G_k$ of LCA groups is the finite direct product

$$\mathcal{W}^\wedge = \prod_{k \in \mathcal{I}} G_k^\wedge,$$

with pairing $\langle h, g \rangle$ defined by the componentwise sum

$$\langle h, g \rangle = \sum_{k \in \mathcal{I}} \langle h_k, g_k \rangle, \quad h \in \mathcal{W}, g \in \mathcal{W}.$$

Note that $\sum_{k \in \mathcal{I}} \langle h_k, g_k \rangle$ is well defined since \mathcal{I} is finite.

It follows that the character group of $G = \mathbb{R}^n$ is $G^\wedge = \mathbb{R}^n$, and that the pairing $\langle h, g \rangle$ between vectors $g \in \mathbb{R}^n, h \in \mathbb{R}^n$ is the ordinary inner (dot) product $h \cdot g, \text{ mod } \mathbb{Z}$.

Similarly, since every finite abelian group may be decomposed into a finite direct product of finite cyclic groups, it follows that every finite abelian group G is isomorphic to its character group G^\wedge . Moreover, if m is the exponent of G (the least integer such that $mg = 0$ for all $g \in G$), then G may be written as a subgroup of $(\mathbb{Z}_m)^n$ for some n . The character group of $(\mathbb{Z}_m)^n$ may be identified with $(\mathbb{Z}_m)^n$, and pairings may then be defined in the usual manner as inner products over the ring \mathbb{Z}_m .

C. Orthogonal subgroup duality

We now consider a second kind of duality, which will be the basis of our definition of dual codes and systems.

Let G be an LCA group with character group G^\wedge , and let S be a subset of G . The **orthogonal subgroup** to $S \subseteq G$ (the *annihilator* of S) is the set of all elements of G^\wedge that are orthogonal to all elements of S :

$$S^\perp = \{a \in G^\wedge \mid \langle a, s \rangle = 0 \text{ for all } s \in S\}.$$

The orthogonal subgroup to G itself is $G^\perp = \{0\}$, since the zero character is the unique character in G^\wedge that is orthogonal to all of G . Similarly, $\{0\}^\perp = G^\wedge$.

In topological groups, the group *generated* by a subset $S \subseteq G$ is defined as the smallest closed subgroup of G that contains S , called the *closure* S^{cl} of S . S is *closed* if $S = S^{\text{cl}}$. Thus in topological groups the notion of closure involves both algebraic and topological closure.

Orthogonal subgroups and closed subgroups are intimately linked by the following duality theorem [34]:

Theorem 2.3 (Orthogonal subgroup duality): If G is an LCA group, and S is a subset of G , then

- the orthogonal subgroup S^\perp to S is a closed subgroup of G^\wedge ;
- the orthogonal subgroup $S^{\perp\perp}$ to S^\perp is the closure S^{cl} of S in G .

It follows that S is a closed subgroup of G if and only if $S^{\perp\perp} = S$. Also, $S^{\perp\perp\perp} = S^\perp$.

We shall say that two orthogonal closed subgroups $H \subseteq G$ and $H^\perp \subseteq G^\wedge$ are *dual subgroups*. We caution the reader that when we say that a group H^\perp is the orthogonal group to H , we do not imply that H is closed, so that $H^{\perp\perp} = H$. However, if we say that two groups are dual or orthogonal groups, then we imply mutual orthogonality, and thus that both groups are closed.

This notion of duality is consistent with the usual definitions of duality in a variety of contexts:

- If $G = \mathbb{R}^n$ and H is a *subspace* of G as a vector space over \mathbb{R} , then H^\perp is the *orthogonal subspace* to H in $G^\wedge = \mathbb{R}^n$. *Proof:* for $\mathbf{g} \in G$ and $\mathbf{a} \in G^\wedge$, the pairing $\langle \mathbf{a}, \mathbf{g} \rangle$ is the ordinary dot product $\mathbf{a} \cdot \mathbf{g}, \text{ mod } \mathbb{Z}$. But a subspace H of G is scale-invariant; i.e., $\mathbf{h} \in H$ implies $\alpha \mathbf{h} \in H$ for all $\alpha \in \mathbb{R}$. Now $\mathbf{a} \cdot \alpha \mathbf{h} \equiv 0 \text{ mod } \mathbb{Z}$ for all $\alpha \in \mathbb{R}$ if and only if $\mathbf{a} \cdot \mathbf{h} = 0$. Thus

$$H^\perp = \{\mathbf{a} \in G^\wedge \mid \mathbf{a} \cdot \mathbf{h} = 0 \text{ for all } \mathbf{h} \in H\},$$

which is the usual definition of the orthogonal subspace to H .

- If $G = \mathbb{R}^n$ and H is a *lattice* in \mathbb{R}^n (a discrete subgroup of \mathbb{R}^n), then H^\perp is the *dual lattice* in $G^\wedge = \mathbb{R}^n$. *Proof:* Since $\langle \mathbf{a}, \mathbf{g} \rangle = \mathbf{a} \cdot \mathbf{g} \text{ mod } \mathbb{Z}$,

$$H^\perp = \{\mathbf{a} \in G^\wedge \mid \mathbf{a} \cdot \mathbf{h} \equiv 0 \text{ mod } \mathbb{Z} \text{ for all } \mathbf{h} \in H\},$$

which is the usual definition of the dual lattice to H .

- If $G = (\mathbb{Z}_m)^n$ and H is a subgroup (a *linear block code* of length n over \mathbb{Z}_m), then H^\perp is the *dual linear block code* in $G^\wedge = (\mathbb{Z}_m)^n$. *Proof:* Here the pairing $\langle \mathbf{a}, \mathbf{g} \rangle$ is the usual inner product over the ring \mathbb{Z}_m .

It is important to distinguish character group duality from orthogonal subgroup duality. The character group G^\wedge is often called the “dual group” to G in the mathematical literature. However, these examples show that the terms “dual code” and “dual lattice” are to be understood in the orthogonal subgroup sense. We use both types of duality in this paper; for example, we use the term “dual sequence space” in the character group sense, whereas we use the terms “dual code” and “dual system” in the orthogonal subgroup sense. We caution the reader to keep this distinction in mind, and to refer to the notation if in doubt.

D. Sum/intersection duality

Let G be a topological group, and let $\{S_j \subseteq G, j \in \mathcal{J}\}$ be a collection of subsets of G indexed by an index set \mathcal{J} , possibly infinite. For topological groups, the group *generated* by the collection, called the *sum* of the subsets $\{S_j\}$ and denoted by $\sum_{j \in \mathcal{J}} S_j$, is defined as the closure S^{cl} of the set S of all finite sums $\sum_{j \in \mathcal{J}} s_j$, where s_j denotes an element of S_j . Thus the sum (the group generated by the S_j) is closed both algebraically and topologically.

Let $\{S_j^\perp \subseteq G^\wedge, j \in \mathcal{J}\}$ be the collection of orthogonal subgroups to the subsets $\{S_j, j \in \mathcal{J}\}$. The intersection $\bigcap_{j \in \mathcal{J}} S_j^\perp$ of this set of closed subgroups is a closed subgroup of G^\wedge . Moreover, by orthogonal subgroup duality, it is the orthogonal group to the sum $\sum_{j \in \mathcal{J}} S_j$:

Theorem 2.4 (Sum/intersection duality):

$$\left(\sum_{j \in \mathcal{J}} S_j\right)^\perp = \bigcap_{j \in \mathcal{J}} S_j^\perp; \quad \sum_{j \in \mathcal{J}} S_j = \left(\bigcap_{j \in \mathcal{J}} S_j^\perp\right)^\perp.$$

Proof. Let S be the set of all finite sums $\sum_j s_j$ for all $s_j \in S_j$. Then $S^\perp = \bigcap_j S_j^\perp$, since $h \in G^\wedge$ is orthogonal to S if and only if h is in all orthogonal subgroups S_j^\perp . But by definition $\sum_j S_j = S^{\text{cl}}$, and by orthogonal subgroup duality $S^{\text{cl}} = S^{\perp\perp} = \left(\bigcap_j S_j^\perp\right)^\perp$. \square

This theorem applies particularly when the subsets S_j consist of single elements $s_j \in G$, called *generators*. The orthogonal subgroup to S_j is then the set of elements $a \in G^\wedge$ that pass the test $\langle a, s_j \rangle = 0$, called a *check* (or constraint). This theorem then says that the orthogonal subgroup to the subgroup generated by the generators $s_j, j \in \mathcal{J}$, is the set of $a \in G^\wedge$ that satisfy all checks $\langle a, s_j \rangle = 0, j \in \mathcal{J}$.

E. Quotient group duality

Let H and H^\perp be dual (closed) subgroups in G and G^\wedge . Every character g in the character group G^\wedge of G is evidently a character of H^\perp . However, since for a given $h \in H^\perp$

$$\langle h, g \rangle = \langle h, g' \rangle \Leftrightarrow \langle h, g - g' \rangle = 0,$$

two characters $g, g' \in G^\wedge$ of H^\perp are identical if and only if $g - g' \in H$, the orthogonal subgroup to H^\perp . Thus the characters of H^\perp naturally correspond one-to-one to the cosets $H+r$ of H in G , which form the quotient group G/H . Indeed, it is easy to verify that the correspondence $(H^\perp)^\wedge \leftrightarrow G/H$ is an isomorphism. In this sense, the quotient group G/H acts as the character group of H^\perp , with pairing defined by $\langle h, H+r \rangle = \langle h, r \rangle$, just as G acts as the character group of

G^\wedge . Correspondingly, H^\perp acts as the character group of G/H with the same pairing [45].

Theorem 2.5 (Subgroup/quotient group duality): If H and H^\perp are dual closed subgroups in G and G^\wedge , then G/H acts as the character group of H^\perp and *vice versa*:

$$(H^\perp)^\wedge = G/H; \quad (G/H)^\wedge = H^\perp.$$

For example, if H is a subspace of $G = \mathbb{R}^n$, and H^\perp is its orthogonal subspace, then this theorem implies that $\dim H^\perp = \dim G - \dim H$.

We note that each element of a group G with a subgroup H may be written uniquely as $g = r + h$, where r is a representative of the coset $H+g \in G/H$ and $h \in H$. There is thus a one-to-one correspondence between G and the Cartesian product $H \times G/H$, which may be viewed as a decomposition of G into two components, H and G/H . However, the two components play different roles. In general, G/H is not a subgroup of G ; moreover, G may have no subgroup isomorphic to G/H . For example, \mathbb{R} has no subgroup isomorphic to \mathbb{R}/\mathbb{Z} . Note that although the character group G^\wedge may similarly be thought of as being composed of H^\wedge and $(G/H)^\wedge$, the two components exchange roles: $(G/H)^\wedge = H^\perp$ is by definition a subgroup of G^\wedge , whereas H^\wedge is the quotient G^\wedge/H^\perp , which in general is not a subgroup of G^\wedge .

This result may be straightforwardly extended to the quotients of a finite chain $J \subseteq H \subseteq G$ of closed subgroups of G . Since $h \in H^\perp$ implies $h \in J^\perp$, the orthogonal subgroup chain runs in the reverse order: $H^\perp \subseteq J^\perp \subseteq G^\wedge$. For $g \in H, h \in J^\perp$, the value of the pairing $\langle h, g \rangle$ depends only on the cosets $J+g, H^\perp+h$ of J and H^\perp in H and J^\perp , respectively. Therefore H/J and J^\perp/H^\perp act as dual character groups, with pairing defined by $\langle H^\perp+h, J+g \rangle = \langle h, g \rangle$. In summary:

Theorem 2.6 (Quotient group duality): If $J \subseteq H \subseteq G$, then the dual quotient group J^\perp/H^\perp to H/J acts as the character group of H/J : $(H/J)^\wedge = J^\perp/H^\perp$.

Quotient groups such as H/J and J^\perp/H^\perp will be called **dual quotient groups**.

The *dual diagrams* below illustrate two chains of subgroups, with their quotients. The right chain is obtained by inverting the left chain, replacing subgroups by their orthogonal subgroups, and replacing quotient groups by their character groups.

$$\begin{array}{ccc} G & & \{0\}^\perp = G^\wedge \\ | & G/H & | & G^\wedge/J^\perp = J \\ H & & | & J^\perp/H^\perp = (H/J)^\wedge \\ | & H/J & | & H^\perp \\ J & & | & H^\perp = (G/H)^\wedge \\ | & J & | & \\ \{0\} & & | & G^\perp = \{0\} \end{array}$$

The following dual diagrams illustrate the chain of elementary groups $\{0\} \subseteq m\mathbb{Z} \subseteq \mathbb{Z} \subseteq \mathbb{R}$, whose quotients are $m\mathbb{Z} \cong \mathbb{Z}, \mathbb{Z}/m\mathbb{Z} = \mathbb{Z}_m$, and \mathbb{R}/\mathbb{Z} , and its dual chain

$$\{0\} \subseteq \mathbb{Z}^\perp = \mathbb{Z} \subseteq (m\mathbb{Z})^\perp = m^{-1}\mathbb{Z} \subseteq \mathbb{R}^\wedge = \mathbb{R},$$

whose quotients are congruent to $\mathbb{Z} \cong (\mathbb{R}/\mathbb{Z})^\wedge, \mathbb{Z}_m \cong (\mathbb{Z}_m)^\wedge$, and $\mathbb{R}/\mathbb{Z} \cong (m\mathbb{Z})^\wedge$, respectively. Indeed, the dual chain is just the primal chain scaled by m^{-1} .

$$\begin{array}{ccc}
 \mathbb{R} & & \mathbb{R}^\wedge = \mathbb{R} \\
 | & \mathbb{R}/\mathbb{Z} & | \\
 \mathbb{Z} & & \mathbb{R}/(m^{-1}\mathbb{Z}) \cong \mathbb{R}/\mathbb{Z} \\
 | & (m\mathbb{Z})^\perp = m^{-1}\mathbb{Z} & | \\
 m\mathbb{Z} & & \mathbb{R}/(m^{-1}\mathbb{Z})/\mathbb{Z} \cong \mathbb{Z}_m \\
 | & \mathbb{Z}/m\mathbb{Z} = \mathbb{Z}_m & | \\
 | & m\mathbb{Z} \cong \mathbb{Z} & | \\
 \{0\} & & \mathbb{Z} \\
 & & | \\
 & & \{0\}
 \end{array}$$

F. Adjoint duality

Quotient group duality is a special case of a general duality principle for adjoint homomorphisms.

Let $\phi: G \rightarrow U$ be a homomorphism of an LCA group G to another LCA group U . The *adjoint homomorphism*

$$\phi^*: U^\wedge \rightarrow G^\wedge$$

is the unique homomorphism such that $\langle v, \phi(g) \rangle = \langle \phi^*(v), g \rangle$ for all $g \in G, v \in U^\wedge$, where G^\wedge and U^\wedge are the character groups of G and U , respectively. Explicitly, the adjoint character $\phi^*(v)$ is the unique character in G^\wedge whose values are given by $\phi^*(v)(g) = \langle v, \phi(g) \rangle$. Evidently the adjoint of ϕ^* is ϕ ; i.e., $\phi^{**} = \phi$.

For example, let H be a closed subgroup of G , and let $\phi: G \rightarrow G/H$ be the natural map defined by $\phi(g) = H + g$. Since H^\perp acts as the character group of G/H , with $\langle v, H + g \rangle = \langle v, g \rangle$ for $g \in G, v \in H^\perp \subseteq G^\wedge$, the adjoint $\phi^*: H^\perp \rightarrow G^\wedge$ is the inclusion of H^\perp into G^\wedge .

The fundamental adjoint duality theorem is as follows:

Theorem 2.7 (Adjoint duality): Given adjoint homomorphisms $\phi: G \rightarrow U$, $\phi^*: U^\wedge \rightarrow G^\wedge$, the kernel of ϕ is the orthogonal subgroup in G^\wedge to the image of ϕ^* .

Proof. We show that $g \in (\text{im } \phi^*)^\perp$ if and only if $g \in \ker \phi$. Let $g \in \ker \phi$; i.e., $\phi(g) = 0$. Then $\langle \phi^*(v), g \rangle = \langle v, \phi(g) \rangle = 0$; i.e., every $g \in \ker \phi$ is orthogonal to $\phi^*(v) \in G^\wedge$ for all $v \in U^\wedge$. Conversely, if g is not in $\ker \phi$, then $\phi(g) \neq 0$, so $\langle \phi^*(v), g \rangle = \langle v, \phi(g) \rangle \neq 0$ for some $\phi^*(v) \in G^\wedge$, because $0 \in U$ is the unique character $u \in U = U^\wedge$ such that $\langle v, u \rangle = 0$ for all $v \in U^\wedge$. \square

Note that whereas the kernel of ϕ is necessarily closed, the image of ϕ^* may not be closed; the orthogonal subgroup to $\ker \phi$ is therefore the closure of $\text{im } \phi^*$.

In our example, the kernel H of the natural map $\phi: G \rightarrow G/H$ is indeed the orthogonal subgroup in G to the image H^\perp of the inclusion $\phi^*: H^\perp \rightarrow G^\wedge$. Also, the kernel of ϕ^* is $\{0\} \subseteq H^\perp$ and the image of ϕ is the trivially orthogonal subgroup $G/H = (H^\perp)^\wedge$ in $(H^\perp)^\wedge$.

The decomposition of G into H and G/H is sometimes illustrated by the following *short exact sequence*:

$$\{0\} \rightarrow H \rightarrow G \rightarrow G/H \rightarrow \{0\},$$

where the first two maps are inclusions and the second two are natural maps. (“Exact” means that the image of each map is the kernel of the next.) The adjoint short exact sequence

$$\{0\} \rightarrow (G/H)^\wedge = H^\perp \rightarrow G^\wedge \rightarrow H^\wedge = G^\wedge/H^\perp \rightarrow \{0\},$$

illustrates the exchange of roles upon which we previously remarked.

A subgroup chain such as $\{0\} \subseteq J \subseteq H \subseteq G$ implies a chain of inclusion maps, e.g.,

$$\{0\} \rightarrow J \rightarrow H \rightarrow G.$$

The adjoint chain runs in the opposite direction,

$$G^\wedge \rightarrow H^\wedge \rightarrow J^\wedge \rightarrow \{0\},$$

and consists of a chain of natural maps with kernels $H^\perp = (G/H)^\wedge$, $J^\perp/H^\perp = (H/J)^\wedge$, and $G^\wedge/J^\perp = J^\wedge$, illustrating the same decomposition of G^\wedge as in the first dual diagram above.

III. DUAL SEQUENCE SPACES

A group code or system (behavior) \mathcal{C} is a subgroup of a sequence space \mathcal{W} . In this section we define complete, Laurent and finite topological sequence spaces, and determine their character groups (dual sequence spaces) \mathcal{W}^\wedge . We briefly discuss more general memoryless sequence spaces.

A. Complete and finite sequence spaces

We now let the discrete index \mathcal{I} be possibly countably infinite: e.g., $\mathcal{I} = \mathbb{Z}$. In general, \mathcal{I} need not be ordered; for example, we could consider an n -dimensional index set such as $\mathcal{I} = \mathbb{Z}^n$. However, for simplicity we will assume $\mathcal{I} \subseteq \mathbb{Z}$ from now on. We will continue to call a set indexed by \mathcal{I} a *sequence*.

Given a set of LCA symbol groups $\{G_k, k \in \mathcal{I}\}$ indexed by \mathcal{I} , their **direct product** is again defined as the Cartesian product set of all sequences $\mathbf{w} = \{w_k \in G_k, k \in \mathcal{I}\}$, now denoted by

$$\mathcal{W}^c = \prod_{k \in \mathcal{I}} G_k.$$

We call a direct product \mathcal{W}^c a **complete sequence space**. Its group operation is still defined componentwise. We continue to write $\mathcal{W}^c = G^\mathcal{I}$ if all symbol groups are equal to G .

The complete sequence space \mathcal{W}^c is equipped with the natural product topology [39]. If all symbol groups G_k are compact, then under the product topology \mathcal{W}^c is compact. However, even when all symbol groups are locally compact, \mathcal{W}^c need not be locally compact [39].

In topology, “completeness” is a property of metric spaces (every Cauchy sequence converges). A *metric space* is a topological space whose topology is induced by a *distance function* $d(\cdot, \cdot)$ that satisfies the distance axioms: strict positivity, symmetry, and the triangle inequality.

For example, if $\mathcal{I} \subseteq \mathbb{Z}$ and all G_k are discrete, then the product topology is induced by the distance metric

$$d(\mathbf{w}, \mathbf{w}') = 2^{-l(\mathbf{w}, \mathbf{w}')},$$

where $l(\mathbf{w}, \mathbf{w}')$ is the least absolute value $|k|$ of an index $k \in \mathcal{I}$ such that $w_k \neq w'_k$. In other words, two sequences are regarded as “close” if they agree over a large central interval. In this case the product topology is also called the *topology of pointwise convergence*, because a series $\{\mathbf{w}^n, n \in \mathbb{N}\}$ converges to \mathbf{w} if and only if, for all $k \in \mathcal{I}$, $w_k^n = w_k$ for all sufficiently large n .

In general, a topological direct product $\mathcal{W}^c = \prod_{\mathcal{I}} G_k$ is complete if and only if all G_k are complete [40, II.3.5]. We will therefore assume from now on that all symbol groups G_k are complete metric spaces. Moreover, a countable direct product \mathcal{W}^c of complete metric spaces is metrizable (can be endowed with a metric under which it is a metric space) [40, II.3.8].

In a complete metric space, a subspace is complete if and only if it is closed [40, II.3.2]. Since all sequence spaces we consider will be complete metric spaces, we will generally use the term “closed” rather than “complete” for subspaces. We will reserve the term “complete” to mean “closed in the product topology;” *i.e.*, as a subspace of a complete sequence space \mathcal{W}^c .

In behavioral system theory, a behavior $\mathcal{C} \subseteq \mathcal{W}^c$ is called “complete” if whenever a sequence $\mathbf{w} \in \mathcal{W}^c$ satisfies all finite \mathcal{C} -checks, then $\mathbf{w} \in \mathcal{C}$. As we will discuss in Section 4.6, this notion of completeness usually coincides with the topological definition, but may need to be generalized.

On the other hand, the **direct sum** of the symbol groups $\{G_k, k \in \mathcal{I}\}$ is defined as the subset of \mathcal{W}^c comprising the sequences $\mathbf{w} = \{w_k\}$ in which only finitely many symbol values w_k are nonzero (sometimes called the set of “Laurent polynomials” in system theory), denoted by

$$\mathcal{W}_f = \bigoplus_{k \in \mathcal{I}} G_k.$$

We will call a direct sum \mathcal{W}_f a **finite sequence space**. Sums are still defined componentwise, and \mathcal{W}_f is evidently closed under finite sums. If all symbol groups are equal to a common group G , then we write $\mathcal{W}_f = (G^{\mathcal{I}})_f$.

The direct sum \mathcal{W}_f is equipped with the natural sum topology [39]. If all G_k are discrete, then the sum topology is simply the discrete topology (the topology induced by the Hamming metric). Such a setting is purely algebraic, with no additional topological structure. If all symbol groups are complete, then \mathcal{W}_f is topologically complete under the sum topology.

If \mathcal{I} is finite, then there is no distinction between a direct product \mathcal{W}^c and the corresponding direct sum \mathcal{W}_f , either algebraically or topologically. However, if \mathcal{I} is infinite, then \mathcal{W}_f is a proper subset of \mathcal{W}^c , and the sum topology of \mathcal{W}_f is in general different from the topology of \mathcal{W}_f as a subspace of \mathcal{W}^c . In particular, \mathcal{W}_f is not closed in \mathcal{W}^c , and its closure is $(\mathcal{W}_f)^c = \mathcal{W}^c$, where the first superscript “*c*” denotes closure or completion in \mathcal{W}^c .

B. Direct product/direct sum duality

Although an infinite direct product of LCA groups is not necessarily LCA, the following duality theorem nevertheless holds [22]:

Theorem 3.1 (Direct product/direct sum duality): The character group of a direct product $\mathcal{W}^c = \prod_{k \in \mathcal{I}} G_k$ of LCA groups is the direct sum

$$(\mathcal{W}^c)^\wedge = \bigoplus_{k \in \mathcal{I}} G_k^\wedge,$$

with pairing $\langle h, g \rangle$ defined by the componentwise sum

$$\langle h, g \rangle = \sum_{k \in \mathcal{I}} \langle h_k, g_k \rangle$$

for $h \in (\mathcal{W}^c)^\wedge, g \in \mathcal{W}^c$.

Note that the sum $\sum_{k \in \mathcal{I}} \langle h_k, g_k \rangle$ is well defined, since only finitely many h_k are nonzero.

In other words, the dual of a complete sequence space is the finite sequence space with the dual symbol groups, and *vice versa*.

C. Laurent sequence spaces

In convolutional coding theory and classical linear system theory, all sequences are usually semi-infinite Laurent sequences—*i.e.*, sequences that have only finitely many nonzero symbol values before some arbitrary time, say $k = 0$, or equivalently that have a definite “starting time.”

A natural definition of a **Laurent sequence space** is the direct product of a finite sequence space defined on the “past,” $\mathcal{I}^- = \{k \in \mathcal{I} \mid k < 0\}$ and a complete sequence space defined on the “future,” $\mathcal{I}^+ = \{k \in \mathcal{I} \mid k \geq 0\}$:

$$\mathcal{W}_L = \left(\bigoplus_{k \in \mathcal{I}^-} G_k \right) \times \left(\prod_{k \in \mathcal{I}^+} G_k \right),$$

We call \mathcal{W}_L the *Laurent product* of the symbol groups $\{G_k, k \in \mathcal{I}\}$.

Similarly, we define an *anti-Laurent sequence space* by the *anti-Laurent product*

$$\mathcal{W}_{\bar{L}} = \left(\prod_{k \in \mathcal{I}^-} G_k \right) \times \left(\bigoplus_{k \in \mathcal{I}^+} G_k \right).$$

By direct product/direct sum duality, it is immediate that the dual of a Laurent sequence space is an anti-Laurent sequence space:

Theorem 3.2 (Laurent/anti-Laurent duality): . The anti-Laurent sequence space $\mathcal{X}_{\bar{L}} = (\prod_{k \in \mathcal{I}^-} G_k)^\wedge \times (\bigoplus_{k \in \mathcal{I}^+} G_k)^\wedge$ acts as the character group of the Laurent sequence space $\mathcal{W}_L = (\bigoplus_{k \in \mathcal{I}^-} G_k) \times (\prod_{k \in \mathcal{I}^+} G_k)$, and *vice versa*: $(\mathcal{W}_L)^\wedge = \mathcal{X}_{\bar{L}}$.

Note that in this case, for $\mathbf{x} \in \mathcal{X}_{\bar{L}}, \mathbf{w} \in \mathcal{W}_L$, the pairing $\langle \mathbf{x}, \mathbf{w} \rangle = \sum_{k \in \mathcal{I}} \langle x_k, w_k \rangle$ is well defined, because only finitely many pairings $\langle x_k, w_k \rangle$ are nonzero.

It is customary to reverse the direction of time in the dual sequence space $\mathcal{X}_{\bar{L}}$, so that it also becomes a Laurent sequence space. This yields a nice symmetry between the primal and dual spaces, which is lacking for the complete/finite pair.

D. Memorylessness

Memorylessness is a set-theoretic property of a subset \mathcal{V} of a Cartesian product sequence space $\mathcal{W}^c = \prod_{k \in \mathcal{I}} G_k$. The subset \mathcal{V} will be called **memoryless** if for any partition of the index set \mathcal{I} into two disjoint subsets \mathcal{J} and $\mathcal{I} - \mathcal{J}$, if $\mathcal{V}|_{\mathcal{J}}$ and $\mathcal{V}|_{\mathcal{I} - \mathcal{J}}$ are the corresponding restrictions of \mathcal{V} (see Section 4.3), then \mathcal{V} is the Cartesian product

$$\mathcal{V} = \mathcal{V}|_{\mathcal{J}} \times \mathcal{V}|_{\mathcal{I} - \mathcal{J}}.$$

In general, \mathcal{V} will be called a *sequence space* if and only if \mathcal{V} is memoryless. It is easily verified that complete, finite and Laurent sequence spaces are memoryless.

Another example of a memoryless sequence space is the set l_2 of all square-summable sequences in a real or complex complete sequence space \mathcal{W}^c . The character group of l_2 is the dual square-summable sequence space l_2 . More generally, for $1 \leq p \leq \infty$, the set l_p of all p -power-summable sequences is memoryless, and its character group is $(l_p)^\wedge = l_q$, where $\frac{1}{p} + \frac{1}{q} = 1$ [39].

Given a set of symbol groups $\{G_k, k \in \mathcal{I}\}$, the direct product $\mathcal{W}^c = \prod_{k \in \mathcal{I}} G_k$ is clearly the largest possible sequence space with these symbol groups, since it consists of all possible sequences \mathbf{w} such that $w_k \in G_k$ for all $k \in \mathcal{I}$. Conversely, the direct sum $\mathcal{W}_f = \bigoplus_{k \in \mathcal{I}} G_k$ is the smallest memoryless sequence space \mathcal{V} such that $\mathcal{V}|_k = G_k$ for all $k \in \mathcal{I}$, since by memorylessness the finite sequence $(\prod_{j \in \mathcal{J}} \mathcal{V}_j) \times 0_{|\mathcal{I}-\mathcal{J}}$ must be in \mathcal{V} for any finite $\mathcal{J} \subseteq \mathcal{I}$. It follows that if \mathcal{I} is finite, then $\mathcal{W}^c = \mathcal{W}_f$ is the only possible memoryless sequence space with symbol groups $\{G_k\}$.

IV. DUAL GROUP CODES

A group code, system or behavior is a subgroup \mathcal{C} of a sequence space \mathcal{W} . In the topological group setting, it is natural to define a *topological group code* or system to be a *closed* subgroup of a topological sequence space. Therefore, unless stated otherwise, the term **group code** will hereafter mean a closed subgroup \mathcal{C} of a complete, finite or Laurent sequence space \mathcal{W} .

In this section we establish the basic duality between a closed group code \mathcal{C} and its dual code \mathcal{C}^\perp . This shows that the dual code of a complete code is a finite code, and *vice versa*. We show that if \mathcal{C} has certain symmetries such as linearity or time-invariance, then so does \mathcal{C}^\perp . We prove a basic projection/subcode duality theorem. A more general principle is conditioned subcode duality, which can be regarded as a fundamental behavioral control theorem. We discuss the meaning of completeness in both a topological and behavioral sense, and agree to define completeness here as closure in a complete sequence space (*i.e.*, closed in the product topology). Completeness is then dual to finiteness. We briefly discuss Laurent completion and ‘‘Laurentization.’’ Finally, we define dual notions of controllability and observability, based on the notions of completion and finitization. Several example codes are given to illustrate these concepts.

A. Group code duality

We define the **dual code** \mathcal{C}^\perp to a group code $\mathcal{C} \subseteq \mathcal{W}$ as the orthogonal subgroup to \mathcal{C} in the dual sequence space \mathcal{W}^\wedge . By orthogonal subgroup duality, we have immediately:

Theorem 4.1 (Group code duality): If $\mathcal{C} \subseteq \mathcal{W}$ is a (closed) group code, then its dual \mathcal{C}^\perp is a (closed) group code in \mathcal{W}^\wedge , and $\mathcal{C}^{\perp\perp} = \mathcal{C}$.

Thus, given \mathcal{W} , a group code \mathcal{C} is completely characterized by its dual code \mathcal{C}^\perp , and *vice versa*. Moreover, the dual code of a complete code is a finite code, and *vice versa*.

If all symbol groups G_k are discrete, then the finite sequence space $\mathcal{W}_f = \bigoplus_{\mathcal{I}} G_k$ is discrete, so every subgroup \mathcal{C} of \mathcal{W}_f is closed. In other words, this discrete setting is purely algebraic and topology may be ignored, even when \mathcal{I} is infinite.

The dual sequence space of $\mathcal{W}_f = \bigoplus_{\mathcal{I}} G_k$ is the complete sequence space $(\mathcal{W}_f)^\wedge = \prod_{\mathcal{I}} G_k^\wedge$. If each G_k is discrete, then each G_k^\wedge is compact and $(\mathcal{W}_f)^\wedge$ is compact. By the orthogonal subgroup duality theorem, the closed subgroups of $(\mathcal{W}_f)^\wedge$ are precisely those subgroups that are duals of group codes in \mathcal{W}_f .

Thus whereas all subgroups of \mathcal{W}_f are closed, only certain subgroups of $(\mathcal{W}_f)^\wedge$ are closed. This asymmetry should not be surprising, since even if $G_k^\wedge \cong G_k$, the complete sequence space $(\mathcal{W}_f)^\wedge$ is much larger than the finite sequence space \mathcal{W}_f , and by Theorem 4.1 there is a one-to-one correspondence between codes in $(\mathcal{W}_f)^\wedge$ and codes in \mathcal{W}_f .

Behavioral system theory has traditionally restricted itself to complete behaviors.¹ But we observe that the dual of a complete group behavior $\mathcal{C} \subseteq \mathcal{W}^c$ is a finite behavior $\mathcal{C}^\perp \in (\mathcal{W}^c)^\wedge$. Thus any theory that encompasses both complete behaviors and their duals must encompass non-complete behaviors, particularly finite behaviors.

B. Linearity and time-invariance

In this subsection we briefly discuss the important properties of linearity and time-invariance. As in [15], linearity and time-invariance play no essential role in our development, although we often use linear and/or time-invariant codes as examples. Within our group-theoretic framework, linearity and time-invariance are simply additional symmetries of a group code, which are reflected by dual symmetries in the dual group code.

A group code $\mathcal{C} \subseteq (\mathbb{R}^n)^\mathcal{I}$ over the real field \mathbb{R} is *linear* if it is invariant under all isomorphisms $\alpha: (\mathbb{R}^n)^\mathcal{I} \rightarrow (\mathbb{R}^n)^\mathcal{I}$ defined by scalar multiplication by a nonzero scalar $\alpha \neq 0 \in \mathbb{R}$. Since $\langle \mathbf{x}, \alpha \mathbf{w} \rangle = \langle \alpha \mathbf{x}, \mathbf{w} \rangle$, the dual \mathcal{C}^\perp of a linear code \mathcal{C} is linear.

Similarly, a group code $\mathcal{C} \subseteq \mathcal{W}$ is *time-invariant* (or shift-invariant) if the time axis is $\mathcal{I} = \mathbb{Z}$, if all symbol groups are the same, and if \mathcal{C} is invariant under the delay isomorphism $D: \mathcal{W} \rightarrow \mathcal{W}$ defined by $D(\mathbf{w})|_k = w_{k-1}$; *i.e.*, if $D\mathcal{C} = \mathcal{C}$. Since $\langle \mathbf{x}, D(\mathbf{w}) \rangle = \langle D^{-1}(\mathbf{x}), \mathbf{w} \rangle$, the dual \mathcal{C}^\perp of a time-invariant group code \mathcal{C} satisfies $D^{-1}\mathcal{C}^\perp = \mathcal{C}^\perp$ and is thus time-invariant.

If $\mathcal{C} \subseteq (\mathbb{R}^n)^\mathbb{Z}$ is both linear and time-invariant, then $\langle \mathbf{x}, \mathbf{w} \rangle = (\tilde{\mathbf{x}} * \mathbf{w})_0$, where $\tilde{\mathbf{x}}$ is the time-reverse of \mathbf{x} and ‘‘*’’ denotes convolution. More generally, $\langle \mathbf{x}, D^k(\mathbf{w}) \rangle = (\tilde{\mathbf{x}} * \mathbf{w})_k$. It follows that \mathbf{x} is in \mathcal{C}^\perp if and only if the convolution $\tilde{\mathbf{x}} * \mathbf{w}$ is the zero sequence $\mathbf{0}$ for all $\mathbf{w} \in \mathcal{C}$. This shows that pairings of linear time-invariant code sequences may be evaluated by sequence convolutions, and further motivates inverting the direction of time in the dual sequence space \mathcal{W}^\wedge .

C. Restrictions, projections and subcodes

In [15], we asserted that projections and subcodes of a group code \mathcal{C} play dual roles. This will turn out to be our key dynamical principle.

¹Indeed, Willems [46, p. 567] has asserted, no doubt whimsically, that ‘‘the study of non-complete systems does not fall within the competence of system theorists and could be better left to cosmologists or theologians...’’

Let \mathcal{W} be a sequence space defined on an index set \mathcal{I} , let $\mathcal{J} \subseteq \mathcal{I}$ be a subset of \mathcal{I} , and let $\mathcal{I} - \mathcal{J}$ be the complementary subset.

The **restriction** $R_{\mathcal{J}}: \mathcal{W} \rightarrow \mathcal{W}_{|\mathcal{J}}$ defined by $R_{\mathcal{J}}(\mathbf{w}) = \mathbf{w}_{|\mathcal{J}} = \{w_k, k \in \mathcal{J}\}$ is a continuous homomorphism. Since \mathcal{W} is memoryless, $\mathcal{W} = \mathcal{W}_{|\mathcal{J}} \times \mathcal{W}_{|\mathcal{I}-\mathcal{J}}$, the image of the homomorphism is $\mathcal{W}_{|\mathcal{J}}$ and its kernel is $\{\mathbf{0}\}_{|\mathcal{J}} \times \mathcal{W}_{|\mathcal{I}-\mathcal{J}}$. The topology of $\mathcal{W}_{|\mathcal{J}}$ is induced from that of \mathcal{W} .

The **projection** $P_{\mathcal{J}}: \mathcal{W} \rightarrow \mathcal{W}$ is an essentially identical map defined by $P_{\mathcal{J}}(\mathbf{w}) = (\mathbf{w}_{|\mathcal{J}}, \mathbf{0}_{|\mathcal{I}-\mathcal{J}})$, a continuous homomorphism with the same kernel whose image is $P_{\mathcal{J}}(\mathcal{W}) = \mathcal{W}_{|\mathcal{J}} \times \{\mathbf{0}\}_{|\mathcal{I}-\mathcal{J}}$.

Let \mathcal{C} be a closed subgroup of \mathcal{W} . Then the kernel of either the restriction $R_{\mathcal{J}}: \mathcal{C} \rightarrow \mathcal{W}_{|\mathcal{J}}$ or the projection $P_{\mathcal{J}}: \mathcal{C} \rightarrow \mathcal{W}$ is the **subcode** $\mathcal{C}_{:\mathcal{I}-\mathcal{J}} = \mathcal{C} \cap (\{\mathbf{0}\}_{|\mathcal{J}} \times \mathcal{W}_{|\mathcal{I}-\mathcal{J}})$, namely the set of all code sequences $\mathbf{w} \in \mathcal{C}$ such that $w_k = 0$ when $k \in \mathcal{J}$. As the kernel of a continuous homomorphism of \mathcal{C} , a subcode $\mathcal{C}_{:\mathcal{I}-\mathcal{J}}$ is a closed subgroup of \mathcal{C} .

Similarly, the restriction $\mathcal{C}_{|\mathcal{I}-\mathcal{J}} = (\mathcal{C}_{:\mathcal{I}-\mathcal{J}})_{|\mathcal{I}-\mathcal{J}}$ of the subcode $\mathcal{C}_{:\mathcal{I}-\mathcal{J}}$ to $\mathcal{I} - \mathcal{J}$, which is isomorphic to $\mathcal{C}_{:\mathcal{I}-\mathcal{J}}$, is a closed subgroup of the *restricted code* $\mathcal{C}_{|\mathcal{I}-\mathcal{J}} = R_{\mathcal{I}-\mathcal{J}}(\mathcal{C})$.

By the fundamental homomorphism theorem, the image $\mathcal{C}_{|\mathcal{J}}$ of $R_{\mathcal{J}}: \mathcal{C} \rightarrow \mathcal{W}_{|\mathcal{J}}$ (or the image $\mathcal{C}_{|\mathcal{J}} \times \{\mathbf{0}\}_{|\mathcal{I}-\mathcal{J}}$ of $P_{\mathcal{J}}: \mathcal{C} \rightarrow \mathcal{W}$) is algebraically isomorphic to the quotient group $\mathcal{C}/\mathcal{C}_{:\mathcal{I}-\mathcal{J}}$.

However, we caution that in certain atypical cases the topology of the restriction $\mathcal{C}_{|\mathcal{J}}$ as a subspace of $\mathcal{W}_{|\mathcal{J}}$ is not necessarily consistent with the topology of the quotient group $\mathcal{C}/\mathcal{C}_{:\mathcal{I}-\mathcal{J}}$. In particular, even though $\mathcal{C}/\mathcal{C}_{:\mathcal{I}-\mathcal{J}}$ is necessarily closed, $\mathcal{C}_{|\mathcal{J}}$ may not be closed in $\mathcal{W}_{|\mathcal{J}}$.

Example 1. Let $\mathcal{W} = \mathbb{R}^2$, and let \mathcal{C} be an irrational lattice in \mathbb{R}^2 ; e.g., the lattice

$$\mathcal{C} = \{(am + bn, -bm + an) \mid (m, n) \in \mathbb{Z}^2\},$$

where the ratio a/b is irrational. \mathcal{C} is discrete, and thus a closed subgroup of \mathbb{R}^2 . The restriction $\mathcal{C}_{|\mathcal{J}}$ of \mathcal{C} to either coordinate is $\mathcal{C}_{|\mathcal{J}} = \{am + bn \mid (m, n) \in \mathbb{Z}^2\}$. The kernel of the restriction is $\mathcal{C}_{:\mathcal{I}-\mathcal{J}} = \{\mathbf{0}\}$, since $am + bn = 0$ implies $m = n = 0$ when a/b is irrational. Thus $\mathcal{C}/\mathcal{C}_{:\mathcal{I}-\mathcal{J}}$ is discrete and homeomorphic to \mathbb{Z}^2 .

On the other hand, as a subspace of $\mathcal{W}_{|\mathcal{J}} = \mathbb{R}$, the restriction $\mathcal{C}_{|\mathcal{J}}$ is not closed, but rather is a dense subgroup of \mathbb{R} whose closure is $(\mathcal{C}_{|\mathcal{J}})^{\text{cl}} = \mathbb{R}$. Thus these two topologies are inconsistent.

Notice that, by orthogonal subgroup duality, $(\mathcal{C}_{|\mathcal{J}})^{\perp} = \{0\}$ and $(\mathcal{C}_{|\mathcal{J}})^{\perp\perp} = \mathbb{R}$. Therefore projection/subcode duality (see next subsection) holds in the form $\mathcal{C}_{|\mathcal{J}} = (\mathcal{C}_{|\mathcal{J}})^{\perp\perp}$, even though $(\mathcal{C}_{|\mathcal{J}})^{\perp} \neq \mathcal{C}_{|\mathcal{J}}$ (rather, $(\mathcal{C}_{|\mathcal{J}})^{\perp} = (\mathcal{C}_{|\mathcal{J}})^{\text{cl}}$). \square

It can be shown that a restriction $\mathcal{C}_{|\mathcal{J}}$ is closed in $\mathcal{W}_{|\mathcal{J}}$ if the sequence space \mathcal{W} is discrete (because all subgroups are closed in the discrete topology), or if \mathcal{W} is compact (the dual to the discrete case; see Section 5.3), or if $\mathcal{W} = (\mathbb{R}^n)^{\mathcal{I}}$ and \mathcal{C} is a subspace (since subspaces of \mathbb{R}^n are closed in the Euclidean topology). As these are the cases of most interest in coding and system theory, the potential pathology illustrated by Example 1 may usually be ignored; i.e., restrictions and projections are usually closed subgroups of their respective sequence spaces. We discuss this point again in Section 5.3.

D. Projection/subcode duality

The results of this subsection follow from the simple observation that for $\mathbf{w} \in \mathcal{W}$, $\mathbf{x} \in \mathcal{W}^{\wedge}$, the pairing $\langle \mathbf{x}, \mathbf{w} \rangle$ may be decomposed as follows:

$$\langle \mathbf{x}, \mathbf{w} \rangle = \langle \mathbf{x}_{|\mathcal{J}}, \mathbf{w}_{|\mathcal{J}} \rangle + \langle \mathbf{x}_{|\mathcal{I}-\mathcal{J}}, \mathbf{w}_{|\mathcal{I}-\mathcal{J}} \rangle.$$

Lemma 4.2 (Restricted sequence spaces): Let \mathcal{W} be a sequence space defined on an index set \mathcal{I} , let \mathcal{W}^{\wedge} be its dual sequence space, and let \mathcal{J} be any subset of \mathcal{I} ; then

- (i) $(\mathcal{W}_{|\mathcal{J}})^{\wedge} = (\mathcal{W}^{\wedge})_{|\mathcal{J}}$; i.e., the character group of a restriction $(\mathcal{W}_{|\mathcal{J}})^{\wedge}$ is the corresponding restriction of \mathcal{W}^{\wedge} .
- (ii) $\mathcal{W} = \mathcal{W}_{|\mathcal{J}} \times \mathcal{W}_{|\mathcal{I}-\mathcal{J}}$ implies $\mathcal{W}^{\wedge} = (\mathcal{W}^{\wedge})_{|\mathcal{J}} \times (\mathcal{W}^{\wedge})_{|\mathcal{I}-\mathcal{J}}$; i.e., if \mathcal{W} is memoryless, then \mathcal{W}^{\wedge} is memoryless.
- (iii) $P_{\mathcal{J}}(\mathcal{W})^{\perp} = P_{\mathcal{I}-\mathcal{J}}(\mathcal{W}^{\wedge})$; i.e., the orthogonal subgroup to the projection $P_{\mathcal{J}}(\mathcal{W})$ is the complementary projection of \mathcal{W}^{\wedge} .

Our central result is then the following projection/subcode duality theorem:

Theorem 4.3 (Projection/subcode duality): Let \mathcal{C} and \mathcal{C}^{\perp} be orthogonal closed group codes in sequence spaces \mathcal{W} and \mathcal{W}^{\wedge} , respectively. Then the orthogonal subgroup to the restriction $\mathcal{C}_{|\mathcal{J}}$ is the restricted subcode $(\mathcal{C}^{\perp})_{|\mathcal{J}}$.

Proof. Since $\langle (\mathbf{x}_{|\mathcal{J}}, \mathbf{0}_{|\mathcal{I}-\mathcal{J}}), \mathbf{w} \rangle = \langle \mathbf{x}_{|\mathcal{J}}, \mathbf{w}_{|\mathcal{J}} \rangle$, we have the following logical chain:

$$\begin{aligned} \mathbf{x}_{|\mathcal{J}} \perp \mathcal{C}_{|\mathcal{J}} &\Leftrightarrow (\mathbf{x}_{|\mathcal{J}}, \mathbf{0}_{|\mathcal{I}-\mathcal{J}}) \perp \mathcal{C} \\ &\Leftrightarrow (\mathbf{x}_{|\mathcal{J}}, \mathbf{0}_{|\mathcal{I}-\mathcal{J}}) \in \mathcal{C}^{\perp} \\ &\Leftrightarrow \mathbf{x}_{|\mathcal{J}} \in (\mathcal{C}^{\perp})_{|\mathcal{J}}. \quad \square \end{aligned}$$

Note that if $\mathcal{C}_{|\mathcal{J}}$ is not closed, then the orthogonal subgroup to $(\mathcal{C}^{\perp})_{|\mathcal{J}}$ is the closure of $\mathcal{C}_{|\mathcal{J}}$.

In the language of coding theory, this theorem is stated as follows: the dual of a punctured code is the corresponding shortened code of the dual code.

This result immediately implies various corollaries:

Corollary 4.4 (Projection/subcode duality corollaries):

Under the same conditions:

- (a) The orthogonal subgroup to the projection $P_{\mathcal{J}}(\mathcal{C}) = \mathcal{C}_{|\mathcal{J}} \times \{\mathbf{0}\}_{|\mathcal{I}-\mathcal{J}}$ is $(\mathcal{C}^{\perp})_{|\mathcal{J}} \times (\mathcal{W}^{\wedge})_{|\mathcal{I}-\mathcal{J}}$.
- (b) The orthogonal subgroup to the restricted subcode $\mathcal{C}_{|\mathcal{J}}$ is the closure of $(\mathcal{C}^{\perp})_{|\mathcal{J}}$ in $(\mathcal{W}^{\wedge})_{|\mathcal{J}}$.
- (c) The orthogonal subgroup to the subcode $\mathcal{C}_{:\mathcal{J}}$ is the closure of $(\mathcal{C}^{\perp})_{|\mathcal{J}} \times (\mathcal{W}^{\wedge})_{|\mathcal{I}-\mathcal{J}}$ in \mathcal{W}^{\wedge} .
- (d) If $\mathcal{C}_{|\mathcal{J}}$ is closed in $\mathcal{W}_{|\mathcal{J}}$, then $\mathcal{C}_{|\mathcal{J}}$ and $(\mathcal{C}^{\perp})_{|\mathcal{J}}$ are dual group codes.
- (e) The orthogonal subgroup to the direct product $\mathcal{C}_{|\mathcal{J}} \times \mathcal{C}_{|\mathcal{I}-\mathcal{J}}$ is $(\mathcal{C}^{\perp})_{|\mathcal{J}} \times (\mathcal{C}^{\perp})_{|\mathcal{I}-\mathcal{J}}$.

E. Conditioned code duality

The following generalization of projection/subcode duality is the key lemma for the graph duality results of [14]. It is also a fundamental result for behavioral control theory.²

²We are grateful to H. Narayanan for pointing out that our conditioned code duality theorem is closely related to his "implicit duality theorem," which he has proved and used extensively in various settings [31], [32], [33].

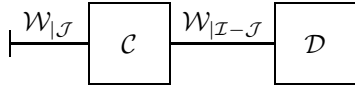
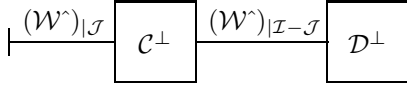
 Figure 4.1. Conditioned code $(\mathcal{C} \mid \mathcal{D})$.

 Figure 4.2. Dual conditioned code $(\mathcal{C}^\perp \mid \mathcal{D}^\perp)$.

Let \mathcal{C} be a group code in a sequence space \mathcal{W} defined on an index set \mathcal{I} , and let \mathcal{D} be a group code defined on $\mathcal{W}_{|\mathcal{I}-\mathcal{J}}$, where $\mathcal{J} \subseteq \mathcal{I}$. The *conditioned code* $(\mathcal{C} \mid \mathcal{D})$ is then defined as the set of all $\mathbf{c} \in \mathcal{C}$ such that $\mathbf{c}_{|\mathcal{I}-\mathcal{J}} \in \mathcal{D}$:

$$(\mathcal{C} \mid \mathcal{D}) = \{\mathbf{c} \in \mathcal{C} \mid \mathbf{c}_{|\mathcal{I}-\mathcal{J}} \in \mathcal{D}\} = \mathcal{C} \cap (\mathcal{W}_{|\mathcal{J}} \times \mathcal{D}).$$

Note that since \mathcal{C} , $\mathcal{W}_{|\mathcal{J}}$ and \mathcal{D} are closed, $(\mathcal{C} \mid \mathcal{D})$ is closed.

The conditioned code may be interpreted in the behavioral control context of Figure 4.1. The symbols in $\mathcal{W}_{|\mathcal{J}}$ represent to-be-controlled variables, those in $\mathcal{W}_{|\mathcal{I}-\mathcal{J}}$ represent control variables, and \mathcal{C} represents a plant whose behavior constrains both. The symbols in $\mathcal{W}_{|\mathcal{I}-\mathcal{J}}$ are further constrained by a controller \mathcal{D} . The restricted conditioned code $(\mathcal{C} \mid \mathcal{D})_{|\mathcal{J}}$ represents the controlled behavior of the variables in $\mathcal{W}_{|\mathcal{J}}$.

The generalized theorem is then as follows (see Figure 4.2):

Theorem 4.5 (Conditioned code duality): If \mathcal{C} and \mathcal{C}^\perp are dual group codes defined on \mathcal{I} , and \mathcal{D} and \mathcal{D}^\perp are dual group codes defined on a subset $\mathcal{I} - \mathcal{J} \subseteq \mathcal{I}$, then the restricted conditioned codes $(\mathcal{C} \mid \mathcal{D})_{|\mathcal{J}}$ and $(\mathcal{C}^\perp \mid \mathcal{D}^\perp)_{|\mathcal{J}}$ are dual group codes defined on \mathcal{J} , assuming both are closed.

Proof. First observe that $(\mathcal{C} \mid \mathcal{D})_{|\mathcal{J}}$ may alternatively be characterized as the restricted subcode

$$(\mathcal{C} \mid \mathcal{D})_{|\mathcal{J}} = (\mathcal{C} + (\{\mathbf{0}\}_{|\mathcal{J}} \times \mathcal{D}))_{|\mathcal{J}},$$

since $\mathbf{c} \in (\mathcal{C} \mid \mathcal{D})$ if and only if there is a $\mathbf{d}_{|\mathcal{I}-\mathcal{J}} \in \mathcal{D}$ such that $(\mathbf{c} + (\mathbf{0}_{|\mathcal{J}}, \mathbf{d}_{|\mathcal{I}-\mathcal{J}}))_{|\mathcal{I}-\mathcal{J}} = \mathbf{0}_{|\mathcal{I}-\mathcal{J}}$. Assuming that both $(\mathcal{C} \mid \mathcal{D})_{|\mathcal{J}}$ and $(\mathcal{C}^\perp \mid \mathcal{D}^\perp)_{|\mathcal{J}}$ are closed, we then have

$$\begin{aligned} ((\mathcal{C} \mid \mathcal{D})_{|\mathcal{J}})^\perp &= \left((\mathcal{C} + (\{\mathbf{0}\}_{|\mathcal{J}} \times \mathcal{D}))_{|\mathcal{J}} \right)^\perp \\ &= \left((\mathcal{C} + (\{\mathbf{0}\}_{|\mathcal{J}} \times \mathcal{D}))^\perp \right)_{|\mathcal{J}} \\ &= (\mathcal{C}^\perp \cap (\{\mathbf{0}\}_{|\mathcal{J}} \times \mathcal{D}))_{|\mathcal{J}} \\ &= (\mathcal{C}^\perp \cap ((\mathcal{W}^\wedge)_{|\mathcal{J}} \times \mathcal{D}^\perp))_{|\mathcal{J}} \\ &= (\mathcal{C}^\perp \mid \mathcal{D}^\perp)_{|\mathcal{J}}, \end{aligned}$$

where we have used projection/subcode, sum/intersection, and direct product duality. \square

Notice that $(\mathcal{C} \mid \mathcal{W}_{|\mathcal{I}-\mathcal{J}}) = \mathcal{C}$, whereas $(\mathcal{C} \mid \{\mathbf{0}\}_{|\mathcal{I}-\mathcal{J}}) = \mathcal{C}_{|\mathcal{J}}$. Therefore projection/subcode duality, namely $(\mathcal{C}_{|\mathcal{J}})^\perp = (\mathcal{C}^\perp)_{|\mathcal{J}}$, is a special case of conditioned code duality.

Moreover, as \mathcal{D} ranges from $\{\mathbf{0}\}_{|\mathcal{I}-\mathcal{J}}$ to $\mathcal{W}_{|\mathcal{I}-\mathcal{J}}$, the restricted conditioned code $(\mathcal{C} \mid \mathcal{D})_{|\mathcal{J}}$ ranges from the restricted subcode $\mathcal{C}_{|\mathcal{J}}$ to the restriction $\mathcal{C}_{|\mathcal{J}}$. This is the essence of the ‘‘most beautiful behavioral control theorem’’ [42].

F. Completeness revisited

In behavioral system theory, the completion of a system \mathcal{C} in a complete sequence space \mathcal{W}^c is defined as [47]

$$\mathcal{C}^{\text{compl}} = \{\mathbf{w} \in \mathcal{W}^c \mid \mathbf{w}_{|\mathcal{J}} \in \mathcal{C}_{|\mathcal{J}} \text{ for all finite } \mathcal{J} \subseteq \mathcal{I}\},$$

and \mathcal{C} is called *complete* if $\mathcal{C}^{\text{compl}} = \mathcal{C}$. In other words, \mathcal{C} is complete if any sequence $\mathbf{w} \in \mathcal{W}^c$ that looks like a sequence in \mathcal{C} through all finite windows is actually in \mathcal{C} .

The following result characterizes the closure \mathcal{C}^{cl} of a subgroup $\mathcal{C} \in \mathcal{W}^c$, which we also call its *completion* \mathcal{C}^c , in almost the same way:

Theorem 4.6 (Completion): If \mathcal{C} is a subgroup of a complete sequence space \mathcal{W}^c defined on an index set \mathcal{I} , then the closure (completion) of \mathcal{C} is

$$\mathcal{C}^c = \{\mathbf{w} \in \mathcal{W}^c \mid \mathbf{w}_{|\mathcal{J}} \in (\mathcal{C}_{|\mathcal{J}})^{\text{cl}} \text{ for all finite } \mathcal{J} \subseteq \mathcal{I}\}.$$

Proof. By orthogonal subgroup duality, \mathcal{C}^c is the dual of the dual code \mathcal{C}^\perp in the dual finite sequence space $(\mathcal{W}^c)^\wedge$. Since \mathcal{C}^\perp is finite, it is certainly generated by its subcodes $(\mathcal{C}^\perp)_{|\mathcal{J}}$ for all finite \mathcal{J} :

$$\mathcal{C}^\perp = \sum_{\mathcal{J} \text{ finite}} (\mathcal{C}^\perp)_{|\mathcal{J}}.$$

By sum/intersection duality, $\mathcal{C}^c = \mathcal{C}^{\perp\perp}$ is the intersection of the dual codes $((\mathcal{C}^\perp)_{|\mathcal{J}})^\perp$:

$$\mathcal{C}^c = \bigcap_{\mathcal{J} \text{ finite}} ((\mathcal{C}^\perp)_{|\mathcal{J}})^\perp.$$

The theorem follows since by Corollary 4.4(c),

$$\begin{aligned} ((\mathcal{C}^\perp)_{|\mathcal{J}})^\perp &= (\mathcal{C}_{|\mathcal{J}})^{\text{cl}} \times (\mathcal{W}^c)_{|\mathcal{I}-\mathcal{J}} \\ &= \{\mathbf{w} \in \mathcal{W}^c \mid \mathbf{w}_{|\mathcal{J}} \in (\mathcal{C}_{|\mathcal{J}})^{\text{cl}}\}. \quad \square \end{aligned}$$

It follows that if the restriction $\mathcal{C}_{|\mathcal{J}}$ is closed for all finite $\mathcal{J} \subseteq \mathcal{I}$, then completeness in the behavioral system theory sense is equivalent to closure in the product topology, which is what we call ‘‘completeness’’ in this paper. In particular, the two concepts coincide if all symbol groups G_k are discrete.

A reviewer has pointed out that Theorem 4.6 may be extended to the case in which \mathcal{C} is merely a subset of \mathcal{W}^c .

G. Completion/finitization duality

The **finite subset** (or ‘‘finitization’’) of a subgroup \mathcal{C} of a complete sequence space \mathcal{W}^c will be denoted by $\mathcal{C}_f = \mathcal{C} \cap \mathcal{W}_f$. We say that \mathcal{C} is *finite* if $\mathcal{C} = \mathcal{C}_f$. \mathcal{C} is evidently a subgroup of \mathcal{W}_f . We will assume that \mathcal{C}_f is closed when endowed with the topology of \mathcal{W}_f . For example, the finite subset of \mathcal{W}^c or of \mathcal{W}_L is \mathcal{W}_f .

The following result shows that completion and finitization are duals:

Theorem 4.7 (Completion/finitization duality): Let \mathcal{C} be a closed subgroup of a complete, finite or Laurent sequence space \mathcal{W} with symbol groups $\{G_k, k \in \mathcal{I}\}$, and let \mathcal{C}^\perp be the dual subgroup in the dual sequence space \mathcal{W}^\wedge , with symbol groups $\{\hat{G}_k\}$. Let \mathcal{C}_f be the finite subset of \mathcal{C} , and assume that \mathcal{C}_f is closed when endowed with the topology of \mathcal{W}_f . Then the dual subgroup to \mathcal{C}_f in $(\mathcal{W}^\wedge)^c = \prod_{k \in \mathcal{I}} \hat{G}_k$ is the completion of \mathcal{C}^\perp in $(\mathcal{W}^\wedge)^c$: $(\mathcal{C}_f)^\perp = (\mathcal{C}^\perp)^c$.

Proof. Following the proof of Theorem 4.6, \mathcal{C}_f is generated by the finite subcodes $\mathcal{C}_{:\mathcal{J}}$ of \mathcal{C} for all finite \mathcal{J} :

$$\mathcal{C}_f = \sum_{\mathcal{J} \text{ finite}} \mathcal{C}_{:\mathcal{J}}.$$

By sum/intersection duality, $(\mathcal{C}_f)^\perp$ is the intersection of the dual codes $(\mathcal{C}_{:\mathcal{J}})^\perp$:

$$(\mathcal{C}_f)^\perp = \bigcap_{\mathcal{J} \text{ finite}} (\mathcal{C}_{:\mathcal{J}})^\perp$$

By projection/subcode duality,

$$(\mathcal{C}_{:\mathcal{J}})^\perp = \{\mathbf{w} \in (\mathcal{W})^c \mid \mathbf{w}_{|\mathcal{J}} \in ((\mathcal{C}^\perp)_{|\mathcal{J}})^{\text{cl}}\},$$

so

$$(\mathcal{C}_f)^\perp = \{\mathbf{w} \in (\mathcal{W})^c \mid \mathbf{w}_{|\mathcal{J}} \in ((\mathcal{C}^\perp)_{|\mathcal{J}})^{\text{cl}} \text{ for all finite } \mathcal{J}\},$$

which by Theorem 4.6 is $(\mathcal{C}^\perp)^c$. \square

H. Laurent codes

Similarly, a *Laurent group code* is a closed subgroup \mathcal{C} of a Laurent sequence space \mathcal{W}_L . The dual of a Laurent group code \mathcal{C} is an (anti-)Laurent group code \mathcal{C}^\perp in the dual (anti-)Laurent sequence space $(\mathcal{W}_L)^\wedge$.

As in Theorem 4.1, if \mathcal{C} and \mathcal{C}^\perp are dual Laurent group codes, then either determines the other. Here the primal and dual codes are symmetric.

The *Laurent completion* of a subgroup \mathcal{C} of a Laurent sequence space \mathcal{W}_L is the closure of the group generated by \mathcal{C} in \mathcal{W}_L , denoted by \mathcal{C}^L . \mathcal{C} is a Laurent group code if and only if $\mathcal{C} = \mathcal{C}^L$. For example, the Laurent completion of \mathcal{W}_f is \mathcal{W}_L .

The *Laurent subset* (“Laurentization”) of a subgroup \mathcal{C} of a sequence space \mathcal{W} will be denoted by \mathcal{C}^L ; *i.e.*,

$$\mathcal{C}^L = \mathcal{C} \cap \mathcal{W}_L.$$

\mathcal{C}^L is endowed with the topology of \mathcal{W}_L . \mathcal{C} is *Laurent* if $\mathcal{C} = \mathcal{C}^L$. For example, the Laurent subset of \mathcal{W}^c is \mathcal{W}_L .

I. Wide-sense controllability and observability

Fagnani [6] has proposed an elegant definition of (wide-sense) controllability, which we restate as follows. A complete group code $\mathcal{C} \subseteq \mathcal{W}^c$ is **controllable** if $(\mathcal{C}_f)^c = \mathcal{C}$. In other words, a complete group code is controllable if it is generated by its finite sequences. Fagnani has shown that a complete compact time-invariant group code that is controllable in this sense is controllable in the sense of Willems [47].

More generally, we say that a group code \mathcal{C} in a sequence space \mathcal{W} is controllable if $(\mathcal{C}_f)^c = \mathcal{C}^c$; *i.e.*, if the completion of \mathcal{C} in \mathcal{W}^c is the completion of the finite sequences of \mathcal{C} . The complete code $(\mathcal{C}_f)^c$ will be called the *controllable subcode* of the complete code \mathcal{C}^c . Note that any finite code \mathcal{C} is necessarily controllable.

We then propose the following dual definition: a group code \mathcal{C} in a sequence space \mathcal{W} is **observable** if $(\mathcal{C}^c)_f = \mathcal{C}_f$. In other words, completing \mathcal{C} does not introduce any new finite sequences beyond those already in \mathcal{C} . The finite code $(\mathcal{C}^c)_f$

will be called the *observable supercode* of the finite code \mathcal{C}_f . Note that any complete code is necessarily observable.

The following shows that these two definitions are duals:

Theorem 4.8 (Controllability/observability duality): If \mathcal{C} and \mathcal{C}^\perp are dual group codes, then:

- (a) \mathcal{C}^c and $(\mathcal{C}^\perp)_f$ are dual group codes;
- (b) The controllable subcode $(\mathcal{C}_f)^c$ of \mathcal{C}^c and the observable supercode $((\mathcal{C}^\perp)^c)_f$ of $(\mathcal{C}^\perp)_f$ are dual group codes;
- (c) The quotient group $((\mathcal{C}^\perp)^c)_f / (\mathcal{C}^\perp)_f$ acts as the character group of $\mathcal{C}^c / (\mathcal{C}_f)^c$;
- (d) \mathcal{C} is controllable if and only if \mathcal{C}^\perp is observable.

Proof. Part (a) is Theorem 4.7. This also implies part (b), since

$$((\mathcal{C}_f)^c)^\perp = ((\mathcal{C}_f)^\perp)_f = ((\mathcal{C}^\perp)^c)_f.$$

Part (c) follows by quotient group duality. Part (d) is a corollary of part (c), since

$$\begin{aligned} \mathcal{C}^c = (\mathcal{C}_f)^c &\Leftrightarrow \mathcal{C}^c / (\mathcal{C}_f)^c = \{0\} \\ &\Leftrightarrow ((\mathcal{C}^\perp)^c)_f / (\mathcal{C}^\perp)_f = \{0\}^\wedge = \{0\} \\ &\Leftrightarrow ((\mathcal{C}^\perp)^c)_f = (\mathcal{C}^\perp)_f. \quad \square \end{aligned}$$

Note that these notions of controllability and observability do not depend on \mathcal{I} being ordered. Therefore they apply to systems with unordered time axes; *e.g.*, two-D systems [36], [44], [11], [12].

The core meaning of “controllable” is that any code sequence can be reached from any other code sequence in a finite interval. We will consider a strong notion of controllability below, and will prove that strong controllability implies controllability in the sense of this section when all symbol groups are compact. Similarly, the core meaning of “observable” is that observation of a code sequence during a finite interval gives a sufficient statistic for the future or the past. We will show below that strong observability in this sense implies observability in the sense of this section when all symbol groups are discrete.

We say that a code is *local* if it is both controllable and observable. By Theorem 4.8, the dual of a local group code is local. Local codes can be completed or finitized without loss of structure, so it does not matter much whether we consider the complete, finite or Laurent versions of such codes. Practical convolutional codes are always chosen to be local, so as to avoid the pathologies associated with uncontrollability (autonomous behavior) and unobservability (“catastrophicity”).

To illustrate, we now give a standard example of an uncontrollable (autonomous) group code \mathcal{C} that is inherently complete and cannot be “finitized” or “Laurentized” without losing its dynamical structure. Its dual \mathcal{C}^\perp is an unobservable (catastrophic) group code that is inherently finite and cannot be completed without losing its structure.

Example 2. Let G be an LCA group, let \mathcal{W}^c be the complete sequence space $G^{\mathbb{Z}}$, and let $\mathcal{C} \subseteq G^{\mathbb{Z}}$ be the *bi-infinite repetition code* over G ; *i.e.*,

$$\mathcal{C} = \{\mathbf{g} = (\dots, g, g, g, \dots) \mid g \in G\}.$$

\mathcal{C} is a complete time-invariant group code which is isomorphic to G .

The dual sequence space \mathcal{W}° to \mathcal{W}^c is the finite sequence space $((G^\wedge)^\mathbb{Z})_f$, where G^\wedge is the character group of G . The dual group code \mathcal{C}^\perp is the *bi-infinite zero-sum code* over G^\wedge , namely the finite code defined by

$$\mathcal{C}^\perp = \{\mathbf{h} \in ((G^\wedge)^\mathbb{Z})_f \mid \sum_{k \in \mathbb{Z}} h_k = 0\}.$$

This follows since for $\mathbf{g} = (\dots, g, g, g, \dots) \in \mathcal{C}$ and $\mathbf{h} \in \mathcal{W}^\circ$, the pairing $\langle \mathbf{h}, \mathbf{g} \rangle$ is

$$\langle \mathbf{h}, \mathbf{g} \rangle = \sum_{k \in \mathbb{Z}} \langle h_k, g \rangle = \langle \sum_{k \in \mathbb{Z}} h_k, g \rangle,$$

which is equal to 0 for all $g \in G$ if and only if $\sum_k h_k = 0$, the sum being well-defined because there are only finitely many nonzero components in $\mathbf{h} \in \mathcal{W}^\circ$. \mathcal{C}^\perp is a closed subgroup of the finite sequence space \mathcal{W}° , since it is the orthogonal subgroup to the complete code \mathcal{C} . Like \mathcal{C} , it is time-invariant.

The repetition code \mathcal{C} is uncontrollable, since its finite subcode consists of only the all-zero sequence, $\mathcal{C}_f = \{\mathbf{0}\}$, and this trivial subcode is complete. The zero-sum code \mathcal{C}^\perp is unobservable, since its completion is the complete sequence space $(G^\wedge)^\mathbb{Z}$.³ Thus finitization of \mathcal{C} or completion of \mathcal{C}^\perp destroys dynamical structure.

Clearly $\mathcal{C}/\mathcal{C}_f \cong G$, which by Theorem 4.8(c) implies that $\mathcal{W}^\circ/\mathcal{C}^\perp \cong G^\wedge$. The cosets of \mathcal{C}^\perp in \mathcal{W}° are in fact the subsets of \mathcal{W}° such that $\sum_k h_k = h$, for each $h \in G^\wedge$. \mathcal{C}^\perp is unobservable because no finite observation can distinguish between these cosets. \square

J. Further examples

We now give two more examples of dual group codes. The first involves a standard controllable and observable (local) time-invariant convolutional code over a finite symbol group and its dual. The second exhibits a curious complete time-invariant group code that can be finitized on the past (“Laurentized”) without loss of dynamical structure, but not on the future. Its dual has the dual property. These two codes were proposed in [27] and [28], respectively, but were not recognized there as duals.

Example 3. Let \mathcal{C} be the complete rate-1/3 linear time-invariant convolutional code over \mathbb{Z}_4 comprising all linear combinations of time shifts of the generator

$$\mathbf{g} = (\dots, 000, 100, 010, 002, 000, \dots)$$

\mathcal{C} is closed in the complete sequence space $((\mathbb{Z}_4)^3)^\mathbb{Z}$.

The finite subcode \mathcal{C}_f of \mathcal{C} is generated by all finite linear combinations of time shifts of \mathbf{g} , and is closed in the finite sequence space $((\mathbb{Z}_4)^3)^\mathbb{Z}_f$. The completion of \mathcal{C}_f is \mathcal{C} , so \mathcal{C} is controllable. Thus \mathcal{C} is local, since as a complete code it is automatically observable.

Similarly, the Laurent subcode \mathcal{C}_L is generated by all Laurent linear combinations of time shifts of \mathbf{g} , and is closed in the Laurent sequence space $((\mathbb{Z}_4)^3)^\mathbb{Z}_L$.

³*Proof:* let $\mathbf{c}^{(m,n)}$ be the sequence in \mathcal{C}^\perp with $c_m = g, c_n = -g$, and $c_k = 0$ for $k \neq m, n$; then for fixed m the “limit” of $\mathbf{c}^{(m,n)}$ as $n \rightarrow \infty$ in the product topology is the sequence with $c_m = g$ and $c_k = 0$ for $k \neq m$, a finite sequence that is not in \mathcal{C}^\perp . Since such unit sequences generate $(G^\wedge)^\mathbb{Z}$, we have $(\mathcal{C}^\perp)^c = (G^\wedge)^\mathbb{Z}$.

The dual code \mathcal{C}^\perp is the finite rate-2/3 code linear time-invariant convolutional code over \mathbb{Z}_4 consisting of all finite linear combinations of time shifts of the two generators

$$\begin{aligned} \mathbf{h}_1 &= (\dots, 000, 100, 030, 000, \dots); \\ \mathbf{h}_2 &= (\dots, 000, 020, 001, 000, \dots), \end{aligned}$$

which are orthogonal to all time shifts of \mathbf{g} under the usual inner product over \mathbb{Z}_4 . (Equivalently, the convolutions $\mathbf{h}_1 * \mathbf{g}$ and $\mathbf{h}_2 * \mathbf{g}$ of the time-reverses $\tilde{\mathbf{h}}_1$ and $\tilde{\mathbf{h}}_2$ are equal to $\mathbf{0}$.) \mathcal{C}^\perp is closed in the finite sequence space $((\mathbb{Z}_4)^3)^\mathbb{Z}_f$.

The dual complete code $(\mathcal{C}_f)^\perp$ is the set of all linear combinations of time shifts of \mathbf{h}_1 and \mathbf{h}_2 . \mathcal{C}^\perp is the finite subcode of $(\mathcal{C}_f)^\perp$, and $(\mathcal{C}_f)^\perp$ is the completion of \mathcal{C}^\perp . Thus \mathcal{C}^\perp is local.

Here there is no essential difference between the finite, Laurent, or complete versions of \mathcal{C} or \mathcal{C}^\perp . In general, the dynamical structure of a group code \mathcal{C} is not affected by completion or finitization if and only if \mathcal{C} is local. \square

Example 4. The following is a much more exotic example (a “solenoid” [26]), and is a rich source of counterexamples.

Loeliger [27], [1] proposed the following curious PSK-type code. Let \mathcal{C} be the complete compact linear time-invariant code over the additive circle group \mathbb{R}/\mathbb{Z} that consists of all integer linear combinations of time shifts of the Laurent generator

$$\mathbf{g} = (\dots, 0, \frac{1}{2}, \frac{1}{4}, \frac{1}{8}, \dots).$$

Since $2\mathbf{g} \pmod{\mathbb{Z}}$ is a shift of \mathbf{g} , the “input” at each time k is essentially a binary variable $u_k \in \{0, \frac{1}{2}\}$, which may be regarded as representing the subgroup $(\frac{1}{2}\mathbb{Z})/\mathbb{Z}$ of \mathbb{R}/\mathbb{Z} . The “output” symbol at time k is

$$c_k = \frac{u_k}{2} + \frac{u_{k-1}}{4} + \frac{u_{k-2}}{8} + \dots = \frac{u_k}{2} + \frac{c_{k-1}}{2} \in \mathbb{R}/\mathbb{Z}.$$

Thus c_k determines the entire past input sequence.

If the output symbol is mapped onto the complex unit circle via $c_k \mapsto e^{2\pi i c_k}$, then \mathcal{C} is a well-defined PSK-type code that transmits one bit per symbol and has a well-defined minimum squared distance (6.79...). However, the symbol alphabet of \mathcal{C} is the entire infinite circle group \mathbb{R}/\mathbb{Z} , rather than a finite subgroup as with ordinary PSK codes. Also, the code “state” c_{k-1} lies in the infinite state space \mathbb{R}/\mathbb{Z} . Each state c_{k-1} has two successors c_k , but each c_k has only one predecessor c_{k-1} .

The dual code \mathcal{C}^\perp to \mathcal{C} is the finite discrete linear time-invariant code over the integers \mathbb{Z} (the character group of \mathbb{R}/\mathbb{Z}) comprising all finite integer linear combinations of time shifts of the finite generator

$$\mathbf{h} = (\dots, 0, 1, -2, 0, \dots).$$

It is easily verified that \mathbf{h} is orthogonal (mod \mathbb{Z}) to all time shifts of \mathbf{g} , that a sequence in $(\mathbb{R}/\mathbb{Z})^\mathbb{Z}$ is in \mathcal{C} if and only if it is orthogonal to all shifts of \mathbf{h} , and that a sequence in $(\mathbb{Z}^\mathbb{Z})_f$ is in \mathcal{C}^\perp if and only if it is orthogonal to all shifts of \mathbf{g} .

Loeliger’s code \mathcal{C} is uncontrollable, since its finite subcode consists only of the all-zero sequence, $\mathcal{C}_f = \{\mathbf{0}\}$. Indeed, its time-reverse $\tilde{\mathcal{C}}$ is a standard example of a chaotic dynamical system whose evolution depends entirely on initial conditions [2]. Nevertheless, \mathcal{C} may be generated by a causal encoder with one input bit per unit time.

\mathcal{C} has a natural Laurent subcode \mathcal{C}_L that is generated by the input sequences that are Laurent. Thus while finitization destroys its structure, Laurentization does not. (However, Laurentization does reduce the symbol alphabet from the uncountably infinite set \mathbb{R}/\mathbb{Z} to the countably infinite set of dyadic numbers in \mathbb{R}/\mathbb{Z} .) On the other hand, the anti-Laurent subcode of \mathcal{C} is $\{\mathbf{0}\}$, since if the output is 0 at any time, then it must have been 0 at all previous times. Thus even though \mathcal{C} is time-invariant, its time axis has a distinct directionality.

The finite dual code \mathcal{C}^\perp is unobservable, since its completion is the complete sequence space $\mathbb{Z}^{\mathbb{Z}}$. Its Laurent completion is $(\mathbb{Z}^{\mathbb{Z}})_L$ (the dual of $\{\mathbf{0}\} \subseteq ((\mathbb{R}/\mathbb{Z})^{\mathbb{Z}})_L$). However, its anti-Laurent completion is simply the set of all anti-Laurent integer combinations of shifts of \mathbf{h} , which again indicates the directionality of the time axis.

Interestingly, \mathcal{C}^\perp is a version of an example given in [28], [29] to show that the set of all sequences generated by a group trellis whose state space (in this case \mathbb{Z}) does not satisfy the descending chain condition may not be a complete code.

Pontryagin suggested as a general rule that a compact group might be best studied via its discrete character group [35]. In this spirit, we suggest that it might be useful in general to study compact solenoids via their discrete duals. In this case, for instance, the dual code \mathcal{C}^\perp is finite and has short integer-valued generators. \square

V. DYNAMICAL DUALITY

This section develops basic dynamical dual properties of dual group codes \mathcal{C} and \mathcal{C}^\perp , such as:

- The state spaces of \mathcal{C}^\perp act as the character groups of the state spaces of \mathcal{C} .
- The observability properties of \mathcal{C}^\perp are the controllability properties of \mathcal{C} .

A. Topological state space theorems

The fundamental result of [15] is the state space theorem, which shows that for a group code \mathcal{C} every two-way partition of the time axis induces a certain group-theoretic minimal state space $\Sigma_{\mathcal{J}}$. Moreover, there exists a minimal state realization for \mathcal{C} in which every state space is isomorphic to the corresponding minimal state space $\Sigma_{\mathcal{J}}$. We now discuss this theorem for the topological group codes of this paper.

Given a subset $\mathcal{J} \subseteq \mathcal{I}$, the subcodes $\mathcal{C}_{:\mathcal{J}}$ and $\mathcal{C}_{:\mathcal{I}-\mathcal{J}}$ and their internal direct product $\mathcal{C}_{:\mathcal{J}} \times \mathcal{C}_{:\mathcal{I}-\mathcal{J}}$ are closed normal subgroups of \mathcal{C} . The (two-sided) **state space** of \mathcal{C} induced by the two-way partition of \mathcal{I} into $\{\mathcal{J}, \mathcal{I} - \mathcal{J}\}$ is then well defined as the quotient group

$$\Sigma_{\mathcal{J}}(\mathcal{C}) = \frac{\mathcal{C}}{\mathcal{C}_{:\mathcal{J}} \times \mathcal{C}_{:\mathcal{I}-\mathcal{J}}}.$$

The proof of the following version of the state space theorem goes through as in [15]:

Theorem 5.1 (State space theorem): Given a group code \mathcal{C} in a sequence space defined on an index set \mathcal{I} and a two-way partition of \mathcal{I} into “past” \mathcal{J} and “future” $\mathcal{I} - \mathcal{J}$, the minimal state space of any state realization of \mathcal{C} at the time corresponding to this “cut” is $\Sigma_{\mathcal{J}}(\mathcal{C})$.

In [15], *one-sided state spaces* $P_{\mathcal{J}}(\mathcal{C})/\mathcal{C}_{:\mathcal{J}}$ and $P_{\mathcal{I}-\mathcal{J}}(\mathcal{C})/\mathcal{C}_{:\mathcal{I}-\mathcal{J}}$ are also introduced, and shown to be algebraically isomorphic to the state space $\Sigma_{\mathcal{J}}(\mathcal{C})$. This follows from the correspondence theorem, since the kernels of the projections of \mathcal{C} and of $\mathcal{C}_{:\mathcal{J}} \times \mathcal{C}_{:\mathcal{I}-\mathcal{J}}$ onto \mathcal{J} are the same, namely $\mathcal{C}_{:\mathcal{I}-\mathcal{J}}$. One-sided state spaces may also be defined using restrictions since, e.g.,

$$\frac{P_{\mathcal{J}}(\mathcal{C})}{\mathcal{C}_{:\mathcal{J}}} \cong \frac{\mathcal{C}_{|\mathcal{J}}}{\mathcal{C}_{|\mathcal{J}}}.$$

As discussed in Subsection IV-C, a restriction $\mathcal{C}_{|\mathcal{J}}$ is homeomorphic to the quotient group $\mathcal{C}/\mathcal{C}_{:\mathcal{J}}$, provided that $\mathcal{C}_{|\mathcal{J}}$ is closed. With this caveat, we obtain a topological version of the one-sided state space theorem:

Theorem 5.2 (One-sided state spaces): Under the same conditions, let $\mathcal{C}_{|\mathcal{J}}$ and $\mathcal{C}_{|\mathcal{I}-\mathcal{J}}$ be the restrictions of \mathcal{C} to \mathcal{J} and $\mathcal{I} - \mathcal{J}$, respectively, and assume both are closed. Then

$$\frac{\mathcal{C}_{|\mathcal{J}}}{\mathcal{C}_{|\mathcal{J}}} \cong \frac{\mathcal{C}_{|\mathcal{I}-\mathcal{J}}}{\mathcal{C}_{|\mathcal{I}-\mathcal{J}}} \cong \Sigma_{\mathcal{J}}(\mathcal{C}).$$

Example 1 (cont.) Again, let \mathcal{C} be a lattice $\{(am+bn, -bm+an) \mid (m, n) \in \mathbb{Z}^2\}$, where a/b is irrational. \mathcal{C} is isomorphic and homeomorphic to \mathbb{Z}^2 . Letting \mathcal{J} and $\mathcal{I} - \mathcal{J}$ denote the two single-coordinate subsets, we have $\mathcal{C}_{:\mathcal{J}} = \mathcal{C}_{:\mathcal{I}-\mathcal{J}} = \{\mathbf{0}\}$. Therefore $\Sigma_{\mathcal{J}}(\mathcal{C}) \cong \mathcal{C} \cong \mathbb{Z}^2$, as expected, since either coordinate determines the lattice point and thus the other coordinate.

In this case, if $\mathcal{C}_{|\mathcal{J}}$ and $\mathcal{C}_{|\mathcal{I}-\mathcal{J}}$ are endowed with the discrete topology, then they are homeomorphic to \mathbb{Z}^2 , so Theorem 5.2 holds. However, as subspaces of \mathbb{R} , $\mathcal{C}_{|\mathcal{J}}$ and $\mathcal{C}_{|\mathcal{I}-\mathcal{J}}$ are not closed, and not homeomorphic to $\Sigma_{\mathcal{J}}(\mathcal{C})$. \square

We will continue this discussion in Section 5.3.

B. The dual state space theorem

We can now relate the state spaces of a dual code \mathcal{C}^\perp to those of \mathcal{C} , using the one-sided state space theorem. We must therefore continue to require restrictions to be closed.

Theorem 5.3 (Dual state space theorem): If \mathcal{C} and \mathcal{C}^\perp are dual group codes defined on \mathcal{I} , then for any subset $\mathcal{J} \subseteq \mathcal{I}$, the corresponding one-sided state space of \mathcal{C}^\perp acts as the character group of the corresponding one-sided state space of \mathcal{C} :

$$\left(\frac{\mathcal{C}_{|\mathcal{J}}}{\mathcal{C}_{|\mathcal{J}}} \right)^\wedge = \frac{(\mathcal{C}^\perp)_{|\mathcal{J}}}{(\mathcal{C}^\perp)_{|\mathcal{J}}}.$$

Consequently the state space of \mathcal{C}^\perp is isomorphic to the character group of the state space of \mathcal{C} :

$$(\Sigma_{\mathcal{J}}(\mathcal{C}))^\wedge \cong \Sigma_{\mathcal{J}}(\mathcal{C}^\perp).$$

Proof. By quotient group and projection/subcode duality,

$$\left(\frac{\mathcal{C}_{|\mathcal{J}}}{\mathcal{C}_{|\mathcal{J}}} \right)^\wedge = \frac{(\mathcal{C}_{|\mathcal{J}})^\perp}{(\mathcal{C}_{|\mathcal{J}})^\perp} = \frac{(\mathcal{C}^\perp)_{|\mathcal{J}}}{(\mathcal{C}^\perp)_{|\mathcal{J}}} \quad \square$$

In the usual cases, this simple but powerful theorem generalizes a known result for linear codes over fields: the state spaces of dual codes have the same dimensions. In particular:

- If $\Sigma_{\mathcal{J}}(\mathcal{C})$ is finite, then $\Sigma_{\mathcal{J}}(\mathcal{C}) \cong \Sigma_{\mathcal{J}}(\mathcal{C}^\perp)$.
- If $\Sigma_{\mathcal{J}}(\mathcal{C})$ is a finite-dimensional real vector space, then $\dim \Sigma_{\mathcal{J}}(\mathcal{C}) = \dim \Sigma_{\mathcal{J}}(\mathcal{C}^\perp)$.

The following examples show that when the restrictions $C_{|\mathcal{J}}$ and $C_{|\mathcal{I}-\mathcal{J}}$ are closed, the dual state space theorem gives a satisfactory system-theoretic result, even when \mathcal{C} is uncontrollable, unobservable, or solenoidal.

Example 2 (cont.) For the bi-infinite repetition code \mathcal{C} over G , given any proper subset $\mathcal{J} \subseteq \mathbb{Z}$, we have $\mathcal{C}_{:\mathcal{J}} = \mathcal{C}_{:\mathcal{I}-\mathcal{J}} = \{\mathbf{0}\}$, so the state space $\Sigma_{\mathcal{J}}(\mathcal{C})$ is isomorphic to $\mathcal{C} \cong G$. For the dual bi-infinite zero-sum code \mathcal{C}^\perp over G^\wedge , $(\mathcal{C}^\perp)_{:\mathcal{J}}$ is the set of all finite sequences \mathbf{h} with support in \mathcal{J} whose component sum is 0, $\sum_{k \in \mathcal{J}} h_k = 0$, whereas $(\mathcal{C}^\perp)_{|\mathcal{J}}$ is the set $((G^\wedge)^\mathcal{J})_f$ of all finite sequences with support in \mathcal{J} , so

$$\Sigma_{\mathcal{J}}(\mathcal{C}^\perp) \cong \frac{(\mathcal{C}^\perp)_{|\mathcal{J}}}{(\mathcal{C}^\perp)_{:\mathcal{J}}} \cong G^\wedge,$$

where the cosets of $(\mathcal{C}^\perp)_{|\mathcal{J}}$ in $(\mathcal{C}^\perp)_{|\mathcal{J}}$ correspond to the different possible component sums $\sum_{k \in \mathcal{J}} h_k \in G^\wedge$. Hence $\Sigma_{\mathcal{J}}(\mathcal{C}^\perp) \cong (\Sigma_{\mathcal{J}}(\mathcal{C}))^\wedge$. The dual state spaces are isomorphic if and only if $G \cong G^\wedge$.

Note that \mathcal{C}^\perp has nontrivial state spaces, even though its completion is the memoryless sequence space \mathcal{W}^\wedge . The unobservability of \mathcal{C}^\perp is reflected in the fact that the state of a sequence $\mathbf{h} \in \mathcal{C}^\perp$ cannot be observed from any finite segment $\mathbf{h}_{|\mathcal{J}}$ of \mathbf{h} . \square

Example 3 (cont.) For any partition of the time axis into past k^- and future k^+ , the state spaces of both time-invariant codes \mathcal{C} and \mathcal{C}^\perp of Example 3 are isomorphic to $\mathbb{Z}_2 \times \mathbb{Z}_4$, which as a finite abelian group is isomorphic to its character group. Generators for representatives of the cosets of $\mathcal{C}_{|:k^+}$ in $\mathcal{C}_{|k^+}$ are $|010, 002, 000, \dots\rangle$ and $|002, 000, 000, \dots\rangle$, which generate cyclic groups of orders 4 and 2, respectively. Generators for representatives of the cosets of $(\mathcal{C}^\perp)_{|:k^+}$ in $(\mathcal{C}^\perp)_{|k^+}$ are $|030, 000, 000, \dots\rangle$ and $|001, 000, 000, \dots\rangle$; the first has order 4, but the order of the second is only 2, since $|002, 000, 000, \dots\rangle$ is a code sequence in $(\mathcal{C}^\perp)_{|:k^+}$. \square

Example 4 (cont.) The state of Loeliger's code \mathcal{C} at time k is the output $c_k \in \mathbb{R}/\mathbb{Z}$, since $\mathcal{C}_{:k^-} = \{\mathbf{0}\}$ (if the future is all-zero, then $c_k = 0$, which implies that the past $\mathbf{c}_{|k^-}$ is all-zero). Since the dual code \mathcal{C}^\perp is the set of all finite integer combinations of $\mathbf{h} = (\dots, 0, 1, -2, 0, \dots)$, the state of \mathcal{C}^\perp at time k is essentially its most recent input $u_{k-1} \in \mathbb{Z}$ (representatives of the cosets of $(\mathcal{C}^\perp)_{|:k^+}$ in $(\mathcal{C}^\perp)_{|k^+}$ are generated by $|-2, 0, 0, \dots\rangle$). The dual state spaces are thus \mathbb{R}/\mathbb{Z} and \mathbb{Z} , which are indeed each other's character groups, but which are not isomorphic. \square

C. Non-closed restrictions

However, in the exceptional cases where restrictions are not closed, the dual state space theorem can fail.

Example 1 (cont.) As shown above, the irrational lattice $\mathcal{C} = \{(am + bn, -bm + an) \mid (m, n) \in \mathbb{Z}^2\}$ is isomorphic and homeomorphic to \mathbb{Z}^2 , and so is its state space $\Sigma_{\mathcal{J}}(\mathcal{C})$ corresponding to splitting the two coordinates. The two restrictions $\mathcal{C}_{|\mathcal{J}}$ and $\mathcal{C}_{|\mathcal{I}-\mathcal{J}}$ are isomorphic and homeomorphic to \mathbb{Z}^2 under the discrete topology, but not under the subspace topology.

The definition of the dual code \mathcal{C}^\perp depends on the sequence space in which \mathcal{C} is considered to lie. If \mathcal{C} is regarded as a subspace of \mathbb{R}^2 , then the dual sequence space is \mathbb{R}^2 , with pairing equal to the usual inner product mod \mathbb{Z} . Let us write $\mathcal{C} = A\mathbb{Z}^2$, where $A = \begin{bmatrix} a & b \\ -b & a \end{bmatrix}$. The dual code is then the irrational lattice $\mathcal{C}^\perp = A^{-1}\mathbb{Z}^2$ in \mathbb{R}^2 , whose state space is again isomorphic to \mathbb{Z}^2 . Thus, under the usual subspace topologies, the dual state space theorem fails.

However, suppose we regard \mathcal{C} as a subspace of the trimmed sequence space $\mathcal{C}_{|\mathcal{J}} \times \mathcal{C}_{|\mathcal{I}-\mathcal{J}}$ under the discrete topology; then this sequence space is isomorphic and homeomorphic to $\mathbb{Z}^2 \times \mathbb{Z}^2$, and the dual sequence space is isomorphic to $(\mathbb{R}/\mathbb{Z})^2 \times (\mathbb{R}/\mathbb{Z})^2$. As \mathcal{C} is isomorphic to a repetition code over \mathbb{Z}^2 , the dual code \mathcal{C}^\perp in this dual sequence space is isomorphic to a zero-sum code over $(\mathbb{R}/\mathbb{Z})^2$, whose state space is isomorphic to $(\mathbb{R}/\mathbb{Z})^2$ (see Example 2, above). Thus, under these topologies, the dual state space theorem holds. \square

We conjecture that the dual state space theorem, and all later duality results, hold when the symbol groups G_k are taken as the restrictions $\mathcal{C}_{|\{k\}}$, with the appropriate topologies.

However, as we see from this example, although use of nonstandard topologies may lead to results which are formally correct, they may not be consistent with the usual conventions, which are often based on subspace topologies. For instance, the usual definition of a dual lattice is with respect to \mathbb{R}^n ; then the dual lattice of any full-rank lattice, even an irrational lattice, is itself a lattice (a discrete subgroup of \mathbb{R}^n), not some weird continuous compact group like $(\mathbb{R}/\mathbb{Z})^2$.

One drawback of a Laurent sequence space is that in general it is neither discrete nor compact, so we may expect Laurent codes to provide further counterexamples, such as the following one.

Example 5. Let $\mathcal{C} \subseteq (\mathbb{Z}_2)^\mathbb{Z}$ be the binary *mirror-image code* consisting of all binary sequences $\mathbf{x} \in (\mathbb{Z}_2)^\mathbb{Z}$ that exhibit mirror symmetry; i.e., $x_k = x_{-k}$ for all $k \in \mathbb{Z}$. \mathcal{C} is complete (a closed subgroup of the complete sequence space $\mathcal{W}^c = (\mathbb{Z}_2)^\mathbb{Z}$) and controllable (\mathcal{C} is generated by its finite sequences, $\mathcal{C} = (\mathcal{C}_f)^c$). Its dual code \mathcal{C}^\perp in $\mathcal{W}_f = ((\mathbb{Z}_2)^\mathbb{Z})_f$ is the set of all finite binary sequences in \mathcal{C} with $x_0 = 0$; i.e.,

$$\mathcal{C}^\perp = (\mathcal{C}_f)_{:\mathbb{Z}-\{0\}}.$$

\mathcal{C}^\perp may also be regarded as a Laurent code \mathcal{C}_L in the Laurent sequence space $\mathcal{W}_L = ((\mathbb{Z}_2)^\mathbb{Z})_L$, where it remains closed. Its dual $(\mathcal{C}_L)^\perp$ in this setting is an anti-Laurent code in \mathcal{W}_L , which as a set is equal to the finite subcode \mathcal{C}_f .

Whereas \mathcal{W}_f is discrete and \mathcal{W}^c is compact, the sequence spaces \mathcal{W}_L and \mathcal{W}_L are neither discrete nor compact. Thus whereas the restrictions of $\mathcal{C} \subseteq \mathcal{W}^c$ and $\mathcal{C}^\perp \subseteq \mathcal{W}_f$ to the past interval $\mathcal{P} = (-\infty, 0)$ are necessarily closed, the restrictions $(\mathcal{C}_L)_{|\mathcal{P}}$ and $((\mathcal{C}_L)^\perp)_{|\mathcal{P}}$ are not necessarily closed. In fact, $(\mathcal{C}_L)_{|\mathcal{P}}$ is closed in \mathcal{W}_L , but $((\mathcal{C}_L)^\perp)_{|\mathcal{P}}$ is not closed in \mathcal{W}_L , even though they are identical as sets (both are equal to $((\mathbb{Z}_2)^\mathcal{P})_f$).

This shows again that the validity of our topological results depends very much on the topologies of the sequence spaces in which codes are regarded as being defined, and in particular on whether restrictions are necessarily closed. \square

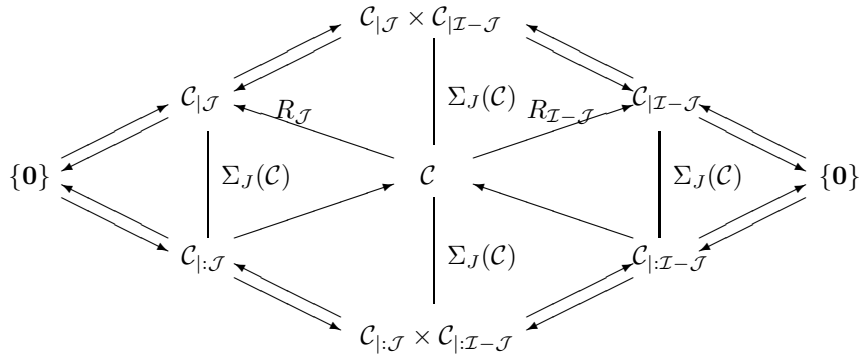

Figure 5.1. Tableau illustrating state space and reciprocal state space theorems.

In order not to have to continually deal with such pathological cases, we therefore impose from now on the following **closed-projections assumption**:

The topology induced by every restriction or projection onto a subset $\mathcal{J} \subseteq \mathcal{I}$ is consistent with the topology of $\mathcal{W}_{|\mathcal{J}}$. In particular, projections of closed subgroups are closed in the subspace topology.

A reviewer has pointed out that the closed-projections assumption is satisfied for a complete sequence space \mathcal{W} if all symbol groups G_k are compact metric spaces, and in particular if all G_k are finite. Then \mathcal{W} is a compact metrizable space, so every closed and thus compact subset of \mathcal{W} has a compact and thus closed image under the continuous restriction map $R_{\mathcal{J}} : \mathcal{W} \rightarrow \mathcal{W}_{|\mathcal{J}}$.

Under the closed-projections assumption, we can apply our duality results freely without continual consideration of topological issues. The reader must therefore use our results with caution whenever topological subtleties are suspected.

D. The reciprocal state space theorem

What is the character group of the two-sided state space $\Sigma_{\mathcal{J}}(\mathcal{C})$? The following theorem shows that it is the (two-sided) **reciprocal state space** of \mathcal{C}^{\perp} , defined as

$$\Sigma^{\mathcal{J}}(\mathcal{C}^{\perp}) = \frac{(\mathcal{C}^{\perp})_{|\mathcal{J}} \times (\mathcal{C}^{\perp})_{|\mathcal{I}-\mathcal{J}}}{\mathcal{C}^{\perp}}.$$

(The reciprocal state space was introduced in a different context in [7].)

Theorem 5.4 (Reciprocal state space theorem): If \mathcal{C} and \mathcal{C}^{\perp} are dual group codes, then the reciprocal state space $\Sigma^{\mathcal{J}}(\mathcal{C}^{\perp})$ acts as the character group of the two-sided state space $\Sigma_{\mathcal{J}}(\mathcal{C})$.

Proof. Using quotient group, direct product, and projection/subcode duality, we have

$$\begin{aligned} \left(\frac{\mathcal{C}}{\mathcal{C}_{|:\mathcal{J}} \times \mathcal{C}_{|:\mathcal{I}-\mathcal{J}}} \right)^{\wedge} &= \frac{(\mathcal{C}_{|:\mathcal{J}} \times \mathcal{C}_{|:\mathcal{I}-\mathcal{J}})^{\perp}}{\mathcal{C}^{\perp}} \\ &= \frac{(\mathcal{C}_{|:\mathcal{J}})^{\perp} \times (\mathcal{C}_{|:\mathcal{I}-\mathcal{J}})^{\perp}}{\mathcal{C}^{\perp}} \\ &= \frac{(\mathcal{C}^{\perp})_{|\mathcal{J}} \times (\mathcal{C}^{\perp})_{|\mathcal{I}-\mathcal{J}}}{\mathcal{C}^{\perp}}. \quad \square \end{aligned}$$

The reciprocal state space theorem has an immediate corollary, which yields a fourth state space for the group codes that we are considering:

Corollary 5.5: The reciprocal state space $\Sigma^{\mathcal{J}}(\mathcal{C})$ is isomorphic to the state space $\Sigma_{\mathcal{J}}(\mathcal{C})$.

Proof. By the reciprocal state space and dual state space theorems,

$$\Sigma^{\mathcal{J}}(\mathcal{C}) = (\Sigma_{\mathcal{J}}(\mathcal{C}^{\perp}))^{\wedge} \cong \Sigma_{\mathcal{J}}(\mathcal{C}). \quad \square$$

We caution the reader that this result depends on the closed-projections assumption. Moreover, as we will discuss further below, it applies only when \mathcal{C} is abelian. Nonetheless, it rounds out the state space theorem nicely when it applies.

When the reciprocal state space theorem holds, there is a chain

$$\mathcal{C}_{|:\mathcal{J}} \times \mathcal{C}_{|:\mathcal{I}-\mathcal{J}} \subseteq \mathcal{C} \subseteq \mathcal{C}_{|\mathcal{J}} \times \mathcal{C}_{|\mathcal{I}-\mathcal{J}},$$

in which both quotients are isomorphic to $\Sigma_{\mathcal{J}}(\mathcal{C})$. The dual chain is

$$(\mathcal{C}^{\perp})_{|:\mathcal{J}} \times (\mathcal{C}^{\perp})_{|:\mathcal{I}-\mathcal{J}} \subseteq \mathcal{C}^{\perp} \subseteq (\mathcal{C}^{\perp})_{|\mathcal{J}} \times (\mathcal{C}^{\perp})_{|\mathcal{I}-\mathcal{J}},$$

which has quotients isomorphic to $\Sigma_{\mathcal{J}}(\mathcal{C}^{\perp}) \cong \Sigma^{\mathcal{J}}(\mathcal{C})^{\wedge}$, as illustrated by the dual diagrams below.

$$\begin{array}{ccc} \mathcal{C}_{|\mathcal{J}} \times \mathcal{C}_{|\mathcal{I}-\mathcal{J}} & \Sigma^{\mathcal{J}}(\mathcal{C}) & (\mathcal{C}^{\perp})_{|\mathcal{J}} \times (\mathcal{C}^{\perp})_{|\mathcal{I}-\mathcal{J}} \\ \downarrow & & \downarrow \\ \mathcal{C} & & \mathcal{C}^{\perp} \\ \downarrow & \Sigma_{\mathcal{J}}(\mathcal{C}) & \downarrow \\ \mathcal{C}_{|:\mathcal{J}} \times \mathcal{C}_{|:\mathcal{I}-\mathcal{J}} & & (\mathcal{C}^{\perp})_{|:\mathcal{J}} \times (\mathcal{C}^{\perp})_{|:\mathcal{I}-\mathcal{J}} \end{array} \Sigma^{\mathcal{J}}(\mathcal{C}^{\perp})$$

Figure 5.1 exhibits a related tableau of homomorphisms, in which all quotient groups are isomorphic to the state space $\Sigma_{\mathcal{J}}(\mathcal{C})$. Note that every left-to-right or right-to-left chain of four maps in this tableau is a short exact sequence (a sequence in which the image of each map is the kernel of the next). Moreover, this tableau is self-dual, in the sense that the dual diagram is the corresponding tableau for \mathcal{C}^{\perp} .

E. The abelian dynamics theorem

In this subsection we give a purely algebraic proof that the reciprocal state space $\Sigma^{\mathcal{J}}(\mathcal{C})$ is isomorphic to the state space $\Sigma_{\mathcal{J}}(\mathcal{C})$ when $\Sigma_{\mathcal{J}}(\mathcal{C})$ is abelian. When $\Sigma_{\mathcal{J}}(\mathcal{C})$ is not abelian, $\Sigma^{\mathcal{J}}(\mathcal{C})$ is not well defined, but on the other hand the situation is not essentially different. Finally, we show that these results are a special case of the abelian dynamics theorem.

The one-sided state space theorem shows that we can compute the state $\sigma_{\mathcal{J}}(\mathbf{c}) \in \Sigma_{\mathcal{J}}(\mathcal{C})$ of a code sequence $\mathbf{c} \in \mathcal{C}$ from either its “past” $\mathbf{c}_{|\mathcal{J}}$ or its “future” $\mathbf{c}_{|\mathcal{I}-\mathcal{J}}$; *i.e.*, there exist homomorphic *state maps* $\sigma_{|\mathcal{J}} : \mathcal{C}_{|\mathcal{J}} \rightarrow \Sigma_{\mathcal{J}}(\mathcal{C})$ and $\sigma_{|\mathcal{I}-\mathcal{J}} : \mathcal{C}_{|\mathcal{I}-\mathcal{J}} \rightarrow \Sigma_{\mathcal{J}}(\mathcal{C})$, whose images are the state space $\Sigma_{\mathcal{J}}(\mathcal{C})$ and whose kernels are the restricted subcodes $\mathcal{C}_{|\mathcal{J}}$ and $\mathcal{C}_{|\mathcal{I}-\mathcal{J}}$, respectively. For $\mathbf{c} \in \mathcal{C}$, the images of these maps must agree: $\sigma_{\mathcal{J}}(\mathbf{c}_{|\mathcal{J}}) = \sigma_{\mathcal{I}-\mathcal{J}}(\mathbf{c}_{|\mathcal{I}-\mathcal{J}})$.

A general pair $(\mathbf{w}_{|\mathcal{J}}, \mathbf{w}_{|\mathcal{I}-\mathcal{J}}) \in \mathcal{C}_{|\mathcal{J}} \times \mathcal{C}_{|\mathcal{I}-\mathcal{J}}$ is in \mathcal{C} if and only if $\sigma_{\mathcal{J}}(\mathbf{w}_{|\mathcal{J}}) = \sigma_{\mathcal{I}-\mathcal{J}}(\mathbf{w}_{|\mathcal{I}-\mathcal{J}})$ [15]. Therefore we can test whether $(\mathbf{w}_{|\mathcal{J}}, \mathbf{w}_{|\mathcal{I}-\mathcal{J}})$ is in \mathcal{C} by forming the state difference (“syndrome”)

$$d(\mathbf{w}_{|\mathcal{J}}, \mathbf{w}_{|\mathcal{I}-\mathcal{J}}) = \sigma_{\mathcal{J}}(\mathbf{w}_{|\mathcal{J}}) - \sigma_{\mathcal{I}-\mathcal{J}}(\mathbf{w}_{|\mathcal{I}-\mathcal{J}}).$$

Then $(\mathbf{w}_{|\mathcal{J}}, \mathbf{w}_{|\mathcal{I}-\mathcal{J}}) \in \mathcal{C}$ if and only if $d(\mathbf{w}_{|\mathcal{J}}, \mathbf{w}_{|\mathcal{I}-\mathcal{J}}) = 0$. In other words, \mathcal{C} is the kernel of the state difference map $d : \mathcal{C}_{|\mathcal{J}} \times \mathcal{C}_{|\mathcal{I}-\mathcal{J}} \rightarrow \Sigma_{\mathcal{J}}(\mathcal{C})$.

When $\Sigma_{\mathcal{J}}(\mathcal{C})$ is abelian, the state difference map is a homomorphism. Since \mathcal{C} is its kernel, it follows that \mathcal{C} is a closed normal subgroup of $\mathcal{C}_{|\mathcal{J}} \times \mathcal{C}_{|\mathcal{I}-\mathcal{J}}$, and therefore that the quotient group $(\mathcal{C}_{|\mathcal{J}} \times \mathcal{C}_{|\mathcal{I}-\mathcal{J}})/\mathcal{C}$ (*i.e.*, the reciprocal state space) is well defined.

When $\Sigma_{\mathcal{J}}(\mathcal{C})$ is not abelian, \mathcal{C} is still the kernel of the state difference map. The following theorem shows that in this case \mathcal{C} cannot be a normal subgroup of $\mathcal{C}_{|\mathcal{J}} \times \mathcal{C}_{|\mathcal{I}-\mathcal{J}}$, and therefore the state difference map cannot be a homomorphism.

Theorem 5.6 (algebraic reciprocal state space theorem):

If \mathcal{C} is an algebraic group code in the sense of [15], then the state space $\Sigma_{\mathcal{J}}(\mathcal{C})$ is abelian if and only if \mathcal{C} is a normal subgroup of $\mathcal{C}_{|\mathcal{J}} \times \mathcal{C}_{|\mathcal{I}-\mathcal{J}}$.

Proof. On the one hand, if $\Sigma_{\mathcal{J}}(\mathcal{C})$ is abelian, then the state difference map $d : \mathcal{C}_{|\mathcal{J}} \times \mathcal{C}_{|\mathcal{I}-\mathcal{J}} \rightarrow \Sigma_{\mathcal{J}}(\mathcal{C})$ is a homomorphism with kernel \mathcal{C} , so \mathcal{C} is a normal subgroup of $\mathcal{C}_{|\mathcal{J}} \times \mathcal{C}_{|\mathcal{I}-\mathcal{J}}$.

On the other hand, if \mathcal{C} is a normal subgroup of $\mathcal{C}_{|\mathcal{J}} \times \mathcal{C}_{|\mathcal{I}-\mathcal{J}}$, then the reciprocal state space $\Sigma^{\mathcal{J}}(\mathcal{C}) = (\mathcal{C}_{|\mathcal{J}} \times \mathcal{C}_{|\mathcal{I}-\mathcal{J}})/\mathcal{C}$ is abelian, which implies that $\Sigma_{\mathcal{J}}(\mathcal{C}) \cong \Sigma^{\mathcal{J}}(\mathcal{C})$ is abelian. Let $\mathbf{w} \in P_{\mathcal{J}}(\mathcal{C})$; then $\mathbf{w} \in \mathcal{C}_{|\mathcal{J}} \times \{\mathbf{0}\}_{|\mathcal{I}-\mathcal{J}} \subseteq \mathcal{C}_{|\mathcal{J}} \times \mathcal{C}_{|\mathcal{I}-\mathcal{J}}$, so by normality $\mathbf{w}\mathbf{c}\mathbf{w}^{-1} \in \mathcal{C}$ and thus $\mathbf{w}\mathbf{c}\mathbf{w}^{-1}\mathbf{c}^{-1} \in \mathcal{C}$ for any $\mathbf{c} \in \mathcal{C}$. Now \mathbf{w} has support \mathcal{J} , so $P_{|\mathcal{I}-\mathcal{J}}(\mathbf{w}\mathbf{c}\mathbf{w}^{-1}\mathbf{c}^{-1}) = \mathbf{0}$, which implies $\mathbf{w}\mathbf{c}\mathbf{w}^{-1}\mathbf{c}^{-1} \in \mathcal{C}_{:\mathcal{J}}$ and $\mathbf{w}\mathbf{c}\mathbf{w}^{-1}\mathbf{c}^{-1} = \mathbf{w}P_{\mathcal{J}}(\mathbf{c})\mathbf{w}^{-1}(P_{\mathcal{J}}(\mathbf{c}))^{-1}$. As \mathbf{w} and $P_{\mathcal{J}}(\mathbf{c})$ run through $P_{\mathcal{J}}(\mathcal{C})$, the commutators $\mathbf{w}P_{\mathcal{J}}(\mathbf{c})\mathbf{w}^{-1}(P_{\mathcal{J}}(\mathbf{c}))^{-1} \in \mathcal{C}_{:\mathcal{J}}$ therefore run through the generators of the commutator subgroup $[P_{\mathcal{J}}(\mathcal{C}), P_{\mathcal{J}}(\mathcal{C})]$. Therefore $[P_{\mathcal{J}}(\mathcal{C}), P_{\mathcal{J}}(\mathcal{C})] \subseteq \mathcal{C}_{:\mathcal{J}}$. By a general property of commutator subgroups [38, Ex. 2.52], $(\mathcal{C}_{|\mathcal{J}} \times \mathcal{C}_{|\mathcal{I}-\mathcal{J}})/\mathcal{C}$ is thus abelian. \square

Theorem 5.6 shows that there is a distinct algebraic difference between the abelian and nonabelian cases. However, the two cases are otherwise not fundamentally different. Even when \mathcal{C} is not a normal subgroup of $\mathcal{C}_{|\mathcal{J}} \times \mathcal{C}_{|\mathcal{I}-\mathcal{J}}$, we can still partition $\mathcal{C}_{|\mathcal{J}} \times \mathcal{C}_{|\mathcal{I}-\mathcal{J}}$ into “cosets” corresponding to the distinct possible state differences in $\Sigma_{\mathcal{J}}(\mathcal{C})$ under the state difference map, thus establishing a one-to-one map between the “cosets” of \mathcal{C} in $\mathcal{C}_{|\mathcal{J}} \times \mathcal{C}_{|\mathcal{I}-\mathcal{J}}$ and the state space $\Sigma_{\mathcal{J}}(\mathcal{C})$. Thus the basic idea of a correspondence between syndrome equivalence classes of $\mathcal{C}_{|\mathcal{J}} \times \mathcal{C}_{|\mathcal{I}-\mathcal{J}}$ and $\Sigma_{\mathcal{J}}(\mathcal{C})$ still holds.

There is a nice generalization of the above theorem, as follows. Given an algebraic group code \mathcal{C} in the sense of

[15], the *label groups* of \mathcal{C} are defined as the quotient groups $\{\mathcal{C}_{|\{k\}}/\mathcal{C}_{|\{k\}} \cong \Sigma_{\{k\}}(\mathcal{C}), k \in \mathcal{I}\}$. The group code \mathcal{C} then has the same dynamical structure as its label code $\mathbf{q}(\mathcal{C})$, obtained by the natural map $q_k : \mathcal{C}_{|\{k\}} \rightarrow \mathcal{C}_{|\{k\}}/\mathcal{C}_{|\{k\}}$ of each *output group* $\mathcal{C}_{|\{k\}}$ of \mathcal{C} onto its label group. \mathcal{C} is said to have *abelian dynamics* if all label groups are abelian, for then and only then all state spaces $\Sigma_{\mathcal{J}}(\mathcal{C})$ are abelian [15].

We define the *output sequence space* of \mathcal{C} as the direct product (or whatever product/sum is appropriate) of the output groups, $\mathcal{W}(\mathcal{C}) = \prod_{k \in \mathcal{I}} \mathcal{C}_{|\{k\}}$, and the *nondynamical sequence space* as the product $\mathcal{V}(\mathcal{C}) = \prod_{k \in \mathcal{I}} \mathcal{C}_{|\{k\}}$.

Theorem 5.7 (abelian dynamics theorem): If \mathcal{C} is an algebraic group code in the sense of [15], then \mathcal{C} has abelian dynamics if and only if \mathcal{C} is normal in its output sequence space $\mathcal{W}(\mathcal{C})$.

Proof. If \mathcal{C} has abelian dynamics, then $\mathcal{W}(\mathcal{C})/\mathcal{V}(\mathcal{C}) = \prod_{k \in \mathcal{I}} \mathcal{C}_{|\{k\}}/\mathcal{C}_{|\{k\}}$ is abelian. Thus $\mathcal{C}/\mathcal{V}(\mathcal{C})$ is an abelian and normal subgroup. By the correspondence theorem, \mathcal{C} is normal in $\mathcal{W}(\mathcal{C})$.

Conversely, if \mathcal{C} is a normal subgroup of $\mathcal{W}(\mathcal{C}) = \mathcal{C}_{|\{k\}} \times \prod_{k' \in \mathcal{I}-\{k\}} \mathcal{C}_{|\{k'\}}$, then *a fortiori* \mathcal{C} is normal in $\mathcal{C}_{|\{k\}} \times \mathcal{C}_{|\mathcal{I}-\{k\}}$, since $\mathcal{C}_{|\mathcal{I}-\{k\}} \subseteq \prod_{k' \in \mathcal{I}-\{k\}} \mathcal{C}_{|\{k'\}}$. Therefore, by the previous theorem, the label group $\mathcal{C}_{|\{k\}}/\mathcal{C}_{|\{k\}}$ (which is the state space $\Sigma_{\{k\}}(\mathcal{C})$) is abelian, for any $k \in \mathcal{I}$. Since all label groups are abelian, \mathcal{C} has abelian dynamics. \square

A *syndrome-former* for \mathcal{C} is a dynamical map defined on the output sequence space $\mathcal{W}(\mathcal{C})$ (or a larger sequence space) whose kernel is \mathcal{C} . It follows from this theorem that a syndrome-former can be homomorphic if and only if \mathcal{C} has abelian dynamics. However, as we see from the example of a state difference map, a syndrome-former can be non-homomorphic while still being straightforward and essentially group-theoretic. Thus our assumption of abelian dynamics in this paper is not fundamental, as the syndrome-former constructions of Fagnani and Zampieri [10] show.

VI. NOTIONS OF FINITE MEMORY

In this section we discuss several notions of finite memory, and study their duality properties in a group-theoretic context. Most of these notions have been introduced previously in behavioral system theory [47] in a set-theoretic context.

We first introduce *L*-controllability and *L*-observability, which turn out to be duals. We give two characterizations of each, which are also duals. We then introduce *L*-finiteness and *L*-completeness, also duals, and show that they are equivalent to *L*-controllability and *L*-observability, respectively, in appropriate settings.

To discuss memory, we must assume that the time index set \mathcal{I} is ordered; *i.e.*, without loss of generality, $\mathcal{I} \subseteq \mathbb{Z}$. We will use the notation of [15] for subintervals of \mathcal{I} ; *e.g.*,

$$\begin{aligned} [m, n) &= \{k \in \mathcal{I} \mid m \leq k < n\}; \\ m^- &= \{k \in \mathcal{I} \mid k < m\}; \\ n^+ &= \{k \in \mathcal{I} \mid k \geq n\}. \end{aligned}$$

Thus \mathcal{I} is the disjoint union of the three subintervals $\{m^-, [m, n), n^+\}$.

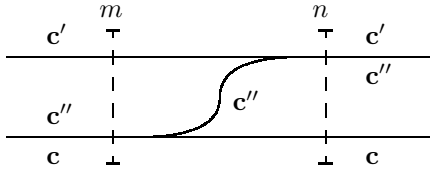

Figure 6.1. Illustration of $[m, n]$ -controllability with code sequences \mathbf{c}, \mathbf{c}' and \mathbf{c}'' .

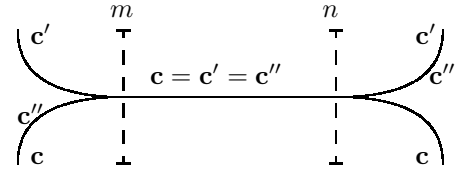

Figure 6.2. Illustration of $[m, n]$ -observability with code sequences \mathbf{c}, \mathbf{c}' and \mathbf{c}'' .

A. Strong controllability and observability

We now study the duality between notions of strong controllability and observability. Our definition of strong controllability is the same as that of Willems [47]. Our definition of strong observability (introduced in [28]) corresponds to Willems' definition of "finite memory."⁴ We show that these two notions are duals. We also show that strong controllability or observability implies controllability or observability, respectively, as defined earlier.

Given a finite interval $[m, n]$, a code \mathcal{C} is **$[m, n]$ -controllable** if for any $\mathbf{c}, \mathbf{c}' \in \mathcal{C}$ there exists a $\mathbf{c}'' \in \mathcal{C}$ such that $\mathbf{c}''_{|m^-} = \mathbf{c}_{|m^-}$ and $\mathbf{c}''_{|n^+} = \mathbf{c}'_{|n^+}$. A code is **L -controllable** if it is $[m, m+L]$ -controllable for every length- L interval $[m, m+L]$, and **strongly controllable** if it is L -controllable for some L . The least such L is the **controller memory** of \mathcal{C} .

The following controllability test follows directly from the definition.

Theorem 6.1 (first $[m, n]$ -controllability test): A code \mathcal{C} is $[m, n]$ -controllable if and only if $\mathcal{C}_{|I-[m,n]} = \mathcal{C}_{|m^-} \times \mathcal{C}_{|n^+}$.

Proof. This merely restates the definition; it says that \mathcal{C} is $[m, n]$ -controllable if and only if any past in $\mathcal{C}_{|m^-}$ can be linked to any future in $\mathcal{C}_{|n^+}$. \square

If \mathcal{C} is a group code, then we have an alternative controllability test:

Theorem 6.2 (second $[m, n]$ -controllability test): A group code \mathcal{C} is $[m, n]$ -controllable if and only if $\mathcal{C} = \mathcal{C}_{:n^-} + \mathcal{C}_{:m^+}$.

Proof. If \mathcal{C} is generated by $\mathcal{C}_{:n^-}$ and $\mathcal{C}_{:m^+}$, then any past $\mathbf{c}_{|m^-}$ can be linked to any future $\mathbf{c}_{|n^+}$ as follows: find any $\mathbf{c}^- \in \mathcal{C}_{:n^-}$ and $\mathbf{c}^+ \in \mathcal{C}_{:m^+}$ such that $(\mathbf{c}^-)_{|m^-} = \mathbf{c}_{|m^-}$ and $(\mathbf{c}^+)_{|n^+} = \mathbf{c}_{|n^+}$; then $\mathbf{c}^- + \mathbf{c}^+$ is the desired linking sequence. Conversely, if \mathcal{C} is $[m, n]$ -controllable, then any $\mathbf{c}^- \in \mathcal{C}_{:m^-}$ can be linked to $\mathbf{0} \in \mathcal{C}_{:n^+}$, and any $\mathbf{c}^+ \in \mathcal{C}_{:n^+}$ can be linked to $\mathbf{0} \in \mathcal{C}_{:m^-}$, which implies that $\mathcal{C} = \mathcal{C}_{:n^-} + \mathcal{C}_{:m^+}$. \square

The definition of $[m, n]$ -controllability, illustrated in Figure 6.1, involves a notion of finite reachability: from any state (set of past trajectories) at time m we can reach any state (set of future trajectories) at time n . The first $[m, n]$ -controllability test translates this into a notion of memorylessness: the state at time n is not constrained by the trajectory before time m . The second $[m, n]$ -controllability test relies on the group property, by which it suffices to show that every state at time m can reach the zero state at time n and every state at time n can be reached from the zero state at time m ; it then translates this observation into the statement that every code sequence can be decomposed into a code sequence in $\mathcal{C}_{:n^-}$ and a code sequence in $\mathcal{C}_{:m^+}$, which is a generatability criterion.

⁴In [49, p. 336], Willems calls this notion "insightful" for discrete-time behaviors.

We define a code \mathcal{C} to be **$[m, n]$ -observable** if whenever $\mathbf{c}_{|[m,n]} = \mathbf{c}'_{|[m,n]}$ for $\mathbf{c}, \mathbf{c}' \in \mathcal{C}$, then the concatenation of $\mathbf{c}_{|m^-}, \mathbf{c}_{|[m,n]} = \mathbf{c}'_{|[m,n]}$, and $\mathbf{c}'_{|n^+}$ is in \mathcal{C} . A code is **L -observable** if it is $[m, m+L]$ -observable for every length- L interval $[m, m+L]$, and **strongly observable** if it is L -observable for some L . The least such L is the **observer memory** of \mathcal{C} .

The following observability test follows directly from this definition:

Theorem 6.3 (first $[m, n]$ -observability test): A code \mathcal{C} in a sequence space \mathcal{W} is $[m, n]$ -observable if and only if

$$\mathcal{C} = \{\mathbf{w} \in \mathcal{W} \mid \mathbf{w}_{|n^-} \in \mathcal{C}_{|n^-}, \mathbf{w}_{|m^+} \in \mathcal{C}_{|m^+}\}.$$

Proof. If $\mathcal{C} = \{\mathbf{w} \in \mathcal{W} \mid \mathbf{w}_{|n^-} \in \mathcal{C}_{|n^-}, \mathbf{w}_{|m^+} \in \mathcal{C}_{|m^+}\}$ and $\mathbf{c}, \mathbf{c}' \in \mathcal{C}$ have a common central segment $\mathbf{c}_{|[m,n]}$, then $\mathbf{w} = (\mathbf{c}_{|m^-}, \mathbf{c}_{|[m,n]}, \mathbf{c}'_{|n^+})$ satisfies the constraints $\mathbf{w}_{|n^-} \in \mathcal{C}_{|n^-}, \mathbf{w}_{|m^+} \in \mathcal{C}_{|m^+}$ and is therefore in \mathcal{C} , so \mathcal{C} is $[m, n]$ -observable. Conversely, if \mathcal{C} is $[m, n]$ -observable, then the fact that if $\mathbf{c}, \mathbf{c}' \in \mathcal{C}$ have a common central segment $\mathbf{c}_{|[m,n]}$ then $\mathbf{w} = (\mathbf{c}_{|m^-}, \mathbf{c}_{|[m,n]}, \mathbf{c}'_{|n^+})$ is a code sequence implies that any sequence $\mathbf{w} \in \mathcal{W}$ whose restrictions $\mathbf{w}_{|n^-}$ and $\mathbf{w}_{|m^+}$ equal restricted code sequences $\mathbf{c}_{|n^-} \in \mathcal{C}_{|n^-}$ and $\mathbf{c}_{|m^+} \in \mathcal{C}_{|m^+}$, respectively, is a valid code sequence. \square

If \mathcal{C} is a group code, then we have an alternative observability test:

Theorem 6.4 (second $[m, n]$ -observability test): A group code \mathcal{C} is $[m, n]$ -observable if and only if $\mathcal{C}_{:I-[m,n]} = \mathcal{C}_{:m^-} \times \mathcal{C}_{:n^+}$.

Proof. In general, $\mathcal{C}_{:m^-} \times \mathcal{C}_{:n^+} \subseteq \mathcal{C}_{:I-[m,n]}$. If $\mathbf{c} \in \mathcal{C}_{:I-[m,n]}$, then $\mathbf{c}_{|[m,n]} = \mathbf{0}_{|[m,n]}$. Since $\mathbf{0} \in \mathcal{C}$, if \mathcal{C} is $[m, n]$ -observable, then the concatenations $(\mathbf{c}_{|m^-}, \mathbf{0}_{|m^+}) = P_{m^-}(\mathbf{c})$ and $(\mathbf{0}_{|n^-}, \mathbf{c}_{|n^+}) = P_{n^+}(\mathbf{c})$ are in \mathcal{C} , and thus in $\mathcal{C}_{:m^-}$ and $\mathcal{C}_{:n^+}$, respectively. So $\mathcal{C}_{:I-[m,n]} \subseteq \mathcal{C}_{:m^-} \times \mathcal{C}_{:n^+}$, which implies that $\mathcal{C}_{:I-[m,n]} = \mathcal{C}_{:m^-} \times \mathcal{C}_{:n^+}$.

Conversely, if $\mathbf{c}, \mathbf{c}' \in \mathcal{C}$ are such that $\mathbf{c}_{|[m,n]} = \mathbf{c}'_{|[m,n]}$, then $\mathbf{c} - \mathbf{c}' \in \mathcal{C}_{:I-[m,n]}$. If $\mathcal{C}_{:I-[m,n]} = \mathcal{C}_{:m^-} \times \mathcal{C}_{:n^+}$, then $\mathbf{c} - \mathbf{c}'$ may be written as $\mathbf{c} - \mathbf{c}' = \mathbf{c}^- + \mathbf{c}^+$, where $\mathbf{c}^- \in \mathcal{C}_{:m^-}$ and $\mathbf{c}^+ \in \mathcal{C}_{:n^+}$. It follows that

$$P_{m^-}(\mathbf{c}) + P_{n^+}(\mathbf{c}') = \mathbf{c}' + P_{m^-}(\mathbf{c} - \mathbf{c}') = \mathbf{c}' + \mathbf{c}^-,$$

which by the group property of \mathcal{C} is in \mathcal{C} . So \mathcal{C} is $[m, n]$ -observable. \square

Our definition of $[m, n]$ -observability, illustrated in Figure 6.2, is implicitly a notion of state observability: given a segment of a code sequence $\mathbf{c}_{|[m,n]}$, the states at time m and n (and indeed during the entire interval $[m, n]$) are determined. The first $[m, n]$ -observability test translates this into a checkability criterion: if a sequence looks like a code sequence during the overlapping intervals n^- and m^+ , then

it is a code sequence. The second $[m, n]$ -observability test relies on the group property, by which it suffices to show that $\mathbf{c}_{|[m, n]} = \mathbf{0}_{|[m, n]}$ implies that $\mathbf{c} \in \mathcal{C}$ passes through the zero state at times m and n (and therefore during the entire interval $[m, n]$); it then translates this observation into the statement that every code sequence with $\mathbf{c}_{|[m, n]} = \mathbf{0}_{|[m, n]}$ can be decomposed into a code sequence in $\mathcal{C}_{:m^-}$ and a sequence in $\mathcal{C}_{:n^+}$, which is another notion of memorylessness.

Our desired duality theorem then follows directly from projection/subcode duality, applied to either of two dual pairs of tests. The first proof shows that the first $[m, n]$ -controllability test and the second $[m, n]$ -observability test are duals, whereas the second proof shows that the second $[m, n]$ -controllability test and the first $[m, n]$ -observability test are duals.

Theorem 6.5 (strong controllability/observability duality): Given dual group codes $\mathcal{C}, \mathcal{C}^\perp$ and a finite interval $[m, n] \subseteq \mathcal{I}$, \mathcal{C} is $[m, n]$ -controllable if and only if \mathcal{C}^\perp is $[m, n]$ -observable.

First proof. By the first $[m, n]$ -controllability test, \mathcal{C} is $[m, n]$ -controllable if and only if $\mathcal{C}_{|\mathcal{I}-[m, n]} = \mathcal{C}_{|m^-} \times \mathcal{C}_{|n^+}$. By projection/subcode duality, the duals of the left and right sides of this equation are $(\mathcal{C}^\perp)_{|\mathcal{I}-[m, n]}$ and $(\mathcal{C}^\perp)_{|m^-} \times (\mathcal{C}^\perp)_{|n^+}$, respectively. Therefore $\mathcal{C}_{|\mathcal{I}-[m, n]} = \mathcal{C}_{|m^-} \times \mathcal{C}_{|n^+}$ if and only if $(\mathcal{C}^\perp)_{|\mathcal{I}-[m, n]} = (\mathcal{C}^\perp)_{|m^-} \times (\mathcal{C}^\perp)_{|n^+}$, which is effectively the second $[m, n]$ -observability test for \mathcal{C}^\perp . \square

Second proof. By the second $[m, n]$ -controllability test, \mathcal{C} is $[m, n]$ -controllable if and only if $\mathcal{C} = \mathcal{C}_{:n^-} + \mathcal{C}_{:m^+}$. By projection/subcode and sum/intersection duality, the duals of these two codes are \mathcal{C}^\perp and $(\mathcal{C}_{:n^-})^\perp \cap (\mathcal{C}_{:m^+})^\perp$, respectively. Furthermore, by projection/subcode duality,

$$(\mathcal{C}_{:n^-})^\perp = \{\mathbf{x} \in \mathcal{W} \mid \mathbf{x}_{|n^-} \in (\mathcal{C}^\perp)_{|n^-}\};$$

$$(\mathcal{C}_{:m^+})^\perp = \{\mathbf{x} \in \mathcal{W} \mid \mathbf{x}_{|m^+} \in (\mathcal{C}^\perp)_{|m^+}\};$$

so $(\mathcal{C}_{:n^-})^\perp \cap (\mathcal{C}_{:m^+})^\perp$ is equal to

$$\{\mathbf{x} \in \mathcal{W} \mid \mathbf{x}_{|n^-} \in (\mathcal{C}^\perp)_{|n^-}, \mathbf{x}_{|m^+} \in (\mathcal{C}^\perp)_{|m^+}\}.$$

But this is \mathcal{C}^\perp if and only if \mathcal{C}^\perp is $[m, n]$ -observable, by the first $[m, n]$ -observability test for \mathcal{C}^\perp . \square

As immediate corollaries, we have:

Corollary 6.6: Given dual group codes \mathcal{C} and \mathcal{C}^\perp ,

- (a) \mathcal{C} is L -controllable $\Leftrightarrow \mathcal{C}^\perp$ is L -observable;
- (b) \mathcal{C} is strongly controllable $\Leftrightarrow \mathcal{C}^\perp$ is strongly observable;
- (c) controller memory of \mathcal{C} = observer memory of \mathcal{C}^\perp .

This fundamental duality result provides strong support for our use of the term ‘‘observability’’ rather than ‘‘finite memory’’ in [28] and here. Also, it is desirable to distinguish between controller and observer memory.

All notions of zero memory coincide: a code is 0-controllable or 0-observable or memoryless if for any time m and any $\mathbf{c}, \mathbf{c}' \in \mathcal{C}$, the concatenation $(\mathbf{c}_{|m^-}, \mathbf{c}'_{|m^+})$ is in \mathcal{C} .

However, if \mathcal{C} is not memoryless, then there is no necessary relationship between its controller memory and its observer memory; these are two distinct (and dual) notions of the memory of \mathcal{C} . The controller memory measures the maximum time needed to link any past to any future. The observer memory measures the maximum observation time needed to obtain a ‘‘sufficient statistic’’ for predicting the future (resp. the past) from the past (resp. the future).

Finally, we now verify that strong controllability (resp. observability) implies wide-sense controllability (resp. observability) as defined earlier. For observability, we will consider only the case in which all symbol groups are discrete, in which case the topology of the complete sequence space \mathcal{W}^c is the topology of pointwise convergence. Under our standing assumptions, the corresponding controllability result then holds when all symbol groups are compact.

Theorem 6.7: Let \mathcal{C} and \mathcal{C}^\perp be dual group codes in sequence spaces \mathcal{W} and \mathcal{W}^\wedge , respectively. Let all symbol groups G_k of \mathcal{W}^c be discrete, and all symbol groups G_k^\wedge of $(\mathcal{W}^c)^\wedge$ be compact. Then \mathcal{C} is observable if \mathcal{C} is strongly observable, and \mathcal{C}^\perp is controllable if \mathcal{C}^\perp is strongly controllable.

Proof. Suppose \mathcal{C} is strongly observable but not observable; i.e., $(\mathcal{C}^c)_f \neq \mathcal{C}_f$. Then there exists some finite sequence $\mathbf{w} \in (\mathcal{C}^c)_f$ that is not in \mathcal{C}_f . Since the topology of \mathcal{C}^c is the topology of pointwise convergence, this means that there is some series $\{\mathbf{c}^n\}$ of code sequences $\mathbf{c}^n \in \mathcal{C}$ that converges pointwise to \mathbf{w} as $n \rightarrow \infty$. Now \mathcal{C} is L -observable for some integer L , and the support of \mathbf{w} is some finite interval $[k, k']$. Pointwise convergence then implies that $\mathbf{c}^n_{|[k-L, k'+L]} = \mathbf{w}_{|[k-L, k'+L]}$ for all sufficiently large n . But L -observability then implies that \mathbf{w} is a finite code sequence in \mathcal{C} , since $\mathbf{c}^n_{|[k-L, k'+L]}$ is a code sequence that agrees with the all-zero sequence $\mathbf{0}$ during the length- L intervals $[k-L, k]$ and $[k', k+L]$; contradiction. Thus \mathcal{C} must be observable.

Finally, \mathcal{C}^\perp is controllable if and only if \mathcal{C} is observable by Theorem 4.8, and \mathcal{C}^\perp is strongly controllable if and only if \mathcal{C} is strongly observable by the corollary above. \square

On the other hand, the following example shows that a controllable code need not be strongly controllable, and an observable code need not be strongly observable.

Example 6. Let $\mathcal{I} = \{1, 2, \dots\}$, and let \mathcal{C} be the group code over a group G in which the symbols c_k are chosen freely from G at times $k = 2^n$ for all $n \in \{0, 1, \dots\}$, but at all other times $c_k = c_{k-1}$. Then \mathcal{C} is generated by finite sequences of the form $(\dots, 0, g, g, \dots, g, 0, \dots)$ with support $[2^n, 2^{n+1})$ and is thus controllable, but \mathcal{C} is not L -controllable for any $L \in \mathbb{Z}$. The dual subcode \mathcal{C}^\perp is thus observable but not strongly observable. \square

B. L -finiteness and L -completeness

In this subsection we introduce L -finiteness and L -completeness, which turn out to be duals. Our definition of L -completeness is the same as that of Willems [47], except for the modification that we made earlier when defining completeness; it is a notion of finite checkability in complete sequence spaces. We define L -finiteness in a dual way as a notion of finite generatability that applies to group codes in finite sequence spaces. We show that in these restricted contexts L -finiteness is equivalent to L -controllability, and L -completeness is equivalent to L -observability.

We define a group code \mathcal{C} in a finite sequence space \mathcal{W}_f to be **L -finite** if it is generated by its finite code sequences of length $L + 1$:

$$\mathcal{C} = \sum_{k \in \mathbb{Z}} \mathcal{C}_{:[k, k+L]}.$$

In other words, \mathcal{C} is L -finite if and only if any $\mathbf{c} \in \mathcal{C}$ may be decomposed into a sum of code sequences $\mathbf{c}_{[k,k+L]} \in \mathcal{C}_{:[k,k+L]}$ whose supports are intervals of length $L + 1$:

$$\mathbf{c} = \sum_{k \in \mathbb{Z}} \mathbf{c}_{[k,k+L]}.$$

Notice that this definition makes sense only in the setting of group codes; no analogue exists for set-theoretic codes.

The following theorem shows that for such group codes, L -finiteness is equivalent to L -controllability:

Theorem 6.8 (L -finite = L -controllable + finite): If \mathcal{C} is a group code in a finite sequence space \mathcal{W}_f , then \mathcal{C} is L -finite if and only if \mathcal{C} is L -controllable.

Proof. If \mathcal{C} is L -finite, then we may write any $\mathbf{c} \in \mathcal{C}$ as $\mathbf{c} = \sum_{j \in \mathbb{Z}} \mathbf{c}_{[j,j+L]}$, so for any k , \mathbf{c} may be written as a sum $\mathbf{c} = \mathbf{c}_{(k+L)-} + \mathbf{c}_{k+}$ with $\mathbf{c}_{(k+L)-} \in \mathcal{C}_{:(k+L)-}$ and $\mathbf{c}_{k+} \in \mathcal{C}_{:k+}$, as follows:

$$\mathbf{c} = \sum_{j < k} \mathbf{c}_{[j,j+L]} + \sum_{j \geq k} \mathbf{c}_{[j,j+L]} = \mathbf{c}_{(k+L)-} + \mathbf{c}_{k+}.$$

Thus $\mathcal{C} = \mathcal{C}_{:(k+L)-} + \mathcal{C}_{:k+}$, so by the second $[m, n]$ -controllability test \mathcal{C} is $[k, k + L]$ -controllable for all k , and thus L -controllable.

Conversely, let \mathcal{C} be L -controllable. Since all code sequences are finite, the support of any $\mathbf{c} \in \mathcal{C}$ is a finite interval, say $[k, k' + L]$. By L -controllability, for any $j \in \mathbb{Z}$ there exists a $\mathbf{c}_{j+} \in \mathcal{C}_{:j+}$ such that $(\mathbf{c}_{j+})_{|j-} = \mathbf{0}_{|j-}$ and $(\mathbf{c}_{j+})_{|(j+L)+} = \mathbf{c}_{|(j+L)+}$. Then $\mathbf{c}_{[j,j+L]} = \mathbf{c}_{j+} - (\mathbf{c}_{(j+1)+})_{|(j+L)+}$ has support $[j, j + L]$. Thus for any $\mathbf{c} \in \mathcal{C}$ we have $\mathbf{c} = \sum_{j \in [k, k']} \mathbf{c}_{[j,j+L]}$; so \mathcal{C} is L -finite. \square

Dually, a group code \mathcal{C} in a complete sequence space \mathcal{W}^c will be defined as **L -complete** if

$$\mathcal{C} = \{\mathbf{w} \in \mathcal{W}^c \mid \mathbf{w}_{|[k,k+L]} \in (\mathcal{C}_{|[k,k+L]})^{\text{cl}} \text{ for all } k \in \mathbb{Z}\}.$$

As in our definition of completeness, this definition uses closed restrictions $(\mathcal{C}_{|[k,k+L]})^{\text{cl}}$. If the closed-projections assumption holds, then this reduces to Willems' definition [47]. In other words, \mathcal{C} is L -complete if whenever $\mathbf{w} \in \mathcal{W}^c$ looks like a code sequence through all windows of length $L + 1$, then \mathbf{w} is in fact a code sequence.

The duality of L -completeness and L -finiteness then follows directly from projection/subcode duality:

Theorem 6.9 (L -finiteness/ L -completeness duality): If \mathcal{C} and \mathcal{C}^\perp are dual group codes in dual finite and complete sequence spaces \mathcal{W}_f and $(\mathcal{W}_f)^\wedge$, then \mathcal{C} is L -finite if and only if \mathcal{C}^\perp is L -complete.

Proof. By sum/intersection duality, $\mathcal{C} = \sum_{k \in \mathbb{Z}} \mathcal{C}_{:[k,k+L]}$ if and only if $\mathcal{C}^\perp = \bigcap_{k \in \mathbb{Z}} (\mathcal{C}_{:[k,k+L]})^\perp$. By projection/subcode duality, $(\mathcal{C}_{:[k,k+L]})^\perp$ is the closure of

$$\{\mathbf{x} \in (\mathcal{W}_f)^\wedge \mid \mathbf{x}_{|[k,k+L]} \in (\mathcal{C}^\perp)_{|[k,k+L]}\}.$$

Then

$$\mathcal{C}^\perp = \{\mathbf{x} \in (\mathcal{W}_f)^\wedge \mid (\mathbf{x}_{|[k,k+L]})^{\text{cl}} \in (\mathcal{C}^\perp)_{|[k,k+L]} \text{ for all } k\},$$

which is the definition of L -completeness for \mathcal{C}^\perp . \square

Corollary 6.10 (L -complete = L -observable + complete): If \mathcal{C} is a (complete) group code in a complete sequence space \mathcal{W}^c , then \mathcal{C} is L -complete if and only if \mathcal{C} is L -observable.

Proof. We have now shown that the following are equivalent:

$$\begin{aligned} \mathcal{C} \text{ is } L\text{-complete} &\Leftrightarrow \mathcal{C}^\perp \text{ is } L\text{-finite} \Leftrightarrow \\ \mathcal{C}^\perp \text{ is } L\text{-controllable} &\Leftrightarrow \mathcal{C} \text{ is } L\text{-observable}. \quad \square \end{aligned}$$

This is a group-theoretic version of Willems' set-theoretic theorem [47] that a complete code is L -complete if and only if it has L -finite memory (is L -observable).

While L -finiteness and L -controllability are equivalent (resp. L -completeness and L -observability), the tests that they imply are different in practice, as we show by revisiting the controllability and observability tests of Subsection VI-A, and then applying these tests to our examples.

The tests of Subsection VI-A involve a three-way partition of the time axis \mathcal{I} , namely $\mathcal{I} = \{m^-, [m, n], n^+\}$. We may correspondingly identify \mathcal{I} with an equivalent finite time axis $\mathcal{I}' = \{1, 2, 3\}$ of length 3, and we may regard any code \mathcal{C} defined on \mathcal{I} as a code \mathcal{C}' defined on \mathcal{I}' . Note that the equivalent length-3 sequence space $\mathcal{W}' = \mathcal{W}_{|m^-} \times \mathcal{W}_{|[m,n]} \times \mathcal{W}_{|n^+}$ is both complete and finite, assuming that each of the restrictions $\mathcal{W}_{|m^-}$, $\mathcal{W}_{|[m,n]}$ and $\mathcal{W}_{|n^+}$ is complete (closed).

Now in terms of the equivalent code \mathcal{C}' on \mathcal{I}' , we have:

- \mathcal{C} is $[m, n]$ -controllable $\Leftrightarrow \mathcal{C}'$ is 1-controllable;
- \mathcal{C}' is 1-controllable $\Leftrightarrow \mathcal{C}'_{|\{1,3\}} = \mathcal{C}'_{|\{1\}} \times \mathcal{C}'_{|\{3\}}$;
- \mathcal{C}' is 1-finite $\Leftrightarrow \mathcal{C}' = \mathcal{C}'_{:\{1,2\}} + \mathcal{C}'_{:\{2,3\}}$.

The latter two tests correspond to our first and second $[m, n]$ -controllability tests, respectively, and their equivalence follows from Theorem 6.8. Similarly,

- \mathcal{C} is $[m, n]$ -observable $\Leftrightarrow \mathcal{C}'$ is 1-observable;
- \mathcal{C}' is 1-observable $\Leftrightarrow \mathcal{C}'_{:\{1,3\}} = \mathcal{C}'_{:\{1\}} \times \mathcal{C}'_{:\{3\}}$;
- \mathcal{C}' is 1-complete \Leftrightarrow
 $\mathcal{C}' = \{\mathbf{w} \in \mathcal{W}' \mid \mathbf{w}_{|\{1,2\}} \in \mathcal{C}'_{|\{1,2\}}, \mathbf{w}_{|\{2,3\}} \in \mathcal{C}'_{|\{2,3\}}\}.$

These two tests correspond to our second and first $[m, n]$ -observability tests, respectively, and their equivalence follows from Corollary 6.10, or by duality from our $[m, n]$ -controllability tests.

Now let us see how these various tests apply to some of our example codes.

Example 2 (cont.) A bi-infinite repetition code \mathcal{C} over G is 1-observable, because two code sequences that agree anywhere agree everywhere. It is 1-complete, because a sequence \mathbf{w} is in \mathcal{C} if and only if the two components of every length-2 restriction $\mathbf{w}_{|[k,k+1]}$ are equal. The zero-sum code \mathcal{C}^\perp over G^\wedge is 1-controllable, because for any two finite sequences \mathbf{x}, \mathbf{x}' and any $k \in \mathbb{Z}$, there is an $h \in G^\wedge$ such that $(\mathbf{x}_{|k^-}, h, (\mathbf{x}')_{|(k+1)+})$ is in \mathcal{C}^\perp . It is 1-finite, because it is generated by its length-2 sequences $(\dots, 0, g, -g, 0, \dots)$. \square

Example 3 (cont.) The finite subcode \mathcal{C}_f of the rate-1/3 linear time-invariant convolutional code \mathcal{C} over \mathbb{Z}_4 comprising all linear combinations of time shifts of $\mathbf{g} = (\dots, 000, 100, 010, 002, 000, \dots)$ is by definition 2-finite and evidently 2-controllable, since it has a feedbackfree encoder with memory 2. The finite subset $(\mathcal{C}^\perp)_f$ of its dual rate-2/3 code \mathcal{C}^\perp comprising all linear combinations of time shifts of the generators $\mathbf{h}_1 = (\dots, 000, 100, 030, 000, \dots)$, $\mathbf{h}_2 = (\dots, 000, 020, 001, 000, \dots)$ is by definition 1-finite and evidently 1-controllable.

\mathcal{C} is 1-complete, because it is the set of all sequences orthogonal to all shifts of the length-2 sequences \mathbf{h}_1 and \mathbf{h}_2 . \mathcal{C} is 1-observable, because a zero symbol 000 can be observed only if \mathcal{C} is in the zero state. Similarly, \mathcal{C}^\perp is 2-complete, because it is the set of all sequences orthogonal to all shifts of the length-3 sequence \mathbf{g} , and it is 2-observable since two successive zero symbols (000,000) can be observed only if \mathcal{C}^\perp is in the zero state, as the reader may verify. \square

Example 4 (cont.) Loeliger's code \mathcal{C} is 1-observable, since two code sequences with the same output c_k have a uniquely determined past and the same set of possible futures. It is 1-complete, because a sequence \mathbf{w} is in \mathcal{C} if and only if the first component of every length-2 restriction $\mathbf{w}|_{[k,k+1]}$ is twice the second component (mod \mathbb{Z}). Its dual \mathcal{C}^\perp is generated by the time shifts of the length-2 generator $\mathbf{h} = (\dots, 0, 1, -2, 0, \dots)$, and thus is by definition 1-finite; it is 1-controllable since it evidently has a feedbackfree encoder with memory 1. \square

VII. DUAL GRANULE DECOMPOSITIONS

The development of [15] is based on a decomposition of an L -controllable group code \mathcal{C} according to a chain of j -controllable subcodes \mathcal{C}_j ,

$$\mathcal{C}_0 \subseteq \mathcal{C}_1 \subseteq \dots \subseteq \mathcal{C}_L = \mathcal{C},$$

and then a further decomposition of the quotients $\mathcal{C}_j/\mathcal{C}_{j-1}$ into direct products of j th-level granules, defined (in additive notation) as

$$\Gamma_{[k,k+j]}(\mathcal{C}) = \frac{\mathcal{C}_{:[k,k+j]}}{\mathcal{C}_{:[k,k+j]} + \mathcal{C}_{:(k,k+j)}}.$$

We now give a dual decomposition of an L -observable group code \mathcal{C} according to the j -observable supercode chain,

$$\mathcal{C} = \mathcal{C}^L \subseteq \mathcal{C}^{L-1} \subseteq \dots \subseteq \mathcal{C}^0,$$

and then a further decomposition of the quotients $\mathcal{C}^{j-1}/\mathcal{C}^j$ into products of j th-level observer granules $\Phi_{[k,k+j]}(\mathcal{C})$. Here the "granules" $\Gamma_{[k,k+j]}(\mathcal{C})$ of [15] will be called "controller granules."

We will show that the j -observable supercode \mathcal{C}^j of \mathcal{C} is the dual of the j -controllable subcode $(\mathcal{C}^\perp)_j$ of its dual \mathcal{C}^\perp , and that the observer granules of \mathcal{C} act as the character groups of the corresponding controller granules of \mathcal{C}^\perp .

In the following section, we will give examples of how this observability structure can be used to construct minimal observer-form encoders, state observers and syndrome-formers. A general construction of syndrome-formers for non-topological group codes over finite, possibly nonabelian groups that uses this observability structure is given in [10].

A. Controller decomposition

We review the results of [15] in our topological group setting, to prepare for dualizing them.

From here on, for simplicity, when we denote a sequence subspace in a sequence space \mathcal{W} by a Cartesian product, e.g., $\prod_{k \in \mathcal{I}} A_k$, we imply that the product is of the same type as that of \mathcal{W} — e.g., a direct product, Laurent product, or direct sum.

As in [15], we define the **j -controllable subcode** \mathcal{C}_j of a group code \mathcal{C} in a sequence space \mathcal{W} as the code generated by the length- $(j+1)$ subcodes $\mathcal{C}_{:[k,k+j]}$ of \mathcal{C} :

$$\mathcal{C}_j = \sum_{k \in \mathbb{Z}} \mathcal{C}_{:[k,k+j]}.$$

If \mathcal{W} is finite, then \mathcal{C}_j by definition is j -finite. By a proof like that of Theorem 6.8, \mathcal{C}_j is j -controllable, and \mathcal{C} is L -controllable if and only if $\mathcal{C} = \mathcal{C}_L$.

If \mathcal{C} is L -controllable, then we have a chain of j -controllable subcodes

$$\{\mathbf{0}\} \subseteq \mathcal{C}_0 \subseteq \mathcal{C}_1 \subseteq \dots \subseteq \mathcal{C}_L = \mathcal{C}.$$

For consistency in indexing, we may denote the trivial subcode $\{\mathbf{0}\}$ by \mathcal{C}_{-1} .

The 0-controllable subcode \mathcal{C}_0 (called the *parallel transition subcode* of \mathcal{C}) is a memoryless sequence space of the same type as \mathcal{W} , whose symbol groups are the length-1 subcodes $\mathcal{C}_{:\{k\}}$. Since it is memoryless, it has trivial dynamics (i.e., trivial state spaces).

The controller granules $\Gamma_{[k,k+j]}(\mathcal{C})$ are defined by

$$\Gamma_{[k,k+j]}(\mathcal{C}) = \frac{(\mathcal{C}_j)_{:[k,k+j]}}{(\mathcal{C}_{j-1})_{:[k,k+j]}}, \quad k \in \mathbb{Z}, 0 \leq j \leq L.$$

Since $(\mathcal{C}_j)_{:[k,k+j]} = \mathcal{C}_{:[k,k+j]}$ and $(\mathcal{C}_{j-1})_{:[k,k+j]} = \mathcal{C}_{:[k,k+j]} + \mathcal{C}_{:(k,k+j)}$, this is equivalent to the definition of [15]:

$$\begin{aligned} \Gamma_{[k,k+j]}(\mathcal{C}) &= \frac{\mathcal{C}_{:[k,k+j]}}{\mathcal{C}_{:[k,k+j]} + \mathcal{C}_{:(k,k+j)}}, \quad 1 \leq j \leq L; \\ \Gamma_{[k,k]}(\mathcal{C}) &= \mathcal{C}_{:[k,k]} = \mathcal{C}_{:\{k\}}. \end{aligned}$$

The cosets of $(\mathcal{C}_{j-1})_{:[k,k+j]}$ in $(\mathcal{C}_j)_{:[k,k+j]}$ are represented by sequences in $\mathcal{C}_{:[k,k+j]}$ that are not in the $(j-1)$ -controllable subcode \mathcal{C}_{j-1} . The zeroth-level controller granules $\Gamma_{[k,k]}(\mathcal{C})$ are called "nondynamical granules" and are equal to the *parallel transition subgroups* $\mathcal{C}_{:\{k\}}$.

As in the code granule theorem of [15], we can then show that

$$\frac{\mathcal{C}_j}{\mathcal{C}_{j-1}} \cong \prod_{k \in \mathbb{Z}} \Gamma_{[k,k+j]}(\mathcal{C}), \quad 0 \leq j \leq L,$$

where the product is a direct product, Laurent product, or direct sum according to the character of the sequence space \mathcal{W} in which \mathcal{C} lies. The proof essentially follows from the facts that $\mathcal{C}_j/\mathcal{C}_{j-1}$ is generated by the sequences in $\mathcal{C}_{:[k,k+j]}$ that are not in \mathcal{C}_{j-1} for all $k \in \mathbb{Z}$, and that $(\mathcal{C}_j)_{:[k,k+j+1]}$ is the direct product of $(\mathcal{C}_j)_{:[k,k+j]}$ and $(\mathcal{C}_j)_{:[k+1,k+j+1]}$ modulo \mathcal{C}_{j-1} , since the intersection of $(\mathcal{C}_j)_{:[k,k+j]}$ and $(\mathcal{C}_j)_{:[k+1,k+j+1]}$ is $(\mathcal{C}_j)_{:(k,k+j)} \subseteq \mathcal{C}_{j-1}$.

The restrictions of the future subcodes $(\mathcal{C}_j)_{:k+}$ to time k are defined as the **j th-level first-output groups**

$$F_{j,k}(\mathcal{C}) = ((\mathcal{C}_j)_{:k+})|_{\{k\}}, \quad 0 \leq j \leq L,$$

which form a chain

$$\{\mathbf{0}\} \subseteq F_{0,k}(\mathcal{C}) \subseteq F_{1,k}(\mathcal{C}) \subseteq \dots \subseteq F_{L,k}(\mathcal{C}) = F_k(\mathcal{C}),$$

where $F_k(\mathcal{C}) = (\mathcal{C}_{:k+})|_{\{k\}}$ is the **first-output group** of \mathcal{C} at time k (also called the *input group* [15]). Since $F_{j,k}(\mathcal{C}) = (\mathcal{C}_{:[k,k+j]})|_{\{k\}}$ and the kernels of the restrictions to $\{k\}$ of

$(\mathcal{C}_j)_{:[k,k+j]}$ and $(\mathcal{C}_{j-1})_{:[k,k+j]}$ are both equal to $\mathcal{C}_{:[k,k+j]}$, it follows from the correspondence theorem that the quotients of this chain are isomorphic to the corresponding controller granules:

$$\frac{F_{j,k}(\mathcal{C})}{F_{j-1,k}(\mathcal{C})} \cong \Gamma_{[k,k+j]}(\mathcal{C}).$$

Similarly, we define the **j th-level last-output groups** as

$$L_{j,k}(\mathcal{C}) = ((\mathcal{C}_j)_{:(k+1)^-})_{|\{k\}}, \quad 0 \leq j \leq L,$$

which form a chain up to $L_k(\mathcal{C}) = (\mathcal{C}_{:(k+1)^-})_{|\{k\}}$, the **last-output group** of \mathcal{C} :

$$\{0\} \subseteq L_{0,k}(\mathcal{C}) \subseteq L_{1,k}(\mathcal{C}) \subseteq \cdots \subseteq L_{L,k}(\mathcal{C}) = L_k(\mathcal{C}),$$

with quotients also isomorphic to controller granules:

$$\frac{L_{j,k}(\mathcal{C})}{L_{j-1,k}(\mathcal{C})} \cong \Gamma_{[k-j,k]}(\mathcal{C}).$$

The **state code** of \mathcal{C} is the group code $\sigma(\mathcal{C})$, where the state map σ is the Cartesian product of the state maps σ_k ; *i.e.*,

$$\sigma(\mathbf{c}) = \{\sigma_k(\mathbf{c}), k \in \mathbb{Z}\},$$

where $\sigma_k(\mathbf{c}) \in \Sigma_k(\mathcal{C})$ is the state of the code sequence $\mathbf{c} \in \mathcal{C}$ at time k . The kernel of the state code map is the parallel transition subcode \mathcal{C}_0 .

As in [15], the state spaces and state code of \mathcal{C} may be decomposed according to the chains

$$\begin{aligned} \{0\} &= \sigma_k(\mathcal{C}_0) \subseteq \sigma_k(\mathcal{C}_1) \subseteq \cdots \subseteq \sigma_k(\mathcal{C}_L) = \Sigma_k(\mathcal{C}); \\ \{0\} &= \sigma(\mathcal{C}_0) \subseteq \sigma(\mathcal{C}_1) \subseteq \cdots \subseteq \sigma(\mathcal{C}_L) = \sigma(\mathcal{C}), \end{aligned}$$

where $\sigma_k(\mathcal{C}_j)$ is the state space of the j -controllable subcode \mathcal{C}_j at time k and $\sigma(\mathcal{C}_j)$ is the state code of \mathcal{C}_j . The zeroth-level state code $\sigma(\mathcal{C}_0)$ is trivial since \mathcal{C}_0 is memoryless.

The quotients of the latter chain are isomorphic to $\mathcal{C}_j/\mathcal{C}_{j-1}$:

$$\frac{\sigma(\mathcal{C}_j)}{\sigma(\mathcal{C}_{j-1})} \cong \frac{\mathcal{C}_j}{\mathcal{C}_{j-1}} \cong \prod_{k \in \mathbb{Z}} \Gamma_{[k,k+j]}(\mathcal{C}), \quad 1 \leq j \leq L.$$

The quotients of the former chain are isomorphic to direct products of the j th-level controller granules that are “active” at time k :

$$\frac{\sigma_k(\mathcal{C}_j)}{\sigma_k(\mathcal{C}_{j-1})} \cong \prod_{i \in [k-j,k]} \Gamma_{[i,i+j]}(\mathcal{C}), \quad 1 \leq j \leq L.$$

Each single controller granule $\Gamma_{[k,k+j]}(\mathcal{C})$ may be implemented by a little state machine with an input group and a state space isomorphic to $\Gamma_{[k,k+j]}(\mathcal{C})$ which is active during the interval $(k, k+j]$, as follows. An input in $F_{j,k}(\mathcal{C})/F_{j-1,k}(\mathcal{C}) \cong \Gamma_{[k,k+j]}(\mathcal{C})$ arrives at time k and determines a corresponding first output, which is the time- k output symbol of a representative of the corresponding coset of $(\mathcal{C}_{j-1})_{:[k,k+j]}$ in $(\mathcal{C}_j)_{:[k,k+j]}$, as well as a corresponding state in a state space isomorphic to $\Gamma_{[k,k+j]}(\mathcal{C})$ at time $k+1$. During the interval $(k, k+j]$, the state is constant, and determines the remaining output symbols of the representative sequence. At time $k+j$, the last output is emitted (a representative of $L_{j,k+j}(\mathcal{C})/L_{j-1,k+j}(\mathcal{C}) \cong \Gamma_{[k,k+j]}(\mathcal{C})$), and the granule becomes “inactive;” *i.e.*, no further memory is required.

A j th-level encoder for $\mathcal{C}_j/\mathcal{C}_{j-1}$ in controller form may then be implemented by combining the outputs of encoders for $\Gamma_{[k,k+j]}(\mathcal{C})$ for all $k \in \mathbb{Z}$ (with finite or Laurent constraints, if appropriate; *e.g.*, that there be only finitely many nonzero inputs for $k < 0$). The resulting encoder implements an isomorphism from the “input sequence space” $\prod_k F_{j,k}(\mathcal{C})/F_{j-1,k}(\mathcal{C}) \cong \prod_k \Gamma_{[k,k+j]}(\mathcal{C})$ to the output space $\mathcal{C}_j/\mathcal{C}_{j-1} \cong \prod_k \Gamma_{[k,k+j]}(\mathcal{C})$. The state space of the j th-level encoder at any time is isomorphic to $\sigma_k(\mathcal{C}_j)/\sigma_k(\mathcal{C}_{j-1})$ and is thus minimal.

Since the parallel transition subcode $\mathcal{C}_0 = \prod_k \mathcal{C}_{:\{k\}}$ is a memoryless sequence space, the zeroth-level encoder for \mathcal{C}_0 requires no memory; the output is simply a complete, Laurent or finite sequence of elements from the parallel transition subgroups $F_{0,k}(\mathcal{C}) = \mathcal{C}_{:\{k\}}$, $k \in \mathbb{Z}$.

Finally, a minimal encoder for \mathcal{C} in controller form may be implemented by adding the outputs of all j th-level encoders, $0 \leq j \leq L$. Such an encoder implements a one-to-one correspondence from $\prod_k F_k(\mathcal{C})$ to \mathcal{C} , but not necessarily an isomorphism [15] (see also [28], [29]).

B. Controllable and uncontrollable codes

We now extend the results above to codes $\mathcal{C} \subseteq \mathcal{W}$ that are not necessarily strongly controllable. For simplicity, we take \mathcal{W} to be a complete sequence space.

We then have a chain of subcodes

$$\{0\} \subseteq \mathcal{C}_0 \subseteq \mathcal{C}_1 \subseteq \cdots \subseteq (\mathcal{C}_f)^c \subseteq \mathcal{C},$$

where \mathcal{C}_j is the j -controllable subcode of \mathcal{C} , $j \geq 0$, and $(\mathcal{C}_f)^c$ is the controllable subcode of \mathcal{C} . We recall that \mathcal{C} is controllable if and only if $(\mathcal{C}_f)^c = \mathcal{C}$.

Since $(\mathcal{C}_f)^c$ is the (closure of the) code generated by all finite subcodes of \mathcal{C} ,

$$(\mathcal{C}_f)^c = \sum_{\text{finite } \mathcal{J}} \mathcal{C}_{\mathcal{J}},$$

it is clear in the topological setting that $(\mathcal{C}_f)^c$ may be regarded as the “limit” of the j -controllable subcodes \mathcal{C}_j as $j \rightarrow \infty$. For instance, if the symbol groups are discrete, then $(\mathcal{C}_f)^c$ is the code consisting of the limits of all finite sequences in \mathcal{C} in the topology of pointwise convergence.

\mathcal{C} is therefore controllable if and only if every sequence in \mathcal{C} can be expressed as such a limit of finite code sequences. If \mathcal{C} is uncontrollable, then the code sequences not in $(\mathcal{C}_f)^c$ not only are not finite, but also are not the limit of any series of finite sequences in \mathcal{C} . For example, in Examples 2 and 4, the only finite sequence in \mathcal{C} is $\mathbf{0}$.

Again, there are state space and state code chains as follows:

$$\begin{aligned} \{0\} &\subseteq \sigma_k(\mathcal{C}_1) \subseteq \cdots \subseteq \sigma_k((\mathcal{C}_f)^c) \subseteq \sigma_k(\mathcal{C}) = \Sigma_k(\mathcal{C}); \\ \{0\} &\subseteq \sigma(\mathcal{C}_1) \subseteq \cdots \subseteq \sigma((\mathcal{C}_f)^c) \subseteq \sigma(\mathcal{C}). \end{aligned}$$

Since $\mathcal{C}/(\mathcal{C}_f)^c \cong \sigma(\mathcal{C})/\sigma((\mathcal{C}_f)^c)$ (because the kernel \mathcal{C}_0 of the state map is a subcode of both $(\mathcal{C}_f)^c$ and \mathcal{C}), it follows that $(\mathcal{C}_f)^c = \mathcal{C}$ if and only if $\sigma((\mathcal{C}_f)^c) = \sigma(\mathcal{C})$:

Theorem 7.1 (dynamical controllability test): A complete group code \mathcal{C} is controllable if and only if $\sigma((\mathcal{C}_f)^c) = \sigma(\mathcal{C})$.

In other words, finitization preserves the dynamics of \mathcal{C} if and only if \mathcal{C} is controllable.

Let \mathcal{C} be time-invariant, so that all state spaces $\Sigma_k(\mathcal{C})$ are congruent to $\Sigma_0(\mathcal{C})$, and suppose that $\Sigma_0(\mathcal{C})$ satisfies the descending chain condition (DCC). Then \mathcal{C} is complete [29, Prop. 3.6]; moreover, by the DCC, there can be only a finite number of steps in the state space chain, which implies that the controllable subcode $(\mathcal{C}_f)^c$ is strongly controllable (see [28], [29]). Thus we have:

Theorem 7.2: If \mathcal{C} is a time-invariant group code whose state space $\Sigma_0(\mathcal{C})$ satisfies the descending chain condition, then $(\mathcal{C}_f)^c$ is strongly controllable. Thus \mathcal{C} is controllable if and only if \mathcal{C} is strongly controllable.

Example 6, in which \mathcal{C} is controllable but not strongly controllable even though the state space is never larger than G , shows that time-invariance is essential.

Theorem 7.2 has been extended to time-invariant group codes over finitely generated abelian symbol groups in [6], and to time-invariant ring codes over finitely generated modules over a principal ideal domain in [9]. All versions of Theorem 7.2 depend on some sort of finiteness condition.

The basic structure theorem of Miles and Thomas [30] (see [6]) says that if G is a compact abelian Lie group and $\mathcal{C} \subseteq G^{\mathbb{Z}}$ is a closed time-invariant group code over G , then there exists a finite chain

$$\{\mathbf{0}\} \subseteq \mathcal{C}_0 \subseteq \mathcal{C}_1 \subseteq \dots \subseteq \mathcal{C}_L = (\mathcal{C}_f)^c \subseteq \mathcal{C}^s \subseteq \mathcal{C}$$

of closed normal time-invariant subcodes of \mathcal{C} , where $\mathcal{C}_j/\mathcal{C}_{j-1} \cong (G_j)^{\mathbb{Z}}$ for some compact Lie group G_j (in our setting, G_j may be identified with the j th-level controller granule $\Gamma_{[k,k+j]}$); $\mathcal{C}^s/(\mathcal{C}_f)^c$ is a solenoid (a compact connected abelian group of finite topological dimension), as in our Example 4; and $\mathcal{C}/\mathcal{C}^s$ is autonomous (a semi-simple Lie group), as in our Example 2. Using this theorem, Kitchens and Schmidt [24] show that if \mathcal{C} is a compact controllable time-invariant group code whose state space $\Sigma_0(\mathcal{C})$ satisfies the DCC, then \mathcal{C} is strongly controllable.

C. Observable and unobservable codes

An observer decomposition of \mathcal{C} may be obtained by simply “dualizing” the controller decomposition just described.

The **j -observable supercode** \mathcal{C}^j of a group code \mathcal{C} in a sequence space \mathcal{W} is defined as

$$\mathcal{C}^j = \{\mathbf{w} \in \mathcal{W} \mid \mathbf{w}_{|[k,k+j]} \in \mathcal{C}_{|[k,k+j]} \text{ for all } k \in \mathbb{Z}\}.$$

If \mathcal{W} is complete, then \mathcal{C}^j by definition is j -complete.

By projection/subcode duality, we have:

Theorem 7.3 (subcode/supercode duality): If \mathcal{C} and \mathcal{C}^\perp are dual group codes, then the j -observable supercode of \mathcal{C}^\perp is the dual of the j -controllable subcode of \mathcal{C} :

$$(\mathcal{C}^\perp)^j = (\mathcal{C}_j)^\perp.$$

It follows that \mathcal{C}^j is j -observable, and that \mathcal{C} is L -observable if and only if $\mathcal{C} = \mathcal{C}^L$.

Since the dual of the controllable subcode $(\mathcal{C}_f)^c$ of a complete code \mathcal{C} is the observable supercode $((\mathcal{C}^\perp)^c)_f$ of the

finite code \mathcal{C}^\perp , we have for a finite code \mathcal{C} a supercode chain dual to the subcode chain of \mathcal{C}^\perp :

$$\mathcal{C} \subseteq (\mathcal{C}^c)_f \subseteq \dots \subseteq \mathcal{C}^1 \subseteq \mathcal{C}^0 = \mathcal{W}(\mathcal{C}) \subseteq \mathcal{W}_f.$$

Again, by duality $(\mathcal{C}^c)_f$ is the “limit” of the j -observable supercodes \mathcal{C}^j as $j \rightarrow \infty$.

Each of these supercodes has well-defined state spaces Σ_k , which are trivial in the case of the memoryless supercodes $\mathcal{C}^0 = \mathcal{W}(\mathcal{C})$ and \mathcal{W}_f , and well-defined state maps σ_k and $\sigma = \{\sigma_k, k \in \mathcal{I}\}$. By dualizing Theorem 7.1, we obtain:

Theorem 7.4 (dynamic observability test): A finite group code \mathcal{C} is observable if and only if $\sigma((\mathcal{C}^c)_f) = \sigma(\mathcal{C})$.

In other words, completion preserves the dynamics of \mathcal{C} if and only if \mathcal{C} is observable.

Also, by dualizing Theorem 7.2, we obtain:

Theorem 7.5: If \mathcal{C} is a finite time-invariant group code whose state space $\Sigma_0(\mathcal{C})$ satisfies the descending chain condition, then $(\mathcal{C}^c)_f$ is strongly observable. Consequently, \mathcal{C} is observable if and only if \mathcal{C} is strongly observable.

D. Observer granule decomposition

Now let \mathcal{C} be a general finite, Laurent or complete L -observable group code. Then we have an ascending j -observable supercode chain:

$$\mathcal{C} = \mathcal{C}^L \subseteq \mathcal{C}^{L-1} \subseteq \dots \subseteq \mathcal{C}^0 = \mathcal{W}(\mathcal{C}) \subseteq \mathcal{W}.$$

For indexing consistency, we denote \mathcal{W} by \mathcal{C}^{-1} .

The 0-observable supercode $\mathcal{C}^0 = \prod_k \mathcal{C}_{\{k\}}$ is the output sequence space $\mathcal{W}(\mathcal{C})$, a memoryless sequence space of the same type as \mathcal{W} .

By Theorem 7.3, this chain is dual to the subcode chain of the dual code \mathcal{C}^\perp :

$$(\mathcal{C}^\perp)_{-1} = \{\mathbf{0}\} \subseteq (\mathcal{C}^\perp)_0 \subseteq (\mathcal{C}^\perp)_1 \subseteq \dots \subseteq (\mathcal{C}^\perp)_L = \mathcal{C}^\perp.$$

By quotient group duality, the quotients of the latter chain act as the character groups of the quotients of the former:

$$\left(\frac{\mathcal{C}^{j-1}}{\mathcal{C}^j}\right)^\wedge = \frac{(\mathcal{C}^\perp)_j}{(\mathcal{C}^\perp)_{j-1}}, \quad 0 \leq j \leq L.$$

Note that the output sequence space $\mathcal{W}(\mathcal{C}) = \mathcal{C}^0$ acts as the character group of the parallel transition subcode $(\mathcal{C}^\perp)_0$, and that $\mathcal{W}(\mathcal{C}) = \mathcal{W}$ if and only if $(\mathcal{C}^\perp)_0 = \{\mathbf{0}\}$. Dynamically, \mathcal{C} should be regarded as lying between the memoryless sequence spaces \mathcal{C}_0 and $\mathcal{W}(\mathcal{C})$, rather than between $\{\mathbf{0}\}$ and \mathcal{W} . Trimming the sequence space \mathcal{W} to $\mathcal{W}(\mathcal{C})$ is dual to factoring out the parallel transition subcode to yield the dynamically equivalent “label code” $\mathbf{q}(\mathcal{C}) \cong \mathcal{C}/\mathcal{C}_0$ [15].

Since

$$\frac{(\mathcal{C}^\perp)_j}{(\mathcal{C}^\perp)_{j-1}} \cong \prod_k \Gamma_{[k,k+j]}(\mathcal{C}^\perp),$$

it follows from direct product/direct sum duality that

$$\frac{\mathcal{C}^{j-1}}{\mathcal{C}^j} \cong \prod_k \Gamma_{[k,k+j]}(\mathcal{C}^\perp)^\wedge$$

where as usual the indicated product denotes a direct product, Laurent product, or direct sum according to the character of \mathcal{W} .

Since the controller granule $\Gamma_{[k,k+j]}(\mathcal{C}^\perp)$ is defined as a quotient group, it is natural to define the **observer granule** $\Phi_{[k,k+j]}(\mathcal{C})$ as the dual quotient group:

$$\Phi_{[k,k+j]}(\mathcal{C}) = \frac{(\mathcal{C}^{j-1})_{|[k,k+j]}}{(\mathcal{C}^j)_{|[k,k+j]}}, \quad k \in \mathbb{Z}, 0 \leq j \leq L.$$

For $0 \leq j \leq L$, $(\mathcal{C}^j)_{|[k,k+j]} = \mathcal{C}_{|[k,k+j]}$, so the cosets of $(\mathcal{C}^j)_{|[k,k+j]}$ in $(\mathcal{C}^{j-1})_{|[k,k+j]}$ are represented by sequences in $(\mathcal{C}^{j-1})_{|[k,k+j]}$ that are not in $\mathcal{C}_{|[k,k+j]}$.

For $1 \leq j \leq L$, we may write $(\mathcal{C}^{j-1})_{|[k,k+j]}$ as

$$\{\mathbf{w} \in \mathcal{W} \mid \mathbf{w}_{|[k,k+j]} \in \mathcal{C}_{|[k,k+j]}, \mathbf{w}_{|(k,k+j)} \in \mathcal{C}_{|(k,k+j)}\} \\ = (\mathcal{C}_{|[k,k+j]} \times \mathcal{W}_{\{k+j\}}) \cap (\mathcal{W}_{\{k\}} \times \mathcal{C}_{|(k,k+j)}).$$

In other words, $\Phi_{[k,k+j]}(\mathcal{C})$ is the quotient of the subset of sequences in $\mathcal{W}_{|[k,k+j]}$ that satisfy the checks of \mathcal{C} on the intervals $[k, k+j]$ and $(k, k+j]$ with the subset that checks on the entire interval $[k, k+j]$.

For $j = 1$, we have $(\mathcal{C}^0)_{|[k,k+1]} = \mathcal{C}_{\{k\}} \times \mathcal{C}_{\{k+1\}}$, so

$$\Phi_{[k,k+1]}(\mathcal{C}) = \frac{\mathcal{C}_{\{k\}} \times \mathcal{C}_{\{k+1\}}}{\mathcal{C}_{|[k,k+1]}}.$$

In other words, $\Phi_{[k,k+1]}(\mathcal{C})$ is the reciprocal state space of $\mathcal{C}_{|[k,k+1]}$ as a length-2 code.

For $j = 0$, we have $(\mathcal{C}^{-1})_{|[k,k]} = G_k$ and $(\mathcal{C}^0)_{|[k,k]} = \mathcal{C}_{\{k\}}$, so the zeroth-level (nondynamical) time- k observer granule is

$$\Phi_{[k,k]}(\mathcal{C}) = \frac{G_k}{\mathcal{C}_{\{k\}}}.$$

Now in summary, having defined observer granules to be dual to controller granules, we obtain our main duality and decomposition theorems:

Theorem 7.6 (granule duality): If \mathcal{C} and \mathcal{C}^\perp are dual group codes, then the observer granule $\Phi_{[k,k+j]}(\mathcal{C})$ acts as the character group of the controller granule $\Gamma_{[k,k+j]}(\mathcal{C}^\perp)$:

$$\Gamma_{[k,k+j]}(\mathcal{C}^\perp)^\wedge = \Phi_{[k,k+j]}(\mathcal{C}).$$

Proof. Follows from quotient group duality, projection/subcode duality, and subcode/supercode duality. \square

Corollary 7.7 (observer granule decomposition theorem): If \mathcal{C} is a complete (resp. Laurent, finite) group code, then $\mathcal{C}^{j-1}/\mathcal{C}^j$ is isomorphic to the direct product (resp. Laurent product, direct sum) of the observer granules $\Phi_{[k,k+j]}(\mathcal{C})$:

$$\frac{\mathcal{C}^{j-1}}{\mathcal{C}^j} \cong \prod_k \Phi_{[k,k+j]}(\mathcal{C}), \quad j \geq 0.$$

Thus we may decompose a sequence in \mathcal{W} according to the j -observable supercode chain into a sequence in \mathcal{C} and representatives of $\mathcal{C}^{j-1}/\mathcal{C}^j$, $0 \leq j \leq L$, and then decompose each of these into a product of observer granule representatives.

Example 2 (cont.) The bi-infinite zero-sum code \mathcal{C}^\perp over G^\wedge is 1-controllable. Its 0-controllable subcode is $\{\mathbf{0}\}$, and its 1-controllable subcode is itself. Its only nontrivial controller granules are therefore the first-level granules $\Gamma_{[k,k+1]}(\mathcal{C}^\perp) = (\mathcal{C}^\perp)_{:[k,k+1]}$, each of which is a group of length-2 sequences of the form $(\dots, 0, h, -h, 0, \dots)$ with $h \in G^\wedge$, and is isomorphic to G^\wedge . \mathcal{C}^\perp is the code generated by all finite sums of such sequences, and thus is isomorphic to the finite sequence space $((G^\wedge)^\mathbb{Z})_f$.

The dual bi-infinite repetition code \mathcal{C} over G is 1-observable. Its only nontrivial observer granules are the first-level granules $\Phi_{[k,k+1]}(\mathcal{C}) = (\mathcal{C}_{\{k\}} \times \mathcal{C}_{\{k+1\}})/\mathcal{C}_{|[k,k+1]}$. Now $\mathcal{C}_{\{k\}} \times \mathcal{C}_{\{k+1\}}$ is the set of all pairs $\{(g, h), g, h \in G\}$, while $\mathcal{C}_{|[k,k+1]}$ is the set of all repeated pairs $\{(g, g), g \in G\}$, so $\Phi_{[k,k+1]}(\mathcal{C}) \cong G$. Sets of coset representatives for $\Phi_{[k,k+1]}(\mathcal{C})$ are $\{(0, g), g \in G\}$ or $\{(g, 0), g \in G\}$. The quotient \mathcal{W}/\mathcal{C} is isomorphic to the direct product of these granules—*i.e.*, to the complete sequence space $G^\mathbb{Z}$. \square

Example 3 (cont.) Here the rate-1/3 convolutional code \mathcal{C} is 2-controllable and 1-observable, while its dual rate-2/3 code \mathcal{C}^\perp is 1-controllable and 2-observable. The zeroth-level controller granules of \mathcal{C}^\perp are generated by $(\dots, 000, 002, 000, \dots)$ and are isomorphic to \mathbb{Z}_2 ; the first-level controller granules are generated by generators $\mathbf{h}_1 = (\dots, 000, 100, 030, 000, \dots)$, which has order 4, and $\mathbf{h}_2 = (\dots, 000, 020, 001, 000, \dots)$, which has order 2 modulo the zeroth-level granules, so they are isomorphic to $\mathbb{Z}_4 \times \mathbb{Z}_2$. This confirms that the state space $\Sigma_0(\mathcal{C}^\perp)$ is isomorphic to $\mathbb{Z}_4 \times \mathbb{Z}_2$.

It follows that \mathcal{C} has nontrivial observer granules at levels 0 and 1 isomorphic to \mathbb{Z}_2 and to $\mathbb{Z}_4 \times \mathbb{Z}_2$, respectively. Indeed, $\mathcal{C}_{\{k\}}$ is the 32-element subgroup $\mathbb{Z}_4 \times \mathbb{Z}_4 \times 2\mathbb{Z}_4$ of the 64-element group $G_k = (\mathbb{Z}_4)^3$, so the nondynamical length-1 granules $G_k/\mathcal{C}_{\{k\}}$ are isomorphic to \mathbb{Z}_2 ; a nonzero coset representative is 001. We verify that the length-2 observer granules $\Phi_{[k,k+1]}(\mathcal{C}) = (\mathcal{C}_{\{k\}} \times \mathcal{C}_{\{k+1\}})/\mathcal{C}_{|[k,k+1]}$ have order 8, since $|\mathcal{C}_{\{k\}} \times \mathcal{C}_{\{k+1\}}| = 32 \times 32$, whereas $|\mathcal{C}_{|[k,k+1]}| = 8 \times 4 \times 4$ (the number of states times the number of input pairs). A set of coset representatives for $\mathcal{C}_{|[k,k+1]}$ in $\mathcal{C}_{\{k\}} \times \mathcal{C}_{\{k+1\}}$ is generated by (000, 010) and (000, 002), so the length-2 observer granules are indeed isomorphic to $\mathbb{Z}_4 \times \mathbb{Z}_2$.

Similarly, the first-level controller granules of \mathcal{C} are generated by sequences such as $(\dots, 000, 200, 020, 000, \dots)$ and are isomorphic to \mathbb{Z}_2 , while the second-level controller granules are generated by $\mathbf{g} = (\dots, 000, 100, 010, 002, 000, \dots)$, modulo the first-level granules, and thus are also isomorphic to \mathbb{Z}_2 . It follows that \mathcal{C}^\perp has nontrivial observer granules for $j = 1$ and $j = 2$, all isomorphic to \mathbb{Z}_2 , as the reader may verify. Since first-level granules are active for 1 time unit and second-level granules are active for 2 time units, this implies a state space of size 8. \square

Example 4 (cont.) The dual code \mathcal{C}^\perp over \mathbb{Z} is again 1-controllable. As in Example 2, the only nontrivial controller granules are the first-level granules $\Gamma_{[k,k+1]}(\mathcal{C}^\perp) = (\mathcal{C}^\perp)_{:[k,k+1]}$, which are generated by time shifts of $\mathbf{h} = (\dots, 0, 1, -2, 0, \dots)$, and are isomorphic to \mathbb{Z} . \mathcal{C}^\perp is generated by all finite sums of such sequences, and thus is isomorphic to the finite sequence space $(\mathbb{Z}^\mathbb{Z})_f$.

The primal code \mathcal{C} over \mathbb{R}/\mathbb{Z} is 1-observable. Its only nontrivial observer granules are the first-level granules $\Phi_{[k,k+1]}(\mathcal{C}) = (\mathcal{C}_{\{k\}} \times \mathcal{C}_{\{k+1\}})/\mathcal{C}_{|[k,k+1]}$. Now $\mathcal{C}_{\{k\}} \times \mathcal{C}_{\{k+1\}}$ is the set of all pairs $\{(g, h), g, h \in \mathbb{R}/\mathbb{Z}\}$, whereas $\mathcal{C}_{|[k,k+1]}$ is the set of all pairs $\{(g, h) \mid g \equiv 2h \pmod{\mathbb{Z}}\}$. Since g is determined by h , $\mathcal{C}_{|[k,k+1]} \cong \mathbb{R}/\mathbb{Z}$ and $\Phi_{[k,k+1]}(\mathcal{C}) \cong \mathbb{R}/\mathbb{Z}$. Sets of coset representatives for $\mathcal{C}_{|[k,k+1]}$ are $\{(g, 0), g \in \mathbb{R}/\mathbb{Z}\}$ or $\{(0, h/2), h \in \mathbb{R}/\mathbb{Z}\}$. \mathcal{W}/\mathcal{C} is isomorphic to the direct product of these granules—*i.e.*, to $(\mathbb{R}/\mathbb{Z})^\mathbb{Z}$. \square

E. Observer granule decomposition of state spaces

We now obtain an observer decomposition of the state spaces and state code of an L -observable code \mathcal{C} by dualizing the controller decomposition of an L -controllable code \mathcal{C}^\perp , again using the chain of j -observable supercodes \mathcal{C}^j .

Combining the reciprocal state space theorem with subcode/supercode duality, we obtain the following basic result:

Theorem 7.8 (state space duality): If \mathcal{C} and \mathcal{C}^\perp are group codes, then the reciprocal state space $\Sigma^k(\mathcal{C}^j)$ of the j -observable supercode \mathcal{C}^j at time k acts as the character group of the state space $\Sigma_k((\mathcal{C}^\perp)_j)$ of the j -controllable subcode $(\mathcal{C}^\perp)_j$ at time k : $\Sigma^k(\mathcal{C}^j) = \Sigma_k((\mathcal{C}^\perp)_j)^\wedge$.

Thus the j -observable state space $\sigma_k(\mathcal{C}^j)$ is isomorphic to the character group of the j -controllable state space $\sigma_k((\mathcal{C}^\perp)_j)$, and $\sigma(\mathcal{C}^j) \cong \sigma((\mathcal{C}^\perp)_j)^\wedge$.

For the state spaces of the ascending chain of the j -controllable subcodes $(\mathcal{C}^\perp)_j$ of the L -controllable dual code \mathcal{C}^\perp , we have chains of inclusion maps as follows:

$$\begin{aligned} \{0\} &\rightarrow \sigma_k((\mathcal{C}^\perp)_1) \rightarrow \cdots \rightarrow \sigma_k((\mathcal{C}^\perp)_L) = \sigma_k(\mathcal{C}^\perp); \\ \{0\} &\rightarrow \sigma((\mathcal{C}^\perp)_1) \rightarrow \cdots \rightarrow \sigma((\mathcal{C}^\perp)_L) = \sigma(\mathcal{C}^\perp). \end{aligned}$$

This shows that $\sigma_k(\mathcal{C}^\perp)$ and $\sigma(\mathcal{C}^\perp)$ may be regarded as being composed of the quotient groups $\sigma_k((\mathcal{C}^\perp)_j)/\sigma_k((\mathcal{C}^\perp)_{j-1})$ and $\sigma((\mathcal{C}^\perp)_j)/\sigma((\mathcal{C}^\perp)_{j-1})$, respectively.

As discussed in Section II-F, although $\sigma_k((\mathcal{C}^\perp)_{j-1})$ is a subgroup of $\sigma_k((\mathcal{C}^\perp)_j)$, the dual state space (character group) $\sigma_k(\mathcal{C}^{j-1})$ is not in general a subgroup of $\sigma_k(\mathcal{C}^j)$. Nevertheless, there still exists a decomposition into dual quotient groups. The adjoint chains of the above inclusion map chains are chains of natural maps, as follows:

$$\begin{aligned} \sigma_k(\mathcal{C}^L) = \Sigma_k(\mathcal{C}) &\rightarrow \cdots \rightarrow \sigma_k(\mathcal{C}^1) \rightarrow \{0\}; \\ \sigma(\mathcal{C}^L) = \sigma(\mathcal{C}) &\rightarrow \cdots \rightarrow \sigma(\mathcal{C}^1) \rightarrow \{0\}. \end{aligned}$$

Moreover, $\Sigma_k(\mathcal{C})$ and $\sigma(\mathcal{C})$ may be regarded as being composed of the respective kernels of these maps, $(\sigma_k((\mathcal{C}^\perp)_j)/\sigma_k((\mathcal{C}^\perp)_{j-1}))^\wedge$ and $(\sigma((\mathcal{C}^\perp)_j)/\sigma((\mathcal{C}^\perp)_{j-1}))^\wedge$.

Dualizing our granule decompositions of these quotient groups and using direct product/direct sum duality, we have

$$\begin{aligned} \left(\frac{\sigma_k((\mathcal{C}^\perp)_j)}{\sigma_k((\mathcal{C}^\perp)_{j-1})} \right)^\wedge &\cong \prod_{i \in [k-j, k]} \Phi_{[i, i+j]}(\mathcal{C}), \quad 1 \leq j \leq L; \\ \left(\frac{\sigma((\mathcal{C}^\perp)_j)}{\sigma((\mathcal{C}^\perp)_{j-1})} \right)^\wedge &\cong \prod_{k \in \mathbb{Z}} \Phi_{[k, k+j]}(\mathcal{C}), \quad 1 \leq j \leq L. \end{aligned}$$

As we have already seen, the latter is isomorphic to $\mathcal{C}^{j-1}/\mathcal{C}^j$.

In summary:

Theorem 7.9 (dual state granule theorem): Let \mathcal{C} be an L -observable group code, let $\Sigma_k(\mathcal{C})$ be its state space at time k , and let $\sigma_k(\mathcal{C}^j)$ be the state space at time k of its j -observable supercode \mathcal{C}^j . Then there exists a chain of natural maps

$$\sigma_k(\mathcal{C}^L) = \Sigma_k(\mathcal{C}) \rightarrow \cdots \rightarrow \sigma_k(\mathcal{C}^1) \rightarrow \{0\} = \sigma_k(\mathcal{C}^0),$$

whose kernels are isomorphic to direct products of the j observer granules $\Phi_{[i, i+j]}(\mathcal{C})$, $k-j \leq i < k$, for $1 \leq j \leq L$. Consequently there is a one-to-one correspondence between the state space $\Sigma_k(\mathcal{C})$ and the Cartesian product of the observer granules $\Phi_{[i, i+j]}(\mathcal{C})$, $k-j \leq i < k$, $1 \leq j \leq L$.

F. Dual first-output and last-output groups

What is the dual to the j th first-output group $F_{j,k}(\mathcal{C}) = (\mathcal{C}_{:[k, k+j]})_{|\{k\}}$ (which can also be thought of as the input group at level j at time k)? By projection/subcode duality, it is the parallel transition subgroup at time k of $(\mathcal{C}^\perp)_{|[k, k+j]}$. In other words, $F_{j,k}(\mathcal{C})^\perp$ is the set $((\mathcal{C}^\perp)_{:\mathcal{I}-(k, k+j)})_{|\{k\}}$ of time- k symbols in all sequences in \mathcal{C}^\perp whose components are all zero during $(k, k+j]$.

We therefore define the **j th-level dual last-output group** of \mathcal{C} at time k as

$$L^{j,k}(\mathcal{C}) = F_{j,k}(\mathcal{C})^\perp = (\mathcal{C}_{:\mathcal{I}-(k, k+j)})_{|\{k\}}.$$

In other words, $L^{j,k}(\mathcal{C})$ is the set of time- k symbols that can be followed by a sequence of j consecutive zeroes, or equivalently that can precede the zero state in $\sigma_k(\mathcal{C}^j)$.

Note that $L^{0,k}(\mathcal{C}) = \mathcal{C}_{|\{k\}}$. Moreover, if \mathcal{C} is L -observable, then $L^{L,k}(\mathcal{C}) = L_k(\mathcal{C})$, because by the second $[m, n]$ -observability test $\mathcal{C}_{:\mathcal{I}-(k, k+L)} = \mathcal{C}_{:(k+1)^-} \times \mathcal{C}_{:(k+L+1)^+}$.

Thus the *time- k dual last-output chain* of \mathcal{C} ,

$$L_k(\mathcal{C}) = L^{L,k}(\mathcal{C}) \subseteq L^{L-1,k}(\mathcal{C}) \subseteq \cdots \subseteq L^{0,k}(\mathcal{C}) = \mathcal{C}_{|\{k\}},$$

is dual to the time- k first-output chain of \mathcal{C}^\perp . By quotient group duality, the quotients of this chain are the character groups of the quotients of the dual chain. These quotients are isomorphic to the controller granules of \mathcal{C}^\perp , whose character groups act as the observer granules of \mathcal{C} :

$$\frac{L^{j-1,k}(\mathcal{C})}{L^{j,k}(\mathcal{C})} \cong \Phi_{[k, k+j]}(\mathcal{C}), \quad 0 \leq j \leq L.$$

Similarly, we define the **j th-level dual first-output group** of \mathcal{C} at time k as

$$F^{j,k}(\mathcal{C}) = L_{j,k}(\mathcal{C})^\perp = (\mathcal{C}_{:\mathcal{I}-[k-j, k]})_{|\{k\}}.$$

In other words, $F^{j,k}(\mathcal{C})$ is the set of time- k symbols that can follow a sequence of j consecutive zeroes, or equivalently that can follow the zero state in $\sigma_k(\mathcal{C}^j)$.

Again we have $F^{0,k}(\mathcal{C}) = \mathcal{C}_{|\{k\}}$, and if \mathcal{C} is L -observable, then $F^{L,k}(\mathcal{C}) = F_k(\mathcal{C})$, since $\mathcal{C}_{:\mathcal{I}-[k-L, k]} = \mathcal{C}_{:(k-L)^-} \times \mathcal{C}_{:k^+}$. The *time- k dual first-output chain* of \mathcal{C} ,

$$F_k(\mathcal{C}) = F^{L,k}(\mathcal{C}) \subseteq F^{L-1,k}(\mathcal{C}) \subseteq \cdots \subseteq F^{0,k}(\mathcal{C}) = \mathcal{C}_{|\{k\}},$$

is dual to the time- k last-output chain of \mathcal{C}^\perp , and the quotients are isomorphic to observer granules:

$$\frac{F^{j-1,k}(\mathcal{C})}{F^{j,k}(\mathcal{C})} \cong \Phi_{[k-j, k]}(\mathcal{C}), \quad 0 \leq j \leq L.$$

The quotient $G_k/F_k(\mathcal{C})$ will be called the **syndrome group** $S_k(\mathcal{C})$ of \mathcal{C} at time k , and the quotient $F^{j-1,k}(\mathcal{C})/F^{j,k}(\mathcal{C})$ will be called the **j th-level syndrome group** $S_{j,k}(\mathcal{C})$ at time k , $0 \leq j \leq L$. The syndrome group at time k may be decomposed according to the dual first-output chain at time k into an element of the first-output group $F_k(\mathcal{C})$ and representatives of the quotients $F^{k,j-1}(\mathcal{C})/F^{k,j}(\mathcal{C})$, which are isomorphic to the observer granules that “end” at time k . The syndrome group $S_k(\mathcal{C})$ acts as the character group of $L_k(\mathcal{C}^\perp)$.

In summary:

Theorem 7.10 (first-output/last-output duality): If \mathcal{C} and \mathcal{C}^\perp are dual group codes and \mathcal{C} is L -observable, then the dual first-output (resp. last-output) chain of \mathcal{C} at time k is dual to the last-output (resp. first-output) chain of \mathcal{C}^\perp at time k . In particular,

$$\begin{aligned} F^{0,k}(\mathcal{C}) &= L^{0,k}(\mathcal{C}) = \mathcal{C}_{|\{k\}} = ((\mathcal{C}^\perp)_{|\{k\}})^\perp; \\ F^{L,k}(\mathcal{C}) &= F_k(\mathcal{C}) = (L_k(\mathcal{C}^\perp))^\perp; \\ L^{L,k}(\mathcal{C}) &= L_k(\mathcal{C}) = (F_k(\mathcal{C}^\perp))^\perp. \end{aligned}$$

The quotients of the dual chains of \mathcal{C} act as the character groups of the corresponding quotients of the primal chains of \mathcal{C}^\perp , and are isomorphic to observer granules as follows:

$$\begin{aligned} \frac{L^{j-1,k}(\mathcal{C})}{L^{j,k}(\mathcal{C})} &\cong \Phi_{[k,k+j]}(\mathcal{C}), \quad 0 \leq j \leq L; \\ \frac{F^{j-1,k}(\mathcal{C})}{F^{j,k}(\mathcal{C})} &\cong \Phi_{[k-j,k]}(\mathcal{C}), \quad 0 \leq j \leq L. \end{aligned}$$

VIII. MINIMAL OBSERVER-FORM ENCODERS AND SYNDROME-FORMERS

One original objective of this paper was to develop a minimal syndrome-former construction based on observer granules for a strongly observable code \mathcal{C} that would be dual to the minimal controller-form encoder construction of [15] for strongly controllable codes, with memory equal to the observer memory L . Such a syndrome-former is easily found in many cases: for Examples 2-4 of this paper, for codes and systems over fields [13], [21], and we dare say for most codes that the reader is likely to imagine. However, finding a general minimal syndrome-former construction that has all of the properties that one might desire turns out to be quite difficult.

This problem has now been solved satisfactorily by Fagnani and Zampieri [10]. Interestingly, their construction works equally well for nonabelian codes and, although it is based on the observer granule decomposition of the previous section, it does not make any use of duality.

In this section we construct minimal syndrome-formers and observer-form encoders for Examples 2-4 of this paper, and also for the main example of [10]. Our approach uses the observability granules of \mathcal{C} directly, and seems simpler than the general methods of [10] for these simple codes.

A **minimal syndrome-former** for \mathcal{C} is a dynamical map from \mathcal{W} to the syndrome sequence space $\prod_k S_k(\mathcal{C})$ that has at least the following properties:

- (a) The kernel of the map is the code \mathcal{C} ;
- (b) If \mathcal{C} is L -observable, then the map has memory L ;
- (c) The time- k state space corresponds in some way to the active observer granules at time k .

We also desire that the inverse images of the syndrome sequences form a disjoint partition of \mathcal{W} in which each inverse image is in some sense isomorphic to \mathcal{C} (see [10]). However, we ignore here the behavior of the syndrome-former for input sequences not in \mathcal{C} . Nevertheless, in all our examples, our syndrome-former construction turns out to have this property.

An encoder for \mathcal{C} is a dynamical one-to-one map from the memoryless input sequence space $\prod_k F_k(\mathcal{C})$ to \mathcal{C} . A **minimal observer-form encoder** for \mathcal{C} is an encoder for \mathcal{C} whose

state space at time k corresponds in some sense to the active observer granules at time k .

Our constructions will be based on the construction of a minimal state observer for \mathcal{C} . If \mathcal{C} is L -observable, then a **state observer** for \mathcal{C} with memory L is a system that maps $\mathbf{c}_{|[k-L,k]} \in \mathcal{C}_{|[k-L,k]}$ to the state $\sigma_k(\mathbf{c})$ of $\mathbf{c} \in \mathcal{C}$ at time k for each time k . In other words, the state observer dynamically implements the state map $\sigma : \mathcal{C} \rightarrow \sigma(\mathcal{C})$ using a “sliding window” of width L .

In view of the dual state granule theorem, the state $\sigma_k(\mathbf{c})$ is determined by the values of the observer granules $\Phi_{[i-j,i]}(\mathcal{C})$, $k \leq i < k+j$, $1 \leq j \leq L$; namely, the observer granules that are “active” at time k . A state observer is minimal if its state space at time k corresponds in some sense to the active observer granules at time k .

Our approach to realizing such a minimal state observer is as follows. If $\mathbf{c} \in \mathcal{C}$, then *a fortiori* $\mathbf{c} \in \mathcal{C}^j$ for all j -observable supercodes \mathcal{C}^j , $0 \leq j \leq L$. Given $\mathbf{c} \in \mathcal{C}^{j-1}$, the j th-level observer granule $\Phi_{[i-j,i]}(\mathcal{C})$ may be computed by determining the character table column (“check”)

$$\langle \Gamma_{[i-j,i]}(\mathcal{C}^\perp), \mathbf{c} \rangle = \{ \langle \mathbf{x}, \mathbf{c} \rangle \mid \mathbf{x} \in \Gamma_{[i-j,i]}(\mathcal{C}^\perp) \}$$

since $\Gamma_{[i-j,i]}(\mathcal{C}^\perp)$ acts as the character group of $\Phi_{[i-j,i]}(\mathcal{C})$. This requires the calculation of the pairing $\langle \mathbf{x}, \mathbf{c} \rangle$ only for a set of generators of $\Gamma_{[i-j,i]}(\mathcal{C}^\perp)$.

Since the pairing $\langle \mathbf{x}, \mathbf{c} \rangle$ is a componentwise sum over the interval $[i-j, i]$, and since the character table column $\langle \Gamma_{[i-j,i]}(\mathcal{C}^\perp), \mathbf{c} \rangle$ specifies an element of $\Phi_{[i-j,i]}(\mathcal{C})$, implementation of such a pairing requires only a memory element storing an element of $\Phi_{[i-j,i]}(\mathcal{C})$ that is active during the interval $(i-j, i]$. At each time during this interval, the memory element stores a “partial sum” in $\Phi_{[i-j,i]}(\mathcal{C})$. The values of all of the partial sums corresponding to all active observer granules is then the observer state at time k .

Given a minimal state observer for \mathcal{C} , a minimal observer-form encoder for \mathcal{C} may then be realized as follows. Assume that at time k the encoder has generated the past $\mathbf{c}_{|k-}$ of a code sequence $\mathbf{c} \in \mathcal{C}$. A minimal state observer that tracks this past will indicate the current state $\sigma_k(\mathbf{c})$ by the stored values of its currently active observer granules. The next output is then determined by an “input” in the first-output group $F_k(\mathcal{C})$ and the current state $\sigma_k(\mathbf{c})$.

Specifically, the next output $c_k \in G_k$ must be chosen so that all observer granules $\Phi_{[k-j,k]}(\mathcal{C})$, $0 \leq j \leq L$, that end at time k take on the value 0, since $\mathbf{w} \in \mathcal{C}$ if and only if the values of all quotients in the chain

$$\mathcal{C} = \mathcal{C}^L \subseteq \mathcal{C}^{L-1} \subseteq \dots \subseteq \mathcal{C}^0 \subseteq \mathcal{W}$$

are equal to zero. In view of the dual first-output chain

$$F_k(\mathcal{C}) = F^{L,k}(\mathcal{C}) \subseteq F^{L-1,k}(\mathcal{C}) \subseteq \dots \subseteq F^{0,k}(\mathcal{C}) = \mathcal{C}_{|\{k\}},$$

given representatives of each quotient group $F^{j-1,k}(\mathcal{C})/F^{j,k}(\mathcal{C}) \cong \Phi_{[k-j,k]}(\mathcal{C})$, this can be done by subtracting representatives from an arbitrary “free” input in $\mathcal{C}_{|\{k\}}$ according to the current partial sums of the ending granules $\Phi_{[k-j,k]}(\mathcal{C})$, leaving a residual free input in $F_k(\mathcal{C})$. This produces a next output c_k such that $\mathbf{c}_{|(k+1)-} \in \mathcal{C}_{|(k+1)-}$, which determines the next state, and so forth.

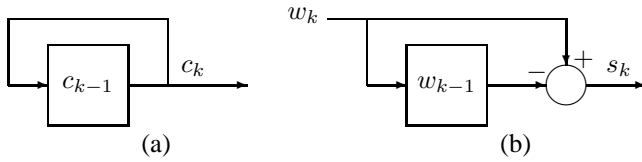

Figure 8.1. Minimal (a) observer-form encoder and (b) syndrome-former for bi-infinite repetition code \mathcal{C} .

Similarly, a minimal syndrome-former can simply check whether the next output is in the appropriate set determined by $\sigma_k(\mathbf{c})$. If so, it continues. If not, then it needs to make some “correction” to reduce it to this set, so that the state observer can continue.

We now give some applications of this approach.

Example 2 (cont.) For the bi-infinite repetition code \mathcal{C} over G , the state space at any time k is G , and consists of a single first-level observer granule $\Phi_{[k-1,k]}(\mathcal{C}) \cong G$. The first-output (input) group of \mathcal{C} is trivial, $F_k(\mathcal{C}) = \{0\}$, and the syndrome group $S_k(\mathcal{C})$ is G .

The check corresponding to $\Phi_{[k-1,k]}(\mathcal{C})$ is orthogonality to the dual first-level controller granule $\Gamma_{[k-1,k]}(\mathcal{C}^\perp) = \{(\dots, 0, h, -h, 0, \dots) \mid h \in G\}$. For $\mathbf{w} \in G^{\mathbb{Z}}$, we have

$$\langle (\dots, 0, h, -h, 0, \dots), \mathbf{w} \rangle = \{ \langle h, w_{k-1} - w_k \rangle \mid h \in G \},$$

which is equal to zero for all $h \in G$ if and only if $w_k = w_{k-1}$. A minimal state observer for \mathcal{C} therefore needs only to store the partial sum $w_{k-1} \in G$ at time k , so it has memory 1.

A minimal observer-form encoder for \mathcal{C} stores the previous output $c_{k-1} \in G$ and enforces the constraint $c_k = c_{k-1}$, as shown in Figure 8.1(a); *i.e.*, there is no nontrivial input, and the state space is G . The initial condition of the memory element is unspecified, and its effect persists indefinitely.

A minimal syndrome-former for \mathcal{C} may simply be constructed by implementing this check dynamically, as shown in Figure 8.1(b). (Conversely, the minimal encoder of Figure 8.1(a) may be obtained by forcing $s_k = 0$ in Figure 8.1(b).) The value of each check is the syndrome $s_k = w_k - w_{k-1} \in G$. The syndrome sequence is $\mathbf{0}$ if and only if $\mathbf{w} \in \mathcal{C}$, and in this case the syndrome-former acts as a state observer for \mathcal{C} . In this example each coset $\mathcal{C} + \mathbf{s}$ of \mathcal{C} in \mathcal{W} maps to a unique syndrome sequence $\mathbf{s} \in G^{\mathbb{Z}}$. \square

Example 3 (cont.) We now consider our 1-observable rate-1/3 convolutional code \mathcal{C} over \mathbb{Z}_4 .

For an element $g \in \mathbb{Z}_4$, it will often be useful to consider a two-bit representation $(g_1, g_0) \in (\mathbb{Z}_2)^2$ such that $g = 2g_1 + g_0$; *i.e.*, g_1 is the “high-order bit” and g_0 is the “low-order bit.”

We recall that \mathcal{C} has nontrivial observer granules at levels 0 and 1 isomorphic to \mathbb{Z}_2 and $\mathbb{Z}_4 \times \mathbb{Z}_2$, respectively. The zeroth-level observer granule corresponds to the constraint that $c_{k,3} \in 2\mathbb{Z}_4$ —*i.e.*, the low-order bit $c_{0,k,3}$ equals 0. Thus $\mathcal{C}_{\{0\}} = \mathbb{Z}_4 \times \mathbb{Z}_4 \times 2\mathbb{Z}_4$. The first-level granule corresponds to the constraint of orthogonality with the shifts of the generators $\mathbf{h}_1 = (\dots, 000, 100, 030, 000, \dots)$ and $\mathbf{h}_2 = (\dots, 000, 020, 001, 000, \dots)$ of \mathcal{C}^\perp . The inner product with \mathbf{h}_1 yields the constraint $c_{k-1} \cdot (100) + c_k \cdot (030) = 0$, or $c_{k,2} = c_{k-1,1}$. The inner product with \mathbf{h}_2 yields $c_{k-1} \cdot (020) + c_k \cdot (001) = 0$, or $c_{1,k,3} = c_{0,k-1,2}$.

In short, $c_{0,k,3} = 0$, $c_{1,k,3} = c_{0,k-1,2}$, and $c_{k,2} = c_{k-1,1}$. Thus we obtain a minimal observer-form encoder with “free input” $c_{k,1} \in \mathbb{Z}_4$, as shown in Figure 8.2(a). Note that this encoder is feedbackfree, and is also a minimal controller-form encoder with controller memory 2.

Similarly, a minimal syndrome-former for \mathcal{C} has two levels. The zeroth (nondynamical) level checks whether $w_{k,3} \in 2\mathbb{Z}_4$, or equivalently whether $w_{0,k,3} = 0$, and, if not, “corrects” to meet this constraint. This can be done simply by regarding $w_{0,k,3}$ as the zeroth-level syndrome, and ignoring it thereafter. The next (first) level checks the constraints $c_{k,2} = c_{k-1,1}$ and $c_{1,k,3} = c_{0,k-1,2}$ by forming the syndromes $s_{k,2} = w_{k,2} - w_{k-1,1} \in \mathbb{Z}_4$ and $s_{1,k,3} = w_{1,k,3} - w_{0,k-1,2} \in \mathbb{Z}_2$, as shown in Figure 8.2(b). For simplicity, we merely compare the two bits of $w_{k,2}$ and $w_{k-1,1}$; this makes the syndrome-former linear over \mathbb{Z}_2 .

The syndrome-former is evidently feedbackfree and has memory 1. Its output sequence \mathbf{s} is $\mathbf{0}$ if and only if $\mathbf{w} \in \mathcal{C}$, and in this case the syndrome-former acts as a state observer for \mathcal{C} .

For the dual 2-observable rate-2/3 code \mathcal{C}^\perp , recall that \mathcal{C}^\perp has nontrivial observer granules at levels 1 and 2 isomorphic to \mathbb{Z}_2 and \mathbb{Z}_2 , respectively. The first-level observer granules correspond to the constraint of orthogonality with the shifts of $2\mathbf{g} = (\dots, 000, 200, 020, 000, \dots)$, which yields the constraint $2c_{k,2} = 2c_{k-1,1}$, or $c_{0,k,2} = c_{0,k-1,1}$. The second-level observer granules correspond to orthogonality with the shifts of $\mathbf{g} = (\dots, 000, 100, 010, 002, 000, \dots)$, which yields $2c_{k,3} = c_{k-1,2} + c_{k-2,1}$. If $c_{0,k-1,2} = c_{0,k-2,1}$, which is guaranteed by the first-level constraint, then this is equivalent to $c_{0,k,3} = c_{1,k-1,2} + c_{1,k-2,1} + c_{0,k-2,1}$, where $c_{0,k-2,1}$ is a “carry bit.”

Thus we obtain a minimal observer-form encoder with “free” binary inputs $c_{1,k,1}, c_{0,k,1}, c_{1,k,2}, c_{1,k,3}$, shown in Figure 8.3(a). The encoder is feedbackfree with memory 2, and is \mathbb{Z}_2 -linear.

A minimal syndrome-former for \mathcal{C}^\perp again has two levels. The first level checks whether $w_{0,k,2} = w_{0,k-1,1}$ by forming the syndrome $s_{0,k,2} = w_{0,k,2} + w_{0,k-1,1} \in \mathbb{Z}_2$. The second level checks whether $w_{0,k,3} = w_{1,k-1,2} + w_{1,k-2,1}$ by forming the syndrome $w_{0,k,3} = w_{0,k,3} + w_{1,k-1,2} + w_{1,k-2,1} + w_{0,k-2,1} = w_{0,k,3} + t_{0,k-1,3} \in \mathbb{Z}_2$, as shown in Figure 8.3(b). The syndrome-former is feedbackfree with memory 2, and is \mathbb{Z}_2 -linear. \square

Example 4 (cont.) For Loeliger’s code \mathcal{C} , the state space at any time k is \mathbb{R}/\mathbb{Z} , and it consists of a single first-level observer granule $\Phi_{[k-1,k]}(\mathcal{C}) \cong \mathbb{R}/\mathbb{Z}$. The first-output (input) group of \mathcal{C} is binary, $F_k(\mathcal{C}) = \{0, \frac{1}{2}\} = (\frac{1}{2}\mathbb{Z})/\mathbb{Z}$, and the syndrome group $S_k(\mathcal{C})$ is $(\mathbb{R}/\mathbb{Z})/F_k(\mathcal{C}) \cong \mathbb{R}/\mathbb{Z}$. A set of representatives for $(\mathbb{R}/\mathbb{Z})/F_k(\mathcal{C})$ is the interval $[0, 1/2)$.

The check corresponding to $\Phi_{[k-1,k]}(\mathcal{C})$ is orthogonality to the dual first-level controller granule $\Gamma_{[k-1,k]}(\mathcal{C}^\perp)$, which is generated by $\mathbf{h} = (\dots, 0, 1, -2, 0, \dots)$. For $\mathbf{w} \in (\mathbb{R}/\mathbb{Z})^{\mathbb{Z}}$, we have

$$\langle \mathbf{h}, \mathbf{w} \rangle = w_{k-1} - 2w_k \in \mathbb{R}/\mathbb{Z}.$$

A minimal state observer for \mathcal{C} therefore needs only to store the partial sum $w_{k-1} \in \mathbb{R}/\mathbb{Z}$ of this check at time k , and thus has memory 1.

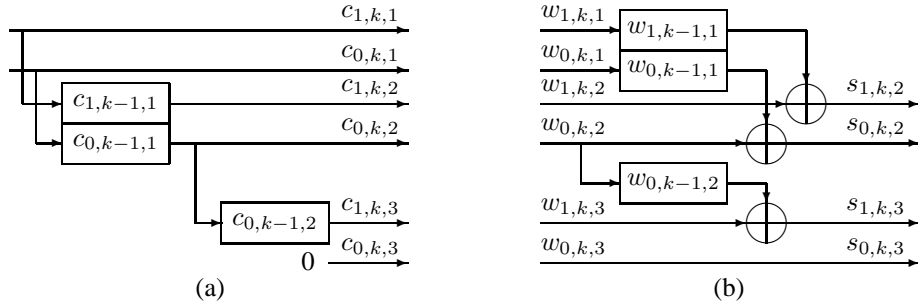

Figure 8.2 Minimal (a) observer-form encoder and (b) syndrome-former for rate-1/3 convolutional code over \mathbb{Z}_4 .

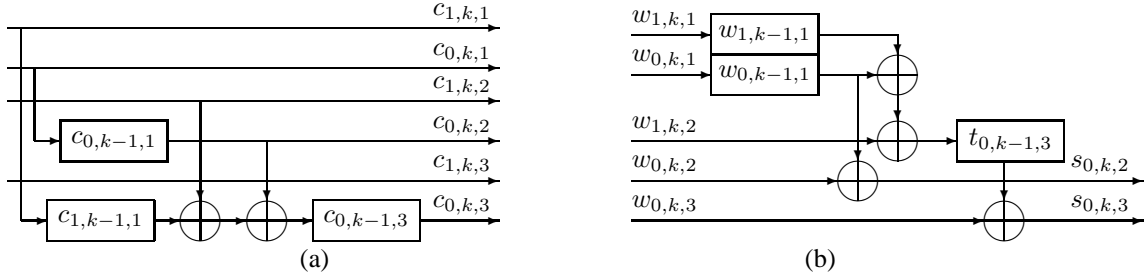

Figure 8.3 Minimal (a) observer-form encoder and (b) syndrome-former for rate-2/3 convolutional code over \mathbb{Z}_4 .

A minimal observer-form encoder for \mathcal{C} stores the previous output $c_{k-1} \in \mathbb{R}/\mathbb{Z}$ and enforces the constraint $2c_k = c_{k-1} \pmod{\mathbb{Z}}$. The set of $c_k \in \mathbb{R}/\mathbb{Z}$ that satisfy this constraint is the set $c_k = \{u_k + \frac{1}{2}c_{k-1} \mid u_k \in \{0, \frac{1}{2}\}\}$, so the encoder has a binary input $u_k \in F_k(\mathcal{C})$ and a state space of \mathbb{R}/\mathbb{Z} , as shown in Figure 8.4(a). The initial condition of the memory element decays to zero (but is still visible forever in c_k).

A minimal syndrome-former for \mathcal{C} may be constructed by implementing this check dynamically, as shown in Figure 8.4(b). (Conversely, the minimal encoder of Figure 8.4(a) may be obtained by forcing $s_k = 0$ in Figure 8.4(b). Note that there are two values of w_k that satisfy $2w_k = w_{k-1} \pmod{\mathbb{Z}}$, namely $w_k = \{u_k + \frac{1}{2}w_{k-1} \mid u_k \in \{0, \frac{1}{2}\}\}$.) The value of each check is the syndrome $s_k = 2w_k - w_{k-1} \in \mathbb{R}/\mathbb{Z}$. The syndrome sequence is $\mathbf{0}$ if and only if $\mathbf{w} \in \mathcal{C}$, and in this case the syndrome-former acts as a state observer for \mathcal{C} . In this example also each coset $\mathcal{C} + \mathbf{s}$ of \mathcal{C} in \mathcal{W} maps to a unique syndrome sequence $\mathbf{s} \in (\mathbb{R}/\mathbb{Z})^{\mathbb{Z}}$.

Finally, consider the chaotic time-reversed code $\tilde{\mathcal{C}}$. The state space at any time k is \mathbb{R}/\mathbb{Z} , and consists of a single first-level observer granule $\Phi_{[k-1,k]}(\mathcal{C}) \cong \mathbb{R}/\mathbb{Z}$. The first-output (input) group of $\tilde{\mathcal{C}}$ is trivial, $F_k(\tilde{\mathcal{C}}) = L_k(\tilde{\mathcal{C}}) = \{0\}$, and the syndrome group $S_k(\tilde{\mathcal{C}})$ is \mathbb{R}/\mathbb{Z} . A minimal observer-form encoder for $\tilde{\mathcal{C}}$ stores the previous output $\tilde{c}_{k-1} \in \mathbb{R}/\mathbb{Z}$ and enforces the constraint $\tilde{c}_k = 2\tilde{c}_{k-1} \pmod{\mathbb{Z}}$, which completely determines \tilde{c}_k , as shown in Figure 8.4(c); *i.e.*, there is no nontrivial input, and the state space is \mathbb{R}/\mathbb{Z} . Since the map $\tilde{c}_{k-1} \rightarrow 2\tilde{c}_{k-1} \pmod{\mathbb{Z}}$ is “expansive,” the behavior of $\tilde{\mathcal{C}}$ is not only uncontrollable, but in fact chaotic. \square

Example 7. This code was the main example in [10]. It turns out that our construction method yields a simpler syndrome-former than the general construction given in [10].

Let \mathcal{C} be the set of sequences in $(\mathbb{Z}_4)^{\mathbb{Z}}$ that (a) are either all odd or all even, and (b) have period 1 or 2. In other words, a code sequence is the bi-infinite repetition of one of the 8 pairs

$\{00, 22, 02, 20, 11, 33, 13, 31\}$; therefore $\mathcal{C} \cong \mathbb{Z}_4 \times \mathbb{Z}_2$. The dual is the finite linear code \mathcal{C}^\perp over \mathbb{Z}_4 generated by shifts of $\mathbf{h}_1 = (\dots, 0, 2, 2, 0, \dots)$ and $\mathbf{h}_2 = (\dots, 0, 1, 0, 1, 0, \dots)$.

\mathcal{C} is clearly linear, time-invariant, autonomous and 2-observable. Its first-level observer granules $\Phi_{[k-1,k]}(\mathcal{C})$ check orthogonality to \mathbf{h}_1 ($2c_k = 2c_{k-1}$) and are isomorphic to \mathbb{Z}_2 ; its second-level observer granules $\Phi_{[k-2,k]}(\mathcal{C})$ check orthogonality to \mathbf{h}_2 ($c_k = c_{k-2}$) and are isomorphic to \mathbb{Z}_2 (assuming $\mathbf{c} \in \mathcal{C}^\perp$). Its first-output (input) group is $\{0\}$, and its syndrome group is \mathbb{Z}_4 .

A minimal observer-form encoder for \mathcal{C} may store the previous output $c_{k-1} \in \mathbb{Z}_4$ in the two-bit form $(c_{0,k-1}, c_{1,k-1})$. At the first level, it enforces the constraint $2c_k = 2c_{k-1}$, which determines the low-order bit $c_{0,k}$ of c_k . Given this constraint, it need only store the high-order bit $c_{1,k-1}$ to enforce the second-level constraint $c_{1,k} = c_{1,k-2}$, which determines $c_{1,k}$.

A minimal memory-2 syndrome-former for \mathcal{C} may store the low-order bit $w_{k,0}$ for one time unit and the high-order bit $w_{k,1}$ for two time units, so as to compute the first-level syndrome $s_{0,k} = w_{0,k} - w_{0,k-1}$ and the second-level syndrome $s_{1,k} = w_{1,k} - w_{1,k-2}$, as shown in Figure 8.5(b). The syndrome-former is feedbackfree with memory 2, and is \mathbb{Z}_2 -linear. Again, the encoder may be derived from the syndrome-former simply by forcing the syndromes to 0. \square

IX. THE END-AROUND THEOREM

In this section we show that every observer granule of a group code \mathcal{C} may be viewed purely algebraically as an “end-around” controller granule, and vice versa. As consequences of this observation, we develop:

- A definition of observer granules for nonabelian group codes;
- Simple, purely algebraic alternative proofs of some previous results;
- Myriad further isomorphisms.

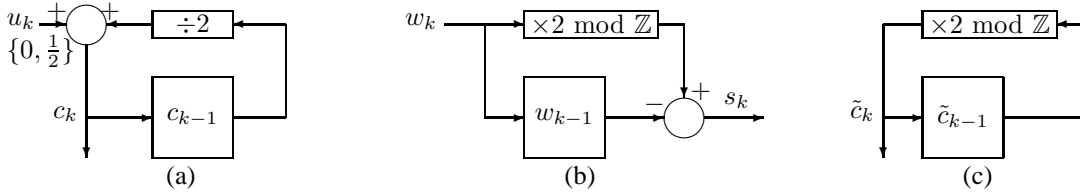

Figure 8.4. Minimal (a) observer-form encoder and (b) syndrome-former for Loeliger's code \mathcal{C} , and (c) minimal observer-form encoder for the chaotic time-reversed code $\tilde{\mathcal{C}}$.

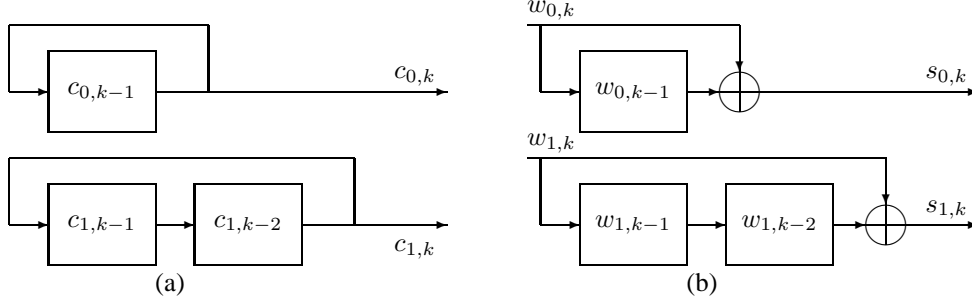

Figure 8.5 Minimal (a) observer-form encoder and (b) syndrome-former for the Fagnani-Zampieri periodic code over \mathbb{Z}_4 [10].

An interval $\mathcal{I} - [m, n]$, $n > m$, may be viewed as an “end-around” interval that “starts” at time n , wraps around from $+\infty$ to $-\infty$, and finally “ends” at time $m-1$. We denote such an interval by $[n, m)$. Similarly, we define $[n, m] = \mathcal{I} - (m, n)$ for $n > m$, an interval which “starts” at time n and “ends” at time $m < n$. If $n = m+1$, then (m, n) is the empty set and $\mathcal{I} - (m, n)$ is the entire time axis \mathcal{I} . Finally, we define $(n, m] = \mathcal{I} - (m, n]$, $n > m$, the end-around interval from time $n+1$ to time m .

We then define an **end-around controller granule** on $[n, m]$, $n > m$, analogously to an ordinary controller granule, as follows:

$$\Gamma_{[n,m]}(\mathcal{C}) = \frac{\mathcal{C}_{:[n,m]}}{\mathcal{C}_{:[n,m]} + \mathcal{C}_{:(n,m)}}, \quad n > m.$$

Then we obtain the following interesting isomorphism:

Theorem 9.1 (end-around theorem): For $n > m$, the end-around controller granule $\Gamma_{[n,m]}(\mathcal{C})$ is isomorphic to the observer granule $\Phi_{[m,n]}(\mathcal{C})$.

Proof. The restrictions of $\mathcal{C}_{:[n,m]}$ and $\mathcal{C}_{:[n,m]} + \mathcal{C}_{:(n,m)}$ onto time n both have kernel $\mathcal{C}_{:(n,m)}$, with images $(\mathcal{C}_{:[n,m]})|_{\{n\}} = F^{n-m-1,n}(\mathcal{C})$ and $(\mathcal{C}_{:[n,m]} + \mathcal{C}_{:(n,m)})|_{\{n\}} = F^{n-m,n}(\mathcal{C})$, respectively, so by the correspondence theorem,

$$\Gamma_{[n,m]}(\mathcal{C}) \cong \frac{F^{n-m-1,n}(\mathcal{C})}{F^{n-m,n}(\mathcal{C})}.$$

By Theorem 7.10, this is isomorphic to $\Phi_{[m,n]}(\mathcal{C})$. \square

We may similarly define an end-around observer granule $\Phi_{[n,m]}(\mathcal{C})$ for $n > m$, and show that it is isomorphic to $\Gamma_{[m,n]}(\mathcal{C})$.

One consequence of the end-around theorem is that all dynamical observer granules may be expressed as end-around controller granules. But controller granules, unlike observer granules, are well-defined for nonabelian group codes. Therefore it is possible to define the dynamical observer granules of a nonabelian code \mathcal{C} by $\Phi_{[m,n]}(\mathcal{C}) = \mathcal{C}_{:[n,m]} / (\mathcal{C}_{:[n,m]} \mathcal{C}_{:(n,m)})$ (in multiplicative notation), which opens the door to extending

our observer dynamics results to nonabelian codes. We regard this as an important topic for further study, especially in view of the successful constructions of [15] and [10] in the nonabelian case.

We now sketch a few applications of the end-around theorem. These involve partitioning the time axis \mathcal{I} into 2, 3, or 4 subintervals, which we then regard as a new finite time axis \mathcal{I}' of length 2, 3, or 4, respectively (as in Subsection VI-B).

The state space theorem involves a two-way partition of \mathcal{I} into disjoint subsets \mathcal{J} and $\mathcal{I} - \mathcal{J}$. We may regard a code \mathcal{C} defined on \mathcal{I} as a code defined on the length-2 time axis $\mathcal{I}' = \{\mathcal{J}, \mathcal{I} - \mathcal{J}\}$, which we identify with the length-2 interval $[1, 2]$.

Now the nondynamical controller granules of \mathcal{C} are $\Gamma_{[1,1]}(\mathcal{C}) = \mathcal{C}_{:\mathcal{J}}$ and $\Gamma_{[2,2]}(\mathcal{C}) = \mathcal{C}_{:\mathcal{I} - \mathcal{J}}$, and the sole dynamical controller granule is the first-level granule $\Gamma_{[1,2]}(\mathcal{C}) = \mathcal{C} / (\mathcal{C}_{:\mathcal{J}} + \mathcal{C}_{:\mathcal{I} - \mathcal{J}})$, which is the two-sided state space $\Sigma_{\mathcal{J}}(\mathcal{C})$. The nondynamical observer granules of \mathcal{C} are $\Phi_{[1,1]}(\mathcal{C}) = \mathcal{W}_{|\mathcal{J}} / \mathcal{C}_{|\mathcal{J}}$ and $\Phi_{[2,2]}(\mathcal{C}) = \mathcal{W}_{|\mathcal{I} - \mathcal{J}} / \mathcal{C}_{|\mathcal{I} - \mathcal{J}}$, and the sole dynamical observer granule is the first-level granule $\Phi_{[1,2]}(\mathcal{C}) = (\mathcal{C}_{|\mathcal{J}} + \mathcal{C}_{|\mathcal{I} - \mathcal{J}}) / \mathcal{C}$, which we recognize as the two-sided reciprocal state space $\Sigma^{\mathcal{J}}(\mathcal{C})$. The end-around controller granule $\Gamma_{[2,1]}(\mathcal{C})$ is $\mathcal{C} / (\mathcal{C}_{:\mathcal{J}} + \mathcal{C}_{:\mathcal{I} - \mathcal{J}}) = \Sigma_{\mathcal{J}}(\mathcal{C})$. The end-around theorem therefore implies $\Sigma_{\mathcal{J}}(\mathcal{C}) \cong \Sigma^{\mathcal{J}}(\mathcal{C})$, an important isomorphism that we derived previously as a corollary of the reciprocal state space theorem, as well as purely algebraically.

The $[m, n]$ -controllability and $[m, n]$ -observability tests involve a three-way partition of \mathcal{I} into disjoint subsets m^- , $[m, n]$, and n^+ . We may regard a code \mathcal{C} defined on \mathcal{I} as a code defined on the length-3 time axis $\mathcal{I}' = \{m^-, [m, n], n^+\}$, which we identify with the length-3 interval $[1, 3]$.

Now by the first $[m, n]$ -observability test, \mathcal{C} is $[m, n]$ -observable if and only if \mathcal{C} is 1-observable on \mathcal{I}' ; *i.e.*, if and only if the second-level observer granule $\Phi_{[1,3]}(\mathcal{C}) = \mathcal{C}^1 / \mathcal{C}^2$ is trivial, where $\mathcal{C}^2 = \mathcal{C}$ and

$$\mathcal{C}^1 = \{\mathbf{w} \in \mathcal{W} \mid \mathbf{w}_{|[1,2]} \in \mathcal{C}_{|[1,2]}, \mathbf{w}_{|[2,3]} \in \mathcal{C}_{|[2,3]}\}.$$

By the end-around theorem,

$$\Phi_{[1,3]}(\mathcal{C}) \cong \Gamma_{[3,1]}(\mathcal{C}) = \frac{\mathcal{C}_{:[3,1]}}{\mathcal{C}_{:\{3\}} + \mathcal{C}_{:\{1\}}} = \frac{\mathcal{C}_{:[n,m]}}{\mathcal{C}_{:n^+} \times \mathcal{C}_{:m^-}},$$

so \mathcal{C} is $[m, n]$ -observable if and only if $\mathcal{C}_{:[n,m]} = \mathcal{C}_{:n^+} \times \mathcal{C}_{:m^-}$. Thus the first $[m, n]$ -observability test is equivalent to the second by the end-around theorem.

Similarly, by our second $[m, n]$ -controllability test, \mathcal{C} is $[m, n]$ -controllable if and only if \mathcal{C} is 1-controllable on \mathcal{I}' ; i.e., if and only if the second-level controller granule

$$\Gamma_{[1,3]}(\mathcal{C}) = \frac{\mathcal{C}}{\mathcal{C}_{:[1,2]} + \mathcal{C}_{:[2,3]}}$$

is trivial. By the dual to the end-around theorem, $\Gamma_{[1,3]}(\mathcal{C})$ is isomorphic to the end-around observer granule

$$\Phi_{[3,1]}(\mathcal{C}) = \frac{\mathcal{C}_{\{3\}} \times \mathcal{C}_{\{1\}}}{\mathcal{C}_{[3,1]}} = \frac{\mathcal{C}_{|n^+} \times \mathcal{C}_{|m^-}}{\mathcal{C}_{|[n,m]}},$$

so \mathcal{C} is $[m, n]$ -controllable if and only if $\mathcal{C}_{|[n,m]} = \mathcal{C}_{|n^+} \times \mathcal{C}_{|m^-}$. Thus the first $[m, n]$ -controllability test is equivalent to the second by the dual end-around theorem.

Projections of these quotients onto the subintervals m^- , $[m, n]$, and n^+ yield still further tests in terms of trivial quotients of primal and dual first-output and last-output chains, which are cumbersome to write but which have the advantage of being testable on a single interval. Even on a time axis of length 3, there are a great many isomorphisms that can be derived from the general granule isomorphisms, since the system dynamical structure is determined by only three dynamical controller granules Γ_{12}, Γ_{23} and Γ_{123} and three dynamical observer granules Φ_{12}, Φ_{23} and Φ_{123} (or equivalently three end-around controller granules $\Gamma_{231}, \Gamma_{312}$ and Γ_{31}).

A set of such isomorphisms is illustrated in Figure 9.1. Moreover, every permutation of the three indices $\{1, 2, 3\}$ yields a similar set of further isomorphisms. Here $\mathcal{C}_{:1} \times \mathcal{C}_{:2} \times \mathcal{C}_{:3}$ is the 0-controllable subcode of \mathcal{C} , and $\mathcal{C}_{:12} + \mathcal{C}_{:23}$ is the 1-controllable subcode of \mathcal{C} . The figure shows how $\mathcal{C}/(\mathcal{C}_{:1} \times \mathcal{C}_{:2} \times \mathcal{C}_{:3})$ decomposes into the controllability granules Γ_{12}, Γ_{23} and $\Gamma_{123} \cong \Phi_{31}$. Similarly, $\mathcal{C}_{|1} \times \mathcal{C}_{|2} \times \mathcal{C}_{|3}$ is the 0-observable supercode of \mathcal{C} , $(\mathcal{C}_{|12} \times \mathcal{C}_{|3}) \cap (\mathcal{C}_{|1} \times \mathcal{C}_{|23})$ is the 1-observable supercode of \mathcal{C} , and the figure shows how $(\mathcal{C}_{|1} \times \mathcal{C}_{|2} \times \mathcal{C}_{|3})/\mathcal{C}$ decomposes into the observability granules Φ_{12}, Φ_{23} and $\Phi_{123} \cong \Gamma_{31}$. The diagram is self-dual.

Finally, our j th dual first-output and last-output group results for $j \geq 1$ involve a four-way partition of \mathcal{I} into disjoint subsets $\{k-j\}, (k-j, k), \{k\}, (k, k-j)$, which we regard as a length-4 time axis \mathcal{I}' and identify with the length-4 interval $[1, 4]$.

In this point of view, the dual first-output group $F^{j,k}(\mathcal{C})$ is the set of time-2 symbols in the subcode $\mathcal{C}_{:[3,4]}$ that “starts” at time k and “ends” at time $k-j-1$,

$$F^{j,k}(\mathcal{C}) = (\mathcal{C}_{:[3,4]})_{\{3\}},$$

while $F^{j-1,k}(\mathcal{C})$ is the set of time-2 symbols in the subcode $\mathcal{C}_{:[3,1]}$ that “starts” at time k and “ends” at time $k-j$:

$$F^{j-1,k}(\mathcal{C}) = (\mathcal{C}_{:[3,1]})_{\{3\}}.$$

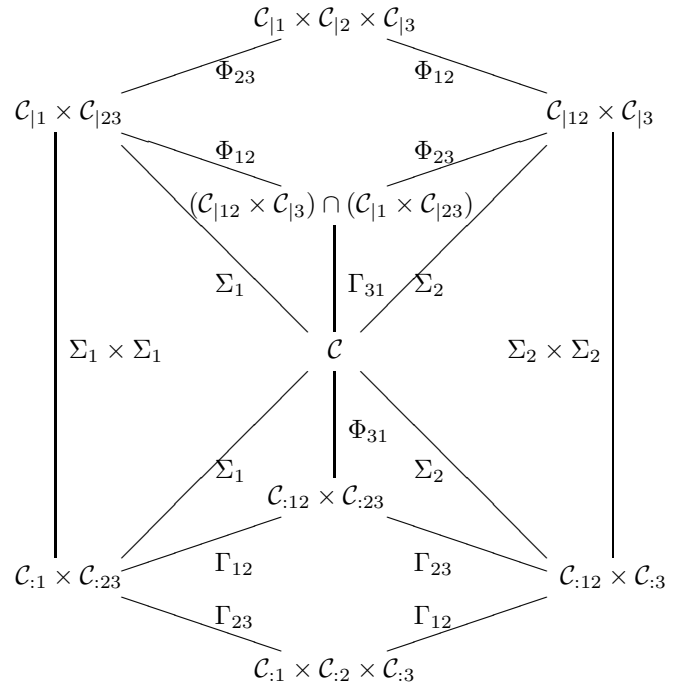

Figure 9.1. Granule isomorphisms on a length-3 time axis.

Since the end-around controller granule $\Gamma_{[3,1]}(\mathcal{C})$ is $\mathcal{C}_{:[3,1]}/(\mathcal{C}_{:[3,4]} + \mathcal{C}_{:[4,1]})$, we have by projection onto time 2 and the end-around theorem

$$\frac{F^{j-1,k}(\mathcal{C})}{F^{j,k}(\mathcal{C})} \cong \Gamma_{[3,1]}(\mathcal{C}) \cong \Phi_{[1,3]}(\mathcal{C}),$$

where $\Phi_{[1,3]}(\mathcal{C})$ denotes the observer granule $\Phi_{[k-j,k]}(\mathcal{C})$. The isomorphism $L^{j-1,k}(\mathcal{C})/L^{j,k}(\mathcal{C}) \cong \Phi_{[k,k+j]}(\mathcal{C})$ may be derived similarly.

X. CONCLUSION

In this paper we have extended the duality principles that have proved to be so useful in coding and system theory to abelian group codes. We have introduced a bit of topology in order to make use of Pontryagin duality, but topology is not used in any essential way other than to clarify duality principles when the time axis is infinite. We have also introduced a few technical “well-behavedness” conditions, principally the closed-projections assumption. Since this assumption holds when symbol groups are compact, or *a fortiori* finite, we do not believe that it will prove to be restrictive in practical applications.

We have generalized the dual state space theorem of linear system theory, which shows in a precise sense that the state complexity of dual codes or systems is dual in the character group sense. We have also shown that there are well-defined dual notions of controllability and observability for codes and behaviors, rather than for state-space realizations of codes and behaviors as in classical and behavioral linear system theory. Finally, we have shown close connections between controllability and finite generatability, on the one hand, and observability and finite checkability (completeness), on the other.

It is helpful to keep in mind both the controllability and observability properties of a code or system. An uncontrollable (resp. unobservable) system may have simple observability (resp. controllability) properties, as shown in Example 4. A “low-rate” code or system is usually more simply specified in controller form (e.g., by a generator matrix, encoder or image representation), whereas a “high-rate” code or system is usually more simply specified in observer form (e.g., by a parity-check matrix, syndrome-former or kernel representation). Controller memory and observer memory are both important parameters of a system.

It can also be helpful to characterize a code or system by its dual. For example, a complete compact code or system can be characterized by its finite discrete dual, whose properties are purely algebraic. Pathologies in the primal system will be reflected in pathologies in the dual system, but their nature will usually be quite different (e.g., in Examples 2 and 4).

It appears to us that behavioral system theory and symbolic dynamics have focussed largely on observability structure. Systems are usually assumed to be complete and compact, and “memory” usually means observer memory (see, e.g., [19]). In automata theory, on the other hand, languages are usually sets of discrete and finitely supported sequences. We believe that each of these fields might benefit from a more balanced viewpoint.

There are several clues in this work, as well as in [15] and [10], that the abelian assumption is inessential. It is not needed for the purely algebraic controllability structure discussed in [15], nor for the more difficult observer-form constructions of [10]. The key idea of [10] may be the recognition that even when a subgroup H (such as a code) is not normal in a group G (such as its output sequence space), the set $G//H$ of left cosets of H in G is nonetheless a tractable group-theoretic object upon which G acts naturally by translation. Moreover, in this paper we have shown that all observer granules are isomorphic to “end-around” controller granules, which remain well-defined in the nonabelian case. It may well be useful therefore to develop an alternative purely algebraic general theory of observability structure that will apply equally to abelian and nonabelian group codes.

ACKNOWLEDGMENTS

This paper has benefited from the comments of many colleagues over its lengthy development. We would like to acknowledge particularly Thomas Ericson, Fabio Fagnani, Andi Loeliger, Brian Marcus, Thomas Mittelholzer, Sanjoy Mitter, Joachim Rosenthal, Maria Elena Valcher, Jan Willems and Sandro Zampieri. We are also grateful to the Associate Editor and referees for four excellent reviews. We are particularly indebted to Thomas Mittelholzer for helpful suggestions and references with regard to the issues of “closed projections” and “completeness,” and to Fabio Fagnani for correction of mathematical errors.

REFERENCES

[1] H. Andersson and H.-A. Loeliger, “Codes from iterated maps,” *Proc. 1995 IEEE Intl. Symp. Inform. Theory* (Whistler, BC), p. 309, Sept. 1995.

[2] R. Devaney, *An Introduction to Chaotic Dynamical Systems*. Reading, MA: Addison-Wesley, 1987.

[3] M. Enock and J.-M. Schwartz, *Kac Algebras and Duality of Locally Compact Groups*. New York: Springer-Verlag, 1992.

[4] F. Fagnani, “Controllability and observability indices for linear time-invariant systems: A new approach,” *Syst. Contr. Lett.*, vol. 17, pp. 243–250, 1991.

[5] F. Fagnani, “Some results on the classification of expansive automorphisms of compact Abelian groups,” *Ergod. Theory Dyn. Syst.*, vol. 16, pp. 45–50, 1996.

[6] F. Fagnani, “Shifts on compact and discrete Lie groups: Algebraic-topological invariants and classification problems,” *Adv. Math.*, vol. 127, pp. 283–306, 1997.

[7] F. Fagnani and J. C. Willems, “Controllability of l_2 systems,” *SIAM J. Contr. Opt.*, vol. 30, pp. 1101–1125, 1992.

[8] F. Fagnani and S. Zampieri, “Dynamical systems and convolutional codes over finite Abelian groups,” *IEEE Trans. Inform. Theory*, vol. 42, pp. 1892–1912, Nov. 1996.

[9] F. Fagnani and S. Zampieri, “Classification problems for shifts on modules over a principal ideal domain,” *Trans. AMS*, vol. 349, pp. 1993–2006, 1997.

[10] F. Fagnani and S. Zampieri, “Minimal syndrome formers for group codes,” *IEEE Trans. Inform. Theory*, vol. 45, pp. 3–31, Jan. 1999.

[11] E. Fornasini and M. E. Valcher, “Algebraic aspects of 2D convolutional codes,” *IEEE Trans. Inform. Theory*, vol. 40, pp. 1068–1082, 1994.

[12] E. Fornasini and M. E. Valcher, “Multidimensional systems with finite support behaviors: Signal structure, generation and detection,” *SIAM J. Contr. Opt.*, vol. 36, pp. 760–779, 1998.

[13] G. D. Forney, Jr., “Structural analysis of convolutional codes via dual codes,” *IEEE Trans. Inform. Theory*, vol. IT-19, pp. 512–518, 1973.

[14] G. D. Forney, Jr., “Codes on graphs: Normal realizations,” *IEEE Trans. Inform. Theory*, vol. 47, pp. 520–548, Feb. 2001.

[15] G. D. Forney, Jr. and M. D. Trott, “The dynamics of group codes: State spaces, trellis diagrams and canonical encoders,” *IEEE Trans. Inform. Theory*, vol. 39, pp. 1491–1513, Sept. 1993.

[16] G. D. Forney, Jr. and M. D. Trott, “The dynamics of group codes: Syndromes, normal codes and observers,” *Proc. 1993 Intl. Symp. Inform. Theory* (San Antonio, TX), p. 177, Jan. 1993.

[17] G. D. Forney, Jr. and M. D. Trott, “Duals of abelian group codes and systems,” *Proc. IEEE Workshop on Coding, System Theory and Symbolic Dynamics* (Mansfield, MA), pp. 36–38, Oct. 1993.

[18] G. D. Forney, Jr. and M. D. Trott, “Controllability, observability and duality in behavioral group systems,” *Proc. 34th Conf. Dec. Contr.* (New Orleans, LA), vol. 3, pp. 3259–3264, Dec. 1995.

[19] G. D. Forney, Jr., B. Marcus, N. T. Sindhushayana and M. D. Trott, “Multilingual dictionary: System theory, coding theory, symbolic dynamics and automata theory,” *Proc. Symp. Appl. Math.*, vol. 50, pp. 109–137, 1995.

[20] E. Hewitt and K. A. Ross, *Abstract Harmonic Analysis I* (second ed.). New York: Springer-Verlag, 1979.

[21] T. Kailath, *Linear Systems*. Englewood Cliffs, NJ: Prentice-Hall, 1980.

[22] S. Kaplan, “Extension of the Pontrjagin duality I: Infinite products,” *Duke Math. J.*, vol. 15, pp. 649–658, 1948.

[23] B. Kitchens, “Expansive dynamics on zero-dimensional groups,” *Ergod. Theory Dyn. Syst.*, vol. 7, pp. 249–261, 1987.

[24] B. Kitchens and K. Schmidt, “Automorphisms of compact groups,” *Ergod. Theory Dyn. Syst.*, vol. 9, pp. 691–735, 1989.

[25] A. N. Kolmogorov and S. V. Fomin, *Introductory Real Analysis* (R. A. Silverman, trans./ed.). New York: Dover, 1970.

[26] D. Lind and B. Marcus, *Symbolic Dynamics and Coding*. Cambridge, UK: Cambridge U. Press, 1995.

[27] H.-A. Loeliger, “Abelian-group convolutional codes need not be ring codes,” *Proc. 6th Joint Swedish-Russian Intl. Wkshp. Inform. Theory* (Mölle, Sweden), pp. 21–22, Aug. 1993.

[28] H.-A. Loeliger, G. D. Forney, Jr., T. Mittelholzer and M. D. Trott, “Minimality and observability of group systems,” *Linear Alg. Appl.*, vol. 205–206, pp. 937–963, July 1994.

[29] H.-A. Loeliger and T. Mittelholzer, “Convolutional codes over groups,” *IEEE Trans. Inform. Theory*, vol. 42, pp. 1660–1686, Nov. 1996.

[30] G. Miles and R. K. Thomas, “The breakdown of automorphisms of compact topological groups,” in *Studies in Probability and Ergodic Theory* (Adv. Math. Suppl. Stud.), vol. 2, pp. 207–218. Academic Press, 1978.

[31] H. Narayanan, *Submodular Functions and Electrical Networks* (Ann. Discr. Math. **54**), Chaps. 7–8. Amsterdam: North Holland, 1997.

- [32] H. Narayanan, "Matroids representable over modules, electrical network topology and behavioural systems theory," research report, EE Dept., IIT-Bombay, May 2000.
- [33] H. Narayanan, "On the duality between controllability and observability in behavioural systems theory," *Proc. CCSP 2000*, Bangalore, pp. 183–186, July 2000.
- [34] N. Noble, " k -groups and duality," *Trans. AMS*, vol. 151, pp. 551–561, Oct. 1970.
- [35] L. Pontryagin, *Topological Groups*. Princeton, NJ: Princeton U. Press, 1946.
- [36] P. Rocha and J. C. Willems, "Controllability of 2D systems," *IEEE Trans. Automat. Contr.*, vol. 36, pp. 413–423, 1991.
- [37] J. Rosenthal, J. M. Schumacher and E. V. York, "On behaviors and convolutional codes," *IEEE Trans. Inform. Theory*, vol. 42, pp. 1881–1891, 1996.
- [38] J. J. Rotman, *An Introduction to the Theory of Groups*. Dubuque, IA: Wm. C. Brown, 1988.
- [39] W. Rudin, *Fourier Analysis on Groups*. New York: Wiley, 1990.
- [40] H. Schubert, *Topology* (S. Moran, trans.). Boston: Allyn and Bacon, 1968.
- [41] K. Schmidt, "Automorphisms of compact abelian groups and affine varieties," *Proc. London Math. Soc.*, vol. 61, pp. 480–496, 1990.
- [42] H. Trentelman, "A truly behavioral approach to the H_∞ control problem," in *The Mathematics of Systems and Control: From Intelligent Control to Behavioral Systems* (J. W. Polderman and H. Trentelman, eds.), pp. 177–190. Groningen, The Netherlands: U. Groningen Press, 1999.
- [43] M. D. Trott, "The algebraic structure of trellis codes," Ph.D. dissertation, Dept. Elec. Engg., Stanford U., Stanford, CA, Aug. 1992.
- [44] M. E. Valcher and E. Fornasini, "On 2D finite-support convolutional codes: An algebraic approach," *Multid. Syst. Sig. Proc.*, vol. 5, pp. 231–243, 1994.
- [45] R. Venkataraman, "A characterization of Pontryagin duality," *Math. Z.*, vol. 149, pp. 109–119, 1976.
- [46] J. C. Willems, "From time series to linear systems, Parts I–III," *Automatica*, vol. 22, pp. 561–580 and 675–694, 1986; vol. 23, pp. 87–115, 1987.
- [47] J. C. Willems, "Models for dynamics," *Dynamics Reported*, vol. 2, pp. 171–269, 1989.
- [48] J. C. Willems, "Paradigms and puzzles in the theory of dynamical systems," *IEEE Trans. Automat. Contr.*, vol. 36, pp. 259–294, Mar. 1991.
- [49] J. C. Willems, "On interconnections, control and feedback," *IEEE Trans. Automat. Contr.*, vol. 42, pp. 326–339, Mar. 1997.
- [50] S. Zampieri and S. Mitter, "Linear systems over Noetherian rings in the behavioral approach," *J. Math. Syst. Estim. Contr.*, vol. 6, pp. 235–238, 1996.
- G. David Forney, Jr.** (S'59–M'61–F'73) received the B.S.E. degree in electrical engineering from Princeton University, Princeton, NJ, in 1961, and the M.S. and Sc.D. degrees in electrical engineering from the Massachusetts Institute of Technology (MIT), Cambridge, in 1963 and 1965, respectively. From 1965 to 1999 he was with the Codex Corporation, which was acquired by Motorola, Inc. in 1977, and its successor, the Motorola Information Systems Group, Mansfield, MA. Since 1996, he has been Bernard M. Gordon Adjunct Professor at M.I.T.
- Dr. Forney was Editor-in-Chief of the IEEE TRANSACTIONS ON INFORMATION THEORY from 1970 to 1973. He has been a member of the Board of Governors of the IEEE Information Theory Society during 1970–76, 1986–94, and 2004–, and was President in 1992. He has been awarded the 1970 IEEE Information Theory Group Prize Paper Award, the 1972 IEEE Browder J. Thompson Memorial Prize Paper Award, the 1990 IEEE Donald G. Fink Prize Paper Award, the 1992 IEEE Edison Medal, the 1995 IEEE Information Theory Society Claude E. Shannon Award, the 1996 Christopher Columbus International Communications Award, and the 1997 Marconi International Fellowship. In 1998 he received an IT Golden Jubilee Award for Technological Innovation, and two IT Golden Jubilee Paper Awards. He was elected a Fellow of the IEEE in 1973, a member of the National Academy of Engineering (USA) in 1983, a Fellow of the American Association for the Advancement of Science in 1993, an honorary member of the Popov Society (Russia) in 1994, a Fellow of the American Academy of Arts and Sciences in 1998, and a member of the National Academy of Sciences (USA) in 2003.
- Mitchell D. Trott** (S'90–M'92) received the B.S. and M.S. degrees in systems engineering from Case Western Reserve University, Cleveland, OH, in 1987 and 1988, respectively, and the Ph.D. degree in electrical engineering from Stanford University, Stanford, CA, in 1992.
- He was an Associate Professor in the Department of Electrical Engineering and Computer Science at the Massachusetts Institute of Technology, Cambridge, MA, from 1992 until 1998, and Director of Research at ArrayComm, Inc., San Jose, CA, from 1997 through 2002. He now leads the Streaming Media Technologies group at Hewlett-Packard Laboratories, Palo Alto, CA.
- His research interests include streaming media systems, multi-user and wireless communications, and information theory.