

A Survey on Inference Optimization Techniques for Mixture of Experts Models

JIACHENG LIU*, Chinese University of Hong Kong, China

PENG TANG*, Shanghai Jiao Tong Universtiy, China

WENFENG WANG, Shanghai Jiao Tong Universtiy, China

YUHANG REN, Shanghai Jiao Tong Universtiy, China

XIAOFENG HOU†, Shanghai Jiao Tong Universtiy, China

PHENG-ANN HENG, Chinese University of Hong Kong, China

MINYI GUO, Shanghai Jiao Tong Universtiy, China

CHAO LI†, Shanghai Jiao Tong Universtiy, China

The emergence of large-scale Mixture of Experts (MoE) models has marked a significant advancement in artificial intelligence, offering enhanced model capacity and computational efficiency through conditional computation. However, the deployment and inference of these models present substantial challenges in terms of computational resources, latency, and energy efficiency. This comprehensive survey systematically analyzes the current landscape of inference optimization techniques for MoE models across the entire system stack. We first establish a taxonomical framework that categorizes optimization approaches into model-level, system-level, and hardware-level optimizations. At the model level, we examine architectural innovations including efficient expert design, attention mechanisms, various compression techniques such as pruning, quantization, and knowledge distillation, as well as algorithm improvement including dynamic routing strategies and expert merging methods. At the system level, we investigate distributed computing approaches, load balancing mechanisms, and efficient scheduling algorithms that enable scalable deployment. Furthermore, we delve into hardware-specific optimizations and co-design strategies that maximize throughput and energy efficiency. This survey not only provides a structured overview of existing solutions but also identifies key challenges and promising research directions in MoE inference optimization. Our comprehensive analysis serves as a valuable resource for researchers and practitioners working on large-scale deployment of MoE models in resource-constrained environments. To facilitate ongoing updates and the sharing of cutting-edge advances in MoE inference optimization research, we have established a repository accessible at <https://github.com/MoE-Inf/awesome-moe-inference/>.

ACM Reference Format:

Jiacheng Liu, Peng Tang, Wenfeng Wang, Yuhang Ren, Xiaofeng Hou, Pheng-Ann Heng, Minyi Guo, and Chao Li. 2018. A Survey on Inference Optimization Techniques for Mixture of Experts Models. In *Proceedings of Make sure to enter the correct conference title from your rights confirmation emai (Conference acronym 'XX)*. ACM, New York, NY, USA, 27 pages. <https://doi.org/XXXXXXX.XXXXXXX>

*Both authors contributed equally to this research.

†Corresponding authors.

Authors' Contact Information: Jiacheng Liu, jcliu@cse.cuhk.edu.hk, Chinese University of Hong Kong, Hong Kong, China; Peng Tang, Shanghai Jiao Tong Universtiy, Shanghai, China; Wenfeng Wang, Shanghai Jiao Tong Universtiy, Shanghai, China; Yuhang Ren, Shanghai Jiao Tong Universtiy, Shanghai, China; Xiaofeng Hou, Shanghai Jiao Tong Universtiy, Shanghai, China; Pheng-Ann Heng, Chinese University of Hong Kong, Hong Kong, China; Minyi Guo, Shanghai Jiao Tong Universtiy, Shanghai, China; Chao Li, Shanghai Jiao Tong Universtiy, Shanghai, China.

Permission to make digital or hard copies of all or part of this work for personal or classroom use is granted without fee provided that copies are not made or distributed for profit or commercial advantage and that copies bear this notice and the full citation on the first page. Copyrights for components of this work owned by others than the author(s) must be honored. Abstracting with credit is permitted. To copy otherwise, or republish, to post on servers or to redistribute to lists, requires prior specific permission and/or a fee. Request permissions from permissions@acm.org.

© 2018 Copyright held by the owner/author(s). Publication rights licensed to ACM.

Manuscript submitted to ACM

Manuscript submitted to ACM

1 Introduction

Large language models (LLMs) have revolutionized artificial intelligence, demonstrating unprecedented capabilities across various domains including natural language processing [20, 115, 157], computer vision [31, 33, 194], and multimodal tasks [86, 123, 162]. Models like GPT-4 [2], Claude [8], and Gemini [151] have achieved remarkable performance in tasks ranging from natural language understanding to complex reasoning and code generation. The impressive capabilities of these models are largely attributed to their massive scale, both in terms of model parameters and computational resources invested in training. This scaling trend is supported by empirical evidence showing consistent improvements in model performance with increased size, as demonstrated by various scaling laws in language modeling and other domains [5, 19, 74]. However, this trajectory presents significant challenges in terms of computational efficiency and resource utilization, particularly during inference, where real-world deployment constraints become critical [10, 173, 187, 199].

Mixture of Experts (MoE) has emerged as a promising architectural solution to address scaling challenges in machine learning [137]. Originally introduced by Jacobs et al. [68] in the early 1990s as a method for learning subtasks in neural networks, Numerous MoE-based models [37, 53, 155] have been developed over the years. In the era of large language models, MoE has again experienced a renaissance [1, 29, 70, 148]. The core principle of MoE is to distribute the model’s capacity across multiple specialized sub-networks, or experts, with a learned gating mechanism that selectively activates only the relevant experts for each input. This approach allows models to maintain a large parameter count while keeping computational costs manageable through sparse activation. Recent implementations, such as Mixtral 8x7B [70], Switch Transformers [42] and GShard [82], have demonstrated the effectiveness of this strategy in scaling language models to trillions of parameters while maintaining reasonable computational requirements.

The success of MoE in scaling models has led to its adoption in various state-of-the-art systems. For example, Google’s GLaM [35] outperforms GPT-3 while using significantly fewer computational resources during inference. Similarly, Mixtral 8x7B [70], a recent open-source MoE model, has demonstrated competitive performance compared to much larger dense models, while maintaining efficient inference characteristics. Table 1 summarizes recent state-of-the-art open-source MoE models that have garnered significant attention, further highlighting the strong potential of the MoE architecture. These successes have sparked widespread interest in MoE across both academia and industry, leading to innovations in model design [22, 164, 192], training techniques [34, 47, 101], and deployment strategies [15, 16, 183].

However, the efficient deployment of MoE models for inference presents unique and significant challenges [65, 150, 181, 196]. The dynamic nature of expert activation patterns introduces complexity in resource management and scheduling that is not present in traditional dense models. These challenges span multiple levels: at the model level, the design of efficient expert architectures and routing mechanisms directly impacts inference performance; at the system level, managing distributed computation and load balancing becomes increasingly complex; and at the hardware level, specialized acceleration techniques are needed to handle the sparse computation patterns.

Numerous methods have been developed to address these challenges in MoE deployment and inference [72, 125, 133, 170]. While the rapid growth of research in this field demonstrates its importance, it can also make it difficult to identify key trends and best practices. A critical gap in existing literature is the absence of a systematic framework for analyzing and developing comprehensive inference optimization solutions for MoE models.

To bridge this gap, our work offers a comprehensive survey of inference optimization techniques for MoE models. We propose a taxonomical framework that categorizes optimization approaches into model-level, system-level, and hardware-level optimizations, as illustrated in Figure 1. This framework provides a structured approach to understanding

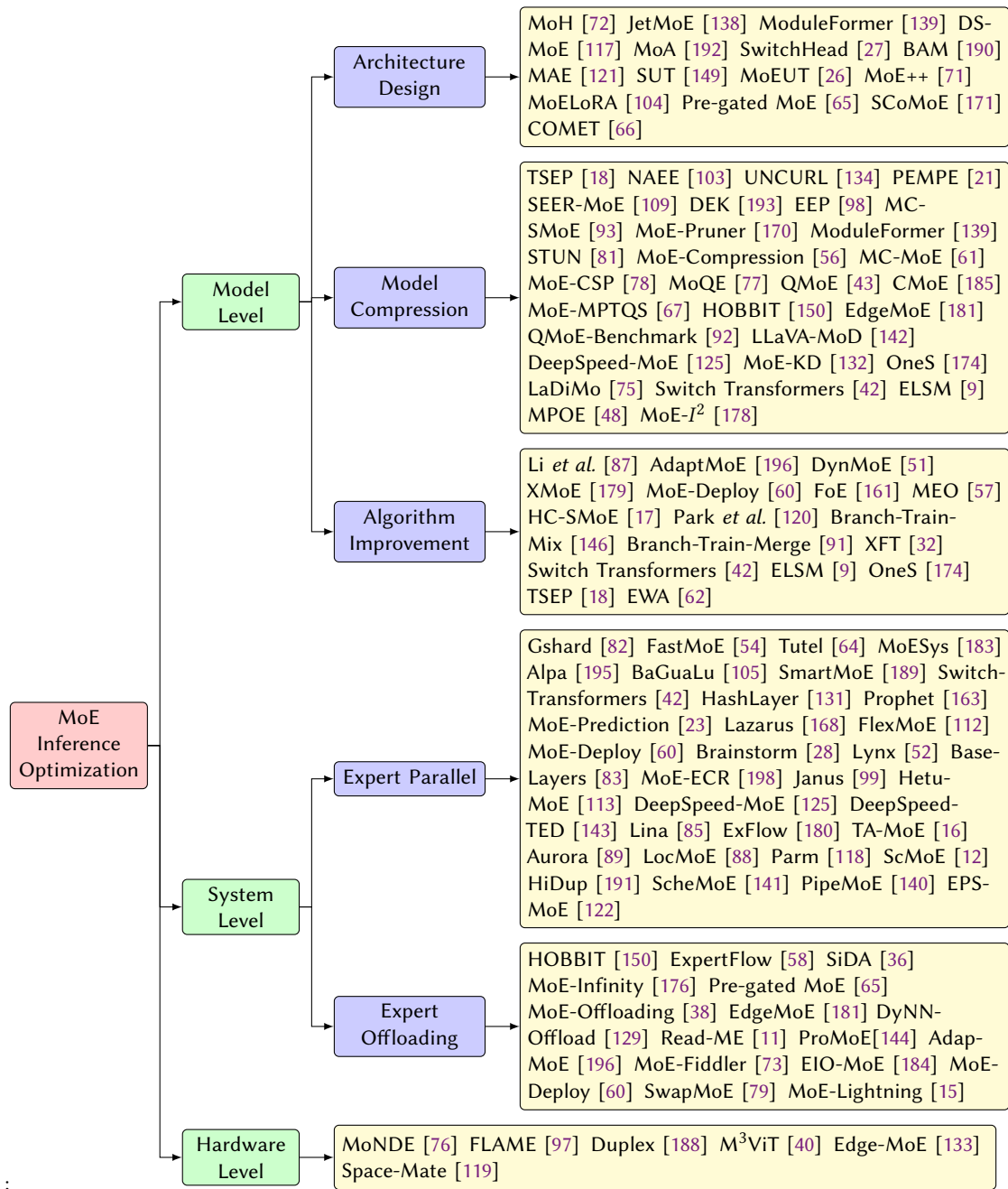

Fig. 1. Taxonomy of MoE inference optimization literature.

and comparing different optimization techniques. While there are related surveys on LLM efficiency [10, 84, 90, 156, 159, 173, 187, 199] and MoE architectures [13, 41, 158], our work is the first to specifically focus on inference optimization

Reference	Para.	Experts	#L	#H	d_{model}	d_{ffn}	d_{expert}	Affiliation	Time
NLLB [24]	54B	2/64/0	24	16	1024	8192	8192	FaceBook	2022.07
Qwen2-57B-A14B [177]	57.4B	8/64/0	28	28	3584	18944	2560	Alibaba	2023.05
Mixtral-8x7B [70]	46.7B	2/8/0	32	32	4096	14336	14336	Mistral AI	2023.12
OpenMoE [175]	34B	2/16/0	12	12	768	2048	2048	NUS et al.	2023.12
DeepSeekMoE [29]	16.4B	6/64/2	28	16	2048	10944	1408	DeepSeek-AI	2024.01
Qwen1.5-MoE [153]	14.3B	4/60/0	24	16	2048	5632	1408	Alibaba	2024.02
JetMoE [138]	8.52B	2/8/0	24	32	2048	5632	5632	MIT et al.	2024.03
Jamba [96]	51.6B	2/16/0	32	32	4096	14336	14336	ai21labs	2024.03
DBRX [154]	132B	4/16/0	40	48	6144	10752	10752	Databricks	2024.03
Grok-1 [169]	314B	2/8/0	64	48	6144	UNK	UNK	xAI	2024.03
Arctic [130]	482B	2/128/0	35	56	7168	4864	4864	Snowflake	2024.04
Mixtral-8x22B [70]	141B	2/8/0	56	48	6144	16384	16384	Mistral AI	2024.04
DeepSeek-V2 [30]	236B	6/160/2	60	128	5120	12288	1536	DeepSeek-AI	2024.04
Skywork-MoE [166]	13B	2/16/0	52	36	4608	12288	12288	Kunlun Tech	2024.05
Yuan2 [167]	40B	2/32/0	24	16	2048	8192	8192	IEIT-Yuan	2024.05
LLaMA-MoE [201]	6.7B	2/8/0	32	32	4096	11008	11008	Zhu et al.	2024.06
OLMo [108]	6.92B	8/64/0	16	16	2048	1024	1024	AllenAI	2024.07
Phi-3 [1]	41.9B	2/16/0	32	32	4096	6400	6400	MicroSoft	2024.08
GRIN-MoE [100]	41.9B	2/16/0	32	32	4096	6400	6400	MicroSoft	2024.09
Hunyuan-Large [148]	389B	1/16/1	64	80	6400	18304	18304	Tencent	2024.11

Table 1. A List of SOTA MoEs. Attribute Param. represents the number of total parameters. Experts according to the format of number of Activation Experts/Total Experts/Shared Experts. #L represents the number of hidden layers, #H represents the number of attention heads. d_{model} is the hidden size, d_{ffn} is the intermediate size of FFNs, d_{expert} is the intermediate size of FFN experts.

techniques for MoE models. We systematically analyze optimization approaches at different abstraction levels, from model architecture to hardware acceleration, providing a valuable resource for researchers and practitioners working deploy MoE models for different real-world applications.

The remainder of this survey is organized as follows: Section 2 provides background on MoE models and their inference characteristics. Sections 3-5 detail optimization techniques at the model, system, and hardware levels respectively. Section 6 discusses future challenges and opportunities, and Section 7 concludes the survey.

2 Fundamentals of Mixture of Experts

Mixture of Experts (MoE) represents a significant architectural paradigm in neural networks, particularly in large language models, where it enables conditional computation through sparse activation mechanisms [13]. At its core, an MoE architecture consists of a routing network $R(x)$ and a set of expert networks E_1, E_2, \dots, E_N , where N denotes the total number of experts. The fundamental principle of MoE can be expressed as $y = \sum_{i=1}^N g_i(x) \cdot E_i(x)$, where $g_i(x)$ represents the gating function for expert i , and $E_i(x)$ is the output of expert i .

As illustrated in Figure 2, existing studies typically use the MoE module to replace part of the traditional dense layer, thereby forming a sparse MoE layer. While most research focuses on substituting the FFN module with the MoE module [1, 30, 70, 71, 153], some have also explored replacing the Attention module [72, 138, 139, 192].

In the inference process of a sparse MoE model, computation follows a three-stage pipeline. First, the router computes expert selection probabilities:

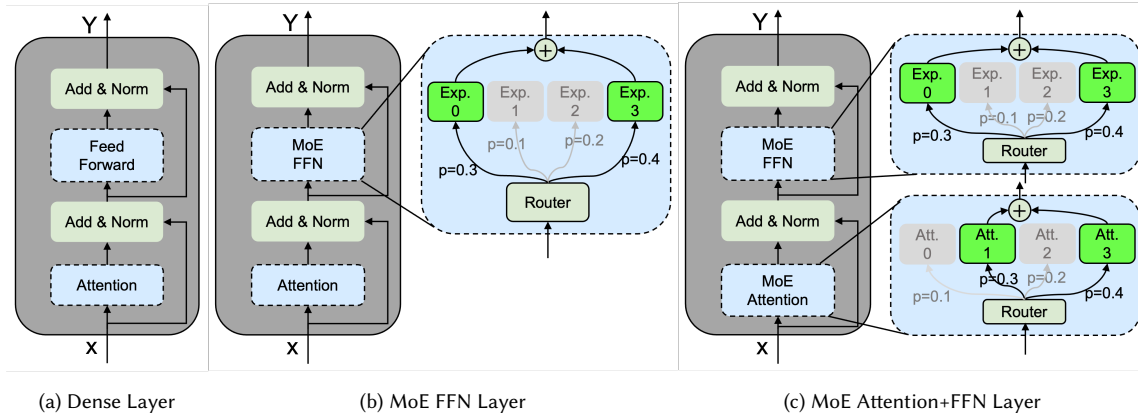

Fig. 2. Architectural comparison of dense layer with MoE layers: (a) conventional dense transformer layer, (b) transformer layer with MoE-based feed-forward network, and (c) transformer layer with both MoE-based attention and feed-forward networks.

$$\theta = \text{Softmax}(R(x)) \quad (1)$$

where $x \in \mathbb{R}^d$ is the input token embedding, $R(\cdot)$ is the routing function, and $\theta \in \mathbb{R}^N$ represents the expert selection probabilities for N total experts. Next, the top- K experts are selected based on these probabilities:

$$E_{\text{selected}} = \text{TopK}(\theta, K) \quad (2)$$

where E_{selected} contains the indices of the K selected experts, $K \leq N$. The selected experts then process the input in parallel:

$$y_i = E_i(x), \quad \forall i \in E_{\text{selected}} \quad (3)$$

where $E_i(\cdot)$ represents the computation of expert i , and y_i is its output. Finally, the expert outputs are combined through weighted aggregation:

$$y = \sum_{i \in E_{\text{selected}}} \frac{\theta_i}{\sum_{j \in E_{\text{selected}}} \theta_j} \cdot y_i \quad (4)$$

By partitioning dense models into relatively independent expert models and dynamically activating specific subsets (or the entire set) of experts based on each input token, the model's overall performance can be significantly enhanced with only a marginal increase in inference computation. This approach clearly demonstrates the MoE model's exceptional flexibility and scalability.

3 Model-level Optimizations

Model-level optimizations aim to enhance the inherent structure and efficiency of MoE models through systematic improvements in architecture, parameter optimization, and algorithmic design. These optimizations can be broadly categorized into three main areas: efficient model architecture design, model compression techniques, and algorithmic improvements. Architecture design focuses on developing more efficient expert and attention structures, while compression techniques aim to reduce model size and memory footprint through methods such as pruning, quantization,

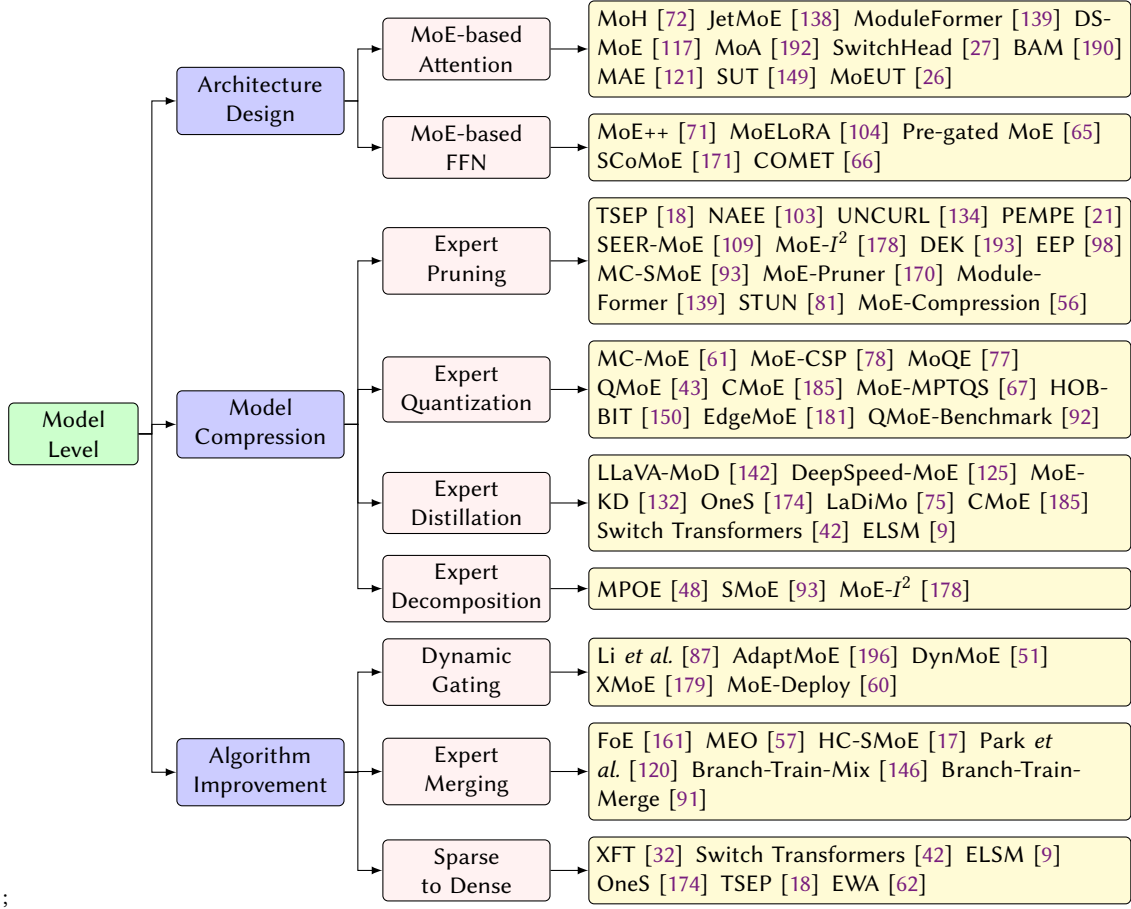

Fig. 3. Model-level inference optimization techniques for MoE.

and knowledge distillation. Algorithmic improvements concentrate on enhancing the dynamic aspects of MoE models, including routing mechanisms and expert combination strategies. Figure 3 illustrates the detailed structure of this section.

3.1 Efficient Model Architecture Design

A transformer block typically consists of two main components: the attention module and the FFN module. To build better MoE models, many studies focus on designing improved versions of both the attention and FFN modules, aiming to achieve strong performance while maintaining high efficiency.

3.1.1 MoE-based Attention Design. In addition to the typical application of the MoE structure in the FFN module of transformer layer, current studies explore how to incorporate MoE into the Attention module for improved performance. MAE [121] was the first to explain the multi-head attention mechanism from the MoE perspective, using a learned gating function to activate different experts for different inputs, with each expert consisting of $n - 1$ heads. To further optimize MoE-based attention modules, existing research proposes various structures. MoA [192] and BAM [190] select

k heads for a given input and share key projection and value projection weights among all heads, while SwitchHead [27] shares key projection and query projection weights to enhance computational efficiency. MoH [72] introduces shared heads and a two-stage routing process to further improve the standard MoE method, offering an advantage over MoA. Building upon MoA, ModuleFormer [139] extends sparse modules to both the attention and feed-forward layers, allowing for the easy addition and removal of modules. Inspired by MoA and ModuleFormer, JetMoE-8B [138] develops a powerful open-source model featuring sparse attention and sparse feed-forward layers, while DS-MoE [117] proposes a hybrid dense training and sparse inference framework for efficient training and inference. Additionally, SUT [149] and MoEUT [26] use sparse attention and sparse feed-forward layers to construct the efficient Sparse Universal Transformer model, which shares parameters across all layers.

3.1.2 MoE-based FFN Design. To enhance the efficiency of MoE-based models, current research explores various variants of the standard MoE module. MoE++ [71] introduces three types of zero-computation experts based on standard experts, aimed at reducing computational overhead. SCoMoE [171] leverages a structured all-to-all communication approach, inspired by hierarchical communication topologies, to reduce communication costs during parallel MoE computation. Pre-gated MoE [65] proposes a pre-gate MoE module that prefetches the required experts to improve inference speed on memory-constrained devices. COMET [66] introduces a tree-based sparse expert selection mechanism to optimize the traditional gating module, which typically relies on a linear approach. Additionally, MoELoRA [104] reimagines LoRA as a MoE for more parameter-efficient fine-tuning.

3.2 Model Compression Techniques

Model compression is a popular area of research for reducing model size in current LLM studies, with techniques such as pruning [94, 107], quantization [44, 160], knowledge distillation [3, 50], and low-rank decomposition [165, 186]. Since experts constitute the majority of the weights in MoE models (e.g., 96% for Mixtral-8x7B [70]), most MoE-related compression efforts focus on applying these common techniques specifically to the experts.

3.2.1 Expert Pruning. Due to the large number of parameters in MoE-based models, current research explores pruning methods to reduce the number of parameters in MoE experts. These methods are generally divided into structured and unstructured pruning. Most studies focus on structured expert pruning, which aims to reduce the number of experts in the MoE layer while maintaining model accuracy. As shown in Figure 4-(a), some approaches directly remove unimportant experts (left side), while others merge groups of experts into a single expert (right side). TSEP [18] removes non-professional experts for the target downstream task, while fine-tuning professional experts to preserve model performance. NAEF [103] eliminates unimportant experts by evaluating expert combinations on a small calibration dataset to minimize accuracy loss, while UNCURL [134] reduces the number of experts based on MoE router logits. PEMPE [21] prunes experts that have smaller changes in the router’s l_2 norm between the pre-trained and fine-tuned models, while SEER-MoE [109] employs a heavy-hitters counting method for expert pruning. And MoE- I^2 [178] proposes the Layer-wise Genetic Search and Block-wise KT-Reception Field with the non-uniform pruning ratio to prune unimportant experts. In addition to direct pruning, some studies utilize expert merging to reduce the number of experts. DEK [193] identifies and groups similar experts in feature space, then merges experts within the same group in weight space to reduce the expert count. EEP [98] introduces a two-stage approach to both prune and merge experts, reducing the total number of experts (saving GPU memory) and the number of active experts (accelerating inference). And MC-SMoE [93] divides experts into different groups based on routing policies and then merges each group into one expert. For unstructured pruning, MoE-Pruner [170] prunes weights with the smallest magnitudes, weighted by

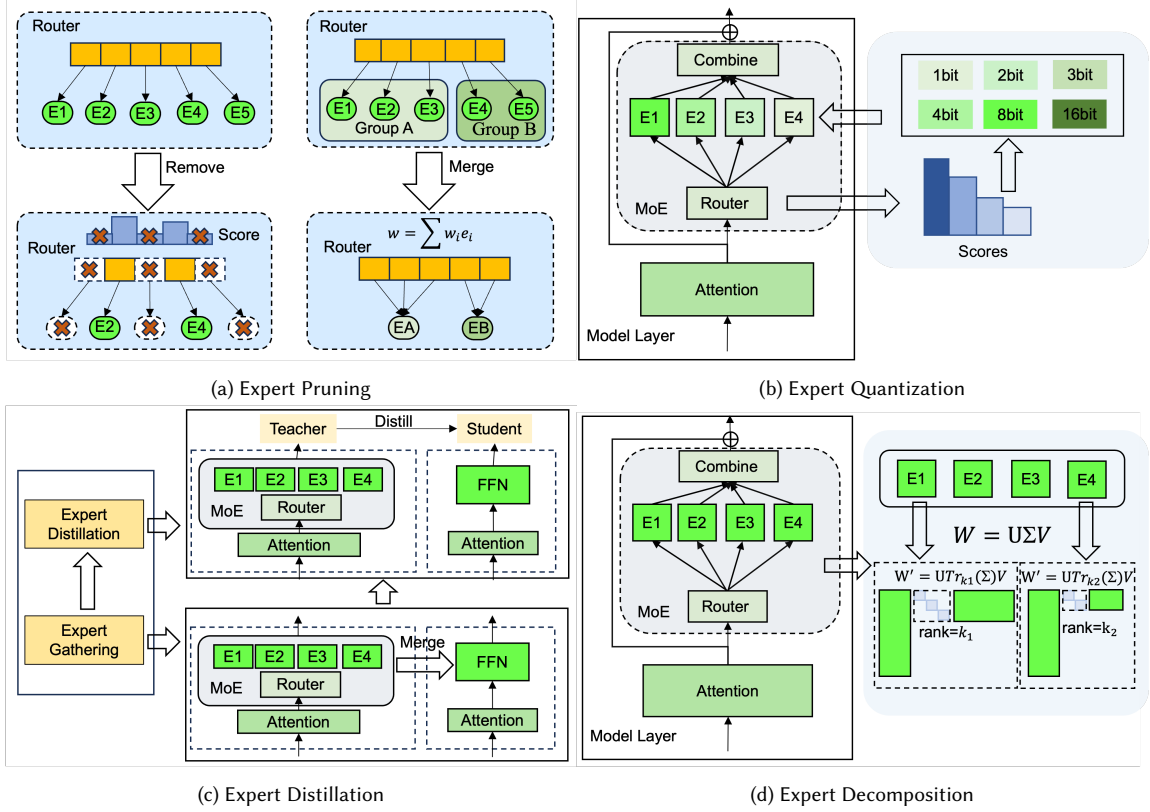

Fig. 4. Compression techniques in MoE models.

the corresponding input activations and router weights. Moreover, STUN [81] combines structured and unstructured pruning to achieve better performance than unstructured pruning alone. MoE-Compression [56] proposes a unified framework for MoE compression, using both structured and unstructured pruning methods to achieve significant inference speedup with minimal accuracy loss.

3.2.2 Expert Quantization. In addition to model pruning, quantization is an effective method for reducing model size by converting high-precision weights into low-precision ones. Due to the redundancy of experts in MoE models, current studies focus on quantizing the weights of MoE experts. As shown in Figure 4-(b), experts are quantized into suitable low precision versions using different methods. MC-MoE [61] uses both the frequency and scores of expert activations, along with the associated quantization loss, as metrics to determine the optimal quantization configuration for experts through a Linear Programming model. MoE-CSP [78] quantizes expert weights into 4 bits and designs specific cuda kernel to accelerate the computation. MoQE [77] quantizes expert weights to 2 bits to address the memory and latency challenges of MoE models, while QMoE [43] and CMoE [185] compress MoE models to 1 bit, drastically reducing model size. Furthermore, some MoE-optimized systems leverage quantization for efficient system utilization. MoE-MPTQS [67] and HOBBIT [150] dynamically select quantized experts to replace the original experts based on the current inputs, reducing the expert loading cost on memory-limited devices. EdgeMoE [181] determines the appropriate expert bit

width by profiling expert importance on a calibration dataset statistically. Additionally, QMoE-Benchmark [92] provides a benchmark that explores several MoE structure-aware quantization heuristics, ranging from coarse to fine granularity. The study reveals that different MoE structures (e.g., blocks, experts, linear layers) require varying numbers of weight bits for effective and efficient quantization.

3.2.3 Expert Distillation. Knowledge distillation is an effective method for creating smaller, yet powerful models from larger ones. Due to the large size of MoE models, direct deployment is challenging. Therefore, As shown in Figure 4-(c), knowledge distillation offers a potential solution to generate a compact, high-performance model from the original MoE model. LLaVA-MoD [142] leverages the MoE structure to balance scale reduction while maintaining the ability to capture complex multimodal knowledge through two consecutive distillation stages: mimic distillation and preference distillation. DeepSpeed-MoE [125] employs staged knowledge distillation to create a distilled version of its proposed PR-MoE model, called MoS, which reduces model size while preserving performance. Furthermore, some studies focus on transferring the power of sparse models to dense models through knowledge distillation for more efficient deployment. For example, MoE-KD [132] and CMoE [185] distill MoE-base speech recognition models into dense models, accelerating speech recognition process. OneS [174] merges experts into a single expert using various aggregation methods, and then distills the merged model with the original MoE model. Switch Transformers [42] and ELSM [9] also study the distillation techniques to distill their sparse model into a dense model. And Additionally, to simplify the construction of MoE models, LaDiMo [75] converts a dense model into a sparse MoE model through layer-wise distillation, where each expert learns to approximate the results of the original layers.

3.2.4 Expert Decomposition. As shown in Figure 4-(d), Low-rank decomposition is another effective method for reducing model size by decomposing a large weight matrix into two smaller matrices. MPOE [48] employs the matrix product operator (MPO), a tensor decomposition technique derived from quantum many-body physics, to decompose expert weights into a central tensor and several auxiliary tensors. All experts in one layer share the same central tensor, thereby reducing the total number of parameters. MC-SMoE [93] applies low-rank decomposition to its merged experts, further reducing the model size. And MoE- J^2 [178] identifies the importance of each expert and assigns higher ranks to more important experts while assigning lower ranks to less important ones for low-rank decomposition.

3.3 Algorithm Optimization

The core algorithm design of MoE is expert networks, and selecting appropriate granularity sparsity is a prerequisite for effectively utilizing the advantages of MoE. Next, we will fully explore the inference optimization of MoE models from three different strategies.

3.3.1 Dynamic Gating. Given the significant progress in utilizing the sparsity of MoE models, an important question arises: how can we further leverage this sparsity during inference? Due to the vertical parallel structure of MoE experts, dynamically reducing the number of experts activated for each token clearly presents an effective strategy. Figure 5-(a) illustrates the MoE layer’s calculation process after the skip mechanism is applied, in contrast to the original process.

Li *et al.* [87] proposes a self-adaptive gating mechanism that dynamically determines the number of experts required for each token, based on the expert probability distribution. This method enhances training efficiency while preserving the sparsity of the MoE model and further reduces training time through curriculum learning. DynMoE [51] introduces two innovative methods for expert activation: the top-down gating method, which allows different tokens to activate varying numbers of experts, and an adaptive process that dynamically adjusts the number of activated experts based on

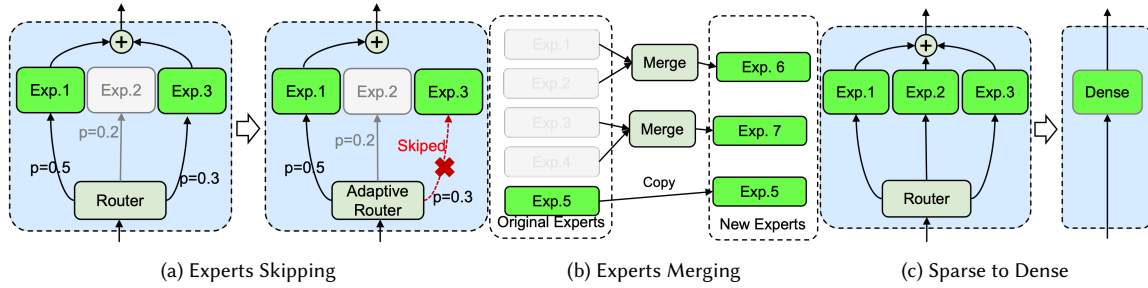

Fig. 5. Algorithm improvement on experts.

need. XMoE [179] employs a strategy of using smaller, but more experts, dynamically selecting the number of activated experts based on a set threshold. AdapMoE [196] is a co-design framework aimed at improving inference efficiency on edge devices. It adaptively applies three techniques: expert activation, expert prefetching, and GPU cache allocation. For deployment, MoE-Deploy [60] integrates a dynamic gating method with the other two technologies to optimize performance.

3.3.2 Expert Merging. What other methods can we use to reduce the number of experts while maintaining or even improving their performance? One potential approach is inspired by ensemble learning, where merging outdated sub-experts based on their parameters could achieve this goal. Figure 5-(b) illustrates the expert merging process to decrease the number of parameters during inference.

Branch-Train-Merge [91] independently trains different parts of the model on distinct subsets of data, eliminating the need for large-scale multi-node synchronization typically required in traditional LLM training. Building on this, Branch-Train-Mix [146] merges the parameters of the MoE layer to create a unified model that can be further trained. Park *et al.* [120] observed that introducing a shared layer in the MoE could lead to performance degradation. To address this, they trained merged experts that learned the same features in different ways, improving their ability to generalize and mitigating catastrophic forgetting during incremental learning of multi-domain tasks. HC-SMoE [17] is a framework that uses hierarchical clustering to merge experts without requiring retraining, and can be applied in a task-agnostic manner. During inference, MEO [57] first merges the selected expert parameters and then performs efficient computation. FoE [161] fuses the outputs of expert models by leveraging their complementary knowledge of the data distribution, framing it as a supervised learning instance.

3.3.3 Sparse to Dense. In certain scenarios, dense models offer unique advantages due to their smaller number of parameters. So why not transform MoE models into dense target models all at once, achieving maximum sparsity while maintaining model performance? Most approaches use knowledge distillation to achieve this sparse-to-dense conversion, as illustrated in Figure 5-(c).

XFT [32] proposes a novel method to supervise fine-tune dense LLMs. They first generate a sparse-upcycled MoE model, then transform it back into an efficient dense LLM of the same size and structure through a learnable merging mechanism. Switch Transformers [42] explores distillation techniques to convert a sparse model into a dense one, demonstrating that the dense model can retain over 30% of its performance even after compressing 97% of the parameters from the sparse MoE model. In another study ELSM [9], it also finds that a dense student model distilled from a sparse MoE model can improve performance. OneS [174] employs four distinct methods to generate the dense model, including

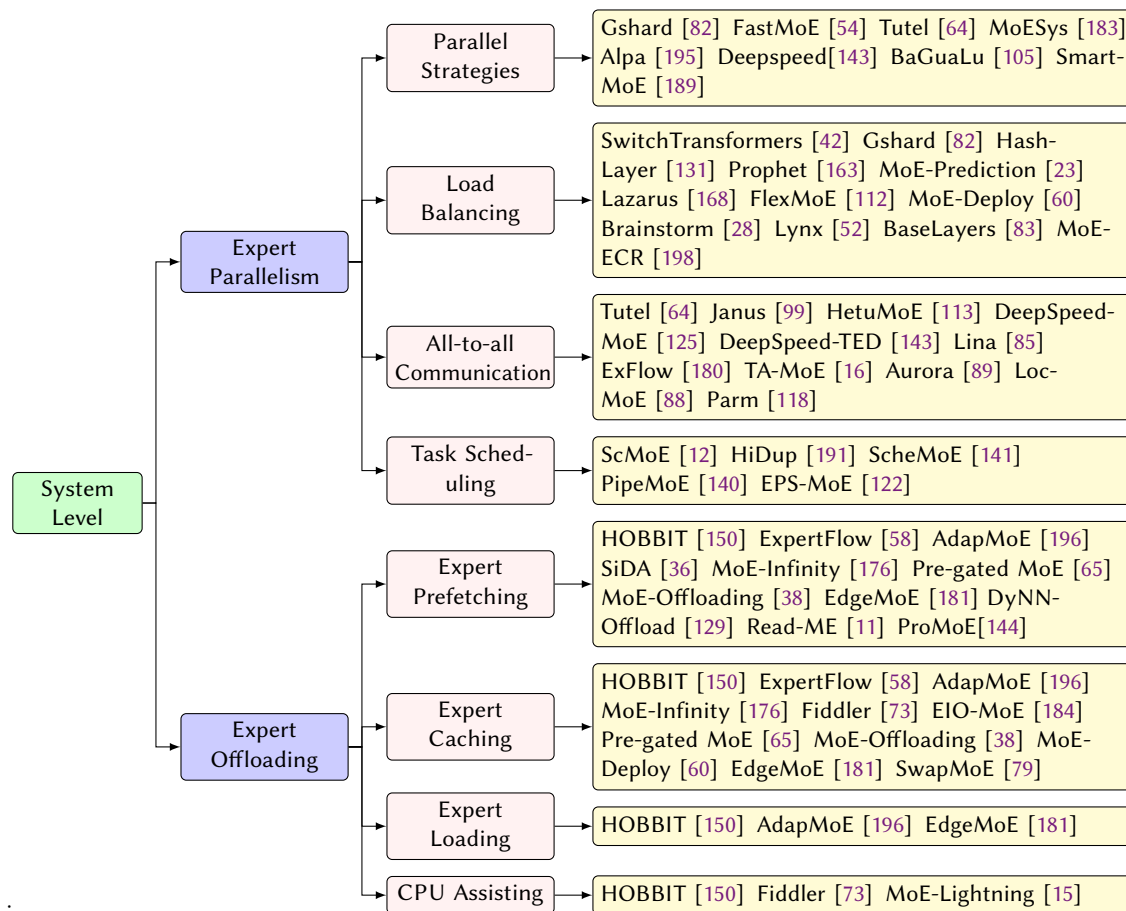

Fig. 6. System-level inference optimization techniques for MoE.

summation, averaging, Top-K Knowledge Gathering, and Singular Value Decomposition Knowledge Gathering. The model is then refined to reduce noise by gathering sparse knowledge. TSEP [18] progressively eliminates non-expert components based on specific downstream tasks, ultimately converting the sparse MoE model into a dense counterpart. EWA [62] replaces FFNs with specially designed MoEs during training, and then reverts to the original dense ViT for inference.

4 System-level Optimizations

Due to the unique structure of MoE, many studies focus on accelerating inference at the system level by leveraging the sparse activation patterns inherent to this architecture. Typically, MoE models are deployed in two scenarios: cloud environments with multiple servers and edge environments with a single device. In cloud clusters, MoE models are distributed across many devices to enable parallel execution. In addition to traditional parallelization techniques such as data parallelism, tensor parallelism, and pipeline parallelism [69, 110, 126], expert parallelism is a specialized method tailored specifically for MoE models. On edge devices, limited GPU memory often cannot accommodate all parameters

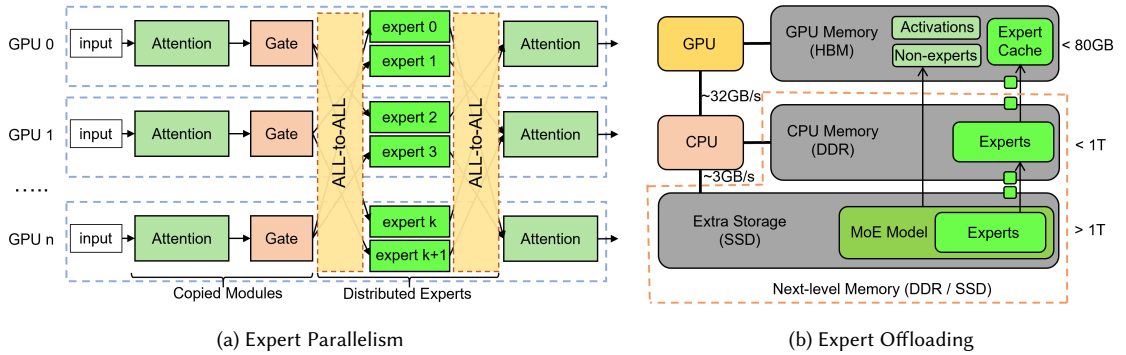

Fig. 7. Expert parallelism and expert offloading techniques.

of an MoE model, necessitating the offloading of some parameters to CPU memory or SSD storage. To address this, the expert-offloading technique has been developed to fully utilize the sparse activation patterns of experts for efficient execution. Figure 6 shows the detailed structure of this section.

4.1 Expert Parallelism

Expert parallelism is a key technique for deploying large MoE models across multiple devices to enable distributed execution. As Figure 7-(a) shown [141], when distributing MoE layers, each device holds a subset of experts along with all other non-expert parameters. In special cases where an expert is very large, each device may contain only one expert. During the execution of an MoE layer, inputs are processed on each device by the attention module and gate module. Subsequently, an all-to-all communication operation redistributes tokens to corresponding devices based on the gate output, allowing each expert to process its assigned inputs. Finally, another all-to-all communication operation occurs to exchange the experts' outputs and send them back to the originating devices. Consequently, the execution time of MoE layers is dominated by two primary phases: computation and communication. To accelerate inference, various studies have proposed optimizations for these phases.

Existing research focuses on optimizing MoE training and inference performance along four main dimensions: parallel strategies, load balancing, all-to-all communication, and task scheduling.

4.1.1 Parallelism Strategy Design. In addition to relying solely on expert parallelism [54, 82], recent studies combine multiple parallel strategies to maximize parallelism and achieve more efficient distributed computing. Tutel [64] dynamically switches parallel strategies at each iteration without incurring extra overhead. MoESys [183] employs an elastic MoE training strategy with 2D prefetching and fusion communication over hierarchical storage for efficient parallelism. Alpa [195] automatically derives efficient parallel execution plans at both inter-operator and intra-operator levels. DeepSpeed-TED [143] implements a hybrid parallel algorithm combining data, tensor, and expert parallelism. BaGuaLu [105] integrates MoE and data parallelism to scale models effectively. SmartMoE [189] introduces a two-stage approach to identify optimal parallel strategies for data-sensitive models.

4.1.2 Load Balancing. Token processing in MoE models can lead to imbalances, where some experts receive significantly more tokens than others. This disparity results in some devices experiencing high overheads while others remain idle, ultimately delaying overall computation. To address this issue, some works propose to add auxiliary loading

balancing loss to train the gate module [42, 82, 137], while other works implement gate modules with special hash functions to avoid imbalance loading [131]. Advanced techniques also focus on expert placement optimization. For example, Prophet [163] leverages temporal locality to fine-tune resource allocation and expert placement, while MoE-Prediction [23] monitors expert loads and adapts placements based on transient and stable states. Lazarus [168] allocates expert replicas using an optimal placement algorithm, and FlexMoE [112] employs fine-grained replication strategies to dynamically adjust the expert-to-device mapping at runtime. Additional strategies, such as those proposed by MoE-Deploy [60] and Brainstorm [28], rely on historical allocation data and expert reordering to balance loads. Furthermore, techniques like Lynx [52] reduce the number of active experts during batch inference, and BaseLayers [83] formulates token-to-expert allocation as a linear assignment problem to ensure equitable token distribution. And MoE-ECR [198] allows experts to select the top-k tokens instead of letting each token choose the top-k experts, ensuring that each expert has a fixed bucket size.

4.1.3 All-to-all Communication Optimization. All-to-all communication is a significant bottleneck in MoE layer execution [55, 89, 125], prompting substantial research to optimize this operation. Many efforts focus on hierarchical communication strategies and data compression techniques to reduce overhead. For instance, Tutel [64] introduces a two-dimensional hierarchical all-to-all algorithm, while HetuMoE [113] and DeepSpeed-MoE [125] optimize communication by combining intra-node and inter-node hierarchies. Data compression strategies, such as those employed by DeepSpeed-TED [143] and TA-MoE [16], minimize data transfer by eliminating unnecessary information and adapting data volume to the network topology. Innovative paradigms like Janus [99] adopt a data-centric approach, where experts are moved between devices instead of tokens, significantly reducing communication costs. Similarly, ExFlow [180] exploits inter-layer expert affinity to halve the number of all-to-all operations per MoE layer, and Aurora [89] optimizes token transmission to avoid bandwidth contention. LocMoE [88] and Parm [118] further enhance communication efficiency by converting inter-node communication to intra-node operations and overlapping intra-node with inter-node communications. And Lina [85] accelerates the all-to-all communication by prioritizing all-to-all operation over all-reduce operation.

4.1.4 Task Scheduling. To overlap communication and computation tasks to reduce end-to-end runtime, various task scheduling strategies have been developed. Advanced scheduling strategies leverage architectural and algorithmic innovations to achieve this overlap effectively. For example, ScMoE [12] integrates shortcut-connected MoE architecture to enable simultaneous communication and computation, while HiDup [191] uses microbatching to alternate between computation and communication within a single training step. ScheMoE [141] provides a generic framework for optimizing task scheduling, and PipeMoE [140] pipelines tasks to hide communication latency through a performance model. Additionally, EPS-MoE [122] dynamically selects optimal kernel implementations to adaptively overlap FFN module computation with all-to-all communication, further improving runtime efficiency.

4.2 Expert Offloading

When deploying MoE models on edge devices, parameter-offloading techniques offer a potential solution to mitigate the challenge of insufficient GPU memory for storing all model parameters. However, traditional parameter-offloading methods load model parameters layer by layer from CPU memory or SSD, neglecting the sparse activation characteristics of MoE models. This oversight incurs significant overhead in parameter loading, leading to suboptimal inference performance. To address this limitation, many studies have proposed expert-offloading techniques, which take advantage

of MoE sparse activation patterns. Instead of loading all experts for a given layer, expert-offloading selectively loads only the required experts, thereby significantly reducing loading latency.

As Figure 7-(b) shown [150], expert-offloading operates by storing all non-expert weights and a subset of critical experts in GPU memory (referred to as the "expert cache") while offloading less frequently used experts to CPU memory or SSD (referred to as "next-level memory"). When required experts are missing from the expert cache, they are fetched from next-level memory and loaded into the cache, potentially replacing some existing experts. Various studies have optimized this process using different strategies to achieve superior inference performance.

4.2.1 Expert Prefetching. To minimize waiting time for the required experts, some studies focus on optimizing prefetching techniques, which overlap expert loading with GPU computation. Several works predict the experts needed for subsequent layers. For example, MoE-Offloading [38], AdapMoE [196], and HOBBIT [150] use current gating inputs as predictors for the next-layer gating inputs, prefetching the required experts in advance. Pre-gated MoE [65] introduces a pre-gated MoE structure that identifies the experts required by the next layer during the computation of the current layer and preloads them accordingly. EdgeMoE [181] constructs a prediction table using a calibrated dataset, leveraging the current layer experts to predict the next layer's experts. DyNN-Offload [129] trains a pilot model for each layer to predict the required experts for the next layer. MoE-Infinity [176] tracks the request-level usage frequency of each expert and prefetches high-priority experts based on this frequency. ProMoE [144] uses a learned predictor to prefetch experts in a sliding-window manner. Additionally, some works aim to predict all the required experts in the current forward pass in a single step. For instance, ExpertFlow [58] trains a predictor to anticipate all the required experts for the current forward pass and prefetches them in advance. SiDA [36] employs a hash function to predict activated experts for each token in the sequence based on its embedding. Similarly, Read-ME [11] constructs a pre-gating router decoupled from the MoE backbone to predict all required experts at once.

4.2.2 Expert Caching. Since GPU memory can hold only a subset of experts (expert cache), optimizing the cache management policy is critical to improving the cache hit ratio and reducing transfer time. Several works [38, 60, 65, 181, 184] adopt the Least Recently Used (LRU) policy, as recently used experts are more likely to be accessed again. In contrast, MoE-Infinity [176] employs a Least Frequently Used (LFU) policy due to its request-level tracking capability. Fiddler [73] maintains the most critical experts in GPU memory using a static dataset-based approach, whereas SwapMoE [79] dynamically updates the most important experts. AdapMoE [196] introduces a dynamic cache size for different model layers, driven by its adaptive gating algorithm. Meanwhile, HOBBIT [150] proposes a multidimensional cache policy combining LRU, LFU, and a novel Least High Precision Used (LHU) strategy for its mixed-precision expert cache.

4.2.3 Expert Loading. Expert loading time often constitutes the primary bottleneck in expert-offloading inference. To address this, some works aim to directly reduce loading costs. EdgeMoE [181] and HOBBIT [150] reduce loading time by using low-precision experts instead of high-precision ones. EdgeMoE determines expert precision by profiling their importance on a dataset, while HOBBIT dynamically selects suitable precision for cache-missing experts based on current inputs. AdapMoE [196] employs an adaptive gating algorithm to skip less important experts, further lowering expert loading costs.

4.2.4 CPU Assisting. Beyond relying solely on the GPU for computation, some approaches leverage the CPU to assist. Fiddler [73] performs MoE computation on the CPU when the required experts are unavailable in GPU memory, instead of loading them into the GPU. MoE-Lightning [15] introduces an innovative CPU-GPU-I/O pipelining strategy, enabling simultaneous utilization of CPU and GPU resources to enhance overall system efficiency.

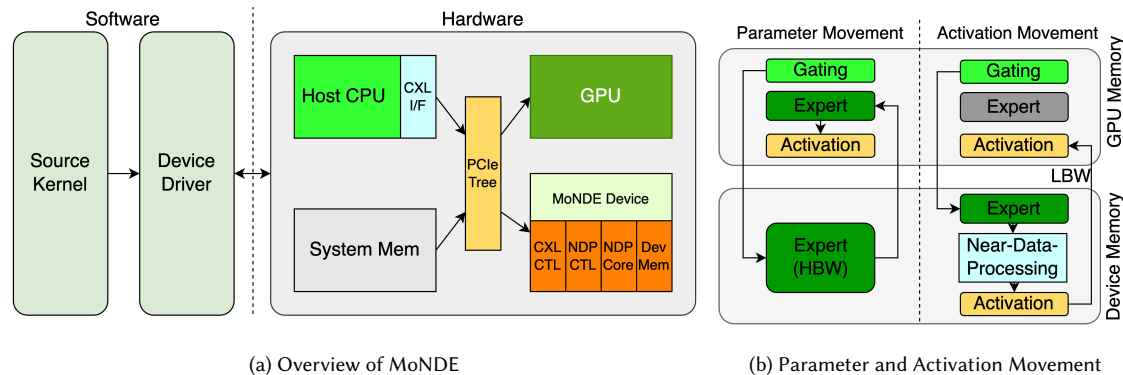

Fig. 8. (a) MoNDE [76] system design integrating software and hardware. (b) the data flow between AM and PM.

5 Hardware-Level Optimization

Recent hardware optimizations for MoE inference have addressed key challenges through novel architectures and co-design approaches. These optimizations target critical issues such as operations per byte (Op/B) efficiency, heterogeneous computing units, and memory access patterns. The following discusses significant advances in hardware-level solutions.

MoNDE [76] introduces a near-data processing (NDP) solution to address the challenges of sparse activation and expert parameter transmission overhead (Fig. 8). The architecture integrates CXL (Compute Express Link)-based NDP controllers with specialized NDP cores for in-memory computation, utilizing LPDDR SDRAM (low power double data rate synchronous dynamic random-access memory) for high bandwidth and energy efficiency. The system implements a hybrid computing strategy where GPUs handle frequently accessed "hot" experts while NDP units process "cold" experts, enabling concurrent execution through an Activation Movement paradigm rather than traditional Parameter Movement.

FLAME [97] is the first MoE accelerating framework which fully exploits MoE sparsity for transformer on FPGA. At the parameter level of the model, it utilizes M:N pruning to reduce unnecessary calculations, which can make balance between column balanced structured pruning and unstructured pruning; At the expert level, sparse activation prediction is performed through CEPR(circular expert prediction). By changing the patterning of activation path of experts, the accuracy of expert predictions can be effectively improved. Then use a double buffering mechanism to load the predicted expert while computing the previous expert to improve expert deployment efficiency.

M³ViT [40] and Edge-MoE [133] constructed their FPGA architecture based on the reordering of attention computation in multitasking scenarios. For inference, M³ViT can activate only the sparse "expert" pathway relevant to the task of interest for efficiency, and can further achieve zero-overhead switching between tasks with their hardware-level co-design. Edge-MoE is the first end-to-end FPGA implementation for multi-task ViT proposed some aggressive techniques, including an approximate method for solving the excessive complexity of GELU function calculation on FPGA and a unified linear layer module to achieve efficient reuse of hardware resource.

Duplex [188] selects a destination suitable for each layer execution in the device that combines xPU and Logic PIM (processing-in-memory). that's means it could integrate two types of processing units that share device memories. Due to the bottleneck in computation and memory access between these two processing units which can complement each other, high computation and memory access utilization can be achieved simultaneously on the same device. Besides, it

introduced an alternative PIM microarchitecture. logic PIM optimized low Op/B operations through powerful processing units on the logic die, as well as more through silicon vias (TSVs) to achieve high bandwidth communication between DRAM die and logic die. Furthermore, it could execute expert and attention stage in parallel to maximize inference efficiency.

Space-mate [119] has provided its accelerator design for SLAM (simultaneous localization and mapping) tasks on mobile devices. Mainly including an Out-of-Order (OoO) SMOE router to alleviate data transactions for low latency, a single skip (SS) and dual-skip (DS) heterogeneous core architecture to exploit coarse-grained sparsity caused by similar zero patterns in the same expert for high throughput and energy-efficiency.

6 Future Directions and Open Challenges

Despite significant advances in MoE inference optimization, critical challenges and opportunities exist throughout the computing stack. This section presents a systematic analysis of future research directions, organized along three fundamental dimensions: (1) computing infrastructure, from hardware to system software, (2) key system requirements, including performance, reliability, and efficiency, and (3) development support ecosystem. These dimensions are interconnected: advances in infrastructure enable better system properties, while development tools accelerate progress in both areas.

6.1 Computing Infrastructure Optimization

6.1.1 Hardware Integration and Acceleration. The efficient execution of MoE models demands novel hardware architectures and acceleration strategies that go beyond traditional computing paradigms [40, 119, 133, 188]. Current hardware platforms, optimized primarily for dense computations, often struggle to efficiently handle the sparse and dynamic nature of MoE workloads [147, 182, 197]. This necessitates the development of specialized hardware solutions that can better support the unique computational patterns of MoE inference.

Traditional hardware optimization presents several immediate opportunities for improvement. The development of specialized circuits for expert routing and activation could significantly reduce the overhead of dynamic expert selection. Memory hierarchies optimized for sparse parameter access could better support the irregular access patterns characteristic of MoE computation. Furthermore, the implementation of efficient hardware support for dynamic workload patterns could enhance the overall system performance.

Emerging hardware platforms offer exciting new possibilities for MoE acceleration. Neuromorphic computing systems [135, 136], with their inherent support for sparse, event-driven computation, could provide natural acceleration for expert activation patterns. Quantum computing platforms [95, 116, 145] might enable novel approaches to complex routing decisions, though significant challenges remain in effectively bridging classical and quantum computations. The integration of novel memory technologies could also provide more efficient storage and access patterns for expert parameters.

6.1.2 System Software Optimization. The optimization of the system software stack presents significant challenges for MoE models due to their unique computational patterns and resource requirements. Current operating systems and runtime environments, designed primarily for traditional dense neural networks, lack native support for efficient sparse computation and dynamic expert scheduling [28]. This gap between hardware capabilities and application requirements necessitates fundamental innovations in system software design.

Memory management systems need a significant redesign to handle the dynamic nature of expert activation. Traditional virtual memory systems and cache hierarchies for LLM are optimized for regular access patterns, while MoE models exhibit highly irregular, input-dependent memory access behaviors [80]. Future research must develop specialized memory management techniques that can predict and prefetch expert parameters more effectively, potentially incorporating new abstractions for sparse tensor operations.

Resource allocation in distributed environments requires particular attention. The dynamic nature of expert activation makes it difficult to optimize placement and migration decisions [23, 163]. Future systems need to incorporate robust mechanisms for load balancing, fault tolerance, and resource elasticity. This includes developing intelligent middleware that can adapt to changing workload patterns and system conditions while maintaining efficient resource utilization.

The co-design of hardware and software components represents a crucial challenge in this domain, reflecting the fundamental gap between traditional computing architectures designed for dense computation and the unique requirements of MoE models. Future research must focus on developing hardware architectures that can minimize energy consumption while maintaining performance, including exploring novel approaches to reducing data movement and developing hardware-level techniques for trading off accuracy for efficiency. Success in this area requires close collaboration between hardware architects and algorithm designers to ensure that hardware optimizations align with the computational requirements of MoE models, as progress in both hardware and software layers, and particularly their co-design, is essential for efficient MoE deployment.

6.2 Operational Challenges and Requirements

The deployment and operation of MoE systems in production environments introduce complex challenges that span performance optimization, system reliability, and resource efficiency. These operational requirements often interact and sometimes conflict, requiring careful balance in real-world settings. Understanding and addressing these challenges is crucial for the practical adoption of MoE systems across different application domains and deployment scenarios.

6.2.1 Energy Efficiency and Sustainability. Energy efficiency and environmental impact considerations have received relatively less attention in MoE inference optimization research, which has predominantly focused on throughput and latency metrics. As AI systems continue to scale and their environmental impact becomes more significant, there is a pressing need to consider energy consumption and carbon emissions as primary optimization objectives alongside traditional performance metrics [6, 25, 59, 106, 127].

The energy consumption patterns of MoE models present unique challenges due to their sparse activation patterns and distributed nature. While sparse activation theoretically reduces computational demands, the overhead from expert routing, communication, and load balancing can lead to significant energy costs [64, 112, 141]. Current hardware platforms, often optimized for dense computations, result in suboptimal energy efficiency when handling the dynamic workloads characteristic of MoE inference [114, 200]. Additionally, the distributed nature of many MoE deployments introduces substantial energy overhead from data movement and communication.

Carbon-aware deployment strategies represent an important direction for future research [39, 46, 124]. In distributed settings, expert placement and workload distribution decisions should consider not just computational resources but also the carbon intensity of different data centers' power sources. This could involve developing dynamic scheduling algorithms that preferentially route computation to locations with access to renewable energy. Understanding and optimizing the trade-off between energy consumption and model quality is crucial, requiring methods to quantify

these relationships and creating adaptive mechanisms that can dynamically adjust this trade-off based on application requirements and energy constraints.

The development of comprehensive energy accounting frameworks is essential for accurate optimization. Current evaluation methodologies often fail to account for the full energy cost of MoE inference, including both direct computational costs and indirect costs from data movement, cooling, and infrastructure overhead. Future research must focus on developing more sophisticated energy models that can capture these various aspects of energy consumption, enabling more informed optimization decisions that consider the full environmental impact of MoE deployment.

6.2.2 Latency and Quality of Service. The dynamic and distributed nature of MoE inference introduces significant challenges in maintaining consistent performance and reliability. Unlike traditional neural networks with fixed computation patterns, MoE models exhibit variable execution paths and resource requirements, making it difficult to provide consistent latency guarantees and maintain high availability [28, 176].

Predictable expert activation and routing represent a fundamental challenge. The input-dependent nature of expert selection can lead to significant variability in processing time and resource utilization. Research is needed to develop techniques that can better predict and manage this variability, potentially through advanced caching strategies, workload characterization, and adaptive routing algorithms [58, 144, 196]. This includes methods for balancing the trade-off between routing accuracy and computational overhead.

System reliability and fault tolerance require particular attention in distributed MoE deployments [14]. The failure of individual experts or communication links can significantly impact system performance and model quality. Research opportunities include developing robust failure detection and recovery mechanisms, implementing graceful degradation strategies, and designing redundancy schemes that balance reliability with resource efficiency. This includes methods for maintaining service quality even when some experts are unavailable or performing sub-optimally.

6.3 Development Support Ecosystem

6.3.1 Open-Source Frameworks. Current deep learning frameworks like PyTorch [4] and TensorFlow [152] lack native optimizations for MoE workloads, treating them as an auxiliary use case rather than a primary optimization target. This gap between framework capabilities and MoE requirements creates significant challenges for researchers and practitioners attempting to develop and deploy MoE systems efficiently.

Core framework support for MoE-specific operations requires fundamental enhancements. Research opportunities include developing specialized operators for expert routing, implementing efficient sparse computation primitives, and creating optimized memory management systems for expert parameters [102, 122]. These enhancements must be deeply integrated into framework internals to achieve performance comparable to dense model optimization.

High-level APIs and abstractions are essential for making MoE development accessible to a broader community. Current frameworks often require significant expertise to implement MoE architectures efficiently, limiting adoption and experimentation [49]. Research needs include developing intuitive APIs for expert definition and routing configuration, implementing automated optimization passes for MoE workloads, and creating deployment abstractions that handle distributed execution complexity. These APIs must balance ease of use with the flexibility to implement novel MoE architectures and optimization strategies.

Framework integration with existing ML ecosystems represents another critical challenge. MoE systems must coexist with traditional models and leverage existing tools for training, debugging, and deployment. Future research should focus on developing standardized interfaces for MoE components, implementing compatibility layers with popular ML

tools, and creating unified optimization pipelines that can handle both dense and sparse computation patterns. This integration must preserve framework performance while maintaining compatibility with the broader ML ecosystem.

6.3.2 Benchmarking and Standardization. The rapid advancement of MoE inference optimization techniques has created a pressing need for comprehensive benchmarking and standardization frameworks [45, 111]. Although many LLM benchmarks have been developed in recent years [7, 63, 128, 172], they are not well-suited for evaluating MoE systems due to a lack of consideration for the unique characteristics of the MoE architecture [45]. Current evaluation practices often vary significantly across studies, making it difficult to perform fair comparisons and assess the relative merits of different optimization approaches. This fragmentation in evaluation methodologies impedes the systematic progress of the field and complicates the adoption of optimization techniques in practical applications.

A standardized benchmarking framework should encompass multiple dimensions of MoE inference optimization. This includes performance metrics such as latency, throughput, and resource utilization, as well as model quality metrics across different tasks and domains. The framework should also consider various deployment scenarios, from edge devices to large-scale distributed systems, and different hardware configurations. Furthermore, standardized workload patterns that reflect real-world usage scenarios are essential for meaningful evaluation of optimization techniques.

The development of such benchmarking standards presents several challenges. The dynamic nature of MoE models, where different inputs may activate different experts, makes it difficult to establish consistent performance measurements. The trade-offs between various optimization objectives (e.g., latency vs. throughput, or quality vs. efficiency) need to be carefully balanced in the evaluation criteria. Moreover, the diverse hardware platforms and deployment scenarios used in practice require benchmarks that can meaningfully capture performance across different contexts.

Looking forward, the field would benefit from the establishment of standardized benchmark suites and consistent evaluation methodologies. The development of reference implementations and baseline systems would facilitate comparative analysis, while the definition of representative workload patterns would ensure relevance to practical applications. These standardization efforts would ultimately accelerate the advancement of MoE inference optimization research by enabling more rigorous and comparable evaluations of new techniques.

7 Conclusion

This survey provides a comprehensive overview of inference optimization techniques for MoE models across different abstraction levels. We have systematically analyzed various approaches, from model-level optimizations including efficient expert design, compression techniques, and algorithm improvements, to system-level solutions for distributed computing and expert offloading, and finally to hardware-level acceleration designs. Through this analysis, we observe that while MoE models offer a promising approach to scale model capacity with controlled computational costs, their efficient deployment requires careful consideration and optimization at multiple levels of the system stack. The field has seen rapid advancement with numerous innovative solutions, yet several challenges remain, particularly in areas such as hardware integration, energy efficiency, and standardized benchmarking.

Looking forward, we anticipate continued evolution in MoE inference optimization, driven by both academic research and industrial applications. The increasing adoption of MoE architectures in large-scale language models and multimodal systems will likely spur further innovations in optimization techniques. Key areas for future research include the development of specialized hardware architectures for sparse computation, more efficient expert routing algorithms, and improved system-level solutions for distributed deployment. We hope this survey serves as a valuable reference for

researchers and practitioners working on MoE deployment, providing a structured understanding of current approaches and inspiring new directions in this rapidly evolving field.

References

- [1] ABDIN, M., ANEJA, J., AWADALLA, H., AWADALLAH, A., AWAN, A. A., BACH, N., BAHREE, A., BAKHTIARI, A., BAO, J., BEHL, H., ET AL. Phi-3 technical report: A highly capable language model locally on your phone. *arXiv preprint arXiv:2404.14219* (2024).
- [2] ACHIAM, J., ADLER, S., AGARWAL, S., AHMAD, L., AKKAYA, I., ALEMAN, F. L., ALMEIDA, D., ALTENSCHMIDT, J., ALTMAN, S., ANADKAT, S., ET AL. Gpt-4 technical report. *arXiv preprint arXiv:2303.08774* (2023).
- [3] AGARWAL, R., VIEILLARD, N., STANCZYK, P., RAMOS, S., GEIST, M., AND BACHEM, O. Gkd: Generalized knowledge distillation for auto-regressive sequence models. *arXiv preprint arXiv:2306.13649* (2023).
- [4] AI, M. Pytorch, 2024.
- [5] ALABDULMOHSIN, I. M., NEYSHABUR, B., AND ZHAI, X. Revisiting neural scaling laws in language and vision. *Advances in Neural Information Processing Systems* 35 (2022), 22300–22312.
- [6] ALIZADEH, N., AND CASTOR, F. Green ai: A preliminary empirical study on energy consumption in dl models across different runtime infrastructures. In *Proceedings of the IEEE/ACM 3rd International Conference on AI Engineering-Software Engineering for AI* (2024), pp. 134–139.
- [7] ANALYSIS, A. Artificial analysis llm performance leaderboard, 2024.
- [8] ANTHROPIC. The claude 3 model family: Opus, sonnet, haiku, 2023.
- [9] ARTETXE, M., BHOSALE, S., GOYAL, N., MIHAYLOV, T., OTT, M., SHLEIFER, S., LIN, X. V., DU, J., IYER, S., PASUNURU, R., ET AL. Efficient large scale language modeling with mixtures of experts. *arXiv preprint arXiv:2112.10684* (2021).
- [10] BAI, G., CHAI, Z., LING, C., WANG, S., LU, J., ZHANG, N., SHI, T., YU, Z., ZHU, M., ZHANG, Y., ET AL. Beyond efficiency: A systematic survey of resource-efficient large language models. *arXiv preprint arXiv:2401.00625* (2024).
- [11] CAI, R., RO, Y., KIM, G.-W., WANG, P., BEJNORDI, B. E., AKELLA, A., AND WANG, Z. Read-me: Refactorizing llms as router-decoupled mixture of experts with system co-design, 2024.
- [12] CAI, W., JIANG, J., QIN, L., CUI, J., KIM, S., AND HUANG, J. Shortcut-connected expert parallelism for accelerating mixture-of-experts. *arXiv preprint arXiv:2404.05019* (2024).
- [13] CAI, W., JIANG, J., WANG, F., TANG, J., KIM, S., AND HUANG, J. A survey on mixture of experts. *Authorea Preprints* (2024).
- [14] CAI, W., QIN, L., AND HUANG, J. Moc-system: Efficient fault tolerance for sparse mixture-of-experts model training, 2024.
- [15] CAO, S., LIU, S., GRIGGS, T., SCHAFHALTER, P., LIU, X., SHENG, Y., GONZALEZ, J. E., ZAHARIA, M., AND STOICA, I. Moe-lightning: High-throughput moe inference on memory-constrained gpus, 2024.
- [16] CHEN, C., LI, M., WU, Z., YU, D., AND YANG, C. Ta-moe: Topology-aware large scale mixture-of-expert training. *Advances in Neural Information Processing Systems* 35 (2022), 22173–22186.
- [17] CHEN, I., LIU, H.-S., SUN, W.-F., CHAO, C.-H., HSU, Y.-C., LEE, C.-Y., ET AL. Retraining-free merging of sparse mixture-of-experts via hierarchical clustering. *arXiv preprint arXiv:2410.08589* (2024).
- [18] CHEN, T., HUANG, S., XIE, Y., JIAO, B., JIANG, D., ZHOU, H., LI, J., AND WEI, F. Task-specific expert pruning for sparse mixture-of-experts. *arXiv preprint arXiv:2206.00277* (2022).
- [19] CHERTI, M., BEAUMONT, R., WIGHTMAN, R., WORTSMAN, M., ILHARCO, G., GORDON, C., SCHUHMAN, C., SCHMIDT, L., AND JITSEV, J. Reproducible scaling laws for contrastive language-image learning. In *Proceedings of the IEEE/CVF Conference on Computer Vision and Pattern Recognition* (2023), pp. 2818–2829.
- [20] CHOWDHURY, A., NARANG, S., DEVLIN, J., BOSMA, M., MISHRA, G., ROBERTS, A., BARHAM, P., CHUNG, H. W., SUTTON, C., GEHRMANN, S., ET AL. Palm: Scaling language modeling with pathways. *Journal of Machine Learning Research* 24, 240 (2023), 1–113.
- [21] CHOWDHURY, M. N. R., WANG, M., MAGHRAOUI, K. E., WANG, N., CHEN, P.-Y., AND CAROTHERS, C. A provably effective method for pruning experts in fine-tuned sparse mixture-of-experts. *arXiv preprint arXiv:2405.16646* (2024).
- [22] CHOWDHURY, M. N. R., ZHANG, S., WANG, M., LIU, S., AND CHEN, P.-Y. Patch-level routing in mixture-of-experts is provably sample-efficient for convolutional neural networks. In *International Conference on Machine Learning* (2023), PMLR, pp. 6074–6114.
- [23] CONG, P., YUAN, A., CHEN, S., TIAN, Y., YE, B., AND YANG, T. Prediction is all moe needs: Expert load distribution goes from fluctuating to stabilizing. *arXiv preprint arXiv:2404.16914* (2024).
- [24] COSTA-JUSSÀ, M. R., CROSS, J., ÇELEBI, O., ELBAYAD, M., HEAFIELD, K., HEFFERNAN, K., KALBASSI, E., LAM, J., LICHT, D., MAILLARD, J., ET AL. No language left behind: Scaling human-centered machine translation. *arXiv preprint arXiv:2207.04672* (2022).
- [25] CRUZ, L., GUTIERREZ, X. F., AND MARTÍNEZ-FERNÁNDEZ, S. Innovating for tomorrow: The convergence of se and green ai. *arXiv preprint arXiv:2406.18142* (2024).
- [26] CSORDÁS, R., IRIE, K., SCHMIDHUBER, J., POTTS, C., AND MANNING, C. D. Moeut: Mixture-of-experts universal transformers. *arXiv preprint arXiv:2405.16039* (2024).
- [27] CSORDÁS, R., PIĘKOS, P., IRIE, K., AND SCHMIDHUBER, J. Switchhead: Accelerating transformers with mixture-of-experts attention. *arXiv preprint arXiv:2312.07987* (2023).

- [28] CUI, W., HAN, Z., OUYANG, L., WANG, Y., ZHENG, N., MA, L., YANG, Y., YANG, F., XUE, J., QIU, L., ZHOU, L., CHEN, Q., TAN, H., AND GUO, M. Optimizing dynamic neural networks with brainstorm. In *17th USENIX Symposium on Operating Systems Design and Implementation (OSDI 23)* (Boston, MA, July 2023), USENIX Association, pp. 797–815.
- [29] DAI, D., DENG, C., ZHAO, C., XU, R., GAO, H., CHEN, D., LI, J., ZENG, W., YU, X., WU, Y., ET AL. Deepseekmoe: Towards ultimate expert specialization in mixture-of-experts language models. *arXiv preprint arXiv:2401.06066* (2024).
- [30] DEEPSEEK-AI, LIU, A., FENG, B., WANG, B., WANG, B., LIU, B., ZHAO, C., DENG, C., RUAN, C., DAI, D., GUO, D., YANG, D., CHEN, D., JI, D., LI, E., LIN, F., LUO, F., HAO, G., CHEN, G., LI, G., ZHANG, H., XU, H., YANG, H., ZHANG, H., DING, H., XIN, H., GAO, H., LI, H., QU, H., CAI, J. L., LIANG, J., GUO, J., NI, J., LI, J., CHEN, J., YUAN, J., QIU, J., SONG, J., DONG, K., GAO, K., GUAN, K., WANG, L., ZHANG, L., XU, L., XIA, L., ZHAO, L., ZHANG, L., LI, M., WANG, M., ZHANG, M., ZHANG, M., TANG, M., LI, M., TIAN, N., HUANG, P., WANG, P., ZHANG, P., ZHU, Q., CHEN, Q., DU, Q., CHEN, R. J., JIN, R. L., GE, R., PAN, R., XU, R., CHEN, R., LI, S. S., LU, S., ZHOU, S., CHEN, S., WU, S., YE, S., MA, S., WANG, S., ZHOU, S., YU, S., ZHOU, S., ZHENG, S., WANG, T., PEI, T., YUAN, T., SUN, T., XIAO, W. L., ZENG, W., AN, W., LIU, W., LIANG, W., GAO, W., ZHANG, W., LI, X. Q., JIN, X., WANG, X., BI, X., LIU, X., WANG, X., SHEN, X., CHEN, X., CHEN, X., NIE, X., SUN, X., WANG, X., LIU, X., XIE, X., YU, X., SONG, X., ZHOU, X., YANG, X., LU, X., SU, X., WU, Y., LI, Y. K., WEI, Y. X., ZHU, Y. X., XU, Y., HUANG, Y., LI, Y., ZHAO, Y., SUN, Y., LI, Y., WANG, Y., ZHENG, Y., ZHANG, Y., XIONG, Y., ZHAO, Y., HE, Y., TANG, Y., PIAO, Y., DONG, Y., TAN, Y., LIU, Y., WANG, Y., GUO, Y., ZHU, Y., WANG, Y., ZOU, Y., ZHA, Y., MA, Y., YAN, Y., YOU, Y., LIU, Y., REN, Z. Z., REN, Z., SHA, Z., FU, Z., HUANG, Z., ZHANG, Z., XIE, Z., HAO, Z., SHAO, Z., WEN, Z., XU, Z., ZHANG, Z., LI, Z., WANG, Z., GU, Z., LI, Z., AND XIE, Z. Deepseek-v2: A strong, economical, and efficient mixture-of-experts language model, 2024.
- [31] DEGHANI, M., DJOLONGA, J., MUSTAFA, B., PADLEWSKI, P., HEEK, J., GILMER, J., STEINER, A. P., CARON, M., GEIRHOS, R., ALABDULMOHSIN, I., JENATTON, R., BEYER, L., TSCHANNEN, M., ARNAB, A., WANG, X., RIQUELME RUIZ, C., MINDERER, M., PUIGSERVER, J., EVCI, U., KUMAR, M., STEENKISTE, S. V., ELSAYED, G. F., MAHENDRAN, A., YU, F., OLIVER, A., HUOT, F., BASTINGS, J., COLLIER, M., GRITSENKO, A. A., BIRODKAR, V., VASCONCELOS, C. N., TAY, Y., MENSINK, T., KOLESNIKOV, A., PAVETIC, F., TRAN, D., KIPF, T., LUCIC, M., ZHAI, X., KEYSERS, D., HARMSSEN, J. J., AND HOULSBY, N. Scaling vision transformers to 22 billion parameters. In *Proceedings of the 40th International Conference on Machine Learning* (23–29 Jul 2023), A. Krause, E. Brunskill, K. Cho, B. Engelhardt, S. Sabato, and J. Scarlett, Eds., vol. 202 of *Proceedings of Machine Learning Research*, PMLR, pp. 7480–7512.
- [32] DING, Y., LIU, J., WEI, Y., ZHUO, T. Y., AND ZHANG, L. Xft: Unlocking the power of code instruction tuning by simply merging upcycled mixture-of-experts. *arXiv preprint arXiv:2404.15247* (2024).
- [33] DOSOVITSKIY, A. An image is worth 16x16 words: Transformers for image recognition at scale. *arXiv preprint arXiv:2010.11929* (2020).
- [34] DOU, S., ZHOU, E., LIU, Y., GAO, S., SHEN, W., XIONG, L., ZHOU, Y., WANG, X., XI, Z., FAN, X., ET AL. Loramoe: Alleviating world knowledge forgetting in large language models via moe-style plugin. In *Proceedings of the 62nd Annual Meeting of the Association for Computational Linguistics (Volume 1: Long Papers)* (2024), pp. 1932–1945.
- [35] DU, N., HUANG, Y., DAL, A. M., TONG, S., LEPIKHIN, D., XU, Y., KRIVUN, M., ZHOU, Y., YU, A. W., FIRAT, O., ET AL. Glam: Efficient scaling of language models with mixture-of-experts. In *International Conference on Machine Learning* (2022), PMLR, pp. 5547–5569.
- [36] DU, Z., LI, S., WU, Y., JIANG, X., SUN, J., ZHENG, Q., WU, Y., LI, A., LI, H., AND CHEN, Y. Sida: Sparsity-inspired data-aware serving for efficient and scalable large mixture-of-experts models. *Proceedings of Machine Learning and Systems 6* (2024), 224–238.
- [37] EIGEN, D., RANZATO, M., AND SUTSKEVER, I. Learning factored representations in a deep mixture of experts. *CoRR abs/1312.4314* (2013).
- [38] ELISEEV, A., AND MAZUR, D. Fast inference of mixture-of-experts language models with offloading. *arXiv preprint arXiv:2312.17238* (2023).
- [39] FAIZ, A., KANEDA, S., WANG, R., OSI, R., SHARMA, P., CHEN, F., AND JIANG, L. Llmcarbon: Modeling the end-to-end carbon footprint of large language models. *arXiv preprint arXiv:2309.14393* (2023).
- [40] FAN, Z., SARKAR, R., JIANG, Z., CHEN, T., ZOU, K., CHENG, Y., HAO, C., WANG, Z., ET AL. M3vit: Mixture-of-experts vision transformer for efficient multi-task learning with model-accelerator co-design. *Advances in Neural Information Processing Systems 35* (2022), 28441–28457.
- [41] FEDUS, W., DEAN, J., AND ZOPH, B. A review of sparse expert models in deep learning. *arXiv preprint arXiv:2209.01667* (2022).
- [42] FEDUS, W., ZOPH, B., AND SHAZEER, N. Switch transformers: Scaling to trillion parameter models with simple and efficient sparsity. *Journal of Machine Learning Research 23*, 120 (2022), 1–39.
- [43] FRANTAR, E., AND ALISTARH, D. Qmoe: Practical sub-1-bit compression of trillion-parameter models. *arXiv preprint arXiv:2310.16795* (2023).
- [44] FRANTAR, E., ASHKBOOS, S., HOEFLER, T., AND ALISTARH, D. Gptq: Accurate post-training quantization for generative pre-trained transformers. *arXiv preprint arXiv:2210.17323* (2022).
- [45] FU, Y., JIANG, Y., HUANG, Y., NIE, P., LU, Z., XUE, L., HE, C., SIT, M.-K., XUE, J., DONG, L., ET AL. Moe-cap: Cost-accuracy-performance benchmarking for mixture-of-experts systems. *arXiv preprint arXiv:2412.07067* (2024).
- [46] FU, Z., CHEN, F., ZHOU, S., LI, H., AND JIANG, L. Llmco2: Advancing accurate carbon footprint prediction for llm inferences. *arXiv preprint arXiv:2410.02950* (2024).
- [47] GAO, C., CHEN, K., RAO, J., SUN, B., LIU, R., PENG, D., ZHANG, Y., GUO, X., YANG, J., AND SUBRAHMANIAN, V. Higher layers need more lora experts. *arXiv preprint arXiv:2402.08562* (2024).
- [48] GAO, Z.-F., LIU, P., ZHAO, W. X., LU, Z.-Y., AND WEN, J.-R. Parameter-efficient mixture-of-experts architecture for pre-trained language models. *arXiv preprint arXiv:2203.01104* (2022).
- [49] GERGANOV, G. Llama.cpp, 2023.
- [50] GU, Y., DONG, L., WEI, F., AND HUANG, M. Knowledge distillation of large language models. *arXiv preprint arXiv:2306.08543* (2023).
- [51] GUO, Y., CHENG, Z., TANG, X., TU, Z., AND LIN, T. Dynamic mixture of experts: An auto-tuning approach for efficient transformer models. *arXiv preprint arXiv:2405.14297* (2024).

- [52] GUPTA, V., SINHA, K., GAVRILOVSKA, A., AND IYER, A. P. Lynx: Enabling efficient moe inference through dynamic batch-aware expert selection. *arXiv preprint arXiv:2411.08982* (2024).
- [53] HAMPSHIRE, J., AND WAIBEL, A. The meta-pi network: building distributed knowledge representations for robust multisource pattern recognition. *IEEE Transactions on Pattern Analysis and Machine Intelligence* 14, 7 (1992), 751–769.
- [54] HE, J., QIU, J., ZENG, A., YANG, Z., ZHAI, J., AND TANG, J. Fastmoe: A fast mixture-of-expert training system. *arXiv preprint arXiv:2103.13262* (2021).
- [55] HE, J., ZHAI, J., ANTUNES, T., WANG, H., LUO, F., SHI, S., AND LI, Q. Fastermoe: modeling and optimizing training of large-scale dynamic pre-trained models. In *Proceedings of the 27th ACM SIGPLAN Symposium on Principles and Practice of Parallel Programming* (New York, NY, USA, 2022), PPoPP '22, Association for Computing Machinery, p. 120–134.
- [56] HE, S., DONG, D., DING, L., AND LI, A. Demystifying the compression of mixture-of-experts through a unified framework. *arXiv preprint arXiv:2406.02500* (2024).
- [57] HE, S., FAN, R.-Z., DING, L., SHEN, L., ZHOU, T., AND TAO, D. Merging experts into one: Improving computational efficiency of mixture of experts. *arXiv preprint arXiv:2310.09832* (2023).
- [58] HE, X., ZHANG, S., WANG, Y., YIN, H., ZENG, Z., SHI, S., TANG, Z., CHU, X., TSANG, I., AND SOON, O. Y. Expertflow: Optimized expert activation and token allocation for efficient mixture-of-experts inference. *arXiv preprint arXiv:2410.17954* (2024).
- [59] HOU, X., XU, C., LI, C., LIU, J., TANG, X., CHENG, K.-T., AND GUO, M. Improving efficiency in multi-modal autonomous embedded systems through adaptive gating. *IEEE Transactions on Computers* (2024).
- [60] HUANG, H., ARDALANI, N., SUN, A., KE, L., LEE, H.-H. S., SRIDHAR, A., BHOSALE, S., WU, C.-J., AND LEE, B. Towards moe deployment: Mitigating inefficiencies in mixture-of-expert (moe) inference. *arXiv preprint arXiv:2303.06182* (2023).
- [61] HUANG, W., LIAO, Y., LIU, J., HE, R., TAN, H., ZHANG, S., LI, H., LIU, S., AND QI, X. Mc-moe: Mixture compressor for mixture-of-experts llms gains more. *arXiv preprint arXiv:2410.06270* (2024).
- [62] HUANG, Y., YE, P., HUANG, X., LI, S., CHEN, T., HE, T., AND OUYANG, W. Experts weights averaging: A new general training scheme for vision transformers. *arXiv preprint arXiv:2308.06093* (2023).
- [63] HUGGINGFACE. Llm-perf leaderboard, 2023.
- [64] HWANG, C., CUI, W., XIONG, Y., YANG, Z., LIU, Z., HU, H., WANG, Z., SALAS, R., JOSE, J., RAM, P., ET AL. Tutel: Adaptive mixture-of-experts at scale. *Proceedings of Machine Learning and Systems* 5 (2023), 269–287.
- [65] HWANG, R., WEI, J., CAO, S., HWANG, C., TANG, X., CAO, T., AND YANG, M. Pre-gated moe: An algorithm-system co-design for fast and scalable mixture-of-expert inference. In *2024 ACM/IEEE 51st Annual International Symposium on Computer Architecture (ISCA)* (2024), IEEE, pp. 1018–1031.
- [66] IBRAHIM, S., CHEN, W., HAZIMEH, H., PONOMAREVA, N., ZHAO, Z., AND MAZUMDER, R. Comet: Learning cardinality constrained mixture of experts with trees and local search. In *Proceedings of the 29th ACM SIGKDD Conference on Knowledge Discovery and Data Mining* (2023), pp. 832–844.
- [67] IMANI, H., AMIRANY, A., AND EL-GHAZAWI, T. Mixture of experts with mixture of precisions for tuning quality of service. *arXiv preprint arXiv:2407.14417* (2024).
- [68] JACOBS, R., JORDAN, M., NOWLAN, S., AND HINTON, G. Adaptive mixture of local expert. *Neural Computation* 3 (02 1991), 78–88.
- [69] JIA, Z., ZAHARIA, M., AND AIKEN, A. Beyond data and model parallelism for deep neural networks. *Proceedings of Machine Learning and Systems* 1 (2019), 1–13.
- [70] JIANG, A. Q., SABLAYROLLES, A., ROUX, A., MENSCH, A., SAVARY, B., BAMFORD, C., CHAPLOT, D. S., CASAS, D. D. L., HANNA, E. B., BRESSAND, F., ET AL. Mixtral of experts. *arXiv preprint arXiv:2401.04088* (2024).
- [71] JIN, P., ZHU, B., YUAN, L., AND YAN, S. Moe++: Accelerating mixture-of-experts methods with zero-computation experts. *arXiv preprint arXiv:2410.07348* (2024).
- [72] JIN, P., ZHU, B., YUAN, L., AND YAN, S. Moh: Multi-head attention as mixture-of-head attention. *arXiv preprint arXiv:2410.11842* (2024).
- [73] KAMAHORI, K., GU, Y., ZHU, K., AND KASIKCI, B. Fiddler: Cpu-gpu orchestration for fast inference of mixture-of-experts models. *arXiv preprint arXiv:2402.07033* (2024).
- [74] KAPLAN, J., MCCANDLISH, S., HENIGHAN, T., BROWN, T. B., CHESSE, B., CHILD, R., GRAY, S., RADFORD, A., WU, J., AND AMODEI, D. Scaling laws for neural language models. *arXiv preprint arXiv:2001.08361* (2020).
- [75] KIM, S., KIM, Y., MOON, K., AND JANG, M. Ladimo: Layer-wise distillation inspired moefier. *arXiv preprint arXiv:2408.04278* (2024).
- [76] KIM, T., CHOI, K., CHO, Y., CHO, J., LEE, H.-J., AND SIM, J. Monde: Mixture of near-data experts for large-scale sparse models. In *Proceedings of the 61st ACM/IEEE Design Automation Conference* (New York, NY, USA, 2024), DAC '24, Association for Computing Machinery.
- [77] KIM, Y. J., FAHIM, R., AND AWADALLA, H. H. Mixture of quantized experts (moqe): Complementary effect of low-bit quantization and robustness. *arXiv preprint arXiv:2310.02410* (2023).
- [78] KIM, Y. J., HENRY, R., FAHIM, R., AND AWADALLA, H. H. Who says elephants can't run: Bringing large scale moe models into cloud scale production. *arXiv preprint arXiv:2211.10017* (2022).
- [79] KONG, R., LI, Y., FENG, Q., WANG, W., KONG, L., AND LIU, Y. Serving moe models on resource-constrained edge devices via dynamic expert swapping. *arXiv preprint arXiv:2308.15030* (2023).
- [80] KWON, W., LI, Z., ZHUANG, S., SHENG, Y., ZHENG, L., YU, C. H., GONZALEZ, J. E., ZHANG, H., AND STOICA, I. Efficient memory management for large language model serving with pagedattention. In *Proceedings of the ACM SIGOPS 29th Symposium on Operating Systems Principles* (2023).
- [81] LEE, J., QIAO, A., CAMPOS, D. F., YAO, Z., HE, Y., ET AL. Stun: Structured-then-unstructured pruning for scalable moe pruning. *arXiv preprint arXiv:2409.06211* (2024).

- [82] LEPIKHIN, D., LEE, H., XU, Y., CHEN, D., FIRAT, O., HUANG, Y., KRICKUN, M., SHAZEER, N., AND CHEN, Z. Gshard: Scaling giant models with conditional computation and automatic sharding. *arXiv preprint arXiv:2006.16668* (2020).
- [83] LEWIS, M., BHOSALE, S., DETTMERS, T., GOYAL, N., AND ZETTLEMOYER, L. Base layers: Simplifying training of large, sparse models. In *International Conference on Machine Learning* (2021), PMLR, pp. 6265–6274.
- [84] LI, B., JIANG, Y., GADEPALLY, V., AND TIWARI, D. Llm inference serving: Survey of recent advances and opportunities. *arXiv preprint arXiv:2407.12391* (2024).
- [85] LI, J., JIANG, Y., ZHU, Y., WANG, C., AND XU, H. Accelerating distributed MoE training and inference with lina. In *2023 USENIX Annual Technical Conference (USENIX ATC 23)* (Boston, MA, July 2023), USENIX Association, pp. 945–959.
- [86] LI, J., SELVARAJU, R., GOTMARE, A., JOTY, S., XIONG, C., AND HOI, S. C. H. Align before fuse: Vision and language representation learning with momentum distillation. *Advances in neural information processing systems* 34 (2021), 9694–9705.
- [87] LI, J., SU, Q., YANG, Y., JIANG, Y., WANG, C., AND XU, H. Adaptive gating in mixture-of-experts based language models. *arXiv preprint arXiv:2310.07188* (2023).
- [88] LI, J., SUN, Z., HE, X., ZENG, L., LIN, Y., LI, E., ZHENG, B., ZHAO, R., AND CHEN, X. Locmoe: A low-overhead moe for large language model training. *arXiv preprint arXiv:2401.13920* (2024).
- [89] LI, J., TRIPATHI, S., RASTOGI, L., LEI, Y., PAN, R., AND XIA, Y. Optimizing mixture-of-experts inference time combining model deployment and communication scheduling. *arXiv preprint arXiv:2410.17043* (2024).
- [90] LI, J., XU, J., HUANG, S., CHEN, Y., LI, W., LIU, J., LIAN, Y., PAN, J., DING, L., ZHOU, H., ET AL. Large language model inference acceleration: A comprehensive hardware perspective. *arXiv preprint arXiv:2410.04466* (2024).
- [91] LI, M., GURURANGAN, S., DETTMERS, T., LEWIS, M., ALTHOFF, T., SMITH, N. A., AND ZETTLEMOYER, L. Branch-train-merge: Embarrassingly parallel training of expert language models. *arXiv preprint arXiv:2208.03306* (2022).
- [92] LI, P., JIN, X., CHENG, Y., AND CHEN, T. Examining post-training quantization for mixture-of-experts: A benchmark. *arXiv preprint arXiv:2406.08155* (2024).
- [93] LI, P., ZHANG, Z., YADAV, P., SUNG, Y.-L., CHENG, Y., BANSAL, M., AND CHEN, T. Merge, then compress: Demystify efficient smoe with hints from its routing policy. *arXiv preprint arXiv:2310.01334* (2023).
- [94] LI, Y., YU, Y., ZHANG, Q., LIANG, C., HE, P., CHEN, W., AND ZHAO, T. Lospars: Structured compression of large language models based on low-rank and sparse approximation. In *International Conference on Machine Learning* (2023), PMLR, pp. 20336–20350.
- [95] LIANG, Z., CHENG, J., YANG, R., REN, H., SONG, Z., WU, D., QIAN, X., LI, T., AND SHI, Y. Unleashing the potential of llms for quantum computing: A study in quantum architecture design. *arXiv preprint arXiv:2307.08191* (2023).
- [96] LIEBER, O., LENZ, B., BATA, H., COHEN, G., OSIN, J., DALMEDIGOS, I., SAFARI, E., MEIROM, S., BELINKOV, Y., SHALEV-SHWARTZ, S., ET AL. Jamba: A hybrid transformer-mamba language model. *arXiv preprint arXiv:2403.19887* (2024).
- [97] LIN, X., TIAN, H., XUE, W., MA, L., CAO, J., ZHANG, M., YU, J., AND WANG, K. Flame: Fully leveraging moe sparsity for transformer on fpga. In *Proceedings of the 61st ACM/IEEE Design Automation Conference* (New York, NY, USA, 2024), DAC '24, Association for Computing Machinery.
- [98] LIU, E., ZHU, J., LIN, Z., NING, X., BLASCHKO, M. B., YAN, S., DAI, G., YANG, H., AND WANG, Y. Efficient expert pruning for sparse mixture-of-experts language models: Enhancing performance and reducing inference costs. *arXiv preprint arXiv:2407.00945* (2024).
- [99] LIU, J., WANG, J. H., AND JIANG, Y. Janus: A unified distributed training framework for sparse mixture-of-experts models. In *Proceedings of the ACM SIGCOMM 2023 Conference* (New York, NY, USA, 2023), ACM SIGCOMM '23, Association for Computing Machinery, p. 486–498.
- [100] LIU, L., KIM, Y. J., WANG, S., LIANG, C., SHEN, Y., CHENG, H., LIU, X., TANAKA, M., WU, X., HU, W., ET AL. Grin: Gradient-informed moe. *arXiv preprint arXiv:2409.12136* (2024).
- [101] LIU, Q., WU, X., ZHAO, X., ZHU, Y., XU, D., TIAN, F., AND ZHENG, Y. Moelora: An moe-based parameter efficient fine-tuning method for multi-task medical applications. *arXiv preprint arXiv:2310.18339* (2023).
- [102] LIU, R., KIM, Y. J., MUZIO, A., AND HASSAN, H. Gating dropout: Communication-efficient regularization for sparsely activated transformers. In *International Conference on Machine Learning* (2022), PMLR, pp. 13782–13792.
- [103] LU, X., LIU, Q., XU, Y., ZHOU, A., HUANG, S., ZHANG, B., YAN, J., AND LI, H. Not all experts are equal: Efficient expert pruning and skipping for mixture-of-experts large language models. *arXiv preprint arXiv:2402.14800* (2024).
- [104] LUO, T., LEI, J., LEI, F., LIU, W., HE, S., ZHAO, J., AND LIU, K. Moelora: Contrastive learning guided mixture of experts on parameter-efficient fine-tuning for large language models. *arXiv preprint arXiv:2402.12851* (2024).
- [105] MA, Z., HE, J., QIU, J., CAO, H., WANG, Y., SUN, Z., ZHENG, L., WANG, H., TANG, S., ZHENG, T., LIN, J., FENG, G., HUANG, Z., GAO, J., ZENG, A., ZHANG, J., ZHONG, R., SHI, T., LIU, S., ZHENG, W., TANG, J., YANG, H., LIU, X., ZHAI, J., AND CHEN, W. Bagualu: targeting brain scale pretrained models with over 37 million cores. In *Proceedings of the 27th ACM SIGPLAN Symposium on Principles and Practice of Parallel Programming* (New York, NY, USA, 2022), PPOPP '22, Association for Computing Machinery, p. 192–204.
- [106] MAO, Y., YU, X., HUANG, K., ZHANG, Y.-J. A., AND ZHANG, J. Green edge ai: A contemporary survey. *Proceedings of the IEEE* (2024).
- [107] MEN, X., XU, M., ZHANG, Q., WANG, B., LIN, H., LU, Y., HAN, X., AND CHEN, W. Shortgpt: Layers in large language models are more redundant than you expect. *arXiv preprint arXiv:2403.03853* (2024).
- [108] MUENNIGHOFF, N., SOLDAINI, L., GROENEVELD, D., LO, K., MORRISON, J., MIN, S., SHI, W., WALSH, P., TAFJORD, O., LAMBERT, N., ET AL. Olmoe: Open mixture-of-experts language models. *arXiv preprint arXiv:2409.02060* (2024).
- [109] MUZIO, A., SUN, A., AND HE, C. Seer-moe: Sparse expert efficiency through regularization for mixture-of-experts. *arXiv preprint arXiv:2404.05089*

- (2024).
- [110] NARAYANAN, D., SHOEBI, M., CASPER, J., LEGRSLEY, P., PATWARY, M., KORTHIKANTI, V., VAINBRAND, D., KASHINKUNTI, P., BERNAUER, J., CATANZARO, B., ET AL. Efficient large-scale language model training on gpu clusters using megatron-1m. In *Proceedings of the International Conference for High Performance Computing, Networking, Storage and Analysis* (2021), pp. 1–15.
 - [111] NGUYEN, N. V., DOAN, T. T., TRAN, L., NGUYEN, V., AND PHAM, Q. Libmoe: A library for comprehensive benchmarking mixture of experts in large language models. *arXiv preprint arXiv:2411.00918* (2024).
 - [112] NIE, X., MIAO, X., WANG, Z., YANG, Z., XUE, J., MA, L., CAO, G., AND CUI, B. Flexmoe: Scaling large-scale sparse pre-trained model training via dynamic device placement. *Proceedings of the ACM on Management of Data* 1, 1 (2023), 1–19.
 - [113] NIE, X., ZHAO, P., MIAO, X., ZHAO, T., AND CUI, B. Hetumoe: An efficient trillion-scale mixture-of-expert distributed training system. *arXiv preprint arXiv:2203.14685* (2022).
 - [114] NING, S., ZHU, H., FENG, C., GU, J., JIANG, Z., YING, Z., MIDKIFF, J., JAIN, S., HLAING, M. H., PAN, D. Z., ET AL. Photonic-electronic integrated circuits for high-performance computing and ai accelerators. *Journal of Lightwave Technology* (2024).
 - [115] OUYANG, L., WU, J., JIANG, X., ALMEIDA, D., WAINWRIGHT, C., MISHKIN, P., ZHANG, C., AGARWAL, S., SLAMA, K., RAY, A., ET AL. Training language models to follow instructions with human feedback. *Advances in neural information processing systems* 35 (2022), 27730–27744.
 - [116] PADMANABAN, H. Quantum computing and ai in the cloud. *Journal of Computational Intelligence and Robotics* 4, 1 (2024), 14–32.
 - [117] PAN, B., SHEN, Y., LIU, H., MISHRA, M., ZHANG, G., OLIVA, A., RAFFEL, C., AND PANDA, R. Dense training, sparse inference: Rethinking training of mixture-of-experts language models. *arXiv preprint arXiv:2404.05567* (2024).
 - [118] PAN, X., LIN, W., SHI, S., CHU, X., SUN, W., AND LI, B. Parm: Efficient training of large sparsely-activated models with dedicated schedules. In *IEEE INFOCOM 2024 - IEEE Conference on Computer Communications* (2024), pp. 1880–1889.
 - [119] PARK, G., SONG, S., SANG, H., IM, D., HAN, D., KIM, S., LEE, H., AND YOO, H.-J. 20.8 space-mate: A 303.5mw real-time sparse mixture-of-experts-based nerf-slam processor for mobile spatial computing. In *2024 IEEE International Solid-State Circuits Conference (ISSCC)* (2024), vol. 67, pp. 374–376.
 - [120] PARK, S. Learning more generalized experts by merging experts in mixture-of-experts. *arXiv preprint arXiv:2405.11530* (2024).
 - [121] PENG, H., SCHWARTZ, R., LI, D., AND SMITH, N. A. A mixture of h - 1 heads is better than h heads. In *Proceedings of the 58th Annual Meeting of the Association for Computational Linguistics* (Online, July 2020), D. Jurafsky, J. Chai, N. Schluter, and J. Tetreault, Eds., Association for Computational Linguistics, pp. 6566–6577.
 - [122] QIAN, Y., LI, F., JI, X., ZHAO, X., TAN, J., ZHANG, K., AND CAI, X. Eps-moe: Expert pipeline scheduler for cost-efficient moe inference. *arXiv preprint arXiv:2410.12247* (2024).
 - [123] RADFORD, A., KIM, J. W., HALLACY, C., RAMESH, A., GOH, G., AGARWAL, S., SASTRY, G., ASKELL, A., MISHKIN, P., CLARK, J., ET AL. Learning transferable visual models from natural language supervision. In *International conference on machine learning* (2021), PMLR, pp. 8748–8763.
 - [124] RADOVANOVIĆ, A., KONINGSTEIN, R., SCHNEIDER, I., CHEN, B., DUARTE, A., ROY, B., XIAO, D., HARIDASAN, M., HUNG, P., CARE, N., ET AL. Carbon-aware computing for datacenters. *IEEE Transactions on Power Systems* 38, 2 (2022), 1270–1280.
 - [125] RAJBHANDARI, S., LI, C., YAO, Z., ZHANG, M., AMINABADI, R. Y., AWAN, A. A., RASLEY, J., AND HE, Y. DeepSpeed-moe: Advancing mixture-of-experts inference and training to power next-generation AI scale. In *Proceedings of the 39th International Conference on Machine Learning (17–23 Jul 2022)*, K. Chaudhuri, S. Jegelka, L. Song, C. Szepesvari, G. Niu, and S. Sabato, Eds., vol. 162 of *Proceedings of Machine Learning Research*, PMLR, pp. 18332–18346.
 - [126] RAJBHANDARI, S., RASLEY, J., RUWASE, O., AND HE, Y. Zero: Memory optimizations toward training trillion parameter models. In *SC20: International Conference for High Performance Computing, Networking, Storage and Analysis* (2020), IEEE, pp. 1–16.
 - [127] RAMAN, R., PATNAIK, D., LATHABAI, H. H., KUMAR, C., GOVINDAN, K., AND NEDUNGADI, P. Green and sustainable ai research: an integrated thematic and topic modeling analysis. *Journal of Big Data* 11, 1 (2024), 55.
 - [128] REDDI, V. J., CHENG, C., KANTER, D., MATTSON, P., SCHMUELLING, G., WU, C.-J., ANDERSON, B., BREUGHE, M., CHARLEBOIS, M., CHOU, W., ET AL. Mlperf inference benchmark. In *2020 ACM/IEEE 47th Annual International Symposium on Computer Architecture (ISCA)* (2020), IEEE, pp. 446–459.
 - [129] REN, J., XU, D., YANG, S., ZHAO, J., LI, Z., NAVASCA, C., WANG, C., XU, H., AND LI, D. Enabling large dynamic neural network training with learning-based memory management. In *2024 IEEE International Symposium on High-Performance Computer Architecture (HPCA)* (2024), pp. 788–802.
 - [130] RESEARCH, S. A. Snowflake arctic: The best llm for enterprise ai – efficiently intelligent, truly open, April 2024.
 - [131] ROLLER, S., SUKHAATAR, S., WESTON, J., ET AL. Hash layers for large sparse models. *Advances in Neural Information Processing Systems* 34 (2021), 17555–17566.
 - [132] SALINAS, F. C., KUMATANI, K., GMYR, R., LIU, L., AND SHI, Y. Knowledge distillation for mixture of experts models in speech recognition. Tech. rep., Technical Report MSR-TR-2022-6, Microsoft Research, May 2022. [https://www ...](https://www...), 2022.
 - [133] SARKAR, R., LIANG, H., FAN, Z., WANG, Z., AND HAO, C. Edge-moe: Memory-efficient multi-task vision transformer architecture with task-level sparsity via mixture-of-experts. In *2023 IEEE/ACM International Conference on Computer Aided Design (ICCAD)* (2023), pp. 01–09.
 - [134] SARKAR, S., LAUSEN, L., CEVHER, V., ZHA, S., BROX, T., AND KARYPIS, G. Revisiting smoe language models by evaluating inefficiencies with task specific expert pruning. *arXiv preprint arXiv:2409.01483* (2024).
 - [135] SCHUMAN, C. D., KULKARNI, S. R., PARSA, M., MITCHELL, J. P., DATE, P., AND KAY, B. Opportunities for neuromorphic computing algorithms and applications. *Nature Computational Science* 2, 1 (2022), 10–19.
 - [136] SCHUMAN, C. D., POTOK, T. E., PATTON, R. M., BIRDWELL, J. D., DEAN, M. E., ROSE, G. S., AND PLANK, J. S. A survey of neuromorphic computing and neural networks in hardware. *arXiv preprint arXiv:1705.06963* (2017).

- [137] SHAZEER, N., MIRHOSEINI, A., MAZIARZ, K., DAVIS, A., LE, Q., HINTON, G., AND DEAN, J. Outrageously large neural networks: The sparsely-gated mixture-of-experts layer. *arXiv preprint arXiv:1701.06538* (2017).
- [138] SHEN, Y., GUO, Z., CAI, T., AND QIN, Z. Jetmoe: Reaching llama2 performance with 0.1 m dollars. *arXiv preprint arXiv:2404.07413* (2024).
- [139] SHEN, Y., ZHANG, Z., CAO, T., TAN, S., CHEN, Z., AND GAN, C. Moduleformer: Learning modular large language models from uncurated data. *arXiv preprint arXiv:2306.04640* (2023).
- [140] SHI, S., PAN, X., CHU, X., AND LI, B. Pipemoe: Accelerating mixture-of-experts through adaptive pipelining. In *IEEE INFOCOM 2023 - IEEE Conference on Computer Communications* (2023), pp. 1–10.
- [141] SHI, S., PAN, X., WANG, Q., LIU, C., REN, X., HU, Z., YANG, Y., LI, B., AND CHU, X. Schemoe: An extensible mixture-of-experts distributed training system with tasks scheduling. In *Proceedings of the Nineteenth European Conference on Computer Systems* (New York, NY, USA, 2024), EuroSys '24, Association for Computing Machinery, p. 236–249.
- [142] SHU, F., LIAO, Y., ZHUO, L., XU, C., ZHANG, L., ZHANG, G., SHI, H., CHEN, L., ZHONG, T., HE, W., ET AL. Llava-mod: Making llava tiny via moe knowledge distillation. *arXiv preprint arXiv:2408.15881* (2024).
- [143] SINGH, S., RUWASE, O., AWAN, A. A., RAJBHANDARI, S., HE, Y., AND BHATELE, A. A hybrid tensor-expert-data parallelism approach to optimize mixture-of-experts training. In *Proceedings of the 37th International Conference on Supercomputing* (2023), pp. 203–214.
- [144] SONG, X., ZHONG, Z., AND CHEN, R. Promoe: Fast moe-based llm serving using proactive caching. *arXiv preprint arXiv:2410.22134* (2024).
- [145] STEANE, A. Quantum computing. *Reports on Progress in Physics* 61, 2 (1998), 117.
- [146] SUKHBAATAR, S., GOLOVNEVA, O., SHARMA, V., XU, H., LIN, X. V., ROZIÈRE, B., KAHN, J., LI, D., YIH, W.-T., WESTON, J., ET AL. Branch-train-mix: Mixing expert llms into a mixture-of-experts llm. *arXiv preprint arXiv:2403.07816* (2024).
- [147] SUN, M., MA, H., KANG, G., JIANG, Y., CHEN, T., MA, X., WANG, Z., AND WANG, Y. Vaqf: Fully automatic software-hardware co-design framework for low-bit vision transformer. *arXiv preprint arXiv:2201.06618* (2022).
- [148] SUN, X., CHEN, Y., HUANG, Y., XIE, R., ZHU, J., ZHANG, K., LI, S., YANG, Z., HAN, J., SHU, X., ET AL. Hunyuan-large: An open-source moe model with 52 billion activated parameters by.tencent. *arXiv preprint arXiv:2411.02265* (2024).
- [149] TAN, S., SHEN, Y., CHEN, Z., COURVILLE, A., AND GAN, C. Sparse universal transformer. *arXiv preprint arXiv:2310.07096* (2023).
- [150] TANG, P., LIU, J., HOU, X., PU, Y., WANG, J., HENG, P.-A., LI, C., AND GUO, M. Hobbit: A mixed precision expert offloading system for fast moe inference. *arXiv preprint arXiv:2411.01433* (2024).
- [151] TEAM, G., GEORGIEV, P., LEI, V. I., BURNELL, R., BAI, L., GULATI, A., TANZER, G., VINCENT, D., PAN, Z., WANG, S., ET AL. Gemini 1.5: Unlocking multimodal understanding across millions of tokens of context. *arXiv preprint arXiv:2403.05530* (2024).
- [152] TEAM, G. B. Tensorflow, 2024.
- [153] TEAM, Q. Qwen1.5-moe: Matching 7b model performance with 1/3 activated parameters", February 2024.
- [154] TEAM, T. M. R. Introducing dbrx: A new state-of-the-art open llm, March 2024.
- [155] TRESP, V. Mixtures of gaussian processes. In *Advances in Neural Information Processing Systems* (2000), T. Leen, T. Dietterich, and V. Tresp, Eds., vol. 13, MIT Press.
- [156] TREVISI, M., LEE, J.-U., JI, T., AKEN, B. v., CAO, Q., CIOSICI, M. R., HASSID, M., HEAFIELD, K., HOOKER, S., RAFFEL, C., ET AL. Efficient methods for natural language processing: A survey. *Transactions of the Association for Computational Linguistics* 11 (2023), 826–860.
- [157] VASWANI, A. Attention is all you need. *Advances in Neural Information Processing Systems* (2017).
- [158] VATS, A., RAJA, R., JAIN, V., AND CHADHA, A. The evolution of mixture of experts: A survey from basics to breakthroughs. *Preprints* (August 2024).
- [159] WAN, Z., WANG, X., LIU, C., ALAM, S., ZHENG, Y., LIU, J., QU, Z., YAN, S., ZHU, Y., ZHANG, Q., ET AL. Efficient large language models: A survey. *arXiv preprint arXiv:2312.03863* (2023).
- [160] WANG, H., MA, S., DONG, L., HUANG, S., WANG, H., MA, L., YANG, F., WANG, R., WU, Y., AND WEI, F. Bitnet: Scaling 1-bit transformers for large language models. *arXiv preprint arXiv:2310.11453* (2023).
- [161] WANG, H., POLO, F. M., SUN, Y., KUNDU, S., XING, E., AND YUROCHKIN, M. Fusing models with complementary expertise. *arXiv preprint arXiv:2310.01542* (2023).
- [162] WANG, P., YANG, A., MEN, R., LIN, J., BAI, S., LI, Z., MA, J., ZHOU, C., ZHOU, J., AND YANG, H. Ofa: Unifying architectures, tasks, and modalities through a simple sequence-to-sequence learning framework. In *International conference on machine learning* (2022), PMLR, pp. 23318–23340.
- [163] WANG, W., LAI, Z., LI, S., LIU, W., GE, K., LIU, Y., SHEN, A., AND LI, D. Prophet: Fine-grained load balancing for parallel training of large-scale moe models. In *2023 IEEE International Conference on Cluster Computing (CLUSTER)* (2023), pp. 82–94.
- [164] WANG, X., YU, F., DUNLAP, L., MA, Y.-A., WANG, R., MIRHOSEINI, A., DARRELL, T., AND GONZALEZ, J. E. Deep mixture of experts via shallow embedding. In *Uncertainty in artificial intelligence* (2020), PMLR, pp. 552–562.
- [165] WANG, X., ZHENG, Y., WAN, Z., AND ZHANG, M. Svd-llm: Truncation-aware singular value decomposition for large language model compression. *arXiv preprint arXiv:2403.07378* (2024).
- [166] WEI, T., ZHU, B., ZHAO, L., CHENG, C., LI, B., LÜ, W., CHENG, P., ZHANG, J., ZHANG, X., ZENG, L., ET AL. Skywork-moe: A deep dive into training techniques for mixture-of-experts language models. *arXiv preprint arXiv:2406.06563* (2024).
- [167] WU, S., LUO, J., CHEN, X., LI, L., ZHAO, X., YU, T., WANG, C., WANG, Y., WANG, F., QIAO, W., ET AL. Yuan 2.0-m32: Mixture of experts with attention router. *arXiv preprint arXiv:2405.17976* (2024).
- [168] WU, Y., QU, W., TAO, T., WANG, Z., BAI, W., LI, Z., TIAN, Y., ZHANG, J., LENTZ, M., AND ZHUO, D. Lazarus: Resilient and elastic training of mixture-of-experts models with adaptive expert placement. *arXiv preprint arXiv:2407.04656* (2024).

- [169] xAI. Open release of grok-1, March 2024.
- [170] XIE, Y., ZHANG, Z., ZHOU, D., XIE, C., SONG, Z., LIU, X., WANG, Y., LIN, X., AND XU, A. Moe-pruner: Pruning mixture-of-experts large language model using the hints from its router. *arXiv preprint arXiv:2410.12013* (2024).
- [171] XIONG, D., ET AL. Scormoe: Efficient mixtures of experts with structured communication. In *The Eleventh International Conference on Learning Representations*.
- [172] XU, C., HOU, X., LIU, J., LI, C., HUANG, T., ZHU, X., NIU, M., SUN, L., TANG, P., XU, T., ET AL. Mmbench: Benchmarking end-to-end multi-modal dnns and understanding their hardware-software implications. In *2023 IEEE International Symposium on Workload Characterization (IISWC) (2023)*, IEEE, pp. 154–166.
- [173] XU, M., YIN, W., CAI, D., YI, R., XU, D., WANG, Q., WU, B., ZHAO, Y., YANG, C., WANG, S., ET AL. A survey of resource-efficient llm and multimodal foundation models. *arXiv preprint arXiv:2401.08092* (2024).
- [174] XUE, F., HE, X., REN, X., LOU, Y., AND YOU, Y. One student knows all experts know: From sparse to dense. *arXiv preprint arXiv:2201.10890* (2022).
- [175] XUE, F., ZHENG, Z., FU, Y., NI, J., ZHENG, Z., ZHOU, W., AND YOU, Y. Openmoe: An early effort on open mixture-of-experts language models. *arXiv preprint arXiv:2402.01739* (2024).
- [176] XUE, L., FU, Y., LU, Z., MAI, L., AND MARINA, M. Moe-infinity: Activation-aware expert offloading for efficient moe serving. *arXiv preprint arXiv:2401.14361* (2024).
- [177] YANG, A., YANG, B., HUI, B., ZHENG, B., YU, B., ZHOU, C., LI, C., LI, C., LIU, D., HUANG, F., ET AL. Qwen2 technical report. *arXiv preprint arXiv:2407.10671* (2024).
- [178] YANG, C., SUI, Y., XIAO, J., HUANG, L., GONG, Y., DUAN, Y., JIA, W., YIN, M., CHENG, Y., AND YUAN, B. Moe-i2: Compressing mixture of experts models through inter-expert pruning and intra-expert low-rank decomposition. *arXiv preprint arXiv:2411.01016* (2024).
- [179] YANG, Y., QI, S., GU, W., WANG, C., GAO, C., AND XU, Z. Xmoe: Sparse models with fine-grained and adaptive expert selection. In *Findings of the Association for Computational Linguistics ACL 2024* (2024), pp. 11664–11674.
- [180] YAO, J., ANTHONY, Q., SHAFI, A., SUBRAMONI, H., AND PANDA, D. K. D. Exploiting inter-layer expert affinity for accelerating mixture-of-experts model inference. In *2024 IEEE International Parallel and Distributed Processing Symposium (IPDPS) (2024)*, IEEE, pp. 915–925.
- [181] YI, R., GUO, L., WEI, S., ZHOU, A., WANG, S., AND XU, M. Edgemoe: Fast on-device inference of moe-based large language models. *arXiv preprint arXiv:2308.14352* (2023).
- [182] YOU, H., SUN, Z., SHI, H., YU, Z., ZHAO, Y., ZHANG, Y., LI, C., LI, B., AND LIN, Y. Vitcod: Vision transformer acceleration via dedicated algorithm and accelerator co-design. In *2023 IEEE International Symposium on High-Performance Computer Architecture (HPCA) (2023)*, IEEE, pp. 273–286.
- [183] YU, D., SHEN, L., HAO, H., GONG, W., WU, H., BIAN, J., DAI, L., AND XIONG, H. Moesys: A distributed and efficient mixture-of-experts training and inference system for internet services. *IEEE Transactions on Services Computing* 17, 5 (2024), 2626–2639.
- [184] YUAN, X., KONG, W., LUO, Z., AND XU, M. Efficient inference offloading for mixture-of-experts large language models in internet of medical things. *Electronics* 13, 11 (2024), 2077.
- [185] YUAN, Y., YOU, Z., FENG, S., SU, D., LIANG, Y., SHI, X., AND YU, D. Compressed moe asr model based on knowledge distillation and quantization.
- [186] YUAN, Z., SHANG, Y., SONG, Y., WU, Q., YAN, Y., AND SUN, G. Asvd: Activation-aware singular value decomposition for compressing large language models. *arXiv preprint arXiv:2312.05821* (2023).
- [187] YUAN, Z., SHANG, Y., ZHOU, Y., DONG, Z., ZHOU, Z., XUE, C., WU, B., LI, Z., GU, Q., LEE, Y. J., ET AL. Llm inference unveiled: Survey and roofline model insights. *arXiv preprint arXiv:2402.16363* (2024).
- [188] YUN, S., KYUNG, K., CHO, J., CHOI, J., KIM, J., KIM, B., LEE, S., SOHN, K., AND AHN, J. H. Duplex: A device for large language models with mixture of experts, grouped query attention, and continuous batching. *MICRO* (2024).
- [189] ZHAI, M., HE, J., MA, Z., ZONG, Z., ZHANG, R., AND ZHAI, J. SmartMoE: Efficiently training Sparsely-Activated models through combining offline and online parallelization. In *2023 USENIX Annual Technical Conference (USENIX ATC 23)* (Boston, MA, July 2023), USENIX Association, pp. 961–975.
- [190] ZHANG, Q., GRITSCH, N., GNANESHWAR, D., GUO, S., CAIRUZ, D., VENKITESH, B., FOERSTER, J., BLUNSOM, P., RUDER, S., USTUN, A., ET AL. Bam! just like that: Simple and efficient parameter upcycling for mixture of experts. *arXiv preprint arXiv:2408.08274* (2024).
- [191] ZHANG, S., DIAO, L., WU, C., WANG, S., AND LIN, W. Accelerating large-scale distributed neural network training with spmd parallelism. In *Proceedings of the 13th Symposium on Cloud Computing* (2022), pp. 403–418.
- [192] ZHANG, X., SHEN, Y., HUANG, Z., ZHOU, J., RONG, W., AND XIONG, Z. Mixture of attention heads: Selecting attention heads per token. *arXiv preprint arXiv:2210.05144* (2022).
- [193] ZHANG, Z., LIU, X., CHENG, H., XU, C., AND GAO, J. Diversifying the expert knowledge for task-agnostic pruning in sparse mixture-of-experts. *arXiv preprint arXiv:2407.09590* (2024).
- [194] ZHANG, Z., LU, X., CAO, G., YANG, Y., JIAO, L., AND LIU, F. Vit-yolo: Transformer-based yolo for object detection. In *Proceedings of the IEEE/CVF international conference on computer vision* (2021), pp. 2799–2808.
- [195] ZHENG, L., LI, Z., ZHANG, H., ZHUANG, Y., CHEN, Z., HUANG, Y., WANG, Y., XU, Y., ZHUO, D., XING, E. P., GONZALEZ, J. E., AND STOICA, I. Alpa: Automating inter- and Intra-Operator parallelism for distributed deep learning. In *16th USENIX Symposium on Operating Systems Design and Implementation (OSDI 22)* (Carlsbad, CA, July 2022), USENIX Association, pp. 559–578.
- [196] ZHONG, S., LIANG, L., WANG, Y., WANG, R., HUANG, R., AND LI, M. Adapmoe: Adaptive sensitivity-based expert gating and management for efficient moe inference. *arXiv preprint arXiv:2408.10284* (2024).
- [197] ZHOU, M., XU, W., KANG, J., AND ROSING, T. Transpim: A memory-based acceleration via software-hardware co-design for transformer. In *2022*

- IEEE International Symposium on High-Performance Computer Architecture (HPCA)* (2022), pp. 1071–1085.
- [198] ZHOU, Y., LEI, T., LIU, H., DU, N., HUANG, Y., ZHAO, V., DAI, A. M., LE, Q. V., LAUDON, J., ET AL. Mixture-of-experts with expert choice routing. *Advances in Neural Information Processing Systems 35* (2022), 7103–7114.
- [199] ZHOU, Z., NING, X., HONG, K., FU, T., XU, J., LI, S., LOU, Y., WANG, L., YUAN, Z., LI, X., ET AL. A survey on efficient inference for large language models. *arXiv preprint arXiv:2404.14294* (2024).
- [200] ZHU, H., GU, J., WANG, H., JIANG, Z., ZHANG, Z., TANG, R., FENG, C., HAN, S., CHEN, R. T., AND PAN, D. Z. Lightening-transformer: A dynamically-operated optically-interconnected photonic transformer accelerator. In *2024 IEEE International Symposium on High-Performance Computer Architecture (HPCA)* (2024), IEEE, pp. 686–703.
- [201] ZHU, T., QU, X., DONG, D., RUAN, J., TONG, J., HE, C., AND CHENG, Y. Llama-moe: Building mixture-of-experts from llama with continual pre-training. In *Proceedings of the 2024 Conference on Empirical Methods in Natural Language Processing* (2024), pp. 15913–15923.

Received 20 February 2007; revised 12 March 2009; accepted 5 June 2009