

INVERSE SCATTERING PROBLEMS FOR NON-LINEAR WAVE EQUATIONS ON LORENTZIAN MANIFOLDS

SPYROS ALEXAKIS, HIROSHI ISOZAKI, MATTI LASSAS, TEEMU TYNI

ABSTRACT. We show that an inverse scattering problem for a semilinear wave equation can be solved on a manifold having an asymptotically Minkowskian infinity, that is, scattering functionals determine the topology, differentiable structure, and the conformal type of the manifold. Moreover, the metric and the coefficient of the non-linearity are determined up to a multiplicative transformation. The manifold on which the inverse problem is considered is allowed to be an open, globally hyperbolic manifold which may have non-trivial topology or several infinities (i.e., ends) of which at least one has to be of the asymptotically Minkowskian type. To formulate the inverse problems we define a new type of data, non-linear scattering functionals, which are defined also in the cases where the classically defined scattering operators are not well-defined. This makes it possible to solve inverse problems also in cases where some of the incoming waves lead to a blow-up of the scattered solution. We use non-linear interaction of waves as a beneficial tool that helps to solve the inverse problem. The corresponding inverse problem for the linear wave equation still remains unsolved.

Keywords: Inverse scattering problem, semilinear wave equation.

CONTENTS

1. Introduction: inverse scattering problems	2
1.1. A simplified scattering problem	4
1.2. Scattering functionals and manifolds with an asymptotically Minkowskian infinity	7
1.3. Main result	13
1.4. Examples	15
1.5. Reduction of the scattering measurements to the near field measurements in the extended space-time	19
1.6. Structure of the proofs of the main theorems	20
1.7. Generalizations of the inverse scattering problem for FLRW space-times	21
2. Geometric properties and notations	24
3. Scattering functionals and the source-to-solution operator	29
3.1. Existence of scattering functionals	29
3.2. Scattering functionals determine the source-to-solution operator	33
4. Microlocal analysis of the source-to-solution operator	34
5. Proof of the main theorem	45
Appendix A. Energy inequality for a nonlinear wave equation	56
References	64

Date: January 14, 2025.

1. INTRODUCTION: INVERSE SCATTERING PROBLEMS

In this work we consider scattering problems for non-linear wave equations on Lorentzian manifolds. Examples of scattering problems include radar, seismic and optical imaging [21, 22, 23, 110] and theory of experiments in particle physics, see [61, 100]. In typical linear cases, scattering problems [13, 50, 51, 90] are formulated in asymptotically flat space-times (\mathbb{R}^{3+1}, g) for linear wave equations $\square_g u = 0$ as the task of recovering information about the space-time metric g from measurements of the scattering operator $S : u_- \mapsto u_+$. Here $u_{\pm}(s, \theta) = \lim_{t \rightarrow \pm\infty} |t|^{(3-1)/2} u(t + s, t\theta)$, $s \in \mathbb{R}$, are the past and future radiation fields. The geometrical formulation of inverse scattering problems have been studied e.g. in [46, 62, 63, 108] for a linear wave equation with a time-independent metric. Inverse scattering problems for non-linear wave equations with a known metric and unknown non-linear term has been studied in [55, 56, 103, 109].

The work [75] introduced a method now known as the higher order linearization method to inverse problems for nonlinear equations. The method is based on self-interaction of waves in the presence of non-linearities, and has successfully been used to solve many inverse problems from local measurements (see e.g. [24, 40, 70, 80] for elliptic problems and [79, 81, 82, 83] for wave equations). Such methods are not available for linear wave equations, where the existing uniqueness results are limited to manifolds that are close to subsets of Minkowski space [2, 3], or have a time-independent or real-analytic metric [37]. For the latter case the results are based on Tataru's unique continuation theorem [114], and these results have been shown to fail for general metric tensors that are not analytic in the time variable [4].

In [27, 39, 74, 75] inverse problems with near-field measurements have been studied for non-linear wave equations, e.g., of the form

$$(1) \quad \sum_{j,k=0}^3 g^{jk}(x) \frac{\partial^2 u}{\partial x^j \partial x^k}(x) + a(x)u(x)^\kappa = f(x)$$

where $x = (x^0, x^1, x^2, x^3) = (t, y) \in \mathbb{R}^{1+3}$, $x^0 = t$ is the time-variable and $g^{jk}(x)$ is a Lorentzian metric. For this equation one can consider an open set $V \subset \mathbb{R}^{1+3}$ and the *source-to-solution map* $L : f \rightarrow u|_V$ that maps a (sufficiently small) source f supported in the set V to the restriction $u|_V$ of the corresponding solution u of (1). This map is similar to the Dirichlet-to-Neumann map or the Cauchy data set, often used in the study inverse boundary value problems [67, 68, 112, 113, 116] for conductivity equation, [41, 47, 67, 68, 95, 96, 113] for Schrödinger equation and [47] for Laplace-Beltrami equation and [34, 97, 106, 111] for general real principal type operators and systems. On counterexamples, see [32, 86]. The work [75] studied the question of which the (local) source-to-solution operator uniquely determine the metric $g^{jk}(x)$ in a maximal set $W \subset \mathbb{R}^{1+3}$ to which causal signals can propagate from V and return to V . Using non-linearity as a beneficial tool, inverse problems have been solved for several hyperbolic equations, for example [33, 93, 104, 117, 127] for wave equation and [36] of Westervelt equation, and [6, 7, 117, 118, 128] for hyperbolic systems of equations. Some physically motivated works are [74] and [27, 28, 39], where inverse problems for the

Einstein and Yang-Mills equations were considered, respectively. Related questions have also been studied in [70, 71, 72, 73, 78] for elliptic equations. There are also results for the Boltzmann equation [10, 76, 77] and non-linear parabolic equations [38].

In inverse scattering problems on Lorentzian manifolds, a motivating problem are wave scattering on a black hole [14, 16, 54] and the Doppler ultrasound imaging in moving medium [42] (on non-linear models used in ultrasound imaging, see [1, 36, 119]). Our space-times will allow the causal structure of black hole exteriors, and in fact will allow multiple (asymptotically Minkowskian) “ends”, and also multiple event horizons. However we should make clear that we expect that the space-times we consider cannot be solutions to Einstein’s equations with reasonable matter models. (For those with a complete maximal Cauchy surface, this is because their ADM energy will be zero.) Nonetheless, traditional notions of general relativity such as null infinities \mathcal{I}^+ , \mathcal{I}^- , and event horizons continue to make sense. So we adopt this terminology here.

The present paper has two goals: The first one is to consider inverse scattering problems in a more general setting than is traditionally done and introduce a new type of limited scattering data, the *scattering functionals* (see Definition 4 below). In the study of scattering (and inverse scattering) for quasilinear equations (such as the Einstein equations) with incoming data coming from past null infinity on encounters several technical problems; among many other difficulties, one has the possibility of the causal structure of the space-time changing because of the quasilinearity. (The dynamical formation of black holes being one such example.) Even restricting to semi-linear equations, one may not be able to define a scattering map due to the finite-time breakdown of the solutions. Yet the traditional definition of the scattering operator [61, 85, 87, 89], see also [8, 9, 115] on non-linear problems, requires global existence of solutions. To consider inverse problems in such potentially unstable physical systems where global existence of solutions may fail, we define the scattering functionals on incoming data that are suitably small. These form a more limited data set which exists even in the case when the solutions may not exist globally – The scattering functionals share the same feature as the generalized curvature used in synthetic non-smooth geometry (see [124]): The scattering functionals are equivalent to the scattering operator when it is well-defined, but the scattering functionals are defined also in more general settings.

Below, we will consider Lorentzian manifolds that are assumed to be globally hyperbolic. Note that this is a standard condition that guarantees that hyperbolic equations have local solutions with compactly supported sources. We will show that using the scattering functionals, it is possible to reconstruct the topology of the manifold and the conformal class of its metric under the assumption that the manifold has at least one asymptotically Minkowskian infinity, and that the whole space-time is causally connected to this infinity in the future and the past. The scattering functional are associated to using small amplitude in-going waves and observing their scattering on a *portion* of future null infinity. We remark that the produced waves may well blow up somewhere in space-time; the key idea is that we observe their

scattering data at only a part of the future light-like infinity \mathcal{I}^+ prior to any potential blow-up.

The second goal of the paper is to show that the inverse scattering problems can be reduced to inverse problems for near field observations, including the case when the perturbation of the metric is not compactly supported. For linear equations, inverse scattering problems and inverse problems with near field measurements are in many cases equivalent [17], while for the non-linear equations the relation of these problems is not understood. In this paper our aim is to develop a *general method to reduce inverse scattering problems to near-field problems*. This method could be used to solve many classical inverse scattering problems for non-linear models. Our approach is based on the Penrose compactification of the space-time. There, the non-compact Lorentzian manifold (\mathbb{R}^{3+1}, g) is mapped to $(\widehat{N}, g_{\widehat{N}})$, where \widehat{N} is a compact subset of $\mathbb{S}^3 \times \mathbb{R}$ (see Figure 1, Right). The compactified manifold $(\widehat{N}, g_{\widehat{N}})$ can be extended smoothly to a larger, open subset of $\mathbb{S}^3 \times \mathbb{R}$. It turns out that the past and future radiation fields can be thought of as resulting from waves produced by sources in the non-physical extension. Hence, one could say that the scattering problem is reduced to a problem where the *measurements are done beyond the infinity of the physical space*.

Summarizing, we study the following inverse scattering problem:

Inverse scattering problem: In a globally hyperbolic space-time with at least one infinity that is an asymptotically Minkowski space, does the scattering functionals for a non-linear wave equation uniquely determine the topology and differentiable structure of the underlying space-time and (the conformal type of) the Lorentzian metric?

1.1. A simplified scattering problem. To warm up, let us consider the nonlinear wave equation

$$(2) \quad \square_g u(t, y) + a(t, y)u(t, y)^\kappa = 0, \quad x = (t, y) \in \mathbb{R}^{1+3}$$

where g is a globally hyperbolic Lorentzian metric on $\mathbb{R}^{1+3} = \mathbb{R} \times \mathbb{R}^3$, and $\kappa \geq 4$ is an integer and $a(t, y) \neq 0$ is a smooth Schwartz class rapidly decreasing function in $\mathbb{R} \times \mathbb{R}^3$. We denote the coordinates of the Minkowski space by $x = (t, y) \in \mathbb{R} \times \mathbb{R}^3$ and the Minkowski metric by $\eta = -dt^2 + \sum_{j=1}^3 (dy^j)^2$. To warm up, we consider the case when the topology of the space-time is that of \mathbb{R}^4 the difference $g - \eta$ and all of its derivatives vanish faster than any polynomial uniformly as $|x| \rightarrow \infty$. Analogously to the inverse problems for the linear wave equations, see [87], we will consider the radiation fields

$$(3) \quad u_{\pm}(s, \theta) = \lim_{t \rightarrow \pm\infty} |t|^{(3-1)/2} u(t + s, t\theta)$$

where $\theta \in \mathbb{S}^2 = \{\theta \in \mathbb{R}^3 : \|\theta\|_{\mathbb{R}^3} = 1\}$ is the direction where the asymptotics of u is observed and $s \in \mathbb{R}$ is a delay parameter. Below, by re-parametrizing the ingoing radiation field $u_-(s, \theta)$, $(s, \theta) \in \mathbb{R} \times \mathbb{S}^2$ as a function h_- , it holds that for any $s_{\text{in}}, s_{\text{out}} \in \mathbb{R}$ there is $\varepsilon(s_{\text{in}}, s_{\text{out}}) > 0$ such that when the function $u_-(s, \theta)$ is supported in $(-s_{\text{in}}, s_{\text{in}}) \times \mathbb{S}^2$ and its Sobolev norm in $H^k(\mathbb{R} \times \mathbb{S}^2)$, $k \geq 5$ is smaller than $\varepsilon(s_{\text{in}}, s_{\text{out}})$, then the value of the outgoing radiation field $u_+(s_{\text{out}}, \theta_{\text{out}})$ is well-defined. For such ingoing radiation fields we define

the scattering functionals $S_{s_{\text{in}}, s_{\text{out}}, \theta_{\text{out}}}$ which map the function $u_-(s, \theta)$ to the number $u_+(s_{\text{out}}, \theta_{\text{out}})$.

1.1.1. *Penrose compactification on the perturbed Minkowski space.* To define a geometric scattering operator for the wave equation (2), we next recall the properties of the *Penrose compactification* studied in detail e.g. in [99, 126]. To do this, consider the Minkowski space \mathbb{R}^{1+3} , $n = 1 + 3$, with time t and spherical space coordinates $(r, \theta, \varphi) \in [0, \infty) \times [0, \pi] \times [0, 2\pi]$, in which the Minkowski metric is given by

$$\eta := ds^2 = -dt^2 + dr^2 + r^2 (d\theta^2 + \sin^2(\theta)d\varphi^2).$$

We use the auxiliary coordinates $v = t + r$ and $u = t - r$ and define a metric $\eta_c = \Omega^2 \eta$ that is a conformal to the Minkowski metric with the conformal factor

$$(4) \quad \Omega^2 = 4(1 + v^2)^{-1}(1 + u^2)^{-1}.$$

To represent $(\mathbb{R}^{1+3}, \eta_c)$ in the Penrose coordinates, we define a map $\Phi : \mathbb{R} \times \mathbb{R}^3 \rightarrow \mathbb{R} \times \mathbb{S}^3$. To do that, on $\mathbb{R} \times \mathbb{S}^3$ we use the time coordinate $T \in \mathbb{R}$ and on the 3-dimensional sphere \mathbb{S}^3 the Riemannian normal coordinates $(R, \theta, \varphi) \in [0, \pi] \times [0, \pi] \times [0, 2\pi]$ at the North pole (denoted NP). Here, R is the distance from the North pole. On $\mathbb{R} \times \mathbb{S}^3$ we use the product Lorentzian metric, given in the above coordinates by

$$(5) \quad g_{\mathbb{R} \times \mathbb{S}^3} = d\tilde{s}^2 = -dT^2 + dR^2 + \sin^2(R) (d\theta^2 + \sin^2(\theta)d\varphi^2).$$

We consider the map $\Phi : \mathbb{R}^{1+3} \rightarrow \mathbb{R} \times \mathbb{S}^3$ that maps a point $x \in \mathbb{R} \times \mathbb{R}^3$ with the coordinates (t, r, θ, φ) to a point on $\mathbb{R} \times \mathbb{S}^3$ that has the coordinates (T, R, θ, φ) with

$$(6) \quad \begin{aligned} T &= \tan^{-1}(v) + \tan^{-1}(u), \\ R &= \tan^{-1}(v) - \tan^{-1}(u). \end{aligned}$$

Then $\widehat{N} = \Phi(\mathbb{R}^{1+3}) \subset \mathbb{R} \times \mathbb{S}^3$ consists of the points whose coordinates (T, R, θ, φ) satisfy

$$-\pi < T + R < \pi, \quad -\pi < T - R < \pi, \quad R \geq 0.$$

The map $\Phi : (\mathbb{R}^{1+3}, \eta_c) \rightarrow (\widehat{N}, g_{\mathbb{R} \times \mathbb{S}^3})$ is an isometric diffeomorphism. This implies that the Minkowski space $(\mathbb{R} \times \mathbb{R}^3, \eta)$ is conformal to the subset $\widehat{N} \subset \mathbb{R} \times \mathbb{S}^3$ endowed with the standard product metric of $\mathbb{R} \times \mathbb{S}^3$. We will call the image $\widehat{N} = \Phi(\mathbb{R} \times \mathbb{R}^3)$ the *Penrose compactification* of the Minkowski space (see Figure 1, Left).

We use subsets of the boundary $\partial \widehat{N} \subset \mathbb{R} \times \mathbb{S}^3$ that are named as follows: The future light-like infinity \mathcal{I}^+ and the past light-like infinity \mathcal{I}^- ,

$$(7) \quad \mathcal{I}^+ = \partial \widehat{N} \cap \{0 < T < \pi\}, \quad \mathcal{I}^- = \partial \widehat{N} \cap \{-\pi < T < 0\},$$

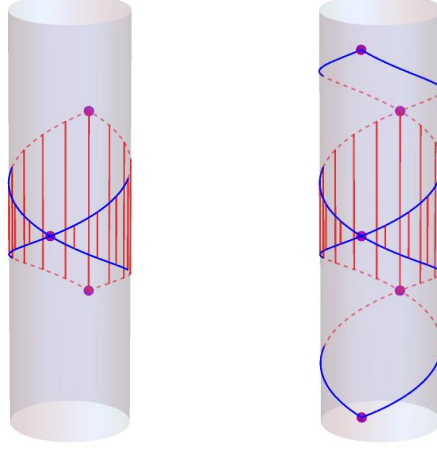

FIGURE 1. **Left:** The Penrose map is a conformal map $\Phi : \mathbb{R} \times \mathbb{R}^3 \rightarrow \mathbb{R} \times \mathbb{S}^3$ and its image $\widehat{N} = \Phi(\mathbb{R} \times \mathbb{R}^3) \subset \mathbb{R} \times \mathbb{S}^3$ is the Penrose compactification of the Minkowski space, see (6). In the figure $\mathbb{R} \times \mathbb{S}^3$ is visualized as a cylindrical surface $\mathbb{R} \times \mathbb{S}^1$, and \widehat{N} is visualized as the area shaded by the red lines, that is, \widehat{N} is visualized as a subset that is cut from the cylinder by two “circles”, one of which passes through the points i_0 and i_- and the other passes through i_0 and i_+ . The lower part of the boundary of \widehat{N} is the past conformal infinity and the upper part of the boundary of \widehat{N} is the future conformal infinity. **Right:** The Penrose compactification \widehat{N} is extended to a manifold N_{ext} by gluing to \widehat{N} non-physical extensions on the other sides of the future and the past (light-like) infinities. In the figure, the boundary of extended space-time N_{ext} is marked by blue (color online) curves. The shaded region is the Penrose compactification \widehat{N} of the Minkowski space. The space \widehat{N} is extended to the Lorentzian manifold $N_{\text{ext}} = \widehat{N} \cup N^+ \cup N^-$ where N^+ and N^- are the non-physical parts of extended manifold that are the mirror images of the space \widehat{N} on the other side of the future and the past light-like infinities. The boundary of N_{ext} is marked in the figure by blue curves.

and the future time-like infinity i_+ , the past time-like infinity i_- , and the space-like infinity (i.e., the spatial infinity) i_0 , are the points

$$(8) \quad i_+ = \partial\widehat{N} \cap \{T = \pi\} = \{(NP, \pi)\},$$

$$(9) \quad i_- = \partial\widehat{N} \cap \{T = -\pi\} = \{(NP, -\pi)\},$$

$$(10) \quad i_0 = \partial\widehat{N} \cap \{T = 0\} = \{(SP, 0)\}.$$

Below, we use i_0 to denote both the single point set $\{(SP, 0)\}$ and the point $(SP, 0)$ and use similar notations for the points i_{\pm} .

Let $g_c = \Omega^2 g$ be a metric that is conformal to the perturbed Minkowski metric g on \mathbb{R}^{1+3} with the conformal factor Ω^2 and denote by $\tilde{g} = \Phi_* g_c$

the push-forward metric on \widehat{N} . By using the transformation properties of the conformal Laplacian we see that a function $u : \mathbb{R}^{1+3} \rightarrow \mathbb{R}$ satisfies the non-linear wave equation (2) if and only if $\tilde{u} = (\Omega^{-1}u) \circ \Phi^{-1}$ solves the wave equation

$$(11) \quad (\square_{\tilde{g}} + B_{\tilde{g}})\tilde{u} + A \cdot (\tilde{u})^\kappa = 0, \quad \text{in } \widehat{N},$$

where

$$(12) \quad A := (\Phi^{-1})^*(a\Omega^{\kappa-3}), \quad B_{\tilde{g}} := -\frac{1}{6}(\Phi^{-1})^*(R_{\Omega^2g} - \Omega^{-2}R_g).$$

and R_g is the scalar curvature of the metric g .

As seen below, when $\kappa \geq 4$ is an integer, for any $0 > T_0 > -\pi$ there are $s_\kappa > 0$ and $\varepsilon > 0$ such that boundary value problem

$$(13) \quad \begin{cases} (\square_{\tilde{g}} + B_{\tilde{g}})\tilde{u} + A \cdot (\tilde{u})^\kappa = 0, & \text{in } \widehat{N} \\ \tilde{u}|_{\mathcal{I}^-} = h, \\ \tilde{u} = 0 & \text{for } T < T_0 \end{cases}$$

has a unique solution, where $h \in H^{s_\kappa}(\mathcal{I}^-)$ satisfies $\text{supp}(h) \subset \{T_0 < T < 0\}$ and $\|h\|_{H^{s_\kappa}(\mathcal{I}^-)} < \varepsilon$, where $H^s(\mathcal{I}^-)$ denotes the Sobolev space on \mathcal{I}^- with smoothness index s . As \widehat{N} is a conformal compactification of the Minkowski space, we call (13) a scattering problem.

Thus, the zero-function has in the space $C_0^\infty(\mathcal{I}^-)$ a neighborhood \mathcal{U} in which the scattering problem (13) has a unique solution for all $h \in \mathcal{U}$. We define the geometric scattering operator $S_{\widehat{N}, \tilde{g}, A} : \mathcal{U} \rightarrow C^\infty(\mathcal{I}^+)$ for the equation (13) by setting

$$(14) \quad S_{\widehat{N}, \tilde{g}, A}(\tilde{u}|_{\mathcal{I}^-}) = \tilde{u}|_{\mathcal{I}^+}, \quad \text{for } h = \tilde{u}|_{\mathcal{I}^-} \in \mathcal{U}.$$

We will prove the following theorem for the perturbed Minkowski space.

Theorem 1. *Let η be the standard Minkowski metric in the space \mathbb{R}^{1+3} , $a(x)$ be a nowhere vanishing, Schwartz rapidly decreasing function and g be a globally hyperbolic Lorentzian metric in \mathbb{R}^{1+3} such that the tensor $g_{jk}(x) - \eta_{jk}$ is a Schwartz rapidly decreasing function. Then the geometric scattering operator $S_{\widehat{N}, \tilde{g}, A}$, defined in a neighborhood of the zero function in $C_0^\infty(\mathcal{I}^-)$ determines the conformal class of the metric g uniquely.*

1.2. Scattering functionals and manifolds with an asymptotically Minkowskian infinity. In this section, we will use the standard causality notations used in Lorentzian geometry defined below in section 2.0.1. We will consider manifolds which may not be homeomorphic to the Minkowski space.

1.2.1. Manifolds with an asymptotically Minkowskian infinity.

Let $g_{\mathbb{R} \times \mathbb{S}^3} = -dt^2 + g_{\mathbb{S}^3}$ be the standard Lorentzian metric of the product space $\mathbb{R} \times \mathbb{S}^3$.

As defined above, let $\Phi : \mathbb{R}^{1+3} \rightarrow \mathbb{R} \times \mathbb{S}^3$ be Penrose's conformal map, denote by $\widehat{N} = \Phi(\mathbb{R}^{1+3})$ the Penrose compactification of the Minkowski space. We denote $g_{\widehat{N}} = g_{\mathbb{R} \times \mathbb{S}^3}|_{\widehat{N}}$ (see Figure 1, Left). Recall that $\Omega \in C^\infty(\mathbb{R}^{1+3})$ is the function for which $\Phi : (\mathbb{R}^{1+3}, \Omega^2 g_{\mathbb{R}^{1+3}}) \rightarrow (\widehat{N}, g_{\widehat{N}})$ is an isometry. Also, let $\omega = \Omega \circ \Phi^{-1} : \widehat{N} \rightarrow \mathbb{R}_+$.

Definition 1. Let $V \subset \mathbb{R}^{1+3}$ and g_V be a Lorentzian metric on V . We say that (V, g_V) is a neighborhood of the light-like infinity in \mathbb{R}^{1+3} with an asymptotically Minkowskian metric if

(i) there is an open set $\widehat{V} \subset \mathbb{R} \times \mathbb{S}^3$ such that $\mathcal{I}^+ \cup \mathcal{I}^- \cup \{i_0\} \subset \widehat{V}$ and

$$V = \Phi^{-1}(\widehat{V} \cap \widehat{N}),$$

(ii) there is a C^∞ -smooth Lorentzian metric $g_{\widehat{V}}$ on \widehat{V} such that $g_{\widehat{V}} = g_{\mathbb{R} \times \mathbb{S}^3}$ on $\widehat{V} \setminus \widehat{N}$ and

$$\Omega^2 g_V = \Phi^* g_{\widehat{V}} \quad \text{on } V.$$

Definition 2. A manifold (M, g_M) has an asymptotically Minkowskian infinity E (up to infinite order) that is visible in the whole space-time M if

(i) (M, g_M) is a globally hyperbolic manifold and it has a subset $E \subset M$ such that $(E, g_M|_E)$ is isometric to a neighborhood (V, g_V) of the light-like infinity in \mathbb{R}^{1+3} with an asymptotically Minkowskian metric.

(ii) $J_M^+(E) = J_M^-(E) = M$.

Let us note that it is possible to construct examples of space-times with an asymptotically Minkowskian infinity whose topological completion admits a boundary with the structure of a bifurcate null surface, with the geometric properties of the event horizons of the Schwarzschild exterior, non-trivial topology, or several ends. See for example Section 1.4, Examples 3-4. Also, in section 1.7 we consider conformally equivalent models similar to those used in cosmology.

Observe that above it is possible that $i_+, i_- \notin \widehat{V}$. This happens in the examples where we consider product space-times $M = \mathbb{R} \times (\mathbb{R}^3 \# K)$ where K is a compact, closed 3-dimensional manifold which is not simply connected and $\mathbb{R}^3 \# K$ is the connected sum of \mathbb{R}^3 and K . See Example 2 and Fig. 6 below on a ‘wormhole’ manifold $N_0 = \mathbb{R}^3 \# K$ with a handlebody that is obtained by glueing smoothly a 3-torus $K = \mathbb{T}^3$ and \mathbb{R}^3 . Roughly speaking, when we do the conformal change in Lorentzian metric, the handlebody becomes arbitrarily small when one approaches the time-like infinity i_+ , and thus i_+ can be considered as a singular boundary point of the conformally compactified space-time

When $(E, g_M|_E)$ is an asymptotically Minkowskian infinity, we see (using the notations of the above definitions) that there is an isometry (see Fig. 2)

$$\psi : (E, g_M|_E) \rightarrow (\widehat{V} \cap \widehat{N}, \omega^{-2} g_{\widehat{V}}),$$

We say that a function $a \in C^\infty(M)$ is a Schwartz class function in an asymptotically Minkowskian infinity of M if for all $\alpha \in \mathbb{N}^4$ and $m \in \mathbb{Z}_+$ there is $C_{\alpha, m} > 0$ such that

$$(15) \quad |\partial_x^\alpha (a \circ \psi^{-1} \circ \Phi(x))| \leq C_{\alpha, m} (1 + |x|)^{-m}, \quad \text{for all } x \in V,$$

where $|x|$ is the Euclidean length of $x \in \mathbb{R}^4 = \mathbb{R}^{1+3}$.

Let $\omega_M \in C^\infty(M)$ be a strictly positive function satisfying $\omega_M|_E = \omega \circ \psi$. Without loss of generality, we can assume that ψ is the identity map, that is, E and $\widehat{V} \cap \widehat{N}$ are identified as sets and the metric tensors on them are conformal, that is, they are the same up to a conformal factor. Let us denote

$$(16) \quad (N, g_N) = (M, (\omega_M)^2 g_M),$$

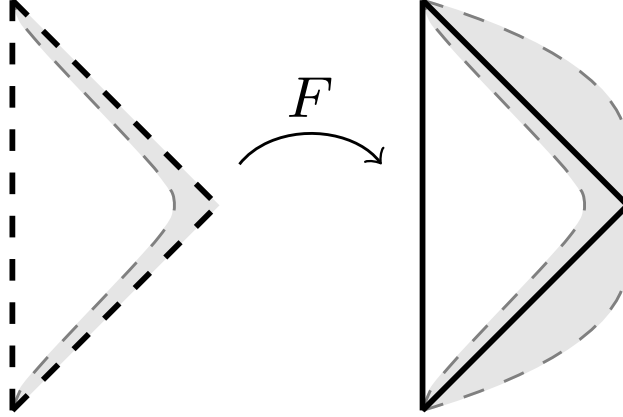

FIGURE 2. Visualization of the definition of the asymptotically Minkowskian infinity $E \subset M$. The figures show the Penrose diagrams that are 2-dimensional analogs of the cylinders shown in Figure 1. The map F takes V conformally to $\widehat{V} \cap \widehat{N}$ where $\widehat{N} = \Phi(\mathbb{R}^{1+3}) \subset \mathbb{R} \times \mathbb{S}^3$ is the Penrose compactification of the Minkowski space and $\widehat{V} \subset \mathbb{R} \times \mathbb{S}^3$ is a neighborhood of $\mathcal{I}^+ \cup \mathcal{I}^- \cup i_0$. The Lorentzian metric on \widehat{V} coincides with the standard metric of $\mathbb{R} \times \mathbb{S}^3$ outside \widehat{N} .

that is, $N = M$ but we use different symbols for the two conformally related space-times.

Next we extend the manifold (N, g_N) by gluing subsets of $\mathbb{R} \times \mathbb{S}^3$ to it. Let (see Figure 1, Right)

$$\begin{aligned} N^+ &= J_{\mathbb{R} \times \mathbb{S}^3}^+(\mathcal{I}^+ \cup i_0) \setminus J_{\mathbb{R} \times \mathbb{S}^3}^+(i_+) \subset \mathbb{R} \times \mathbb{S}^3, \\ N^- &= J_{\mathbb{R} \times \mathbb{S}^3}^-(\mathcal{I}^- \cup i_0) \setminus J_{\mathbb{R} \times \mathbb{S}^3}^-(i_-) \subset \mathbb{R} \times \mathbb{S}^3 \end{aligned}$$

be endowed with the Lorentzian metric $g_{\mathbb{R} \times \mathbb{S}^3}$ of $\mathbb{R} \times \mathbb{S}^3$. Recall, that we can assume that E in Definition 2 is identified with a subset of $\mathbb{R} \times \mathbb{S}^3$.

We define a Lorentzian manifold

$$(17) \quad N_{\text{ext}} = N \cup N^+ \cup N^-$$

such that the differentiable structure of N_{ext} in $E \cup N^+ \cup N^-$ coincides with the one inherited from $\mathbb{R} \times \mathbb{S}^3$ (see Figure 1, Right). We emphasize that N_{ext} is an open Lorentzian manifold and the time-like infinities i_+ and i_- are not contained in N_{ext} . Moreover, i_+ and i_- may be singular boundary points of N_{ext} . The Lorentzian metric g_{ext} of N_{ext} is such a C^∞ -smooth metric that on N it coincides with g_N , and on $N^+ \cup N^-$ it coincides with the standard metric $g_{\mathbb{R} \times \mathbb{S}^3}$ of $\mathbb{R} \times \mathbb{S}^3$.

1.2.2. *Scattering problem on a manifold with an asymptotically Minkowskian infinity.* For $q \in \mathcal{I}^+$ and $p \in \mathcal{I}^-$ we denote, slightly abusing the notations

$$I_M^-(q) = I_{N_{\text{ext}}}^-(q) \cap N, \quad I_M^+(p) = I_{N_{\text{ext}}}^+(p) \cap N$$

and

$$J_{\mathcal{I}^-}^+(p) = \mathcal{I}^- \cap J_{N_{\text{ext}}}^+(p), \quad I_{\mathcal{I}^+}^-(q) = \mathcal{I}^+ \cap I_{N_{\text{ext}}}^-(q).$$

Let $k \in \mathbb{Z}_+$, $k \geq 5$, and $h_- \in H^k(I^-)$ be supported in the future of the point $p \in \mathcal{I}^-$. Let $q, q_1 \in \mathcal{I}^+$ be such that $q_1 > q$, that is, q_1 is in the future of q . Let $a(x) > 0$ be a Schwartz class function in an asymptotical Minkowskian infinity of M .

Definition 3. Let $k \geq 5$, $q_0 \in \mathcal{I}^+$, $M(q_0) := I_M^-(q_0) \subset M$ and $h_- \in C(\mathcal{I}^-)$ be supported in the future of the point $p \in \mathcal{I}^-$. Let $a(x)$ and $d(x)$ Schwartz functions on M . We say that a function $u \in H_{\text{loc}}^k(M(q_0)) \cap C(M(q_0))$ is a solution of the scattering problem on $(M(q_0), g_M)$ at rest prior to p with the past radiation field h_- , if

$$(18) \quad \square_{g_M} u(x) + d(x)u(x) + a(x)u(x)^\kappa = 0, \quad \text{on } I_M^-(q_0),$$

$$(19) \quad \lim_{x \rightarrow q} \omega_M(x)^{-1} u(\Phi(x)) = h_-(q) \quad \text{for all } q \in \mathcal{I}^-,$$

$$(20) \quad u = 0 \quad \text{on } M \setminus J_M^+(p).$$

Moreover, we say that $\tilde{u} \in H^k(I_{N_{\text{ext}}}^-(q_0) \cap N)$ and is a solution of the Goursat-Cauchy boundary value problem with the past radiation field (or with the Goursat data) h_- if

$$(21) \quad \square_{g_N} \tilde{u}(x) + (B_{g_N}(x) + D(x))\tilde{u}(x) + A(x)\tilde{u}(x)^\kappa = 0, \quad \text{in } N \cap I_{N_{\text{ext}}}^-(q_0),$$

$$(22) \quad \tilde{u}|_{\mathcal{I}^-} = h_-,$$

$$(23) \quad \tilde{u} = 0 \quad \text{on } N_{\text{ext}} \setminus J_{N_{\text{ext}}}^+(p)$$

where

$$(24) \quad A := a \cdot \omega_M^{\kappa-3}, \quad D := d \cdot \omega_M^{\kappa-1} \quad B_{g_N} := -\frac{1}{6}(R_{g_N} - \omega_M^2 R_{g_M}).$$

We say that u has the future radiation field h_+ if

$$(25) \quad \lim_{x \rightarrow q} \omega_M(x)^{-1} u(\Phi(x)) = h_+(q) \quad \text{for all } q \in \mathcal{I}^+(q_0),$$

see formula (3). Also, we say that \tilde{u} has the future radiation field h_+ if

$$(26) \quad \tilde{u}|_{I_{\mathcal{I}^+}^-(q_0)} = h_+.$$

The existence and uniqueness of the solution \tilde{u} of the Cauchy-Goursat problem (21)-(23) is considered below in Theorem 5. By Sobolev embedding theorem $H^k(M(q_0)) \subset C(M(q_0))$ for $k > 2$, and we see that when \tilde{u} is a solution of the Goursat-Cauchy boundary value problem on $N \cap I_{N_{\text{ext}}}^-(q_0)$ with the future radiation field h_+ then

$$u(x) = \omega_M(\Phi^{-1}(x))\tilde{u}(\Phi^{-1}(x))$$

is a solution of the scattering problem on $(M(q_0), g_M)$ having the same future radiation field h_+ .

1.2.3. The past and future radiation fields of the waves that are compactly supported in space at any time. In this section, we consider waves in the Minkowski space. The extension of the Penrose compactification of the Minkowski space \mathbb{R}^{1+3} is the product space $\mathbb{R} \times \mathbb{S}^3$ with the metric $-dT^2 + g_{\mathbb{S}^3}$, where $g_{\mathbb{S}^3}$ is the Riemannian metric of the unit 3-sphere $\mathbb{S}^3 \subset \mathbb{R}^4$. For $R > 0$, let

$$P(R) = \{\Phi(t, y) \mid t = 0, y \in \mathbb{R}^3, |y| \leq R\}$$

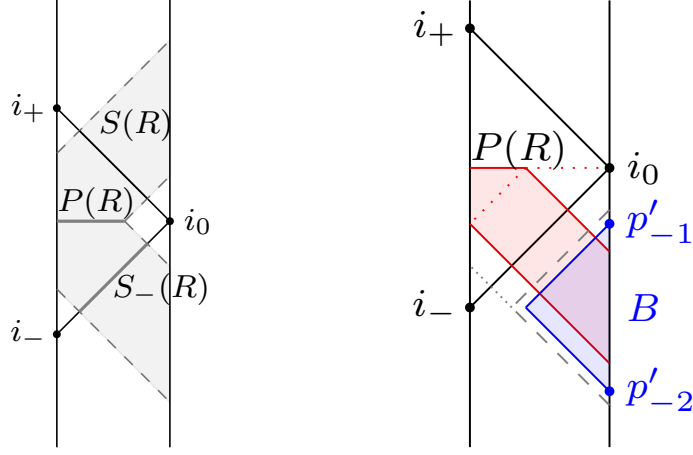

FIGURE 3. **Left:** The set $P(R)$ is shown as the horizontal bold gray line. The grayed region depicts the set $S(R)$, while its restriction $S_-(R)$ to the past null infinity \mathcal{I}^- is shown as the diagonal gray line. **Right:** Sets and the support of the cut-off function ρ used in the proof of Theorem 5.

be the image of the set $\{0\} \times \overline{B_{\mathbb{R}^3}}(0, R)$ under the Penrose map Φ . Moreover, let

$$S(R) = \{\gamma_{x,\xi}(s) \in \mathbb{R} \times \mathbb{S}^3 \mid x \in P(R), \xi \in L_x(\mathbb{R} \times \mathbb{S}^3), s \in \mathbb{R}\}$$

(see Figure 3, Left) and let

$$S_-(R) = S(R) \cap \mathcal{I}^-$$

be the set of the intersection points of light-like geodesics on the past light-like geodesics emanating from the points in $S(R)$. Observe that $S_-(R) \subset \mathcal{I}^-$ is compact. Figure 3 depicts the sets $P(R)$, $S(R)$, and $S_-(R)$.

Let $(\phi_0, \phi_1) \in \mathcal{E}'(\mathbb{S}^3 \setminus \{i_0\})^2$ be distributions supported on $P(R)$. As the scalar curvature of the sphere \mathbb{S}^3 equals 6, we see that in the Penrose compactification of the Minkowski space $\tilde{b} = 1$. By [84, Appendix A], on the unit 3-sphere \mathbb{S}^3 the wave equation

$$(27) \quad (\partial_T^2 - \Delta_{\mathbb{S}^3} + 1)\tilde{u} = 0, \quad \text{on } \mathbb{R} \times \mathbb{S}^3,$$

$$(28) \quad (\tilde{u}|_{T=0}, \partial_T \tilde{u}|_{T=0}) = (\phi_0, \phi_1),$$

satisfies the strong Huygen's principle, that is,

$$\text{supp}(\tilde{u}) \subset \{\gamma_{x,\xi}(s) \in \mathbb{R} \times \mathbb{S}^3 \mid x = (0, y) \in \mathbb{R} \times \mathbb{S}^3, \text{ where } y \in \text{supp}(\phi_0) \cup \text{supp}(\phi_1), \xi \in L_x(\mathbb{R} \times \mathbb{S}^3), s \in \mathbb{R}\},$$

where $L_x(\mathbb{R} \times \mathbb{S}^3)$ is the set of light-like vectors in the tangent space $T_x M_0$ of manifold $M_0 = \mathbb{R} \times \mathbb{S}^3$. Thus for $(\phi_0, \phi_1) \in \mathcal{E}'(\mathbb{S}^3)^2$ supported on $P(R)$ it holds that

$$(29) \quad \text{supp}(\tilde{u}) \subset S(R), \quad \text{supp}(\tilde{u}|_{\mathcal{I}^-}) \subset S_-(R).$$

Observe also that the Penrose map Φ maps the surface $\{0\} \times \mathbb{R}^3$ to the surface $\{0\} \times \mathbb{S}^3$. Thus, the support of the initial data $(u|_{t=0}, \partial_t u|_{t=0})$ is compact in \mathbb{R}^3 if and only if the the support of the initial data $(\tilde{u}|_{T=0}, \partial_T \tilde{u}|_{T=0})$

is a compact subset of $\mathbb{S}^3 \setminus \{i_0\}$. Using this observation we define the past and future radiation fields arising from compactly supported initial data

$$(30) \quad \mathcal{B}_\pm = \{\tilde{u}|_{\mathcal{I}^\pm} \mid \tilde{u} \text{ solves (27)-(28) with } (\phi_0, \phi_1) \in \mathcal{E}'(\mathbb{S}^3 \setminus \{i_0\})^2\},$$

where $\mathcal{E}'(\mathbb{S}^3 \setminus \{i_0\})$ is the set of distributions on \mathbb{S}^3 whose support does not contain the point i_0 . We note that when \tilde{u} is the solution of the wave equation having the initial data $(\phi_0, \phi_1) \in \mathcal{E}'(\mathbb{S}^3 \setminus \{i_0\})^2$, then the wavefront set of \tilde{u} does not intersect the normal bundle of \mathcal{I}^+ or \mathcal{I}^- , and thus the traces $\tilde{u}|_{\mathcal{I}^\pm}$ are well-defined as distributions, see [35]. Observe that if $h_- \in \mathcal{B}_-$ then $\text{supp}(h_-)$ is a compact subset of \mathcal{I}^- . Below, we call \mathcal{B}_- and \mathcal{B}_+ the past and future radiation fields of concentrated waves (that in Minkowski space correspond to waves $u(t, y)$ that at any time t are supported in a bounded subset of \mathbb{R}^3). We also denote for $R > 0$

$$(31) \quad \mathcal{B}_\pm(R) = \{\tilde{u}|_{\mathcal{I}^\pm} \mid \tilde{u} \text{ solves (27)-(28) with } (\phi_0, \phi_1) \in \mathcal{E}'(P(R))^2\},$$

On space-time $\mathbb{R} \times \mathbb{S}^3$ we define a time function $\mathbf{t} : \mathbb{R} \times \mathbb{S}^3 \rightarrow \mathbb{R}$ by setting $\mathbf{t}(p) := t$ for $p = (t, y) \in \mathbb{R} \times \mathbb{S}^3$. In particular, this defines the time function \mathbf{t} for $p = (t, y) \in N \cup \mathcal{I}^- \cup \mathcal{I}^+$. Moreover, for $t_-, t_+ \in [-\pi, \pi]$, $t_- < t_+$, we denote $\mathcal{I}^-(t_-, t_+) = \{p \in \mathcal{I}^- \mid \mathbf{t}(p) \in (t_-, t_+)\}$ and $\mathcal{I}^+(t_-, t_+) = \{p \in \mathcal{I}^+ \mid \mathbf{t}(p) \in (t_-, t_+)\}$, and for $t_1 < 0$

$$(32) \quad R(t_1) = \inf\{R > 0 \mid \mathcal{I}^-(-\pi - t_1, t_1) \subset S_-(R)\}.$$

For $-\pi < t_1 < 0$ it holds that $R(t_1) < \infty$ and the points i_0, i_- have neighborhoods $U_0, U_- \subset \mathbb{R} \times \mathbb{S}^3$, respectively, such that $S(R(t_1)) \cap (U_0 \cup U_-) = \emptyset$.

Let us next describe the scattering problem (see, e.g. [15, 63, 87, 89, 102, 123]) in a more general setting. To this end, we consider scattering functionals which are also defined in many cases, where the scattering operator is not defined.

Definition 4. Let $k \geq 3$, $-\pi < t_1 < 0$, $q, q_1 \in \mathcal{I}^+$, where q_1 is in the future of q and $\varepsilon > 0$ and

$$(33) \quad \mathcal{D}(S_{t_1, q}) = \mathcal{D}_{(\varepsilon)}(S_{t_1, q}) = \{h \in H^k(\mathcal{I}^-) \cap \mathcal{B}_-(R(t_1)) \mid \|h\|_{H^k(\mathcal{I}^-)} < \varepsilon\}$$

be an open neighborhood of the zero function in $H^k(\mathcal{I}^-) \cap \mathcal{B}_-(R(t_1))$. Let $\varepsilon = \varepsilon(t_1, q_1) > 0$ be so small that for any past radiation field $h_- \in \mathcal{D}_{(\varepsilon)}(S_{t_1, q})$ there is a unique solution \tilde{u} for the Goursat-Cauchy boundary value problem (21)-(23). Let $q \in \mathcal{I}^+(0, t_2)$ and h_+ be the future radiation field of \tilde{u} , see (26). Then, we say that the (non-linear) functional

$$\begin{aligned} S_{t_1, q} : \mathcal{D}_{(\varepsilon)}(S_{t_1, q}) &\rightarrow \mathbb{R}, \\ S_{t_1, q}(h_-) &= h_+(q) \end{aligned}$$

is a scattering functional associated to (M, g_M, a) , and the time t_1 and the point $q \in \mathcal{I}^+$ (See Fig. 4). We also denote $S_{M, g_M, a, d; t_1, q} = S_{t_1, q}$.

Observe also that if a scattering operator $S_{M, g_M, a}$ exists, it determines the scattering functionals $S_{M, g_M, a; t_1, q}$ for all (t_1, q) .

Remark 1. The past and future radiation fields of concentrated waves (i.e., waves in the Minkowski space produced by compactly supported initial data) particularly suitable in study of inverse problems as a phenomenon called the

causality violation at infinity (CVI), see [20], does not appear for them. In this phenomenon one considers the extended spacetime $\mathbb{R} \times \mathbb{S}^3$ and light-like geodesic travelling from \mathcal{I}^- to \mathcal{I}^+ through the space-like infinity i_0 . Let us consider Green's function $G(x, x')$ of the wave equation, $(\partial_T^2 - \Delta_{\mathbb{S}^3})G(\cdot, x') = \delta_{x'}$, where the source point x' is i_- . The wavefront set of the function $G(x, i_-)$ is the union of bicharacteristics corresponding to light-like geodesics that travel through the point i_0 . The function $G(x, i_-)$ is a wave on $\mathbb{R} \times \mathbb{S}^3$ whose wavefront set contains the normal bundle of \mathcal{I}^+ , and thus one can state that this wave carries information from $i_- \cup \mathcal{I}^-$ to \mathcal{I}^+ , see also [89]. However, the wave $G(x, i_-)$ vanishes in the physical part $N = I_{\mathbb{R} \times \mathbb{S}^3}^+(i_-) \cap I_{\mathbb{R} \times \mathbb{S}^3}^-(i_+)$ of the space-time $\mathbb{R} \times \mathbb{S}^3$. Moreover, there are distributions f supported on the past light-like infinity \mathcal{I}^- for which the solution u of the wave equation $\square_{\mathbb{R} \times \mathbb{S}^3} u + u = f$ is such that the singularities propagate along the (non-smooth) surface $\mathcal{I}^- \cup i_0 \cup \mathcal{I}^0$ to the future light-like infinity but the wave u is C^∞ -smooth on the physical part of the space-time. This paradox is called the causality violation at infinity. As the past radiation fields $h_- \in \mathcal{B}_-$ give rise to waves vanishing near i_0 , these waves avoid causality violation at infinity. Below, we show that the scattering functionals $S_{M^{(1)}, g_M^{(1)}, a, d; t_1, q}$, where $-\pi < t_1 < 0$ and $q \in \mathcal{I}^+$, are equivalent to the source-to-solution maps defined for sources supported in compact subsets $K_n \subset (N^-)^{\text{int}}$, see (41). In particular these sources are not supported on \mathcal{I}^- , and therefore do not produce waves whose wavefronts propagate along the light-like geodesics that pass through i_0 .

1.3. Main result. Our main result is the following uniqueness result for the inverse scattering problem for a semi-linear wave equation.

Theorem 2. *Let $(M^{(j)}, g^{(j)})$, $j = 1, 2$ be two globally hyperbolic manifolds with asymptotically Minkowskian infinities (up to infinite order) that are visible in the whole space-time $M^{(j)}$, see Definition 1. Let $a^{(j)}, d^{(j)} \in C^\infty(M^{(j)})$ be Schwartz functions in an asymptotically Minkowskian infinity of $M^{(j)}$, $a^{(j)}(x) \neq 0$ for all $x \in M^{(j)}$, and $\kappa \geq 4$. Assume that for all $-\pi < t_1 < 0$ and $q \in \mathcal{I}^+$ the scattering functionals (see Definition 4) for equations (18)-(20) satisfy*

$$S_{M^{(1)}, g_M^{(1)}, a^{(1)}, d^{(1)}; t_1, q}(h) = S_{M^{(2)}, g_M^{(2)}, a^{(2)}, d^{(2)}; t_1, q}(h)$$

when $h \in \mathcal{D}(S_{M^{(1)}, g_M^{(1)}, a^{(1)}, d^{(1)}; t_1, q}) \cap \mathcal{D}(S_{M^{(2)}, g_M^{(2)}, a^{(2)}, d^{(2)}; t_1, q})$. Then there is a diffeomorphism $\Psi : M^{(1)} \rightarrow M^{(2)}$ and a function $\gamma \in C^\infty(M^{(1)})$ such that the metric tensors $g^{(j)}$ and the coefficients $a^{(j)}$ of the non-linear terms satisfy

$$(34) \quad \begin{aligned} g^{(1)} &= e^{2\gamma} \Psi^* g^{(2)}, \\ a^{(1)} &= e^{(\kappa-3)\gamma(x)} \Psi^* a^{(2)}, \end{aligned}$$

that is, the non-linear scattering functionals uniquely determine the topology, the differentiable structure, and the conformal type of the Lorentzian manifold, and the Lorentzian metric, and the coefficient function of the non-linear term up to the transformations in (34).

Remark 2. While working on the paper we became aware of another group of researchers, P. Hintz, A. Sá Barreto, G. Uhlmann, and Y. Zhang, who were also working on non-linear inverse scattering problems, and in private communication we agreed on publishing their and our preprints on the same day. It turned out that their results in [53] and our work are complementary, in the sense that the classes of manifolds studied in these works are disjoint. Moreover, [53] analyses more general non-linear equations than those considered in this paper. An essential difference in the papers is that the conformal compactifications of the Lorentzian manifolds studied in [53] are globally hyperbolic spaces that have a spatial infinity that is diffeomorphic to \mathbb{S}^{n-1} , where the dimension of the Lorentzian manifold is $n + 1$. In contrast, in the present paper we consider Lorentzian manifolds whose conformal compactification has a spatial infinity that is a single point i_0 , similarly to the Penrose compactification of the Minkowski space [99]. This makes the classes of manifolds considered in the papers different. For example, for the Minkowski space (\mathbb{R}^{1+3}, η) , denoted below by M_0 , the conformal boundary (that is, the conformal infinity) $\partial_c M_0$ is defined by using equivalence classes of Cauchy sequences on a certain bundle $\mathcal{P}^1(M_0)$ over the space-time M_0 so that the conformal boundary depends only on the conformal structure of the space-time M_0 and is thus independent of the choice of conformal compactification; see [107, Section 2]. By results of B. Schmidt, see [107], the conformal boundary $\partial_c M_0$ of the Minkowski space can be identified with the boundary of N in $\mathbb{R} \times \mathbb{S}^3$, that is, with $\mathcal{I}^- \cup \mathcal{I}^+ \cup i_+ \cup i_- \cup i_0$, where the light-like infinities $\mathcal{I}^-, \mathcal{I}^+$ are the subsets defined above of the boundary of $N \subset \mathbb{R} \times \mathbb{S}^3$, see (7), and the future time-like infinity i_+ , the past time-like infinity i_- , and the spatial infinity i_0 are the points of the boundary of N , see (8). This implies that that conformal boundary of the Minkowski space contains only three points, i_+, i_- , and i_0 , which are not limits of light-like geodesics of M_0 (that is, points for which there exists a light-like geodesic $\gamma \subset M_0$ such that the equivalence class of the point is a limit point of the lift of the curve γ on $\mathcal{P}^1(M_0)$). Hence, for the Minkowski space \mathbb{R}^{1+3} there do not exist two conformally flat extensions where the spatial infinity is on one extension a single point and the sphere \mathbb{S}^2 on the other extension. We refer the reader to the monograph by R. Wald, [126, Section 11.1], for in-depth discussion on the structure of spatial infinity on Lorentzian spaces and its role in physical models.

1.3.1. *Properties of the extended space-time.* To define certain useful points on $\mathbb{R} \times \mathbb{S}^3$, let $\widehat{\mu}(s) = (s, \text{SP})$ be the path $\widehat{\mu} : [-2\pi, 2\pi] \rightarrow \mathbb{R} \times \mathbb{S}^3$ associated to the South Pole SP of the sphere \mathbb{S}^3 , and let $0 < s_{+2} < 2\pi$ and $0 > s_{-2} > -2\pi$. We denote $p_{+2} = \widehat{\mu}(s_{+2})$ and $p_{-2} = \widehat{\mu}(s_{-2})$. Moreover, let $s_{-2} < s_- < 0 < s_+ < s_{+2}$, see Figure 8 (Left). We denote

$$p_- = \widehat{\mu}(s_-) \quad \text{and} \quad p_+ = \widehat{\mu}(s_+).$$

Let us next consider the extended manifold

$$(35) \quad N_{\text{ext}} = N \cup N^+ \cup N^-.$$

The following lemma is essential to the direct problem.

Lemma 1. *The manifold N_{ext} is globally hyperbolic.*

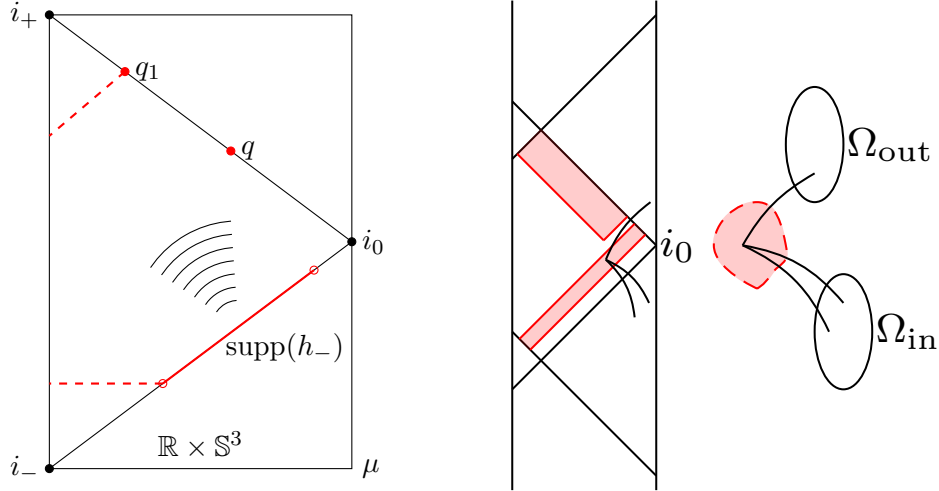

FIGURE 4. Left: Visualization of setting where scattering functionals are defined. The in-going radiation field h_- is supported on a relatively compact subset of \mathcal{I}^- . When $\|h_-\| < \varepsilon(t_1, q_1)$, the solution u of the scattering problem is defined in the past of the point q_1 . The scattering functional $S_{t_1, q}(h_-)$ takes the value of the out-going radiation field h_+ evaluated at the point $q < q_1$. **Middle:** In our spacetime sources will be produced in the nonphysical past (the lower triangular region below past null infinity). The nonlinear interaction of waves produces new waves in the physical region (shaded red), and the interactions are observed in the nonphysical future. The sources and receivers are separated by the point i_0 . **Right:** Schematic picture on the reconstruction. Sources located in Ω_{in} produce waves that interact inside the red shaded region D and cause signals that can be observed in the causally separated domain Ω_{out} . The closures of the domains Ω_{in} , Ω_{out} and D are disjoint. This causes difficulties that are encountered also in the figure on the left, and we overcome this issue by introducing a reconstruction algorithm which works in the situation when the light-like geodesics connecting Ω_{in} to D do not have conjugate or cut points.

The proof of Lemma 1 is postponed to later.

1.4. Examples. We emphasize that in Definition 2 we do not assume that the manifold M has a Cauchy surface Σ for which $\Sigma \setminus E$ is compact. Thus the manifold M may have several infinities of which at least one is an asymptotically Minkowskian infinity.

Example 1. The Lorentzian product manifold $\mathbb{R} \times (\mathbb{R}^3 \# \mathbb{R}^3)$ has an asymptotically Minkowskian infinity (in fact, it has two asymptotically Minkowskian infinities, but it suffices to define the scattering functionals by considering

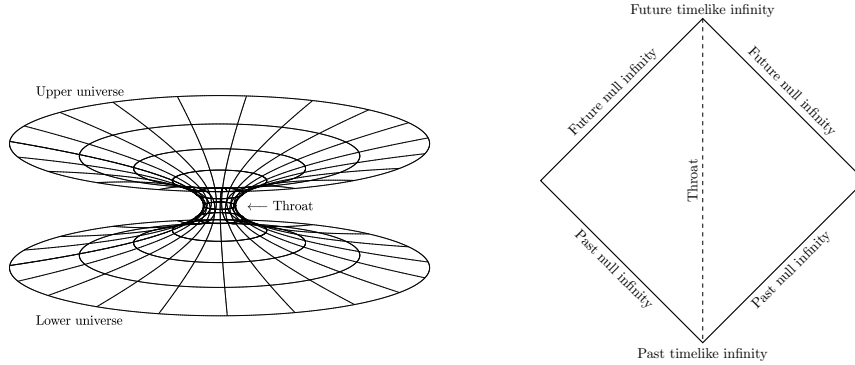

FIGURE 5. Left: Morris-Thorne wormhole manifold, see [91,92], is a static universe (that is non-physical due to negative mass) of the form $M = \mathbb{R} \times N_0$, where N_0 is illustrated in the figure. Right: Penrose diagram of a (non-physical) traversable wormhole, see [11,43,125]. Note that this resembles the Penrose diagram of a Schwarzschild blackhole, though in that case the consideration of the point i_0 is more complicated due to singularities in the compactification, see [49].

measurements only one infinity), see Figure 5. Recall that all globally hyperbolic manifolds are homeomorphic to a product space $\mathbb{R} \times N_1$. Any differentiable manifold N_1 has a complete Riemannian metric, and using this metric, one can construct a Lorentzian metric on $\mathbb{R} \times (\mathbb{R}^3 \# N_1)$ that is globally hyperbolic and has an asymptotically Minkowskian infinity that is visible from the infinity. Thus Definition 2 allows all such manifolds where N_1 has a general topology.

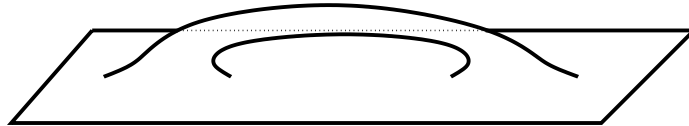

FIGURE 6. We can consider product space-times $M = \mathbb{R} \times N_0$ where N_0 is a 3-dimensional Riemannian manifold with non-trivial topology or several ends. One of the ends of N_0 has to be asymptotically Euclidean so that the manifold M has an asymptotically Minkowskian infinity. The figure visualizes a (2-dimensional) Riemannian manifold N_0 that is obtained by gluing a handlebody in the Euclidean space

Example 2. Let us consider product space-times $M = \mathbb{R} \times N_0$ where (N_0, g_{N_0}) is a complete 3-dimensional Riemannian manifold with several ends of which at least one is asymptotically Euclidean (a Schwartz class perturbation of the Euclidean metric). Also, let g on M be a Lorentzian time-oriented metric that coincides with $-dt^2 + g_{N_0}$ outside a compact set

then the manifold M has an asymptotically Minkowskian infinity (see Figure 6).

Example 3. Let us consider a Lorentzian manifold (M_0, g_{r_s}) having a locally Schwarzschild event horizon, see [98, p. 376], and a Minkowskian infinity. An example of such a space is $M_0 = \mathbb{R} \times (\mathbb{R}^3 \setminus \overline{B_{\mathbb{R}^3}(0, r_s)})$, where $r_s > 0$ is a parameter (the Schwarzschild radius) and we use the coordinates (t, r, φ, θ) , where $t \in \mathbb{R}$ is the Schwarzschild time coordinate and $r > r_s$ is the Schwarzschild radial coordinate, determined by the standard spherical coordinates (r, φ, θ) of \mathbb{R}^3 , see [98, p. 364-365]. In these coordinates, the metric g_{r_s} of M_0 is given by

$$(36) \quad g_{r_s} = -\left(1 - \phi(r)\frac{r_s}{r}\right) dt^2 + \left(1 - \phi(r)\frac{r_s}{r}\right)^{-1} dr^2 + r^2 (d\theta^2 + \sin^2(\theta) d\varphi^2)$$

where $r_s > 0$ is the Schwarzschild radius and $\phi \in C^\infty((r_s, \infty))$ is a function such that $0 \leq \phi \leq 1$ and that $\phi(r) = 1$ for $r < 2r_s$ and $\phi(r) = 0$ for $r > 4r_s$. Note that in the region $r > 4r_s$ the metric tensor g_{r_s} coincides with the metric of the Minkowski space and in the region $r \in (r_s, 2r_s)$ the metric tensor g_{r_s} coincides with the metric of the Schwarzschild space. In particular, (M_0, g_{r_s}) contains, as an isometric subset, the region $r \in (r_s, \frac{3}{2}r_s)$ that in the Schwarzschild black hole is the region between the event horizon and the photon sphere $r = \frac{3}{2}r_s$. As stated in the introduction, this and the other examples of Lorentzian manifolds do not solve the Einstein equations for physical matter model — they are purely examples of Lorentzian spacetimes, see Figure 7 (left).

By using the fact that the exterior of the Schwarzschild black hole is a globally hyperbolic manifold, one sees first for the space-spherically symmetric sets $S = [-T, T] \times \partial B_{\mathbb{R}^3}(0, r)$ that $J^+(S) \cap J^-(S)$ are compact and then that the space-time (M_0, g_{r_s}) , where $M_0 = \mathbb{R} \times (\mathbb{R}^3 \setminus B_{\mathbb{R}^3}(0, r_s))$, is a globally hyperbolic Lorentzian manifold. Alternatively, we observe that, in the sense of [44] g_{r_s} is causally dominated by f^*g_{Sc} , denoted $g_{r_s} < f^*g_{Sc}$, where g_{Sc} the standard Schwarzschild metric in the exterior of the event horizon in M_0 (given by formula (36) when ϕ is identically 1) and $f : M_0 \rightarrow M_0$ is a map that scales the time variable by $f(t, r, \varphi, \theta) = (4t, r, \varphi, \theta)$, and therefore by [44, Thm. 12], (M_0, g_{r_s}) , also, as the subset $\mathbb{R} \times (\mathbb{R}^3 \setminus B_{\mathbb{R}^3}(0, 4r_s))$ is isometric to a domain of the Minkowski space, we see that (M_0, g_{r_s}) has an asymptotically Minkowskian infinity, $E = \{(x^0, x') \in \mathbb{R}^{1+3} : c_0|x^0| \leq |x'|, |x'| > r_0\}$ with suitable chosen $0 < c_0 < 1$ and $r_0 > 0$. It is also easy to see that this infinity is visible in the whole space. We will use this in the example below.

Example 4. Let g_{r_s} be the Lorentzian metric tensor of the form (36) in $\mathbb{R} \times (\mathbb{R}^3 \setminus B_{\mathbb{R}^3}(0, r_s))$, where $\phi \in C^\infty([r_s, \infty))$ is such that $\phi(r) = 1$ for $r_s < r < R$ and $\phi(r) = 0$ for $r > 2R$ where $R = 2r_s$. Moreover, let $\Lambda_\ell \in O(1, 3)$ be a Lorentz transformation $\Lambda_\ell : \mathbb{R} \times \mathbb{R}^3 \rightarrow \mathbb{R} \times \mathbb{R}^3$ that maps the line $\ell_0 = \{(t, 0, 0, 0) \in \mathbb{R} \times \mathbb{R}^3\}$ to the affine time-like line $\ell \subset \mathbb{R} \times \mathbb{R}^3$. For $r > 0$, we denote by V_r the closed ‘‘cylinder’’ $V_r = \mathbb{R} \times \overline{B_{\mathbb{R}^3}(0, r)} \subset \mathbb{R}^4$. When the line ℓ is such that the sets $\Lambda_\ell(V_{2R}) \subset \mathbb{R}^{1+3}$ and $V_{2R} \subset \mathbb{R}^{1+3}$ do

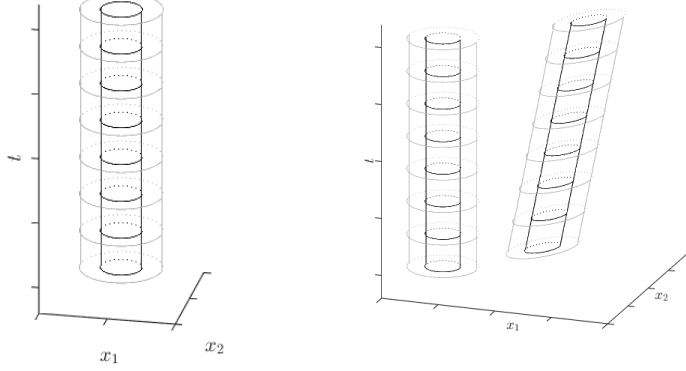

FIGURE 7. **Left.** The figure shows the $(1+2)$ dimensional spacetime $\mathbb{R} \times (\mathbb{R}^2 \setminus \overline{B_{\mathbb{R}^2}(0, r_s)})$ that is analogous to the $(1+3)$ dimensional spacetime $M_0 = \mathbb{R} \times (\mathbb{R}^3 \setminus \overline{B_{\mathbb{R}^3}(0, r_s)})$, see Example 3. In this space-time, we consider the metric g_{r_s} given in (36). The surface $r = r_s$ is visualized as a black cylinder and the grey cylinder is the surface $r = 2r_s$. The function $\phi(r)$ in (36) is equal to one for $r \in (r_s, 2r_s)$ and thus space-time (M_0, g_{r_s}) contains in this region a locally Schwarzschild event horizon. The function $\phi(r)$ vanishes for $r > 4r_s$, that is, outside the grey cylinder. In this region the metric g_{r_s} coincides with the metric tensor of the Minkowski space. The coordinate axis in the figure are (t, x^1, x^2) are the standard Minkowski coordinates in $r > 4r_s$. **Right.** In Example 4, we consider a toy model for a space that has two moving black holes, and energy density which may have both positive and negative values. The figure visualizes the space-time $(M_1, g_{\ell_0, \ell})$, see (37) and (38), where the set $M_1 \subset \mathbb{R} \times \mathbb{R}^3$ has the Lorentzian metric $g_{\ell_0, \ell}$. In the figure, the space-time M_1 is visualized as the exterior of the black cylinders. The space-time $(M_1, g_{\ell_0, \ell})$ has an (asymptotically) Minkowskian infinity and two locally Schwarzschild event horizons. Note that the metric of the space-time coincide with the Minkowski metric outside the grey cylinders.

not intersect, we define the Lorentzian metric

$$(37) \quad g_{\ell_0, \ell} := \begin{cases} (\Lambda_\ell)_* g_{r_s}, & \text{in } (\mathbb{R} \times \mathbb{R}^3) \setminus (V_{2R} \cup \Lambda_\ell(V_{r_s})), \\ g_{r_s}, & \text{in } V_{2R} \setminus V_{r_s}. \end{cases}$$

The Lorentzian manifold $(M_1, g_{\ell_0, \ell})$, where

$$(38) \quad M_1 = (\mathbb{R} \times \mathbb{R}^3) \setminus (V_{r_s} \cup \Lambda_\ell(V_{r_s})) \subset \mathbb{R} \times \mathbb{R}^3$$

is a globally hyperbolic Lorentzian manifold with an asymptotically Minkowskian infinity that is visible in the whole space. Observe that this space-time has one Minkowskian end and the metric tensor $g_{\ell_0, \ell}$ is isometric to the

metric tensor of a Schwarzschild space-time in the domain $V_R \setminus V_{r_s}$ as well as in the domain $\Lambda_\ell(V_R \setminus V_{r_s})$. In these two regions, the space-time has locally Schwarzschild event horizons, see Figure 7 (Right). If we operate with an additional Lorentz transformation $\Lambda_{\ell'} \in O(1, 3)$ to the space-time $(M_1, g_{\ell_0, \ell})$, we obtain the space-time

$$((\mathbb{R} \times \mathbb{R}^3) \setminus (\Lambda_{\ell'}(\Lambda_\ell(V_{r_s})) \cup \Lambda_{\ell'}(V_{r_s})), (\Lambda_{\ell'})_* g_{\ell_0, \ell})$$

that is a toy model to a space-time with two black holes that move along the lines ℓ' and $\Lambda_{\ell'}(\ell)$. Iterating the above construction we obtain an asymptotically Minkowskian space-time that has several Schwarzschild (bifurcate) event horizons. As before, this space-time do not solve Einstein's field equations. On physically realistic space-times obtained by gluing black-hole and other vacuum space-times, see [52] and references therein, and [122] on scattering from physical black holes.

On the above examples, as well on any other space-time that satisfies our assumptions, we can consider the non-linear wave equation

$$(39) \quad \square_g u(x) + d(x)u(x) + a(x)u(x)^\kappa = 0, \quad x \in M$$

where $\kappa \geq 4$ and (M, g) is a perturbed Lorentzian product space with an Euclidean infinity. Then the family of the scattering functionals $S_{M, g_M, a; t_1, q}$, given for all $-\pi < t_1 < 0$ and $q \in \mathcal{I}^+$ determines the manifold M , and the conformal class of the metric g_M on M , and the pair (g_M, A) up to a conformal transformation.

1.5. Reduction of the scattering measurements to the near field measurements in the extended space-time. Next, we will consider the equation

$$(40) \quad \begin{cases} (\square_{g_{\text{ext}}} + B)w + Aw^\kappa = f, & \text{in } x \in I_{N_{\text{ext}}}^-(p), \\ \text{supp}(w) \subset J_{N_{\text{ext}}}^+(\text{supp}(f)) \end{cases}$$

where $p \in N_{\text{ext}}$. To make our conformal transformations below possible, we will allow B to be a general smooth function. In particular, we will consider the case when $B = B_g + D$, and B_g and D are defined in (24).

Lemma 2. *Let $\kappa \geq 1$ and $k \geq 4$. Moreover, let $A, B \in C^\infty(N_{\text{ext}})$, $K \subset N_{\text{ext}}$ be a compact set and $p \in N_{\text{ext}}$. Then there is $\varepsilon > 0$ such that for all $f \in H_0^k(K)$, $\|f\|_{H^k(N_{\text{ext}})} < \varepsilon$ there exists a unique (small) solution $w \in H^{k+1}(I_{N_{\text{ext}}}^-(p))$ to the equation (40). Moreover, the solution w depends in $H^{k+1}(I_{N_{\text{ext}}}^-(p))$ continuously on the source $f \in H_0^k(K)$ and*

$$\|w\|_{H^{k+1}(I_{N_{\text{ext}}}^-(p))} \leq C \|f\|_{H^k(N_{\text{ext}})},$$

where C is independent of f .

The proof of Lemma 2 can be obtained using the proof of the results in [101, Prop. 9.12 and 9.17], by using the energy estimates for the wave equation (40). Alternatively, see [60, Thm. III], [66], or [29, App. III, Thm. 3.7 and 4.2].

Let $K_n \subset (N^-)^{\text{int}}$, $n = 1, 2, \dots$ be compact sets that are closures of open sets such that $K_n \subset K_{n+1}$ and $\bigcup_{n=1}^\infty K_n = (N^-)^{\text{int}}$. For example, we can

choose

$$(41) \quad K_n = J^+\left(\left(-\pi + \frac{1}{n}, \text{SP}\right)\right) \cap J^-\left(-\frac{1}{n}, \text{SP}\right).$$

Let $\mathcal{V}_n \subset H_0^k(K_n)$ be a sufficiently small neighborhood of the zero function. Then the source-to-solution map

$$(42) \quad L_{g_{\text{ext}}, B, A, p_+, K_n} : \mathcal{V}_n \subset H_0^k(K_n) \rightarrow L^2(I_{N_{\text{ext}}}^-(p_+) \cap N^+)$$

is well defined by setting $L_{g_{\text{ext}}, B, A, p_+, K_n}(f) = u|_{I_{N_{\text{ext}}}^-(p_+) \cap N^+}$, where u solves (40).

The following theorem shows that the scattering functionals determine the source-to-solution maps.

Theorem 3. *Let (M_1, g_{M_1}) and (M_2, g_{M_2}) be globally hyperbolic Lorentzian manifolds with an asymptotically Minkowskian infinity that are visible in the whole space-time. Let (N_1, g_{N_1}) and (N_2, g_{N_2}) be conformal manifolds given in Definition 2 and (N_{ext}^1, g_1) and (N_{ext}^2, g_2) be the corresponding extended manifolds. Let $a_j, d_j \in C^\infty(M_j)$, $j = 1, 2$ be Schwartz functions in an asymptotically Minkowskian infinity of M_j , $a_j(x) \neq 0$ for all $x \in M_j$, and $\kappa \geq 4$.*

Let $S_{M_j, g_{M_j}, a_j, t_1, q}$ be the scattering functionals related to (M_j, g_{M_j}) and coefficients a_j . If the scattering functions on (M_j, g_{M_j}) satisfy

$$S_{M_1, g_{M_1}, a_1, d_1; t_1, q}(h) = S_{M_2, g_{M_2}, a_2, d_2; t_1, q}(h),$$

for all $-\pi < t_1 < 0$, $q \in \mathcal{I}^+$ and $h \in \mathcal{D}(S_{M_1, g_{M_1}, a_1, t_1, q}) \cap \mathcal{D}(S_{M_2, g_{M_2}, a_2, t_1, q})$, then the corresponding source-to-solution maps on (N_{ext}^j, g_j) (see formula (42)) satisfy for all $p_+ \in \hat{\mu}(0, \pi)$ and n

$$L_{g_1, B_1, A_1, p_+, K_n}(f) = L_{g_2, B_2, A_2, p_+, K_n}(f)$$

when f is in some neighborhood \mathcal{U}_n of the zero function in $H_0^k(K_n)$ and $B_j = B_{g_j} + D_j$ and B_{g_j} and D_j are defined in (24).

1.6. Structure of the proofs of the main theorems. To show that the scattering functionals are well defined in an asymptotically Minkowskian space-time, we reduce the the scattering problem to a nonlinear Cauchy-Goursat problem in a suitable subset W (see (65) and Fig. 8) of the extended space-time N_{ext} . The boundary of W is only Lipschitz-smooth near the space-like infinity i_0 and in Appendix A we obtain regularity estimates in the the higher order Sobolev spaces for the Cauchy-Goursat problem in the space-time W . Using these estimates and the strong Huygens' principle on $\mathbb{R} \times \mathbb{S}^3$, we show that the scattering functionals are well defined, and prove Theorem 3. This result implies that one can reduce the inverse scattering problem to an inverse problem for local measurements in the extended space-time. In this problem with local measurements, a source-to-solution operator is given in the case when the source and the observation sets are different and separated. Earlier, the source-to-solution map with different source and observation sets has been studied in [39] in the situation when

$$(43) \quad M^{\text{in}, \text{out}} := \left(\bigcap_{p \in \Omega_{\text{in}}} I^+(p) \right) \cap \left(\bigcap_{q \in \Omega_{\text{out}}} I^-(q) \right) = \emptyset.$$

In the inverse problem on the extended Penrose compactification N_{ext} the sources are supported in the set $\tilde{\Omega}_{\text{in}} = (N^-)^{\text{int}}$ and solutions are observed in the set $\tilde{\Omega}_{\text{out}} = (N^+)^{\text{int}}$. On the space-time N_{ext} there holds for the space-like infinity i_0 that (see Figure 4, Middle)

$$(44) \quad i_0 \in N_{\text{ext}}^{\text{in,out}} := \left(\bigcap_{p \in \tilde{\Omega}_{\text{in}}} I^+(p) \right) \cap \left(\bigcap_{q \in \tilde{\Omega}_{\text{out}}} I^-(q) \right)$$

that is, the sets $\tilde{\Omega}_{\text{in}} = (N^-)^{\text{int}}$ and $\tilde{\Omega}_{\text{out}} = (N^+)^{\text{int}}$ are causally separated by i_0 . This implies that the Lorentzian time separation function $\tau : N_{\text{ext}} \times N_{\text{ext}} \rightarrow \mathbb{R}$ satisfies $\tau(p, q) > 0$ for all $p \in \tilde{\Omega}_{\text{in}}$ and $q \in \tilde{\Omega}_{\text{out}}$ and $\tilde{\Omega}_{\text{in}}$ and thus $\tilde{\Omega}_{\text{out}}$ can not be connected by light-like geodesics having no conjugate or cut points. This prevents to use of layer-wise constructions (e.g., the layer-stripping) to solve the inverse problem. We deal with this difficulty by first constructing open subsets of space-time that are not connected to the source and observation sets, but which can be connected to the source set with light-like geodesics that have no cut or conjugate points, see Figure 4 (Middle and Right). Second, we prove that the source-to-solution map in the original source and observation domains N^- and N^+ and the open sets reconstructed above determine two new local source-to-solution maps in the neighborhoods of the sets $\mathcal{I}^+ \cup i_0$ and $\mathcal{I}^- \cup i_0$. That is, we show that by using the source-to-solution map in the non-physical part of the extended space-time N_{ext} , one can reproduce the results of the measurements where both the sources and the observations would be located the physical part N of the space-time. Theorem 2 is then proven by combining the original and the reproduced measurements in the extended space-time and using the multiple linearization results for the non-linear wave equation.

1.7. Generalizations of the inverse scattering problem for FLRW space-times. Next we will consider space-times similar to the *Friedmann-Lemaître-Robertson-Walker (FLRW)* space-times studied in cosmology. It is possible to apply our constructions to perturbations of such space-times, given in (51) below, when the condition (52) holds. We note that such cosmological backgrounds are conformally related to the whole Minkowski space-time and thus no particle horizons appear, see [126, p. 105 and Fig. 5.6] – this has sometimes been suggested as a solution to the particle horizon problem in big-bang cosmology, see [69, Sec. 4.2-4.3].

An appealing feature of this construction is that then the sources that generate waves could lie near the cosmological singularity (i.e., the big-bang) in the M_{FLRW} space-time.

While the conformal structure of the space-times we consider here is the same as the Minkowski space, it should be said that our notion of radiation field is an extrapolation.

To define the scattering problem in FLRW space-times, we consider a class of manifolds with a more general conformal factor close to the infinities. Let $V \subset \mathbb{R}^{1+3}$ and g_V be a Lorentzian metric on V . We say that (V, g_V) is a neighborhood of the light-like infinity in \mathbb{R}^{1+3} with a conformally asymptotically Minkowskian metric with conformal factor $\tilde{\Omega} \in C^\infty(\mathbb{R}^{1+3})$ if the conditions in Definition 1 are valid when Ω is replaced by $\tilde{\Omega}|_V$. Moreover, we

say that a manifold (M, g_M) has a conformally asymptotically Minkowskian infinity E (with a conformal factor $\tilde{\Omega}$) that is visible in the whole space-time M if

- (i) (M, g_M) is a globally hyperbolic manifold and it has a subset $E \subset M$ such that $(E, g_M|_E)$ is isometric to a neighborhood (V, g_V) of the light-like infinity in \mathbb{R}^{1+3} with a conformally asymptotically Minkowskian metric with conformal factor $\tilde{\Omega}$,
- (ii) $J_M^+(E) = J_M^-(E) = M$.

Our results for the inverse scattering problem generalize for the manifolds with a conformally asymptotically Minkowskian infinity E with a priori given conformal factor $\tilde{\Omega}$. In such manifold, let us consider the equation for the conformal wave operator

$$(45) \quad \square_g u - \frac{1}{6} R_g u + du + au^\kappa = 0, \quad \text{on } M,$$

where $d = d(x)$ and $a = a(x)$ are scalar functions. Using a conformal transformation, we see that the equation (45) is equivalent to the wave equation

$$(46) \quad \square_{g_0} u_0 - \frac{1}{6} R_{g_0} u_0 + d_0 u_0 + a_0 u_0^\kappa = 0, \quad \text{on } M,$$

where $u_0 = (\Omega/\tilde{\Omega})^{-1}u$ and

$$(47) \quad g_0 = (\Omega/\tilde{\Omega})^2 g, \quad d_0 = (\Omega/\tilde{\Omega})^{-2} d, \quad a_0 = a \cdot (\Omega/\tilde{\Omega})^{\kappa-3}.$$

Here, (M, g_0) is a Lorentzian manifold that has an asymptotically Minkowskian infinity E that is visible in the whole space-time M . Below, we assume that $d_0(\Phi(x))$ and $a_0(\Phi(x))$ are Schwartz functions (that is, those vanish up to infinite order near $\mathcal{I}^- \cup \mathcal{I}^+ \cup i_0$).

For the equation (46), we define the scattering functionals as in the Definition 4, where the equation (18) is replaced by the equation (46) having the potential term d_0 . That is, $\tilde{S}_{M^{(1)}, g_M^{(1)}, a^{(1)}, d^{(1)}, t_1, q} : h_- \rightarrow h_+(q)$ is as in the Definition 4, when the equation (18) is replaced by the equation (46). That is, $\tilde{S}_{M^{(1)}, g_M^{(1)}, a^{(1)}, d^{(1)}, t_1, q}(h_-) = h_+(q)$, where h_- and h_+ are the generalized past and future radiation fields, respectively, that are given by

$$(48) \quad \lim_{x \rightarrow p} \tilde{\Omega}(\Phi^{-1}(x))^{-1} u(\Phi^{-1}(x)) = h_-(p) \quad \text{for } p \in \mathcal{I}^-,$$

$$(49) \quad \lim_{x \rightarrow q} \tilde{\Omega}(\Phi^{-1}(x))^{-1} u(\Phi^{-1}(x)) = h_+(q) \quad \text{for } q \in \mathcal{I}^+,$$

where $x \in \Phi(V) \cup (\mathcal{I}^- \cup \mathcal{I}^+)$, c.f. (25) and u satisfies (45). In this setting Theorem 2 generalizes to the following result where the conformal factor is $\tilde{\Omega}$ and we are given only a restricted scattering data.

Theorem 4. *Let $(M^{(j)}, g^{(j)})$, $j = 1, 2$ be two globally hyperbolic manifolds with conformally asymptotically Minkowskian infinities with conformal factor $\tilde{\Omega}$, that are visible in the whole space-time $M^{(j)}$. Let $a^{(j)}, d^{(j)} \in C^\infty(M^{(j)})$, $j = 1, 2$ be such that the corresponding functions $a_0^{(j)}(\Phi(x))$ and $d_0^{(j)}(\Phi(x))$ defined by formula (47) are Schwartz functions and $a_0^{(j)}$ are strictly positive.*

Moreover, let $-\pi \leq t_1^* < 0$. Assume that for all $t_1^* < t_1 < 0$ and $q \in \mathcal{I}^+$ the scattering functionals for the equations (45) satisfy

$$\tilde{S}_{M^{(1)}, g_{M^{(1)}}, a^{(1)}, d^{(1)}; t_1, q}(h) = \tilde{S}_{M^{(2)}, g_{M^{(2)}}, a^{(2)}, d^{(2)}; t_1, q}(h)$$

when $h \in \mathcal{D}(\tilde{S}_{M^{(1)}, g_{M^{(1)}}, a^{(1)}, d^{(1)}; t_1, q}) \cap \mathcal{D}(\tilde{S}_{M^{(2)}, g_{M^{(2)}}, a^{(2)}, d^{(2)}; t_1, q})$. Then there is a diffeomorphism $\Psi : I_{M^{(1)}}^+(\mathcal{I}^- \cap \mathcal{B}_-(R(t_1^*))) \rightarrow I_{M^{(2)}}^+(\mathcal{I}^- \cap \mathcal{B}_-(R(t_1^*)))$ and a function $\gamma \in C^\infty(M^{(1)})$ such that the metric tensors $g^{(j)}$ and the coefficients $a^{(j)}$ of the non-linear terms satisfy

$$(50) \quad \begin{aligned} g^{(1)} &= e^{2\gamma} \Psi^* g^{(2)}, \\ a^{(1)} &= e^{(\kappa-3)\gamma(x)} \Psi^* a^{(2)}, \end{aligned}$$

in the domain $I_{M^{(1)}}^+(\mathcal{I}^- \cap \mathcal{B}_-(R(t_1^*)))$, that is, the non-linear scattering functionals uniquely determine the topology, the differentiable structure, and the conformal type of the Lorentzian manifold, and the Lorentzian metric, and the coefficient function of the non-linear term up to the transformations in (50).

To apply the above theorem we will recall the definition of the Friedmann-Lemaître-Robertson-Walker (FLRW) space-times. These space-times are Lorentzian manifolds $(M_{\text{FLRW}}, g_\sigma)$ of the following warped product form $M_{\text{FLRW}} = (0, \infty) \times \mathbb{R}^3$ with the metric

$$(51) \quad g_\sigma(t, x) = -dt^2 + \sigma^2(t)((dx^1)^2 + (dx^2)^2 + (dx^3)^2),$$

where $(t, x^1, x^2, x^3) \in (0, \infty) \times \mathbb{R}^3$, $\sigma(t) > 0$ is smooth on $(0, \infty)$ and tends to zero as $t \rightarrow 0$, possibly causing a singularity near $t = 0$. A singularity at the boundary $t = 0$ corresponds physically to the Big Bang and the behaviour of the metric at large t corresponds to the expansion of the Universe, see [105, 126]. In particular, the choice $\sigma(t) = t^{2/3}$ gives the Einstein-de Sitter cosmological model [105, p. 31]. Let us consider next a model where

$$(52) \quad \int_1^\infty \frac{1}{\sigma(t)} dt = \infty \quad \text{and} \quad \sigma(t) < c_1 t \text{ for } 0 < t < 1,$$

where $c_1 > 0$. In this case there are no particle horizons, that is, all observers on the co-moving curves $x = \text{constant}$ can see at a given time all other co-moving observers, see [126, p. 105 and Fig. 5.6]. The condition (52) is closely related to cosmological models with inflation, see [69, Sec. 4.3].

We note that the Einstein tensor of several FLRW metrics satisfy the null energy condition (that corresponds to non-negative energy density in general relativity), see [25], and thus by using perturbations of the FLRW space-times we can consider inverse problems for manifolds satisfying the null energy condition.

Example 5. Let $(M_{\text{FLRW}}, g_\sigma)$ be a space time the form (51) that satisfies the condition (52). Under the assumptions, $(M_{\text{FLRW}}, g_\sigma)$ is conformal to the Minkowski space in suitable coordinates. Indeed, let us define the conformal time, that is the strictly increasing function

$$(53) \quad \tau(t) := \int_1^t \frac{1}{\sigma(t')} dt', \quad t \in (0, \infty).$$

Observe that $\tau(t) \rightarrow -\infty$ as $t \rightarrow 0$. Let

$$(54) \quad F : \mathbb{R}_+ \times \mathbb{R}^3 \rightarrow \mathbb{R} \times \mathbb{R}^3, \quad F(t, x) = (\tau(t), x)$$

Then, F is an isometric diffeomorphism from the space $(M_{\text{FLRW}}, g_\sigma)$ to $(\mathbb{R} \times \mathbb{R}^3, g_{\tilde{\sigma}})$,

$$(55) \quad g_{\tilde{\sigma}}(\tau, x) = \tilde{\sigma}^2(\tau)(-d\tau^2 + (dx^1)^2 + (dx^2)^2 + (dx^3)^2),$$

where $(\tau, x^1, x^2, x^3) \in \mathbb{R} \times \mathbb{R}^3$ and $\tilde{\sigma}(\tau(t)) = \sigma(t)$.

Next, let us consider the space-time $\mathbb{R}_+ \times \mathbb{R}^3$ with a metric g , that is a perturbation of a FLRW space-time $(\mathbb{R}_+ \times \mathbb{R}^3, g_\sigma)$ in (51). We assume that $\sigma(t)$ is such that there are no particle horizons, that is, the conditions given below in (52) are valid. Let $F : \mathbb{R}_+ \times \mathbb{R}^3 \rightarrow \mathbb{R} \times \mathbb{R}^3$ be the map given in (53) and (54) and assume that $F_*(g - g_\sigma)$ is a Schwartz class function in $\mathbb{R} \times \mathbb{R}^3$. Let $\tilde{g} = F_*g$. Then, $(\mathbb{R} \times \mathbb{R}^3, \tilde{g})$ is a globally hyperbolic manifold with a conformally asymptotically Minkowskian infinity with conformal factor $\tilde{\Omega} = \tilde{\sigma}(\tau)\Omega$, that is visible in the whole space-time, and Theorem 4 can be used to reconstruct the metric g in the future of the domain $\mathcal{I}^- \cap \mathcal{B}_-(R(t_1^*))$, where the ingoing radiation fields are supported. Here, the radiation fields h_+ and h_- are given by

$$(56) \quad \lim_{x \rightarrow p} \tilde{\Omega}(F^{-1}(\Phi^{-1}(x)))^{-1} u(F^{-1}(\Phi^{-1}(x))) = h_\pm(p) \quad \text{for } p \in \mathcal{I}^\pm,$$

where u is the solution of the equation (45) on $(\mathbb{R}_+ \times \mathbb{R}^3, g)$.

Acknowledgements. H. I. was supported by Grant-in-Aid for Scientific Research (C) 24K06768 Japan Society for the Promotion of Science. M. L. was partially supported by a AdG project 101097198 of the European Research Council, Centre of Excellence of Research Council of Finland and the FAME flagship of the Research Council of Finland (grant 359186). S. A. was supported by the Natural Sciences and Engineering Research Council of Canada (NSERC): RGPIN-2020-01113 and RGPIN-2019-06946. T. T was supported by the FAME flagship and the Emil Aaltonen foundation. Views and opinions expressed are those of the authors only and do not necessarily reflect those of the funding agencies or the EU.

2. GEOMETRIC PROPERTIES AND NOTATIONS

2.0.1. *Preliminary notations on Lorentzian manifolds.* We recall some notations and definitions for Lorentzian manifolds. A more extensive treatment of Lorentzian geometry can be found in [98]. Let (M, g_M) be an $(n+1)$ -dimensional Lorentzian manifold with metric of signature $(-, +, +, \dots, +)$ where $n = 3$. We assume that M is time-oriented. Then a smooth path $\mu : (a, b) \rightarrow M$ is time-like if $g_M(\dot{\mu}(s), \dot{\mu}(s)) < 0$ for all $s \in (a, b)$. The path μ is causal, if $g_M(\dot{\mu}(s), \dot{\mu}(s)) \leq 0$ and $\dot{\mu}(s) \neq 0$ for all $s \in (a, b)$. For $p, q \in M$ we denote $p \ll q$ if $p \neq q$ and there is a future-pointing time-like path from p to q . Similarly, $p < q$ if $p \neq q$ and there is a future-pointing causal path from p to q , and $p \leq q$ when $p = q$ or $p < q$. The chronological future of $p \in M$ is the set $I^+(p) = \{q \in M \mid p \ll q\}$ and the causal future of p is $J^+(p) = \{q \in M \mid p \leq q\}$. The chronological past $I^-(q)$ and causal past $J^-(q)$ of $q \in M$ are defined similarly. If $A \subset M$,

then we denote $J^\pm(A) = \cup_{p \in A} J^\pm(p)$. The diamond sets are denoted by $J(p, q) = J^+(p) \cap J^-(q)$ and $I(p, q) = I^+(p) \cap I^-(q)$.

A time-orientable Lorentzian manifold (M, g_M) is globally hyperbolic if there are no closed causal paths in M and for $q_1, q_2 \in M$ with $q_1 < q_2$ the diamond $J(q_1, q_2) \subset M$ is compact [19]. In a globally hyperbolic manifold the sets $J^\pm(p)$ are closed and $\text{cl}(I^\pm(p)) = J^\pm(p)$.

Let $L_p M = \{\xi \in T_p M \setminus \{0\} \mid g_M(\xi, \xi) = 0\}$ be the set of light-like vectors in the tangent space $T_p M$. This set is called the light-cone of p . Let also $L_p^+ M$ and $L_p^- M$ denote the future and past light-like vectors in $T_p M$ and $L_p^{*,+} M$ and $L_p^{*,-} M$ denote the future and past light-like covectors in $T_p^* M$, and denote $L_p^* M = L_p^{*,+} M \cup L_p^{*,-} M$. Let $\mathcal{L}^+(q) = \exp_q(\overline{L_q^+ M})$.

We use also some other notations: For $\xi \in T_x^* M$ we will denote $(\xi^\sharp)^j = g_M^{jk} \xi_k$ and for $\zeta \in T_x M$ we let $(\zeta^\flat)_j = g_{jk} \zeta^k$. Here g^{jk} is the inverse matrix of g_{jk} .

The time-separation function $\tau(x, y)$ of $x, y \in M$, $x < y$ is defined as the supremum of the lengths $L(\alpha) = \int_0^1 \sqrt{-g(\dot{\alpha}(s), \dot{\alpha}(s))} ds$ of the piece-wise smooth causal paths $\alpha : [0, 1] \rightarrow M$ from x to y . If $x < y$ is not valid, we set $\tau(x, y) = 0$. If (x, ξ) is a non-zero vector, the number $\mathcal{T}(x, \xi) \in (0, \infty]$ will be used to denote the maximum time for which the geodesic $\gamma_{x, \xi} : [0, \mathcal{T}(x, \xi)) \rightarrow M$ is defined.

For a light-like vector $(x, \xi) \in L^+ M$ we define the cut-locus function

$$(57) \quad \rho(x, \xi) = \sup\{s \in [0, \mathcal{T}(x, \xi)) \mid \tau(x, \gamma_{x, \xi}(s)) = 0\}.$$

Definition 5. *The light observation set from the point q in $V \subset M$ is*

$$\mathcal{P}_V(q) = \mathcal{L}^+(q) \cap V,$$

and the earliest light observation set from the point q is

$$(58) \quad \mathcal{E}_V(q) = \{x \in \mathcal{P}_V(q) \mid \text{there are no } y \in \mathcal{P}_V(q) \text{ and future-pointing time-like path } \alpha : [0, 1] \rightarrow V \text{ such that } \alpha(0) = y \text{ and } \alpha(1) = x\}.$$

Let $W \subset M$ be open. The family of the earliest light observation sets with source points in W is

$$(59) \quad \mathcal{E}_V(W) = \{\mathcal{E}_V(q) \subset V \mid q \in W\}$$

When we want to emphasize the manifold M on which we consider the earliest light observation sets, we use notation $\mathcal{E}_V(W) = \mathcal{E}_{V, M}(W)$.

The earliest light observation set are discussed in detail in [75]. The earliest light observation set $\mathcal{E}_V(q)$ can be written also as

$$(60) \quad \mathcal{E}_V(q) = \left(\bigcup_{\xi \in L_q^+ M} \gamma_{q, \xi}([0, \rho(x, \xi)]) \right) \cap V,$$

that is $\mathcal{E}_V(q)$ is the intersection of the observation set V and the union of all future-directed light-like geodesic segments $\gamma_{q, \xi}([0, \rho(x, \xi)])$ from q to their first cut or conjugate point $\gamma_{q, \xi}(\rho(x, \xi))$. In the case when a point source is located in the point q of the space-time, the earliest light observation set $\mathcal{E}_V(q)$ is the set when the light (or other signal) arriving to V are detected

first time, i.e. the signal is detected at p but not in the chronological past of p .

2.0.2. *Properties of the extended manifold N_{ext} .* Next we prove Lemma 1.

Proof. (of Lemma 1). Let us start with the simple cases when (M, g_M) is either the Minkowski space-time with the standard metric or the space-time \mathbb{R}^{1+3} where we have added a Schwartz class perturbation to the metric of the Minkowski space. In these cases the manifold $(N, g_N) = (M, \omega_M^2 g_M)$ is the subset $I_{\mathbb{R} \times \mathbb{S}^3}^+(i_-) \cap I_{\mathbb{R} \times \mathbb{S}^3}^-(i_+) \subset \mathbb{R} \times \mathbb{S}^3$ with a metric tensor that can be C^∞ -smoothly extended to the space $\mathbb{R} \times \mathbb{S}^3$ so that the extended metric coincides with the standard metric of $\mathbb{R} \times \mathbb{S}^3$ outside the set N . In this case use the whole space N as the neighborhood E of $\mathcal{I}^+ \cup \mathcal{I}^- \cup i_0$ and obtain the extended space-time N_{ext} by gluing N with N^- and N^+ smoothly using the standard coordinates of $\mathbb{R} \times \mathbb{S}^3$. This makes N_{ext} a globally hyperbolic space-time.

Next, we consider the more general space-times N with (possibly) non-trivial topology.

Let $\Sigma \subset N$ be a Cauchy surface of N . We recall that a subset $\Sigma \subset N$ of a time-oriented Lorentzian manifold is a Cauchy surface if the intersection of every inextendable timelike curve in N and the set Σ is one point, see [98, Ch. 14, Definition 28]. We recall that a timelike curve $\mu : I_0 = (a, b) \rightarrow N_{\text{ext}}$ is future (or past) inextendable if there is an increasing (or decreasing) sequence $s_j, j \in \mathbb{Z}_+$ such that $\mu(s_j)$ does not converge as $j \rightarrow \infty$, and that a path is inextendable if it is both past and future inextendable. Observe that the definition of a Cauchy surface does not require that Σ is a smooth submanifold. By [98, Ch. 14, Corollary 39], the time-oriented Lorentzian manifold N is globally hyperbolic if and only if it has a Cauchy surface. Let us next show that $\Sigma_{\text{ext}} = \Sigma \cup i_0$ is a Cauchy surface of N_{ext} .

Let $\mu : I_0 \rightarrow N_{\text{ext}}$ be an inextendable causal curve in N_{ext} , $I_0 \subset \mathbb{R}$. If $\mu \cap N \neq \emptyset$, we see that $\mu \cap N$ is an inextendable causal path in N and hence μ intersects Σ once. Hence, if $\mu \cap N \neq \emptyset$, then μ has to intersect $\Sigma \cup i_0$.

Next, assume that $\mu \cap N = \emptyset$. To show that μ contains the point i_0 , we assume to the contrary that $i_0 \notin \mu$. As the path μ is a connected set but $N_{\text{ext}} \setminus (N \cup i_0) = N^+ \cup N^-$ is disconnected, there holds $\mu \subset N^+$ or $\mu \subset N^-$. Suppose that the former is valid, that is, $\mu \subset N^+$. Because μ is past inextendable, there is a decreasing sequence $r_j \in I_0, j = 1, 2, \dots$ such that $\mu(r_j)$ does not converge as $j \rightarrow \infty$. However, as μ is causal $\mu(r_j) \subset J_{N_{\text{ext}}}^-(x_1)$ for all j , where $x_1 = \mu(r_1)$. As $N^+ \subset J_{N_{\text{ext}}}^+(i_0)$ and the set $J_{N_{\text{ext}}}^-(x_1) \cap J_{N_{\text{ext}}}^+(i_0)$ is compact, we see that there is a subsequence $x_k = \mu(r_{j_k})$ such that $\mu(r_{j_k})$ converges to $p \in J_{N_{\text{ext}}}^-(x_1) \cap J_{N_{\text{ext}}}^+(i_0) \subset N^+$. As $N^+ \subset \mathbb{R} \times \mathbb{S}^3$ and $x_k \rightarrow p$ as $k \rightarrow \infty$, we see that $x_k \in J_{N_{\text{ext}}}^+(p)$ and for $j' \geq j_k$ we have

$$\mu(r_{j'}) \subset J_{N_{\text{ext}}}^-(x_k) \cap J_{N_{\text{ext}}}^+(x_{k+1}) \subset J_{N_{\text{ext}}}^-(x_k) \cap J_{N_{\text{ext}}}^+(p).$$

As the sets $J_{N_{\text{ext}}}^-(x_k) \cap J_{N_{\text{ext}}}^+(p)$ converge to the singleton $\{p\}$ as $k \rightarrow \infty$ (that is, for any neighborhood $U \subset \mathbb{R} \times \mathbb{S}^3$ of p there is k such that $J_{N_{\text{ext}}}^-(x_k) \cap J_{N_{\text{ext}}}^+(p) \subset U$), we see that the sequence $\mu(r_j)$ converges to the limit point

$p \in N^+$ as $j \rightarrow \infty$. As this is in contradiction with the assumption that μ is an inextendable causal path, we have shown that μ contains the point i_0 . Thus, we have seen that also when $\mu \cap N = \emptyset$ then μ has to intersect $\Sigma \cup i_0$.

Hence, we have shown in all cases that any inextendable causal curve μ in N_{ext} intersects $\Sigma \cup i_0$.

Let us next show that μ can intersect $\Sigma \cup i_0$ only once. Using the definition of the infinity E of the manifold N_{ext} , the causal vectors at the point i_0 with respect to the metric g coincide with the causal vector with respect to the metric $-dT^2 + g_{\mathbb{S}^3}$. Thus all causal paths from i_0 enter in the future to N^+ and in the past to N^- . This means that a causal path can not enter from N to the point i_0 .

Let us first consider the case when $\mu \cap N \neq \emptyset$. Then the path μ may exit from N only to \mathcal{I}^+ or \mathcal{I}^- and in particular, it can not intersect i_0 . Let us consider the case when μ intersects \mathcal{I}^+ but not \mathcal{I}^- . Then $\mu \subset N \cup N^+$ as μ can not be extended in N_{ext} to the past, there is a decreasing sequence $r_j \in I_0$ such that $\mu(r_j) \in N$ does not converge in N_{ext} as $j \rightarrow \infty$. Then $\mu(r_j) \in N$ can neither converge in N as $j \rightarrow \infty$. These imply that $\mu \cap N$ is inextendable in N . Moreover, there exists the smallest value $r' \in I_0$ such that $\mu(r') \in N^+$. Then there is an increasing sequence $r'_j \rightarrow r'$ such that $\mu(r'_j) \in N$. As $\lim_{j \rightarrow \infty} \mu(r'_j) = \mu(r') \in N^+$, we see that $\mu(r'_j)$ does not converge in N as $j \rightarrow \infty$. Thus, $\mu \cap N$ is inextendable in the future.

Similarly, by considering all cases when μ does or does not intersect \mathcal{I}^+ or \mathcal{I}^- , we see that in all cases $\mu \cap N$ is inextendable in N . Hence, $\mu \cap N$ intersects Σ at most once (and do not intersect i_0).

Let us next consider the case when $\mu \cap N = \emptyset$. We observe that a causal curve in N^+ or in N^- can intersect i_0 only at once. Moreover, when μ is parametrized to the future direction, we see that μ can enter from N^- to N^+ only through i_0 , and then it stays in $(N^-)^{\text{int}}$. Thus we see that μ can intersect i_0 only once.

Above, we have seen that any inextendable causal curve in N_{ext} can intersect $\Sigma \cup i_0$ at most once. Thus, $\Sigma \cup i_0$ is a Cauchy surface of N_{ext} and hence N_{ext} is a globally hyperbolic Lorentzian manifold. \square

2.0.3. *Notations related to the extended manifold.* Recall that

$$(61) \quad N_{\text{ext}} = N \cup N^+ \cup N^-.$$

We define

$$(62) \quad \begin{aligned} \mathbb{D} &= (I_{(N_{\text{ext}}, g_{\text{ext}})}^+(p_-) \cap I_{(N_{\text{ext}}, g_{\text{ext}})}^-(p_+)) \setminus (N^+ \cup N^-), \\ \mathbb{D}_0 &= I_{(N_{\text{ext}}, g_{\text{ext}})}^+(p_-) \cap I_{(N_{\text{ext}}, g_{\text{ext}})}^-(p_+). \end{aligned}$$

We define

$$(63) \quad V^\pm = I_{N_{\text{ext}}}^\pm(i_0) = (N^\pm)^{\text{int}},$$

and recall that (see Figure 8 (Left))

$$\begin{aligned} \Omega_{\text{in}} &= I_{N_{\text{ext}}}^-(i_0) \cap I^+(p_-), \\ \Omega_{\text{out}} &= I_{N_{\text{ext}}}^+(i_0) \cap I^-(p_+). \end{aligned}$$

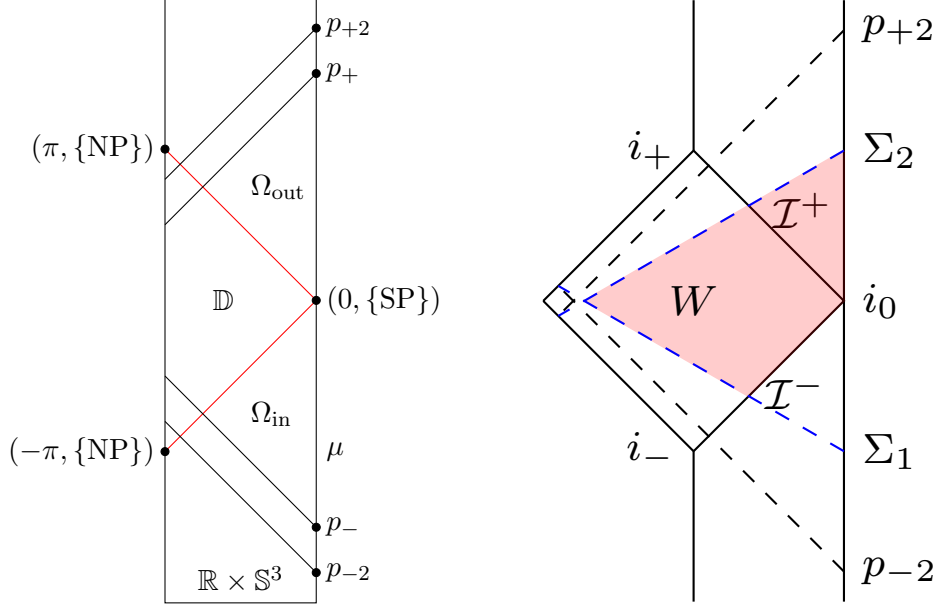

FIGURE 8. **Left:** Penrose diagram. The red curves correspond to 3-dimensional light-like surfaces \mathcal{I}^- and \mathcal{I}^+ . Note that in the case when the metric g in $\mathbb{R}^3 \times \mathbb{R}$ is time-independent, the metric \tilde{g} may be non-smooth near the points $i_+ = (\pi, \{\text{NP}\})$ and $i_- = (-\pi, \{\text{NP}\})$. Also, $i_0 = (0, \{\text{SP}\})$. **Right:** It suffices to consider the non-linear wave equation in the red shaded set W . The boundary ∂W consists of the past part that is a subset of \mathcal{I}^- and subset of a Cauchy surface of $N_1 = I_{N_{\text{ext}}}^+(p_{-2})$ and the future part Σ_f that is a subset of a smooth space-like surface.

2.0.4. *Two time functions defining foliations.* Let us make the following auxiliary construction.

Let (see Figure 8 (Left))

$$N_1 = I_{(N_{\text{ext}}, g_{\text{ext}})}^+(p_{-2}), \quad N_2 = I_{(N_{\text{ext}}, g_{\text{ext}})}^-(p_{+2}).$$

Also, let $N_{12} = N_1 \cap N_2$. Observe that (N_1, g_{ext}) , (N_2, g_{ext}) and (N_{12}, g_{ext}) are globally hyperbolic manifolds and $\overline{\mathbb{D}_0} = J_{(N_{\text{ext}}, g_{\text{ext}})}^-(p_+) \cap J_{(N_{\text{ext}}, g_{\text{ext}})}^+(p_-)$ is a compact subset of N_1 as well as a compact subset of N_2 .

As (N_j, g_{ext}) , $j = 1, 2$ are globally hyperbolic manifolds, by [18], both these Lorentzian manifolds have a smooth time function

$$(64) \quad \mathbf{t}_j : N_j \rightarrow \mathbb{R}$$

such that

$$\Sigma_j(T) = \{x \in N_j \mid \mathbf{t}_j(x) = T\}, \quad T \in \mathbb{R}$$

are smooth Cauchy surfaces of N_j .

Let us next consider N_1 . We denote

$$E^k([T', T'']) = \bigcap_{j=0}^k C^j([T', T'']; H^{j-k}(\Sigma_1(T)))$$

and

$$E_0^k([T', T'']) = \bigcap_{j=0}^k C_0^j([T', T'']; H^{j-k}(\Sigma_1(T)))$$

The above setting is useful when we consider the non-linear scattering problem on the set

$$(65) \quad W := \{x \in N_1 \mid \mathbf{t}_1(x) > T_1\} \cap \{x \in N_2 \mid \mathbf{t}_2(x) < T_2\} \setminus N^-$$

(see Figure 8, Right) and

$$(66) \quad W_0 := \{x \in N_1 \mid \mathbf{t}_1(x) > T_1\} \cap \{x \in N_2 \mid \mathbf{t}_2(x) < T_2\},$$

where $T_1, T_2 \in \mathbb{R}$ are chosen so that $\overline{\mathbb{D}_0} \subset W_0^{\text{int}}$.

We will next consider a non-linear wave equation in the domain W that is relatively compact in N_{ext} , see Figure 8. Observe that the set W can be covered with a finite number of coordinate neighborhoods of N_{ext} . We consider W primarily as a subset of a globally hyperbolic N_1 space.

Note that the surfaces $\Gamma := \{x \in N_1 \mid \mathbf{t}_1(x) = T_1\} \cap \{x \in N_2 \mid \mathbf{t}_2(x) = t\}$ are not necessarily smooth but we are going to consider the initial and boundary values which will imply that the solutions of the wave equations vanish identically near $\{x \in N_1 \mid \mathbf{t}_1(x) = T_1\}$.

Below, we use

$$T_1^- < \min_{x \in \overline{W}} \mathbf{t}_1(x), \quad T_1^+ > \max_{x \in \overline{W}} \mathbf{t}_1(x).$$

3. SCATTERING FUNCTIONALS AND THE SOURCE-TO-SOLUTION OPERATOR

3.1. Existence of scattering functionals. For $T_1 < 0$ let

$$\mathcal{I}^-(T_1) := \mathcal{I}^- \cap \{x \in N_1 \mid \mathbf{t}_1(x) > T_1\}$$

be the part of the past light-like infinity \mathcal{I}^- , see Figure 8, Right. In the next theorem, we consider the well-posedness of the direct problem. For several physically relevant non-linear wave equations (e.g., with cubic or similar non-linear terms), more general existence results can be obtained using the Baez-Segal-Zhou method [8, 9], but in the theorem below we will construct special solutions whose extension to the non-physical part of the space-time N_- vanish in $N_- \cap U_0$, where U_0 is a neighborhood of the spatial infinity i_0 as it is convenient to analyze below the (conormal) singularities of such solutions.

Theorem 5. *Let $k \geq 5$ and $\kappa \geq 4$. Let $-\pi < t_1 < 0$. Let $T_1 < 0$ be such that $S_-(R(t_1)) \subset \mathcal{I}^-(T_1)$. Moreover, let $T_2 > 0$ be such that $\mathbf{t}_2(p_+) < T_2$ and W and W_0 be the sets given in (65) and (66). Then,*

- (i) *There exist $\varepsilon_0(t_1, T_1) > 0$ and $C_0 = C_0(t_1, n)$ such that when $0 < \varepsilon < \varepsilon_0(t_1, T_1)$ and $G \in H^{k+1}(\mathcal{I}^-) \cap \mathcal{B}_-(R(t_1))$ and $\|G\|_{H^{k+1}(\mathcal{I}^-)} < \varepsilon$, the nonlinear Cauchy-Goursat problem*

$$(67) \quad \begin{cases} \square_{g_{\text{ext}}} \tilde{u} + B\tilde{u} + A\tilde{u}^\kappa = 0, & \text{in } W, \\ \tilde{u} = G, & \text{on } \mathcal{I}^-(T_1), \\ \tilde{u} = 0, & \text{on } \{x \in W \mid \mathbf{t}_1(x) < T_1\}, \end{cases}$$

has a unique solution $\tilde{u} \in H^k(W)$ satisfying $\|\tilde{u}\|_{H^k(W)} \leq C_0\varepsilon$.

(ii) For any $n \in \mathbb{Z}_+$ there exist $\varepsilon_1(n) > 0$ and $C_1 = C_1(n)$ such that if $0 < \varepsilon < \varepsilon_1(n)$ and $\tilde{f} \in H_0^{k+1}(K_n)$ is such that

$$(68) \quad \|\tilde{f}\|_{H^{k+1}(K_n)} \leq \varepsilon$$

then the solution $\tilde{w} \in H^k(W_0)$ (that exists due to Lemma 2)

$$(69) \quad \begin{cases} \square_{g_{\text{ext}}} \tilde{w} + B\tilde{w} + A\tilde{w}^\kappa = \tilde{f}, & \text{in } W_0, \\ \tilde{w}(x) = 0 & \text{for } \mathbf{t}_1(x) < T_1. \end{cases}$$

and $G = \tilde{w}|_{\mathcal{I}^-}$ satisfy $G \in \mathcal{B}_- \cap H^k(\mathcal{I}^-)$ and $\|G\|_{H^k(\mathcal{I}^-)} \leq C_1\varepsilon$.

(iii) There exist $\varepsilon_2(t_1, T_1) > 0$, $C_2 = C_0(t_1, T_1)$ and $n_0 = n_0(t_1, T_1)$ such that when $0 < \varepsilon < \varepsilon_2(t_1, T_1)$, $G \in H^{k+1}(\mathcal{I}^-) \cap \mathcal{B}_-(R(t_1))$, $\|G\|_{H^{k+1}(\mathcal{I}^-)} < \varepsilon$, and \tilde{u} solves (67), then there is $\tilde{f} \in H^k(K_{n_0})$ satisfying (68) and the solution $\tilde{w} \in H^k(W)$ of (69) such that $\tilde{w}|_W = \tilde{u}$, and $G = \tilde{w}|_{\mathcal{I}^-}$ and $\|\tilde{f}\|_{H^k(K_{n_0})} \leq C_2\varepsilon$.

The claim (i) and the Sobolev embedding theorem imply that under the assumptions on h_- given in the claim, the scattering problem (18)-(20) has a solution.

Proof. (i) As $G \in \mathcal{B}_-(R(t_1))$, it follows from the definitions of $\mathcal{B}_-(R)$ and $R(t_1)$ that there are $(\phi_0, \phi_1) \in \mathcal{E}'(P(R(t_1)))^2$ and a solution \tilde{v} of (27)-(28), that is,

$$(70) \quad \begin{aligned} (\partial_T^2 - \Delta_{\mathbb{S}^3} + 1)\tilde{v} &= 0, & \text{on } \mathbb{R} \times \mathbb{S}^3, \\ (\tilde{v}|_{T=0}, \partial_T \tilde{v}|_{T=0}) &= (\phi_0, \phi_1), \end{aligned}$$

such that $\tilde{v}|_{\mathcal{I}^-} = G$. Moreover, by using the finite speed of wave propagation and the strong Huygens' principle, we see that the function \tilde{v} vanishes in the open set $V_0 = (\mathbb{R} \times \mathbb{S}^3) \setminus S(R(t_1))$ that contains i_0 and i_- .

Recall that $\hat{\mu}(s) = (s, \text{SP})$. We see that there are $t'_{-1}, t'_{-2} \in (0, -2\pi)$, $t'_{-1} > t'_{-2}$ such that for $S(R(t_1)) \cap \hat{\mu}(0, -2\pi) \subset \hat{\mu}(t'_{-2}, t'_{-1})$. Then, $S(R(t_1)) \subset \{\gamma_{p,\xi}(\mathbb{R}_+) \mid p \in \hat{\mu}(t'_{-2}, t'_{-1}), \xi \in L_p^+(\mathbb{R} \times \mathbb{S}^3)\}$.

Let now $0 > t'_0 > t'_{-1}$. Then, for the values $0 > t'_0 > t'_{-1} > t'_{-2} > -2\pi$ and the points $p'_0 = (t'_0, \text{SP})$, $p'_{-1} = (t'_{-1}, \text{SP})$ and $p'_{-2} = (t'_{-2}, \text{SP})$ it holds that the set $B = J_{N^-}^-(p'_{-1}) \cap J_{N^-}^+(p'_{-2})$, is a compact set $B \subset (N^-)^{\text{int}}$ that satisfies ¹

$$(71) \quad B \subset I_{N^-}^-(p'_0),$$

$$(72) \quad (S(R) \cap N^-) \setminus I^-(p'_0) \subset I_{N^-}^+(B^{\text{int}}).$$

Let $n \in \mathbb{Z}_+$ be such that the compact set $K_n \subset N^-$ satisfies

$$(73) \quad \begin{aligned} B &\subset (K_n)^{\text{int}}, \\ J^+(B) \cap J^-(p'_0) &\subset (K_n)^{\text{int}}. \end{aligned}$$

As $G \in \mathcal{B}_-(R(t_1))$, the solution \tilde{v} of (70) satisfies

$$(74) \quad \text{supp}(\tilde{v}) \subset S(R), \quad \text{supp}(G) \subset S_-(R) = S(R) \cap \mathcal{I}^-.$$

As $\|G\|_{H^{k+1}(\mathcal{I}^-)} < \varepsilon$, the formula (74) and the energy estimate for the Goursat problem in the set $S(R) \subset \mathbb{R} \times \mathbb{S}^3$, we see using Proposition 1 in the

¹See the blue set in the Figure 3, Right.

Appendix for the linear wave equation that there is $C_1 = C_1(t_1)$ such that $\phi_0 = \tilde{v}|_{T=0} \in H^{k+1}(\mathbb{S}^3)$ and $\phi_1 = \partial_T \tilde{v}|_{T=0} \in H^k(\mathbb{S}^3)$ satisfy

$$(75) \quad \|\phi_0\|_{H^{k+1}(\mathbb{S}^3)} + \|\phi_1\|_{H^k(\mathbb{S}^3)} \leq C_1(t_1)\varepsilon.$$

These and the standard energy estimates for the Cauchy problem for the linear wave equation, see [101, Prop. 9.12] and [29, Thm. 3.7, p. 596], imply that the solution \tilde{v} of (70) satisfies

$$\tilde{v} \in \bigcap_{\ell=0}^{k+1} C^\ell([-2\pi, 2\pi]; H^{k-\ell}(\mathbb{S}^3)) \subset H^{k+1}([-2\pi, 2\pi] \times \mathbb{S}^3)$$

and there is $C'_2(t_1) > 0$ such that

$$(76) \quad \|\tilde{v}\|_{H^{k+1}([-2\pi, 2\pi] \times \mathbb{S}^3)} \leq C'_2(t_1)\varepsilon.$$

Let us now choose a function $\rho \in C^\infty(\mathbb{R} \times \mathbb{S}^3)$ such that

$$(77) \quad \rho(x) = 1, \quad \text{for } x \in S(R) \setminus I_{N^-}^-(p'_0),$$

$$(78) \quad \text{supp}(\rho) \subset I_{\mathbb{R} \times \mathbb{S}^3}^+(K_n),$$

$$(79) \quad \text{supp}(\rho) \cap I_{N^-}^-(p'_0) \subset K_n.$$

Let us define

$$(80) \quad \tilde{v}_1(x) = \rho(x)\tilde{v}(x), \quad \text{for } x \in \mathbb{R} \times \mathbb{S}^3.$$

Then, \tilde{v}_1 satisfies the equation

$$(81) \quad \begin{aligned} (\partial_T^2 - \Delta_{\mathbb{S}^3} + 1)\tilde{v}_1 &= \tilde{f}, \quad \text{on } \mathbb{R} \times \mathbb{S}^3, \\ \text{supp}(\tilde{v}_1) &\subset J^+(\text{supp}(\tilde{f})). \end{aligned}$$

As $\rho = 1$ in $S(R) \setminus I_{N^-}^-(p'_0)$, we have $\text{supp}(\tilde{f}) \cap I_{N^-}^-(p'_0) = \emptyset$. Moreover, by (79), $\text{supp}(\tilde{f}) \cap I_{N^-}^-(p'_0) \subset K_n$. These yield that

$$(82) \quad \text{supp}(\tilde{f}) \subset K_n.$$

Moreover, as $\rho = 1$ on $\mathcal{I}^- \cap S(R)$, the formula (77) implies that

$$(83) \quad \tilde{v}|_{\mathcal{I}^-} = G.$$

Then, by using formulas (76), (80), and (81) we see that

$$(84) \quad \|\tilde{f}\|_{H^k([-2\pi, 2\pi] \times \mathbb{S}^3)} \leq C'_3(t_1, n)\varepsilon.$$

When we consider K_n as a compact subset of N_1 , we see that there is $T_1 \in \mathbb{R}$ such that $K_n \subset \{x \in N_1 \mid \mathbf{t}_1(x) > T_1\}$.

Observe that the function $\tilde{f}|_{(N^-)^{\text{int}}}$ in $H^k((N^-)^{\text{int}})$ that is compactly supported in $K_n \subset (N^-)^{\text{int}}$ can be continued from the set N^- by zero to a function in N_1 so that the obtained function, that we continue to denote by \tilde{f} , satisfies $\tilde{f} \in E^{k-1}([T_1^-, T_1^+])$ and $\|\tilde{f}\|_{E^{k-1}([T_1^-, T_1^+])} \leq C_3(t_1, n)\varepsilon$.

By using local existence results for the Cauchy problem for the non-linear wave equation on the globally hyperbolic manifold N_1 with a source supported in the compact set K_n , see [29, Thm. 3.12], we see that when ε is assumed to be small enough, there exists $\tilde{w} \in \bigcap_{\ell=0}^k C^\ell([T_1^-, T_1^+]; H^{k-\ell}(\Sigma_1(T)))$

that satisfies

$$(85) \quad \begin{cases} \square_{g_{\text{ext}}} \tilde{w} + B\tilde{w} + A\tilde{w}^\kappa = \tilde{f}, & \text{in } \{x \in N_1 \mid \mathbf{t}_1(x) < T_1^+\}, \\ \tilde{w}(x) = 0 & \text{for } \mathbf{t}_1(x) < T_1^- \end{cases}$$

and

$$\|\tilde{w}\|_{E^k(T_1^-, T_1^+)} \leq C'_4(t_1, n)\varepsilon.$$

Observe that in N^- we have $\tilde{w} = \tilde{v}_1$, as the functions A and B vanishes in N^- and the function \tilde{f} is supported in the set where $\mathbf{t}_1(x) \geq T_1^-$. Thus, $\tilde{w} = \tilde{v}_1 = \tilde{v} = G$ on \mathcal{I}^- . Hence, $\tilde{u} = \tilde{w}|_W$ is a solution of

$$(86) \quad \begin{cases} \square_{g_{\text{ext}}} \tilde{u} + B\tilde{u} + A\tilde{u}^\kappa = 0, & \text{in } W, \\ \tilde{u} = G, & \text{on } \mathcal{I}^-(T_1), \\ \tilde{u} = 0, & \text{on } \{x \in W \mid \mathbf{t}_1(x) < T_1\}, \end{cases}$$

and satisfies $\|\tilde{w}\|_{H^k(W)} \leq C_4\varepsilon$.

Summarizing the above, we have shown that when ε is small enough, for any $G \in \mathcal{B}_-(R(t_1))$ satisfying $\|G\|_{H^{k+1}(\mathcal{I}^-)} < \varepsilon$, there is \tilde{f} satisfying $\|\tilde{f}\|_{H^k(W)} \leq C_5\|G\|_{H^{k+1}(\mathcal{I}^-)}$, and a unique solution \tilde{w} for the equation (85) and that $\tilde{u} = \tilde{w}|_W$ is a solution for the equation (86). In particular, we have shown the existence of solutions for the equation (86).

Next, we consider the uniqueness of the solutions for the equation (86). The results of Nicolas [94] for the linear wave equation imply, see the Proposition 3 in the Appendix, for the Goursat problem for the non-linear equation that the solution \tilde{u} of (86), when it exists, is unique. This yields the claim (i).

(ii) For any n there is $R = R_n$ such that $K_n \subset S(R)$. As the coefficient A of the non-linear term vanishes in N^- , we see that the solution \tilde{w} of (85) coincides with the solution of the corresponding linear wave equation and thus by the strong Huygen's principle [84], $\text{supp}(\tilde{w}) \cap N^-$ is contained in $S(R)$. Hence $\tilde{w}|_{\mathcal{I}^-} \in \mathcal{B}^-(R)$. By Lemma 2, $\tilde{w}|_{\mathcal{I}^-} \in H^k(\mathcal{I}^-)$. These imply the claim (ii).

Finally the claim (iii) follows by the construction of \tilde{f} given in the proof of the claim (i). \square

Let $\kappa \geq 4$, $-\pi < t_1 < 0$ and $q \in \mathcal{I}^+$. For t_2 , we choose $T_2 \in \mathbb{R}$ such that

$$(87) \quad p_+, q \in \{x \in W \mid \mathbf{t}_2(x) < T_2\}.$$

By Theorem 5, there are $\varepsilon > 0$ and C_0 such that if $h_- \in H_0^{k+1}(\mathcal{I}^-) \cap \mathcal{B}_-(R(t_1))$ then the nonlinear Cauchy-Goursat problem (67) with $G = h_-$ has a unique solution \tilde{u} . Let us denote $u(x) = \omega_M(x)\tilde{u}(x)$ the solution of the non-linear scattering problem

$$(88) \quad \begin{cases} \square_{g_M} u(x) + d(x)u(x) + a(x)u(x)^\kappa = 0, & \text{in } \{x \in M \mid \mathbf{t}_2(x) < T_2\} \\ u(x) = h_-(x) & \text{on } \mathcal{I}^- \cap \{x \in M \mid \mathbf{t}_2(x) < T_2\}, \\ u = 0 & \text{on } M \setminus J_M^+(\text{supp}(h_-)), \end{cases}$$

that satisfies

$$\|\omega_M^{-1}\tilde{u}\|_{C([T_1^-, T_1^+]; H^k(\Sigma_1(T))) \cap C^k([T_1^-, T_1^+]; L^2(\Sigma_1(T)))} < C_0\varepsilon.$$

In the set

$$(89) \quad \mathcal{D}(S_{t_1,q}) = \mathcal{D}_{(\varepsilon)}(S_{t_1,q}) = \{h \in H^k(\mathcal{I}^-) \cap \mathcal{B}_-(R(t_1)) \mid \|h\|_{H^k(\mathcal{I}^-)} < \varepsilon\}$$

we have a well-defined map

$$(90) \quad S_{t_1,q} : \mathcal{D}(S_{t_1,q}) \rightarrow \mathbb{R},$$

$$(91) \quad S_{t_1,q}(h_-) = \tilde{u}(q),$$

where \tilde{u} solves (88). In particular, this implies that the scattering functionals $S_{t_1,q}$ are well-defined.

The next goal is to study the globally hyperbolic space-time $(N_{\text{ext}}, g_{\text{ext}})$, where the sources are supported in N^- and the waves are observed on N^- , and aim to construct the conformal type of $(\mathbb{D}, g_{\text{ext}})$. We recall that g_{ext} coincides with g_N within N .

We recall that $\mathcal{V}_n \subset H_0^k(K_n)$ are sufficiently small neighborhoods of the zero function and we have defined the source-to-solution maps

$$(92) \quad L_{g_{\text{ext}}, B, A, p_+, K_n} : \mathcal{V}_n \subset H_0^k(K_n) \rightarrow L^2(N^+),$$

that map $L_{g_{\text{ext}}, B, A, p_+, K_n} f = u|_{N^+}$, where u solves (40).

3.2. Scattering functionals determine the source-to-solution operator. Next we prove Theorem 3, that is, the scattering functional determine the near field measurements, i.e., source-to-solution operator.

Proof. (of Theorem 3) Given a source $f \in \mathcal{V}_n \subset H_0^k(K_n)$, we solve on both manifolds $N_{\text{ext}}^{(j)}$ the following linear initial value problem

$$(93) \quad \begin{cases} (\square_{g_{\text{ext}}} + B)u^{(j)} = f, & \text{in } N_{\text{ext}}^{(j)}, \\ \text{supp}(u^{(j)}) \subset J_{N_{\text{ext}}^{(j)}}^+(\text{supp}(f)). \end{cases}$$

In N^- it holds that $u^{(j)} = \tilde{u}^{(j)}|_{N^-}$ where $\tilde{u}^{(j)}$ is the wave equation

$$(94) \quad \begin{aligned} (\partial_T^2 - \Delta_{\mathbb{S}^3} + 1)\tilde{u}^{(j)} &= f, & \text{on } \mathbb{R} \times \mathbb{S}^3, \\ \text{supp}(\tilde{u}^{(j)}) &\subset J^+(\text{supp}(f)). \end{aligned}$$

The strong Huygen's principle, see [84], implies then that

$$\text{supp}(\tilde{u}^{(j)}) \subset \{\gamma_{x,\xi}(s) \mid x \in \text{supp}(f), \xi \in L_x^+(\mathbb{R} \times \mathbb{S}^3), s \geq 0\}.$$

Recall that $\text{supp}(f) \subset K_n$ where $K_n \subset (N^-)^{\text{int}} \subset I^-(i_0)$ is compact and that no geodesics connecting a point $x \in K_n$ to i_0 is light-like. This and the strong Huygen's principle imply that i_0 has a neighborhood $V_0 \subset \mathbb{R} \times \mathbb{S}^3$ such that $\text{supp}(\tilde{u}^{(j)}) \cap V_0 = \emptyset$. Moreover, by causality, $\tilde{u}^{(j)}$ vanishes in a neighborhood of i_- . These imply that

$$(95) \quad \tilde{u}^{(j)}|_{\mathcal{I}^-} \in \mathcal{B}_-(R(t_1))$$

with some $-\pi < t_1 < 0$.

As the subsets N^- of the manifolds $N_{\text{ext}}^{(j)}$, $j = 1, 2$ coincide on both manifolds (i.e. those are isometric), the boundary values of the solutions on \mathcal{I}^- coincide,

$$(96) \quad u^{(1)}|_{\mathcal{I}^-} = u^{(2)}|_{\mathcal{I}^-}.$$

By assumption, scattering functionals $S_{M^{(j)}, g_M^{(j)}, a^{(j)}; t_1, q} = S_{t_1, q}^{(j)}$, $j = 1, 2$ coincide for all $-\pi < t_1 < 0$ and $q \in \mathcal{I}^+$.

Let us next use $-\pi < t_1 < 0$ such that for $R = R(t_1)$ the condition

$$(97) \quad \mathcal{B}(K_n) \subset S(R)$$

holds, where

$$(98) \quad \mathcal{B}(K_n) := \{\gamma_{x, \xi}(s) \mid x \in K_n, \xi \in L_x^+(\mathbb{R} \times \mathbb{S}^3), s \geq 0\}.$$

Moreover, we use $q \in \mathcal{I}^+$ such that

$$J_{N^+}^-(p_+) \cap \mathcal{I}^+ \subset \mathcal{I}^+(q).$$

Then, for any $q' \in \mathcal{I}^+(q)$

$$(99) \quad u^{(1)}|_{\mathcal{I}^+(t_2)}(q') = S_{t_1, q}^{(1)} u^{(1)}(q') = S_{t_1, q}^{(2)} u^{(2)}(q') = u^{(2)}|_{\mathcal{I}^+(t_2)}(q').$$

Using $h_+ = u^{(1)}|_{\mathcal{I}^+(t_2)}$, we solve for both manifolds $(M^{(j)}, g_M^{(j)})$, $j = 1, 2$ a linear Goursat problem

$$(100) \quad \begin{cases} (\square_{g_{\text{ext}}^{(j)}} + B^{(j)})u^{(j)} = 0, & \text{in } x \in N^+ \cap J_{N_{\text{ext}}^{(j)}}^-(p_+), \\ u^{(j)}|_{\mathcal{I}^+ \cap J_{N_{\text{ext}}^{(j)}}^-(p_+)} = h_+. \end{cases}$$

By [59, 94], the Goursat problem (100) has a unique solution in $H^1(N^+ \cap J_{N_{\text{ext}}^{(j)}}^-(p_+))$. Hence, we see that the solutions of the equations (100) with $j = 1, 2$ (defined using the two manifolds $(M^{(j)}, g^{(j)})$) coincide on the set $N^+ \cap J_{N_{\text{ext}}^{(1)}}^-(p_+) = N^+ \cap J_{N_{\text{ext}}^{(2)}}^-(p_+)$. This implies that the source-to-solution operators satisfy $L_{g_{\text{ext}}, 1, B_1, A_1, p_+, K_n}(f) = L_{g_{\text{ext}}, 2, B_2, A_2, p_+, K_n}(f)$ for all $f \in \mathcal{V}_n$. This proves the claim. \square

4. MICROLOCAL ANALYSIS OF THE SOURCE-TO-SOLUTION OPERATOR

Below, we consider the inverse problem when the sources are supported in $K_n \subset (N^-)^{\text{int}}$ and the waves are observed in $(N^+)^{\text{int}}$. As $(N^-)^{\text{int}}$ is in the chronological past of i_0 and $(N^+)^{\text{int}}$ is in the chronological future of i_0 , the set where the sources are supported and the set where the wave are observed are causally separated. This situation causes difficulties: As an example, let us consider the Lorentzian manifold $\mathbb{R} \times \mathbb{S}^3$ and the sets $\omega_j = (-2j\pi, 0) \times \mathbb{S}^3$, $j = 1, 2$. For the sake of presenting a simple example, let us assume that we can use sources on $(\mathbb{R} \times \mathbb{S}^3) \setminus \omega_j$ and make observations on the set $U = (0, \infty) \times \mathbb{S}^3$ to determine the light observation sets of points q in ω_j , that is,

$$\mathcal{E}_U(\omega_j) = \{\mathcal{E}_U(q) \mid q \in \omega_j\}.$$

Then, as all great circles of \mathbb{S}^3 are closed geodesics of length 2π , we see that $\mathcal{E}_U(\omega_1) = \mathcal{E}_U(\omega_2)$, that is, the light observation sets of points in ω_1 and ω_2 coincide and these sets are indistinguishable using light observation sets. Observe that $\mathbb{R} \times \mathbb{S}^3$ is a special manifold in the sense that antipodal points on \mathbb{S}^3 give rise to conjugate points for light-like geodesics. Due to these observations, below in Section 5, we will consider inverse problem for the source-to-solution maps with causally separated sources and observations paying particular attention to the cut-points and conjugate points. Before

that, in this section we give a modification of the notations on conormal sources and interacting waves introduced in [75,83]. Instead of reconstructing the space-time using a layer striping process done in [75,83], we show that the light observation set $\mathcal{E}_{N^+}(q)$ of the point q can be directly reconstructed if the distant areas of the space-time can be reconstructed when the point q can be connected to the set N^- with a light-like geodesic that have no cut points. Moreover, to be able to change the conformal factor of the metric, we will pay attention to the fact that many of the construction steps are independent of the coefficient B of the zeroth order term in the wave equation.

4.0.1. *Definitions in microlocal analysis and nonlinear interactions.* Below, we use that N_{ext} and its subset W are globally hyperbolic Lorentzian manifolds of dimension $(1+3)$. Observe that below the coefficient B is allowed to be a general smooth function on N_{ext} . To simplify the notations, we denote the metric g_{ext} of N_{ext} just by g . We will consider the equation

$$(101) \quad \begin{cases} (\square_g + B)u + Au^\kappa = f, & \text{in } W, \\ u = 0, & \text{in } W \setminus J^+(p^-), \end{cases}$$

where $f \in \cup_n \mathcal{V}_n \subset H_0^k(\Omega_{\text{in}} \setminus J^+(p^-))$. We assume that we are given the source-to-solution maps $L_{g_{\text{ext}}, B, A, p_+, K_n} : f \mapsto u|_{N^+ \cap I_{N_{\text{ext}}}^-(p_+)}$ where $p_+ \in \widehat{\mu}(0, \pi)$.

Below, we use for a pair $(x, \xi) \in TN_{\text{ext}}$ the notation

$$(x(t), \xi(t)) = (\gamma_{x, \xi}(t), \dot{\gamma}_{x, \xi}(t)).$$

Let g^+ be a smooth Riemannian metric on N_{ext} .

Let $\eta_0 \in L_{i_0}^+ N_{\text{ext}}$, $\|\eta_0\|_{g^+} = 1$. Since $\rho(x, \xi)$ on (N_{ext}, g) is lower semi-continuous and $\overline{\mathbb{D}}_0 = J^+(p^-) \cap J^-(p^+)$ is compact, we see that for all $\varepsilon_0 > 0$ there are $\delta_0, \delta_1 > 0$ such that for $\widehat{x} = \mu_{\text{in}}(s_0)$, $-\delta_0 \leq s_0 \leq 0$, $x \in \mathbb{D}_0$, with $d_{g^+}(x, \widehat{x}) < \delta_1$ and $\xi \in L_x^+ N_{\text{ext}}$, with $\|\xi\|_{g^+} = 1$, we have $\rho(x, \xi) > \rho(i_0, \eta_0) - \varepsilon_0$.

4.0.2. *Observation time functions.* Let us define the observation time functions as in [75]:

Definition 6. Let $\mu : [s^-, s^+] \rightarrow N_{\text{ext}}$ be a time-like path. We define $f_\mu^+(x), f_\mu^-(x) \in \mathbb{R}$ by the formulae

$$\begin{aligned} f_\mu^+(x) &:= \inf(\{s \in [s^-, s^+] \mid \tau(x, \mu(s)) > 0\} \cup \{s^+\}), \\ f_\mu^-(x) &:= \sup(\{s \in [s^-, s^+] \mid \tau(\mu(s), x) > 0\} \cup \{s^-\}). \end{aligned}$$

The value $f_\mu^+(x)$ is called the earliest observation time from the point x on the path μ .

4.0.3. *Notation for the sources and Lagrangian submanifolds.* We will consider sources supported in Ω_{in} and observations made in Ω_{out} . For $x_0 \in \Omega_{\text{in}}$, $\zeta_0 \in L_{x_0}^+ N_{\text{ext}}$, and $s_0 > 0$ we define

$$(102) \quad \mathcal{V}_{x_0, \zeta_0, s_0} = \{\eta \in T_{x_0} N_{\text{ext}} \mid \|\eta - \zeta_0\|_{g^+} < s_0, \|\eta\|_{g^+} = \|\zeta_0\|_{g^+}\}.$$

Let $\mathcal{W}_{x_0, \zeta_0, s_0} = L_{x_0}^+ N_{\text{ext}} \cap \mathcal{V}_{x_0, \zeta_0, s_0}$ and define

$$(103) \quad K(x_0, \zeta_0, s_0) = \{\gamma_{x_0, \eta}(t) \in N_{\text{ext}} \mid \eta \in \mathcal{W}_{x_0, \zeta_0, s_0}, t \in (0, \infty)\}.$$

We also define

$$(104) \quad \begin{aligned} \Sigma(x_0, \zeta_0, s_0) &= \{(x_0, r\eta^b) \in T^*N_{\text{ext}} \mid \eta \in \mathcal{V}_{x_0, \zeta_0, s_0}, r \in \mathbb{R} \setminus \{0\}\}, \\ \Lambda(x_0, \zeta_0, s_0) &= \{(\gamma_{x_0, \eta}(t), r\dot{\gamma}_{x_0, \eta}(t)^b) \in T^*N_{\text{ext}} \mid \eta \in \mathcal{W}_{x_0, \zeta_0, s_0}, \\ &\quad t \in (0, \infty), r \in \mathbb{R} \setminus \{0\}\}. \end{aligned}$$

Observe that $\Lambda(x_0, \zeta_0, s_0)$ is a Lagrangian submanifold of N_{ext} . Roughly speaking, near the points where K is a smooth manifold, Λ is its conormal bundle. Intuitively, K is the light-cone associated to a small spherical cap \mathcal{V} , Σ is the vertex of this cone in the cotangent space, c.f. [120, 121] or related results on scattering from corners, and Λ is the set to which this spherical cap propagates under the Hamiltonian flow. At the limit $s_0 \rightarrow 0$ the set K tends to the geodesic $\gamma_{x_0, \eta}$. We will soon construct sources with singularities on Σ . The corresponding solutions propagate along geodesics and their singularities propagate in Λ . This allows us to use the conormal calculus to study singularities produced in collision of such waves.

Let $p(x, \xi) = g^{ij}\xi_i\xi_j$ be the principal symbol of \square_g . The Hamilton vector field of p is denoted by H_p and it is given in local coordinates by

$$H_p = \sum_{j=0}^3 \left(\frac{\partial p}{\partial \xi_j} \frac{\partial}{\partial x^j} - \frac{\partial p}{\partial x^j} \frac{\partial}{\partial \xi_j} \right).$$

The integral curves of H_p are called null bicharacteristics, denoted by Θ . We denote by $\Theta_{x, \xi}$ the bicharacteristic containing $(x, \xi) \in L^*N_{\text{ext}}$. It is worth noting that $(y, \eta) \in \Theta_{x, \xi}$ if and only if $(y, \eta^\sharp) = (\gamma_{x, \xi^\sharp}(t), \dot{\gamma}_{x, \xi^\sharp}(t))$ for some $t \in \mathbb{R}$, where γ_{x, ξ^\sharp} is the light-like geodesic with $(x, \xi^\sharp) \in LN_{\text{ext}}$.

Now, denoting by $\text{char}(\square_g) = \{(x, \xi) \in T^*N_{\text{ext}} \mid p(x, \xi) = 0\}$ the characteristic variety of p , we have that $\Lambda(x_0, \zeta_0, s_0)$ is the Lagrangian submanifold that is obtained by flowing-out of $\text{char}(\square_g) \cap \Sigma(x_0, \zeta_0, s_0)$ by the Hamilton flow of p in the future direction.

We will use conormal and Lagrangian distributions to analyse the propagation of singularities. To do this, let us recall some relevant notations and definitions. Suppose X is a smooth n -dimensional manifold and $\Lambda \subset T^*X \setminus \{0\}$ is a Lagrangian submanifold. Let $(x, \theta) \in X \times \mathbb{R}^n$ and $\phi(x, \theta)$ be a non-degenerate phase function, which locally parametrizes Λ near $(x_0, \xi) \in \Lambda$, that is, in some conic neighbourhood $\Gamma \subset T^*X \setminus \{0\}$ the set $\Lambda \cap \Gamma$ coincides with the set $\{(x, d_x\phi(x, \theta)) \in \Gamma \mid d_\theta\phi(x, \theta) = 0\}$. The set of classical Lagrangian distributions $I^m(X; \Lambda)$ is then defined to be those distributions $u \in \mathcal{D}'(X)$ that can be represented in local coordinates $X : V \rightarrow \mathbb{R}^n$, defined in an open set $V \subset X$, as an oscillatory integral (modulo a C^∞ function) of the form

$$u(x) = \int_{\mathbb{R}^N} e^{i\phi(x, \theta)} a(x, \theta) d\theta, \quad x \in V.$$

Here $a(x, \theta) \in S^{m+\frac{n}{4}-\frac{N}{2}}(V; \mathbb{R}^N)$ is a classical symbol of order $m + \frac{n}{4} - \frac{N}{2}$. Corresponding to a classical Lagrangian distribution $u \in I^m(X; \Lambda)$ there is a principal symbol $\sigma_u^{(p)}(x_0, \zeta_0)$, $(x_0, \zeta_0) \in \Lambda$, which satisfies

$$\sigma_u^{(p)}(x_0, \zeta_0) \in S^{m+\frac{n}{4}}(\Lambda, \Omega^{\frac{1}{2}} \times L) / S^{m+\frac{n}{4}-1}(\Lambda, \Omega^{\frac{1}{2}} \times L),$$

where L is the Maslov-Keller line bundle and $\Omega^{\frac{1}{2}}$ is the half-density on X . When Λ is a conormal bundle of a smooth submanifold $S \subset X$, that is, $\Lambda = N^*S$, the distributions $u \in I^m(X; \Lambda)$ are called conormal distributions.

Furthermore, we will need distributions associated to two cleanly intersecting Lagrangians [48,88]. We say that two Lagrangians $\Lambda_0, \Lambda_1 \in T^*X \setminus \{0\}$ intersect cleanly if

$$T_p\Lambda_0 \cap T_p\Lambda_1 = T_p(\Lambda_0 \cap \Lambda_1)$$

for all $p \in \Lambda_0 \cap \Lambda_1$. The set of distributions associated to two Lagrangian manifolds Λ_0 and Λ_1 is denoted by $I^{k,l}(X; \Lambda_0, \Lambda_1)$. It is known that if $u \in I^{k,l}(X; \Lambda_0, \Lambda_1)$, then $\text{WF}(u) \subset \Lambda_0 \cup \Lambda_1$ and moreover microlocally away from $\Lambda_0 \cap \Lambda_1$ we have $u \in I^{k+l}(X; \Lambda_0 \setminus \Lambda_1)$ and $u \in I^k(X; \Lambda_1 \setminus \Lambda_0)$. Since all cleanly intersecting Lagrangian submanifolds with given dimension of intersection are locally equivalent (see [48] or Theorem 3.5.6 of [35]), it will be enough to consider only model Lagrangians in the Euclidean case. Let us denote $(x_1, \dots, x_n) = (x', x'', x''') \in \mathbb{R}^n$, where $x' = (x_1, \dots, x_{d_1})$, $x'' = (x_{d_1+1}, \dots, x_{d_1+d_2})$ and $x''' = (x_{d_1+d_2+1}, \dots, x_n)$. Following [45], we represent the distributions using the Lagrangian distributions

$$\Lambda_0 = N^*\{x' = x'' = 0\} \text{ and } \Lambda_1 = N^*\{x' = 0\}.$$

Then $u \in I^{k,l}(\mathbb{R}^n; \Lambda_0, \Lambda_1)$ can be explicitly written in terms of oscillatory integrals (modulo a C^∞ function) as

$$u(x) = \int_{\mathbb{R}^{d_1+d_2}} e^{i(x' \cdot \theta' + x'' \cdot \theta'')} a(x, \theta', \theta'') d\theta' d\theta''.$$

Here the symbol $a(x, \theta', \theta'') \in S^{\mu_1, \mu_2}(\mathbb{R}^n; (\mathbb{R}^{d_1} \setminus \{0\}) \times \mathbb{R}^{d_2})$ is of product type, that is, $a \in C^\infty(\mathbb{R}^n \times \mathbb{R}^{d_1} \times \mathbb{R}^{d_2})$ and for all compact subsets $K \subset \mathbb{R}^n$ it holds that

$$|\partial_{x''}^\gamma \partial_{\theta'}^\alpha \partial_{\theta''}^\beta a(x, \theta', \theta'')| \leq C_{\gamma\alpha\beta K} (1 + |\theta'| + |\theta''|)^{\mu_1 - |\alpha|} (1 + |\theta''|)^{\mu_2 - |\beta|},$$

for all $x \in K$, where $\mu_1 = k - \frac{n}{4} + \frac{d_1}{2}$ and $\mu_2 = l + \frac{d_2}{2}$.

We will often abbreviate

$$I^p(X; \Lambda) = I^p(\Lambda) \quad \text{and} \quad I^{m_1, m_2}(X; \Lambda_1, \Lambda_2) = I^{m_1, m_2}(\Lambda_1, \Lambda_2).$$

Also, if the cotangent bundles of submanifolds S_j of codimension d_j , $j = 1, 2$, are cleanly intersecting, we will use notations

$$I^\mu(S_1) = I^{\mu + \frac{d_1}{2} - \frac{n}{4}}(N^*S_1) \quad \text{and} \quad I^{\mu_1, \mu_2}(S_1, S_2) = I^{m_1, m_2}(N^*S_1, N^*S_2),$$

where $m_1 = \mu_1 + \mu_2 + d_1/2 - n/4$ and $m_2 = -\mu_2 + d_2/2$. It is occasionally useful to use the embedding $I^\mu(\Lambda) \subset H^s(N_{\text{ext}})$, that is continuous for all $s < -\mu - \frac{n}{4}$.

4.0.4. *Causal inverse of $\square_g + B$.* When $\Lambda_1 \subset T^*N_{\text{ext}}$ is a Lagrangian manifold which intersects the characteristic variety of \square_g , we can consider solutions u_1 of $\square_g u_1 + B u_1 = f_1$, with source $f_1 \in I^m(\Lambda_1)$. As $\Lambda_1 \cap \text{char}(\square_g)$ is not empty, we find that the wavefront set of u_1 is contained in the union of Λ_1 with the bicharacteristics that contain points of the intersection.

More precisely, on globally hyperbolic Lorentzian manifolds the hyperbolic operator $\square_g + B$ has a unique causal inverse operator $Q = (\square_g + B)^{-1}$, see [12, Theorem 3.2.11]. Denoting the Schwartz kernel of the operator Q

again by $Q = Q(x, y)$, we have $Q \in I^{-\frac{3}{2}, -\frac{1}{2}}(\Delta'_{T^*N_{\text{ext}}}, \Lambda_g)$, see [45]. Here $\Delta'_{T^*N_{\text{ext}}}$ denotes the conormal bundle of the diagonal, $\Delta'_{T^*N_{\text{ext}}} = N^*(\{(x, x) \mid x \in N_{\text{ext}}\})$ and $\Lambda_g \subset T^*N_{\text{ext}} \times T^*N_{\text{ext}}$ is the Lagrangian manifold associated to the canonical relation of \square_g , given by,

$$(105) \quad \Lambda_g = \{(x, \xi, y, -\eta) \mid (x, \xi) \in \text{char}(\square_g), (y, \eta) \in \Theta_{x, \xi}\},$$

where $\Theta_{x, \xi}$ is the bicharacteristic of \square_g containing (x, ξ) .

When Λ_0 is a Lagrangian manifold and the intersection $\Lambda_0 \cap \text{char}(\square_g)$ is transversal, the union Λ_1 of bicharacteristics intersecting this set is a Lagrangian manifold.

Lemma 3. *Let n be an integer, $s_0 > 0$, $K = K(x_0, \zeta_0, s_0)$, $\Lambda_1 = \Lambda(x_0, \zeta_0, s_0)$ and $\Sigma = \Sigma(x_0, \zeta_0, s_0)$. Let $(x, \xi) \in \Sigma \cap L^*N_{\text{ext}}$, $v = \xi^\sharp \in L_x N_{\text{ext}}$, $r \in \mathbb{R}$ and $y = \gamma_{x, v}(r)$ and $\eta = (\dot{\gamma}_{x, v}(r))^b$ be such that $x < y$. Assume that $f_1 \in I^{n+1}(\Sigma)$ is a compactly supported distribution with a classical symbol.*

Then $w_1 = (\square_g + B)^{-1} f_1$ satisfies $w_1 \in I^{n-1/2, -1/2}(\Sigma, \Lambda_1)$.

Let $\sigma_{f_1}^{(p)}(x, \xi)$ be the principal symbol of f_1 at (x, ξ) and $\sigma_{w_1}^{(p)}(y, \eta)$ be the principal symbol of w_1 at $(y, \eta) \in \Lambda_1$. Then

$$(106) \quad \sigma_{w_1}^{(p)}(y, \eta) = R(y, \eta, x, \xi) \sigma_{f_1}^{(p)}(x, \xi)$$

where $R = R(y, \eta, x, \xi)$ is an invertible linear operator (or, a non-zero scalar number if Maslov line bundle structure is omitted). Moreover, the function R is independent of the coefficient B .

Proof. The lemma follows from the proof of Lemma 3.1 of [75], but we recall the essential arguments of the proof. Since the Schwartz kernel Q of $(\square_g + B)^{-1}$ satisfies $Q \in I^{-\frac{3}{2}, -\frac{1}{2}}(\Delta'_{T^*N_{\text{ext}}}, \Lambda_g)$, then using $f_1 \in I^{n+1}(\Sigma)$ we get $Qf_1 \in I^{n-\frac{1}{2}, -\frac{1}{2}}(\Sigma, \Lambda_1)$. Let $\pi : T^*N_{\text{ext}} \rightarrow N_{\text{ext}}$ be the projection to the base point of a covector. Considering the restriction of $w = Qf_1$ in the set $N_{\text{ext}} \setminus \pi(\Sigma)$, then using the formula (1.4) of [45], we see that $w|_{N_{\text{ext}} \setminus \pi(\Sigma)} \in I^{n-\frac{1}{2}}(\Lambda_1)$.

In our case, because the manifold is globally hyperbolic, $\Theta_{x, \xi} \cap \Sigma$ contains only a single point and the formula (106) for principal symbols follows from [45], Proposition 2.1 and is given precisely by

$$\sigma_{w_1}^{(p)}(y, \eta) = \sigma(Q)(x, \xi; y, \eta) \sigma_{f_1}^{(p)}(x, \xi),$$

where $(x, \xi) \in \Theta_{x, \xi} \cap \Sigma \subset T^*N_{\text{ext}}$. The function $\sigma(Q)$ does not vanish and one can consider it as a non-zero scalar. Finally, the principal symbol $\sigma_{w_1}^{(p)}$ does not depend on the coefficient B , and thus R is independent of B . \square

4.0.5. κ th order interactions. Let $x_j \in \Omega_{\text{in}}$ and $\zeta_j \in L_{x_j} N_{\text{ext}}$, $j = 1, 2, 3, 4$, and consider the sources

$$(107) \quad f_j \in I^{n+1}(\Sigma(x_j, \zeta_j, s_0)),$$

$n \in \mathbb{R}$, $n < -6$. Let $V = \bigcup_{j=1}^4 \text{supp}(f_j)$ and assume that $V \subset \Omega_{\text{in}}$ and define $\vec{\varepsilon} = (\varepsilon_1, \varepsilon_2, \varepsilon_3, \varepsilon_4)$ and

$$(108) \quad f_{\vec{\varepsilon}} = \sum_{j=1}^4 \varepsilon_j f_j.$$

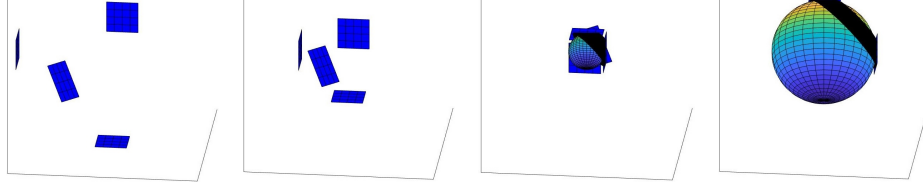

FIGURE 9. The directed conormal sources $\varepsilon_j f_j$, supported in N_- near the past light-like infinity \mathcal{I}^- , produce distorted plane waves u_j . The left and the center left figures show, at the times t_1 and t_2 the singular supports of such waves. When the four waves have non-linear interaction, and produce a wave $\mathcal{U}^{(\kappa)}$, see formula (113), that is similar to a spherical wave produced by a point source. The black, conic waves are produced by 3-interactions. The center right and the right figures show, at the times t_3 and t_4 , the singular supports the distorted plane waves and the interaction waves. Using scattering functionals, one can detect the interaction waves at the future light-like infinity \mathcal{I}^+ and use these data to construct the conformal class of the metric g near $\mathcal{I}^+ \cup \mathcal{I}^- \cup i_0$.

Let $u_{\bar{\varepsilon}}$ be the solution of

$$(109) \quad \begin{cases} (\square_{g_{\text{ext}}} + B)u_{\bar{\varepsilon}} + Au_{\bar{\varepsilon}}^{\kappa} = f_{\bar{\varepsilon}}, & \text{in } I_{N_{\text{ext}}}^-(p_+), \\ \text{supp}(u_{\bar{\varepsilon}}) \subset J^+(\text{supp}(f)). \end{cases}$$

Moreover, assume that

$$(110) \quad \text{supp}(f_j) \cap J^+(\text{supp}(f_k)) = \emptyset, \quad \text{for all } j \neq k \text{ and } \text{supp}(f_j) \subset \Omega_{\text{in}},$$

so that the supports of the sources are causally independent.

These sources give rise to the solutions of the linearized wave equation, which we denote by

$$(111) \quad u_j := \partial_{\varepsilon_j} u_{\bar{\varepsilon}}|_{\bar{\varepsilon}=0} = (\square_g + B)^{-1} f_j \in I(N_{\text{ext}} \setminus \{x_j\}; \Lambda(x_j, \zeta_j, s_0)).$$

We will use the following abbreviations: $\partial_{\bar{\varepsilon}}^1 u_{\bar{\varepsilon}}|_{\bar{\varepsilon}=0} := \partial_{\varepsilon_1} u_{\bar{\varepsilon}}|_{\bar{\varepsilon}=0}$, $\partial_{\bar{\varepsilon}}^2 u_{\bar{\varepsilon}}|_{\bar{\varepsilon}=0} := \partial_{\varepsilon_1} \partial_{\varepsilon_2} u_{\bar{\varepsilon}}|_{\bar{\varepsilon}=0}$, $\partial_{\bar{\varepsilon}}^3 u_{\bar{\varepsilon}}|_{\bar{\varepsilon}=0} := \partial_{\varepsilon_1} \partial_{\varepsilon_2} \partial_{\varepsilon_3} u_{\bar{\varepsilon}}|_{\bar{\varepsilon}=0}$ and

$$\partial_{\bar{\varepsilon}}^4 u_{\bar{\varepsilon}}|_{\bar{\varepsilon}=0} := \partial_{\varepsilon_1} \partial_{\varepsilon_2} \partial_{\varepsilon_3} \partial_{\varepsilon_4} u_{\bar{\varepsilon}}|_{\bar{\varepsilon}=0}$$

and

$$(112) \quad D^{\kappa} u_{\bar{\varepsilon}}|_{\bar{\varepsilon}=0} := \partial_{\varepsilon_1} \partial_{\varepsilon_2} \partial_{\varepsilon_3} \partial_{\varepsilon_4}^{\kappa-3} u_{\bar{\varepsilon}}|_{\bar{\varepsilon}=0}.$$

The result of the fourth-order interactions produced by the waves u_j for the non-linear wave equation, see Figure 9, will be denoted by

$$(113) \quad \mathcal{U}^{(\kappa)} := D^{\kappa} u_{\bar{\varepsilon}}|_{\bar{\varepsilon}=0} = (\square_g + B)^{-1} \mathcal{S},$$

where

$$(114) \quad \mathcal{S} := -\kappa! \cdot Au_1 u_2 u_3 (u_4)^{\kappa-3}.$$

Let now $v_{\bar{\varepsilon}}$ be a solution to $\square_g v_{\bar{\varepsilon}} + Bv_{\bar{\varepsilon}} = f_{\bar{\varepsilon}}$, where $f_{\bar{\varepsilon}} = \sum_{i=1}^4 \varepsilon_i f_i$. By linearity $v_{\bar{\varepsilon}} = \sum_{i=1}^4 \varepsilon_i u_i$, where $\square_g u_i + Bu_i = f_i$. This also implies that for

sufficiently small $\vec{\varepsilon}$,

$$\|u_{\vec{\varepsilon}}\|_{H^\tau(N_{\text{ext}})} \leq C \sum_{i=1}^4 \varepsilon_i \|f_i\|_{H^\tau(N_{\text{ext}})},$$

where $\tau > -n - 2 \geq 4$. Now $\square_g(u_{\vec{\varepsilon}} - v_{\vec{\varepsilon}}) + B(u_{\vec{\varepsilon}} - v_{\vec{\varepsilon}}) + Au_{\vec{\varepsilon}}^\kappa = 0$, which yields

$$(115) \quad u_{\vec{\varepsilon}} = v_{\vec{\varepsilon}} - Q(Au_{\vec{\varepsilon}}^\kappa),$$

where Q is the causal inverse of $\square_g + B$.

By a direct calculation, one sees that

$$u_{\vec{\varepsilon}}^\kappa = (v_{\vec{\varepsilon}} - Q(Au_{\vec{\varepsilon}}^\kappa))^\kappa = v_{\vec{\varepsilon}}^\kappa + R,$$

where R contains all terms which are $O(\varepsilon_1^{k_1} \varepsilon_2^{k_2} \varepsilon_3^{k_3} \varepsilon_4^{k_4})$, $k_1 + k_2 + k_3 + k_4 > \kappa$ in the space $H^\tau(N_{\text{ext}})$. Furthermore, substituting this back to (115) yields

$$u_{\vec{\varepsilon}} = v_{\vec{\varepsilon}} - Q(Av_{\vec{\varepsilon}}^\kappa) + R.$$

When we compute the derivatives of this equation with respect to ε_j 's, we obtain, see [82] for the details on computing the derivatives (113). This shows that we only need to consider these interactions of order κ . However, we need to keep in mind also regions where only three waves interact, since there can be problems in the symbol calculus in this case.

Definition 7. *The geodesics corresponding to $(\vec{x}, \vec{\xi}) = ((x_j, \xi_j))_{j=1}^4$ intersect and the intersection takes place at $q \in N_{\text{ext}}$ if there are $t_j > 0$ such that $q = \gamma_{x_j, \xi_j}(t_j)$ for all $j = 1, 2, 3, 4$. The intersection is regular if $t_j \in (0, \rho(x_j, \xi_j))$ and the vectors $\dot{\gamma}_{x_j, \xi_j}(t_j) \in T_q N_{\text{ext}}$, $j = 1, 2, 3, 4$, are linearly independent.*

Now, for $q \in N_{\text{ext}}$ let Λ_{int} be the Lagrangian manifold

$$(116)$$

$$\Lambda_{\text{int}} := \{(y, \eta) \in T^* N_{\text{ext}} \mid y = \gamma_{q, \zeta}(1), \eta^\sharp = r \dot{\gamma}_{q, \zeta}(1), \zeta \in L_q^+ N_{\text{ext}}, r \in \mathbb{R} \setminus \{0\}\}.$$

Then the projection $\pi(\Lambda_{\text{int}})$ of Λ_{int} on N_{ext} is the light-cone $\mathcal{L}^+(q) \subset N_{\text{ext}}$ emanating from q . Let us take four points satisfying

$$(117) \quad x_j \in \Omega_{\text{in}} \quad \text{and} \quad x_j \notin J^+(x_k), \quad \text{for } j \neq k, \quad j, k = 1, 2, 3, 4.$$

Let $\xi_j \in L_{x_j}^+ N_{\text{ext}}$ and denote $(\vec{x}, \vec{\xi}) := (x_j, \xi_j)_{j=1}^4$. Let

$$(118) \quad \mathcal{N}(\vec{x}, \vec{\xi}) := N_{\text{ext}} \setminus \bigcup_{j=1}^4 J^+(\gamma_{x_j, \xi_j}(\mathbf{t}_j)), \quad \text{where } \mathbf{t}_j := \rho(x_j, \xi_j).$$

Denote also

$$(119) \quad K_j(s_0) := K(x_j, \xi_j, s_0) = \pi(\Lambda(x_j, \xi_j, s_0)), \quad \Lambda_j := \Lambda(x_j, \xi_j, s_0)$$

similarly to (103) and (104). Here we choose $s_0 > 0$ so small that either

$$(A) \quad K_{1234} = \bigcap_{s_0 > 0} \left(\bigcap_{j=1}^4 K_j(s_0) \right) \cap \mathcal{N}(\vec{x}, \vec{\xi}) = \emptyset,$$

or

$$(B) \quad K_{1234} = \bigcap_{s_0 > 0} \left(\bigcap_{j=1}^4 K_j(s_0) \right) \cap \mathcal{N}(\vec{x}, \vec{\xi}),$$

$$q = \gamma_{x_j, \xi_j}(t_j) \in K_{1234}, \quad t_j > 0 \text{ for all } j = 1, 2, 3, 4.$$

Moreover, let us define condition (T) as

- (T) the condition (B) is valid with $q \in K_{1234}$
 and there exists $b_j = \dot{\gamma}_{x_j, \xi_j}(t_j) \in N_q K_j \setminus \{0\}$
 such that $b_j, j = 1, 2, 3, 4$ are linearly independent.

Roughly speaking, in case (A) the geodesics $\gamma_{x_j, \xi_j}, j = 1, 2, 3, 4$ do not intersect in $\mathcal{N}(\vec{x}, \vec{\xi})$ and in (B) they intersect at a single point $\{q\} \in \mathcal{N}$. We will use distorted plane-waves that propagate on the surfaces K_j . Due to the κ :th order non-linearity with $\kappa \geq 4$, we avoid dealing with the 3-wave interactions of waves as they disappear in the linearized equations. However, while we do not have singularities produced by three waves, the sets where these 3-wave singularities would propagate can cause some problems.

Due to this, we define the following sets analogously to [75].

Let $\mathcal{X}((\vec{x}, \vec{\xi}), s_0) \subset L^* N_{\text{ext}}$ be the set of all light-like co-vectors (x, ξ) belonging to the conormal bundles $N^*(K_{j_1}(s_0) \cap K_{j_2}(s_0) \cap K_{j_3}(s_0))$ with $1 \leq j_1 < j_2 < j_3 \leq 4$. More precisely, let $K_{j_1, j_2, j_3}(s_0) = K_{j_1}(s_0) \cap K_{j_2}(s_0) \cap K_{j_3}(s_0)$ and

$$(120) \quad \mathcal{X}_{j_1 j_2 j_3}((\vec{x}, \vec{\xi}), s_0) = N^* K_{j_1, j_2, j_3}(s_0) \cap L^* N_{\text{ext}}.$$

Observe that $K_{j_1, j_2, j_3}(s_0) \cap \mathcal{N}(\vec{x}, \vec{\xi})$ is a smooth surface whose Hausdorff dimension is $(3 + 1) - 3 = 1$. For each $x \in K_{j_1, j_2, j_3}(s_0) \cap \mathcal{N}(\vec{x}, \vec{\xi})$, the set $N_x^* K_{j_1, j_2, j_3}(s_0) \cap L^* N_{\text{ext}}$ is of Hausdorff dimension 2. At the limit $s_0 \rightarrow 0$ the sets $K_j(s_0)$ tend towards the light-like geodesics γ_{x_j, ξ_j} . Thus the submanifold $\mathcal{X}_{j_1 j_2 j_3}((\vec{x}, \vec{\xi}), s_0) \cap T^* \mathcal{N}(\vec{x}, \vec{\xi}) \subset T^* M$ has Hausdorff dimension 3 and when $s_0 \rightarrow 0$ these submanifolds converge to a submanifold $\mathcal{X}_{j_1 j_2 j_3}(\vec{x}, \vec{\xi}) \cap T^* \mathcal{N}(\vec{x}, \vec{\xi}) \subset T^* M$ of Hausdorff dimension 2.

Recall that $\Theta_{x, \xi}$ is the bicharacteristic of \square_g containing (x, ξ) . To define the sets of three wave interactions, we define

$$\mathcal{H}_{j_1 j_2 j_3}((\vec{x}, \vec{\xi}), s_0) = \{(y, \eta) \in T^* N_{\text{ext}} \mid \text{there is } (x, \zeta) \in \mathcal{X}_{j_1 j_2 j_3}((\vec{x}, \vec{\xi}), s_0) \\ \text{such that } x \leq y \text{ and } (y, \eta) \in \Theta_{x, \zeta}\}.$$

Roughly speaking, the sets $\mathcal{X}_{j_1 j_2 j_3}$ are the light-like directions related to the three wave interactions and $\mathcal{H}_{j_1 j_2 j_3}$ are the sets to which $\mathcal{X}_{j_1 j_2 j_3}$ flow under the bicharacteristic flow. We also denote

$$(121) \quad \mathcal{H}(\vec{x}, \vec{\xi}) = \bigcap_{s_0 > 0} \left(\bigcup_{1 \leq j_1 < j_2 < j_3 \leq 4} \mathcal{H}_{j_1 j_2 j_3}((\vec{x}, \vec{\xi}), s_0) \right).$$

We use the above sets to discard the possible singularities produced by three waves interactions. Moreover, these sets allow us to define $\mathcal{Y}((\vec{x}, \vec{\xi}), s_0) = \pi(\mathcal{H}((\vec{x}, \vec{\xi}), s_0))$, where $\pi : T^* N_{\text{ext}} \rightarrow N_{\text{ext}}$ is the projection to the base space on the cotangent bundle. The limiting spaces are defined as

$$(122) \quad \mathcal{Y}(\vec{x}, \vec{\xi}) = \bigcap_{s_0 > 0} \mathcal{Y}((\vec{x}, \vec{\xi}), s_0), \quad \mathcal{X}(\vec{x}, \vec{\xi}) = \bigcap_{s_0 > 0} \mathcal{X}((\vec{x}, \vec{\xi}), s_0).$$

We call the sets $\mathcal{Y}(\vec{x}, \vec{\xi})$ the exceptional sets of 3-wave interactions.

Recall that the submanifold $\mathcal{X}_{j_1 j_2 j_3}((\vec{x}, \vec{\xi})) \cap T^* \mathcal{N}(\vec{x}, \vec{\xi}) \subset T^* M$ has the Hausdorff dimension 2. The main point of these sets is that at the limit $s_0 \rightarrow$

0 the sets $\mathcal{V}((\vec{x}, \vec{\xi}), s_0) \cap \mathcal{N}(\vec{x}, \vec{\xi}) \subset T^*M$ tend to the set $\mathcal{V}((\vec{x}, \vec{\xi})) \cap \mathcal{N}(\vec{x}, \vec{\xi}) \subset T^*M$, whose Hausdorff dimension is at most 2 and the sets $\mathcal{H}((\vec{x}, \vec{\xi}), s_0) \cap T^*\mathcal{N}(\vec{x}, \vec{\xi}) \subset T^*M$ tend to the set $\mathcal{H}((\vec{x}, \vec{\xi})) \cap T^*\mathcal{N}(\vec{x}, \vec{\xi}) \subset T^*M$, whose Hausdorff dimension is at most 3. Later, these sets can be discarded in the reconstruction procedure. We will not analyze what happens on these exceptional sets. We refer the reader to [39] for a study where the three wave interactions are used also to prove uniqueness results for inverse problems.

We will also need small neighbourhoods of the sets Λ_j . Recall that on the manifold N_{ext} we have an auxiliary Riemannian metric g^+ . Using g^+ we may define the unit cotangent bundle S^*N_{ext} , which further allows us to consider conic ε -neighbourhoods $\Gamma_j(\varepsilon)$ of $\Lambda_j \cap S^*N_{\text{ext}}$. Let us denote

$$(123) \quad \begin{aligned} \tilde{\Gamma}(\varepsilon) := & \left(\bigcup_{j < k < l} (\Gamma_j(\varepsilon) + \Gamma_k(\varepsilon) + \Gamma_l(\varepsilon)) \right) \\ & \cup \left(\bigcup_{j < k} (\Gamma_j(\varepsilon) + \Gamma_k(\varepsilon)) \right) \cup \left(\bigcup_{j=1}^4 \Gamma_j(\varepsilon) \right). \end{aligned}$$

This set contains $\mathcal{X}((\vec{x}, \vec{\xi}))$. Moreover, let

$$(124) \quad \mathcal{H}(\varepsilon) := \Lambda'_g \circ (\tilde{\Gamma}(\varepsilon) \cap \text{char}(\square_g))$$

be the Hamiltonian flow-out of $\tilde{\Gamma}(\varepsilon)$ (given by the canonical relation of \square_g). Then $\mathcal{H}(\varepsilon)$ is a neighbourhood of $\mathcal{H}((\vec{x}, \vec{\xi}))$.

Next we use a generalization of the analysis obtained in [75] and [83]

First, to analyze the κ -th order non-linearity, we use the following result:

Lemma 4. *Let $K \subset N_{\text{ext}}$ be a codimension one submanifold. Let $u_j \in I^{\mu_j}(K)$, $j = 1, 2, \dots, J$, $\mu_j < -\frac{3}{2}$. Then $v = \prod_{j=1}^J u_j(x)$ is a well-defined distribution in $I^\nu(K)$ with $\nu = \frac{3}{2}(J-1) + \sum_{j=1}^J \mu_j$. Moreover, the principal symbol satisfies*

$$(125) \quad \sigma(v) = (2\pi)^{-J/2} \sigma(u_1) * \sigma(u_2) * \dots * \sigma(u_J)$$

where the convolution is over the fiber variable of N^*K , i.e.,

$$(126) \quad \sigma(v)(x, \xi) = \int_{\mathbb{R}^{J-1}} \sigma(u_J)(x, \xi - \sum_{j=1}^{J-1} \eta_j) \cdot \prod_{j=1}^{J-1} \sigma(u_j)(x, \eta_j) d\eta_1 \dots d\eta_{J-1}$$

where $(x, \xi) \in K \times (\mathbb{R} \setminus 0)$ and we identify $K \times (\mathbb{R} \setminus 0)$ with N^*K . Moreover, the product v satisfies $\text{WF}(v) \subset N^*K$.

Proof. The proof follows by iterating Lemma 5.1 in [83]. □

Lemma 5. *Let $(\vec{x}, \vec{\xi}) = ((x_j, \xi_j))_{j=1}^4$ be future pointing light-like vectors such that (117) is satisfied. Assume also that $s_0 > 0$, K_j, Λ_j are as in (119). Let $y_0 \in \mathcal{N}(\vec{x}, \vec{\xi}) \cap \Omega_{\text{out}}$, see (118).*

Let $n \in \mathbb{Z}_+$ and $f_j \in \mathcal{I}^{-n+1}(\Sigma(x_j, \zeta_j, s_0))$, $j = 1, 2, 3, 4$, be sources satisfying (110) and $u_j = (\square_g + B)^{-1} f_j$ and $\mathcal{U}^{(\kappa)}$ be the wave produced by the

κ :th order interaction given in (113). When n is large enough, s_0 is small enough, the following claims hold:

(a) When the above condition (A) is satisfied, then $(y_0, \zeta_0) \notin WF(\mathcal{U}^{(\kappa)})$. Moreover, if $y_0 \notin \bigcup_{j=1}^4 \gamma_{x_j, \xi_j}([0, \infty)) \cup \mathcal{Y}((\vec{x}, \vec{\xi}), s_0)$, see (118) and (122), the point y_0 has a neighborhood $U \subset \Omega_{\text{out}}$ such that $\mathcal{U}^{(\kappa)}|_U$ is C^∞ -smooth.

(b) When the above conditions (B) and (T) are satisfied, the following holds:

(i) If $y_0 \notin \mathcal{L}^+(q)$, then y_0 has a neighborhood V such that $\mathcal{U}^{(\kappa)}|_V$ is C^∞ -smooth.

(ii) Assume that $y_0 \in \mathcal{L}^+(q) \setminus \mathcal{Y}((\vec{x}, \vec{\xi}), s_0)$. Also, assume that $w_0 \in L_{y_0}^* N_{\text{ext}}$ and $r \in \mathbb{R}$ are such that $\gamma_{y_0, w_0}(r) = q$ and denote $\eta = (\dot{\gamma}_{y_0, w_0}^\#(r))^\flat \in \Lambda_{1234}$. Then the point y_0 has a neighbourhood V such that $\mathcal{U}^{(\kappa)}$ in V is a Lagrangian distribution, $\mathcal{U}^{(\kappa)}|_V \in I^{-4n-\frac{1}{2}}(\Lambda_{\text{int}})$.

Moreover, η can be written as $\eta = \sum_{j=1}^4 \zeta_j$, where $\zeta_j \in N_q^* K_j$ are linearly independent. Then the principal symbol of $\mathcal{U}^{(\kappa)}|_V \in I^{-4n-\frac{1}{2}}(\Lambda_{1234})$, at the point (y_0, w_0) , is

(127)

$$\sigma_{\mathcal{U}^{(\kappa)}}^p(y_0, w_0) = -\kappa!(2\pi)^{-3} R(y_0, w_0, q, \eta) \cdot A(q) \left(\prod_{j=1}^3 \sigma_{u_j}^p(q, \zeta_j) \right) \cdot \sigma_v^p(q, \zeta_4),$$

where $v = u_4^{\kappa-3}$ and $\vec{\zeta} = (\zeta_j)_{j=1}^4$ and $R(y_0, w_0, q, \eta)$ is given Lemma 3.

We remark that as by Lemma 3 the principal symbols of u_j does not depend on the coefficient B , we see that the principal symbol of $\mathcal{U}^{(\kappa)}$ given in (127) does not depend on B .

Proof. In the proof of both cases (A) and (B) we use the fact that we consider observations at the point $y_0 \in \mathcal{N}(\vec{x}, \vec{\xi})$ and thus the point y_0 has a neighborhood V_0 such that in the chronological past $I^-(V_0)$ the linearized waves $u_j \in I(K_j)$ are conormal distributions associated to smooth submanifolds $K_j \cap I^-(V_0)$.

The case (a) follows from Prop. 5.6 in [83] (see also Theorem 3.3 of [75] about the detailed analysis for 2nd order non-linearity).

Next we prove the case (b). First, we consider the claim (ii). As in the proof of Lemma 3, we start by recalling that the causal inverse $Q = (\square_g + B)^{-1} \in I^{-\frac{3}{2}, -\frac{1}{2}}(\Delta'_{T^* N_{\text{ext}}}, \Lambda_g)$. Therefore, for $f_j \in I^{-n+1}(\Sigma_j)$ we have that $u_j := Qf_j \in I^{-n-\frac{1}{2}, -\frac{1}{2}}(\Sigma_j, \Lambda_j)$.

By Prop. 5.6 in [83] (see also Prop. 3.11, claim (i) in [83] on the detailed analysis when $\kappa = 4$), we know that the product $u_1^{\kappa-3} u_2 u_3 u_4$ can be expressed as

$$\begin{cases} u_1^{\kappa-3} u_2 u_3 v = w_0 + w_1, \\ w_0|_{M \setminus \mathcal{Y}((\vec{x}, \vec{\xi}), s_0)} \in I^{-4n+1+(\kappa-4)(1-n)}(\Lambda_{1234}), \quad w_1 \in \mathcal{D}'(N_{\text{ext}}), \\ \text{WF}(w_1) \subset \tilde{\Gamma}(\varepsilon), \end{cases}$$

where $\tilde{\Gamma}(\varepsilon)$ is given by (123).

By Hörmander's theorem about propagation of singularities [58, Theorem 26.1.1]

$$\text{WF}(-\kappa!Q(Aw_1)) \subset \tilde{\Gamma}(\varepsilon) \cup \mathcal{H}(\varepsilon),$$

where $\mathcal{H}(\varepsilon)$ is as in (124). Noting that $\pi(\mathcal{H}(\varepsilon))$ contains an ε -neighbourhood of $\mathcal{Y}((\vec{x}, \vec{\xi}))$ yields for small enough $\varepsilon > 0$ that y_0 has a neighbourhood W such that $W \cap \mathcal{H}(\varepsilon) = \emptyset$. Finally, applying Q to $-\kappa!Aw_0$ yields that in the set $M \setminus \mathcal{Y}((\vec{x}, \vec{\xi}), s_0)$

$$-\kappa!Q(Aw_0) \in I^{-4n+1+(\kappa-4)(1-n)-\frac{3}{2}, -\frac{1}{2}}(\Lambda_{1234}, \Lambda_{\text{int}}),$$

where $\Lambda_{\text{int}} = \Lambda'_g \circ (\Lambda_{1234} \cap \text{char}(\square_g))$ is the Hamiltonian flow-out of Λ_{1234} . The notation Λ_{int} refers to the fact that this Lagrangian submanifold is associated to the interaction of waves. Hence, assuming $A(q) \neq 0$, we have

$$\mathcal{U}^{(\kappa)}|_{\Omega_{\text{out}} \setminus \mathcal{Y}((\vec{x}, \vec{\xi}))} \in I(\Lambda_{\text{int}}).$$

The claim about the principal symbol $\sigma_{\mathcal{U}^{(\kappa)}}^{\text{P}}$ follows from Propositions 3.12(i) and 5.6 in [83] and Lemma 3.

For claim (i), note that $(y_0, w_0) \in \text{WF}(\mathcal{U}^{(\kappa)})$ if either w_0 is not light-like and $(y_0, w_0) \in \text{WF}(\mathcal{S})$ or w_0 is light-like and $(\gamma_{y_0, w_0^\#}(s), \gamma_{y_0, w_0^\#}(s)^b) \in \text{WF}(\mathcal{S})$, for some $s \in \mathbb{R}$. By the above considerations, we know that $\text{WF}(\mathcal{U}^{(\kappa)}) \subset \Lambda_{\text{int}} \cup \tilde{\Gamma}(\varepsilon) \cup \mathcal{H}(\varepsilon)$. It follows from (116) that $\pi(\Lambda_{\text{int}}) = \mathcal{L}^+(q)$, so when $y_0 \notin J^+(q)$, we have that $(y_0, w_0) \notin \Lambda_{\text{int}}$. On the other hand, we assumed $y_0 \notin \mathcal{Y}((\vec{x}, \vec{\xi}))$. Taking small enough $\varepsilon > 0$ it holds that $(y_0, w_0) \notin \mathcal{H}(\varepsilon)$. So y_0 is not in the wave-front set of $\mathcal{U}^{(\kappa)}$ and hence it has a neighbourhood V where $\mathcal{U}^{(\kappa)}$ is smooth. \square

Lemma 6. *Let $x_j \in \Omega_{\text{in}}$, $j = 1, 2, 3, 4$ and $\xi_j \in T_{x_j}N_{\text{ext}}$ be future directed light-like vectors, and consider geodesics $\gamma_{x_j, \xi_j}(\mathbb{R}_+)$. Also, let $t_0 \geq 0$ be such that $\gamma_{x_j, \xi_j}([0, t_0]) \subset N^-$. Then using the extended source-to-solution operator L_{g_{ext}, p_+} we can determine a set $S = S(\vec{x}, \vec{\xi}, t_0)$ having the following properties:*

(i) *If all four geodesics $\gamma_{x_j, \xi_j}([t_0, \infty))$, $j = 1, 2, 3, 4$ intersect at a point q before the first cut point of any of these geodesics and $A(q) \neq 0$, then $S = \mathcal{E}_V(q)$, where $V = \Omega_{\text{out}}$.*

(ii) *If all four geodesics $\gamma_{x_j, \xi_j}([t_0, \infty))$, $j = 1, 2, 3, 4$ do not intersect before the first cut point of any of these geodesics or they intersect at the point q having a neighborhood V_q where $A|_{V_q} = 0$, then $S \subset \Omega_{\text{out}} \setminus \mathcal{N}((\vec{x}, \vec{\xi}), t_0)$.*

Proof. Consider $\vec{x} = (x_j)_{j=1}^4$, $x_j \in N^-$ and $\vec{\xi} = (\xi_j)_{j=1}^4$, where $\xi_j \in T_{x_j}N_{\text{ext}}$ are future directed light-like vectors. Also, let $t_0 > 0$ be so small that $\gamma_{x_j, \xi_j}([0, t_0]) \subset N^-$. Similarly to [75, Section 3.5], we say that a point $y \in \Omega_{\text{out}}$, satisfies the singularity detection condition (D) with light-like directions $(\vec{x}, \vec{\xi})$, and $t_0, \hat{s} > 0$ if

(D) *For any $s, s_0 \in (0, \hat{s})$ and $j = 1, 2, 3, 4$ there exists (x'_j, ξ'_j) in the s -neighborhood of (x_j, ξ_j) , open sets $B_j \subset B_{g^+}(\gamma_{x'_j, \xi'_j}(t_0), s)$, satisfying $B_j \cap J^+(B_k) = \emptyset$ for $j \neq k$, such that the following is valid: There are $f_j \in I^{\mu+1}(Y((x'_j, \xi'_j); t_0, s_0))$ such that $\text{supp}(f_j) \subset B_j$, the wavefront set of f_j is in the s_0 -neighborhood of (x'_j, ξ'_j) , and for the solution $u = u_\varepsilon$ of (109) with the*

source $f_{\vec{\epsilon}} = \sum_{j=1}^4 \epsilon_j f_j$ it holds that $\mathcal{U}^{(\kappa)} = \partial_{\vec{\epsilon}_1}^{k-3} \partial_{\epsilon_2} \partial_{\epsilon_3} \partial_{\epsilon_4} u_{\vec{\epsilon}}|_{\{\epsilon_1=\epsilon_2=\epsilon_3=\epsilon_4=0\}}$ is not C^∞ -smooth at y .

We see that if geodesics $\gamma_{x_j, \xi_j}(\mathbb{R}_+)$ intersect at a point $q \in \mathcal{N}((\vec{x}, \vec{\xi}), t_0)$ where $A(q) \neq 0$, then arbitrarily close to $(x_j, \xi_j)_{j=1}^4$ in $(L^+ N_{\text{ext}})^4$ there are $(x'_j, \xi'_j)_{j=1}^4$ such that the geodesics $\gamma_{x'_j, \xi'_j}(\mathbb{R}_+)$ intersect at the point q and also the condition (T) is valid.

Thus Lemma 5 implies that the set

$$(128) \quad S(\vec{x}, \vec{\xi}, t_0) := \{y \in \Omega_{\text{out}} \mid \text{there is } \hat{s} > 0 \text{ such that} \\ y \text{ satisfies (D) with } (\vec{x}, \vec{\xi}) \text{ and } t_0, \hat{s}\}$$

has the property that

$$S(\vec{x}, \vec{\xi}, t_0) \cap \left(\mathcal{N}((\vec{x}, \vec{\xi}), t_0) \setminus (\mathcal{Y}^{(3)} \cup \bigcup_{k=1}^4 K_j) \right) \\ = \mathcal{L}^+(q) \cap \Omega_{\text{out}} \cap \left(\mathcal{N}((\vec{x}, \vec{\xi}), t_0) \setminus (\mathcal{Y}^{(3)} \cup \bigcup_{k=1}^4 K_j) \right),$$

where $\mathcal{Y}^{(3)} = \mathcal{Y}((\vec{x}, \vec{\xi}), s_0)$. Roughly speaking, this means that if the geodesics $\gamma_{x_j, \xi_j}(\mathbb{R}_+)$ intersect at q before their first cut points, then the linearized waves $v_j = Q_g f_j$ interact at the point q and produce a wave $\mathcal{U}^{(k)}$ that in the set $\mathcal{N}((\vec{x}, \vec{\xi}), t_0)$ may be singular only on the future light cone $\mathcal{L}^+(q)$ emanating from q . Moreover, at any point $y \in \mathcal{L}^+(q) \cap \mathcal{N}((\vec{x}, \vec{\xi}), t_0)$ the wave $\mathcal{U}^{(k)}$ is non-smooth near y if one makes a suitable perturbation to sources f_j .

Define $S_{\text{reg}}(\vec{x}, \vec{\xi}, t_0)$ be the set of the points $y \in S(\vec{x}, \vec{\xi}, t_0)$ having a neighborhood $W \subset \Omega_{\text{out}}$ such that the intersection $W \cap S(\vec{x}, \vec{\xi}, t_0)$ is a non-empty C^∞ -smooth 3-dimensional submanifold. Moreover, let $S_{\text{cl}}(\vec{x}, \vec{\xi}, t_0)$ be the closure of the set $S_{\text{reg}}(\vec{x}, \vec{\xi}, t_0)$ in Ω_{out} and define $S_e(\vec{x}, \vec{\xi}, t_0)$ to be the set of those $y \in S_{\text{cl}}(\vec{x}, \vec{\xi}, t_0)$ for which any geodesics $\mu_a = (\mathbb{R} \times \{a\}) \cap N^+$, $a \in \mathbb{S}^3$, containing y does not intersect $S_{\text{cl}}(\vec{x}, \vec{\xi}, t_0)$ in the chronological past of y .

The proof of Lemma 4.4 of [75] shows the following: First, in the case when all four geodesics $\gamma_{x_j, \xi_j}(\mathbb{R}_+)$, $j = 1, 2, 3, 4$ intersect at some point $q \in \mathcal{N}((\vec{x}, \vec{\xi}), t_0)$, the above constructed set $S_e(\vec{x}, \vec{\xi}, t_0)$ coincides with $\mathcal{E}_V(q)$ with $V = \Omega_{\text{out}}$. Second, in the case when all four geodesics $\gamma_{x_j, \xi_j}(\mathbb{R}_+)$ do not intersect at any point of $\mathcal{N}((\vec{x}, \vec{\xi}), t_0)$ or they intersect at a point near which A vanishes, the above constructed set $S_e(\vec{x}, \vec{\xi}, t_0)$ does not intersect $\mathcal{N}((\vec{x}, \vec{\xi}), t_0)$. This proves the claim for $S(\vec{x}, \vec{\xi}, t_0) = S_e(\vec{x}, \vec{\xi}, t_0)$. \square

5. PROOF OF THE MAIN THEOREM

Proof. (of Theorem 2) Let us consider two manifolds (M_1, g_{M_1}) and (M_2, g_{M_2}) with asymptotically Minkowskian infinities that are visible in the whole manifold and (N_1, g_1) and (N_2, g_2) be conformal to them. Let $(N_{\text{ext}}^1, \tilde{g}_1)$ and $(N_{\text{ext}}^2, \tilde{g}_2)$ be the ‘non-physical extensions’ of (N_1, g_1) and (N_2, g_2) that are obtained by gluing manifolds N^+ and N^- to these spaces.

The proof consists of several steps; let us provide a brief overview of its structure. First, we construct neighbourhoods of \mathcal{I}^+ and \mathcal{I}^- , such that future directed null geodesics do not have conjugate points. This allows us to reconstruct the conformal type of these neighbourhoods of \mathcal{I}^\pm . We then study a gauge-like conformal transformation in these neighbourhoods and show that in the neighbourhoods of \mathcal{I}^\pm , the source-to-solution maps agree up to smoothing error of order one, at least locally. This allows us to consider source-to-solution maps (locally) in a neighbourhood of $\widehat{\mu}$. Having established that the source-to-solution maps of N_{ext}^1 and N_{ext}^2 agree in a neighbourhood of $\widehat{\mu}$, we are in the regime of [75], and can finish the proof using local measurements.

Step 1: *Defining neighborhoods of \mathcal{I}^- and \mathcal{I}^+ with no cut or conjugate points.*

We recall that $\widehat{\mu}(s)$ is the path $\widehat{\mu}(s) = (s, \text{SP}) \in \mathbb{R} \times \mathbb{S}^3$, $s \in (-\pi, \pi)$.

On the both manifolds $(N_{\text{ext}}^1, \widetilde{g}_1)$ and $(N_{\text{ext}}^2, \widetilde{g}_2)$, the metric tensor in the set $J^+(i_0) \cap J^-(p_{+2}) \subset N_{\text{ext}}^j$ coincides with the product metric of $\mathbb{R} \times \mathbb{S}^3$. Let $\xi \in L_{i_0}^+ N_{\text{ext}}^j$ be a light-like vector at the point i_0 , normalized so that $\gamma_{i_0, \xi}(\pi) = \text{NP}$. Then, the cut locus functions on the manifolds N_{ext}^1 and N_{ext}^2 satisfy $\rho(i_0, \xi) = \pi$. Since the cut locus function $\rho(x, \xi)$ is lower semi-continuous and N^+ is isometric to a subset of $\mathbb{R} \times \mathbb{S}^3$, for any $h > 0$ there is a neighborhood $V_h \subset L^+ N_{\text{ext}}^j$ of the point (i_0, ξ) such that $\rho(y, \eta) > \pi - h$ for all $(y, \eta) \in V_h$. Thus, if $h > 0$ is small enough and $s_0^- < 0$ is so close to zero that

$$J^+(p_0^-) \cap N^- \subset V_h, \quad p_0^- = \widehat{\mu}(s_0^-)$$

then the light-like geodesics $\gamma_{y, \eta}$ emanating from the points $y \in J^+(p_0^-) \cap N^- \subset N_{\text{ext}}^j$ and $\eta \in L^+ N_{\text{ext}}^j$ have no cut points in the set $J^-(p_{+2}) \subset N_{\text{ext}}^j$. We denote (see Figure 9 below)

$$W_j(s_0^-) := I_{N_{\text{ext}}^j}^+(p_0^-) \cap I_{N_{\text{ext}}^j}^-(p_{+2}).$$

and

$$Y_j(s_0^-) := W_j(s_0^-) \setminus (N^+ \cup N^-).$$

Next, for fixed $j \in \{1, 2\}$, let us consider $x \in \mathcal{I}^- \cap J^+(p_{-2}) \subset N_{\text{ext}}^j$ and light-like vectors $\xi \in L_x^+ N_{\text{ext}}^j$. We define

$$\begin{aligned} h_0(x, \xi, r) &= f_{\widehat{\mu}}^+(\gamma_{x, \xi}(r)), \\ F_0(x, \xi) &= h_0(x, \xi, \rho(x, \xi)). \end{aligned}$$

The function h_0 is continuous and $r \rightarrow h_0(x, \xi, r)$ is non-decreasing for all $(x, \xi) \in L^+ N$. As $\rho(x, \xi)$ is lower semi-continuous, we see that if $(x_n, \xi_n) \rightarrow (x, \xi)$ as $n \rightarrow \infty$, then

$$\lim_{n \rightarrow \infty} h_0(x_n, \xi_n, \rho(x_n, \xi_n)) = h_0(x, \xi, \lim_{n \rightarrow \infty} \rho(x_n, \xi_n)) \geq h_0(x, \xi, \rho(x, \xi)).$$

Thus, F_0 is also a lower semi-continuous function.

Next we make two observations.

First, let (x, ξ) be a future-directed light-like vector in the tangent space of \mathcal{I}^- or $x = i_0$ and $\xi \in L_{i_0}^+ N_{\text{ext}}^j$. As N^- and N^+ are isometric to subsets of $\mathbb{R} \times \mathbb{S}^3$, we see that $F_0(x, \xi) = h_0(x, \xi, \rho(x, \xi)) > 0$.

Second, if $x \in \mathcal{I}^-$ and $\xi \in L_x^+ N_{\text{ext}}^j$ is not tangent to \mathcal{I}^- , then for all $r > 0$ we have $y = \gamma_{x,\xi}(r) \in I^+(\mathcal{I}^+)$, and thus $f_{\hat{\mu}}^+(y) > 0$. Hence, if $x \in \mathcal{I}^- \cup \{i_0\}$ and $\xi \in L_x^+ N_{\text{ext}}^j$, then $F_0(x, \xi) = h_0(x, \xi, \rho(x, \xi)) > 0$. By using compactness of $\text{cl}(\mathcal{I}^- \cap J^+(p_{-2}))$, we see that

$$(129) \quad s_0^+ := \frac{1}{4} \min\{h_0(x, \xi, \rho(x, \xi)) \mid x \in \text{cl}(\mathcal{I}^- \cap J^+(p_{-2})), (x, \xi) \in L^+ N, \|\xi\|_{g_+} = 1\} > 0.$$

Then, every point $x \in \text{cl}(\mathcal{I}^- \cap J^+(p_{-2}))$ has a neighborhood $B_x \subset N_{\text{ext}}^j$, such that for all $y \in B_x$ and $\eta \in L_y^+ N_{\text{ext}}^j$ it holds that $h_0(y, \eta, \rho(y, \eta)) > 2s_0^+$. Let $p_0^+ = \hat{\mu}(s_0^+)$. Next, let us cover the compact set $\text{cl}(\mathcal{I}^- \cap J^+(p_{-2}))$ with a finite number of open sets $B_k = B_{x_k}$, $k = 1, 2, \dots, K$, see Fig. 10. Then, using compactness of $(N^- \cap J^+(p_{-2})) \setminus \bigcup_{k=1}^K B_k \subset N_{\text{ext}}^j$ and that N^+ is isometric to a subset of $\mathbb{R} \times \mathbb{S}^3$, we see that

$$s_{00}^- := \max\{f_{\hat{\mu}}^+(x) \mid x \in (N^- \cap J^+(p_{-2})) \setminus \bigcup_{k=1}^K B_k\} < 0.$$

Let $p_{00}^- = \hat{\mu}(s_{00}^-)$. Then we see that for all $z \in N_{\text{ext}}^j$ satisfying

$$(130) \quad z \in (N^- \cap J^+(p_{-2})) \setminus I^-(p_{00}^-) \subset \bigcup_{k=1}^K B_k$$

and $\zeta \in L_z^+ N_{\text{ext}}^j$, it holds that $h_0(z, \zeta, \rho(z, \zeta)) > 2s_0^+$. Then by (129) and (130), the light-like geodesics $\gamma_{z,\zeta}$ do not have cut points in the set $J^-(p_0^+) \subset N_{\text{ext}}^j$.

We denote

$$X_j(s) := (I_{N_{\text{ext}}^j}^-(\hat{\mu}(s)) \cap I_{N_{\text{ext}}^j}^+(p_-)) \setminus (N^+ \cup N^-) \subset J^-(p_0^+),$$

so that

$$X_j(s_0^+) := (I_{N_{\text{ext}}^j}^-(p_0^+) \cap I_{N_{\text{ext}}^j}^+(p_-)) \setminus (N^+ \cup N^-) \subset J^-(p_0^+)$$

see (129), and let

$$Z_j = (N^- \cap I_{N_{\text{ext}}^j}^+(p_-)) \setminus J_{N_{\text{ext}}^j}^-(p_{00}^-).$$

Note that by (130), $Z_j \subset \bigcup_{k=1}^K B_k$.

Step 2: *Construction of the conformal type of the neighborhoods of \mathcal{I}^- and \mathcal{I}^+ .*

By using sources f_k that are conormal distributions supported in Z_j , where $j = 1, 2$, and the interaction of waves, observed in N^+ , we apply Lemma 6. We see that the light-like geodesics emanating from points $(x_k, \xi_k) \in L^+ Z_j$, $x_k \in Z_j \subset N^-$, $k = 1, 2, 3, 4$ do not have cut points on $J^-(p_0^+) \subset N_{\text{ext}}^j$. Let now $\tilde{U} = I_{N_{\text{ext}}^j}^-(p_0^+) \cap N^+$ and $S \subset \tilde{U}$ be the set constructed in Lemma 6 with the initial directions $(x_k, \xi_k)_{k=1}^4$. If $S \cap I_{N_{\text{ext}}^j}^-(p_0^+) \neq \emptyset$, Lemma 6 implies that the geodesics $\gamma_{x_k, \xi_k}([0, \infty))$, $k = 1, 2, 3, 4$ have to intersect at some point $q \in I_{N_{\text{ext}}^j}^-(p_0^+) \cap \bar{N}$ and the set S satisfies $S = \mathcal{E}_{N^+}(q)$. In the case

when $S \cap I_{N_{\text{ext}}^j}^-(p_0^+) = \emptyset$, the four geodesics do not have common intersection points in the set $I_{N_{\text{ext}}^j}^-(p_0^+) \cap N$.

Moreover, we see that for all $q \in X_j(s_0^+)$ there exists (x_j, ξ_j) satisfying the above conditions such that the geodesics γ_{x_j, ξ_j} , $j = 1, 2, 3, 4$ intersect at q .

By computing the first Frechet derivatives of source-to-solution maps, we obtain the source-to-solution map for the linearized wave equation. This map determines the earliest light observation sets $\mathcal{E}_U(q)$, where $U = N_+$, for the points $q \in N_-$. Clearly, as $(N_+, g_{\text{ext}}|_{N_+})$ is a known Lorentzian manifold, we can determine also the sets $\mathcal{E}_U(q)$ for $q \in N_+$.

Using the source-to-solution map for the linearized wave equation we can also determine the intersection $\gamma_{x, \xi} \cap N^+$ of the set N^+ and the light-like geodesics $\gamma_{x, \xi}$ emanating from the points $x \in N^-$. Using the knowledge of the geodesic segments $\gamma_{x, \xi} \cap N^+$, $j = 1, 2, 3, 4$, we can determine when $(x_j, \xi_j) \in L^+(N^-)$ are such that the geodesics γ_{x_j, ξ_j} , $j = 1, 2, 3, 4$ have a common intersection point in the set N^+ . Finally, as the metric of N^- coincides with that of $\mathbb{R} \times \mathbb{S}^3$, we can determine when $(x_j, \xi_j) \in L^+(N^-)$ are such that the geodesics γ_{x_j, ξ_j} , $j = 1, 2, 3, 4$ have a common intersection point in the set N^- . Summarizing, we have analyzed the cases when the geodesics γ_{x_j, ξ_j} , $j = 1, 2, 3, 4$ have either a common intersection point in $I_{N_{\text{ext}}^j}^-(p_0^+) \cap \bar{N}$ or N^- or N^+ and also in the case when common intersection points in $I_{N_{\text{ext}}^j}^-(p_0^+)$ do not exist. Note that some of the cases may happen at the same time but when only the first case takes place, we know that the geodesics have a common intersection point in the set $X_j(s_0^+)$.

The above observations imply we can use the source-to-solution map to determine the light observation sets $\{\mathcal{E}_{\tilde{U}}^j(q) \subset N_{\text{ext}}^j \mid q \in X_j(s_0^+)\}$, $j = 1, 2$, that is, we see that

$$\{\mathcal{E}_{\tilde{U}; N_{\text{ext}}^1}(q) \subset N_1 \mid q \in X_1(s_0^+)\} = \{\mathcal{E}_{\tilde{U}; N_{\text{ext}}^2}(q) \subset N_2 \mid q \in X_2(s_0^+)\},$$

where $\mathcal{E}_{\tilde{U}; N_{\text{ext}}^j}(q)$ is the light observation set, that is, the intersection of the light cone emanating from the point q and the \tilde{U} on the manifold N_{ext}^j .

To continue the construction, we observe that for all $0 < s < s_0^+$ and $q \in X_j(s_0^+)$, it holds that $q \in X_j(s_0^+) \setminus X_j(s)$ if and only if $f_{\hat{\mu}}^+(q) > s$, that is equivalent to that $S = \mathcal{E}_{\tilde{U}; N_{\text{ext}}^1}(q)$ satisfies $S \cap \hat{\mu}(s, s_{+2}) \neq \emptyset$. Thus,

(131)

$$\{\mathcal{E}_{\tilde{U}; N_{\text{ext}}^1}(q) \mid q \in X_1(s_0^+) \setminus X_1(s)\} = \{\mathcal{E}_{\tilde{U}; N_{\text{ext}}^2}(q) \mid q \in X_2(s_0^+) \setminus X_2(s)\}.$$

Next we use [75, Theorem 1.2] to reconstruct the conformal class of a set from the collection of the light observation sets of its points. Observe that the closure of the set $X_1(s_0^+) \setminus X_1(s)$ is a compact subset of $I_{N_{\text{ext}}^j}^-(\hat{\mu}(s_+)) \setminus J_{N_{\text{ext}}^j}^-(\hat{\mu}(s))$. Thus, using [75, Theorem 1.2], with the observation set \tilde{U} that is a neighborhood of the time-like path $\hat{\mu} \cap \tilde{U}$, the formula (131) implies that there is a conformal diffeomorphism

$$(132) \quad \Psi : X_1(s_0^+) \setminus X_1(s) \rightarrow X_2(s_0^+) \setminus X_2(s).$$

By taking the union of these sets over $s > 0$, we see that there is a conformal diffeomorphism

$$(133) \quad \Psi : X_1(s_0^+) = X_1(s_0^+) \setminus X_1(0) \rightarrow X_2(s_0^+) = X_2(s_0^+) \setminus X_2(0).$$

Observe that the images of the geodesics γ_{x_0, ξ_0} , where $x_0 \in N^-$ and ξ_0 is light-like, on $\mathcal{E}_{\tilde{U}; N_{\text{ext}}^2}(X_1(s_0^+))$, that is,

$$\{\mathcal{E}_{\tilde{U}; N_{\text{ext}}^2}(q) \in \mathcal{E}_{\tilde{U}; N_{\text{ext}}^2}(X_1(s_0^+)) \mid q \in \gamma_{x_0, \xi_0}([0, \mathcal{T}(x, \xi))) \cap \tilde{U}\}$$

is the set of those $\mathcal{E}_{\tilde{U}; N_{\text{ext}}^2}(q) \in \mathcal{E}_{\tilde{U}; N_{\text{ext}}^2}(X_1(s_0^+))$ that are produced in the above construction with directions $((x_j, \xi_j))_{j=1}^4$, where $(x_1, \xi_1) = (x_0, \xi_0)$. By using light-like geodesics that intersect \mathcal{I}^- transversally, we can glue the sets $X_j(s_0^+)$ together and N^- and see that there is a conformal diffeomorphism

$$(134) \quad \Psi : \mathcal{W}_1^- \rightarrow \mathcal{W}_2^-, \quad \mathcal{W}_j^- := I_{N_{\text{ext}}^j}^-(p_0^+) \cap I_{N_{\text{ext}}^j}^+(p_-).$$

Above, we have essentially reconstructed a neighborhood of \mathcal{I}^- . Next we make similar considerations in a neighborhood of \mathcal{I}^+ .

Next we apply the observation we made above that in the set $W_j := J^+(p_0^-) \cap J^-(p_{+2}) \subset N_{\text{ext}, j}$ the light-like geodesics emanating from $W_j \cap N^-$ have no cut points. Using conormal sources supported in $W_j \cap N^-$ and the corresponding 4-tuples $(x_j, \xi_j)_{j=1}^4$, where $(x_j, \xi_j) \in L^+(W_j \cap N^-)$, we see as above, using Lemma 6, that

$$(135) \quad \{\mathcal{E}_{N^+; N_{\text{ext}}^1}(q) \subset N^+ \mid q \in Y_1(s_0^-) \setminus J_{N_{\text{ext}}^1}^-(\hat{\mu}(s))\} \\ = \{\mathcal{E}_{N^+; N_{\text{ext}}^2}(q) \subset N^+ \mid q \in Y_2(s_0^-) \setminus J_{N_{\text{ext}}^2}^-(\hat{\mu}(s))\}$$

for all $0 < s < s_+$. Then, we see as above, using [75], Theorem 1.2, with the observation set N^+ that is a neighborhood of the time-like path $\hat{\mu}$, that there is a conformal diffeomorphism

$$(136) \quad \Phi : Y_1(s_0^-) \setminus J_{N_{\text{ext}}^1}^-(\hat{\mu}(s)) \rightarrow Y_2(s_0^-) \setminus J_{N_{\text{ext}}^2}^-(\hat{\mu}(s)).$$

Taking union over sets $s > 0$ we see that there is a conformal diffeomorphism

$$(137) \quad \Phi : Y_1(s_0^-) \rightarrow Y_2(s_0^-).$$

Let $(y, \zeta) \in L^+N^+$ and consider the set of the points $q \in Y_j(s_0^-)$ whose light observation set $\mathcal{E}_{N^+}(q)$ contains the light-like geodesic $\gamma_{y, \zeta}([0, r_0]) \subset N^-$, that is, the set

$$\Gamma_{y, \zeta} := \{\mathcal{E}_{N^+}(q) \in \mathcal{E}_{N^+}(Y_j(s_0^-)) \mid \gamma_{y, \zeta}([0, r_0]) \subset \mathcal{E}_{N^+}(q)\}.$$

We see as in [75, Lemma 2.6] that

$$\Gamma_{y, \zeta} = \{\mathcal{E}_{N^+}(q) \mid q \in \gamma_{y, \zeta}(\mathbb{R}) \cap Y_j(s_0^-)\}.$$

Using this, we can construct the images of the light-like geodesics $\gamma_{y, \zeta}(\mathbb{R}) \cap (N^- \cup Y_j(s_0^-))$, in the map \mathcal{E}_{N^+} . Using such geodesics that intersect \mathcal{I}^+ transversally, we can glue the sets $Y_j(s_0^-)$ together with N^+ . As this construction can be done on both manifolds N_{ext}^j , $j = 1, 2$, we see that there is a conformal diffeomorphism

$$(138) \quad \Psi : \mathcal{W}_1^+ \rightarrow \mathcal{W}_2^+, \quad \mathcal{W}_j^+ := I_{N_{\text{ext}}^j}^-(p_+) \cap I_{N_{\text{ext}}^j}^+(p_0^-).$$

By combining the conformal diffeomorphisms (134) and (138), we see that there is a conformal diffeomorphism

$$(139) \quad \Psi : \mathcal{W}_1 \rightarrow \mathcal{W}_2, \quad \mathcal{W}_j := \mathcal{W}_j^+ \cup \mathcal{W}_j^- \subset N_{\text{ext}}^j.$$

Step 3: *Conformal transformation of the neighborhoods of \mathcal{I}^- and \mathcal{I}^+ and source-to-solution maps.*

By the above, there exists a function $\gamma \in C^\infty(\mathcal{W}_1)$ such that

$$(140) \quad g_1 = e^{2\gamma} \Psi^* g_2, \quad \text{on } \mathcal{W}_1.$$

As the metric tensor in the set $N^\pm \subset N_{\text{ext}}^j$ coincides with the product metric of $\mathbb{R} \times \mathbb{S}^3$ we have that $\gamma = 0$ on $(N^- \cup N^+) \cap \mathcal{W}_1$.

Next, we will consider an extension of the source-to-solution map for a non-linear wave equation with an additional term in the zeroth order term B . To do that, we introduce some notations. Let $V_1, V_2 \subset N_{\text{ext}}$ be relatively compact open sets, and $K \subset V_1$ be a compact set.

Let $f \in H_0^k(K)$, $\|f\|_{H^k(V_3)} < \varepsilon$, where $\varepsilon = \varepsilon_K > 0$ is small enough.

Then there exists a unique solution to

$$(141) \quad \begin{cases} (\square_{g_{\text{ext}}} + B)w + Aw^\kappa = f, & \text{in } I_{N_{\text{ext}}}^-(p_+), \\ \text{supp}(w) \subset J_{N_{\text{ext}}}^+(\text{supp}(f)) \end{cases}$$

and we define the source-to-solution map

$$L_{g,B,A;V_1,V_2}(f) = w|_{V_2}.$$

Moreover, we define the domain $\mathcal{D}_{V_1,V_2} = \mathcal{D}(L_{g,B,A;V_1,V_2})$ of the map $L_{g,A,B;V_1,V_2}$ to be the union

$$\mathcal{D}(g, A, B; V_1, V_2) = \bigcup_{K \subset \subset V_1} \{f \in H_0^k(K) \mid \|f\|_{H^k(V_1)} < \varepsilon_K\},$$

where the union is taken over the subsets $K \subset V_1$ and $\varepsilon_K > 0$ are sufficiently small numbers.

Next we consider a transformation of the conformal class of the metric with the function $e^{2\gamma}$. That is, we consider the function $\underline{u} = e^{-\gamma}u$ on the manifold N_{ext}^1 where u satisfies the equation

$$(142) \quad (\square_{g_1} + B_1 + D_1)u + A_1u^\kappa = f \quad \text{on } \mathcal{W}_1,$$

where f is supported in $(N^+ \cup N^-) \cap \mathcal{W}_1$. We observe that as $\gamma = 0$ in $(N^+ \cup N^-) \cap \mathcal{W}_1$, the equation (142) implies

$$(143) \quad (\square_{\underline{g}_1} + \underline{B}_1 + \underline{D}_1 + \underline{q}_1)\underline{u} + \underline{A}_1\underline{u}^\kappa = f,$$

where $\underline{g}_1 = e^{2\gamma}g_1$ and $\underline{B}_1 = e^{-2\gamma}B_1$, $\underline{D}_1 = e^{-2\gamma}D_1$, $\underline{A}_1 = e^{(\kappa-3)\gamma}A_1$ and $\underline{q}_1 = \frac{1}{6}(R_{\underline{g}_1} - e^{2\gamma}R_{g_1})$ is a smooth function that vanishes on $(N^+ \cup N^-) \cap \mathcal{W}_1$.

Next, we consider the principal symbols of the observed waves using [83, Theorem 6.2] (more precisely, we use [83, Prop. 4.3 and 4.5]). To this end, we

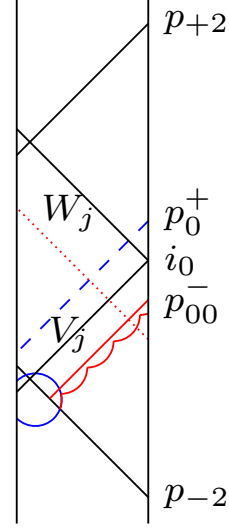

FIGURE 10. Subsets $W = I^+(p_0^-) \cap I^-(p_{+2})$ and $V = I^-(p_0^+) \cap I^+(p_{-2})$ of N_{ext} in the Penrose compactification.

use the operators $f \mapsto (\square_g + B)^{-1}f$. We observe that the principal symbol of the operator $(\square_g + B)^{-1}$ coincides with that of \square_g^{-1} .

To consider the derivatives of the source-to-solution operators that correspond to the zeroth order terms B_1 and $\tilde{B} = \underline{B}_1 + \underline{D}_1 + \underline{q}$, we recall certain details in our earlier considerations. Let us consider the direction $(\vec{x}, \vec{\xi}) = ((x_j, \xi_j))_{j=1}^4$ and s_0 that satisfy either the above condition (A) or the conditions (B) and (T). Let f_j be the conormal sources associated to direction $(\vec{x}, \vec{\xi}) = ((x_j, \xi_j))_{j=1}^4$, given in (107). For such sources, we define the linearized solutions, see (111), using the coefficients B_1 and $\tilde{B} = \underline{B}_1 + \underline{D}_1 + \underline{q}$. These linearized solutions are

$$(144) \quad u_j^{B_1} = (\square_g + B_1)^{-1}f_j \in I(N_{\text{ext}} \setminus \{x_j\}; \Lambda(x_j, \zeta_j, s_0)), \quad \text{and}$$

$$(145) \quad u_j^{\tilde{B}_1} = (\square_g + \tilde{B}_1)^{-1}f_j \in I(N_{\text{ext}} \setminus \{x_j\}; \Lambda(x_j, \zeta_j, s_0)).$$

We see that the principal symbols of $u_j^{B_1}$ and $u_j^{\tilde{B}_1}$ on $\Lambda(x_j, \zeta_j, s_0)$ coincide. Similarly to (113), we define the waves produced by the interaction of linearized waves,

$$(146) \quad \mathcal{U}^{(\kappa, B_1)} = (\square_g + B_1)^{-1}\mathcal{S}^{B_1}, \quad \mathcal{U}^{(\kappa, \tilde{B}_1)} = (\square_g + \tilde{B}_1)^{-1}\mathcal{S}^{\tilde{B}_1},$$

where

$$(147) \quad \mathcal{S}^{B_1} := -\kappa! \cdot A_1 u_1^{B_1} u_2^{B_1} u_3^{B_1} (u_4^{B_1})^{\kappa-3}, \quad \mathcal{S}^{\tilde{B}_1} := -\kappa! \cdot \underline{A}_1 u_1^{\tilde{B}_1} u_2^{\tilde{B}_1} u_3^{\tilde{B}_1} (u_4^{\tilde{B}_1})^{\kappa-3}.$$

Observe that

$$\begin{aligned} \mathcal{U}^{(\kappa, B_1)}|_{V_+} &= D^\kappa|_0 L_{g, B_1, A; V_-, V_+}[f_1, f_2, f_3, f_4], \\ \mathcal{U}^{(\kappa, \tilde{B}_1)}|_{V_+} &= D^\kappa|_0 L_{\underline{g}, \underline{B}_1, \underline{A}; V_-, V_+}[f_1, f_2, f_3, f_4] \end{aligned}$$

are the κ -th order (Fréchet) derivatives of the maps $f \rightarrow L_{g, B_1, A; V_-, V_+}(f)$ and $f \rightarrow L_{\underline{g}, \underline{B}_1, \underline{A}; V_-, V_+}(f)$, evaluated at the point $f = 0$, see (112). As pointed out after the claim of Theorem 5, the restrictions of the functions $\mathcal{U}^{(\kappa, \tilde{B}_1)}$ and $\mathcal{U}^{(\kappa, B_1)}$ to the domain $\mathcal{N}(\vec{x}, \vec{\xi})$ are Lagrangian distributions associated to the same Lagrangian manifold Λ_{1234} and their principal symbols are the same. Below, we refer to this property by saying that the Fréchet derivatives $D^\kappa|_0 L_{g, B_1, A; V_-, V_+}$ and $D^\kappa|_0 L_{\underline{g}, \underline{B}_1, \underline{A}; V_-, V_+}$ are the same up to a smoothing error of order one. This means that adding a potential \underline{q} does not change the construction of the metric g or the coefficient A of the non-linear term.

Also, our assumption that the source-to-solution maps $L_{g_1, B_1, A_1; N^-, N^+}$ and $L_{g_2, B_2, A_2; N^-, N^+}$ are the same, imply that when the pair (V_-, V_+) is either

$$(148) \quad (N^- \cap \mathcal{W}_1^-, N^+ \cap \mathcal{W}_1^-), \quad \text{or} \quad (N^- \cap \mathcal{W}_1^+, N^+ \cap \mathcal{W}_1^+),$$

then

$$L_{g_2, B_2, A_2; V_-, V_+}(f) = L_{g_1, B_1, A_1; V_-, V_+}(f) = L_{\underline{g}_1, \underline{B}_1, \underline{A}_1; V_-, V_+}(f).$$

for all $f \in \mathcal{D}(L_{g_1, B_1, A_1; V_-, V_+})$. As above (\mathcal{W}_2, g_2) and (\mathcal{W}_1, g_1) are isometric, we will next show that also A_2 and \underline{A}_1 coincide in these sets.

By the above considerations, we have that the map

$$(149) \quad \Psi : (\mathcal{W}_1, \underline{g}_1) \rightarrow (\mathcal{W}_2, g_2)$$

is a isometric diffeomorphism. Moreover, as

$$L_{g_2, B_2, A_2; V_-, V_+} = L_{\underline{g}_1, \tilde{B}_1, \underline{A}_1; V_-, V_+}$$

and the maps $D^\kappa|_0 L_{\underline{g}_1, \tilde{B}_1, \underline{A}_1; V_-, V_+}$ and $D^\kappa|_0 L_{\underline{g}_1, \tilde{B}_1, \underline{A}_1; V_-, V_+}$ are the same up to a smoothing error of order one, the maps $D^\kappa|_{f=0} L_{\underline{g}_1, \tilde{B}_1, \underline{A}_1; V_-, V_+}(f)$ and $D^\kappa|_{f=0} L_{g_2, B_2, A_2; V_-, V_+}(f)$ of source-to-solution maps on isometric Lorentzian manifolds $(\mathcal{W}_1, \underline{g}_1)$ and (\mathcal{W}_2, g_2) are the same up to a smoothing error of order one.

Step 4: *Construction of A in neighborhoods of \mathcal{I}^- and \mathcal{I}^+ and modified source-to-solution maps.*

The results in [83] imply that when the metric of a Lorentzian manifold is given, the source-to-solution operator for the non-linear wave equation determines the coefficient A of the non-linear term uniquely. Moreover, the construction of A does not depend on the possible zeroth order term q in the equation. More precisely, using [83, Prop. 4.3 and 4.5] and the formula (149), when (V_-, V_+) is the pair $(N^- \cap \mathcal{W}_1^-, N^+ \cap \mathcal{W}_1^-)$, we see that the equation $\underline{A}_1 = \Phi^* A_2$ holds on the set \mathcal{W}_1^- . Similarly, using the formula (149) when (V_-, V_+) is the pair $(N^- \cap \mathcal{W}_1^+, N^+ \cap \mathcal{W}_1^+)$, we see that the equation $\underline{A}_1 = \Phi^* A_2$ holds on the set \mathcal{W}_1^+ . Thus, $\underline{A}_1 = \Phi^* A_2$ holds on the set \mathcal{W}_1 . Note that we do not know whether the function \underline{g}_1 is zero or not, but as this function does not change the principal symbol of the source-to-solution map, this will not cause issues in our considerations below.

Above, we have shown that the sets (V_1, \underline{g}_1) and (V_2, g_2) , where we denote $V_j := I^-(p_0^+) \cap I^+(p_{-2}) \subset N_{\text{ext}}^j$, $j = 1, 2$, are isometric and thus we can identify these sets below and denote those by V . With this identification, the metric tensor g_2 and \underline{g}_1 as well as the coefficients A_2 and \underline{A}_1 coincide on V . As V is a globally hyperbolic manifold, derivatives of the source-to-solution maps, $D^\kappa|_0 L_{\underline{g}_1, \tilde{B}_1, \underline{A}_1; V, V}$ and $D^\kappa|_0 L_{g_2, B_2, A_2; V, V}$ are the same up to an order 1 smoothing error.

Similarly, as we have shown that sets (W_1, \underline{g}_1) and (W_2, g_2) , where $W_j = I^+(p_0^-) \cap I^-(p_{+2}) \subset N_{\text{ext}}^j$, $j = 1, 2$ are isometric, we identify the sets W_j , $j = 1, 2$, and denote them by W . As above, we see that the source-to-solution maps $D^\kappa|_0 L_{\underline{g}_1, \tilde{B}_1, \underline{A}_1; W, W}$ and $D^\kappa|_0 L_{g_2, B_2, A_2; W, W}$ are the same up to an order 1 smoothing error.

Step 5: *Reconstruction of near field measurements, that is, finding a family of the source-to-solution maps in a neighborhood $\hat{\mu}$.*

Next we use the path $\mu_{\text{mod}} = \hat{\mu} \cap J_{N_{\text{ext}}}^+(p_-) \cap J_{N_{\text{ext}}}^-(p_+)$ and let U be a neighborhood of μ_{mod} such that $\text{cl}(U) \subset N^- \cup W$. Using the first derivatives of the above constructed source-to-solution maps (i.e., the linearized source-to-solution maps) we see that the causality relations $R_{U, g_j}^{\leq} = \{(x, y) \in U \times U \mid x <_{(j)} y\}$ in the set U , where $<_{(j)}$ is the causality relation of the Lorentzian manifold (N_{ext}, g_j) , coincide for $j = 1, 2$.

Recall that the zeroth order term q does not change principal symbols of the derivatives of the source-to-solution maps. Let us next denote

$$(150) \quad \begin{aligned} & D^\kappa|_0 L_{g_j, B_j, A_j, V_1, V_2}[f_1, f_2, f_3, f_4] \\ &= \left. \partial_{\varepsilon_1} \partial_{\varepsilon_2} \partial_{\varepsilon_3} \partial_{\varepsilon_4}^{\kappa-3} L_{g_j, B_j, A_j, V_1, V_2}(\varepsilon_1 f_1 + \varepsilon_2 f_2 + \varepsilon_3 f_3 + \varepsilon_4 f_4) \right|_{\varepsilon=0}, \end{aligned}$$

see (112). Thus the above shows that the source-to-solution maps

$$(151) \quad (f_1, f_2, f_3, f_4) \rightarrow D^\kappa|_0 L_{\underline{g}_1, \tilde{B}_1, \underline{A}_1, V_1, V_2}[f_1, f_2, f_3, f_4]$$

and

$$(152) \quad (f_1, f_2, f_3, f_4) \rightarrow D^\kappa|_0 L_{g_2, B_2, A_2, V_1, V_2}[f_1, f_2, f_3, f_4]$$

are the same up to smoothing error of order 1 when $(V_1, V_2) = (V, V)$, $(V_1, V_2) = (W, W)$, or $(V_1, V_2) = (N^-, N^+ \cap I^-(p_{+2}))$.

We observe that any point $p \in U$ has an open neighborhood $O_p^{(1)} \subset U$ and any point $q \in J^+(p) \cap U$ has a neighborhood $O_{p,q}^{(2)} \subset U$ such that for some of the above pairs (V_1, V_2) it holds that $O_p^{(1)} \subset V_1$ and $O_{p,q}^{(2)} \subset V_2$. Thus, the above considerations lead to the following conclusion: We have shown that the metric tensors g_j , $j = 1, 2$, and the coefficients A_j of the non-linear term coincide up to a conformal transformation in a neighborhood U of the path μ_{mod} . Moreover, any points $p \in U$ and $q \in J^+(p) \cap U$ and for all $f_1, f_2, f_3, f_4 \in H_0^k(U)$ supported in an open neighborhood $O_p^{(1)} \subset U$ we can determine the principal symbol of $D_\kappa|_{\varepsilon=0} u^{f_\varepsilon}$ in $O_{p,q}^{(2)}$. For points $q \in U \setminus J^+(p)$ this principal symbol is zero, and we can find the principal symbol of $D_\kappa|_{\varepsilon=0} u^{f_\varepsilon}$ in the whole set U . Hence, for the functions f_1, f_2, f_3, f_4 supported in $O_p^{(1)} \subset U$, the maps

$$(153) \quad (f_1, f_2, f_3, f_4) \rightarrow D^\kappa|_0 L_{\underline{g}_1, \tilde{B}_1, \underline{A}_1, O_p, U}[f_1, f_2, f_3, f_4]$$

and

$$(154) \quad (f_1, f_2, f_3, f_4) \rightarrow D^\kappa|_0 L_{g_2, B_2, A_2, O_p, U}[f_1, f_2, f_3, f_4]$$

are the same up to smoothing error of order 1. Thus for such sources f_j the principal symbols of $D_\kappa|_{\varepsilon=0}(u^{f_\varepsilon}|_U) = D^\kappa|_{f=0} L_{g_j, B_j, A_j, U, U}(f)[f_1, f_2, f_3, f_4]$ are the same for $j = 1, 2$.

Step 6: Reconstruction of the manifold.

Recall that $U \subset N^- \cup W$ is a neighborhood of the connected path μ_{mod} . This makes it possible to apply the results of [75, 83] for the inverse problem where the source-to-solution map is studied in the case when the set U_{in} , where sources are supported, and the the set U_{out} , where the waves are observed, are the same neighborhood $U = U_{in} = U_{out}$ of a connected time-like path. Thus the fact that the maps (153) and (154) are the same up to smoothing error of order 1 implies that we can determine the principal symbols of functions $D_\kappa u^{f_\varepsilon}|_{\varepsilon=0}$ in U , where f_ε are linear combinations of conormal sources f_k , $k = 1, 2, 3, 4$, that are all supported in some open set O_p . Moreover, the union of these open sets O_p covers the whole set U .

The above observation can be used in the proof of Theorem 4.5 of [75] where in all steps one needs to consider only sources f_ε that are supported in

an arbitrarily small neighborhoods $O_p \subset U$. In particular, for $x_0 \in O_p$ and a light-like geodesic $\gamma_{x_0, \xi}$ emanating from x_0 , we see using Lemma 5 that for all $q \in \gamma_{x_0, \xi}([0, \rho(x_0, \xi)]) \cap N$, for which we have $a(q) \neq 0$, we can determine the light-observation set $\mathcal{E}_U(q)$. For $q \in \gamma_{x_0, \xi} \cap N_-$ the first Frechet derivatives of the source-to-solution map $L_{g, B, A, O_p, U}$ determines the light-observation set $\mathcal{E}_U(q)$ and as the Lorentz metric on N_- is given to us, we can determine $\mathcal{E}_U(q)$ for the points $q \in \gamma_{x_0, \xi} \cap N_+$. Using these observations and the proof of Theorem 4.5 of [75], we can determine the conformal type of the space-time $I^+(p_-) \cap I^-(p_+)$. Again, we can perform a conformal transformation to change the quadruple $(N_{\text{ext}}^1, g_1, B_1, A_1)$ to $(N_{\text{ext}}^1, \underline{g}_1, \tilde{B}_1, \underline{A}_1)$ so that there is an isometric diffeomorphism

$$\Psi : (I_{N_{\text{ext}}^1}^+(p_-) \cap I_{N_{\text{ext}}^1}^-(p_+), g_1) \rightarrow (I_{N_{\text{ext}}^2}^+(p_-) \cap I_{N_{\text{ext}}^2}^-(p_+), g_2).$$

After this, we can use the analysis of the principal symbols of the κ :th derivatives of source-to-solution maps, see [83, Theorem 6.2], and prove that $\underline{A}_1 = \Psi^* A_2$ on $I_{N_{\text{ext}}^1}^+(p_-) \cap I_{N_{\text{ext}}^1}^-(p_+)$. By letting $p_+ \rightarrow i_+$ and $p_- \rightarrow i_-$, we see that after performing a conformal transformation to the triple $(N_{\text{ext}}^2, g_2, A_2)$ there is an isometry $\Psi : (N_{\text{ext}}^1, \underline{g}_1) \rightarrow (N_{\text{ext}}^2, g_2)$ and $\underline{A}_1 = \Psi^* A_2$ on N_{ext}^1 . This proves the claim. \square

As Schwartz class perturbations of the Minkowski space satisfy the assumptions of Theorem 2, we see that Theorem 1 follows from Theorem 2. Theorem 4 follows by applying a conformal transformation (47) that changes (M, g) to the space-time (M, g_0) with an asymptotically Minkowskian infinity and the wave equation (45) to (46). Then, using only the restricted scattering data, we apply the proof of Theorem 2 using only those points p_- for which the sets $\mathcal{W}_j^- = I_{N_{\text{ext}}^j}^-(p_0^+) \cap I_{N_{\text{ext}}^j}^-(p_-)$ satisfy $\mathcal{W}_j^- \subset S(R(t_1^*))$, and obtain the claim of Theorem 4.

5.0.1. *On the further generalizations.* The techniques developed in this paper can be generalized to certain metric tensors that are non-smooth at the spatial infinity i_0 of the Penrose compactification. This situation is encountered in several physical models with a positive total Arnowitt–Deser–Misner (ADM) mass of the space-time, see [126, pp. 276-278 and 281-285]. However, for such metric tensors the existence of solutions to the direct problem is a difficult and deep problem, see [64, 65]. This generalization is outside the scope of this paper and will be considered elsewhere, but we will below discuss in brief how this generalization can be done. First, let us assume (M, g_M) is a space-time whose conformal compactification (N, g_N) is such that the set N is equal to $\hat{N} \subset \mathbb{R} \times \mathbb{S}^3$ used to define the Penrose conformal compactification. Moreover, assume that the metric g_N on N can be extended to N_+ and N_- in a way that makes $N_{\text{ext}} = N \cup N_- \cup N_+$ a globally hyperbolic manifold with a C^0 -metric g_{ext} that is C^∞ -smooth in $N_{\text{ext}} \setminus i_0$ and ∂N is a light cone emanating from i_0 . Moreover, we assume that (M, g_M) is a glued Schwarzschild space-time in the sense of Joudioux, see [64, Def. 1.3]. This implies that (M, g_M) is a Chrusciel-Delay/Corvino-Schoen type space, the conformally compactified metric has a C^∞ -smooth extensions to the neighborhoods of the points i_+ , and i_- , and the spatial infinity i_0 has a neighborhood where the metric is isometric to the Schwarzschild metric.

The initial data sets for such space-times satisfy the constraint equations obtained by Chrusciel-Delay [30] and Corvino-Schoen [31]. Moreover, we need to assume that i_0 has no light-like cut points in the conformal infinities $\mathcal{I}^+ \setminus \{i_+\}$ and $\mathcal{I}^- \setminus \{i_-\}$. Second, consider the non-linear cubic wave equation $(\square_{g_{\text{ext}}} + B_{g_{\text{ext}}})u + au^3 = 0$, where $a(x) < 0$ in N and assume that $a(x)$ can be smoothly extended by zero to $(N_- \cup N_+) \setminus i_0$. Then, the Cauchy problem for the wave equation

$$(155) \quad (\square_{g_{\text{ext}}} + B_{g_{\text{ext}}})u + au^3 = f,$$

in N_{ext} with the compactly supported smooth sources f exists and is unique, see [65, Prop. 2.1], and moreover, the scattering operator is globally defined, see [64, Thm. 4.4]. However, to study the inverse problem with minimal data we define scattering functionals in smaller domains. To do this, let $\mathcal{D}'_{\Gamma}(\mathcal{I}^-)$, see [57, Sec. 8.2] be the set of distributions on \mathcal{I}^- whose wave front set is a subset of a conic set $\Gamma \subset T^*\mathcal{I}^-$. Let $\pi : T^*\mathcal{I}^- \rightarrow \mathcal{I}^-$ be the projection of a covector to its base point, and $\Gamma_n \subset T^*\mathcal{I}^-$, $n \in \mathbb{Z}_+$ be a family of growing conic open subsets whose union is the complement of the light-like directions in $T^*\mathcal{I}^-$ and for which the sets $\pi(\Gamma_n)$ are relatively compact. Moreover, let $q_n \in \mathcal{I}^-$ be such that $\pi(\Gamma_n) \subset J^+(q_n)$. Then, the scattering functionals $S_{n,p} : h \rightarrow u|_{\mathcal{I}^+(p)}$, where $n \in \mathbb{Z}_+$ and $p \in \mathcal{I}^+$, are defined for $h \in \mathcal{D}(S_{n,p}) = \{h \in H^5(\mathcal{I}^-) \cap \mathcal{D}'_{\Gamma_n}(\mathcal{I}^-) \mid \|h_-\|_{H^5(\mathcal{I}^-)} < \varepsilon_{n,p}\}$, where $\varepsilon_{n,p} > 0$ are sufficiently small. Note that such boundary values h cause waves whose wave front sets propagate to N^{int} but not along \mathcal{I}^+ . To define the domains of the source-to-solutions operators, let $v = v^h$ be the solution of the Goursat problem for the linear wave equation in N_- with the reversed causality,

$$(156) \quad \begin{aligned} \square_{g_{\text{ext}}} v + B_{g_{\text{ext}}} v &= 0, \quad \text{in } N_-, \\ v|_{\mathcal{I}^-} &= h. \end{aligned}$$

Then, the source-to-solution operators $L_{n,p} : f \rightarrow u^f|_{\mathcal{I}^-(p^+) \cap N_+}$, where $n \in \mathbb{Z}_+$ and $p^+ \in N_+$, for the equation (155) are defined analogously to (42) for $f \in \mathcal{D}(L_{n,p^+})$, where

$$\begin{aligned} \mathcal{D}(L_{n,p}) &= \{(\square_{g_{\text{ext}}} + B_{g_{\text{ext}}})(\psi v^h) \in H^5(N_-) : h \in \mathcal{D}(S_{n,p}), \psi \in C^\infty(N_{\text{ext}}), \\ &\quad J^+(\text{supp}(\psi)) \cap \mathcal{I}^- \subset J^+(q_n), \psi = 1 \text{ near } \text{supp}(h)\}. \end{aligned}$$

We note that the sets $\mathcal{D}(L_{n,p^+})$ are defined in somewhat less natural way than the domains of the source-to-solution operators for the asymptotically Minkowskian space-times, but it contains sources which produce waves whose wave front set propagates to the unknown space-time N . Next, let u^f denote the solution of the Cauchy problem (40) with $\kappa = 3$ and the source $f \in \mathcal{D}(L_{n,p^+})$. Then, the non-smoothness at i_0 produces singularities in the wave u^f , but these singularities propagate along the light cone \mathcal{I}^+ emanating from i_0 . Thus, the non-linear interaction does not affect to these singularities as the coefficient $a(x)$ vanishes on this light-cone. Hence the singularities emanating from i_0 do not cause observable singularities in N_+^{int} . To reconstruct the light observation sets for the wave equation (155) with a cubic non-linearity, we need to replace the analysis done in the proof of Lemma 5 for the

κ -th order non-linearity with that arguments similar to those in proof of Theorem 6.1 in [83], that is, one needs to consider the singularities produced by the 5th order interaction. Alternatively, one can use more advanced, recent techniques developed in [53] to analyze directly the 3rd order interactions. Then, by using the modified version of Lemma 5, one can proceed as in the proof of Theorem 2 and reconstruct the conformal type of the manifold \mathcal{W} that is defined in (139) and contains the sets V and W (See Fig. 10). Moreover, as in the proof of Theorem 2 one can see that the source-to-solutions maps (151) and (152) are the same up to smoothing error of order 1 for all pairs $(V_1, V_2) = (V, V)$, $(V_1, V_2) = (W, W)$, or $(V_1, V_2) = (N^-, N^+ \cap I^-(p_{+2}))$. Let $\hat{\mu}(s)$ be the path $\hat{\mu}(s) = (s, SP)$ and U a neighborhood of $\hat{\mu}((0, s_{+2}))$ in N_+ . Let $r < 0$ be such that $J^+(\hat{\mu}(r)) \cap I^-(p_{+2}) \subset W$. After these more difficult steps where we have constructed the space-time near the light-like and space-like infinities, let us consider how one can determine the earliest light observation sets $\mathcal{E}_U(q)$ for the points $q \in J^+(p_-) \cap J^-(p_+)$. To do this, we make three observations: First, as the Lorentzian manifold W is already constructed and thus known, we can determine the sets $\mathcal{E}_U(q)$ for all $q \in W$. Second, by using the first derivatives of the source-to-solution maps (151), we can determine $\mathcal{E}_U(q)$ for all $q \in N^- \cap I^+(p_{-2})$. Third, let $x_j \in N_-$, $j = 1, 2, 3, 4$ be points in a sufficiently small neighborhood of the point $\hat{\mu}(s)$, $s_{-2} < s \leq r$ and $\xi_j \in T_{x_j} N_{\text{ext}}$ be future directed light-like vectors and $t_0 > 0$ be sufficiently small. Then, we can use the above discussed version of Lemma 5 for the wave equation with cubic non-linearity and the proof of Lemma 6 to construct the set $\mathcal{S}(\vec{x}, \vec{\xi}, t_0)$ given in Lemma 6. Note that these sets are either of the form $\mathcal{E}_U(q)$, where $q = \gamma_{x_1, \xi_1}(t)$ with $t > t_0$, or sets that does not intersect $\mathcal{N}(\vec{x}, \vec{\xi}, t_0)$, c.f. Lemma 6.

Then, we can apply a layer stripping method based on induction to reconstruct the space-time: First, we note that as $J^+(\hat{\mu}(r)) \cap J^-(p_-) \subset W$, we already have found the collection of the light observation sets $\{\mathcal{E}_U(q) : q \in J^+(\hat{\mu}(r)) \cap J^-(p_-)\}$. Then, by using the above three observations and the proof of Theorem 2, we can apply the induction steps in the proof of Theorem 4.5 in [75] to recurrently reconstruct the sets $\{\mathcal{E}_U(q) : q \in J^+(\hat{\mu}(r_j)) \cap J^-(p_+)\}$ with a sequence of values r_j , $j = 1, 2, \dots, J$, where $r_0 = r$, $r_{j+1} \in (r_j - \varepsilon, r_j)$, $r_J = s_-$, and $\varepsilon > 0$ is small enough. Hence we can find the collection $\{\mathcal{E}_U(q) : q \in J^+(\hat{\mu}(s_-)) \cap J^-(p_+)\}$. Then, similarly to the proof of Theorem 2, we can reconstruct the conformal type of the space-time $J^+(\hat{\mu}(s_-)) \cap J^-(p_+) = J^+(p_-) \cap J^-(p_+)$. By letting $s_- \rightarrow -\pi$ and $s_+ \rightarrow \pi$, we find the conformal type of N .

As noted above, we will present the details of these constructions elsewhere, and do consider in this paper the space-times that are asymptotically Minkowskian and smooth near i_0 , in particular, as in the this case the direct problem can be solved without assuming that the spacetime is isometric to a given, a priori known space-time (e.g., the Schwarchild or the Minkowski space) in a neighborhood of i_0 .

APPENDIX A. ENERGY INEQUALITY FOR A NONLINEAR WAVE EQUATION

In this section we prove an a-priori energy inequality for the wave equation

$$\square_g \psi + B\psi + A\psi^\kappa = F.$$

At this stage, the number κ can be any positive integer greater than or equal to 1. We will prove the energy inequality in a Sobolev space H^k .

Below, we use time functions $\mathbf{t}_j : N_j \rightarrow \mathbb{R}$ defined in (64) and the relatively compact sets W and W_0 defined in (65) and (66) with $T_1 < 0 < T_2$ chosen so that $\overline{\mathbb{D}_0} \subset W_0^{\text{int}}$. Note that the future part of the boundary of W is the smooth surface

$$\Sigma_f := \{x \in N_1 \mid t_1(x) > T_1\} \cap \{x \in N_2 \mid t_2(x) = T_2\}$$

and the past of the boundary is a subset of the union of \mathcal{I}^- and the Cauchy surface Σ_{T_1} , where \mathcal{I}^- is as in (7). Let us denote the light-like part of the boundary of W by

$$\mathcal{I}^-(T_1) := \mathcal{I}^- \cap \{x \in N_1 \mid \mathbf{t}_1(x) > T_1\}.$$

Now W is foliated by the space-like surfaces

$$\Sigma_t := \{x \in W \mid \mathbf{t}_2(x) = t\}.$$

Note that the surfaces $\Gamma := \{x \in N_1 \mid \mathbf{t}_1(x) = T_1\} \cap \{x \in N_2 \mid \mathbf{t}_2(x) = t\}$ are not necessarily smooth but we are going to consider the initial and boundary values which will imply that the solution ψ vanishes identically near $\{x \in N_1 \mid \mathbf{t}_1(x) = T_1\}$. Thus the analysis of the solution ψ near Γ does not pose a problem.

We denote

$$Z_0^k(W) = \{F \in H^k(\mathcal{I}^-(W)) \mid F(x) = 0 \text{ for } x \in J^-(\mathcal{I}^- \cup \Sigma_{T_1}) \cap W\}.$$

We are now ready to state the main result of this section.

Proposition 1. *Suppose $\psi \in H^{k+1}(W)$, where $k + 1 > 2$ satisfies*

$$\square_g \psi + B\psi + A\psi^\kappa = F, \quad \text{on } W$$

where $A, B \in C^k(W)$, $F \in Z_0^k(W)$ and $\kappa \geq 1$. Assume $\text{supp}(F) \subset I^+(W)$ is compact and that there exists an open neighbourhood U of $\{x \in N_1 \mid \mathbf{t}_1(x) = T_1\} \cup \{i_0\}$ such that $U \cap \text{supp}(F) = \emptyset$ and $\psi \equiv 0$ in U . Then there is $\varepsilon > 0$ such that if

$$\|F\|_{H^k(W)} + \|\psi\|_{H^{k+1}(\mathcal{I}^-(T_1))} < \varepsilon,$$

then for any $\ell = 0, \dots, k$,

(157)

$$\|\partial_t^\ell \psi\|_{H^{k-\ell+1}(\Sigma_t)} + \|\partial_t^{\ell+1} \psi\|_{H^{k-\ell}(\Sigma_t)} \leq C \left(\|F\|_{H^k(W)} + \|\psi\|_{H^{k+1}(\mathcal{I}^-(T_1))} \right)$$

for $T_1 \leq t \leq T_2$. If $\kappa = 1$ we do not need to assume the smallness of the norms of F and the initial values. Moreover, similar results follow when W is replaced by W_0 .

Remark 3. Letting $\nabla \mathbf{t}_2$ be the smooth time-like normal vector field along Σ_t induced by \mathbf{t}_2 , summing over $\ell = 0, \dots, k$, and integrating (157) over $t \in [T_1, T_2]$ yields

$$\begin{aligned} \|\psi\|_{H^{k+1}(W)}^2 &\leq C \sum_{\ell=0}^k \int_{T_1}^{T_2} \left(\|\partial_t^\ell \psi\|_{H^{k-\ell+1}(\Sigma_t)}^2 + \|\partial_t^{\ell+1} \psi\|_{H^{k-\ell}(\Sigma_t)}^2 \right) |\nabla \mathbf{t}_2| dt \\ &\leq C(T_2 - T_1)(\ell + 1) \left(\|F\|_{H^k(W)}^2 + \|\psi\|_{H^{k+1}(\mathcal{I}^-(T_1))}^2 \right). \end{aligned}$$

To work in Sobolev spaces, we will construct a finite collection of vector fields on W that span the tangent spaces of W at all points. Consider a finite open cover of the compact set \bar{W} by coordinate charts $\{(U_j, \varphi_j)\}_{j=1}^J$. Let $p \in \bar{W}$. Then $p \in U_j$ for some $j \in \{1, \dots, J\}$. Let V_p be an open set with compact closure such that $\bar{V}_p \subset U_j$. Now the sets V_p form an open cover of \bar{W} , so there is a finite subcover $\{V_k\}_{k=1}^K$. By construction $V_k \subset U_{j_k}$ for some j_k , so also the charts (V_k, φ_{j_k}) form an atlas of \bar{W} . Let $\chi_k \in C^\infty(N_{\text{ext}})$ be such that

$$\chi_k(x) = \begin{cases} 1, & x \in V_k, \\ 0, & x \notin U_{j_k}. \end{cases}$$

Let ∂_i , $i = 1, 2, 3, 4$, denote the coordinate vector fields of U_{j_k} . We can now define

$$X_i = \chi_k(x) \partial_i,$$

so that $X_i = \partial_i$ in V_k and $X_i = 0$ in $W \setminus U_{j_k}$. Doing this for all of the finitely many sets V_k , $k = 1, \dots, K$ yields (at most) $4K$ vector fields X_i , such that

$$(158) \quad T_p W = \text{span}\{X_{i_1}, X_{i_2}, X_{i_3}, X_{i_4} \mid \text{for some } 1 \leq i_1 < i_2 < i_3 < i_4 \leq 4K\}$$

for all $p \in W$. We will let $X_{i_1} = \partial_t$ be the vector along the time-direction, that is, $X_{i_1} = \partial_t$. It can be shown that

$$\|\nabla^j f\|_{L^2(W)} \lesssim \sum_{l=0}^j \sum_{i=1}^{4K} \|X_i^l f\|_{L^2(W)}$$

Proof of Proposition 1. Let $\psi \in C^\infty(N_{\text{ext}})$. We will prove the energy inequality up to $t \in [T_1, T_2]$. Let

$$W_t = \{x \in N_1 \mid \mathbf{t}_1(x) > T_1\} \cap \{x \in N_2 \mid \mathbf{t}_2(x) < t\} \setminus N^-$$

and note $W = W_{T_2}$. The space-like future boundary of W_t is given by Σ_t . To obtain estimates in the Sobolev spaces it suffices to consider $\psi \in C^\infty(W)$, and to find estimates in L^2 in terms of the vector fields X_i . Let $\partial_i \in T_p W$. Then a direct calculation using Leibniz rule shows that the following equalities hold for the commutators:

$$(159) \quad \begin{aligned} [\partial_i^k, \square] \psi &= \sum_{|\alpha| \leq k+1} a_\alpha \partial^\alpha \psi, & [\partial_i^k, B] \psi &= \sum_{|\alpha| < k} b_\alpha \partial^\alpha \psi, \\ \partial_i^k (A \psi^\kappa) &= \sum_{j_1 + \dots + j_{\kappa+1} = k} \binom{k}{j_1, \dots, j_{\kappa+1}} (\partial_i^{j_{\kappa+1}} A) \prod_{l=1}^{\kappa} \partial_i^{j_l} \psi \\ &= \kappa A \psi^{\kappa-1} \partial_i^k \psi + \sum_{\substack{j_1 + \dots + j_{\kappa+1} = k \\ j_{\kappa+1} \geq 1}} \binom{k}{j_1, \dots, j_{\kappa+1}} (\partial_i^{j_{\kappa+1}} A) \prod_{l=1}^{\kappa} \partial_i^{j_l} \psi, \end{aligned}$$

where the coefficient functions a_α are smooth and $b_\beta \in C^{k-|\alpha|}(W)$. We will now consider

$$P^{k-\ell} \partial_t^\ell \psi := \sum_{|\alpha| \leq k-\ell} X^\alpha \partial_t^\ell \psi, \quad 0 \leq \ell \leq k,$$

which is a differential operator of order k , where $X \in \Gamma\Sigma_t$ are vector fields along the space-like surfaces Σ_t and ∂_t the vector field of \mathbf{t} . To simplify the notation, in the sequel we will denote

$$(160) \quad \psi_{\ell,k} := P^{k-\ell} \partial_t^\ell \psi.$$

Then, since $\square\psi + B\psi + A\psi^\kappa = F$, using the standard multi-index notation for α , we have

$$\begin{aligned} P^{k-\ell} \partial_t^\ell F &= P^{k-\ell} \partial_t^\ell (\square\psi + B\psi + A\psi^\kappa) \\ &= \square(\psi_{\ell,k}) + \mathcal{R}[\psi], \end{aligned}$$

where $\mathcal{R}[\psi]$ denotes the lower order terms:

$$\begin{aligned} \mathcal{R}[\psi] &:= \sum_{|\alpha| \leq k+1} a_\alpha \partial^\alpha \psi + B\psi_{\ell,k} + \sum_{|\alpha| < k} b_\alpha \partial^\alpha \psi \\ &\quad + A\psi^{\kappa-1} \tilde{P}^k \psi + \sum_{i=0}^3 \sum_{\substack{j_1+\dots+j_{\kappa+1}=k \\ j_{\kappa+1} \geq 1}} c_{j_1, \dots, j_{\kappa+1}} \prod_{l=1}^{\kappa} \partial_i^{j_l} \psi \end{aligned}$$

for some continuous functions a_α , b_β and c_δ and a differential operator \tilde{P}^k of order k with smooth coefficients. Since the space H^k is an algebra, when $k > n/2$, we have

$$(161) \quad \int_{W_t} \mathcal{R}[\psi]^2 dV_{g_{\text{ext}}} \lesssim \|\psi\|_{H^{k+1}(W_t)}^2 + \|\psi\|_{H^{k+1}(W_t)}^{2\kappa}.$$

To work with the wave equation and Stokes' theorem, it is convenient to define the *energy-momentum tensor* associated to a smooth function ψ to be the $(0, 2)$ -tensor field

$$(162) \quad Q[\psi] := d\psi \otimes d\psi - \frac{1}{2} g_{\text{ext}}^{-1}(d\psi, d\psi) \cdot g_{\text{ext}}.$$

It can be shown that

$$\text{div}(Q[\psi]) = (\square_{g_{\text{ext}}} \psi) d\psi,$$

where the divergence is defined via $\text{div}(V) = (\nabla^i V)_i$. We use the following lemma of Aretakis [5]:

Lemma 7. *If V_1, V_2 are future-directed time-like vector fields, then the energy-momentum tensor is positive-definite, that is*

$$Q[\psi](V_1, V_2) \geq C \sum_{j=0}^3 (\partial_j \psi)^2, \quad C > 0.$$

Let us then contract $Q[\psi_{\ell,k}]$ by a vector field V of N_{ext} and take the divergence as

$$(163) \quad \text{div}(Q[\psi_{\ell,k}]V) = \text{div}(Q[\psi_{\ell,k}])V + \frac{1}{2} Q[\psi_{\ell,k}]_{ij} \pi_V^{ij}$$

where $(\nabla V)^{ij} = (g^{ki} \nabla_k V)^j = (\nabla^i V)^j$ and $\pi_V^{ij} = (\nabla^i V)^j + (\nabla^j V)^i$ is the deformation tensor of V . Integrating (163) over the domain W in N_{ext} , by

Stokes' theorem,

$$(164) \quad \int_{W_t} ((\square\psi_{\ell,k})(V\psi_{\ell,k})) \frac{1}{2} Q[\psi_{\ell,k}]_{ij} \pi_V^{ij} dV_{g_{\text{ext}}} = \int_{\partial W_t} Q[\psi_{\ell,k}](V, n) d(\partial W_t),$$

where n is the normal vector to the boundary ∂W_t and $d(\partial W_t)$ is the induced volume on the boundary. We remind the reader that the boundary of W_t is not necessarily a smooth surface, particularly near $\Gamma = \{\mathbf{t}_1(x) = T_1\} \cap \{\mathbf{t}_2(x) = t\}$, but since ψ vanishes identically near Γ Stokes' theorem remains valid. We will analyse the form of the volume form on the boundary below. Let now V be a time-like vector field and let

$$f(t) := \int_{\Sigma_t} Q[\psi_{\ell,k}](V, n_t) d\Sigma_t,$$

where n_t is the future-directed normal vector of Σ_t and $d\Sigma_t$ is a Riemannian volume form on Σ_t . By Lemma 7, we know

$$(165) \quad c \int_{\Sigma_t} \sum_{j=0}^3 (\partial_j \psi_{\ell,k})^2 d\Sigma_t \leq f(t) \leq C \int_{\Sigma_t} \sum_{j=0}^3 (\partial_j \psi_{\ell,k})^2 d\Sigma_t.$$

Let $\mathcal{I}^-(T_1, t) = \mathcal{I}^- \cap \{x \in N_1 \mid T_1 < \mathbf{t}_1(x) < t\}$. By Stokes' theorem and (164) we have

$$\begin{aligned} & \int_{W_t} (V\psi_{\ell,k})(\mathcal{R}[\psi] - P^{k-\ell} \partial_t^\ell F) dV_{g_{\text{ext}}} + \int_{W_t} Q[\psi_{\ell,k}](\nabla V) dV_{g_{\text{ext}}} \\ &= \int_{W_t} \text{div}(Q[\psi_{\ell,k}](V)) dV_{g_{\text{ext}}} \\ &= - \int_{\Sigma_t} Q[\psi_{\ell,k}](V, n) d\Sigma_t + f(T_1) + \int_{\mathcal{I}^-(T_1, t)} Q[\psi_{\ell,k}](V, n) d\mathcal{I}^- \end{aligned}$$

where n is the future directed normal vector of ∂W_t and $d\mathcal{I}^-$ is a volume element on the null surface $\mathcal{I}^-(T_-, t)$. Rearranging, we get

$$(166) \quad \int_{\Sigma_t} Q[\psi_{\ell,k}](V, n) d\Sigma_t = f(T_1) - \int_{W_t} (V\psi_{\ell,k})(\mathcal{R}[\psi] - P^{k-\ell} \partial_t^\ell F) dV_{g_{\text{ext}}} \\ - \int_{W_t} Q[\psi_{\ell,k}](\nabla V) dV_{g_{\text{ext}}} + \int_{\mathcal{I}^-(T_1, t)} Q[\psi_{\ell,k}](V, n) d\mathcal{I}^-.$$

Because V and n are time-like then in view of Lemma 7

$$\int_{\Sigma_t} |Q[\psi_{\ell,k}](\nabla V)| d\Sigma_t \leq C f(t).$$

Recall that W is foliated by the space-like surfaces $\Sigma_t = \{x \in N_1 \mid \mathbf{t}_2(x) = t\}$ and $\nabla \mathbf{t}_2$ is a smooth time-like normal vector field along Σ_t . By the smooth co-area formula, see [26], we then find

$$\int_{T_1}^t \int_{\Sigma_t} |Q[\psi_{\ell,k}](\nabla V)| d\Sigma_t dt = \int_{W_t} |Q[\psi_{\ell,k}](\nabla V)| |\nabla \mathbf{t}_2| dV_{g_{\text{ext}}} \leq C \int_{T_1}^t f(s) ds$$

where we use the compactness of W and that $c \leq |\nabla \mathbf{t}_2| \leq C$ in W for some constants $C, c > 0$. On the other hand, by Cauchy-Schwarz inequality and

the co-area formula

$$\begin{aligned}
 & \int_{W_t} |\mathcal{R}[\psi] \cdot V\psi_{\ell,k}| dV_{g_{\text{ext}}} \\
 & \leq C \int_{T_1}^t \|\mathcal{R}[\psi]\|_{L^2(\Sigma_s)} \|V\psi_{\ell,k}\|_{L^2(\Sigma_s)} ds \\
 & \leq C \int_{T_1}^t \left(\|\partial_t^\ell \psi\|_{H^{k-\ell+1}(\Sigma_s)} + \|\partial_t^{\ell+1} \psi\|_{H^{k-\ell}(\Sigma_s)} + \right. \\
 & \quad \left. (\|\partial_t^\ell \psi\|_{H^{k-\ell+1}(\Sigma_s)} + \|\partial_t^{\ell+1} \psi\|_{H^{k-\ell}(\Sigma_s)})^{2\kappa} + f(s) \right) ds,
 \end{aligned}$$

where we used (161) and (165). Similarly,

$$\int_{W_t} |P^{k-\ell} \partial_t^\ell F \cdot V\psi_{\ell,k}| dV_g \leq C \left(\|F\|_{H^k(W_t)} + \int_{T_1}^t f(s) ds \right)$$

It remains to analyse the last integral in the formula (166). The integral over this null surface can be understood as follows. Consider a non-vanishing null vector field $n \in \Gamma(T\mathcal{I}^-(T_1))$. Then one can find a unique function $\lambda : \mathcal{I}^-(T_1) \rightarrow \mathbb{R}$ solving the differential equation $d\lambda(n) = 1$ and $\lambda(x) = 1$, when $x \in \Sigma_{T_1} \cap \mathcal{I}^-(T_1)$. Now, restricting the Lorentzian metric g to the null surface $\mathcal{I}^-(T_1)$ and further restricting to a level set of λ shows that $\tilde{g} := g|_{\mathcal{I}^-(T_1), \lambda}$ is a Riemannian metric on the space-like submanifolds

$$\mathcal{I}^-(T_1) \cap \{x \in \mathcal{I}^-(T_1) \mid \lambda(x) = t\}.$$

Let ω be the volume form with respect to \tilde{g} . Then $d\mathcal{I}^- := d\lambda \wedge \omega$ is a volume form on $\mathcal{I}^-(T_1)$. We note that the volume form is uniquely determined after a choice of an affine vector field. Since V is time-like and n is null, we have

$$Q[\psi_{\ell,k}]_{ab} V^a n^b = (n\psi_{\ell,k})^2 + (Y_1\psi_{\ell,k})^2 + (Y_2\psi_{\ell,k})^2,$$

where $Y_1, Y_2 \in \Gamma(T\mathcal{I}^-(T_1))$ are space-like and

$$\text{span}(V(p), n(p), Y_1(p), Y_2(p)) = T_p W.$$

The information of ψ to transversal directions is absent here and thus on the null surface it is enough to know only derivatives of ψ to directions not transverse to \mathcal{I}^- . It follows from Lemma 7 by continuity that $Q[\psi_{\ell,k}](V, n) \geq 0$. Therefore

$$0 \leq \int_{\mathcal{I}^-(T_1)} Q[\psi_{\ell,k}](V, n) d\mathcal{I}^- \leq C \|\psi\|_{H^{k+1}(\mathcal{I}^-(T_1))}.$$

A.0.1. *Combination of estimates.* We have showed that

$$\begin{aligned}
 (167) \quad f(t) & \leq f(T_1) + C_0 \left(\|F\|_{H^k(W)} + \|\psi\|_{H^{k+1}(\mathcal{I}^-(T_1))} \right) \\
 & \quad + C_1 \int_{T_1}^{T_2-\delta} f(s) ds + C_2 \int_{T_1}^{T_2-\delta} f(s)^{2\kappa} ds.
 \end{aligned}$$

As we want a bound for the Sobolev H^k norm of ψ and the estimate (167) does not include $\|\psi\|_{L^2(W)}$ on the left-hand side, we need to find suitable estimate for that.

Let ϕ_s be the (smooth, global) flow of $\nabla \mathbf{t}_2$ to the future direction and let $\phi : \mathbb{R} \times N_2 \rightarrow N_2$ be the smooth map $\phi(s, x) = \phi_s(x)$. Let $x \in \Sigma_t$. By using the fundamental theorem of calculus, we see that

$$(168) \quad \psi(\phi_{t_2}(x))^2 \leq 2\psi(\phi_{t_1}(x))^2 + 2(t_2 - t_1) \int_{t_1}^{t_2} (\partial_s \psi(\phi_s(x)))^2 ds$$

for all $t_1 \leq t_2$.

Let $\theta : \Sigma_t \rightarrow \mathbb{R}$ be the map

$$\theta(x) = \{t \in \mathbb{R} \mid \phi_t(x) \in \Sigma_{T_1} \cup \mathcal{I}^-(T_1)\}.$$

Note that θ is well-defined, because $\Sigma_{T_1} \cup \mathcal{I}^-(T_1)$ and Σ_t are achronal and each integral curve of $\nabla \mathbf{t}_2$ starting from Σ_t intersects $\Sigma_{T_1} \cup \mathcal{I}^-(T_1)$ once. Thus, we see that $\theta(x) \leq 0$ for all $x \in \Sigma_t$ and hence by replacing t_2 by 0 and t_1 by $\theta(x)$ in (168), we get

$$(169) \quad \psi(x)^2 \leq 2\psi(\phi(\theta(x), x))^2 + 2\theta(\phi(\theta(x), x)) \int_{\theta(x)}^0 (\partial_s \psi(\phi_s(x)))^2 ds.$$

Here the map $\phi(\theta(x), x)$ is, in fact, one-to-one, because it is the projection from the space-like surface Σ_t to the past boundary $\Sigma_{T_1} \cup \mathcal{I}^-(T_1)$ along the integral curves of $\nabla \mathbf{t}_2$. Integrating (169) over Σ_t we obtain

$$(170) \quad \begin{aligned} \int_{\Sigma_t} \psi^2 d\Sigma_t &\lesssim \int_{\Sigma_t} \psi(\theta(\phi(\theta(x), x))) d\Sigma_t + \int_{\Sigma_t} \int_{\theta(x)}^0 (\partial_s \psi(\phi(s, x)))^2 ds d\Sigma_t \\ &\lesssim \int_{\mathcal{I}^-(T_1)} \psi(x) d\mathcal{I}^- + \int_{\Sigma_t} \int_{\theta(x)}^0 (\partial_s \psi(\phi(s, x)))^2 ds d\Sigma_t, \end{aligned}$$

where we used the fact that $\psi \equiv 0$ on Σ_{T_1} and that $\phi(\theta(\cdot), \cdot)^* d\Sigma_t = h_1 d\Sigma_{T_1}$, when $\phi(\theta(x), x) \in \Sigma_{T_1}$ and $\phi(\theta(\cdot), \cdot)^* d\Sigma_t = h_2 d\mathcal{I}^-(T_1)$, when $\phi(\theta(x), x) \in \mathcal{I}^-(T_1)$, for some $h_1, h_2 > 0$. This follows from the fact that Σ_t, Σ_{T_1} and $\mathcal{I}^-(T_1)$ are smooth surfaces and pullback takes top-rank differential form to another top-rank form. Moreover, by continuity and compactness of W , there are $c, C > 0$ such that $c \leq h_1, h_2 \leq C$.

The last integral in (170) can be estimated by using the co-area formula,

$$(171) \quad \int_{\Sigma_t} \int_{\theta(x)}^0 (\partial_s \psi(\phi(s, x)))^2 ds d\Sigma_t \leq C \int_{W_t} |\nabla \mathbf{t}_2 \psi(x)|^2 dV_{g_{\text{ext}}} \leq \int_{T_1}^{T_2} f(t) dt.$$

Here we also used that for $x_0 = \phi_{t_0}(x)$ we have $\partial_s \psi(\phi(s, x))|_{s=t_0} = \nabla \mathbf{t}_2 \psi(x_0)$, since $\nabla \mathbf{t}_2$ is the infinitesimal generator of ϕ_t .

Combining (167), (170) and (171) we have that

$$(172) \quad f(t) \lesssim \|F\|_{H^k(W)} + \|\psi\|_{H^{k+1}(\mathcal{I}^-(T_1))} + \int_{T_1}^{T_2} f(t) dt + \int_{T_1}^{T_2} f(t)^{2\kappa} dt.$$

To finish the proof we use the following nonlinear Grönwall inequality, see e.g. [129].

Proposition 2. *Assume $u_0 > 0$ and $p \geq 0$, $p \neq 1$ and v, w, u are non-negative continuous functions. Then*

$$(173) \quad u(t) \leq u_0 + \int_0^t (v(s)u(s) + w(s)u^p(s)) ds$$

implies

$$(174) \quad u(t) \leq e^{\int_0^t v(s) ds} \left[u_0^{1-p} + (1-p) \int_0^t w(s) e^{(p-1) \int_0^s v(r) dr} ds \right]^{\frac{1}{1-p}}.$$

If $u_0 = 0$ then, since the above holds for all $u_0 = u_* > 0$, by taking limit $u_0 \rightarrow 0$ the above inequality still holds, provided the limit exists.

We apply Proposition 2 to $f(t)$, $v = w = 1$ and $p = 2\kappa$, with

$$u_0 = \|F\|_{H^k(W)} + \|\psi\|_{H^{k+1}(\mathcal{I}^-(T_1))}.$$

Thus

$$f(t) \leq C \left(u_0 + \int_{T_1}^t f(s) + f^p(s) ds \right)$$

implies

$$f(t) \leq C' e^{C(t-T_1)} u_0 \left[1 - u_0^{p-1} (e^{C(t-T_1)} - 1) \right]^{\frac{1}{1-p}},$$

for all $t \in [T_1, T_2]$, if the initial data u_0 is chosen so small that

$$u_0^{p-1} (e^{C(T_2-T_1)} - 1) \leq c$$

for some $c < 1$. This concludes the proof of Proposition 1 for the set W . The analogous result in W_0 is obtained by removing the boundary condition on \mathcal{I}^- and covering the whole space W_0 by local coordinate neighborhoods. \square

Proposition 3. *Suppose $\psi_j \in H^{k+1}(W)$, $j = 1, 2$, where $k+1 > 2$ satisfy*

$$\square_g \psi_j + B\psi_j + A\psi_j^\kappa = F, \quad \text{on } W,$$

$$\psi_j(x) = 0, \quad \text{for } x \in U,$$

$$\psi_j(x) = h, \quad \text{for } x \in \mathcal{I}^-(T_1),$$

where A and B are smooth, U is an open neighbourhood of $\{x \in N_1 \mid \mathbf{t}_1(x) = T_1\} \cup \{i_0\}$ and $\text{supp}(F) \subset I^+(W)$ is compact such that $U \cap \text{supp}(F) = \emptyset$. Then, $\psi_1 = \psi_2$.

Proof. The claim follows readily by applying Proposition 1 to the difference $w = \psi_1 - \psi_2$ and observing that by the Sobolev embedding theorem, $w \in C(\overline{W})$. Since

$$s_1^\kappa - s_2^\kappa = (s_1 - s_2) \sum_{p=1}^{\kappa-1} s_1^p s_2^{\kappa-1-p} =: p_\kappa(s_1, s_2) \cdot (s_1 - s_2),$$

we see that w satisfies

$$\square_g w + Bw + Ap_\kappa(\psi_1, \psi_2) \cdot w = 0, \quad \text{on } W,$$

$$w = 0, \quad \text{for } x \in U,$$

$$w = 0, \quad \text{for } x \in \mathcal{I}^-(T_1).$$

As $Ap_\kappa(\psi_1, \psi_2)$ is a continuous function, we see using [94] that $w = 0$. Hence, $\psi_1 = \psi_2$. \square

REFERENCES

- [1] S. Acosta, G. Uhlmann, and J. Zhai. Nonlinear ultrasound imaging modeled by a westervelt equation. *SIAM J. Appl. Math.*, 82(2022):558–607, 2022.
- [2] S. Alexakis, A. Feizmohammadi, and L. Oksanen. Lorentzian Calderón problem under curvature bounds. *Invent. Math.*, 229(1):87–138, 2022.
- [3] S. Alexakis, A. Feizmohammadi, and L. Oksanen. Lorentzian calderon problem near the minkowski geometry. *J. Eur. Math. Soc.*, 2024.
- [4] P. Alinhac. Non-unicite du probleme de cauchy. *Ann. of Math.*, 117:77–108, 1983.
- [5] S. Aretakis. General relativity, University of Toronto, 2018. Lecture notes.
- [6] Y. M. Assylbekov and T. Zhou. Direct and inverse problems for the nonlinear time-harmonic maxwell equations in kerr-type media. *J. Spectr. Theory*, 11(1):1–38, 2021.
- [7] Y. M. Assylbekov and T. Zhou. Inverse problems for nonlinear maxwell’s equations with second harmonic generation. *J. Differential Equations*, 296:148–169, 2021.
- [8] J. C. Baez, I. E. Segal, and Z.-F. Zhou. The global goursat problem and scattering for nonlinear wave equations. *Journal of Functional Analysis*, 93(2):239–269, 1990.
- [9] J. C. Baez and Z.-F. Zhou. Analyticity of scattering for the ϕ^4 theory. *Comm. Math. Phys.*, 124(1):9–21, 1989.
- [10] T. Balehowsky, A. Kujanpää, M. Lassas, and T. Liimatainen. An inverse problem for the relativistic Boltzmann equation. *Comm. Math. Phys.*, 396(3):983–1049, 2022.
- [11] C. Bambi and D. Stojkovic. Astrophysical wormholes. *Universe*, 7:136, 2021.
- [12] C. Bär, N. Ginoux, and F. Pfäffle. Wave equations on lorentzian manifolds and quantization. *ESI Lectures in Mathematics and Physics*, 202 pp, 2007.
- [13] J. A. Barceló, D. Faraco, A. Ruiz, and A. Vargas. Reconstruction of singularities from full scattering data by new estimates of bilinear fourier multipliers. *Math. Ann.*, 346(3):505–544, 2010.
- [14] D. Baskin and A. Sá Barreto. Radiation fields for semilinear wave equations. *Trans. Amer. Math. Soc.*, 367(6):3873–3900, 2015.
- [15] D. Baskin, A. Vasy, and J. Wunsch. Asymptotics of scalar waves on long-range asymptotically Minkowski spaces. *Adv. Math.*, 328:160–216, 2018.
- [16] D. Baskin and F. Wang. Radiation fields on Schwarzschild spacetime. *Comm. Math. Phys.*, 331(2):477–506, 2014.
- [17] Y. Berezanskii. The uniqueness theorem in the inverse problem of spectral analysis for the schrödinger equation. *Trudy Moskov Mat. Obs.*, 7:1–62, 1958.
- [18] A. Bernal and M. Sanchez. Smoothness of time functions and the metric splitting of globally hyperbolic spacetimes. *Comm. Math. Phys.*, 257:43–50, 2005.
- [19] A. Bernal and M. Sanchez. Globally hyperbolic spacetimes can be defined as “causal” instead of “strongly causal”. *Class. Quant. Grav.*, 24:745–750, 2007.
- [20] F. Beyer, J. Frauendiener, and J. Hennig. Explorations of the infinite regions of spacetime. *Int. J. Mod. Phys. D*, 29, 2020. Article 2030007.
- [21] F. Cakoni and D. Colton. *Qualitative methods in inverse scattering theory. An introduction*. Springer, viii+277 pp, 2006.
- [22] F. Cakoni and D. Colton. *A qualitative approach to inverse scattering theory*. Applied Mathematical Sciences, 188. Springer, New York, x+297 pp, 2014.
- [23] F. Cakoni, D. Colton, and H. Haddar. Inverse scattering theory and transmission eigenvalues. pages x+193 pp. SIAM, 2016.
- [24] C. I. Carstea, A. Feizmohammadi, Y. Kian, K. Krupchyk, and G. Uhlmann. The calderón inverse problem for isotropic quasilinear conductivities. *Adv. Math.*, 391, 2021. Paper No. 107956, 31 pp.
- [25] C. Cattoën and M. Visser. Cosmodynamics: energy conditions, Hubble bounds, density bounds, time and distance bounds. *Classical Quantum Gravity*, 25(16):165013, 19, 2008.
- [26] I. Chavel. *Riemannian Geometry: A Modern Introduction*. Cambridge University Press, Cambridge Studies in Advanced Mathematics, 2nd edition, 2006.
- [27] X. Chen, M. Lassas, L. Oksanen, and G. Paternain. Inverse problem for the yang-mills equations. *Commun. Math. Phys.*, 384(2):1187–1225, 2021.

- [28] X. Chen, M. Lassas, L. Oksanen, and G. Paternain. Detection of Hermitian connections in wave equations with cubic non-linearity. *J. Eur. Math. Soc. (JEMS)*, 24(7):2191–2232, 2022.
- [29] Y. Choquet-Bruhat. *General relativity and the Einstein equations*. Oxford Univ. Press, xxvi+785 pp, 2009.
- [30] P. T. Chruściel and E. Delay. Existence of non-trivial, vacuum, asymptotically simple spacetimes. *Classical Quantum Gravity*, 19(9):L71–L79, 2002.
- [31] J. Corvino and R. M. Schoen. On the asymptotics for the vacuum Einstein constraint equations. *J. Differential Geom.*, 73(2):185–217, 2006.
- [32] T. Daudé, N. Kamran, and F. Nicoleau. Non-uniqueness results for the anisotropic Calderón problem with data measured on disjoint sets. *Ann. Inst. Fourier (Grenoble)*, 69(1):119–170, 2019.
- [33] M. de Hoop, G. Uhlmann, and Y. Wang. Nonlinear interaction of waves in elastodynamics and an inverse problem. *Math. Ann.*, 376(1-2):765–795, 2020.
- [34] M. V. de Hoop, G. Uhlmann, and A. Vasy. Recovery of material parameters in transversely isotropic media. *Arch. Ration. Mech. Anal.*, 235(1):141–165, 2020.
- [35] J. Duistermaat. *Fourier Integral Operators*. Birkhäuser, 1996.
- [36] N. Eptaminitakis and P. Stefanov. Weakly nonlinear geometric optics for the Westervelt equation and recovery of the nonlinearity. *SIAM J. Math. Anal.*, 56(1):801–819, 2024.
- [37] G. Eskin. Inverse problems for general second order hyperbolic equations with time-dependent coefficients. *Bull. Math. Sci.*, 7(2):247–307, 2017.
- [38] A. Feizmohammadi, Y. Kian, and G. Uhlmann. An inverse problem for a quasilinear convection–diffusion equation. *Nonl. Anal.*, 222, 2022.
- [39] A. Feizmohammadi, M. Lassas, and L. Oksanen. Inverse problems for non-linear hyperbolic equations with disjoint sources and receivers. *Forum math. Pi*, 10:52, 2021.
- [40] A. Feizmohammadi and L. Oksanen. An inverse problem for a semi-linear elliptic equation in riemannian geometries. *J. Diff. Eq.*, 269(6):4683–4719, 2020.
- [41] D. D. S. Ferreira, C. Kenig, M. Salo, and G. Uhlmann. Limiting Carleman weights and anisotropic inverse problems. *Inventiones mathematicae*, 178(1):119–171, 2009.
- [42] F. Galarce, D. Lombardi, and O. Mula. Reconstructing haemodynamics quantities of interest from Doppler ultrasound imaging. *Int. J. Numer. Methods Biomed. Eng.*, 37(2):Paper No. e3416, 34, 2021.
- [43] R. Garattini and F. Lobo. Self-sustained traversable wormholes in noncommutative geometry. *Physics Letters B*, 671:146–152, 2009.
- [44] R. Geroch. Domain of dependence. *J. Math. Phys.*, 11:437–449, 1970.
- [45] A. Greenleaf and G. Uhlmann. Recovering singularities of a potential from singularities of scattering data. *Comm. Math. Phys.*, 157(3):549–572, 1993.
- [46] C. Guillarmou, M. Salo, and L. Tzou. Inverse scattering at fixed energy on surfaces with Euclidean ends. *Comm. Math. Phys.*, 303(3):761–784, 2011.
- [47] C. Guillarmou and L. Tzou. Calderón inverse problem with partial data on Riemann surfaces. *Duke Mathematical Journal*, 158(1):83–120, 2011.
- [48] V. Guillemin and G. Uhlmann. Oscillatory integrals with singular symbols. *Duke Math. J.*, 48:251–267, 1981.
- [49] J. Haláček and T. Ledvinka. Analytical conformal compactification of schwarzschild spacetime. *Relativity and Gravitation. Springer*, 157, 2014.
- [50] A. Hassell, R. Melrose, and A. Vasy. Spectral and scattering theory for symbolic potentials of order zero. *Adv. Math.*, 181(1):1–87, 2004.
- [51] A. Hassell, R. Melrose, and A. Vasy. Microlocal propagation near radial points and scattering for symbolic potentials of order zero. *Anal. PDE*, 1(2):127–196, 2008.
- [52] P. Hintz. Black hole gluing in de Sitter space. *Commun. Partial Differ. Equ.*, 46(7):1280–1318, 2021.
- [53] P. Hintz, A. S. Barreto, G. Uhlmann, and Y. Zhang. Inverse nonlinear scattering by a metric, 2024.
- [54] P. Hintz and A. Vasy. Asymptotics for the wave equation on differential forms on Kerr-de Sitter space. *J. Differential Geom.*, 110(2):221–279, 2018.

- [55] R. Hora and A. Sá Barreto. Inverse scattering with partial data on asymptotically hyperbolic manifolds. *Anal. PDE*, 8(3):513–559, 2015.
- [56] R. Hora and A. Sá Barreto. Inverse scattering with disjoint source and observation sets on asymptotically hyperbolic manifolds. *Comm. Partial Differential Equations*, 43(9):1363–1376, 2018.
- [57] L. Hörmander. *The analysis of linear partial differential operators I*. Springer-Verlag, viii+525 pp, 1985.
- [58] L. Hörmander. *The analysis of linear partial differential operators IV*. Springer-Verlag, vii+352 pp, 1985.
- [59] L. Hörmander. A remark on the characteristic cauchy problem. *J. Funct. Anal.*, 93:270–277, 1990.
- [60] T. Hughes, T. Kato, and J. Marsden. Well-posed quasi-linear second-order hyperbolic systems with applications to nonlinear elastodynamics and general relativity. *Arch. Rational Mech. Anal.*, 63:273–294, 1976.
- [61] H. Isozaki. *Many-body Schrödinger equation—scattering theory and eigenfunction expansions*. Mathematical Physics Studies. Springer, Singapore, 2023.
- [62] M. S. Joshi and A. Sá Barreto. Recovering asymptotics of metrics from fixed energy scattering data. *Invent. Math.*, 137(1):127–143, 1999.
- [63] M. S. Joshi and A. Sá Barreto. Inverse scattering on asymptotically hyperbolic manifolds. *Acta Math.*, 184(1):41–86, 2000.
- [64] J. Joudioux. Conformal scattering for a nonlinear wave equation. *J. Hyperbolic Differ. Equ.*, 9(1):1–65, 2012.
- [65] J. Joudioux. Hörmander’s method for the characteristic Cauchy problem and conformal scattering for a nonlinear wave equation. *Lett. Math. Phys.*, 110:1391, 2020.
- [66] T. Kato. Quasi-linear equations of evolution, with applications to partial differential equations. In L. N. in, editor, *Spectral theory and differential equations*, pages 25–70. Math, Vol. 448, Springer, 1975.
- [67] C. Kenig and M. Salo. The Calderón problem with partial data on manifolds and applications. *Analysis & PDE*, 6(8):2003–2048, 2014.
- [68] C. Kenig and M. Salo. Recent progress in the Calderón problem with partial data. *Contemp. Math*, 615:193–222, 2014.
- [69] W. H. Kinney. Cosmology, inflation and the physics of nothing. In H. B. Prosper and M. Danilov, editors, *Techniques and Concepts of High-Energy Physics XII*, pages 189–243, Dordrecht, 2003. Springer Netherlands.
- [70] K. Krupchyk and G. Uhlmann. Partial data inverse problems for semilinear elliptic equations with gradient nonlinearities. *Math. Res. Lett.*, 27(6):1801–1824, 2020.
- [71] K. Krupchyk and G. Uhlmann. A remark on partial data inverse problems for semilinear elliptic equations. *Proc. Amer. Math. Soc.*, 148(2):681–685, 2020.
- [72] K. Krupchyk and G. Uhlmann. Inverse problems for nonlinear magnetic Schrödinger equations on conformally transversally anisotropic manifolds. *Anal. PDE*, 16(8):1825–1868, 2023.
- [73] K. Krupchyk, G. Uhlmann, and L. Yan. A remark on inverse problems for nonlinear magnetic Schrödinger equations on complex manifolds. *Proc. Amer. Math. Soc.*, 152(6):2413–2422, 2024.
- [74] Y. Kurylev, M. Lassas, L. Oksanen, and G. Uhlmann. Inverse problem for Einstein-scalar field equations. *Duke Math. J.*, 171(16):3215–3282, 2022.
- [75] Y. Kurylev, M. Lassas, and G. Uhlmann. Inverse problems for Lorentzian manifolds and non-linear hyperbolic equations. *Invent. Math.*, 212(3):781–857, 2018.
- [76] R.-Y. Lai, G. Uhlmann, and Y. Yang. Reconstruction of the collision kernel in the nonlinear boltzmann equation. *SIAM J. Math. Anal.*, 53(1):1049–1069, 2021.
- [77] R.-Y. Lai, G. Uhlmann, and Y. Yang. Reconstruction of the collision kernel in the nonlinear Boltzmann equation. *SIAM J. Math. Anal.*, 53(1):1049–1069, 2021.
- [78] R.-Y. Lai and T. Zhou. Partial data inverse problems for nonlinear magnetic Schrödinger equations. *Math. Res. Lett.*, 30(5):1535–1563, 2023.
- [79] M. Lassas. Inverse problems for linear and non-linear hyperbolic equations. In *Proceedings of International Congress of Mathematicians ICM 2018, Vol III*, pages 3739–3760, Rio de Janeiro, Brazil., 2018.

- [80] M. Lassas, T. Liimatainen, Y.-H. Lin, and M. Salo. Inverse problems for elliptic equations with power type nonlinearities. *J. Math. Pures Appl.*, 145:44, 2021.
- [81] M. Lassas, T. Liimatainen, L. Potenciano-Machado, and T. Tyni. Uniqueness, reconstruction and stability for an inverse problem of a semi-linear wave equation. *J. Diff. Eq.*, 337:395–435, 2022.
- [82] M. Lassas, T. Liimatainen, L. Potenciano-Machado, and T. Tyni. Stability and lorentzian geometry for an inverse problem of a semi-linear wave equation. *Anal. PDE.*, 2024. (in print).
- [83] M. Lassas, G. Uhlmann, and Y. Wang. Inverse problems for semilinear wave equations on lorentzian manifolds. *Comm. Math. Phys.*, 360:555–609, 2018.
- [84] P. Lax. *Hyperbolic Partial Differential Equations*. Courant lecture notes, AMS, 2006.
- [85] P. Lax and R. Phillips. *Scattering theory*, volume 26 of *Pure and Applied Mathematics*. Academic Press, second edition, 1989.
- [86] T. Liimatainen and L. Oksanen. Counterexamples to inverse problems for the wave equation. *Inverse Probl. Imaging*, 16(2):467–479, 2022.
- [87] R. Melrose. *Geometric scattering theory*. Stanford Lectures. Cambridge University Press, Cambridge, 1995.
- [88] R. Melrose and G. Uhlmann. Lagrangian intersection and the cauchy problem. *Comm. Pure Appl. Math.*, 32:483–519, 1979.
- [89] R. Melrose and M. Zworski. Scattering metrics and geodesic flow at infinity. *Invent. Math.*, 124(1-3):389–436, 1996.
- [90] R. B. Melrose. *Geometric scattering theory*. Stanford Lectures. Cambridge University Press, Cambridge, xii+116 pp, 1995.
- [91] M. S. Morris and K. S. Thorne. Wormholes in spacetime and their use for interstellar travel. *Am. J. Phys.*, 56:395, 1988.
- [92] T. Muller. Exact geometric optics in a morris-thorne wormhole spacetime. *Physical review D*, 20:044043, 2008.
- [93] G. Nakamura, M. Vashisth, and M. Watanabe. Inverse initial boundary value problem for a non-linear hyperbolic partial differential equation. *Inverse Problems*, 37(1), 2021. Paper No. 015012, 27 pp.
- [94] J.-P. Nicolas. On Lars Hörmanders remark on the characteristic cauchy problem. *Ann. de l’Institut Fourier, Tome*, 56(3):517–543, 2006.
- [95] R. G. Novikov. A multidimensional inverse spectral problem for the equation $-\Delta\psi + (v(x) - Eu(x))\psi = 0$. *Funktsional. Anal. i Prilozhen.*, 22(4):11–22, 96, 1988.
- [96] R. G. Novikov. The inverse scattering problem at fixed energy for the three-dimensional Schrödinger equation with an exponentially decreasing potential. *Comm. Math. Phys.*, 161(3):569–595, 1994.
- [97] L. Oksanen, M. Salo, P. Stefanov, and G. Uhlmann. Inverse problems for real principal type operators. *Amer. J. Math.*, 146(1):161–240, 2024.
- [98] B. O’Neill. *Semi-Riemannian geometry*. With applications to relativity. Pure and Applied Mathematics, 103. Academic Press, Inc., xiii+468 pp, 1983.
- [99] R. Penrose. Republication of: Conformal treatment of infinity. *Gen. Relativity Gravitation*, 43(3):901–922, 2011.
- [100] V. Petkov. *Scattering Theory for Hyperbolic Operators*. North Holland, 1989.
- [101] H. Ringström. *The Cauchy Problem in General Relativity*. EMS, 2009.
- [102] A. Sá Barreto, G. Uhlmann, and Y. Wang. Inverse scattering for critical semilinear wave equations. *Pure Appl. Anal.*, 4(2):191–223, 2022.
- [103] A. Sá Barreto and Y. Wang. The scattering operator on asymptotically hyperbolic manifolds. *J. Spectr. Theory*, 9(1):269–313, 2019.
- [104] A. Sá Barreto and Y. Wang. Singularities generated by the triple interaction of semilinear conormal waves. *Anal. PDE*, 14(2021):1315–1367, 2020.
- [105] R. Sachs and H. Wu. *General relativity for mathematicians*. Graduate Texts in Mathematics, Vol. 48. Springer-Verlag, New York-Heidelberg, 1977.
- [106] M. Salo and X. Zhong. An inverse problem for the p-Laplacian: boundary determination. *SIAM journal on mathematical analysis*, 44(4):2474–2495, 2012.
- [107] B. G. Schmidt. A new definition of conformal and projective infinity of space-times. *Comm. Math. Phys.*, 36:73–90, 1974.

- [108] P. Stefanov. Inverse scattering problem for the wave equation with time-dependent potential. *J. Math. Anal. Appl.*, 140(2):351–362, 1989.
- [109] P. Stefanov. Uniqueness of the multi-dimensional inverse scattering problem for time dependent potentials. *Math. Z.*, 201:541–559, 1989.
- [110] P. Stefanov, G. Uhlmann, and A. Vasy. Boundary rigidity with partial data. *J. Amer. Math. Soc.*, 29(2):299–332, 2016.
- [111] P. Stefanov, G. Uhlmann, and A. Vasy. The transmission problem in linear isotropic elasticity. *Pure Appl. Anal.*, 3(1):109–161, 2021.
- [112] Z. Sun and G. Uhlmann. Inverse problems in quasilinear anisotropic media. *American Journal of Mathematics*, 119(4):771–797, 1997.
- [113] J. Sylvester and G. Uhlmann. A global uniqueness theorem for an inverse boundary value problem. *Annals of mathematics*, pages 153–169, 1987.
- [114] D. Tataru. Unique continuation for solutions to PDE’s; between Hörmander’s theorem and Holmgren’s theorem. *Comm. PDE*, 20:855–884, 1995.
- [115] G. Taujanskas. Conformal scattering of the Maxwell-scalar field system on de Sitter space. *J. Hyperbolic Differ. Equ.*, 16(4):743–791, 2019.
- [116] G. Uhlmann. Electrical impedance tomography and Calderón’s problem. *Inverse problems*, 25(12):123011, 2009.
- [117] G. Uhlmann and J. Zhai. Inverse problems for nonlinear hyperbolic equations. *Discrete Contin. Dyn. Syst.*, 41(1):455–469, 2021.
- [118] G. Uhlmann and J. Zhai. On an inverse boundary value problem for a nonlinear elastic wave equation. *J. Math. Pures Appl.*, 153(2021):1049–1069, 2021.
- [119] G. Uhlmann and Y. Zhang. An inverse boundary value problem arising in nonlinear acoustics. *SIAM J. Math. Anal.*, 55(2):1364–1404, 2023.
- [120] A. Vasy. Diffraction by edges. *Modern Phys. Lett. B*, 22:2287–2328, 2008.
- [121] A. Vasy. Propagation of singularities for the wave equation on manifolds with corners. *Ann. of Math.*, (2) 168:749–812, 2008.
- [122] A. Vasy. Microlocal analysis of asymptotically hyperbolic and kerr-de sitter spaces (with an appendix by s. dyatlov). *Invent. Math.*, 194:381–513, 2013.
- [123] A. Vasy. Resolvents, Poisson operators and scattering matrices on asymptotically hyperbolic and de Sitter spaces. *J. Spectr. Theory*, 4(4):643–673, 2014.
- [124] C. Villani. Synthetic theory of Ricci curvature bounds. *Jpn. J. Math.*, 11(2):219–263, 2016.
- [125] M. Visser. *Lorentzian Wormholes: From Einstein to Hawking*. American Institute of Physics, 1996.
- [126] R. Wald. *General Relativity*. University of Chicago Press, Chicago, 1984.
- [127] Y. Wang and T. Zhou. Inverse problems for quadratic derivative nonlinear wave equations. *Comm. Partial Differential Equations*, 44(11):1140–1158, 2019.
- [128] Y. Wang and T. Zhou. Inverse problems for quadratic derivative nonlinear wave equations. *Comm. Partial Differential Equations*, 44(11):1140–1158, 2019.
- [129] D. Willett and J. S. W. Wong. On the discrete analogues of some generalizations of Gronwall’s inequality. *Monatsh. Math.*, 69:362–367, 1965.

SPYROS ALEXAKIS, DEPARTMENT OF MATHEMATICS, UNIVERSITY OF TORONTO, CANADA.

HIROSHI ISOZAKI, COLLEGE OF MATHEMATICS, UNIVERSITY OF TSUKUBA, JAPAN.

MATTI LASSAS, DEPARTMENT OF MATHEMATICS AND STATISTICS, UNIVERSITY OF HELSINKI, FINLAND.

TEEMU TYNI, RESEARCH UNIT OF APPLIED AND COMPUTATIONAL MATHEMATICS, UNIVERSITY OF OULU, FINLAND.