

# A collection of integrals, products and series

Robert Reynolds

ABSTRACT. This is a conspectus of definite integrals, products and series. These formulae involve special functions in the integrand and summand functions and closed form solutions. Some of the special cases are stated in terms of fundamental constants.

## 1. Significance statement

Research involving high energy and particle physics that is both computational and theoretical in nature use formulae involving integrals, series, and products. Researchers seeking to model processes involving elements like dark matter, lattice quantum fields, and quantum chromodynamics, even in conjunction with quantum computing, often peruse tables of formulae listing integrals, series, and products to assign equations to these processes. Upon finding equation(s) which fit the model being studied more advanced studies can be performed and a deeper understanding achieved. This work contributes to this research by listing new formulae in easy to navigate tables, to aid researchers.

## 2. Introduction

Tables of integrals, products and series are currently found in well known literature. Books by Bierens de Haan, Fritz Oberhettinger, Eldon Hansen, Gradshteyn and Ryzhik to name a few have an exhaustive listing of these types of formulae. These books are listed in the reference section of this work for interested readers to peruse.

The aim of this work is to add to present literature by providing new definite integrals, products and series involving special functions and fundamental constants. Definite integrals of special functions may have closed-form solutions or require numerical methods for evaluation and have particular uses in mathematical physics or some other branch of mathematics. Products involving special functions often arise in mathematical expressions and are encountered in various branches of mathematics, physics, and engineering. Different special functions have different properties, and their products may exhibit unique characteristics. Series involving

---

2020 *Mathematics Subject Classification*. Primary 30E20, 33-01, 33-03, 33-04.

*Key words and phrases*. Ramanujan, Berndt,  $q$ -Pochhammer symbol, integrals, products, series, special functions, Gauss' multiplication formula.

special functions often involve expressing a function as a series expansion, where an infinite sum of terms contributes to the overall behaviour of the function. Special functions have different series representations, and these representations are useful for various purposes, including solving differential equations, understanding the behaviour of functions, and numerical computations. The plots in this work were rendered using Mathematica software by Wolfram. The formulae in this work were numerically verified using Mathematica by Wolfram.

### 3. Preliminaries

In this work, the methods in [1] and section (7) in [2] are applied to the stated theorems and their special cases are listed as examples that follow. The variables in the theorems are valid along the complex plane unless otherwise stated. The functions appearing in this work are; Hurwitz-Lerch zeta function  $\Phi(z, s, a)$ , given in section (25.14) in [3], the incomplete gamma function  $\Gamma(z, s)$ , given in section (8) in [3], logarithmic function  $\log(z)$ , given in section (4) in [3], Laguerre polynomial  $L_n^a(x)$ , given in section (18) in [3], Euler's polynomial  $E_n(z)$ , given in section (24) in [3], Bessel function of the first kind  $J_n(z)$ , given in section (10) in [3], Kummer confluent hypergeometric function  ${}_1F_1(a, b, c)$ , given in section (13) in [3], the incomplete beta function  $B_x(a, b)$  given in equation (8.17.7) in [3], the Gudermannian function  $\text{gd}(c)$  given in equation (19.10.2) in [3].

### 4. Main Theorems

The theorems in this section have equations and method listed. Absence of a method indicates [1].

#### Theorems involving definite integrals

In this section we tabulate definite integrals involving the logarithmic function, quotient gamma functions, logarithm of quotient trigonometric functions, product of logarithmic functions, logarithmic and rational functions, logarithmic and quotient gamma functions, product of trigonometric and logarithm of trigonometric functions, quotient exponential functions, product of arctangent and rational functions, logarithm of rational functions, product of quotient trigonometric functions and rational functions, generalized product of logarithmic functions, product of Hurwitz-Lerch zeta function and trigonometric functions, product of logarithmic function and arctangent function.

THEOREM 4.1. *From Eq. (3.241.4) in [4].*

$$\begin{aligned}
 (4.1) \quad & \int_0^\infty \frac{x^m \log^k(ax)}{(x^2 + 1)^3} dx \\
 &= \frac{1}{8} \pi^{k-1} e^{\frac{1}{2}i\pi(k+m)} \left( -2i\pi k(m-2) \Phi \left( -e^{im\pi}, 1-k, \log(a) + \frac{1}{2} \right) \right. \\
 & \quad \left. - (k-1)k \Phi \left( -e^{im\pi}, 2-k, \log(a) + \frac{1}{2} \right) \right)
 \end{aligned}$$

$$+\pi^2(m-3)(m-1)\Phi\left(-e^{im\pi}, -k, \log(a) + \frac{1}{2}\right)$$

THEOREM 4.2. *Form Entry (23) in [5]*

$$(4.2) \quad \int_0^\infty \frac{x^{-m}\Gamma(b+x)\log^k\left(\frac{a}{x}\right)}{\Gamma(1+b+n+x)} dx \\ = -\sum_{p=0}^\infty \frac{e^{im\pi}(b+p)^{-m}(2i\pi)^{1+k}\Phi\left(e^{2im\pi}, -k, \frac{\pi-i\log(a)+i\log(b+p)}{2\pi}\right)(-n)_p}{p!\Gamma(1+n)}$$

THEOREM 4.3. *From Eq. (1.9.51) in [6].*

$$(4.3) \quad \int_0^\infty e^{-imx} \left( e^{2imx}(\log(a)+ix)^{k-1} + \frac{m(e^{2imx}(\log(a)+ix)^k + (\log(a)-ix)^k)}{k} \right. \\ \left. + (\log(a)-ix)^{k-1} \log\left(\frac{\cos(\alpha)+\cosh(x)}{\cos(\beta)+\cosh(x)}\right) dx \right) \\ = \frac{(2\pi)^{k+1}}{k} \left( e^{(\pi-\alpha)m}\Phi\left(e^{2m\pi}, -k, \frac{-\alpha+\log(a)+\pi}{2\pi}\right) \right. \\ \left. + e^{(\alpha+\pi)m}\Phi\left(e^{2m\pi}, -k, \frac{\alpha+\log(a)+\pi}{2\pi}\right) \right. \\ \left. - e^{(\pi-\beta)m}\Phi\left(e^{2m\pi}, -k, \frac{-\beta+\log(a)+\pi}{2\pi}\right) \right. \\ \left. + e^{2\beta m}\Phi\left(e^{2m\pi}, -k, \frac{\beta+\log(a)+\pi}{2\pi}\right) \right)$$

THEOREM 4.4. *From Eq. (2.1.5.7) in [7].*

$$(4.4) \quad \int_0^\infty \frac{x^{-1+m}(-1+x^u)\left(\left(-\frac{i\pi}{v}+\log(ax)\right)^k - e^{\frac{2im\pi}{v}}\left(\frac{i\pi}{v}+\log(ax)\right)^k\right)}{-1+x^v} dx \\ = 2^{2+k}e^{\frac{i\pi(2m+u)}{v}}\pi^{1+k}\left(\frac{i}{v}\right)^{2+k}v\Phi\left(e^{\frac{2i\pi(m+u)}{v}}, -k, \frac{\pi-iv\log(a)}{2\pi}\right)\sin\left(\frac{\pi u}{v}\right)$$

THEOREM 4.5. *From Eq. (2.6.15.8) in [8].*

$$(4.5) \quad \int_0^\infty \log\left(\frac{(x+1)(b^2+x)}{(b+x)^2}\right)\log^k(ax)\frac{dx}{x} \\ = \frac{2^{k+3}(i\pi)^{k+2}\zeta\left(-k-1, \frac{-i\log(a)-i\log(b)+\pi}{2\pi}\right)}{k+1} \\ - \frac{(2i\pi)^{k+2}\zeta\left(-k-1, \frac{-i\log(a)-2i\log(b)+\pi}{2\pi}\right)}{k+1} \\ - \frac{(2i\pi)^{k+2}\zeta\left(-k-1, \frac{\pi-i\log(a)}{2\pi}\right)}{k+1}$$

THEOREM 4.6. *From Entry 9, in Table 292 on page 419 in [9].*

$$(4.6) \quad \int_0^{\pi/4} \frac{\csc(2x) \left( \cot^m(x) \log(\tan(x)) \log^k(a \cot(x)) + \tan^m(x) \log(\cot(x)) \log^k(a \tan(x)) \right)}{\log(\cot(x)) (\cot^p(x) - \tan^p(x))} dx$$

$$= \frac{i\pi^{k+1} \left(\frac{i}{p}\right)^k e^{\frac{i\pi m}{p}} \Phi\left(-e^{\frac{i\pi m}{p}}, -k, 1 - \frac{ip \log(a)}{\pi}\right)}{2p} - \frac{i\pi \log^k(a)}{4p}$$

THEOREM 4.7. *From Eq. (2.2.7.3) in [8].*

$$(4.7) \quad \int_{-\alpha}^{\alpha} \frac{\left(\frac{\alpha+x}{\alpha-x}\right)^m \log^k\left(\frac{\alpha(\alpha+x)}{\alpha-x}\right)}{\alpha^2 + x^2} dx = \frac{\pi^{k+1} e^{\frac{1}{2}i\pi(k+m)} \Phi\left(-e^{im\pi}, -k, \frac{1}{2} - \frac{i \log(a)}{\pi}\right)}{\alpha}$$

THEOREM 4.8. *From Eq. (3.414.31) in [4].*

$$(4.8) \quad \int_0^{\infty} \frac{e^{x(p-m)} (\log(a) - x)^k - e^{mx} (\log(a) + x)^k}{e^{px} - 1} dx$$

$$= -\frac{i\pi \left( \log^k(a) + 2^{k+1} \pi^k \left(\frac{i}{p}\right)^k e^{\frac{2i\pi m}{p}} \Phi\left(e^{\frac{2i\pi m}{p}}, -k, 1 - \frac{ip \log(a)}{2\pi}\right) \right)}{p}$$

THEOREM 4.9. *From Eq. (2.6.8.9) in [8].*

$$(4.9) \quad \int_0^{\infty} \frac{x^{m-1} \log^k(\alpha x)}{a^2 + 2ax \cos(\varphi) + x^2} dx$$

$$= (2i)^k \pi^{k+1} a^{m-2} e^{i(m(\pi-\varphi)+\varphi)} \csc(\varphi) \left( e^{2i(m-1)\varphi} \Phi\left(e^{2im\pi}, -k, \frac{\varphi - i \log(a) - i \log(\alpha) + \pi}{2\pi}\right) \right.$$

$$\left. - \Phi\left(e^{2im\pi}, -k, -\frac{\varphi + i \log(a) + i \log(\alpha) - \pi}{2\pi}\right) \right)$$

THEOREM 4.10. *Schröder's integral and Gregory coefficients [10]. From Eq. (3.251.11) in [4].*

$$(4.10) \quad \int_0^{\infty} \frac{x^t \log^k(ax)}{(bx+1)^m} dx$$

$$= -k! \sum_{p=0}^{m-1} \left( \sum_{z=0}^p \frac{(2i\pi)^{k-z+1} (-1)^{2m+p+1} S_p^{(z)}(-t)_{m-p-1} \Phi\left(e^{2i\pi t}, z-k, \frac{-i \log(a) + i \log(b) + \pi}{2\pi}\right)}{e^{-i\pi t} b^{t+1} p! (k-z)! \Gamma(m-p)} \right)$$

THEOREM 4.11. *From Eq. (3.195) in [4].*

$$(4.11) \quad \int_0^{\infty} \frac{\left(\frac{x+1}{b+x}\right)^m \log^k\left(\frac{a(x+1)}{b+x}\right)}{(x+1)(b+x)} dx$$

$$= \frac{a^{-m} (-m)^{-k}}{(b-1)m} (\Gamma(k+1, -m \log(a)) - \Gamma(k+1, m(\log(b) - \log(a))))$$



THEOREM 4.12. *From Eq. (1.7.7.122) in [11].*

$$\begin{aligned}
(4.12) \quad & \int_0^\infty e^{-imx} \left( e^{2imx} (\log(a) + ix)^{k-1} + \frac{m (e^{2imx} (\log(a) + ix)^k + (\log(a) - ix)^k)}{k} \right. \\
& \quad \left. + (\log(a) - ix)^{k-1} \right) \tan^{-1}(\sinh(\alpha) \operatorname{sech}(bx)) dx \\
& = \frac{i\pi^{k+1}}{k} \left( \frac{1}{b} \right)^k e^{\frac{(\pi-2i\alpha)m}{2b}} \left( \Phi \left( -e^{\frac{m\pi}{b}}, -k, \frac{-2i\alpha + 2b \log(a) + \pi}{2\pi} \right) \right. \\
& \quad \left. - e^{\frac{2i\alpha m}{b}} \Phi \left( -e^{\frac{m\pi}{b}}, -k, \frac{2i\alpha + 2b \log(a) + \pi}{2\pi} \right) \right)
\end{aligned}$$

THEOREM 4.13. *From Eq. (2.1.16) in [7].*

$$\begin{aligned}
(4.13) \quad & \int_0^\infty \frac{x^{-m-\frac{1}{2}} \left( \beta + \sqrt{x(2\beta+x)} + x \right)^{-m} \log^k \left( \frac{a}{x(\beta + \sqrt{x(2\beta+x)} + x)} \right)}{\sqrt{2\beta+x}} dx \\
& = -i\pi^{k+1} 2^{2k+m+1} e^{\frac{1}{2}i\pi(k+4m)} \beta^{-2m} \\
& \quad \Phi \left( e^{4im\pi}, -k, \frac{-i \log(2a) + 2i \log(\beta) + 2\pi}{4\pi} \right)
\end{aligned}$$

THEOREM 4.14. *From Eq. (2.4.4.10(ii)) in [8].*

$$\begin{aligned}
(4.14) \quad & \int_0^\infty \frac{\cosh(cu)}{\cosh(bu)} \left( (-u + \log(a))^k + e^{2mu} (u + \log(a))^k \right) \frac{du}{e^{mu}} \\
& = \frac{2^{-1-k} \left( \frac{i}{b} \right)^{-1+k} \pi^{1+k}}{b^2} \left( 2^{1+k} e^{\frac{i(b-c+m)\pi}{2b}} \Phi \left( e^{\frac{i(b-c+m)\pi}{b}}, -k, \frac{1}{2} - \frac{ib \log(a)}{\pi} \right) \right. \\
& \quad \left. + e^{\frac{i(b+c+m)\pi}{2b}} \left( \Phi \left( -e^{\frac{i(b+c+m)\pi}{2b}}, -k, 1 - \frac{2ib \log(a)}{\pi} \right) + \Phi \left( e^{\frac{i(b+c+m)\pi}{2b}}, -k, 1 - \frac{2ib \log(a)}{\pi} \right) \right) \right)
\end{aligned}$$

THEOREM 4.15. *From Eq. (3.241.4) in [4].*

$$\begin{aligned}
(4.15) \quad & \int_0^\infty \cdots \int_0^\infty \frac{x_1^{m-1}}{x_1^n + 1} \left( \prod_{l=1}^j \frac{x_{l+1}^{2^{l-1}m + \frac{n}{2} - 1}}{x_{l+1}^n + 1} \right) \log^k \left( ax_1 \left( \prod_{l=1}^j x_{l+1}^{2^{l-1}} \right) \right) dx_1 \cdots dx_{j+1} \\
& = -i(2\pi)^{j+k+1} n^{-j-1} \left( \frac{i2^j}{n} \right)^k e^{\frac{i\pi 2^j m}{n}} \Phi \left( e^{\frac{i2^{j+1}m\pi}{n}}, -k, \frac{\pi - i2^{-j}n \log(a)}{2\pi} \right)
\end{aligned}$$

THEOREM 4.16. *From Eq. (2.4.6.11) in [8].*

$$\begin{aligned}
(4.16) \quad & \int_0^\infty \frac{e^{-mx} \left( (-x + \log(a))^k + e^{2mx} (x + \log(a))^k \right)}{(\cos(t) + \cosh(cx))^2} dx \\
& = \frac{\left( 2c^{-2-k} e^{\frac{im(\pi-t)}{c}} (2i\pi)^k \right)}{-1 + \cos(2t)} \left( ck\Phi \left( e^{\frac{2im\pi}{c}}, 1-k, \frac{\pi-t-ic \log(a)}{2\pi} \right) \right)
\end{aligned}$$

$$\begin{aligned}
& +ce^{\frac{2imt}{c}} k\Phi\left(e^{\frac{2im\pi}{c}}, 1-k, \frac{\pi+t-ic\log(a)}{2\pi}\right) \\
& +2\pi(im+c\cot(t))\Phi\left(e^{\frac{2im\pi}{c}}, -k, \frac{\pi-t-ic\log(a)}{2\pi}\right) \\
& +2ie^{\frac{2imt}{c}} \pi(m+ic\cot(t))\Phi\left(e^{\frac{2im\pi}{c}}, -k, \frac{\pi+t-ic\log(a)}{2\pi}\right)
\end{aligned}$$

THEOREM 4.17. *From Eq. (1.7.7.20) in [11].*

$$\begin{aligned}
(4.17) \quad & \int_0^\infty \frac{e^{-mx}((-x+a)^k + e^{2mx}(x+a)^k) \sinh(bx)}{\sinh(c\pi x)} dx \\
& = \left(\frac{i}{c}\right)^{1+k} \left( e^{\frac{i(-b+m)}{c}} \Phi\left(-e^{\frac{i(-b+m)}{c}}, -k, 1-ica\right) - e^{\frac{i(b+m)}{c}} \Phi\left(-e^{\frac{i(b+m)}{c}}, -k, 1-ica\right) \right)
\end{aligned}$$

THEOREM 4.18. *From Eq. (1.7.7.1) in [11]*

$$\begin{aligned}
(4.18) \quad & \int_0^\infty (e^{-mx}(-x+\log(a))^k + e^{mx}(x+\log(a))^k) \operatorname{sech}(bx) dx \\
& = \frac{2\left(\left(\frac{i}{b}\right)^k e^{\frac{im\pi}{2b}} \pi^{1+k} \Phi\left(-e^{\frac{im\pi}{b}}, -k, \frac{1}{2} - \frac{ib\log(a)}{\pi}\right)\right)}{b}
\end{aligned}$$

THEOREM 4.19. *From Eq. (1.7.7.2) in [11].*

$$\begin{aligned}
(4.19) \quad & \int_0^\infty e^{-mx}((-x+\log(a))^k + e^{2mx}(x+\log(a))^k) \operatorname{sech}^2(bx) dx \\
& = -\frac{2\left(\frac{i}{b}\right)^k e^{\frac{im\pi}{2b}} \pi^k \left( bk\Phi\left(e^{\frac{im\pi}{b}}, 1-k, \frac{1}{2} - \frac{ib\log(a)}{\pi}\right) + im\pi\Phi\left(e^{\frac{im\pi}{b}}, -k, \frac{1}{2} - \frac{ib\log(a)}{\pi}\right) \right)}{b^2}
\end{aligned}$$

THEOREM 4.20. *From Eq. (3.511.9) in [4].*

$$\begin{aligned}
(4.20) \quad & \int_0^\infty \operatorname{csch}^2(bx) \left( -2\log^k(a) + e^{-2mx}(-2x+\log(a))^k + e^{2mx}(2x+\log(a))^k \right) dx \\
& = \frac{2}{b^2 \log(a)} \left( \left(\frac{i}{b}\right)^k e^{\frac{2im\pi}{b}} (2\pi)^k \left( bk\Phi\left(e^{\frac{2im\pi}{b}}, 1-k, 1 - \frac{ib\log(a)}{2\pi}\right) \right. \right. \\
& \left. \left. + 2im\pi\Phi\left(e^{\frac{2im\pi}{b}}, -k, 1 - \frac{ib\log(a)}{2\pi}\right) \right) \log(a) + \log^k(a)(ik\pi + (b+im\pi)\log(a)) \right)
\end{aligned}$$

THEOREM 4.21. *From Eq. (2.4.6.14) in [8].*

$$\begin{aligned}
(4.21) \quad & \int_0^\infty \frac{e^{-mx}((-x+\log(a))^k - e^{2mx}(x+\log(a))^k) \sinh(bx)}{\cos(t) + \cosh(cx)} dx \\
& = \frac{\left( ie^{-\frac{2i(b(\pi+t)+m(2\pi+t))}{c}} \pi \csc\left(\frac{2b\pi}{c}\right) \csc(t) \right)}{2c} \\
& \left( \left(\frac{i}{c}\right)^k \left( e^{\frac{3i(b+m)(\pi+t)}{c}} - e^{\frac{i(3m(\pi+t)+b(5\pi+t))}{c}} \right) (2\pi)^k \Phi\left(e^{\frac{2i(b-m)\pi}{c}}, -k, \frac{\pi-t+ic\log(a)}{2\pi}\right) \right)
\end{aligned}$$

$$\begin{aligned}
& - \left( -\frac{i}{c} \right)^k e^{\frac{i(b(3\pi+t)+m(\pi+3t))}{c}} \left( -1 + e^{\frac{2ib(\pi+t)}{c}} \right) (2\pi)^k \Phi \left( e^{\frac{2i(b-m)\pi}{c}}, -k, \frac{3\pi - t + ic \log(a)}{2\pi} \right) \\
& - \left( -\frac{i}{c} \right)^k \left( e^{\frac{i(b+m)(3\pi+t)}{c}} - e^{\frac{i(5b\pi+3m\pi+3bt+mt)}{c}} \right) (2\pi)^k \Phi \left( e^{\frac{2i(b-m)\pi}{c}}, -k, \frac{\pi + t + ic \log(a)}{2\pi} \right) \\
& - \left( -\frac{i}{c} \right)^k \left( e^{\frac{i(3b+m)(\pi+t)}{c}} - e^{\frac{i((5b+m)\pi+(b+m)t)}{c}} \right) (2\pi)^k \Phi \left( e^{\frac{2i(b-m)\pi}{c}}, -k, \frac{3\pi + t + ic \log(a)}{2\pi} \right) \\
& + \left( \frac{i}{c} \right)^k \left( e^{\frac{i(b+m)(5\pi+t)}{c}} - e^{\frac{i(3b(\pi+t)+m(5\pi+t))}{c}} \right) (2\pi)^k \Phi \left( e^{\frac{2i(b+m)\pi}{c}}, -k, \frac{\pi - t - ic \log(a)}{2\pi} \right) \\
& - \left( \frac{i}{c} \right)^k \left( e^{\frac{i(b+m)(5\pi+3t)}{c}} - e^{\frac{i(3b\pi+5m\pi+bt+3mt)}{c}} \right) (2\pi)^k \Phi \left( e^{\frac{2i(b+m)\pi}{c}}, -k, \frac{\pi + t - ic \log(a)}{2\pi} \right) \\
& + \left( \frac{i}{c} \right)^k e^{\frac{i(3b\pi+7m\pi+3mt)}{c}} \left( e^{\frac{3ibt}{c}} - e^{\frac{ib(2\pi+t)}{c}} \right) (2\pi)^k \Phi \left( e^{\frac{2i(b+m)\pi}{c}}, -k, \frac{3\pi + t - ic \log(a)}{2\pi} \right) \\
& + \left( \frac{i}{c} \right)^k e^{\frac{i(b(3\pi+t)+m(7\pi+t))}{c}} \left( -1 + e^{\frac{2ib(\pi+t)}{c}} \right) (2\pi)^k \Phi \left( e^{\frac{2i(b+m)\pi}{c}}, -k, -\frac{-3\pi + t + ic \log(a)}{2\pi} \right) \\
& - e^{\frac{3i(b+m)(\pi+t)}{c}} \left( -\frac{i(\pi-t)}{c} + \log(a) \right)^k + e^{\frac{i(b+3m)(\pi+t)}{c}} \left( -\frac{i(\pi-t)}{c} + \log(a) \right)^k \\
& - e^{\frac{i(b(\pi+t)+m(5\pi+t))}{c}} \left( \frac{i(\pi-t)}{c} + \log(a) \right)^k + e^{\frac{i(3b(\pi+t)+m(5\pi+t))}{c}} \left( \frac{i(\pi-t)}{c} + \log(a) \right)^k \\
& + e^{\frac{i(b+m)(3\pi+t)}{c}} \left( -\frac{i(\pi+t)}{c} + \log(a) \right)^k - e^{\frac{i(m(3\pi+t)+b(\pi+3t))}{c}} \left( -\frac{i(\pi+t)}{c} + \log(a) \right)^k \\
& + e^{\frac{i(b\pi+5m\pi+3mt)}{c}} \left( e^{\frac{3ibt}{c}} - e^{\frac{ib(2\pi+t)}{c}} \right) \left( \frac{i(\pi+t)}{c} + \log(a) \right)^k
\end{aligned}$$

THEOREM 4.22. From Eq. (3.984.5) in [4].

$$\begin{aligned}
(4.22) \quad & \int_0^\infty e^{x(m-2i\alpha)} x^{-1+s} \left( -e^{2mx} \Phi \left( -e^{2x(m-i\alpha)}, 1-s, \frac{1}{2} \left( 3 + \frac{a}{x} \right) \right) \right. \\
& + \Phi \left( -e^{2x(m-i\alpha)}, 1-s, \frac{1}{2} \left( \frac{a}{x} + 1 \right) \right) + e^{4ix\alpha} \left( e^{2mx} \Phi \left( -e^{2x(m+i\alpha)}, 1-s, \frac{1}{2} \left( 3 + \frac{a}{x} \right) \right) \right. \\
& \left. \left. - \Phi \left( -e^{2x(m+i\alpha)}, 1-s, \frac{1}{2} \left( \frac{a}{x} + 1 \right) \right) \right) \right) \sec(x\alpha) dx \\
& = \frac{\pi}{2^s e^{a(m+i\alpha)}} \left( \frac{e^{2ia\alpha} \Gamma(s, -a(m-i\alpha))}{(-m+i\alpha)^s} - \frac{\Gamma(s, -a(m+i\alpha))}{(-m-i\alpha)^s} \right)
\end{aligned}$$

THEOREM 4.23. From Eq. (2.2.12.10) in [8].

$$\begin{aligned}
(4.23) \quad & \int_0^1 x^{-m} \left( x^{-1+2m} \alpha^m (\alpha - x\alpha + \beta)^{-m} \log^k \left( \frac{ax\alpha}{\alpha - x\alpha + \beta} \right) \right. \\
& \left. + \beta^{1-m} (\alpha + \beta - x\beta)^{-1+m} \log^k \left( \frac{a(\alpha + \beta - x\beta)}{x\beta} \right) \right) dx \\
& = -e^{im\pi} (2i\pi)^{1+k} \Phi \left( e^{2im\pi}, -k, \frac{\pi - i \log(a)}{2\pi} \right)
\end{aligned}$$

THEOREM 4.24. *From Eq. (1.2.4.90) in [40].*

$$\begin{aligned}
(4.24) \quad & \int_0^\infty e^{-imx} ((-ix + \log(a))^{-2+k} - e^{2imx} (ix + \log(a))^{-2+k} \\
& + \frac{2km}{(-1+k)k} ((-ix + \log(a))^{-1+k} - e^{2imx} (ix + \log(a))^{-1+k}) \\
& + (1+m^2) ((-ix + \log(a))^k - e^{2imx} (ix + \log(a))^k)) \log(1 - e^{-2x}) \sinh(x) dx \\
& = \frac{2a^{-i-m}}{i(-1+k)k} (-a^{2i}(i-m)^{-1-k} \Gamma(1+k, -((-i+m)\log(a))) \\
& \quad - (-i-m)^{-1-k} \Gamma(1+k, -((i+m)\log(a)))) \\
& \quad + \pi \left( -2e^{m\pi} \pi^k \Phi \left( -e^{m\pi}, -k, \frac{\pi + \log(a)}{\pi} \right) + \log^k(a) \right)
\end{aligned}$$

THEOREM 4.25. *From Eq. (2.4.14.9) in [8].*

$$\begin{aligned}
(4.25) \quad & \int_{-\infty}^\infty \frac{e^{-imx} (-ix + \log(a))^k}{\sinh(x) + \sinh(\alpha)} dx \\
& = ie^{-i\alpha} \pi \left( -e^{m\pi} \pi^k \left( \Phi \left( -e^{m\pi}, -k, \frac{\pi - i\alpha + \log(a)}{\pi} \right) + \Phi \left( e^{m\pi}, -k, \frac{\pi - i\alpha + \log(a)}{\pi} \right) \right) \right. \\
& \quad \left. + e^{2im\alpha} \left( \Phi \left( -e^{m\pi}, -k, \frac{\pi + i\alpha + \log(a)}{\pi} \right) - \Phi \left( e^{m\pi}, -k, \frac{\pi + i\alpha + \log(a)}{\pi} \right) \right) \right) \\
& \quad + e^{2im\alpha} (i\alpha + \log(a))^k \operatorname{sech}(\alpha)
\end{aligned}$$

THEOREM 4.26. *From Eq. (2.4.6.27) in [8].*

$$\begin{aligned}
(4.26) \quad & \int_0^\infty \frac{e^{-mx} (-x + \log(a))^k + e^{mx} (x + \log(a))^k}{\cosh^2(cx) + \sinh^2(t)} dx \\
& = \frac{2 \left(\frac{i}{c}\right)^{-1+k} e^{\frac{im(\pi+2it)}{2c}}}{c^2} \pi^{1+k} \operatorname{csch}(2t) \left( e^{\frac{2mt}{c}} \Phi \left( e^{\frac{im\pi}{c}}, -k, \frac{\pi - 2it - 2ic \log(a)}{2\pi} \right) \right. \\
& \quad \left. - \Phi \left( e^{\frac{im\pi}{c}}, -k, \frac{\pi + 2it - 2ic \log(a)}{2\pi} \right) \right)
\end{aligned}$$

THEOREM 4.27. *From Eq. (2.4.6.26) in [8].*

$$\begin{aligned}
(4.27) \quad & \int_0^\infty \frac{\cosh(cx) (e^{-mx} (-x + \log(a))^k + e^{mx} (x + \log(a))^k)}{(1 + \cosh^2(cx))} dx \\
& = \frac{\left(\frac{i}{c}\right)^k e^{\frac{im(\pi+2i \log(1+\sqrt{2}))}{2c}}}{\sqrt{2}c} \pi^{1+k} \left( (1 + \sqrt{2})^{\frac{2m}{c}} \Phi \left( e^{\frac{i(c+m)\pi}{c}}, -k, \frac{\pi - 2i \log(1 + \sqrt{2}) - 2ic \log(a)}{2\pi} \right) \right. \\
& \quad \left. + \Phi \left( e^{\frac{i(c+m)\pi}{c}}, -k, \frac{\pi + 2i \log(1 + \sqrt{2}) - 2ic \log(a)}{2\pi} \right) \right)
\end{aligned}$$

THEOREM 4.28. *From Eq. (2.2.7.12) in [8].*

$$\begin{aligned}
(4.28) \quad & \int_0^\infty \left( \frac{x^{-2m} \log^k \left( \frac{a}{x^2} \right)}{(-1+x)^2} + \frac{x^{2m} \log^k (ax^2)}{(-1+x)^2} - \frac{2 \log^k (a)}{(-1+x)^2} \right) dx \\
& = 2^{3+2(-1+k)} k e^{4im\pi} (i\pi)^k \Phi \left( e^{4im\pi}, 1-k, 1 - \frac{i \log(a)}{4\pi} \right) \\
& \quad + 2^{3+2k} e^{4im\pi} m (i\pi)^{1+k} \Phi \left( e^{4im\pi}, -k, 1 - \frac{i \log(a)}{4\pi} \right) \\
& \quad + 4i\pi k \log^{-1+k}(a) + 4im\pi \log^k(a) + 2 \log^k(a)
\end{aligned}$$

THEOREM 4.29.

$$(4.29) \quad \int_0^\infty \frac{\log^k(ax) \log \left( x^t \left( 1 + \frac{1}{x} \right)_t \right)}{x} dx = \sum_{m=1}^t - \frac{(2i\pi)^{2+k} \zeta \left( -1-k, \frac{\pi - i \log(a) + i \log(m)}{2\pi} \right)}{1+k}$$

THEOREM 4.30. From (4.4.4) in [13].

$$\begin{aligned}
(4.30) \quad & \int_0^\infty \frac{e^{-im\pi} x^{-1+m} \log(x) \left( (-i\pi + \log(ax))^k - e^{2im\pi} (i\pi + \log(ax))^k \right)}{x + \alpha} dx \\
& = -2i\pi \alpha^{-1+m} \left( e^{2im\pi} (2i\pi)^{1+k} \Phi \left( e^{2im\pi}, -k, \frac{2\pi - i \log(a) - i \log(\alpha)}{2\pi} \right) \right. \\
& \quad \left. + (i\pi + \log(\alpha)) (\log(a) + \log(\alpha))^k \right)
\end{aligned}$$

THEOREM 4.31. From Eq.(3.1) in [14].

$$\begin{aligned}
(4.31) \quad & \int_0^\infty \frac{x^{2m+1} \left( \log^k(ax^2) + i^{2m} \log^k(-ax^2) \right)}{\cos(x) + \cosh(x)} dx \\
& = \left( \frac{i}{2} \right)^m \pi^{2(m+1)} \sum_{p=0}^\infty \frac{(-1)^p (1+2p)^{1+2m} \log^k \left( \frac{1}{2} \pi^2 i a (2p+1)^2 \right)}{\cosh \left( \frac{1}{2} (2p+1) \pi \right)}
\end{aligned}$$

THEOREM 4.32. From Eq. (3.2.18) in [6].

$$\begin{aligned}
(4.32) \quad & \int_{-\infty}^\infty \frac{e^{x(2-im-\lambda)} (-ix + \log(a))^k}{(1+e^x\alpha)(1+e^x\beta)} dx \\
& = \frac{i e^{\pi(m-i\lambda)} (2\pi)^{1+k}}{\alpha(\alpha-\beta)\beta} \left( -\alpha^{im+\lambda} \beta \Phi \left( e^{2\pi(m-i\lambda)}, -k, \frac{\pi + \log(a) + i \log(\alpha)}{2\pi} \right) \right. \\
& \quad \left. + \alpha \beta^{im+\lambda} \Phi \left( e^{2\pi(m-i\lambda)}, -k, \frac{\pi + \log(a) + i \log(\beta)}{2\pi} \right) \right)
\end{aligned}$$

THEOREM 4.33. From Eq. (2.6.40.7(a)) in [8]. Extended Winckler form see pp. 359 in [15].

$$\begin{aligned}
(4.33) \quad & \int_0^\infty e^{-imx} \left( (-ix + \log(a))^{-1+k} + e^{2imx} (ix + \log(a))^{-1+k} \right. \\
& \quad \left. + \frac{m \left( (-ix + \log(a))^k + e^{2imx} (ix + \log(a))^k \right)}{k} \right) \log(1 - e^{-x\alpha}) dx
\end{aligned}$$

$$= \frac{a^{-m}(-m)^{-k} \alpha \Gamma(1+k, -m \log(a))}{m} + e^{\frac{2m\pi}{\alpha}} (2\pi)^{1+k} \alpha^{-k} \Phi \left( e^{\frac{2m\pi}{\alpha}}, -k, 1 + \frac{\alpha \log(a)}{2\pi} \right) + \pi \log^k(a)$$

$$= \frac{\hspace{15em}}{k}$$

THEOREM 4.34. *From Eq. (2.6.40.7(b)) in [8]. Extended Winckler form see pp. 359 in [15].*

$$(4.34) \quad \int_0^\infty e^{-imx} \left( k \left( (-ix + \log(a))^{-1+k} + e^{2imx} (ix + \log(a))^{-1+k} \right) \right. \\ \left. + m \left( (-ix + \log(a))^k + e^{2imx} (ix + \log(a))^k \right) \log(1 + e^{-x\alpha}) \right) dx \\ = \frac{a^{-m}(-m)^{-k} \alpha \Gamma(1+k, -m \log(a))}{m} + e^{\frac{m\pi}{\alpha}} (2\pi)^{1+k} \left( \frac{1}{\alpha} \right)^k \Phi \left( e^{\frac{2m\pi}{\alpha}}, -k, \frac{\pi + \alpha \log(a)}{2\pi} \right)$$

THEOREM 4.35. *From Eq. (2.4.4.12) in [8].*

$$(4.35) \quad \int_0^\infty e^{-mx} \left( -(-x + \log(a))^k + e^{2mx} (x + \log(a))^k \right) \operatorname{sech}(cx) \tanh(cx) dx \\ = \frac{2 \left( \frac{i}{c} \right)^k e^{\frac{im\pi}{2c}} \pi^k \left( -ick \Phi \left( -e^{\frac{im\pi}{c}}, 1-k, \frac{1}{2} - \frac{ic \log(a)}{\pi} \right) + m\pi \Phi \left( -e^{\frac{im\pi}{c}}, -k, \frac{1}{2} - \frac{ic \log(a)}{\pi} \right) \right)}{c^2}$$

THEOREM 4.36. *From Eq. (2.5.16.23) in [8].*

$$(4.36) \quad \int_0^\pi e^{-2ix} \cot(x) \left( \Phi \left( e^{-2(m+ix)}, -k, a \right) - e^{4ix} \Phi \left( e^{-2m+2ix}, -k, a \right) \right) dx \\ = -2i\pi \Phi \left( e^{-2m}, -k, a \right)$$

THEOREM 4.37. *From Eq. (1.7.7.107) in [11]*

$$(4.37) \quad \int_0^\infty e^{-imx} \left( (-ix + \log(a))^{-1+k} + e^{2imx} (ix + \log(a))^{-1+k} \right. \\ \left. + \frac{m \left( (-ix + \log(a))^k + e^{2imx} (ix + \log(a))^k \right)}{k} \right) \log \left( \frac{1 + \cosh(cx)}{\cos(b) + \cosh(cx)} \right) dx \\ = \frac{2 \left( \frac{1}{c} \right)^k e^{\frac{m(-b+\pi)}{c}} \pi \left( 2^{1+k} e^{\frac{bm}{c}} \pi^k \Phi \left( e^{\frac{2m\pi}{c}}, -k, \frac{\pi + c \log(a)}{2\pi} \right) \right. \\ \left. - (2\pi)^k \left( \Phi \left( e^{\frac{2m\pi}{c}}, -k, \frac{-b + \pi + c \log(a)}{2\pi} \right) + e^{\frac{2bm}{c}} \Phi \left( e^{\frac{2m\pi}{c}}, -k, \frac{b + \pi + c \log(a)}{2\pi} \right) \right) \right)}{k}$$

THEOREM 4.38. *From Eq. (1.7.7.110) in [11]*

$$(4.38) \quad \int_0^\infty e^{-imx} \left( (-ix + \log(a))^{-1+k} + e^{2imx} (ix + \log(a))^{-1+k} \right. \\ \left. + \frac{m \left( (-ix + \log(a))^k + e^{2imx} (ix + \log(a))^k \right)}{k} \right) \log(1 + \alpha^2 \operatorname{sech}^2(x)) dx \\ = \frac{\left( 2e^{\frac{m\pi}{2}} \pi^{1+k} (\alpha + \sqrt{1 + \alpha^2})^{-im} \right)}{k} \left( \Phi \left( e^{m\pi}, -k, \frac{\pi - 2i \sinh^{-1}(\alpha) + 2 \log(a)}{2\pi} \right) \right)$$

$$\begin{aligned}
& + \left( \alpha + \sqrt{1 + \alpha^2} \right)^{2im} \Phi \left( e^{m\pi}, -k, \frac{\pi + 2i \sinh^{-1}(\alpha) + 2 \log(a)}{2\pi} \right) \\
& \quad - 2 \left( \alpha + \sqrt{1 + \alpha^2} \right)^{im} \Phi \left( e^{m\pi}, -k, \frac{1}{2} + \frac{\log(a)}{\pi} \right)
\end{aligned}$$

THEOREM 4.39. *From Eq. (1.7.7.111) in [11]*

$$\begin{aligned}
(4.39) \quad & \int_0^\infty e^{-imx} \left( (-ix + \log(a))^{-1+k} + e^{2imx} (ix + \log(a))^{-1+k} \right. \\
& \quad \left. + \frac{m \left( (-ix + \log(a))^k + e^{2imx} (ix + \log(a))^k \right)}{k} \right) \log \left( 1 - (\alpha \operatorname{sech}(x))^2 \right) dx \\
& = \frac{\left( 2e^{m \cos^{-1}(\alpha)} \pi^{1+k} \right)}{k} \left( e^{2m \sin^{-1}(\alpha)} \Phi \left( e^{m\pi}, -k, \frac{\pi - \cos^{-1}(\alpha) + \log(a)}{\pi} \right) \right. \\
& \quad \left. + \Phi \left( e^{m\pi}, -k, \frac{\cos^{-1}(\alpha) + \log(a)}{\pi} \right) - 2e^{m \sin^{-1}(\alpha)} \Phi \left( e^{m\pi}, -k, \frac{1}{2} + \frac{\log(a)}{\pi} \right) \right)
\end{aligned}$$

THEOREM 4.40. *From Eq. (2.7.7.76) in [11].*

$$\begin{aligned}
(4.40) \quad & \int_0^\infty e^{-imx} \cot^{-1}(\sinh(bx)) \left( k \left( (-ix + \log(a))^{-1+k} - e^{2imx} (ix + \log(a))^{-1+k} \right) \right. \\
& \quad \left. + m \left( (-ix + \log(a))^k - e^{2imx} (ix + \log(a))^k \right) \right) dx \\
& = -i\pi \left( -2 \left( \frac{1}{b} \right)^k e^{\frac{m\pi}{2b}} \pi^k \Phi \left( -e^{\frac{m\pi}{b}}, -k, \frac{1}{2} + \frac{b \log(a)}{\pi} \right) + \log^k(a) \right)
\end{aligned}$$

THEOREM 4.41. *From Eq. (1.9.68) in [6].*

$$\begin{aligned}
(4.41) \quad & \int_0^\infty e^{-imx} \cot^{-1}(e^{2x}) \left( (-ix + \log(a))^{-2+k} + e^{2imx} (ix + \log(a))^{-2+k} \right. \\
& \quad \left. + \frac{2km}{(-1+k)k} \left( (-ix + \log(a))^{-1+k} + e^{2imx} (ix + \log(a))^{-1+k} \right) \right. \\
& \quad \left. + (1+m^2) \left( (-ix + \log(a))^k + e^{2imx} (ix + \log(a))^k \right) \right) \sinh(x) dx \\
& = \frac{1}{2(-1+k)k} \left( -\sqrt{2} e^{\frac{m\pi}{4}} k \pi^k \Phi \left( -e^{m\pi}, 1-k, \frac{1}{4} + \frac{\log(a)}{\pi} \right) \right. \\
& \quad \left. + \sqrt{2} e^{\frac{3m\pi}{4}} k \pi^k \Phi \left( -e^{m\pi}, 1-k, \frac{3}{4} + \frac{\log(a)}{\pi} \right) \right. \\
& \quad \left. + \pi \left( \sqrt{2} e^{\frac{m\pi}{4}} \pi^k \left( - \left( (-1+m) \Phi \left( -e^{m\pi}, -k, \frac{1}{4} + \frac{\log(a)}{\pi} \right) \right) \right. \right. \right. \\
& \quad \quad \left. \left. + e^{\frac{m\pi}{2}} (1+m) \Phi \left( -e^{m\pi}, -k, \frac{3}{4} + \frac{\log(a)}{\pi} \right) \right) - \log^k(a) \right) \right)
\end{aligned}$$

THEOREM 4.42. *From Eq. (4.294.10) in [4].*

$$(4.42) \quad \int_0^\infty x^{-1+m} \tanh^{-1}(bx) \log^k(ax) dx$$

$$= \sum_{y=0}^{\infty} -i(-1)^k a^{-m} m^{-1-k} \pi \left( \Gamma \left( 1+k, -m \left( i(\pi + 2\pi y) + \log \left( \frac{a}{b} \right) \right) \right) \right. \\ \left. - \Gamma \left( 1+k, m \left( -2i\pi(1+y) + \log \left( \frac{b}{a} \right) \right) \right) \right)$$

THEOREM 4.43. *From Eq. (2.4.6.6) in [8].*

$$(4.43) \quad \int_0^{\infty} \frac{e^{-mx} (-x + \log(a))^k + e^{mx} (x + \log(a))^k}{b + \cosh(cx)} dx \\ = \frac{i^{1+k} c^{-1-k} e^{\frac{im(\pi + i \cosh^{-1}(b))}{c}} (2\pi)^{1+k}}{\sqrt{-1+b^2}} \left( \Phi \left( e^{\frac{2im\pi}{c}}, -k, \frac{\pi + i \cosh^{-1}(b) - ic \log(a)}{2\pi} \right) \right. \\ \left. - e^{\frac{2m \cosh^{-1}(b)}{c}} \Phi \left( e^{\frac{2im\pi}{c}}, -k, -\frac{i(i\pi + \cosh^{-1}(b) + c \log(a))}{2\pi} \right) \right)$$

THEOREM 4.44. *From Eq. (2.2.7.11) in [8].*

$$(4.44) \quad \int_0^{\infty} \frac{x^{-1+\alpha} (b^m \log^k(ab) - x^m \log^k(ax))}{b-x} dx \\ = -(2i)^k b^{-1+m+\alpha} e^{i\pi\alpha} \pi^{1+k} \csc(\pi\alpha) \left( e^{2im\pi} \Phi \left( e^{2i\pi(m+\alpha)}, -k, \frac{2\pi - i \log(a) - i \log(b)}{2\pi} \right) \right. \\ \left. - \Phi \left( e^{2i\pi(m+\alpha)}, -k, -\frac{i(\log(a) + \log(b))}{2\pi} \right) \right)$$

THEOREM 4.45. *From Eq. (2.2.7.13) in [8].*

$$(4.45) \quad \int_0^{\infty} \frac{x^{-1+m-\alpha+\beta} (-1+x^{2\alpha}) \log^k(ax)}{-1+x^{2\beta}} dx \\ = \pi^{1+k} \left( \frac{i}{\beta} \right)^{1+k} \left( e^{\frac{i\pi(m-\alpha)}{\beta}} \Phi \left( -e^{\frac{i\pi(m-\alpha)}{\beta}}, -k, 1 - \frac{i\beta \log(a)}{\pi} \right) \right. \\ \left. - e^{\frac{i\pi(m+\alpha)}{\beta}} \Phi \left( -e^{\frac{i\pi(m+\alpha)}{\beta}}, -k, 1 - \frac{i\beta \log(a)}{\pi} \right) \right)$$

4.0.1. *Integrals of the form  $\int_0^{\infty} x^{m-1} R(a, x)$  where  $R(a, x)$  is a rational function.*

THEOREM 4.46. *From Eq. (2.1.8.3) in [7]*

$$(4.46) \quad \int_0^{\infty} \frac{x^{-1+m} \log^k \left( \frac{\alpha x}{\sqrt{a} + \sqrt{a+x}} \right)}{\sqrt{a+x} (\sqrt{a} + \sqrt{a+x})^m} dx \\ = -2^{1+k+m} a^{\frac{1}{2}(-1+m)} e^{im\pi} (i\pi)^{1+k} \Phi \left( e^{2im\pi}, -k, \frac{1}{2} - \frac{i(\log(4) + \log(a) + 2 \log(\alpha))}{4\pi} \right)$$

THEOREM 4.47. *From Eq. (2.1.8.3) in [7]*



$$(4.47) \quad \int_0^\infty \frac{\log^k \left( \frac{\alpha}{-\sqrt{a} + \sqrt{a+x}} \right)}{x\sqrt{a+x} (-\sqrt{a} + \sqrt{a+x})^m} dx$$

$$= 2^{1+k-m} a^{-\frac{1}{2} - \frac{m}{2}} e^{im\pi} (i\pi)^{1+k} \Phi \left( e^{2im\pi}, -k, \frac{1}{2} + \frac{i(\log(4) + \log(a) - 2\log(\alpha))}{4\pi} \right)$$

THEOREM 4.48. *From Eq. (2.1.8.7) in [7]*

$$(4.48) \quad \int_0^\infty \frac{x^{-1+m} \log^k \left( \frac{\alpha x}{\sqrt{a+x} \sqrt{a(a+2x)}} \right)}{\sqrt{a+2x} (a+x + \sqrt{a(a+2x)})^{m/2}} dx$$

$$= -2^{1+k+\frac{m}{2}} a^{\frac{1}{2}(-1+m)} e^{im\pi} (i\pi)^{1+k} \Phi \left( e^{2im\pi}, -k, \frac{1}{2} - \frac{i(\log(2) + \log(a) + 2\log(\alpha))}{4\pi} \right)$$

THEOREM 4.49. *From Eq. (2.1.8.10) in [7]*

$$(4.49) \quad \int_0^\infty \frac{x^{-1+m} (x + \sqrt{a^2 + x^2})^{m-1} \log^k (\alpha x (x + \sqrt{a^2 + x^2}))}{\sqrt{a^2 + x^2}} dx$$

$$= -2^{1+k-m} a^{-2+2m} e^{im\pi} (i\pi)^{1+k} \Phi \left( e^{2im\pi}, -k, \frac{1}{2} - \frac{i(2\log(a) + \log(\frac{\alpha}{2}))}{2\pi} \right)$$

THEOREM 4.50. *From Eq. (3.194.4(11)) in [4]. K olbig form.*

$$(4.50) \quad \int_0^\infty \frac{x^m \log^k(ax)}{(1 + \beta x^q)^{n+1}} dx$$

$$= \frac{k!}{q^n} \sum_{t=0}^n \sum_{j=0}^n \frac{(-1)^{j+t} e^{\frac{i(1+m)\pi}{q}} (2\pi)^{1+k-t} \left(-\frac{1}{q}\right)^t \left(\frac{i}{q}\right)^{-1+k-t} q^{-2+n} \beta^{-\frac{1+m}{q}} \left(-\frac{1+m-q}{q}\right)_{-j+n} S_j^{(t)}}{j! (-j+n)! (k-t)!}$$

$$\Phi \left( e^{\frac{2i(1+m)\pi}{q}}, -k+t, \frac{\pi - iq \log(a) + i \log(\beta)}{2\pi} \right)$$

THEOREM 4.51. *From Eq. (2.1.9.16) in [7]*

$$(4.51) \quad \int_0^\infty \frac{x^{-1+m} \left( b + x + \sqrt{x(2b+x)} \right)^{-\frac{1}{2}+m} \log^k \left( ax \left( b + x + \sqrt{x(2b+x)} \right) \right)}{\sqrt{2b+x}} dx$$

$$- 2^{\frac{3}{2}+2k-m} b^{-1+2m} e^{2im\pi} (i\pi)^{1+k} \Phi \left( e^{4im\pi}, -k, \frac{2\pi - i \log \left( \frac{ab^2}{2} \right)}{4\pi} \right)$$

THEOREM 4.52. *From Eq. (2.1.9.7) in [7]*

$$(4.52) \quad \int_0^\infty \frac{\sinh^{m-1}(x) \log^k \left( \frac{a \sinh(x)}{\sqrt{1+\cosh(x)}} \right)}{\sqrt{(1+\cosh(x))^m}} dx$$

$$= -i2^{m/2}e^{\frac{1}{2}i(k+m)\pi}\pi^{1+k}\Phi\left(e^{im\pi}, -k, -\frac{i(i\pi + \log(2) + 2\log(a))}{2\pi}\right)$$

THEOREM 4.53. *From Eq. (2.1.9.10) in [7]*

$$(4.53) \quad \int_0^\infty \frac{\log^k(ax(x + \sqrt{b^2 + x^2}))\left(x^{-1+m}(x + \sqrt{b^2 + x^2})^{-1+m}\right)}{\sqrt{b^2 + x^2}} dx \\ - 2^{1+k-m}b^{-2+2m}e^{im\pi}(i\pi)^{1+k}\Phi\left(e^{2im\pi}, -k, -\frac{i(i\pi + \log(a) - \log(2) + 2\log(b))}{2\pi}\right)$$

THEOREM 4.54. *From Eq. (2.1.9.10) in [7]*

$$(4.54) \quad \int_0^\infty \frac{\log^k\left(\frac{ax}{-x + \sqrt{b^2 + x^2}}\right)x^{-1+m}(-x + \sqrt{b^2 + x^2})^{1-m}}{\sqrt{b^2 + x^2}} dx \\ = -2^{1+k-m}e^{im\pi}(i\pi)^{1+k}\Phi\left(e^{2im\pi}, -k, \frac{\pi + i\log(2) - i\log(a)}{2\pi}\right)$$

THEOREM 4.55. *From Eq. (1.2.2.38) in [11]*

$$(4.55) \quad \int_0^\infty x^{-1+m}\left(x + \sqrt{b^2 + x^2}\right)^{-2+m}\log^k\left(ax\left(x + \sqrt{b^2 + x^2}\right)\right) dx \\ = 2^{-1+k-m}b^{-2+2m}e^{\frac{1}{2}i(k+2m)\pi}\pi^k\left(k\Phi\left(e^{2im\pi}, 1-k, -\frac{i\left(i\pi + \log\left(\frac{a}{2}\right) + \log(b^2)\right)}{2\pi}\right)\right) \\ + 2i(-2+m)\pi\Phi\left(e^{2im\pi}, -k, -\frac{i\left(i\pi + \log\left(\frac{a}{2}\right) + \log(b^2)\right)}{2\pi}\right)\right)$$

THEOREM 4.56. *From Eq.(2.2.4.1) in [18]*

$$(4.56) \quad \int_0^\infty e^{bmx}(1 - e^{-bx})^m \log^k(ae^{bx}(1 - e^{-bx})) dx = \frac{e^{im\pi}(2i\pi)^{1+k}\Phi\left(e^{2im\pi}, -k, \frac{\pi - i\log(a)}{2\pi}\right)}{b}$$

THEOREM 4.57. *From Eq.(2.3.1.13) in [18]*

$$(4.57) \quad \int_0^\infty \frac{\log^k\left(\frac{a}{e^x(\cosh(bx) - 1)^{1/b}}\right)}{(e^x(\cosh(bx) - 1)^{1/b})^m} dx \\ = -i^k 2^{1+2k+\frac{m}{b}} b^{-1-k} e^{\frac{2im\pi}{b}} \pi^{1+k} \Phi\left(e^{\frac{4im\pi}{b}}, -k, \frac{1}{2} - \frac{i(\log(2) + b\log(a))}{4\pi}\right)$$

THEOREM 4.58. *From Eq. (2.9.41) in [40]*

$$(4.58) \quad \int_0^\infty e^{-imx}\left((-ix + \log(a))^{-2+k} - e^{2imx}(ix + \log(a))^{-2+k}\right) \\ + \frac{1}{(-1+k)k}\left(2km\left((-ix + \log(a))^{-1+k} - e^{2imx}(ix + \log(a))^{-1+k}\right)\right)$$

$$\begin{aligned}
& + (1 + m^2) \left( (-ix + \log(a))^k - e^{2imx} (ix + \log(a))^k \right) \log(1 - e^{-2x}) \sinh(x) dx \\
& = -\frac{i}{(-1+k)k} \left( 2a^{-i-m} k (-a^{2i}(i-m)^{-1-k} \Gamma(k, -((-i+m)\log(a))) \right. \\
& \quad \left. - (-i-m)^{-1-k} \Gamma(k, -((i+m)\log(a))) \right) \\
& \quad + \pi \left( -2e^{m\pi} \pi^k \Phi \left( -e^{m\pi}, -k, \frac{\pi + \log(a)}{\pi} \right) + \log^k(a) \right) \\
& - 2im \left( (-i-m)^{-1-k} (-((-i+m)\log(a)))^k + (-i-m)^{-1-k} (-((i+m)\log(a)))^k \right)
\end{aligned}$$

THEOREM 4.59. *From Eq. (2.2.4.8) in [8]*

$$\begin{aligned}
(4.59) \quad \int_0^z \frac{x^{m-1}}{(z^u - x^u)^{m/u}} \log^k \left( \frac{ax}{(z^u - x^u)^{1/u}} \right) dx \\
= -e^{\frac{im\pi}{u}} \left( \frac{2\pi i}{u} \right)^{1+k} \Phi \left( e^{\frac{2im\pi}{u}}, -k, \frac{\pi - iu \log(a)}{2\pi} \right)
\end{aligned}$$

THEOREM 4.60. *From Eq. (3.411.31) in [4].*

$$\begin{aligned}
(4.60) \quad \int_0^\infty \frac{-e^{(-m+p)x} (-x + \log(a))^k + e^{mx} (x + \log(a))^k}{-1 + e^{px}} dx \\
= e^{\frac{2im\pi}{p}} \left( \frac{i}{p} \right)^{1+k} (2\pi)^{1+k} \Phi \left( e^{\frac{2im\pi}{p}}, -k, 1 - \frac{ip \log(a)}{2\pi} \right) + \frac{i\pi \log^k(a)}{p}
\end{aligned}$$

THEOREM 4.61.

$$\begin{aligned}
(4.61) \quad \int_0^\infty x^{-1+m} \log^{-1+k}(ax) (k + m \log(ax)) \log \left( x^n \left( 1 + \frac{1}{x} \right)_n \right) dx \\
= -\sum_{s=1}^n e^{im\pi} (2i\pi)^{1+k} s^{-m} \Phi \left( e^{2im\pi}, -k, \frac{\pi - i \log(a) + i \log(s)}{2\pi} \right)
\end{aligned}$$

where  $Re(m) < 0$

THEOREM 4.62.

$$\begin{aligned}
(4.62) \quad \int_0^1 x^n (-1 + x^{-1-n})^{-\frac{1}{2}+m} \log^k(a(-1 + x^{-1-n})) dx \\
= \frac{e^{\frac{1}{2}i(k+2m)\pi}}{1+n} \left( ik(2\pi)^k \Phi \left( -e^{2im\pi}, 1-k, \frac{\pi - i \log(a)}{2\pi} \right) \right. \\
\left. + \pi (-2^{1+k} m \pi^k + (2\pi)^k) \Phi \left( -e^{2im\pi}, -k, \frac{\pi - i \log(a)}{2\pi} \right) \right)
\end{aligned}$$

#### 4.1. Theorems on multi-dimensional integrals.

THEOREM 4.63. *From Entry 23. in [38]*

$$(4.63) \quad \int_0^\infty \int_0^\infty \frac{\log^k \left( \frac{ay}{x^{1/r}} \right) x^{-\frac{m}{r}} y^{-1+m+\frac{r}{2}} \Gamma(b+x)}{(1+dy^r) \Gamma(1+b+n+x)} dy dx$$

$$= \sum_{p=0}^{\infty} \frac{4^{1+k} d^{-\frac{1}{2} - \frac{m}{r}} e^{\frac{2im\pi}{r}} (b+p)^{-\frac{m}{r}} \pi^{2+k} \left(\frac{i}{r}\right)^{-1+k} \Phi\left(e^{\frac{4im\pi}{r}}, -k, \frac{2\pi - ir \log(a) + i \log(d) + i \log(b+p)}{4\pi}\right) (-n)_p}{r^2 p! \Gamma(1+n)}$$

THEOREM 4.64. *From Eq. (3.26.12) in [7] and Eq. (3.326.2(10)) in [4].*

$$(4.64) \quad \int_0^{\infty} \int_0^{\infty} \int_0^{\infty} \int_0^{\infty} \log^k \left( \frac{axy^2 z^2}{t} \right) e^{-b(t+y^4+z^4)} t^{-m} x^{-1+m} y^{2+2m} z^{2+2m} \\ K\left(\frac{-x+\alpha}{2\alpha}\right) \theta(-x+\alpha) dt dz dy dx \\ = \frac{i^{-1+k} 2^{-4+k-m} e^{im\pi} \pi^{\frac{5}{2}+k} \alpha^m \Phi\left(e^{2im\pi}, -k, -\frac{i(\pi + \log(\frac{a}{2}) + \log(\alpha))}{2\pi}\right)}{b^{5/2}}$$

THEOREM 4.65. *From Eq. (2.2.7.3) in [8]*

$$(4.65) \quad \int_{-d}^d \int_{-c}^c \frac{\log^k \left( \frac{a(c+y)\sqrt{-1+\frac{2d}{d+x}}}{c-y} \right) \left(-1 + \frac{2d}{d+x}\right)^{\frac{1}{2}(-2+m)} \left(\frac{c+y}{c-y}\right)^m}{c^2 + y^2} dy dx \\ = \frac{i^{-1+k} d e^{im\pi} (2\pi)^{2+k} \Phi\left(e^{2im\pi}, -k, \frac{\pi - i \log(a)}{2\pi}\right)}{c} + \frac{(2i)^{1+k} d e^{im\pi} m \pi^{2+k} \Phi\left(e^{2im\pi}, -k, \frac{\pi - i \log(a)}{2\pi}\right)}{c} \\ + \frac{(2i)^k k d e^{im\pi} \pi^{1+k} \Phi\left(e^{2im\pi}, 1-k, \frac{\pi - i \log(a)}{2\pi}\right)}{c}$$

THEOREM 4.66. *From Eq. (3.251.1) and (3.241.1) in [4].*

$$(4.66) \quad \int_0^1 \int_0^{\infty} \frac{\log^k (a(-1+x^{-1-n})y^2) x^n (-1+x^{-1-n})^m y^{2m}}{1+y^2} dy dx \\ = \frac{2^{-1+2k} e^{2im\pi} (i\pi)^{1+k} \left( ik \Phi\left(e^{4im\pi}, 1-k, \frac{1}{2} - \frac{i \log(a)}{4\pi}\right) - 4m\pi \Phi\left(e^{4im\pi}, -k, \frac{1}{2} - \frac{i \log(a)}{4\pi}\right) \right)}{1+n}$$

THEOREM 4.67. *From Eq. (3.1.3.9) and (8.334.3) in [8]*

$$(4.67) \quad \int_{\mathbb{R}_+^4} (rs)^{-\frac{m}{2}-1} (r+s)^{\frac{m+1}{2}} (xy)^{m/2} (x+y)^{\frac{1}{2}(-m-1)} e^{-p(r+x)-q(s+y)} \\ \log^k \left( \frac{a\sqrt{r+s}\sqrt{xy}}{\sqrt{rs}\sqrt{x+y}} \right) dx dy dr ds \\ = \frac{2i\pi^{k+2} e^{\frac{1}{2}i\pi(k+m)} \Phi\left(e^{im\pi}, -k, \frac{1}{2} - \frac{i \log(a)}{\pi}\right)}{pq}$$

THEOREM 4.68. *From (3.241.4) in [4] and equation (3.9.1.3) in [7]. For all  $k, a \in \mathbb{C}, \operatorname{Re}(v) > 0, \operatorname{Re}(p) > 0, \operatorname{Re}(m) < \operatorname{Re}(u), -1/2 < \operatorname{Re}(m) < \operatorname{Re}(v), \operatorname{Re}(u) \leq 1$ , then*

$$(4.68) \quad \int_{\mathbb{R}_+^4} y^m x^{u-1} t^{-m+\frac{u}{v}-1} z^{u(\frac{1}{v}-1)-m} D_u(t\alpha) e^{-b(y+z^2)-\frac{1}{4}a^2 t^2}$$

$$\begin{aligned}
& (p + qx^v)^{-m-1} \log^k \left( \frac{ay}{tz(p + qx^v)} \right) dx dy dz dt \\
&= \frac{1}{v} i^{k+1} \pi^{k+\frac{3}{2}} p^{-m-1} e^{i\pi(m-\frac{u}{v})} \Gamma \left( \frac{u}{v} \right) b^{-\frac{(m+3)v+u(-v)+u}{2v}} 2^{\frac{1}{2}(2k+m-\frac{u}{v}+u)} \alpha^{m-\frac{u}{v}} \left( \frac{p}{q} \right)^{u/v} \\
& \quad \Phi \left( e^{2i\pi(m-\frac{u}{v})}, -k, -\frac{i(2\log(a) - \log(b) - 2\log(p) + 2\log(\alpha) + \log(2) + 2i\pi)}{4\pi} \right)
\end{aligned}$$

THEOREM 4.69. From equation (3.18.5) in [7] and equation (3.326.2) in [4]. For all  $k, a, b, c, \alpha \in \mathbb{C}$ ,  $1/2 < \text{Re}(m) < 1$ ,

(4.69)

$$\begin{aligned}
& \int_0^\infty \int_0^\infty \int_0^\infty x^{m-1} y^{2m+4} z^{-m} Ai(x\alpha)^2 e^{-by^6 - cz} \log^k \left( \frac{axy^2}{z} \right) dx dy dz \\
&= -i\pi^{k+\frac{1}{2}} 3^{-\frac{m}{3}-\frac{11}{6}} b^{-\frac{m}{3}-\frac{5}{6}} c^{m-1} 2^{k-\frac{2(m+1)}{3}} e^{\frac{1}{2}i\pi(k+2m)} \alpha^{-m} \\
& \quad \Phi \left( e^{2im\pi}, -k, \frac{i(-3\log(a) + \log(b) - 3\log(c) + 3\log(\alpha) + \log(12) - 3i\pi)}{6\pi} \right)
\end{aligned}$$

THEOREM 4.70. From Eq. (3.251.1) and (3.241.1) in [4]

$$\begin{aligned}
(4.70) \quad & \int_0^1 \int_0^\infty \frac{\log^k (a(-1+x^{-1-n})y^2) x^n (-1+x^{-1-n})^m y^{2m}}{1+y^2} dy dx \\
&= \frac{2^{-1+2k} e^{2im\pi} (i\pi)^{1+k} \left( ik\Phi \left( e^{4im\pi}, 1-k, \frac{1}{2} - \frac{i\log(a)}{4\pi} \right) - 4m\pi\Phi \left( e^{4im\pi}, -k, \frac{1}{2} - \frac{i\log(a)}{4\pi} \right) \right)}{1+n}
\end{aligned}$$

THEOREM 4.71.

$$\begin{aligned}
(4.71) \quad & \int_0^1 \int_0^1 \log^k (a(-1+x^{-1-n})(-1+y^{-1-n})) x^n (-1+x^{-1-n})^m y^n (-1+y^{-1-n})^{\frac{1}{2}+m} dy dx \\
&= \frac{i4^{-1+k} e^{\frac{1}{2}i(k+4m)\pi} \pi^k}{(1+n)^2} \left( 2ik(1+4m)\pi\Phi \left( e^{4im\pi}, 1-k, \frac{1}{2} - \frac{i\log(a)}{4\pi} \right) \right. \\
& \quad \left. + (-1+k)k\Phi \left( e^{4im\pi}, 2-k, \frac{1}{2} - \frac{i\log(a)}{4\pi} \right) - 8m(1+2m)\pi^2\Phi \left( e^{4im\pi}, -k, \frac{1}{2} - \frac{i\log(a)}{4\pi} \right) \right)
\end{aligned}$$

THEOREM 4.72. From Eq. (3.197.10) in [4].

$$\begin{aligned}
(4.72) \quad & \int_0^1 \int_0^1 \frac{\log^k \left( \frac{ax(-1+y^{-1-n})}{1-x} \right) (1-x)^{-\frac{1}{2}-m} x^{-\frac{1}{2}+m} y^n (-1+y^{-1-n})^m}{1+px} dy dx \\
&= -\frac{i(4i)^k e^{2im\pi} (1+p)^{-\frac{1}{2}-m} \pi^{1+k}}{1+n} \left( -ik\Phi \left( e^{4im\pi}, 1-k, \frac{2\pi - i\log(a) + i\log(1+p)}{4\pi} \right) \right. \\
& \quad \left. + 4m\pi\Phi \left( e^{4im\pi}, -k, \frac{2\pi - i\log(a) + i\log(1+p)}{4\pi} \right) \right)
\end{aligned}$$

where  $\text{Im}(n) \leq 0$ .

THEOREM 4.73. From Eq. (3.3.1.1) in [7] and Eq. (3.1.3.9) in [8]

$$\begin{aligned}
(4.73) \quad & \int_0^\infty \int_0^\infty \int_0^\infty \log^k \left( \frac{a\sqrt{xy}}{\sqrt{z}\sqrt{x+y}} \right) e^{-px-xy} (xy)^{m/2} (x+y)^{-\frac{1}{2}-\frac{m}{2}} z^{-1-\frac{m}{2}} Ei(-bz) dz dy dx \\
&= \sum_{y=0}^\infty \frac{4ia^{-m}\pi^{3/2}}{m(\sqrt{p}+\sqrt{q})\sqrt{pq}} \left( (-1)^k m^{-k} \Gamma(1+k) + \left( -k\Gamma(k) + \Gamma\left(1+k, -\frac{1}{2}m(i\pi+2i\pi y) \right. \right. \right. \\
&\quad \left. \left. \left. + 2\log(a) + \log(b) - 2\log(\sqrt{p}+\sqrt{q}) \right) \right) (2\log(a) + \log(b) \right. \\
&\quad \left. + i(\pi + 2\pi y + 2i\log(\sqrt{p}+\sqrt{q})) \right)^k (-m(2\log(a) + \log(b) + i(\pi + 2\pi y + 2i\log(\sqrt{p}+\sqrt{q}))))^{-k}
\end{aligned}$$

THEOREM 4.74. From Eq. (3.3.1.1) in [7] and Eq. (3.1.3.9) in [8]

$$\begin{aligned}
(4.74) \quad & \int_0^\infty \int_0^\infty \int_0^\infty e^{-px-xy} (xy)^{m/2} (x+y)^{-\frac{1}{2}-\frac{m}{2}} z^{-1-\frac{m}{2}} Ei(-bz) \log^{-1+k} \left( \frac{a\sqrt{xy}}{\sqrt{x+y}\sqrt{z}} \right) \\
&\quad \left( k + m \log \left( \frac{a\sqrt{xy}}{\sqrt{x+y}\sqrt{z}} \right) \right) dz dy dx \\
&= \frac{4ib^{m/2} e^{\frac{1}{2}i(k+m)\pi} \pi^{\frac{3}{2}+k} (\sqrt{p}+\sqrt{q})^{-1-m} \Phi \left( e^{im\pi}, -k, \frac{\pi-2i\log(a)-i\log(b)+2i\log(\sqrt{p}+\sqrt{q})}{2\pi} \right)}{\sqrt{pq}}
\end{aligned}$$

THEOREM 4.75. From Eq. (3.368.2) and (3.387.1) in [4].

$$\begin{aligned}
(4.75) \quad & \int_0^{\frac{\pi}{4}} \int_0^{\frac{\pi}{4}} \int_0^{\frac{\pi}{4}} \log^k \left( \frac{a \sin(2x) \sin(2y) \sin(z)}{\cos(2x)(\cos(z) - \sin(z))(\cos(y) + \sin(y))^2} \right) \\
&\quad \cos^{-m}(2x) \sec(x) \sec^2(z) \sin^{-\frac{1}{2}+m}(2x) (\cos(y) + \sin(y))^{-2m} \\
&\quad \sin^{-1+m}(2y) (\cos(z) - \sin(z))^{\frac{1}{2}-m} \sin^{-\frac{1}{2}+m}(z) dz dy dx \\
&= -\sqrt{-1} 2^{2k-m} e^{\frac{1}{2}i(k+3m)\pi} \pi^{2+k} \left( \Phi \left( e^{4im\pi}, -k, \frac{3}{8} - \frac{i\log(\frac{a}{2})}{4\pi} \right) \right. \\
&\quad \left. + i e^{im\pi} \Phi \left( e^{4im\pi}, -k, \frac{5}{8} - \frac{i\log(\frac{a}{2})}{4\pi} \right) \right)
\end{aligned}$$

THEOREM 4.76.

$$\begin{aligned}
(4.76) \quad & \int_0^{\frac{\pi}{2}} \int_0^1 \int_0^{\frac{\pi}{2}} \int_0^1 \log^k \left( \frac{a \sin(x) \sqrt{\log(y)}}{\sin(z) \sqrt{\log(r)}} \right) \log^{-\frac{m}{2}}(r) \log^{\frac{m}{2}}(y) \sin^m(x) \sin^{-m}(z) dr dz dy dx \\
&= \frac{1}{2} e^{\frac{1}{2}i(k+m)\pi} \pi^{2+k} \Phi \left( -e^{im\pi}, -k, \frac{1}{2} - \frac{i\log(a)}{\pi} \right)
\end{aligned}$$

THEOREM 4.77. From Eq. (3.192.4) in [4] and Eq. (3.2.1.2) in [7].

$$(4.77) \quad \int_0^\infty \int_1^\infty \frac{\log^k(ax(-1+y))(-1+y)^{-\frac{1}{2}} Li_n(-bx)}{xy} dy dx$$

$$= - \frac{ik! (-1)^n i^{k+n} 2^{2+2(k+n)} \pi^{2+k+n} \zeta \left( -k-n, \frac{2\pi - i \log(a) + i \log(b)}{4\pi} \right)}{(k+n)!}$$

THEOREM 4.78. From Eq. (3.18.5.1) in [7] and Eq. (3.326.2) in [4].

$$(4.78) \quad \int_0^\infty \int_0^\infty \int_0^\infty \int_0^\infty \log^k \left( \frac{axy^2}{zt^2} \right) e^{-dt^6 - cy^6} t^{-2(-3+m)} x^{-1+m} y^{2(2+m)} z^{-m} Ai(bx)^2 Ai(fz)^2 dt dz dy dx$$

$$= - \frac{1}{81} \left( i 2^{-3+k} b^{-m} c^{-\frac{5}{6} - \frac{m}{3}} d^{-\frac{7}{6} + \frac{m}{3}} e^{im\pi} f^{-1+m} (i\pi)^k \right.$$

$$\left. \Phi \left( e^{2im\pi}, -k, \frac{3\pi - 3i \log(a) + 3i \log(b) + i \log(c) - i \log(d) - 3i \log(f)}{6\pi} \right) \right)$$

THEOREM 4.79.

$$(4.79) \quad \int_0^1 \int_0^1 \frac{x^{-1-m} y^s (-1 + y^{-1-s})^{-\frac{1}{2} + \frac{m}{q}}}{(b+x^q)(1+bx^q)} \left( x^q (1+bx^q) \log^k \left( \frac{a(-1+y^{-1-s})^{1/q}}{x} \right) \right.$$

$$\left. + x^{2m} (b+x^q) \log^k \left( ax(-1+y^{-1-s})^{1/q} \right) \right) dy dx$$

$$= \frac{\left( (4i)^k b^{-\frac{m}{q}} e^{\frac{2im\pi}{q}} \pi^{1+k} q^{-2-k} \right)}{1+s} \left( kq \Phi \left( e^{\frac{4im\pi}{q}}, 1-k, \frac{1}{2} - \frac{iq(\log(a) + \log(b^{-1/q}))}{4\pi} \right) \right.$$

$$\left. - 2i\pi(-2m+q) \Phi \left( e^{\frac{4im\pi}{q}}, -k, \frac{1}{2} - \frac{iq(\log(a) + \log(b^{-1/q}))}{4\pi} \right) \right)$$

THEOREM 4.80. From Eq. (6.4.14) in [40]

$$(4.80) \quad \int_0^1 \int_0^1 \int_0^1 z^s (-1 + z^{-1-s})^m \log^{-\frac{1}{2}+m}(x) \log^{-\frac{1}{2}-m}(y) \log^k \left( \frac{a(-1+z^{-1-s}) \log(x)}{\log(y)} \right) dz dy dx$$

$$= \frac{(4i)^k e^{2im\pi} \pi^{1+k} \left( k \Phi \left( e^{4im\pi}, 1-k, \frac{1}{2} - \frac{i \log(a)}{4\pi} \right) + 4im\pi \Phi \left( e^{4im\pi}, -k, \frac{1}{2} - \frac{i \log(a)}{4\pi} \right) \right)}{1+s}$$

## 4.2. Theorems involving integrals of series.

THEOREM 4.81.

$$(4.81) \quad \int_0^1 \left( \sum_{s=1}^n s^m \left( -1 + \frac{1}{x} \right)^m \log^k \left( as \left( -1 + \frac{1}{x} \right) \right) \right) dx$$

$$= \sum_{c=1}^n \left( -kc^m e^{im\pi} (2i\pi)^k \Phi \left( e^{2im\pi}, 1-k, \frac{\pi - i \log(a) - i \log(c)}{2\pi} \right) \right.$$

$$\left. - mc^m e^{im\pi} (2i\pi)^{1+k} \Phi \left( e^{2im\pi}, -k, \frac{\pi - i \log(a) - i \log(c)}{2\pi} \right) \right)$$

### Theorems involving series

THEOREM 4.82.

$$(4.82) \quad \sum_{j=0}^{\infty} \sum_{l=0}^{\infty} \frac{(-\frac{1}{a})^{j+l} \Gamma(j-m+2) \Gamma(l+m+1) (1-k)_{j+l-1}}{(j+l+1)(j+l+2) \Gamma(j+1) \Gamma(l+1)} \\ = \frac{\pi e^a (m-1) m a^{-k} \csc(\pi m) \Gamma(k+1, a)}{2k}$$

THEOREM 4.83. *From Eq. (5.7.1.15) in [16] and Eq. (6.3.3.1) in [17].*

$$(4.83) \quad \sum_{j=0}^{\infty} \sum_{l=0}^{\infty} \sum_{q=0}^{\infty} \frac{E_q(\alpha) 2^{-2j-2l+q} (-\frac{1}{a})^{2j+2l+q} (1-k)_{2j+2l+q}}{\Gamma(l+1) \Gamma(q+1) \Gamma(2j+l+2)} \\ = \frac{a^{1-k} (2^{2k+1} (\zeta(-k, \frac{1}{4}(a+2\alpha+1)) - \zeta(-k, \frac{1}{4}(a+2\alpha+3))) - (a+2\alpha-1)^k)}{k}$$

THEOREM 4.84. *From Eq. (1.4) in [20] and Eq. (8.440) in [4].*

$$(4.84) \quad \sum_{l=0}^{\infty} \sum_{n=0}^{\infty} \sum_{j=0}^{[n/2]} \frac{(\alpha+n) 2^{-\alpha-2j-2l} (-1)^{-j+l+n} (\frac{1}{t})^{-2j+n+1} \Gamma(-j+n+1) (\frac{-\alpha}{n-j}) a^{-\alpha+k-2l-n}}{\alpha \Gamma(j+1) \Gamma(l+1) \Gamma(l+n+\alpha+1) (k)_{-2l-n-\alpha+1}} \\ = \frac{2^{-\alpha} e^{at} \Gamma(k) t^{\alpha-k-1} \Gamma(k-\alpha+1, at)}{\Gamma(\alpha+1) \Gamma(k-\alpha+1)}$$

THEOREM 4.85. *From Ex.3 on page 230 in [21].*

$$(4.85) \quad \sum_{n=-\infty}^{\infty} \frac{a^{-m+n} e^{in\beta} \Gamma(1+k, (-m+n) \log(a))}{(n-m)^{k+1}} \\ = i e^{\frac{1}{2}i(k\pi+2m\beta)} (2\pi)^{1+k} \Phi \left( e^{2im\pi}, -k, \frac{\beta - i \log(a)}{2\pi} \right)$$

THEOREM 4.86. *From Eq. (1) in [22] and [2].*

$$(4.86) \quad \sum_{n=0}^{\infty} \frac{t^n L_n^a(x)}{(a+n+1)!} = t^{-a-1} \int_0^t e^s s^a (sx)^{-a/2} J_a(2\sqrt{sx}) ds$$

THEOREM 4.87. *From Eq. (12.2.11) in [23] and [2].*

$$(4.87) \quad \sum_{l=0}^{\infty} \frac{(-s)^l \Gamma(l+2v) L_l^u(z)}{(l+u+1)!} = \int_0^s \frac{r^u (r+1)^{-2v} s^{-u-1} \Gamma(2v) {}_1F_1 \left( 2v; u+1; \frac{rz}{r+1} \right)}{\Gamma(u+1)} dr$$

THEOREM 4.88. *From Eq. (12.2.18a) in [23] and [2].*

$$(4.88) \quad \sum_{l=0}^{\infty} \frac{(as)^l L_n^{l-n}(s)}{(l+1)!}$$



$$= -\frac{e^s \left( -(a-1)^n s^n (s-as)^{-n} \Gamma(n+1, s-as) + e^{i\pi n} \Gamma(n+1, s) \right)}{asn!}$$

THEOREM 4.89. *From Eq. (1) in [22].*

$$(4.89) \quad \sum_{n=0}^{\infty} \frac{(-t)^n (1-k)_{n-1} L_n^\alpha(x)}{(\alpha+n)!} = -\frac{\left(\frac{1}{t}+1\right)^k t^k {}_1F_1\left(-k; \alpha+1; \frac{tx}{t+1}\right)}{k\Gamma(\alpha+1)}$$

THEOREM 4.90. *From Eq. (1) in [22] and [2].*

$$(4.90) \quad \sum_{n=0}^{\infty} \frac{(-t)^n (1-k)_{n-1} L_n^\alpha(x)}{(\alpha+n+1)!} = -t^{-\alpha-1} \int_0^t \frac{(-r-1)^k (-r)^{-k} r^{\alpha+k} {}_1F_1\left(-k; \alpha+1; \frac{rx}{r+1}\right)}{k\Gamma(\alpha+1)} dr$$

THEOREM 4.91. *From Eq. (3) in [22].*

$$(4.91) \quad \sum_{n=0}^{\infty} \frac{t^n C_n^{(p+\frac{1}{2})}(x)}{(n+2p+1)!} = \int_0^t \frac{2^p s^{2p} t^{-2p-1} \Gamma(p+1) e^{sx} (s\sqrt{1-x^2})^{-p} J_p(s\sqrt{1-x^2})}{\Gamma(2p+1)} ds$$

THEOREM 4.92. *From Eq. (5.2.13.29) in [8] and [2].*

$$(4.92) \quad \sum_{k=0}^{\infty} \frac{((y-1)y^{-v})^k \Gamma(u+kv)}{(k+1)! \Gamma(vk-k+u)} = \frac{y^u - y^v}{(y-1)(u-v)}$$

THEOREM 4.93. *From Eq. (5.2.13.30) in [8] and [2].*

$$(4.93) \quad \sum_{k=0}^{\infty} \frac{((y-1)y^{-v})^k \Gamma(u+kv-1)}{(k+1)! \Gamma(vk-k+u)} = \frac{y^v}{(1-y)(u-v-1)(u-v)} + \frac{y^u \left( \frac{v}{-uy+vy+y} + \frac{v-1}{u-v} \right)}{(u-1)(1-y)}$$

THEOREM 4.94. *From Eq. (5.13.22) in [24] and [2].*

$$(4.94) \quad \sum_{k=0}^{\infty} \frac{(k+2)^k (e^{-y}y)^{k+1}}{(k+2)!} = \frac{1}{2} (-e^y y + 2e^y - 2)$$

THEOREM 4.95. *From Ex. 28 on page 472 in [21] and [25].*

$$(4.95) \quad \sum_{n=-\infty}^{\infty} e^{\alpha n} \Phi\left(-e^{2(m+n\alpha)}, -k, \frac{1}{2}(\log(a)+1)\right) = \sum_{n=-\infty}^{\infty} \frac{\pi 2^{-k-2} e^{m\left(-1-\frac{2i\pi n}{\alpha}\right)} \operatorname{sech}\left(\frac{\pi^2 n}{\alpha}\right) \left( e^{\frac{4i\pi mn}{\alpha}} \left(\log(a) + \frac{2i\pi n}{\alpha}\right)^k + \left(\log(a) - \frac{2i\pi n}{\alpha}\right)^k \right)}{\alpha}$$

THEOREM 4.96. *From Eq. (4.2.1.7) in [16].*

$$\begin{aligned}
(4.96) \quad & \sum_{p=1}^n \sum_{j=0}^{\infty} \frac{(-1)^{j+p} (2p+v) (2a)^{-2j-2p-v}}{\Gamma(1+j) \Gamma(1-2j+k-2p-v) \Gamma(1+j+2p+v)} \\
&= \sum_{j=0}^{\infty} \frac{((-1)^j 2^{-2-2j-v} a^{-2-2j+k-v})}{a^k \Gamma(1+j)} \\
&\quad \left( -\frac{1}{\Gamma(-1-2j+k-v) \Gamma(2+j+v)} \right. \\
&\quad \quad \left. + \frac{(-\frac{1}{4})^n a^{-2n}}{\Gamma(-1-2j+k-2n-v) \Gamma(2+j+2n+v)} \right)
\end{aligned}$$

THEOREM 4.97. *From Eq. (4.2.1.16) in [16].*

$$\begin{aligned}
(4.97) \quad & \sum_{j=0}^{\infty} \sum_{p=0}^n \frac{(-1)^{j+p} 2^{-2j-m+2p} \binom{m-n}{p} a^{-2j+k-m+2p}}{j! (n-p)! \Gamma(j+m-p+1) (-2j+k-m+2p)!} \\
&= \frac{(-1)^n 2^{2n-m} a^{k-m+2n} {}_2F_1\left(-\frac{k}{2} + \frac{m}{2} - n, -\frac{k}{2} + \frac{m}{2} - n + \frac{1}{2}; m-2n+1; -\frac{1}{a^2}\right)}{\Gamma(n+1) \Gamma(m-2n+1) \Gamma(k-m+2n+1)}
\end{aligned}$$

THEOREM 4.98. *From Eq. (2) in [26].*

$$\begin{aligned}
(4.98) \quad & \sum_{p=0}^{\infty} (-1)^p \left( \frac{a^p \Gamma(1+k, (-m+p) \log(a))}{(p-m)^{k+1}} + \frac{a^{-p} \Gamma(1+k, -((m+p) \log(a)))}{(-m-p)^{k+1}} \right) \\
&= a^m (-1)^m (2i\pi)^{1+k} \Phi\left(e^{2im\pi}, -k, \frac{\pi - i \log(a)}{2\pi}\right) - \frac{\Gamma(1+k, -m \log(a))}{m(-m)^k}
\end{aligned}$$

THEOREM 4.99. *From Eq. (3.31) in [27].*

$$\begin{aligned}
(4.99) \quad & \sum_{p=1}^{\infty} \alpha e^{2\alpha mp} (\coth(\alpha^2 p) - 1) ((\log(a) + 2\alpha p)^k - e^{-4\alpha mp} (\log(a) - 2\alpha p)^k) \\
&+ i \sum_{p=1}^{\infty} \beta e^{-2i\beta mp} (\coth(\beta^2 p) - 1) ((\log(a) - 2i\beta p)^k - e^{4i\beta mp} (\log(a) + 2i\beta p)^k) \\
&= -\frac{1}{\log(a)} \left( 2^{k+1} \log(a) \alpha^{k+1} e^{2\alpha m} \Phi\left(e^{2m\alpha}, -k, \frac{\log(a)}{2\alpha} + 1\right) \right. \\
&\quad \left. - 2^{k+1} \log(a) (i\beta)^{k+1} e^{2i\beta m} \Phi\left(e^{2im\beta}, -k, 1 - \frac{i \log(a)}{2\beta}\right) \right. \\
&\quad \left. + \log^k(a) (2k + \log(a) (\alpha - i\beta + 2m)) \right)
\end{aligned}$$

THEOREM 4.100. *From Eq. (6.1.75) in [24].*

$$(4.100) \quad \sum_{p=0}^{\infty} \frac{((-1)^p e^{-2iapx})}{(m^2 + x^2(1+2p)^2)^{k+1} (1+2p)^2}$$

$$\begin{aligned}
& \left( -e^{2ia(1+2p)x} (k-1)(-im+x(1+2p))(im+x+2px)^2 \right. \\
& \quad \left. (-m-ix(1+2p))^k \Gamma(k-1, -a(m-ix(1+2p))) \right. \\
& -e^{2ia(1+2p)x} m(im+2x(1+2p))(-m-i(1+2p)x)^{1+k} \Gamma(k, -am+ia(1+2p)x) \\
& \quad \left. -x^2(1+2p)^2(im+x(1+2p))(-m+i(1+2p)x)^k \Gamma(k, -a(m+ix(1+2p))) \right) \\
& = \frac{e^{a(m+ix)}}{200k} \left( -200e^{\frac{m\pi}{2x}} \pi^{1+k} \left( \frac{1}{x} \right)^{-1+k} \Phi \left( -e^{\frac{m\pi}{x}}, -k, \frac{1}{2} + \frac{ax}{\pi} \right) \right. \\
& \quad \left. + \frac{a^{-1+k}}{m^3} (-200ikm (Cm^2 + (-3C + \pi)x^2) \right. \\
& + \frac{x}{m^2 + 25x^2} \left( 64km^2 x(-im+5x) {}_4F_3 \left( \frac{5}{2}, \frac{5}{2}, 3, \frac{5}{2} + \frac{im}{2x}; \frac{7}{2}, \frac{7}{2}, \frac{7}{2} + \frac{im}{2x}; -1 \right) \right. \\
& \quad \left. -320km^2 x^2 {}_4F_3 \left( \frac{5}{2}, 3, \frac{5}{2} - \frac{im}{2x}, \frac{5}{2} + \frac{im}{2x}; \frac{7}{2}, \frac{7}{2} - \frac{im}{2x}, \frac{7}{2} + \frac{im}{2x}; -1 \right) \right. \\
& \quad \left. +25(m^2 + 25x^2) \left( - \left( (2am^3 + k(m+ix)(m+3ix)) H_{-\frac{3}{4} - \frac{im}{4x}} \right) \right. \right. \\
& \quad \left. \left. + (2am^3 + k(m+ix)(m+3ix)) H_{-\frac{im+x}{4x}} + (-2am^3 + k(m-ix)(m-3ix)) \right. \right. \\
& \quad \left. \left. \left( -\psi^{(0)} \left( \frac{3}{4} + \frac{im}{4x} \right) + \psi^{(0)} \left( \frac{im+x}{4x} \right) \right) \right) \right) \right)
\end{aligned}$$

THEOREM 4.101. *From Eq. (6.3.4.3) in [17].*

$$\begin{aligned}
(4.101) \quad & \sum_{p=0}^{\infty} \frac{(-1)^p \left( \frac{i}{\pi a} \right)^{2p} (1-k)_{2p} E_{1+2p}(x)}{\Gamma(2+2p)} \\
& = -\frac{a\pi}{k} \left( \frac{2}{a\pi} \right)^k \left( \zeta \left( -k, \frac{1}{2}(1+a\pi-x) \right) - \zeta \left( -k, \frac{1}{2}(2+a\pi-x) \right) \right. \\
& \quad \left. - \zeta \left( -k, \frac{1}{2}(a\pi+x) \right) + \zeta \left( -k, \frac{1}{2}(1+a\pi+x) \right) \right)
\end{aligned}$$

THEOREM 4.102. *From Exercise. (81) in [28].*

$$\begin{aligned}
(4.102) \quad & \sum_{p=1}^n (i(p+2))^k e^{2im(p+2)} \Phi \left( e^{2im(p+2)}, -k, 1 - \frac{i \log(a)}{2(p+2)} \right) \\
& \quad - (i(p+1))^k e^{2im(p+1)} \Phi \left( e^{2im(p+1)}, -k, 1 - \frac{i \log(a)}{2(p+1)} \right) \\
& = (i(n+2))^k e^{2im(n+2)} \Phi \left( e^{2im(n+2)}, -k, 1 - \frac{i \log(a)}{2(n+2)} \right) \\
& \quad - (2i)^k e^{4im} \Phi \left( e^{4im}, -k, 1 - \frac{1}{4} i \log(a) \right)
\end{aligned}$$

THEOREM 4.103.

$$(4.103) \quad \sum_{p=0}^{2n} (-1)^p (i2^p)^k e^{im2^p} \Phi \left( e^{i2^{p+1}m}, -k, \frac{1}{2} (1 - i2^{-p} \log(a)) \right)$$

$$\begin{aligned}
& - \sum_{p=0}^n 2 (i4^p)^k e^{im4^p} \Phi \left( e^{i2^{2p+1}m}, -k, \frac{1}{2} (1 - i4^{-p} \log(a)) \right) \\
& = (i4^n)^k e^{im2^{2n+1}} \Phi \left( e^{i2^{2n+1}m}, -k, 1 - i2^{-2n-1} \log(a) \right) \\
& \quad - \left( \frac{i}{2} \right)^k e^{im} \Phi \left( e^{im}, -k, 1 - i \log(a) \right)
\end{aligned}$$

THEOREM 4.104. *From page 170 exercise 9 in [29].*

(4.104)

$$\begin{aligned}
& \sum_{p=0}^n (i2^p)^k e^{im2^{p+1}} \left( \Phi \left( -e^{i2^{p+1}m}, -k, 1 - i2^{-p-1} \log(a) \right) + \Phi \left( e^{i2^{p+1}m}, -k, 1 - i2^{-p-1} \log(a) \right) \right) \\
& = -2 \left( (i2^{n+1})^k e^{im2^{n+2}} \Phi \left( e^{i2^{n+2}m}, -k, 1 - i2^{-n-2} \log(a) \right) \right. \\
& \quad \left. - i^k e^{2im} \Phi \left( e^{2im}, -k, 1 - \frac{1}{2} i \log(a) \right) \right)
\end{aligned}$$

THEOREM 4.105. *From Eq. (2.4.6.13) in [8] and Eq. (3.511.4) in [4].*

$$\begin{aligned}
(4.105) \quad & \sum_{p=0}^{n-1} (-1)^p e^{-\frac{im p \pi}{n\alpha}} \left( e^{\frac{im(1-2n+2p)\pi}{n\alpha}} \Phi \left( e^{-\frac{2im\pi}{\alpha}}, -k, 1 - \frac{1+2p}{4n} + \frac{a\alpha}{2} \right) \right. \\
& - \Phi \left( e^{-\frac{2im\pi}{\alpha}}, -k, \frac{1+2p+2an\alpha}{4n} \right) - e^{\frac{2im\pi}{\alpha}} \Phi \left( e^{\frac{2im\pi}{\alpha}}, -k, 1 - \frac{1+2p}{4n} + \frac{a\alpha}{2} \right) \\
& \quad \left. + e^{\frac{im(1+2p)\pi}{n\alpha}} \Phi \left( e^{\frac{2im\pi}{\alpha}}, -k, \frac{1+2p+2an\alpha}{4n} \right) \right) \\
& = \left( \frac{1}{2n} \right)^k \left( -\Phi \left( -e^{-\frac{im\pi}{n\alpha}}, -k, \frac{1}{2} + an\alpha \right) + e^{\frac{im\pi}{n\alpha}} \Phi \left( -e^{\frac{im\pi}{n\alpha}}, -k, \frac{1}{2} + an\alpha \right) \right)
\end{aligned}$$

THEOREM 4.106. *From Eq. (4.4.7.14) in [8].*

$$\begin{aligned}
(4.106) \quad & \sum_{p=0}^{n-1} e^{i2^{1-p}m} \left( (i2^{-p})^k \Phi \left( -e^{i2^{1-p}m}, -k, 1 - i2^{-1+p} \log(a) \right) \right. \\
& \quad \left. - (i2^{1-p})^k e^{i2^{1-p}m} \Phi \left( -e^{i2^{2-p}m}, -k, 1 - i2^{-2+p} \log(a) \right) \right) \\
& = -(2i)^k e^{4im} \Phi \left( -e^{4im}, -k, 1 - \frac{1}{4} i \log(a) \right) \\
& \quad + (i2^{1-n})^k e^{i2^{2-n}m} \Phi \left( -e^{i2^{2-n}m}, -k, 1 - i2^{-2+n} \log(a) \right)
\end{aligned}$$

THEOREM 4.107. *Multidimensional sum involving Bernoulli and Euler numbers. From Eqs. (50.5.7) and (51.3.2) in [24].*

(4.107)

$$\sum_{x_1, \dots, x_j \geq 0} \frac{\left( 2^{\sum_{l=1}^{j-1} l x_{2+l}} (-1 + 2^{-1+x_1}) \pi^{x_1 + \sum_{l=1}^j x_{1+l}} B_{x_1} (a\pi)^{k-x_1-\sum_{l=1}^{1j} x_{1+l}} \right) \prod_{l=1}^j \frac{E_{x_{1+l}}}{\Gamma(1+x_{1+l})}}{\Gamma(1+x_1) (k)_{1-x_1-\sum_{l=1}^j x_{1+l}}}$$

$$= \frac{1}{2} (2^{1+j})^k \pi^k \zeta \left( 1 - k, \frac{1}{2} (1 + 2^{-j} a) \right)$$

THEOREM 4.108. *From pg. 127 in [30].*

$$(4.108) \quad \sum_{n=1}^{\infty} \left( (-t)^n (1-k)_{n-1} - \sum_{j=l}^n p^{-j+n} q^j (-t)^j \binom{n}{j} (1-k)_{j-1} \right) \\ = -e^{1/t} t^k \Gamma \left( k, \frac{1}{t} \right) + \frac{e^{1/t} \left( \frac{q}{1-p} \right)^l t^k \Gamma(k) \Gamma \left( 1 + k - l, \frac{1}{t} \right)}{\Gamma(1+k-l)}$$

THEOREM 4.109. *Euler-Hermite generating function. From Eq. (6.3.4) in [17].*

$$(4.109) \quad \sum_{j=0}^{\infty} \sum_{q=0}^{\infty} \frac{(-1)^j a^{-2j-q} E_{2j+1}(\alpha) H_q(\beta)}{\Gamma(2+2j) \Gamma(-2j+k-q) \Gamma(1+q)} \\ = - \sum_{n=0}^{\infty} \sum_{p=0}^{\infty} \frac{(-1)^p i^{1+k-n-2p} 2^{k-2p} a^{1-k} \beta^n}{n! (k-n-2p)! p!} \left( -\zeta \left( -k+n+2p, \frac{1}{2}(1-ia-\alpha) \right) \right. \\ \left. + \zeta \left( -k+n+2p, 1 - \frac{ia}{2} - \frac{\alpha}{2} \right) + \zeta \left( -k+n+2p, \frac{1}{2}(-ia+\alpha) \right) \right. \\ \left. - \zeta \left( -k+n+2p, \frac{1}{2}(1-ia+\alpha) \right) \right)$$

THEOREM 4.110. *From Eq. (4.17)*

$$(4.110) \quad \sum_{p=0}^n \frac{1}{2} (i2^{-p})^{1+k} e^{-i2^{-p}(b+m)} \left( -e^{i2^{1-p}b} \Phi \left( -e^{i2^{-p}(b-m)}, -k, 1 - i2^p a \right) \right. \\ \left. - e^{i2^{1-p}m} \Phi \left( -e^{i2^{-p}(-b+m)}, -k, 1 - i2^p a \right) + \Phi \left( -e^{-i2^{-p}(b+m)}, -k, 1 - i2^p a \right) \right. \\ \left. + e^{i2^{1-p}(b+m)} \Phi \left( -e^{i2^{-p}(b+m)}, -k, 1 - i2^p a \right) \right) \\ = i2^{-1-n} e^{-i2^{-n}(1+2^{1+n})(b+m)} \left( i^k 2^{1+k+n} e^{i(4m+2^{-n}(b+m))} \Phi \left( e^{-2i(b-m)}, -k, 1 - \frac{ia}{2} \right) \right. \\ \left. + i^k 2^{1+k+n} e^{i(4b+2^{-n}(b+m))} \Phi \left( e^{2i(b-m)}, -k, 1 - \frac{ia}{2} \right) \right. \\ \left. - (i2^{-n})^k e^{2i(b+m+2^{-n}m)} \Phi \left( e^{-i2^{-n}(b-m)}, -k, 1 - i2^n a \right) \right. \\ \left. - (i2^{-n})^k e^{2i(b+2^{-n}b+m)} \Phi \left( e^{i2^{-n}(b-m)}, -k, 1 - i2^n a \right) \right. \\ \left. - i^k 2^{1+k+n} e^{i2^{-n}(b+m)} \Phi \left( e^{-2i(b+m)}, -k, 1 - \frac{ia}{2} \right) \right. \\ \left. - i^k 2^{1+k+n} e^{i2^{-n}(1+2^{2+n})(b+m)} \Phi \left( e^{2i(b+m)}, -k, 1 - \frac{ia}{2} \right) \right. \\ \left. + (i2^{-n})^k e^{2i(b+m)} \Phi \left( e^{-i2^{-n}(b+m)}, -k, 1 - i2^n a \right) \right. \\ \left. + (i2^{-n})^k e^{i2^{1-n}(1+2^n)(b+m)} \Phi \left( e^{i2^{-n}(b+m)}, -k, 1 - i2^n a \right) \right)$$

THEOREM 4.111. *From Eq. (22.1.3) in [24] and (5.3.8.4) in [8].*

$$\begin{aligned}
(4.111) \quad & \sum_{j=1}^{\infty} 2^{-j-k} \left( -2 (2^{-j})^k e^{2^{-1-j}m} \left( -\Phi \left( -e^{2^{-1-j}m}, -k, 1 + 2^{1+j} \log(a) \right) \right. \right. \\
& \quad \left. \left. + 2^k e^{2^{-1-j}m} \left( 2^k e^{2^{-j}m} \Phi \left( -e^{2^{-1-j}m}, -k, 1 + 2^{-1+j} \log(a) \right) \right. \right. \right. \\
& \quad \left. \left. \left. - \Phi \left( -e^{2^{-j}m}, -k, 1 + 2^j \log(a) \right) \right) \right) \right) - 2^k \log^k(a) \\
& = - \left( \frac{5a^{-m} (-m)^{-k} \Gamma(1+k, -m \log(a))}{m} + 2^{1-k} e^{m/2} \Phi \left( e^{m/2}, -k, 1 + 2 \log(a) \right) \right. \\
& \quad \left. - 2e^m \left( -\Phi \left( e^m, -k, 1 + \log(a) \right) + 2^k e^m \Phi \left( e^{2m}, -k, 1 + \frac{\log(a)}{2} \right) \right) \right) + \log^k(a)
\end{aligned}$$

THEOREM 4.112. *From Eq. (4.18)*

$$\begin{aligned}
(4.112) \quad & \sum_{p=0}^n 2^p (i2^{-p})^{1+k} e^{-i2^{-1-p}m\pi} \left( -\Phi \left( e^{-i2^{-p}m\pi}, -k, \frac{1}{2} - \frac{i2^p \log(a)}{\pi} \right) \right. \\
& \quad \left. + e^{i2^{-p}m\pi} \Phi \left( e^{i2^{-p}m\pi}, -k, \frac{1}{2} - \frac{i2^p \log(a)}{\pi} \right) \right) \\
& = ie^{-\frac{1}{2}i(4+(2+2^{-n})m)\pi} \left( e^{i2^{-1-n}(2^nk+m)\pi} \left( \Phi \left( e^{-im\pi}, -k, 1 - \frac{i \log(a)}{\pi} \right) \right. \right. \\
& \quad \left. \left. - e^{2im\pi} \Phi \left( e^{im\pi}, -k, 1 - \frac{i \log(a)}{\pi} \right) \right) \right) + (i2^{-1-n})^k e^{im\pi} \left( -\Phi \left( e^{-i2^{-1-n}m\pi}, -k, 1 - \frac{i2^{1+n} \log(a)}{\pi} \right) \right. \\
& \quad \left. + e^{i2^{-n}m\pi} \Phi \left( e^{i2^{-1-n}m\pi}, -k, 1 - \frac{i2^{1+n} \log(a)}{\pi} \right) \right)
\end{aligned}$$

THEOREM 4.113. *From Eqs. (4.19) and (4.20).*

$$\begin{aligned}
(4.113) \quad & \sum_{p=0}^{n-1} (i2^{-p})^k e^{-i2^{-1-p}m\pi} \pi^k \left( -2^p k \Phi \left( e^{-i2^{-p}m\pi}, 1-k, \frac{1}{2} - \frac{i2^p \log(a)}{\pi} \right) \right. \\
& \quad \left. + im\pi \Phi \left( e^{-i2^{-p}m\pi}, -k, \frac{1}{2} - \frac{i2^p \log(a)}{\pi} \right) + e^{i2^{-p}m\pi} \left( 2^p k \Phi \left( e^{i2^{-p}m\pi}, 1-k, \frac{1}{2} - \frac{i2^p \log(a)}{\pi} \right) \right. \right. \\
& \quad \left. \left. + im\pi \Phi \left( e^{i2^{-p}m\pi}, -k, \frac{1}{2} - \frac{i2^p \log(a)}{\pi} \right) \right) \right) \\
& = e^{-im\pi} (i\pi)^k \left( k \Phi \left( e^{-im\pi}, 1-k, 1 - \frac{i \log(a)}{\pi} \right) - im\pi \Phi \left( e^{-im\pi}, -k, 1 - \frac{i \log(a)}{\pi} \right) \right. \\
& \quad \left. - e^{2im\pi} \left( k \Phi \left( e^{im\pi}, 1-k, 1 - \frac{i \log(a)}{\pi} \right) + im\pi \Phi \left( e^{im\pi}, -k, 1 - \frac{i \log(a)}{\pi} \right) \right) \right) \\
& \quad + (i2^{-n})^k e^{-i2^{-n}m\pi} \pi^k \left( -2^n k \Phi \left( e^{-i2^{-n}m\pi}, 1-k, 1 - \frac{i2^n \log(a)}{\pi} \right) \right. \\
& \quad \left. + im\pi \Phi \left( e^{-i2^{-n}m\pi}, -k, 1 - \frac{i2^n \log(a)}{\pi} \right) + e^{i2^{-1-n}m\pi} \left( 2^n k \Phi \left( e^{i2^{-n}m\pi}, 1-k, 1 - \frac{i2^n \log(a)}{\pi} \right) \right. \right. \\
& \quad \left. \left. + im\pi \Phi \left( e^{i2^{-n}m\pi}, -k, 1 - \frac{i2^n \log(a)}{\pi} \right) \right) \right)
\end{aligned}$$

THEOREM 4.114. *From Eqs. (4.21) and (41.12.1) in [24].*

$$(4.114) \quad \begin{aligned} & - \sum_{p=0}^{n-1} (-i2^{-p})^k \left( \zeta \left( -k, \frac{\pi + 3i2^p \log(a)}{6\pi} \right) + \zeta \left( -k, \frac{1}{6} \left( 5 + \frac{3i2^p \log(a)}{\pi} \right) \right) \right) \\ & = e^{-\frac{1}{2}ik\pi} \left( \zeta \left( -k, \frac{1}{3} + \frac{i \log(a)}{2\pi} \right) + \zeta \left( -k, \frac{2}{3} + \frac{i \log(a)}{2\pi} \right) \right) \\ & - (-i2^{-n})^k \left( \zeta \left( -k, \frac{1}{6} \left( 2 + \frac{3i2^n \log(a)}{\pi} \right) \right) + \zeta \left( -k, \frac{1}{6} \left( 4 + \frac{3i2^n \log(a)}{\pi} \right) \right) \right) \end{aligned}$$

THEOREM 4.115. *From Eqs. (4.21) and (41.12.2) in [24].*

$$(4.115) \quad \begin{aligned} & \sum_{p=1}^n (-2^{1+p})^k \left( \zeta \left( -k, \frac{1}{6} \left( 1 - \frac{3 \times 2^{-p} \log(a)}{\pi} \right) \right) + \zeta \left( -k, \frac{1}{6} \left( 5 - \frac{3 \times 2^{-p} \log(a)}{\pi} \right) \right) \right) \\ & = (-2)^k \left( \zeta \left( -k, \frac{1}{3} - \frac{\log(a)}{2\pi} \right) + \zeta \left( -k, \frac{2}{3} - \frac{\log(a)}{2\pi} \right) \right) \\ & - (-2^{1+n})^k \left( \zeta \left( -k, \frac{1}{6} \left( 2 - \frac{3 \times 2^{-n} \log(a)}{\pi} \right) \right) + \zeta \left( -k, \frac{1}{6} \left( 4 - \frac{3 \times 2^{-n} \log(a)}{\pi} \right) \right) \right) \end{aligned}$$

THEOREM 4.116. *From Eq. (5.2.9.5) in [8].*

$$(4.116) \quad \sum_{k=1}^{\infty} \frac{k^k (a \exp(-a))^k}{(k+2)!} = -\frac{-1 + 2a + 2a^2 - 4ae^a + e^{2a}}{4a^2}$$

THEOREM 4.117.

$$(4.117) \quad \sum_{k=1}^{\infty} \frac{k^k (a \exp(-a))^k}{(k+2)!} = -\frac{-1 + 2a + 2a^2 - 4ae^a + e^{2a}}{4a^2}$$

THEOREM 4.118. *From Eqs. (5.24.14) in [24] and (6.3.4.2) in [17].*

$$(4.118) \quad \begin{aligned} & \sum_{n=0}^{\infty} \sum_{p=0}^{\infty} \frac{(1+n)^{-1+n} E_{2p}(x) (-n+a)^{k-n-2p} (-1)^{1+n+2p} (1-k)_{-1+n+2p}}{n! (2p)!} \\ & = \frac{2^k}{k} \left( \zeta \left( -k, \frac{1}{2}(2-x+a) \right) - \zeta \left( -k, \frac{1}{2}(3-x+a) \right) \right) \\ & \quad + \zeta \left( -k, \frac{1}{2}(1+x+a) \right) - \zeta \left( -k, \frac{1}{2}(2+x+a) \right) \end{aligned}$$

THEOREM 4.119. *From Eq. (5.2.11.3) in [8].*

$$(4.119) \quad \sum_{k=0}^{\infty} \frac{\Gamma(1+k+m)x^k}{\Gamma(2+k)} = \frac{(-1 + (1-x)^{-m})\Gamma(m)}{x}$$

THEOREM 4.120.

$$(4.120) \quad \sum_{k=0}^{\infty} \frac{x^k}{(k+1)\Gamma(v-k+1)} = \frac{-1 + (1+x)^{1+v}}{x\Gamma(2+v)}$$

THEOREM 4.121. *Bernoulli generating function. From Eq. (6.3.2) in [17].*

$$(4.121) \quad \sum_{k=0}^{\infty} \frac{(e^{-uy}u)^k B_k(x+ky)}{(k+1)!} \\ = \frac{e^{ux} \left( -(e^u)^{-x+y} u B_{e^u}(x-y, 0) + \Phi(e^u, 2, x-y) \right) - e^{uy} \psi^{(1)}(x-y)}{u}$$

THEOREM 4.122. *Kummer confluent hypergeometric generating function. From Eq. (6.6.1.3) in [17].*

$$(4.122) \quad \sum_{k=0}^{\infty} \frac{(b-a)_k t^k {}_1F_1(a; b+k; x)}{(k+1)! (b)_k} = \int_0^t \exp(s) {}_1F_1(a; b; x-s) \frac{ds}{t}$$

THEOREM 4.123. *From Eq. (5.2.9.9) in [8].*

$$(4.123) \quad \sum_{n=1}^{\infty} \frac{(a-n)^{k-n} (-n)^n (1-k)_{n-1}}{\Gamma(n+4)} \\ = - \frac{-18a^k + \frac{-4a^{3+k} + 4(3+a)^{3+k} + 3(5a^{2+k} - 9(2+a)^{2+k})(3+k) + 18(-a^{1+k} + 3(1+a)^{1+k})(2+k)(3+k)}{(1+k)(2+k)(3+k)}}{108k}$$

THEOREM 4.124. *StruveH and Euler's polynomials. From Eq. (6.4.3.3) in [17].*

$$(4.124) \quad \sum_{j=1}^{\infty} \sum_{n=0}^{\infty} \sum_{p=0}^{\infty} \frac{(-1)^{j+n} 2^{-2n+p} a^{-2n-p} j^{2n} E_p(\alpha)}{\Gamma(\frac{3}{2}+n) \Gamma(1+p) (k)_{-2n-p-v} \Gamma(k) \Gamma(\frac{3}{2}+n+v)} \\ = \frac{2^{-1+2k-2v} a^{1-k+v} \left( -\zeta(1-k+v, \frac{1}{4}(a+2\alpha)) + \zeta(1-k+v, \frac{1}{4}(2+a+2\alpha)) \right)}{\sqrt{\pi} \Gamma(k-v) \Gamma(\frac{3}{2}+v)}$$

THEOREM 4.125. *From Eq. (6.7.1.7) in [17].*

$$(4.125) \quad \sum_{j=0}^{\infty} \sum_{n=0}^{\infty} \frac{a^{-j-n} \Gamma(j+n+\alpha) \Gamma(n+\beta) \Gamma(j+\gamma)}{\Gamma(1+j) (k)_{1-j-n} \Gamma(1+n) \Gamma(c+j+n) \Gamma(\beta) \Gamma(\gamma)} \\ = \sum_{m=0}^{\infty} \frac{a^{-m} \Gamma(m+\alpha) \Gamma(m+\beta+\gamma)}{(k)_{1-m} \Gamma(1+m) \Gamma(c+m) \Gamma(\beta+\gamma)}$$

THEOREM 4.126. *From Eq. (6.4.3.20) in [17].*

$$(4.126) \quad \sum_{j=0}^{\infty} \sum_{m=0}^{\infty} \frac{(-1)^j t^{2j+m} \Gamma(c+j-\alpha) \Gamma(j+m+\alpha) \Gamma(2j+m+\beta) \Gamma(j+\beta-\gamma) \Gamma(j+\gamma)}{\Gamma(1+j) \Gamma(c+j) \Gamma(1-2j+k-m) \Gamma(1+m) \Gamma(c+2j+m) \Gamma(2j+\beta)} \\ = \sum_{p=0}^{\infty} \sum_{n=0}^{\infty} \frac{t^{n+p} \Gamma(n+\alpha) \Gamma(p+\alpha) \Gamma(p+\beta-\gamma) \Gamma(n+\gamma) \Gamma(c-\alpha)}{\Gamma(1+n) \Gamma(c+n) \Gamma(1+k-n-p) \Gamma(1+p) \Gamma(c+p) \Gamma(\alpha)}$$

THEOREM 4.127. *From Eq. (6.9.2.1) in [17].*



$$(4.127) \quad \sum_{j=0}^{\infty} \sum_{l=0}^{\infty} \frac{s^l t^j (-j)_l (-j + \alpha)_l (1 - \beta)_j (\gamma)_l}{\Gamma(1 + j) \Gamma(1 + k - l) \Gamma(1 + l) (1 - \alpha)_j (-j + \beta)_l (\delta)_l}$$

$$= \sum_{n=0}^{\infty} \sum_{m=0}^{\infty} \frac{s^n (-1)^n t^{n+m} (1 - \beta)_m (\gamma)_n}{\Gamma(1 + m) \Gamma(1 + k - n) \Gamma(1 + n) (1 - \alpha)_m (\delta)_n}$$

THEOREM 4.128. *From Eq. (489) pp. 92. in [31]. For  $n$  even.*

$$(4.128) \quad \sum_{r=1}^{\frac{n-2}{2}} \left( e^{\frac{2i\pi m r}{n}} \Phi \left( e^{2im\pi}, -k, \frac{r}{n} + \frac{z}{2} \right) + (-1)^{2m} e^{-\frac{2i\pi m r}{n}} \Phi \left( e^{2im\pi}, -k, \frac{1}{2} \left( -\frac{2r}{n} + z + 2 \right) \right) \right)$$

$$= n^{-k} \Phi \left( e^{\frac{2im\pi}{n}}, -k, \frac{nz}{2} \right) - 2^{-k} \Phi \left( e^{im\pi}, -k, z \right)$$

THEOREM 4.129. *From Eq. (490) pp. 92. in [31]. For  $n$  odd.*

$$(4.129) \quad \sum_{r=1}^{\frac{n-1}{2}} e^{-\frac{i\pi m r}{n}} \left( \Phi \left( e^{im\pi}, -k, \frac{1}{2} \left( a - b - \frac{2r}{n} + 1 \right) \right) \right.$$

$$\left. + e^{\frac{2i\pi m r}{n}} \Phi \left( e^{im\pi}, -k, \frac{1}{2} \left( a - b + \frac{2r}{n} + 1 \right) \right) \right)$$

$$= (-1)^m \Phi \left( e^{im\pi}, -k, \frac{1}{2} (a - b + 1) \right) - n^{-k} i^m \left( \frac{1}{n} + 1 \right) \Phi \left( e^{\frac{im\pi}{n}}, -k, \frac{1}{2} ((a - b)n + 1) \right)$$

THEOREM 4.130. *From Eq. (120) on pp. 71 in [32]. For any positive integer  $n$ .*

$$(4.130) \quad \sum_{r=0}^{n-1} e^{-\frac{i\pi m r}{n}} \left( (-1)^m \Phi \left( e^{im\pi}, -k, a - \frac{2\pi r + t}{2n\pi} + 1 \right) + e^{\frac{im(2\pi r + t)}{n}} \Phi \left( e^{im\pi}, -k, a + \frac{2\pi r + t}{2n\pi} \right) \right)$$

$$= n^{-k} \left( e^{\frac{i\pi m}{n}} \Phi \left( e^{\frac{im\pi}{n}}, -k, an - \frac{t}{2\pi} + 1 \right) + e^{\frac{im t}{n}} \Phi \left( e^{\frac{im\pi}{n}}, -k, an + \frac{t}{2\pi} \right) \right)$$

THEOREM 4.131. *From (41.2.34) in [24] and Eq. (2.4.6.13) in [8].*

$$(4.131) \quad \sum_{p=1}^{n-1} (-1)^p e^{-\frac{m p \pi}{n}} \left( -e^{\frac{2m(-n+p)\pi}{n}} \Phi \left( e^{2m\pi}, -k, \frac{an + p}{2n} \right) \right.$$

$$\left. + \Phi \left( e^{2m\pi}, -k, \frac{1}{2} \left( 2 + a - \frac{p}{n} \right) \right) \right) \sin \left( \frac{p\pi}{n} \right)$$

$$= i 2^{-1-k} e^{\frac{(-i+m-2mn)\pi}{n}} n^{-k} \left( \Phi \left( -e^{\frac{(-i+m)\pi}{n}}, -k, 1 + an \right) - e^{\frac{2i\pi}{n}} \Phi \left( -e^{\frac{(i+m)\pi}{n}}, -k, 1 + an \right) \right)$$

THEOREM 4.132. *From Eq. (41.2.27) in [24] and Eq. (2.4.6.13) in [8].*

$$(4.132) \quad \sum_{p=0}^{n-1} (-1)^p e^{\frac{m p \pi}{n}} \cos \left( \frac{j(1 + 2p)\pi}{2n} \right) \left( \Phi \left( e^{2m\pi}, -k, \frac{1 + 2an + 2p}{4n} \right) \right.$$

$$\left. - e^{\frac{m(-1+2n-2p)\pi}{n}} \Phi \left( e^{2m\pi}, -k, 1 + \frac{a}{2} - \frac{1 + 2p}{4n} \right) \right)$$

$$\begin{aligned}
&= \frac{1}{2} e^{-\frac{m\pi}{2n}} n^{-k} \left( e^{\frac{(-ij+m)\pi}{2n}} \Phi \left( e^{\frac{2(-ij+m)\pi}{n}}, -k, \frac{1}{4}(1+2an) \right) \right. \\
&- e^{\frac{3(-ij+m)\pi}{2n}} \Phi \left( e^{\frac{2(-ij+m)\pi}{n}}, -k, \frac{1}{4}(3+2an) \right) + e^{\frac{(ij+m)\pi}{2n}} \left( \Phi \left( e^{\frac{2(ij+m)\pi}{n}}, -k, \frac{1}{4}(1+2an) \right) \right. \\
&\quad \left. \left. - e^{\frac{(ij+m)\pi}{n}} \Phi \left( e^{\frac{2(ij+m)\pi}{n}}, -k, \frac{1}{4}(3+2an) \right) \right) \right)
\end{aligned}$$

THEOREM 4.133. *From Eq. (37.2.4) in [24] and Eq. (4.3.10) in [13].*

$$\begin{aligned}
(4.133) \quad &\sum_{p=1}^n \frac{1}{2} (i2^{-p})^k e^{i2^{-p}m\pi} \pi^{1+k} \left( 2i\Phi \left( -e^{i2^{-p}m\pi}, -k, 1 - \frac{i2^p \log(a)}{\pi} \right) \right. \\
&+ \Phi \left( -ie^{i2^{-p}m\pi}, -k, 1 - \frac{i2^p \log(a)}{\pi} \right) - \Phi \left( ie^{i2^{-p}m\pi}, -k, 1 - \frac{i2^p \log(a)}{\pi} \right) \Big) \\
&= -i\pi \left( e^{im\pi} (i\pi)^k \Phi \left( -e^{im\pi}, -k, 1 - \frac{i \log(a)}{\pi} \right) \right. \\
&\quad \left. - (i2^{-n})^k e^{i2^{-n}m\pi} \pi^k \Phi \left( -e^{i2^{-n}m\pi}, -k, 1 - \frac{i2^n \log(a)}{\pi} \right) \right)
\end{aligned}$$

THEOREM 4.134. *From Eq. (6.10.6) in [24].*

$$(4.134) \quad \sum_{j=0}^{\infty} \frac{(b+j\alpha)^j (j\alpha+a)^{k-j} (1-k)_{j-1}}{\Gamma(j+1)} = -\frac{(-1)^{-k} e^{-\frac{a+b}{\alpha}} \alpha^k \Gamma(1+k, \frac{b-a}{\alpha})}{k}$$

THEOREM 4.135.

$$(4.135) \quad \sum_{j=0}^{\infty} \frac{(b+j)^j s^j (a+js)^{k-j} (1-k)_{j-1}}{\Gamma(j+1)} = -\frac{(-1)^{-k} e^{b-\frac{a}{s}} s^k \Gamma(1+k, b-\frac{a}{s})}{k}$$

THEOREM 4.136. *Euler-Neumann Generating Functions.*

$$\begin{aligned}
(4.136) \quad &\sum_{n=0}^{\infty} \sum_{p=0}^{\infty} \sum_{q=0}^{\infty} \frac{(-1)^n 2^p (n\alpha + \beta)^{-1+n} E_p(x) (n\alpha + a)^{-1+k-n-p-2q} (-1)^{2+n+p+2q} (1-k)_{n+p+2q}}{n! p! \Gamma(2+2q)} \\
&= \frac{1}{k\beta} \left( -(-1+a+2x-\beta)^k + 2^{1+2k} \left( -\zeta \left( -k, 1 + \frac{1}{4} \log(e^{-1+a+2x-\beta}) \right) \right. \right. \\
&\quad \left. \left. + \zeta \left( -k, \frac{1}{4} (2 + \log(e^{-1+a+2x-\beta})) \right) \right) \right)
\end{aligned}$$

THEOREM 4.137. *From Eq. (5.2.11.17) in [8].*

$$(4.137) \quad \sum_{p=0}^{\infty} \sum_{q=0}^{\infty} \frac{\left(-\frac{1}{a}\right)^{p+q} (\Gamma(1+p-v)\Gamma(q+v)(1-k)_{-1+p+q})}{\Gamma(1+p)\Gamma(1+q)} = -\frac{e^a \pi \csc(\pi v) \Gamma(1+k, a)}{a^k k}$$

THEOREM 4.138.

$$(4.138) \quad \sum_{k=0}^{\infty} \frac{(k+2)^k (y \exp(-y))^{k+1}}{(k+2)!} = -\frac{1}{2} e^y (-2 + 2e^{-y} + y)$$

THEOREM 4.139.

$$(4.139) \quad \sum_{k=0}^{\infty} \frac{a^k E_k(x)}{(k+1)!} = \frac{2e^{ax} {}_2F_1(1, x; 1+x; -e^a) + x(\psi^{(0)}(\frac{x}{2}) - \psi^{(0)}(\frac{1+x}{2}))}{ax}$$

THEOREM 4.140. *From Eq. (21) in [33].*

$$(4.140) \quad \sum_{n=0}^{\infty} \frac{(1+a)_n {}_2F_1(-n, 1+a+b+n; 1+a; \frac{1-x}{2}) z^n}{(n+1)!} \\ = \int_0^z \frac{2^{a+b} (1-s + \sqrt{1+s^2-2sx})^{-a} (1+s + \sqrt{1+s^2-2sx})^{-b}}{\sqrt{1+s^2-2sxz}} ds$$

THEOREM 4.141. *From Eq. (5.2.9.6) in [8].*

$$(4.141) \quad \sum_{j=1}^{\infty} \frac{(1-k)_{j-1} (-j)^{1+j} (t-j)^{-j+k}}{\Gamma(j+2)} = \frac{e^t \Gamma(2+k, t) - (1+t)^{1+k}}{k(1+k)}$$

THEOREM 4.142. *From Eq. (17.3.14) in [24].*

$$(4.142) \quad \sum_{p=0}^{\infty} (-1)^p a^{-2ip\alpha} \cos(x+2px) (-i(m+\alpha+2p\alpha))^{-1-k} \Gamma(1+k, -i(m+\alpha+2p\alpha) \log(a)) \\ + a^{2i(1+2p)\alpha} (-i(m-(1+2p)\alpha))^{-1-k} \Gamma(1+k, -i(m-(1+2p)\alpha) \log(a)) \\ = -\frac{1}{2} i a^{i(m+\alpha)} e^{\frac{im(\pi-2x)}{2\alpha}} \pi^{1+k} \left(\frac{1}{\alpha}\right)^{1+k} \left( \Phi\left(-e^{\frac{im\pi}{\alpha}}, -k, \frac{\pi-2x+2\alpha \log(a)}{2\pi}\right) \right. \\ \left. + e^{\frac{2imx}{\alpha}} \Phi\left(-e^{\frac{im\pi}{\alpha}}, -k, \frac{\pi+2x+2\alpha \log(a)}{2\pi}\right) \right)$$

THEOREM 4.143. *From Exercise vii (f) (p.135) no. 20 in [34].*

$$(4.143) \quad -\sum_{p=1}^n (i3^p)^k e^{2i3^{-1+p}m} \left( \Phi\left(e^{2i3^p m}, -k, \frac{1}{3} - \frac{1}{2} i3^{-p} \log(a)\right) \right. \\ \left. + e^{2i3^{-1+p}m} \Phi\left(e^{2i3^p m}, -k, \frac{2}{3} - \frac{1}{2} i3^{-p} \log(a)\right) \right) \\ = \left( -i^k e^{2im} \Phi\left(e^{2im}, -k, 1 - \frac{1}{2} i \log(a)\right) \right. \\ \left. + (i3^n)^k e^{2i3^n m} \Phi\left(e^{2i3^n m}, -k, 1 - \frac{1}{2} i3^{-n} \log(a)\right) \right)$$

THEOREM 4.144.

$$\begin{aligned}
(4.144) \quad & \sum_{p=1}^n (i3^{-p})^{1+k} \left( \sqrt[3]{-1} e^{i3^{-p}\pi r} \Phi \left( -\sqrt[3]{-1} e^{i3^{-p}\pi r}, -k, 1 + 3^p a \right) \right. \\
& \quad \left. + e^{\pi(-\frac{i}{3} + i3^{-p}r)} \Phi \left( (-1)^{2/3} e^{i3^{-p}\pi r}, -k, 1 + 3^p a \right) \right) \\
& = -ie^{\frac{1}{2}i\pi(k+2r)} \Phi \left( e^{i\pi r}, -k, 1 + a \right) + (i3^{-n})^{1+k} e^{i3^{-n}\pi r} \Phi \left( e^{i3^{-n}\pi r}, -k, 1 + 3^n a \right)
\end{aligned}$$

THEOREM 4.145.

$$\begin{aligned}
(4.145) \quad & \sum_{p=1}^n (i3^{-p})^k e^{2i3^{-1-p}m} \left( \Phi \left( e^{2i3^{-p}m}, -k, \frac{1}{3} - \frac{1}{2}i3^p \log(a) \right) \right. \\
& \quad \left. + e^{2i3^{-1-p}m} \Phi \left( e^{2i3^{-p}m}, -k, \frac{2}{3} - \frac{1}{2}i3^p \log(a) \right) \right) \\
& = - \left( \left( \frac{i}{3} \right)^k e^{\frac{2im}{3}} \Phi \left( e^{\frac{2im}{3}}, -k, 1 - \frac{3}{2}i \log(a) \right) \right. \\
& \quad \left. - (i3^{-1-n})^k e^{2i3^{-1-n}m} \Phi \left( e^{2i3^{-1-n}m}, -k, 1 - \frac{1}{2}i3^{1+n} \log(a) \right) \right)
\end{aligned}$$

THEOREM 4.146.

$$\begin{aligned}
(4.146) \quad & \sum_{p=1}^n 3^p (i3^p)^k \left( (-1)^{5/6} e^{i3^p\pi r} \Phi \left( -\sqrt[3]{-1} e^{i3^p\pi r}, -k, 1 + 3^{-p}a \right) \right. \\
& \quad \left. + ie^{\frac{1}{3}i\pi(-1+3^{1+p}r)} \Phi \left( (-1)^{2/3} e^{i3^p\pi r}, -k, 1 + 3^{-p}a \right) \right) \\
& = 3i \left( (3i)^k e^{3i\pi r} \Phi \left( e^{3i\pi r}, -k, 1 + \frac{a}{3} \right) \right. \\
& \quad \left. - 3^n (i3^{1+n})^k e^{i3^{1+n}\pi r} \Phi \left( e^{i3^{1+n}\pi r}, -k, 1 + 3^{-1-n}a \right) \right)
\end{aligned}$$

THEOREM 4.147. *From Eq. (18) on pp. 292 in [35].*

$$\begin{aligned}
(4.147) \quad & \sum_{p=1}^n (i3^p)^k e^{i3^{-1+p}m} \left( \Phi \left( e^{2i3^p m}, -k, \frac{1}{6} - \frac{1}{2}i3^{-p} \log(a) \right) \right. \\
& \quad \left. + e^{4i3^{-1+p}m} \Phi \left( e^{2i3^p m}, -k, \frac{5}{6} - \frac{1}{2}i3^{-p} \log(a) \right) \right) \\
& = - \left( -i^k e^{im} \Phi \left( e^{2im}, -k, \frac{1}{2} - \frac{1}{2}i \log(a) \right) \right. \\
& \quad \left. + (i3^n)^k e^{i3^n m} \Phi \left( e^{2i3^n m}, -k, \frac{1}{2} - \frac{1}{2}i3^{-n} \log(a) \right) \right)
\end{aligned}$$

THEOREM 4.148. *From Eq. (18) on pp. 292 in [35].*

$$(4.148) \quad \sum_{p=1}^n (i3^{-p})^{1+k} e^{3^{-p}m} \left( (-1)^{2/3} \Phi \left( \sqrt[3]{-1} e^{3^{-p}m}, -k, 1 + 3^p a \right) \right)$$

$$\begin{aligned}
& +\Phi\left(-(-1)^{2/3}e^{3^{-p}m}, -k, 1+3^pa\right) \\
& = (-1)^{5/6}3^{-n}\left(-i^k3^ne^m\Phi\left(-e^m, -k, 1+a\right)\right. \\
& \quad \left.+ (i3^{-n})^k e^{3^{-n}m}\Phi\left(-e^{3^{-n}m}, -k, 1+3^na\right)\right)
\end{aligned}$$

THEOREM 4.149. *From Eq. (18) on pp. 292 in [35].*

$$\begin{aligned}
(4.149) \quad & \sum_{p=1}^n 3^p \left( a^k + \sqrt[3]{-1} (i3^p)^k e^{i3^pm} \left( \Phi\left(\sqrt[3]{-1}e^{i3^pm}, -k, 1-i3^{-p}a\right) \right. \right. \\
& \quad \left. \left. - \sqrt[3]{-1}\Phi\left(-(-1)^{2/3}e^{i3^pm}, -k, 1-i3^{-p}a\right)\right) \right) \\
& = \frac{3}{2} \left( (-1+3^n)a^k + 2(3i)^k e^{3im}\Phi\left(-e^{3im}, -k, 1-\frac{ia}{3}\right) \right. \\
& \quad \left. - 2 \times 3^n (i3^{1+n})^k e^{i3^{1+n}m}\Phi\left(-e^{i3^{1+n}m}, -k, 1-i3^{-1-n}a\right) \right)
\end{aligned}$$

THEOREM 4.150. *From Eq. (18) on pp. 292 in [35].*

$$\begin{aligned}
(4.150) \quad & -\sum_{p=1}^n (i3^{-p})^k e^{i3^{-1-p}m} \left( \Phi\left(e^{2i3^{-p}m}, -k, \frac{1}{6} + \frac{3^pa}{2}\right) \right. \\
& \quad \left. + e^{4i3^{-1-p}m}\Phi\left(e^{2i3^{-p}m}, -k, \frac{5}{6} + \frac{3^pa}{2}\right) \right) \\
& = \left(\frac{i}{3}\right)^k e^{\frac{im}{3}}\Phi\left(e^{\frac{2im}{3}}, -k, \frac{1}{2} + \frac{3a}{2}\right) \\
& \quad - (i3^{-1-n})^k e^{i3^{-1-n}m}\Phi\left(e^{2i3^{-1-n}m}, -k, \frac{1}{2}(1+3^{1+n}a)\right)
\end{aligned}$$

THEOREM 4.151. *From Eq. (17.3.14) in [24].*

$$\begin{aligned}
(4.151) \quad & \sum_{p=0}^{\infty} (-1)^p a^{-2ip\alpha} \cos(x+2px) \left(-i(m+\alpha+2p\alpha)\right)^{-1-k} \Gamma(1+k, -i(m+\alpha+2p\alpha)\log(a)) \\
& \quad + a^{2i(1+2p)\alpha} \left(-i(m-(1+2p)\alpha)\right)^{-1-k} \Gamma(1+k, -i(m-(1+2p)\alpha)\log(a)) \\
& = -\frac{1}{2} ia^{i(m+\alpha)} e^{\frac{im(\pi-2x)}{2\alpha}} \pi^{1+k} \left(\frac{1}{\alpha}\right)^{1+k} \left( \Phi\left(-e^{\frac{im\pi}{\alpha}}, -k, \frac{\pi-2x+2\alpha\log(a)}{2\pi}\right) \right. \\
& \quad \left. + e^{\frac{2imx}{\alpha}} \Phi\left(-e^{\frac{im\pi}{\alpha}}, -k, \frac{\pi+2x+2\alpha\log(a)}{2\pi}\right) \right)
\end{aligned}$$

THEOREM 4.152. *From Eq. (6.1.62) in [24]*

$$(4.152) \quad \sum_{p=0}^{\infty} (-1)^p a^{-m-\frac{1}{2}(1+2p)\beta} \left( a^{\beta+2p\beta} (-2m+\beta+2p\beta)^{-1-k} \Gamma\left(1+k, \frac{1}{2}(-2m+\beta+2p\beta)\log(a)\right) \right)$$

$$\begin{aligned} & -(-2m - (1 + 2p)\beta)^{-1-k} \Gamma\left(1 + k, -\frac{1}{2}(2m + \beta + 2p\beta) \log(a)\right) \\ & = -ie^{\frac{im\pi}{\beta}} \left(\frac{\pi i}{\beta}\right)^{1+k} \Phi\left(-e^{\frac{2im\pi}{\beta}}, -k, \frac{\pi - i\beta \log(a)}{2\pi}\right) \end{aligned}$$

THEOREM 4.153. *From Eq. (37.2.2) in [24].*

$$\begin{aligned} (4.153) \quad & \sum_{p=1}^n 2^k (i2^{-p})^{1+k} e^{i2^{1-p}m} \left( \Phi\left(e^{i2^{1-p}m}, -k, \frac{1}{4} - i2^{-1+p} \log(a)\right) \right. \\ & \quad + e^{i2^{-p}m} \Phi\left(e^{i2^{1-p}m}, -k, \frac{3}{4} - i2^{-1+p} \log(a)\right) \\ & \quad \left. - 2e^{i2^{1-p}m} \Phi\left(e^{i2^{1-p}m}, -k, \frac{1}{2}(1 - i2^p \log(a))\right) \right) \\ & = -i2^{-n} \left( 2^n e^{\frac{1}{2}i(m+k\pi)} \Phi\left(e^{im}, -k, \frac{1}{2} - i \log(a)\right) \right. \\ & \quad \left. - (i2^{-n})^k e^{i2^{1-n}m} \Phi\left(e^{i2^{-n}m}, -k, \frac{1}{2} - i2^n \log(a)\right) \right) \end{aligned}$$

THEOREM 4.154. *From Eq. (37.2.2) in [24].*

$$\begin{aligned} (4.154) \quad & \sum_{p=1}^n (i2^p)^k e^{i2^p m} \left( 2i\Phi\left(-e^{i2^p m}, -k, 1 + 2^{-p}a\right) + \Phi\left(-ie^{i2^p m}, -k, 1 + 2^{-p}a\right) \right. \\ & \quad \left. - \Phi\left(ie^{i2^p m}, -k, 1 + 2^{-p}a\right) \right) \\ & = 2i \left( (2i)^k e^{2im} \Phi\left(-e^{2im}, -k, 1 + \frac{a}{2}\right) \right. \\ & \quad \left. - (i2^{1+n})^k e^{i2^{1+n}m} \Phi\left(-e^{i2^{1+n}m}, -k, 1 + 2^{-1-n}a\right) \right) \end{aligned}$$

THEOREM 4.155. *From Eq. (7.10) pp. 119 in [36].*

$$\begin{aligned} (4.155) \quad & \sum_{p=1}^{2n} (-1)^p e^{\frac{ip\pi}{n}} \Phi\left(-e^{i(m+\frac{p\pi}{n})}, -k, a\right) \\ & = (-1)^{n+1} e^{im(-1+n)} (2n)^{1+k} \Phi\left(e^{2imn}, -k, \frac{-1+a+n}{2n}\right) \end{aligned}$$

THEOREM 4.156. *From Eq. (4.43) and Eq. (41.12.2) in [24].*

$$\begin{aligned} (4.156) \quad & \sum_{p=0}^n (2^p)^{1+k} \left( -\zeta(-k, 3 \times 2^{-p}a) + 3^k \left( \zeta(-k, 2^{-p}a) + \zeta\left(-k, \frac{1}{6} + 2^{-p}a\right) + \zeta\left(-k, \frac{5}{6} + 2^{-p}a\right) \right) \right) \\ & = 2^{-k} \left( -3^k \zeta(-k, 2a) + \zeta(-k, 6a) + 2^{1+k+n} (2^n)^k (3^k \zeta(-k, 2^{-n}a) - \zeta(-k, 3 \times 2^{-n}a)) \right) \end{aligned}$$

THEOREM 4.157. Eq. (5.11.2.13) in [16].

$$(4.157) \quad \sum_{k=0}^{\infty} \frac{(1+ak)^k (e^{-az}z)^k L_k^\alpha\left(\frac{x}{1+ak}\right)}{(1+\alpha)_k} = \frac{e^z(xz)^{-\frac{\alpha}{2}} J_\alpha(2\sqrt{xz}) \Gamma(1+\alpha)}{1-az}$$

THEOREM 4.158. From Eq. (4.157) and section (7) in [2]. Finite Hankel transform distribution similar forms in [42]

$$(4.158) \quad \sum_{k=0}^{\infty} \frac{(1+ak)^k (e^{-az}z)^k L_k^\alpha\left(\frac{x}{1+ak}\right)}{(k+\alpha+1)!} \\ = e^{az(1+\alpha)} z^{-1-\alpha} \int_0^z \frac{e^{-t(-1+a+a\alpha)} t^{1+\alpha} (tx)^{-\frac{\alpha}{2}} J_\alpha(2\sqrt{tx})}{t} dt$$

THEOREM 4.159. Eq. (5.11.2.14) in [16]

$$(4.159) \quad \sum_{k=0}^{\infty} \frac{(1+ak)^{-1+k} (e^{-az}z)^k L_k^\alpha\left(\frac{x}{1+ak}\right)}{(k+\alpha)!} = \frac{e^z {}_1F_2\left(\frac{1}{a}; 1+\frac{1}{a}, 1+\alpha; -xz\right)}{\Gamma(1+\alpha)}$$

THEOREM 4.160. From Eq. (4.159) and section (7) in [2]

$$(4.160) \quad \sum_{k=0}^{\infty} \frac{(1+ak)^{-1+k} (e^{-az}z)^k L_k^\alpha\left(\frac{x}{1+ak}\right)}{(k+\alpha+1)!} \\ = - \left( e^{az(1+\alpha)} z^{-1-\alpha} \right) \int_0^z \frac{e^{-t(-1+a+a\alpha)} t^\alpha (-1+at) {}_1F_2\left(\frac{1}{a}; 1+\frac{1}{a}, 1+\alpha; -tx\right)}{\Gamma(1+\alpha)} dt$$

THEOREM 4.161. From Eq. (5.11.4.6) in [16] and section (7) in [2]

$$(4.161) \quad \sum_{k=0}^{\infty} \frac{L_k^{k\alpha+\beta}(x) \left(\frac{v}{(1+v)^{\alpha+1}}\right)^k}{k+1} \\ = \frac{e^x(1+v)}{v} \left( (1+v)^\alpha x^{\alpha-\beta} \Gamma(-\alpha+\beta, x) \right. \\ \left. - (1+v)^\beta ((1+v)x)^{\alpha-\beta} \Gamma(-\alpha+\beta, (1+v)x) \right)$$

THEOREM 4.162. From Eq. (48.17.2) in [24] and section (7) in [2]. Extended Toscano Laguerre-form.

$$(4.162) \quad \sum_{k=0}^{\infty} \frac{4^{-k} (1-v^2)^k L_k^{c+k}(x)}{k+1} = \frac{2e^x \left( -2E_{2-c}(x) + 2^c \left(\frac{1}{1+v}\right)^{-1+c} E_{2-c}\left(\frac{2x}{1+v}\right) \right)}{-1+v^2}$$

THEOREM 4.163. From Eq. (66.4.1) in [24] and section (7) in [2]

$$(4.163) \quad \sum_{k=0}^{\infty} \frac{(v(1+v)^{-1-c})^k {}_1F_1(-k; a+ck; x) (a)_{k+ck}}{(k+1)! (a)_{ck}}$$

$$= \frac{e^x \left( (1+v)^{1+c} E_{2-a+c}(x) - (1+v)^a E_{2-a+c}((1+v)x) \right)}{v}$$

THEOREM 4.164. *From Eq. (48.19.14) in [24] and section (7) in [2]*

$$(4.164) \quad \sum_{k=0}^{\infty} \frac{4^{-k} (-1+v^2)^k L_{k+m}^{-1-2k-2m}(x) (1+m)_k}{(k+1)!} = \int_1^v \frac{2e^{\frac{1}{2}(1-t)x} t^{-2m} L_m^{-1-2m}(tx)}{-1+v^2} dt$$

4.2.1. *The Gegenbauer polynomials.*

THEOREM 4.165. *From Eq. (5.13.12) in [16] and section (7) in [2]*

$$(4.165) \quad \sum_{k=0}^{\infty} \frac{(b^2 + (1+ak)^2)^{k/2} (e^{-az} z)^k C_k^{(v)} \left( \frac{1+ak}{\sqrt{b^2+(1+ak)^2}} \right)}{(k+2v)!} \\ = e^{2avz} z^{-2v} \int_0^z \frac{e^{t-2atv} t^{2v} {}_0F_1 \left( ; \frac{1}{2} + v; -\frac{1}{4} b^2 t^2 \right)}{t \Gamma(2v)} dt$$

THEOREM 4.166. *From Eq. (5.13.13) in [16] and section (7) in [2]*

$$(4.166) \quad \sum_{k=0}^{\infty} \frac{(1+ak)^{-1+\frac{k}{2}} (1+b+ak)^{k/2} (e^{-az} z)^k C_k^{(v)} \left( \frac{2+b+2ak}{2\sqrt{(1+ak)(1+b+ak)}} \right)}{(k+2v)!} \\ = -e^{2avz} z^{-2v} \int_0^z \frac{e^{t-2atv} t^{-1+2v} (-1+at) {}_2F_2 \left( \frac{1}{a}, v; 1 + \frac{1}{a}, 2v; bt \right)}{\Gamma(2v)} dt$$

where  $Im(z) \neq 0$

THEOREM 4.167. *From Eq. (5.13.14) in [16] and section (7) in [2]*

$$(4.167) \quad \sum_{k=0}^{\infty} \frac{(-4b + (1+ak)^2)^{k/2} (e^{-az} z)^k C_k^{(v)} \left( \frac{1+ak}{\sqrt{-4b+(1+ak)^2}} \right)}{(1+ak)(k+2v)!} \\ = -e^{2avz} z^{-2v} \int_0^z \frac{e^{t-2atv} t^{-1+2v} (-1+at) {}_1F_2 \left( \frac{1}{2a}; 1 + \frac{1}{2a}, \frac{1}{2} + v; bt^2 \right)}{\Gamma(2v)} dt$$

where  $Im(a) \neq 0, Im(z) \neq 0$

THEOREM 4.168. *From Eq. (5.24.14) in [24] and section (7) in [2]*

$$(4.168) \quad \sum_{k=0}^{\infty} \frac{(k+1)^{k-1} (y \exp(-y))^k}{(k+1)!} = -\frac{1}{2} e^y (-2+y)$$

THEOREM 4.169. *From Eq. (5.13.22) in [24] and section (7) in [2]*

$$(4.169) \quad \sum_{k=0}^{\infty} \frac{(k+2)^k (e^{-y} y)^{k+1}}{(k+2)!} = \frac{1}{2} (-e^y y + 2e^y - 2)$$



THEOREM 4.170. From Eq. (5.13.20) in [24] and Eq. (6.3.4.2(a)) in [17].

$$\begin{aligned}
(4.170) \quad & \sum_{n=0}^{\infty} \sum_{p=1}^{\infty} \frac{(-1)^{2n+p} (a-p)^{k-2n-p} p^{-1+p} E_{2n}(x) (1-k)_{-1+2n+p}}{(2n)! \Gamma(2+p)} \\
&= -\frac{2^{-1+k}}{k(1+k)} \left( 4\zeta \left( -1-k, \frac{1}{2}(1+a-x) \right) - 8\zeta \left( -1-k, \frac{1}{2}(2+a-x) \right) \right. \\
&+ 4\zeta \left( -1-k, \frac{1}{2}(3+a-x) \right) + 4\zeta \left( -1-k, \frac{a+x}{2} \right) - 8\zeta \left( -1-k, \frac{1}{2}(1+a+x) \right) \\
&+ 4\zeta \left( -1-k, \frac{1}{2}(2+a+x) \right) + (1+k) \left( k \left( \zeta \left( 1-k, \frac{1}{2}(1+a-x) \right) \right. \right. \\
&- \zeta \left( 1-k, \frac{1}{2}(2+a-x) \right) + \zeta \left( 1-k, \frac{a+x}{2} \right) - \zeta \left( 1-k, \frac{1}{2}(1+a+x) \right) \Big) \\
&+ 2 \left( \zeta \left( -k, \frac{1}{2}(1+a-x) \right) - \zeta \left( -k, \frac{1}{2}(2+a-x) \right) + \zeta \left( -k, \frac{a+x}{2} \right) \right. \\
&\quad \left. \left. - \zeta \left( -k, \frac{1}{2}(1+a+x) \right) \right) \right)
\end{aligned}$$

THEOREM 4.171. From Eq. (5.13.20) in [24] and section (7) in [2]

$$(4.171) \quad \sum_{k=1}^{\infty} \frac{k^{k-1} (y \exp(-y))^k}{(k+1)!} = \frac{1 - e^y + y + y^2}{y}$$

THEOREM 4.172. From Eq. (45.4.2) in [24] and section (7) in [2]

$$\begin{aligned}
(4.172) \quad & \sum_{k=0}^{\infty} \frac{(v(1+v)^{-1-c})^k P_k^{(a+ck, b-k-ck)}(x)}{k+n} \\
&= \frac{(1+v)^{(1+c)n}}{2n(1+n)} \left( 2(1+n) F_1 \left( n; -a+n+cn, a+b; 1+n; -v, \frac{1}{2}v(-1+x) \right) \right. \\
&\quad \left. + nv(-1+x) F_1 \left( 1+n; -a+n+cn, 1+a+b; 2+n; -v, \frac{1}{2}v(-1+x) \right) \right)
\end{aligned}$$

THEOREM 4.173. From Eq. (45.4.3) in [24] and section (7) in [2]

$$\begin{aligned}
(4.173) \quad & \sum_{k=0}^{\infty} \frac{((1-z)^{-1-c} z)^k P_k^{(a-k-ck, b+ck)}(x)}{k+n} \\
&= \frac{(1-z)^{(1+c)n}}{2n(1+n)} \left( 2(1+n) F_1 \left( n; -b+n+cn, a+b; 1+n; z, \frac{1}{2}(1+x)z \right) \right. \\
&\quad \left. + n(1+x)z F_1 \left( 1+n; -b+n+cn, 1+a+b; 2+n; z, \frac{1}{2}(1+x)z \right) \right)
\end{aligned}$$

THEOREM 4.174. From Eq. (45.4.4) in [24] and section (7) in [2]

$$(4.174) \quad \sum_{k=0}^{\infty} \frac{2^k \left( -\frac{w(1+w)^{-c}}{-1+x} \right)^k P_k^{(a-k, b-ck)}(x)}{k+n}$$

$$= \frac{(1+w)^{cn}}{n(1+n)} \left( (1+n)F_1 \left( n; a+b+cn, -a; 1+n; -w, \frac{2w}{-1+x} \right) - nwF_1 \left( 1+n; 1+a+b+cn, -a; 2+n; -w, \frac{2w}{-1+x} \right) \right)$$

THEOREM 4.175. *From Eq. (45.4.5) in [24] and section (7) in [2]*

$$(4.175) \quad \sum_{k=0}^{\infty} \frac{2^k \left( \frac{(1-u)^{-cu}}{1+x} \right)^k F_k^{(a-ck, b-k)}(x)}{k+n} \\ = \frac{(1-u)^{cn}}{n(1+n)} \left( (1+n)F_1 \left( n; a+b+cn, -b; 1+n; u, \frac{2u}{1+x} \right) + nuF_1 \left( 1+n; 1+a+b+cn, -b; 2+n; u, \frac{2u}{1+x} \right) \right)$$

THEOREM 4.176. *From Eq. (57.14.8) in [24] and section (7) in [2]*

$$(4.176) \quad \sum_{k=0}^{\infty} \frac{4^{-2k} J_{a+2k}(z)(z \sin(2t))^{2k}}{(k+1)!(1+a)_k} \\ = \csc^2(2t) \int_0^t 2^{2+2a} J_a(z \cos(s)) J_a(z \sin(s)) \cos(2s) \Gamma(1+a) \sin(2s) (z \sin(2s))^{-a} ds$$

THEOREM 4.177. *From Eq. (65.4.4) in [24] and section (7) in [2]*

$$(4.177) \quad \sum_{k=0}^{\infty} \frac{(v(1+v)^{-1-c})^k {}_2F_1(a, -k; b+ck; x)(b)_{k+ck}}{(k+1)!(b)_{ck}} \\ = \frac{(1+v)x}{(-1+a)v(-1+x)^2} \left( (1+v)^c \left( \frac{x}{-1+x} \right)^{-b+c} {}_2F_1 \left( 1-a, 2-b+c; 2-a; \frac{1}{1-x} \right) - (1+v)^b \left( \frac{(1+v)x}{-1+x} \right)^{-b+c} (1+vx)^{1-a} {}_2F_1 \left( 1-a, 2-b+c; 2-a; \frac{1+vx}{1-x} \right) \right)$$

THEOREM 4.178. *From Eq. (65.4.2) in [24] and section (7) in [2]*

$$(4.178) \quad \sum_{k=0}^{\infty} \frac{4^{-k} \left( x^2 \left( 1 + \frac{1}{-1+x} + x \right)^k + (u-x)(u+x) \left( \frac{-u^2+x^2}{-1+x} \right)^k \right)}{(u-x)(u+x)\Gamma(2+k)(c)_{2k}} \\ \times {}_2F_1(-a+c, -b+c+k; c+2k; x)(a)_{2k}(b)_k \\ = \int_0^u \frac{2t(1-x)^{a+b-c} F_1 \left( a; b, b; c; \frac{t+x}{2}, \frac{1}{2}(-t+x) \right)}{u^2-x^2} dt$$

## 5. Special cases in terms of special functions and fundamental constants

The constants used in this section are; Stieltjes constant  $\gamma_n$  given in Eq. (25.2.5) in [3], Glaisher's constant  $A$  given in Eq. (5.17.7) in [3], Harmonic number function

$H_n$  given in Eq.(25.11.33) in [3], Catalan's constant  $C$  given in Eq.(25.11.40) in [3], Euler's constant  $\gamma$  given in Eq. (5.4.11) in [3], Polygamma Functions  $\psi^{(n)}(z)$  given in section (5.15) in [3],  $q$ -digamma function  $\psi_q(z)$  given on pp. 91-101 in [37], the the  $q$ -Pochhammer symbol  $(a; q)_n$  given on pp. 261-286 in [39].

### 5.1. Definite integrals.

EXAMPLE 5.1. Malmsten integral see Exercise 35 on pp. 80 in [43].

$$\begin{aligned}
 (5.1) \quad & \int_1^\infty \frac{x^2 \log(\log(x)) \left( x^{m/n} + \left( \frac{1}{x} \right)^{m/n} \right)}{(x^2 + 1)^3} dx \\
 &= \frac{i\pi}{32\pi n^2} \left( 8mngd \left( \frac{i\pi m}{2n} \right) + \pi(m-n)(m+n) \right. \\
 &\quad \left. \left( H_{\frac{1}{4} \left( \frac{m}{n} - 1 \right)} - H_{\frac{m+n}{4n}} - (\pi - 2i \log(\pi)) \sec \left( \frac{\pi m}{2n} \right) \right) \right. \\
 &\quad \left. + 2\pi n(3m - 2n) - 4e^{\frac{i\pi m}{2n}} \left( \pi^2(n-m)(m+n) \Phi' \left( -e^{\frac{i\pi m}{n}}, 0, \frac{1}{2} \right) \right. \right. \\
 &\quad \left. \left. + n^2 \Phi \left( -e^{\frac{i\pi m}{n}}, 2, \frac{1}{2} \right) \right) \right)
 \end{aligned}$$

EXAMPLE 5.2.

$$\begin{aligned}
 (5.2) \quad & \int_0^\infty \frac{x^{-m-q} (x^m - x^q) \Gamma(b+x)}{\Gamma(1+b+n+x) \log \left( \frac{1}{x} \right)} dx \\
 &= \frac{\sum_{p=0}^{\infty} \left( e^{im\pi} (b+p)^{-m} \Phi \left( e^{2im\pi}, 1, \frac{\pi+i \log(b+p)}{2\pi} \right) - e^{iq\pi} (b+p)^{-q} \Phi \left( e^{2iq\pi}, 1, \frac{\pi+i \log(b+p)}{2\pi} \right) \right) (-n)_p}{p! \Gamma(1+n)}
 \end{aligned}$$

EXAMPLE 5.3.

$$\begin{aligned}
 (5.3) \quad & \int_0^\infty \frac{(-1 + \sqrt[4]{x}) \Gamma(1+x)}{\sqrt{x} \Gamma(5+x) \log \left( \frac{1}{x} \right)} dx \\
 &= \frac{\sum_{p=0}^{\infty} i \left( \Phi \left( -1, 1, \frac{\pi+i \log(1+p)}{2\pi} \right) + (-1)^{3/4} \sqrt[4]{1+p} \Phi \left( i, 1, \frac{\pi+i \log(1+p)}{2\pi} \right) \right) (-3)_p}{6\sqrt{1+pp!}}
 \end{aligned}$$

EXAMPLE 5.4.

$$\begin{aligned}
 (5.4) \quad & \int_0^\infty \frac{\Gamma \left( \frac{1}{3} + x \right) \log^k \left( \frac{1}{x} \right)}{\sqrt{x} \Gamma \left( \frac{10}{3} + x \right)} dx \\
 &= \frac{\sum_{p=0}^{\infty} (4i)^k \pi^{1+k} \left( \zeta \left( -k, \frac{\pi+i \log(\frac{1}{3}+p)}{4\pi} \right) - \zeta \left( -k, \frac{3}{4} + \frac{i \log(\frac{1}{3}+p)}{4\pi} \right) \right) (-2)_p}{\sqrt{\frac{1}{3} + pp!}}
 \end{aligned}$$

EXAMPLE 5.5.

$$(5.5) \quad \int_0^\infty \frac{\Gamma(b+x) \log^k \left( \frac{a}{x} \right)}{\sqrt{x} \Gamma(1+b+n+x)} dx$$

$$= \sum_{p=0}^{\infty} \frac{2^{1+2k} e^{\frac{ik\pi}{2}} \pi^k \Gamma(-n+p) \left( -\zeta \left( -k, \frac{\pi-i \log(a)+i \log(b+p)}{4\pi} \right) + \zeta \left( -k, \frac{3\pi-i \log(a)+i \log(b+p)}{4\pi} \right) \right) \sin(n\pi)}{\sqrt{b+p} \Gamma(1+p)}$$

EXAMPLE 5.6.

$$(5.6) \quad \int_0^{\infty} \frac{x^{-m} \Gamma(b+x)}{\Gamma(1+b+n+x) (a^2+c^2+2ic \log(x) - \log^2(x))} dx$$

$$= \sum_{p=0}^{\infty} \frac{e^{im\pi} (b+p)^{-m} \left( \Phi \left( e^{2im\pi}, 1, \frac{\pi-i(-a+ic)+i \log(b+p)}{2\pi} \right) - \Phi \left( e^{2im\pi}, 1, \frac{\pi-i(a+ic)+i \log(b+p)}{2\pi} \right) \right) (-n)_p}{2ap! \Gamma(1+n)}$$

EXAMPLE 5.7.

$$(5.7) \quad \int_0^{\infty} \frac{\log(\log(\frac{1}{x}))}{\sqrt{x}(1+x)(2+x)(3+x)(4+x)} dx$$

$$= \frac{\pi}{24\sqrt{2}} \left( i(-6+\sqrt{2}+2\sqrt{6})\pi + \sqrt{2} \log(16) + \sqrt{6} \log(256) - 2 \log(4096) \right.$$

$$\quad \left. + 2(-6+\sqrt{2}+2\sqrt{6}) \log(\pi) + 8\sqrt{2} \log \left( \frac{\Gamma(\frac{3}{4})}{\Gamma(\frac{1}{4})} \right) \right.$$

$$\quad \left. + \log \left( \frac{\Gamma\left(\frac{\pi+i \log(2)}{4\pi}\right)^{24} \left(\frac{\Gamma\left(\frac{\pi+2i \log(2)}{4\pi}\right)}{\Gamma\left(\frac{3}{4} + \frac{i \log(2)}{2\pi}\right)}\right)^{4\sqrt{2}} \left(\frac{\Gamma\left(\frac{\pi+i \log(3)}{4\pi}\right)}{\Gamma\left(\frac{3}{4} + \frac{i \log(3)}{4\pi}\right)}\right)^{-8\sqrt{6}}}{\Gamma\left(\frac{3}{4} + \frac{i \log(2)}{4\pi}\right)^{24}} \right) \right)$$

EXAMPLE 5.8.

$$(5.8) \quad \int_0^{\infty} \frac{\Gamma(b+x) \log^k(\frac{1}{x})}{\sqrt{x} \Gamma(1+b+n+x)} dx$$

$$= - \sum_{p=0}^{\infty} \frac{i^{2+k} (2\pi)^{1+k} \left( -2^k \zeta \left( -k, \frac{1}{2} \left( 1 + \frac{\pi+i \log(b+p)}{2\pi} \right) \right) + 2^k \zeta \left( -k, \frac{\pi+i \log(b+p)}{4\pi} \right) \right) (-n)_p}{\sqrt{b+p} p! \Gamma(1+n)}$$

EXAMPLE 5.9.

$$(5.9) \quad \int_0^{\infty} \frac{\log(\log(\frac{1}{x}))}{\sqrt{x}(1+2x)(3+2x)} dx$$

$$= - \frac{i(-3+\sqrt{3})\pi^2}{12\sqrt{2}}$$

$$\pi \left( \sqrt{3} \log(16) - 6 \log(\pi) + 2\sqrt{3} \log(\pi) - \log \left( \frac{4096 \left( \frac{\Gamma\left(\frac{\pi+i \log(\frac{3}{2})}{4\pi}\right)}{\Gamma\left(\frac{3}{4} + \frac{i \log(\frac{3}{2})}{4\pi}\right)} \right)^{4\sqrt{3}} \Gamma\left(\frac{3}{4} - \frac{i \log(2)}{4\pi}\right)^{12}}{\Gamma\left(\frac{\pi-i \log(2)}{4\pi}\right)^{12}} \right) \right)$$

---

$$12\sqrt{2}$$

EXAMPLE 5.10.

$$\begin{aligned}
(5.10) \quad & \int_0^\infty \frac{\Gamma(i+x)}{\sqrt{x}\Gamma((3+i)+x)\log^2\left(\frac{i}{x}\right)} dx \\
&= \frac{80(-1)^{3/4}C + \frac{10\psi^{(1)}\left(\frac{5}{16} + \frac{i\log(2)}{8\pi}\right)}{\sqrt{1+i}} - \frac{10\zeta\left(2, \frac{7}{8} + \frac{i\log(1+i)}{4\pi}\right)}{\sqrt{1+i}} - \frac{5\left(\zeta\left(2, \frac{3}{8} + \frac{i\log(2+i)}{4\pi}\right) - \zeta\left(2, \frac{7}{8} + \frac{i\log(2+i)}{4\pi}\right)\right)}{\sqrt{2+i}}}{80\pi}
\end{aligned}$$

EXAMPLE 5.11.

$$\begin{aligned}
(5.11) \quad & \int_0^\infty \frac{\Gamma(1+x)\log\left(\log\left(\frac{1}{x}\right)\right)}{\sqrt{x}\Gamma(4+x)} dx \\
&= \frac{1}{12}\pi\left(-i\left(5+3\sqrt{2}-5\sqrt{3}\right)\pi + \sqrt{3}\log(16) - \sqrt{2}\log(4096) + 2\left(3-3\sqrt{2}+\sqrt{3}\right)\log(\pi)\right. \\
&\quad \left.-12\log\left(\Gamma\left(\frac{1}{4}\right)\right) + 12\log\left(\Gamma\left(\frac{3}{4}\right)\right)\right. \\
&\quad \left.+\log\left(4096\left(\frac{\Gamma\left(\frac{\pi+i\log(2)}{4\pi}\right)}{\Gamma\left(\frac{3}{4}+\frac{i\log(2)}{4\pi}\right)}\right)^{12\sqrt{2}}\left(-\frac{\Gamma\left(\frac{\pi+i\log(3)}{4\pi}\right)}{\Gamma\left(\frac{3}{4}+\frac{i\log(3)}{4\pi}\right)}\right)^{-4\sqrt{3}}\right)\right)
\end{aligned}$$

EXAMPLE 5.12.

$$\begin{aligned}
(5.12) \quad & \int_0^\infty \frac{\Gamma(1+x)\log\left(\frac{1}{x}\right)\log\left(\log\left(\frac{1}{x}\right)\right)}{\sqrt{x}\Gamma(4+x)} dx \\
&= \frac{1}{12}\pi\left(-24iC + 2\left(-\sqrt{3}\log(3) + \sqrt{2}\log(8)\right)\log(4\pi)\right. \\
&\quad \left.-i\pi\left(\sqrt{3}\log(3) - \sqrt{2}\log(8) - 16\left(3\sqrt{2}\zeta^{(1,0)}\left(-1, \frac{\pi+i\log(2)}{4\pi}\right)\right.\right.\right. \\
&\quad \left.\left.\left.-3\sqrt{2}\zeta^{(1,0)}\left(-1, \frac{3}{4} + \frac{i\log(2)}{4\pi}\right) + \sqrt{3}\left(-\zeta^{(1,0)}\left(-1, \frac{\pi+i\log(3)}{4\pi}\right)\right.\right.\right. \\
&\quad \left.\left.\left.\left.+\zeta^{(1,0)}\left(-1, \frac{3}{4} + \frac{i\log(3)}{4\pi}\right)\right)\right)\right)\right)
\end{aligned}$$

EXAMPLE 5.13.

$$\begin{aligned}
(5.13) \quad & \int_0^\infty \frac{\Gamma(b+x)\log\left(\log\left(\frac{a}{x}\right)\right)}{\sqrt[4]{x}\Gamma(1+b+n+x)} dx \\
&= \sum_{p=0}^\infty \frac{\sqrt{2}\pi(-n)_p}{\sqrt[4]{b+pp!}\Gamma(1+n)}\left(\frac{i\pi}{2} + \log(2\pi) - (1-i)\left(i\log\left(\frac{\Gamma\left(\frac{1}{4}\left(1+\frac{\pi-i\log(a)+i\log(b+p)}{2\pi}\right)\right)}{2\Gamma\left(\frac{1}{4}\left(3+\frac{\pi-i\log(a)+i\log(b+p)}{2\pi}\right)\right)}\right)\right.\right. \\
&\quad \left.\left.+\log\left(\frac{\Gamma\left(\frac{\pi-i\log(a)+i\log(b+p)}{8\pi}\right)}{2\Gamma\left(\frac{1}{4}\left(2+\frac{\pi-i\log(a)+i\log(b+p)}{2\pi}\right)\right)}\right)\right)\right)
\end{aligned}$$

EXAMPLE 5.14.

$$(5.14) \quad \int_0^\infty \frac{(-1+\sqrt[6]{x})\Gamma(2+x)}{x^{2/3}\Gamma(6+x)\log\left(\frac{1}{x}\right)} dx$$

$$= \sum_{p=0}^{\infty} \frac{\left(-i\sqrt[6]{2+p}\Phi\left(-1, 1, \frac{\pi+i\log(2+p)}{2\pi}\right) + (-1)^{2/3}\Phi\left(-\sqrt[3]{-1}, 1, \frac{\pi+i\log(2+p)}{2\pi}\right)\right)(-3)_p}{6(2+p)^{2/3}p!}$$

EXAMPLE 5.15.

$$(5.15) \quad \int_0^{\infty} \frac{\Gamma(3+x)\log\left(\log\left(\frac{\sqrt[3]{-1}}{x}\right)\right)}{\sqrt{x}\Gamma((9+i)+x)} dx$$

$$= \sum_{p=0}^{\infty} \frac{i\Gamma((-5-i)+p)}{2\sqrt{3+p}\Gamma(1+p)} (i\pi + \log(16) + 2\log(\pi) - 4\log(-8\pi + 3i\log(3+p)))$$

$$+ 4\log(-2\pi + 3i\log(3+p)) - 4\log\Gamma\left(-\frac{2}{3} + \frac{i\log(3+p)}{4\pi}\right)$$

$$+ 4\log\Gamma\left(-\frac{1}{6} + \frac{i\log(3+p)}{4\pi}\right) \sinh(\pi)$$

EXAMPLE 5.16.

$$(5.16) \quad \int_0^{\pi/4} \log(\tan(x)) \left( \frac{\sqrt{\tan(x)}}{(\log^2(\tan(x)) + \pi^2)^2} + \frac{\sqrt{\cot(x)}}{(\log^2(\cot(x)) + \pi^2)^2} \right) \frac{\sin(2x)}{\sin(4x)} dx$$

$$= \frac{1-2C}{8\pi^2}$$

EXAMPLE 5.17.

$$(5.17) \quad \int_0^{\pi/4} \frac{\sec(2x)\log(\tan(x))\log\left(\frac{\log(i\cot(x))}{\log(i\tan(x))}\right)}{\log(\cot(x))} dx = i\pi \log\left(-\frac{2\Gamma\left(\frac{1}{4}\right)}{\Gamma\left(-\frac{1}{4}\right)}\right)$$

EXAMPLE 5.18.

$$(5.18) \quad \int_{-\alpha}^{\alpha} \frac{\log\left(\frac{\alpha+x}{\alpha-x}\right)\log\left(\log\left(\frac{\alpha+x}{\alpha-x}\right)\right)}{\alpha^2+x^2} dx = -\frac{i\pi C}{\alpha}$$

EXAMPLE 5.19.

$$(5.19) \quad \int_0^{\infty} \frac{\log\left(\frac{(x+1)(b^2+x)}{(b+x)^2}\right)\left(\frac{1}{c+\log(x)} - \frac{1}{a+\log(x)}\right)}{x} dx$$

$$= -2i\pi \log\left(\frac{\Gamma\left(\frac{\pi-ia}{2\pi}\right)\Gamma\left(-\frac{i(a+2\log(b)+i\pi)}{2\pi}\right)\Gamma\left(-\frac{i(c+\log(b)+i\pi)}{2\pi}\right)^2}{\Gamma\left(\frac{\pi-ic}{2\pi}\right)\Gamma\left(-\frac{i(a+\log(b)+i\pi)}{2\pi}\right)^2\Gamma\left(-\frac{i(c+2\log(b)+i\pi)}{2\pi}\right)}\right)$$

EXAMPLE 5.20.

$$(5.20) \quad \int_0^{\infty} \frac{\log(x)\log(\log(x))}{(x-1)(x+i)} dx = \left(\frac{1}{32} + \frac{i}{32}\right)\pi \left(-i\pi \log\left(\frac{64e^6\pi^6}{A^{72}}\right) - 16iC + 3\pi^2\right)$$

EXAMPLE 5.21.

$$(5.21) \quad \int_0^\infty \frac{\sqrt{\log(x)} \log(\log(x))}{(x-1)(x+i)} dx$$

$$= \pi^{3/2} \left( 2i \left( \zeta' \left( -\frac{1}{2}, \frac{3}{4} \right) - \zeta' \left( -\frac{1}{2} \right) \right) + (\pi - 2i \log(2\pi)) \left( \zeta \left( -\frac{1}{2}, \frac{3}{4} \right) - \zeta \left( -\frac{1}{2} \right) \right) \right)$$

EXAMPLE 5.22. Mellin transform involving the logarithm of quotient cosine and hyperbolic cosine functions.

$$(5.22) \quad \int_0^\infty x^{s-1} \log \left( \frac{\cos(\alpha) + \cosh(x)}{\cos(\beta) + \cosh(x)} \right) dx$$

$$= \frac{2^s \pi^{s+1} \csc \left( \frac{\pi s}{2} \right) \left( \zeta \left( -s, \frac{\pi-\alpha}{2\pi} \right) + \zeta \left( -s, \frac{\alpha+\pi}{2\pi} \right) - \zeta \left( -s, \frac{\pi-\beta}{2\pi} \right) - \zeta \left( -s, \frac{\beta+\pi}{2\pi} \right) \right)}{s}$$

EXAMPLE 5.23.

$$(5.23) \quad \int_0^\infty \frac{(x^2 - \pi^2) \log \left( \frac{2}{\operatorname{sech}(x)+2} \right)}{(x^2 + \pi^2)^2} dx = \log \left( \frac{2e}{3\sqrt{3}} \right)$$

EXAMPLE 5.24.

$$(5.24) \quad \int_0^\infty \log \left( \frac{\cos(\alpha) + \cosh(x)}{\cos(\beta) + \cosh(x)} \right) \frac{dx}{\pi^2 a^2 + x^2} = \frac{1}{a} \log \left( \frac{\Gamma \left( \frac{\pi a - \beta + \pi}{2\pi} \right) \Gamma \left( \frac{\pi a + \beta + \pi}{2\pi} \right)}{\Gamma \left( \frac{\pi a - \alpha + \pi}{2\pi} \right) \Gamma \left( \frac{\pi a + \alpha + \pi}{2\pi} \right)} \right)$$

EXAMPLE 5.25.

$$(5.25) \quad \int_0^\infty \frac{(\pi x - \sinh(\pi x)) \operatorname{csch} \left( \frac{\pi x}{2} \right) \operatorname{sech} \left( \frac{\pi x}{2} \right) \log \left( \frac{\cos(\alpha) + \cosh(x)}{\cos(\beta) + \cosh(x)} \right)}{4\pi x^2} dx$$

$$= \sum_{a=1}^{\infty} \frac{(-1)^a}{a} \log \left( \frac{\Gamma \left( \frac{a - \beta + \pi}{2\pi} \right) \Gamma \left( \frac{a + \beta + \pi}{2\pi} \right)}{\Gamma \left( \frac{a - \alpha + \pi}{2\pi} \right) \Gamma \left( \frac{a + \alpha + \pi}{2\pi} \right)} \right)$$

EXAMPLE 5.26.

$$(5.26) \quad \int_0^\infty \frac{\sinh \left( \frac{1}{2}(m-n)x \right) \sinh \left( \frac{1}{2}(m+n-p)x \right)}{x \sinh \left( \frac{px}{2} \right)} dx = \frac{1}{2} \log \left( \frac{\sin \left( \frac{n\pi}{p} \right)}{\sin \left( \frac{m\pi}{p} \right)} \right)$$

where  $m, n, p \in \mathbb{R}_+$ .

EXAMPLE 5.27.

$$(5.27) \quad \int_0^\infty \frac{\operatorname{csch}(x) \log \left( 1 - \frac{2x}{ia+x} \right)}{2\pi i} dx = \log \left( \frac{(1+i)\sqrt{\pi} \Gamma \left( 1 + \frac{a}{2\pi} \right)}{\sqrt{ia} \Gamma \left( \frac{a+\pi}{2\pi} \right)} \right)$$

EXAMPLE 5.28.

$$\begin{aligned}
(5.28) \quad & \int_0^\infty e^x \left( (\pi - 2ix) \log \left( -x - \frac{i\pi}{2} \right) - (\pi + 2ix) \log \left( x - \frac{i\pi}{2} \right) \right) (\coth(x) - 1) dx \\
& = i\pi \left( -4C - \pi \log \left( -\frac{i\pi}{2} \right) \right)
\end{aligned}$$

EXAMPLE 5.29.

$$\begin{aligned}
(5.29) \quad & \int_0^\infty \operatorname{csch}(x) \left( \frac{i \log \left( -\frac{1}{2}(i\pi) - x \right)}{\pi - 2ix} + \frac{\log \left( -\frac{1}{2}(i\pi) + x \right)}{i\pi - 2x} \right) dx \\
& = \log \left( \frac{e^{\frac{1}{4}(2\gamma + i(-2 + \pi))\pi} \pi^{1+\pi}}{2^{1+\frac{5\pi}{2}} \Gamma\left(\frac{5}{4}\right)^{2\pi}} \right)
\end{aligned}$$

EXAMPLE 5.30.

$$\begin{aligned}
(5.30) \quad & \int_0^\infty \left( (-px - i\pi) \log \left( -x - \frac{i\pi}{p} \right) + i(\pi + ipx) \log \left( x - \frac{i\pi}{p} \right) \right) \operatorname{csch} \left( \frac{px}{2} \right) dx \\
& = \frac{\pi}{p} \left( -8C - 2\pi \log \left( \frac{\pi}{p} \right) + i\pi^2 \right)
\end{aligned}$$

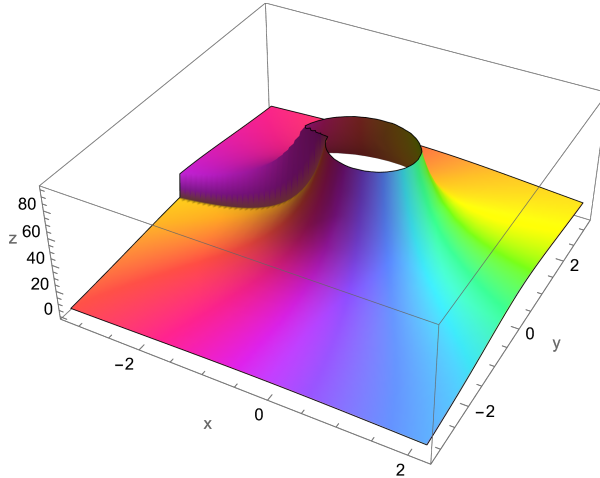
FIGURE 1. Plot of  $f(p) = \frac{\pi(-8C - 2\pi \log(\frac{\pi}{p}) + i\pi^2)}{p}$ ,  $p \in \mathbb{C}$ .

EXAMPLE 5.31.

$$\begin{aligned}
(5.31) \quad & \int_0^\infty x^{s-1} \tan^{-1}(\sinh(\alpha)\operatorname{sech}(bx)) dx \\
& = \frac{i2^{s-1}\pi^{s+1} \left(\frac{1}{b}\right)^s \csc\left(\frac{\pi s}{2}\right)}{s} \left( \zeta\left(-s, \frac{\pi - 2i\alpha}{4\pi}\right) - \zeta\left(-s, \frac{2i\alpha + \pi}{4\pi}\right) \right)
\end{aligned}$$



$$-\zeta\left(-s, \frac{3}{4} - \frac{i\alpha}{2\pi}\right) + \zeta\left(-s, \frac{i\alpha}{2\pi} + \frac{3}{4}\right)$$

EXAMPLE 5.32.

$$(5.32) \quad \int_0^\infty ((\log(a) - ix)^{k-1} + (\log(a) + ix)^{k-1}) \tan^{-1}(\sinh(\alpha)\operatorname{sech}(bx))dx \\ = \frac{i2^k \pi^{k+1} \left(\frac{1}{b}\right)^k}{k} \left( \zeta\left(-k, \frac{-2i\alpha + 2b \log(a) + \pi}{4\pi}\right) - \zeta\left(-k, \frac{-2i\alpha + 2b \log(a) + 3\pi}{4\pi}\right) \right. \\ \left. - \zeta\left(-k, \frac{2i\alpha + 2b \log(a) + \pi}{4\pi}\right) + \zeta\left(-k, \frac{2i\alpha + 2b \log(a) + 3\pi}{4\pi}\right) \right)$$

EXAMPLE 5.33.

$$(5.33) \quad \int_0^\infty \left( \frac{1}{(\log(a) + ix)^2} + \frac{1}{(\log(a) - ix)^2} \right) \tan^{-1}(\sinh(\alpha)\operatorname{sech}(bx))dx \\ = \frac{1}{2}ib \left( \psi^{(0)}\left(\frac{-2i\alpha + 2b \log(a) + \pi}{4\pi}\right) - \psi^{(0)}\left(\frac{-2i\alpha + 2b \log(a) + 3\pi}{4\pi}\right) \right. \\ \left. - \psi^{(0)}\left(\frac{2i\alpha + 2b \log(a) + \pi}{4\pi}\right) + \psi^{(0)}\left(\frac{2i\alpha + 2b \log(a) + 3\pi}{4\pi}\right) \right)$$

EXAMPLE 5.34.

$$(5.34) \quad \int_0^\infty \frac{(12x^2 - 1) \tanh^{-1}(\operatorname{sech}(\pi x))}{(4x^2 + 1)^3} dx = \frac{1}{8}(\pi - 2\pi C)$$

EXAMPLE 5.35.

$$(5.35) \quad \int_0^\infty \frac{(x^4 - 6x^2 + 1) \tanh^{-1}(\operatorname{sech}(\pi x))}{(x^2 + 1)^4} dx = \frac{1}{12}\pi(3\zeta(3) - 2)$$

EXAMPLE 5.36.

$$(5.36) \quad \int_0^\infty \left( \frac{1}{(1 + ix)^6} - \frac{1}{(x + i)^6} \right) \tanh^{-1}(\operatorname{sech}(\pi x))dx = \frac{1}{40}\pi(15\zeta(5) - 8)$$

EXAMPLE 5.37.

$$(5.37) \quad \int_0^\infty \left( \frac{1}{(1 + ix)^{3/2}} + \frac{1}{(1 - ix)^{3/2}} \right) \tanh^{-1}(\operatorname{sech}(\pi x))dx = -4(\sqrt{2} - 1) \pi \zeta\left(\frac{1}{2}\right) - 2\pi$$

EXAMPLE 5.38.

$$(5.38) \quad \int_0^\infty \left( \frac{1}{\sqrt{1 + ix}} + \frac{1}{\sqrt{1 - ix}} \right) \tanh^{-1}(\operatorname{sech}(\pi x))dx = (1 - 2\sqrt{2}) \zeta\left(\frac{3}{2}\right) + 2\pi$$

EXAMPLE 5.39.

$$(5.39) \quad \int_0^\infty \left( \frac{\log(\log(a) - ix)}{\log(a) - ix} + \frac{\log(\log(a) + ix)}{\log(a) + ix} \right) \tan^{-1}(\sinh(\alpha)\operatorname{sech}(bx))dx$$

$$\begin{aligned}
&= \frac{1}{2}i\pi \left( \zeta'' \left( 0, \frac{2b \log(a) - 2i\alpha + \pi}{4\pi} \right) - \zeta'' \left( 0, \frac{2b \log(a) - 2i\alpha + 3\pi}{4\pi} \right) \right. \\
&\quad \left. - \zeta'' \left( 0, \frac{2b \log(a) + 2i\alpha + \pi}{4\pi} \right) + \zeta'' \left( 0, \frac{2b \log(a) + 2i\alpha + 3\pi}{4\pi} \right) \right) \\
&+ 2 \log \left( \frac{2\pi}{b} \right) \left( \log(-4(-2b \log(a) + 2i\alpha + \pi)) + \log(2b \log(a) + 2i\alpha - 3\pi) \right. \\
&\quad \left. - \log(2b \log(a) + 2i\alpha - \pi) - \log(8b \log(a) - 8i\alpha - 12\pi) \right) \\
&- \log \Gamma \left( -\frac{-2i\alpha - 2b \log(a) + \pi}{4\pi} \right) + \log \Gamma \left( -\frac{2i\alpha - 2b \log(a) + \pi}{4\pi} \right) \\
&\quad \left. - \log \Gamma \left( -\frac{2i\alpha - 2b \log(a) + 3\pi}{4\pi} \right) + \log \Gamma \left( \frac{2i\alpha + 2b \log(a) - 3\pi}{4\pi} \right) \right)
\end{aligned}$$

EXAMPLE 5.40.

$$\begin{aligned}
(5.40) \quad &\int_0^\infty \frac{\tan^{-1}(\sinh(\alpha)\operatorname{sech}(bx))}{\log^2(a) + x^2} dx \\
&= -\frac{i\pi}{2 \log(a)} \log \left( \frac{\Gamma \left( \frac{-2i\alpha + 2b \log(a) + \pi}{4\pi} \right) \Gamma \left( \frac{2i\alpha + 2b \log(a) + 3\pi}{4\pi} \right)}{\Gamma \left( \frac{-2i\alpha + 2b \log(a) + 3\pi}{4\pi} \right) \Gamma \left( \frac{2i\alpha + 2b \log(a) + \pi}{4\pi} \right)} \right)
\end{aligned}$$

EXAMPLE 5.41.

$$(5.41) \quad \int_0^\infty \frac{\tanh^{-1}(\operatorname{sech}(\pi x))}{x^2 + 1} dx = -\frac{1}{2} \pi \log \left( \frac{2}{\pi} \right)$$

EXAMPLE 5.42.

$$(5.42) \quad \int_0^\infty \frac{\tanh^{-1}(\sin(\alpha)\operatorname{sech}(bx))}{a^2 + x^2} dx = -\frac{\pi}{2a} \log \left( \frac{\Gamma \left( \frac{2ab - 2\alpha + 3\pi}{4\pi} \right) \Gamma \left( \frac{2ab + 2\alpha + \pi}{4\pi} \right)}{\Gamma \left( \frac{2ab - 2\alpha + \pi}{4\pi} \right) \Gamma \left( \frac{2ab + 2\alpha + 3\pi}{4\pi} \right)} \right)$$

EXAMPLE 5.43.

$$\begin{aligned}
(5.43) \quad &\int_0^\infty \frac{\tanh^{-1}(\sin(\alpha)\operatorname{sech}(bx))}{(a^2 + x^2)^2} dx \\
&= \frac{ab}{8a^3} \left( -\psi^{(0)} \left( \frac{2ab - 2\alpha + \pi}{4\pi} \right) + \psi^{(0)} \left( \frac{2ab - 2\alpha + 3\pi}{4\pi} \right) + \psi^{(0)} \left( \frac{2ab + 2\alpha + \pi}{4\pi} \right) \right. \\
&\quad \left. - \psi^{(0)} \left( \frac{2ab + 2\alpha + 3\pi}{4\pi} \right) \right) - 2\pi \log \left( \frac{\Gamma \left( \frac{2ab - 2\alpha + 3\pi}{4\pi} \right) \Gamma \left( \frac{2ab + 2\alpha + \pi}{4\pi} \right)}{\Gamma \left( \frac{2ab - 2\alpha + \pi}{4\pi} \right) \Gamma \left( \frac{2ab + 2\alpha + 3\pi}{4\pi} \right)} \right)
\end{aligned}$$

EXAMPLE 5.44.

$$(5.44) \quad \int_0^\infty \frac{\tanh^{-1}(\operatorname{sech}(x))}{(x^2 + \pi^2)^2} dx = \frac{\log \left( \frac{2\pi}{e} \right)}{4\pi^2}$$

EXAMPLE 5.45.

$$(5.45) \quad \int_0^\infty \frac{\coth^{-1}(\sqrt{2} \cosh(9\pi x))}{x^2 + 4} dx = -\frac{1}{4} \pi \log \left( \frac{\Gamma \left( \frac{75}{8} \right) \Gamma \left( \frac{77}{8} \right)}{\Gamma \left( \frac{73}{8} \right) \Gamma \left( \frac{79}{8} \right)} \right)$$

EXAMPLE 5.46.

$$(5.46) \quad \int_0^\infty \operatorname{sech}(t) \tanh^{-1}(\sin(\alpha) \operatorname{sech}(ab \sinh(t))) dx \\ = -\frac{1}{2} \pi \log \left( \frac{\Gamma\left(\frac{2ab-2\alpha+3\pi}{4\pi}\right) \Gamma\left(\frac{2ab+2\alpha+\pi}{4\pi}\right)}{\Gamma\left(\frac{2ab-2\alpha+\pi}{4\pi}\right) \Gamma\left(\frac{2ab+2\alpha+3\pi}{4\pi}\right)} \right)$$

EXAMPLE 5.47.

$$(5.47) \quad \exp \left( \int_0^\infty \frac{2i \log(a) \tan^{-1}(\sinh(\alpha) \operatorname{sech}(bx))}{\pi (\log^2(a) + x^2)} dx \right) \\ = \frac{\Gamma\left(\frac{-2i\alpha+2b \log(a)+\pi}{4\pi}\right) \Gamma\left(\frac{2i\alpha+2b \log(a)+3\pi}{4\pi}\right)}{\Gamma\left(\frac{-2i\alpha+2b \log(a)+3\pi}{4\pi}\right) \Gamma\left(\frac{2i\alpha+2b \log(a)+\pi}{4\pi}\right)}$$

EXAMPLE 5.48.

$$(5.48) \quad \int_0^\infty \frac{2(mx \sin(mx) + \cos(mx) - rx \sin(rx) - \cos(rx)) \tan^{-1}(\sinh(\alpha) \operatorname{sech}(bx))}{x^2} dx \\ = ib \left( e^{\frac{(\pi-2i\alpha)m}{2b}} \Phi \left( -e^{\frac{m\pi}{b}}, 1, \frac{1}{2} - \frac{i\alpha}{\pi} \right) - e^{\frac{(\pi+2i\alpha)m}{2b}} \Phi \left( -e^{\frac{m\pi}{b}}, 1, \frac{i\alpha}{\pi} + \frac{1}{2} \right) \right. \\ \left. - e^{\frac{(\pi-2i\alpha)r}{2b}} \Phi \left( -e^{\frac{\pi r}{b}}, 1, \frac{1}{2} - \frac{i\alpha}{\pi} \right) + e^{\frac{(\pi+2i\alpha)r}{2b}} \Phi \left( -e^{\frac{\pi r}{b}}, 1, \frac{i\alpha}{\pi} + \frac{1}{2} \right) \right)$$

EXAMPLE 5.49.

$$(5.49) \quad \int_0^\infty \frac{x^{-m-\frac{1}{2}} \left( \beta + \sqrt{x(2\beta+x)} + x \right)^{-m} \log \left( x \left( \beta + \sqrt{x(2\beta+x)} + x \right) \right)}{\sqrt{2\beta+x}} dx \\ = \pi 2^m \beta^{-2m} \csc(2\pi m) (2 \log(\beta) + 2\pi \cot(2\pi m) - \log(2))$$

EXAMPLE 5.50.

$$(5.50) \quad \int_0^\infty \frac{\log^k \left( \frac{1}{2x(x+\sqrt{x(x+2)+1})} \right)}{x^{3/4} \sqrt{x+2} \sqrt[4]{x+\sqrt{x(x+2)}} + 1} dx \\ = -i 2^{2k+\frac{5}{4}} e^{\frac{1}{2}i\pi(k+1)} \pi^{k+1} \left( 2^k \zeta \left( -k, \frac{1}{4} \right) - 2^k \zeta \left( -k, \frac{3}{4} \right) \right)$$

EXAMPLE 5.51.

$$(5.51) \quad \int_0^\infty \frac{\log \left( \log \left( \frac{1}{2x(x+\sqrt{x(x+2)+1})} \right) \right)}{x^{3/4} \sqrt{x+2} \sqrt[4]{x+\sqrt{x(x+2)}} + 1} dx \\ = \frac{\pi \left( -4 \log \Gamma \left( -\frac{3}{4} \right) + 4 \log \Gamma \left( -\frac{1}{4} \right) + i\pi + \log \left( \frac{64\pi^2}{8\Gamma} \right) \right)}{2^{3/4}}$$

EXAMPLE 5.52.

$$(5.52) \quad \int_0^\infty \frac{\log\left(\frac{1}{2x(x+\sqrt{x(x+2)+1)}+1}\right) \log\left(\log\left(\frac{1}{2x(x+\sqrt{x(x+2)+1)}+1}\right)\right)}{x^{3/4}\sqrt{x+2}\sqrt[4]{x+\sqrt{x(x+2)+1}}} dx = -8i\sqrt[4]{2}\pi C$$

EXAMPLE 5.53.

$$(5.53) \quad \int_0^\infty \frac{\log\left(\log\left(-\frac{1}{2x(x+\sqrt{x(x+2)+1)}+1}\right)\right)}{x^{3/4}\sqrt{x+2}\sqrt[4]{x+\sqrt{x(x+2)+1}} + 1 \log\left(-\frac{1}{2x(x+\sqrt{x(x+2)+1)}+1}\right)} dx$$

$$= \frac{(-\pi + 2i \log(8\pi)) (\psi^{(0)}\left(\frac{3}{8}\right) - \psi^{(0)}\left(\frac{7}{8}\right)) - 2i (\gamma_1\left(\frac{3}{8}\right) - \gamma_1\left(\frac{7}{8}\right))}{4 \cdot 2^{3/4}}$$

EXAMPLE 5.54.

$$(5.54) \quad \int_0^\infty \frac{dx}{x^{3/4}\sqrt{x+2}\sqrt[4]{x+\sqrt{x(x+2)+1}} \left(\log^2\left(2x(x+\sqrt{x(x+2)+1})\right) + \pi^2\right)}$$

$$= \frac{\pi + \log(3 - 2\sqrt{2})}{2\sqrt[4]{2}\pi}$$

EXAMPLE 5.55.

$$(5.55) \quad \int_0^\infty \frac{dx}{2x^{3/4}\sqrt{x+2}\sqrt[4]{x+\sqrt{x(x+2)+1}} \left(\log^2\left(2x(x+\sqrt{x(x+2)+1})\right) + \frac{\pi^2}{4}\right)}$$

$$= \frac{\sin\left(\frac{\pi}{8}\right) (\sqrt{2}\pi + 2 \log(\tan\left(\frac{\pi}{16}\right))) + 2 \cos\left(\frac{\pi}{8}\right) \log\left(\cot\left(\frac{3\pi}{16}\right)\right)}{2^{3/4}\pi}$$

EXAMPLE 5.56.

$$(5.56) \quad \int_0^\infty \frac{\cosh(cu)}{\cosh(\pi u)} \log(a^2 + u^2) du$$

$$= \frac{1}{2} e^{-\frac{1}{2}(ic)} \left( \left( -1 + \frac{1}{1 + e^{ic}} \right) \log(4) - 2\Phi' \left( -e^{-ic}, 0, \frac{1}{2} + a \right) \right. \\ \left. - e^{ic} \left( \Phi' \left( -ie^{\frac{ic}{2}}, 0, 1 + 2a \right) + \Phi' \left( e^{\frac{1}{2}i(c+\pi)}, 0, 1 + 2a \right) \right) \right)$$

EXAMPLE 5.57.

$$(5.57) \quad \int_0^\infty \frac{\cosh(cu)}{\cosh(bu)} \log(a^2 + u^2) du$$

$$= \frac{e^{-\frac{ic\pi}{2b}} \pi}{2b} \left( 2 \log\left(\frac{\pi}{\sqrt{2}b}\right) \left(1 + i \tan\left(\frac{c\pi}{2b}\right)\right) - 2\Phi' \left( -e^{-\frac{ic\pi}{b}}, 0, \frac{1}{2} + \frac{ab}{\pi} \right) \right)$$

$$-e^{\frac{ic\pi}{b}} \left( \Phi' \left( -ie^{\frac{ic\pi}{2b}}, 0, 1 + \frac{2ab}{\pi} \right) + \Phi' \left( e^{\frac{i(b+c)\pi}{2b}}, 0, 1 + \frac{2ab}{\pi} \right) \right)$$

EXAMPLE 5.58.

$$\begin{aligned}
(5.58) \quad & \int_0^\infty \frac{\cosh(cu) \sinh(mu)}{\cosh(bu)} \tan^{-1} \left( \frac{a}{u} \right) du \\
&= \frac{\pi}{16b} \left( -H_{-\frac{b+c-m}{4b}} + H_{-\frac{3b+c-m}{4b}} + H_{-\frac{b-c+m}{4b}} - H_{-\frac{3b-c+m}{4b}} + H_{-\frac{3b+c+m}{4b}} - H_{-\frac{b+c+m}{4b}} + H_{-\frac{b+c+m}{4b}} \right. \\
&\quad \left. - H_{-\frac{3b+c+m}{4b}} - 2i \log(2) \left( \sec \left( \frac{(c-m)\pi}{2b} \right) - \sec \left( \frac{(c+m)\pi}{2b} \right) \right) \right. \\
&\quad \left. - 4e^{\frac{i(b-c-m)\pi}{2b}} \Phi' \left( e^{\frac{i(b-c-m)\pi}{b}}, 0, \frac{1}{2} + \frac{ab}{\pi} \right) - 2e^{\frac{i(b+c-m)\pi}{2b}} \left( \Phi' \left( -e^{\frac{i(b+c-m)\pi}{2b}}, 0, 1 + \frac{2ab}{\pi} \right) \right. \right. \\
&\quad \left. \left. + \Phi' \left( e^{\frac{i(b+c-m)\pi}{2b}}, 0, 1 + \frac{2ab}{\pi} \right) \right) + 4e^{\frac{i(b-c+m)\pi}{2b}} \Phi' \left( e^{\frac{i(b-c+m)\pi}{b}}, 0, \frac{1}{2} + \frac{ab}{\pi} \right) \right. \\
&\quad \left. + 2e^{\frac{i(b+c+m)\pi}{2b}} \left( \Phi' \left( -e^{\frac{i(b+c+m)\pi}{b}}, 0, 1 + \frac{2ab}{\pi} \right) + \Phi' \left( e^{\frac{i(b+c+m)\pi}{2b}}, 0, 1 + \frac{2ab}{\pi} \right) \right) \right)
\end{aligned}$$

EXAMPLE 5.59.

$$(5.59) \quad \int_0^\infty \frac{\cosh(cu) \sinh(mu)}{\cosh(bu)} \frac{du}{u} = \frac{1}{2} \log \left( \tan \left( \frac{(b-c+m)\pi}{4b} \right) \tan \left( \frac{(b+c+m)\pi}{4b} \right) \right)$$

EXAMPLE 5.60.

$$\begin{aligned}
(5.60) \quad & \int_0^1 \left( \frac{\cosh(cu) \sinh(mu)}{\cosh(bu)} + \cosh \left( \frac{c}{u} \right) \operatorname{sech} \left( \frac{b}{u} \right) \sinh \left( \frac{m}{u} \right) \right) \frac{du}{u} \\
&= \frac{1}{2} \log \left( \tan \left( \frac{(b-c+m)\pi}{4b} \right) \tan \left( \frac{(b+c+m)\pi}{4b} \right) \right)
\end{aligned}$$

EXAMPLE 5.61.

$$\begin{aligned}
(5.61) \quad & \int_0^\infty \frac{\cosh(cu) \sinh(mu)}{\cosh(bu)} \frac{du}{u} \\
&= \frac{1}{4} \left( 2 \tanh^{-1} \left( e^{\frac{i(b-c-m)\pi}{2b}} \right) - 2 \tanh^{-1} \left( e^{\frac{i(b-c+m)\pi}{2b}} \right) + \log \left( \frac{b+c-m}{b} \right) \right. \\
&\quad \left. + 2 \log \left( \frac{-5b-c+m}{b} \right) - \log \left( \frac{-3b-c+m}{b} \right) - \log \left( \frac{b+c+m}{b} \right) \right. \\
&\quad \left. + \log \left( -\frac{3b+c+m}{b} \right) - 2 \log \left( -\frac{5b+c+m}{b} \right) + 2 \log \Gamma \left( \frac{b+c-m}{4b} \right) \right. \\
&\quad \left. - \log \Gamma \left( \frac{b+c-m}{2b} \right) - \log \Gamma \left( -\frac{3b+c-m}{2b} \right) + 2 \log \Gamma \left( -\frac{5b+c-m}{4b} \right) \right. \\
&\quad \left. - 2 \log \Gamma \left( \frac{b+c+m}{4b} \right) + \log \Gamma \left( \frac{b+c+m}{2b} \right) + \log \Gamma \left( -\frac{3b+c+m}{2b} \right) \right. \\
&\quad \left. - 2 \log \Gamma \left( -\frac{5b+c+m}{4b} \right) \right)
\end{aligned}$$

EXAMPLE 5.62.

$$\begin{aligned}
(5.62) \quad & \int_0^\infty u^{-1+s} \frac{\cosh(cu)}{\cosh(bu)} du \\
&= 2^{-1-s} \left(\frac{i}{b}\right)^{1+s} b\pi^s \left( i2^s e^{-\frac{ic\pi}{2b}} \Phi\left(-e^{-\frac{ic\pi}{b}}, 1-s, \frac{1}{2}\right) - \text{Li}_{1-s}\left(-ie^{\frac{ic\pi}{2b}}\right) + \text{Li}_{1-s}\left(e^{\frac{i(b+c)\pi}{2b}}\right) \right) \\
&\qquad\qquad\qquad \left( i + \tan\left(\frac{1}{2}\pi(-1+s)\right) \right)
\end{aligned}$$

EXAMPLE 5.63.

$$\begin{aligned}
(5.63) \quad & \int_0^\infty \frac{u}{(a^2+u^2)} \frac{\cosh(cu) \sinh(mu)}{\cosh(bu)} du \\
&= \frac{1}{4} \left( e^{\frac{i(b-c-m)\pi}{2b}} \Phi\left(e^{\frac{i(b-c-m)\pi}{b}}, 1, \frac{1}{2} + \frac{ab}{\pi}\right) + e^{\frac{i(b+c-m)\pi}{2b}} \left( \Phi\left(-e^{\frac{i(b+c-m)\pi}{2b}}, 1, 1 + \frac{2ab}{\pi}\right) \right. \right. \\
&\quad \left. \left. + \Phi\left(e^{\frac{i(b+c-m)\pi}{2b}}, 1, 1 + \frac{2ab}{\pi}\right) \right) - e^{\frac{i(b-c+m)\pi}{2b}} \Phi\left(e^{\frac{i(b-c+m)\pi}{b}}, 1, \frac{1}{2} + \frac{ab}{\pi}\right) \right. \\
&\quad \left. - e^{\frac{i(b+c+m)\pi}{2b}} \left( \Phi\left(-e^{\frac{i(b+c+m)\pi}{2b}}, 1, 1 + \frac{2ab}{\pi}\right) + \Phi\left(e^{\frac{i(b+c+m)\pi}{2b}}, 1, 1 + \frac{2ab}{\pi}\right) \right) \right)
\end{aligned}$$

EXAMPLE 5.64.

$$\begin{aligned}
(5.64) \quad & \int_0^\infty \frac{u}{(a^4-u^4)} \frac{\cosh(cu) \sinh(mu)}{\cosh(bu)} du \\
&= -\frac{1}{8a^2} \left( e^{\frac{i(b-c-m)\pi}{2b}} \Phi\left(e^{\frac{i(b-c-m)\pi}{b}}, 1, \frac{1}{2} + \frac{iab}{\pi}\right) - e^{\frac{i(b-c-m)\pi}{2b}} \Phi\left(e^{\frac{i(b-c-m)\pi}{b}}, 1, \frac{1}{2} + \frac{ab}{\pi}\right) \right. \\
&\quad \left. + e^{\frac{i(b+c-m)\pi}{2b}} \left( \Phi\left(-e^{\frac{i(b+c-m)\pi}{2b}}, 1, 1 + \frac{2iab}{\pi}\right) + \Phi\left(e^{\frac{i(b+c-m)\pi}{2b}}, 1, 1 + \frac{2iab}{\pi}\right) \right) \right. \\
&\quad \left. - e^{\frac{i(b+c-m)\pi}{2b}} \left( \Phi\left(-e^{\frac{i(b+c-m)\pi}{2b}}, 1, 1 + \frac{2ab}{\pi}\right) + \Phi\left(e^{\frac{i(b+c-m)\pi}{2b}}, 1, 1 + \frac{2ab}{\pi}\right) \right) \right. \\
&\quad \left. - e^{\frac{i(b-c+m)\pi}{2b}} \Phi\left(e^{\frac{i(b-c+m)\pi}{b}}, 1, \frac{1}{2} + \frac{iab}{\pi}\right) + e^{\frac{i(b-c+m)\pi}{2b}} \Phi\left(e^{\frac{i(b-c+m)\pi}{b}}, 1, \frac{1}{2} + \frac{ab}{\pi}\right) \right. \\
&\quad \left. - e^{\frac{i(b+c+m)\pi}{2b}} \left( \Phi\left(-e^{\frac{i(b+c+m)\pi}{2b}}, 1, 1 + \frac{2iab}{\pi}\right) + \Phi\left(e^{\frac{i(b+c+m)\pi}{2b}}, 1, 1 + \frac{2iab}{\pi}\right) \right) \right. \\
&\quad \left. + e^{\frac{i(b+c+m)\pi}{2b}} \left( \Phi\left(-e^{\frac{i(b+c+m)\pi}{2b}}, 1, 1 + \frac{2ab}{\pi}\right) + \Phi\left(e^{\frac{i(b+c+m)\pi}{2b}}, 1, 1 + \frac{2ab}{\pi}\right) \right) \right)
\end{aligned}$$

EXAMPLE 5.65.

$$\begin{aligned}
(5.65) \quad & \int_0^\infty \frac{\tan^{-1}\left(\frac{x}{a}\right) \sinh(mx)}{(\cos(t) + \cosh(cx))^2} dx \\
&= -\frac{ie^{-\frac{im(\pi-t)}{c}} \csc^2(t)}{4c^2} \left( -c\Phi\left(e^{-\frac{2im\pi}{c}}, 1, \frac{ac + \pi - t}{2\pi}\right) - ce^{-\frac{2imt}{c}} \Phi\left(e^{-\frac{2im\pi}{c}}, 1, \frac{ac + \pi + t}{2\pi}\right) \right) \\
&\quad + 2\pi(-im + c \cot(t))\Phi'\left(e^{-\frac{2im\pi}{c}}, 0, \frac{ac + \pi - t}{2\pi}\right)
\end{aligned}$$

$$\begin{aligned}
& -2ie^{-\frac{2imt}{c}} \pi(m - ic \cot(t)) \Phi' \left( e^{-\frac{2im\pi}{c}}, 0, \frac{ac + \pi + t}{2\pi} \right) + e^{\frac{2im(\pi-t)}{c}} \left( c\Phi \left( e^{\frac{2im\pi}{c}}, 1, \frac{ac + \pi - t}{2\pi} \right) \right. \\
& -2i\pi(m - ic \cot(t)) \Phi' \left( e^{\frac{2im\pi}{c}}, 0, \frac{ac + \pi - t}{2\pi} \right) + e^{\frac{2imt}{c}} \left( c\Phi \left( e^{\frac{2im\pi}{c}}, 1, \frac{ac + \pi + t}{2\pi} \right) \right. \\
& \left. \left. \left. + 2\pi(-im + c \cot(t)) \Phi' \left( e^{\frac{2im\pi}{c}}, 0, \frac{ac + \pi + t}{2\pi} \right) \right) \right) \right)
\end{aligned}$$

EXAMPLE 5.66.

$$\begin{aligned}
(5.66) \quad & \int_0^\infty \frac{\cosh(mx)}{(\cos(t) + \cosh(cx))^2} \log(a^2 + x^2) dx \\
& = \frac{e^{-\frac{im(\pi+t)}{c}} \csc^2(t)}{2c^2} \left( -ce^{\frac{2imt}{c}} \Phi \left( e^{-\frac{2im\pi}{c}}, 1, \frac{ac + \pi - t}{2\pi} \right) - c\Phi \left( e^{-\frac{2im\pi}{c}}, 1, \frac{ac + \pi + t}{2\pi} \right) \right. \\
& \quad - ce^{\frac{2im\pi}{c}} \Phi \left( e^{\frac{2im\pi}{c}}, 1, \frac{ac + \pi - t}{2\pi} \right) + 4e^{\frac{im(\pi+t)}{c}} \pi \csc \left( \frac{m\pi}{c} \right) (\log(2) \\
& \quad \left. - \log(c) + \log(\pi)) \left( m \cos \left( \frac{mt}{c} \right) - c \cot(t) \sin \left( \frac{mt}{c} \right) \right) \\
& - 2ie^{\frac{2imt}{c}} m\pi \Phi' \left( e^{-\frac{2im\pi}{c}}, 0, \frac{ac + \pi - t}{2\pi} \right) + 2ce^{\frac{2imt}{c}} \pi \cot(t) \Phi' \left( e^{-\frac{2im\pi}{c}}, 0, \frac{ac + \pi - t}{2\pi} \right) \\
& \quad - 2im\pi \Phi' \left( e^{-\frac{2im\pi}{c}}, 0, \frac{ac + \pi + t}{2\pi} \right) - 2c\pi \cot(t) \Phi' \left( e^{-\frac{2im\pi}{c}}, 0, \frac{ac + \pi + t}{2\pi} \right) \\
& + 2ie^{\frac{2im\pi}{c}} m\pi \Phi' \left( e^{\frac{2im\pi}{c}}, 0, \frac{ac + \pi - t}{2\pi} \right) + 2ce^{\frac{2im\pi}{c}} \pi \cot(t) \Phi' \left( e^{\frac{2im\pi}{c}}, 0, \frac{ac + \pi - t}{2\pi} \right) \\
& \left. - e^{\frac{2im(\pi+t)}{c}} \left( c\Phi \left( e^{\frac{2im\pi}{c}}, 1, \frac{ac + \pi + t}{2\pi} \right) + 2\pi(-im + c \cot(t)) \Phi' \left( e^{\frac{2im\pi}{c}}, 0, \frac{ac + \pi + t}{2\pi} \right) \right) \right)
\end{aligned}$$

EXAMPLE 5.67.

$$\begin{aligned}
(5.67) \quad & \int_0^\infty \frac{\sinh(mx)}{x(\cos(t) + \cosh(cx))^2} dx \\
& = -\frac{ie^{-\frac{im(\pi-t)}{c}} \csc^2(t)}{8c\pi} \left( 2\pi(-im + c \cot(t)) \Phi \left( e^{-\frac{2im\pi}{c}}, 1, \frac{\pi - t}{2\pi} \right) \right. \\
& \quad - 2e^{-\frac{2imt}{c}} \pi(im + c \cot(t)) \Phi \left( e^{-\frac{2im\pi}{c}}, 1, \frac{\pi + t}{2\pi} \right) - c\Phi \left( e^{-\frac{2im\pi}{c}}, 2, \frac{\pi - t}{2\pi} \right) \\
& \quad - ce^{-\frac{2imt}{c}} \Phi \left( e^{-\frac{2im\pi}{c}}, 2, \frac{\pi + t}{2\pi} \right) + e^{\frac{2im(\pi-t)}{c}} \left( -2\pi(im + c \cot(t)) \Phi \left( e^{\frac{2im\pi}{c}}, 1, \frac{\pi - t}{2\pi} \right) \right. \\
& \quad \left. + 2e^{\frac{2imt}{c}} \pi(-im + c \cot(t)) \Phi \left( e^{\frac{2im\pi}{c}}, 1, \frac{\pi + t}{2\pi} \right) + c \left( \Phi \left( e^{\frac{2im\pi}{c}}, 2, \frac{\pi - t}{2\pi} \right) \right. \right. \\
& \quad \left. \left. + e^{\frac{2imt}{c}} \Phi \left( e^{\frac{2im\pi}{c}}, 2, \frac{\pi + t}{2\pi} \right) \right) \right)
\end{aligned}$$

EXAMPLE 5.68.

$$(5.68) \quad \int_0^\infty \frac{x^{-1+s} \sinh(mx)}{(\cos(t) + \cosh(cx))^2} dx$$

$$\begin{aligned}
&= -i2^{-3+s}c^{-1-s}e^{\frac{im(-\pi+t)}{c}}\pi^{-1+s}\csc^2(t)\sec\left(\frac{\pi s}{2}\right)\left(2\pi(-im+c\cot(t))\Phi\left(e^{-\frac{2im\pi}{c}},1-s,\frac{\pi-t}{2\pi}\right)\right. \\
&-2e^{-\frac{2imt}{c}}\pi(im+c\cot(t))\Phi\left(e^{-\frac{2im\pi}{c}},1-s,\frac{\pi+t}{2\pi}\right)+c(-1+s)\Phi\left(e^{-\frac{2im\pi}{c}},2-s,\frac{\pi-t}{2\pi}\right) \\
&+ce^{-\frac{2imt}{c}}(-1+s)\Phi\left(e^{-\frac{2im\pi}{c}},2-s,\frac{\pi+t}{2\pi}\right)-e^{\frac{2im(\pi-t)}{c}}\left(2\pi(im+c\cot(t))\Phi\left(e^{\frac{2im\pi}{c}},1-s,\frac{\pi-t}{2\pi}\right)\right. \\
&+2ie^{\frac{2imt}{c}}\pi(m+ic\cot(t))\Phi\left(e^{\frac{2im\pi}{c}},1-s,\frac{\pi+t}{2\pi}\right)+c(-1+s)\left(\Phi\left(e^{\frac{2im\pi}{c}},2-s,\frac{\pi-t}{2\pi}\right)\right. \\
&\quad\left.\left.+e^{\frac{2imt}{c}}\Phi\left(e^{\frac{2im\pi}{c}},2-s,\frac{\pi+t}{2\pi}\right)\right)\right)
\end{aligned}$$

EXAMPLE 5.69.

$$\begin{aligned}
(5.69) \quad &\int_0^\infty \frac{((a-x)^k - (a+x)^k)(\sinh(bx)\sinh(mx))}{\sinh(c\pi x)} dx \\
&= \frac{1}{2}\left(\frac{i}{c}\right)^{1+k}e^{-\frac{i(b+m)}{c}}\left(-e^{\frac{2ib}{c}}\Phi\left(-e^{\frac{i(b-m)}{c}},-k,1-iac\right)-e^{\frac{2im}{c}}\Phi\left(-e^{\frac{i(-b+m)}{c}},-k,1-iac\right)\right. \\
&\quad\left.+\Phi\left(-e^{-\frac{i(b+m)}{c}},-k,1-iac\right)+e^{\frac{2i(b+m)}{c}}\Phi\left(-e^{\frac{i(b+m)}{c}},-k,1-iac\right)\right)
\end{aligned}$$

EXAMPLE 5.70.

$$\begin{aligned}
(5.70) \quad &\int_0^\infty \frac{((a-x)^k + (a+x)^k)(\cosh(mx)\sinh(bx))}{\sinh(c\pi x)} dx \\
&= \frac{1}{2}\left(\frac{i}{c}\right)^{1+k}e^{-\frac{i(b+m)}{c}}\left(-e^{\frac{2ib}{c}}\Phi\left(-e^{\frac{i(b-m)}{c}},-k,1-iac\right)+\Phi\left(-e^{-\frac{i(b+m)}{c}},-k,1-iac\right)\right. \\
&\quad\left.+e^{\frac{2im}{c}}\left(\Phi\left(-e^{\frac{i(-b+m)}{c}},-k,1-iac\right)-e^{\frac{2ib}{c}}\Phi\left(-e^{\frac{i(b+m)}{c}},-k,1-iac\right)\right)\right)
\end{aligned}$$

EXAMPLE 5.71.

$$\begin{aligned}
(5.71) \quad &\int_0^\infty \frac{\tanh^{-1}\left(\frac{x}{a}\right)(\sinh(bx)\sinh(mx))}{\sinh(c\pi x)} dx \\
&= -\frac{ie^{-\frac{i(b+m)}{c}}}{4c}\left(e^{\frac{2ib}{c}}\Phi'\left(-e^{\frac{i(b-m)}{c}},0,1-iac\right)-\Phi'\left(-e^{-\frac{i(b+m)}{c}},0,1-iac\right)\right. \\
&\quad\left.+e^{\frac{2im}{c}}\left(\Phi'\left(-e^{\frac{i(-b+m)}{c}},0,1-iac\right)-e^{\frac{2ib}{c}}\Phi'\left(-e^{\frac{i(b+m)}{c}},0,1-iac\right)\right)\right)
\end{aligned}$$

EXAMPLE 5.72.

$$\begin{aligned}
(5.72) \quad &\int_0^\infty \frac{\cosh(mx)\log(a^2-x^2)\sinh(bx)}{\sinh(c\pi x)} dx \\
&= \frac{\log\left(\frac{i}{c}\right)\sin\left(\frac{b}{c}\right)}{c\cos\left(\frac{b}{c}\right)+c\cos\left(\frac{m}{c}\right)}+\frac{ie^{-\frac{i(b+m)}{c}}}{2c}\left(e^{\frac{2ib}{c}}\Phi'\left(-e^{\frac{i(b-m)}{c}},0,1-iac\right)\right. \\
&\quad\left.-e^{\frac{2im}{c}}\Phi'\left(-e^{\frac{i(-b+m)}{c}},0,1-iac\right)-\Phi'\left(-e^{-\frac{i(b+m)}{c}},0,1-iac\right)\right. \\
&\quad\left.+e^{\frac{2i(b+m)}{c}}\Phi'\left(-e^{\frac{i(b+m)}{c}},0,1-iac\right)\right)
\end{aligned}$$



EXAMPLE 5.73.

$$\begin{aligned}
(5.73) \quad & \int_0^\infty ((a-x)^k - (a+x)^k) \left( \coth\left(\frac{\pi x}{2}\right) - \coth(2^n \pi x) \right) \sinh(bx) \sinh(mx) dx \\
&= \sum_{p=0}^n \frac{1}{2} (i2^{-p})^{1+k} e^{-i2^{-p}(b+m)} \left( -e^{i2^{1-p}b} \Phi\left(-e^{i2^{-p}(b-m)}, -k, 1-i2^p a\right) \right. \\
&\quad \left. -e^{i2^{1-p}m} \Phi\left(-e^{i2^{-p}(-b+m)}, -k, 1-i2^p a\right) + \Phi\left(-e^{-i2^{-p}(b+m)}, -k, 1-i2^p a\right) \right. \\
&\quad \left. +e^{i2^{1-p}(b+m)} \Phi\left(-e^{i2^{-p}(b+m)}, -k, 1-i2^p a\right) \right)
\end{aligned}$$

EXAMPLE 5.74.

$$\begin{aligned}
(5.74) \quad & \int_0^\infty \log(16\pi^2 - x^2) \operatorname{sech}(3x) \sinh\left(\frac{x}{2}\right) \sinh(x) dx \\
&= \frac{(-1)^{3/4} \pi}{12\sqrt{3}} \left( \left( (22-10i) - (12-4i)\sqrt{3} \right) \log(2) - (10+2i) \log(3) + (2-2i)\sqrt{3} \log(577) \right. \\
&\quad \left. - (2-2i) \log(37505) + (4+4i)\sqrt{3} \log\left(\frac{3}{\pi}\right) + (6+6i) \log(\pi) - 2\Phi'\left(-1, 0, \frac{1}{4} - 6i\right) \right. \\
&\quad \left. - 2\Phi'\left(-1, 0, \frac{1}{4} + 6i\right) + 2(i+\sqrt{3}) \Phi'\left(-1, 0, \frac{3}{4} - 6i\right) + 2(i+\sqrt{3}) \Phi'\left(-1, 0, \frac{3}{4} + 6i\right) \right. \\
&\quad \left. + (-2-2i\sqrt{3}) \Phi'\left(-1, 0, \frac{5}{4} - 6i\right) + (-2-2i\sqrt{3}) \Phi'\left(-1, 0, \frac{5}{4} + 6i\right) \right. \\
&\quad \left. + 2i\Phi'\left(-1, 0, \frac{7}{4} - 6i\right) + 2i\Phi'\left(-1, 0, \frac{7}{4} + 6i\right) \right. \\
&\quad \left. + (-i+\sqrt{3}) \Phi'\left(\frac{1}{2} + \frac{i\sqrt{3}}{2}, 0, \frac{1}{4} - 6i\right) + (-i+\sqrt{3}) \Phi'\left(\frac{1}{2} + \frac{i\sqrt{3}}{2}, 0, \frac{1}{4} + 6i\right) \right. \\
&\quad \left. + 2i(i+\sqrt{3}) \Phi'\left(\frac{1}{2} + \frac{i\sqrt{3}}{2}, 0, \frac{3}{4} - 6i\right) + 2i(i+\sqrt{3}) \Phi'\left(\frac{1}{2} + \frac{i\sqrt{3}}{2}, 0, \frac{3}{4} + 6i\right) \right. \\
&\quad \left. - 4i\Phi'\left(\frac{1}{2} + \frac{i\sqrt{3}}{2}, 0, \frac{5}{4} - 6i\right) - 4i\Phi'\left(\frac{1}{2} + \frac{i\sqrt{3}}{2}, 0, \frac{5}{4} + 6i\right) \right. \\
&\quad \left. + (1+i\sqrt{3}) \left( \Phi'\left(\frac{1}{2} + \frac{i\sqrt{3}}{2}, 0, \frac{7}{4} - 6i\right) + \Phi'\left(\frac{1}{2} + \frac{i\sqrt{3}}{2}, 0, \frac{7}{4} + 6i\right) \right) \right)
\end{aligned}$$

EXAMPLE 5.75.

$$\begin{aligned}
(5.75) \quad & \int_0^\infty x^{s-1} e^{x(m-i\alpha)} \left( \Phi\left(-e^{2x(m-i\alpha)}, 1-s, \frac{1}{2}\right) - e^{2i\alpha x} \Phi\left(-e^{2x(m+i\alpha)}, 1-s, \frac{1}{2}\right) \right) dx \\
&= \pi 2^{-s-1} \Gamma(s) \left( (-m+i\alpha)^{-s} - (-m-i\alpha)^{-s} \right)
\end{aligned}$$

EXAMPLE 5.76.

$$(5.76) \quad \int_0^\infty x^{s-1} e^{mx} \Phi\left(-e^{2mx}, 1-s, \frac{1}{2}\right) dx = \frac{1}{2} \pi \left(-\frac{1}{2m}\right)^s \Gamma(s)$$

EXAMPLE 5.77.

$$(5.77) \quad \prod_{k=0}^{n-1} \int_0^\infty e^{mx} x^{\frac{k+s}{n}-1} \Phi \left( -e^{2mx}, 1 - \frac{k+s}{n}, \frac{1}{2} \right) dx \\ = \pi^{\frac{3n}{2}-\frac{1}{2}} 2^{-n-s} n^{\frac{1}{2}-s} \Gamma(s) \left( -\frac{1}{m} \right)^{\frac{1}{2}(n+2s-1)}$$

EXAMPLE 5.78.

$$(5.78) \quad \prod_{a=1}^q \int_0^\infty e^{-2ix\alpha} x^{-1+s} \left( \Phi \left( -e^{-2ix\alpha}, 1-s, \frac{1}{2} \left( 1 + \frac{a}{x} \right) \right) - \Phi \left( -e^{-2ix\alpha}, 1-s, \frac{1}{2} \left( 3 + \frac{a}{x} \right) \right) \right. \\ \left. + e^{4ix\alpha} \left( -\Phi \left( -e^{2ix\alpha}, 1-s, \frac{1}{2} \left( 1 + \frac{a}{x} \right) \right) + \Phi \left( -e^{2ix\alpha}, 1-s, \frac{1}{2} \left( 3 + \frac{a}{x} \right) \right) \right) \right) \sec(\alpha x) dx \\ = \prod_{a=1}^q \frac{\pi}{2^s} \left( \frac{e^{ia\alpha} \Gamma(s, ia\alpha)}{(i\alpha)^s} - \frac{e^{-ia\alpha} \Gamma(s, -ia\alpha)}{(-i\alpha)^s} \right)$$

EXAMPLE 5.79.

$$(5.79) \quad \prod_{a=1}^1 \int_0^\infty x^{s-1} e^{-2iax} \sec(\alpha x) \left( \Phi \left( -e^{-2ix\alpha}, 1-s, \frac{1}{2} \left( \frac{a}{x} + 1 \right) \right) \right. \\ \left. - \Phi \left( -e^{-2ix\alpha}, 1-s, \frac{1}{2} \left( \frac{a}{x} + 3 \right) \right) + e^{4iax} \left( \Phi \left( -e^{2ix\alpha}, 1-s, \frac{1}{2} \left( \frac{a}{x} + 3 \right) \right) \right. \right. \\ \left. \left. - \Phi \left( -e^{2ix\alpha}, 1-s, \frac{1}{2} \left( \frac{a}{x} + 1 \right) \right) \right) \right) dx \\ = \frac{8}{3} i\pi^2 (\pi^2 \text{Ci}(\pi) - 1)$$

EXAMPLE 5.80.

$$(5.80) \quad \prod_{\alpha=1}^2 \int_0^\infty \frac{e^{-2i\alpha x}}{x^7} \left( \Phi \left( -e^{-2ix\alpha}, 7, \frac{1}{4} \left( 2 + \frac{\pi}{x} \right) \right) - \Phi \left( -e^{-2ix\alpha}, 7, \frac{1}{4} \left( 6 + \frac{\pi}{x} \right) \right) \right. \\ \left. + e^{4i\alpha x} \left( \Phi \left( -e^{2ix\alpha}, 7, \frac{1}{4} \left( 6 + \frac{\pi}{x} \right) \right) - \Phi \left( -e^{2ix\alpha}, 7, \frac{1}{4} \left( 2 + \frac{\pi}{x} \right) \right) \right) \right) \sec(\alpha x) dx \\ = \frac{2048 (\pi^5 \text{Ci}(\frac{\pi}{2}) - 768 + 16\pi^2 - 2\pi^4) (-2\pi^5 \text{Si}(\pi) + 48 - 4\pi^2 + 2\pi^4 + \pi^6)}{2025\pi^8}$$

EXAMPLE 5.81.

$$(5.81) \quad \int_0^\infty \int_0^\infty u^{x-1} v^{y-1} e^{m(u+v)} \Phi \left( -e^{2mu}, 1-x, \frac{1}{2} \right) \Phi \left( -e^{2mv}, 1-y, \frac{1}{2} \right) dudv \\ = \pi^2 2^{-x-y-2} \Gamma(x) \Gamma(y) \left( -\frac{1}{m} \right)^{x+y}$$

EXAMPLE 5.82.

$$\begin{aligned}
(5.82) \quad & \sum_{k=0}^n \int_0^\infty \int_0^\infty \frac{2^{2\alpha+n+2} u^{\alpha+k-1} \left(-\frac{1}{m}\right)^{-2\alpha-n} e^{m(u+v)} v^{\alpha-k+n-1} \cos(x(n-2k))}{\pi^2 k! (n-k)!} \\
& \Phi\left(-e^{2mu}, -k-\alpha+1, \frac{1}{2}\right) \Phi\left(-e^{2mv}, k-n-\alpha+1, \frac{1}{2}\right) dudv \\
& = \Gamma(\alpha)^2 C_n^{(\alpha)}(\cos(x))
\end{aligned}$$

EXAMPLE 5.83.

$$\begin{aligned}
(5.83) \quad & \int_0^\infty \left( \operatorname{sech}(x(m-i\alpha)) - \operatorname{sech}(x(m+i\alpha)) \right. \\
& \quad \left. - \operatorname{sech}\left(\frac{1}{2}x(m-2i\alpha)\right) + \operatorname{sech}\left(\frac{1}{2}x(m+2i\alpha)\right) \right) dx \\
& = -\frac{3i\pi\alpha m^2}{(\alpha^2+m^2)(4\alpha^2+m^2)}
\end{aligned}$$

EXAMPLE 5.84.

$$\begin{aligned}
(5.84) \quad & \int_0^1 \left( \frac{\sqrt{\alpha}}{\sqrt{\alpha-x\alpha+\beta} \log\left(\frac{e^{ia\pi}x\alpha}{\alpha-x\alpha+\beta}\right)} + \frac{\sqrt{\beta}}{\sqrt{\alpha+\beta-x\beta} \log\left(\frac{e^{ia\pi}(\alpha+\beta-x\beta)}{x\beta}\right)} \right) \frac{dx}{\sqrt{x}} \\
& = \frac{1}{2}i \left( \psi^{(0)}\left(\frac{1+a}{4}\right) - \psi^{(0)}\left(\frac{3+a}{4}\right) \right)
\end{aligned}$$

EXAMPLE 5.85.

$$\begin{aligned}
(5.85) \quad & \int_0^1 \left( \frac{\sqrt{\alpha} \log\left(-\frac{x\alpha}{\alpha-x\alpha+\beta}\right) \log\left(\log\left(-\frac{x\alpha}{\alpha-x\alpha+\beta}\right)\right)}{\sqrt{\alpha-x\alpha+\beta}} \right. \\
& \quad \left. + \frac{\sqrt{\beta} \log\left(-\frac{\alpha+\beta-x\beta}{x\beta}\right) \log\left(\log\left(-\frac{\alpha+\beta-x\beta}{x\beta}\right)\right)}{\sqrt{\alpha+\beta-x\beta}} \right) \frac{dx}{\sqrt{x}} \\
& = i\pi^2 \log\left(\frac{4i\sqrt[3]{2}e\pi}{A^{12}}\right)
\end{aligned}$$

EXAMPLE 5.86.

$$\begin{aligned}
(5.86) \quad & \int_0^1 \left( \frac{\sqrt{\alpha} \log^2\left(-\frac{x\alpha}{\alpha-x\alpha+\beta}\right) \log\left(\log\left(-\frac{x\alpha}{\alpha-x\alpha+\beta}\right)\right)}{\sqrt{\alpha-x\alpha+\beta}} \right. \\
& \quad \left. + \frac{\sqrt{\beta} \log^2\left(-\frac{\alpha+\beta-x\beta}{x\beta}\right) \log\left(\log\left(-\frac{\alpha+\beta-x\beta}{x\beta}\right)\right)}{\sqrt{\alpha+\beta-x\beta}} \right) \frac{dx}{\sqrt{x}} = 14\pi\zeta(3)
\end{aligned}$$

EXAMPLE 5.87.

$$(5.87) \quad \int_0^1 \left( \frac{\sqrt{\alpha} \log \left( \frac{x\alpha}{\alpha-x\alpha+\beta} \right) \log \left( \log \left( \frac{x\alpha}{\alpha-x\alpha+\beta} \right) \right)}{\sqrt{\alpha-x\alpha+\beta}} \right. \\ \left. + \frac{\sqrt{\beta} \log \left( \frac{\alpha+\beta-x\beta}{x\beta} \right) \log \left( \log \left( \frac{\alpha+\beta-x\beta}{x\beta} \right) \right)}{\sqrt{\alpha+\beta-x\beta}} \right) \frac{dx}{\sqrt{x}} = -4iC\pi$$

EXAMPLE 5.88.

$$(5.88) \quad \int_0^\infty \log(1-e^{-2x}) \left( (1+m^2)x \cos(mx) + (2m + (1+m^2)\log(a)) \sin(mx) \right) \sinh(x) dx \\ = \frac{1}{4} \left( \frac{8-8m^2+8(m+m^3)\log(a)}{(1+m^2)^2} - \pi \operatorname{sech}^2 \left( \frac{m\pi}{2} \right) (\pi + \log(a) \sinh(m\pi)) \right)$$

EXAMPLE 5.89.

$$(5.89) \quad \int_0^\infty \left( x \log(x) - \frac{1}{x} \right) \log(1-e^{-2x}) \sinh(x) dx = 2(1-\gamma) - \frac{1}{12} \pi^2 \log \left( \frac{16\pi^3 \exp(3)}{A^{36}} \right)$$

EXAMPLE 5.90.

$$(5.90) \quad \int_0^\infty \frac{x(\pi^4 - 2x^2 + x^4 + 2\pi^2(3+x^2)) \log(1-e^{-2x}) \sinh(x)}{(\pi^2+x^2)^3} dx = \frac{1}{2} + 2\operatorname{Ci}(\pi) - \log(2)$$

EXAMPLE 5.91.

$$(5.91) \quad \int_0^\infty \log(1-e^{-2x}) \left( \frac{2x}{\pi^2+x^2} - \left( 2\pi \tan^{-1} \left( \frac{x}{\pi} \right) + x \log(\pi^2+x^2) \right) \right) \sinh(x) dx \\ = \frac{1}{6} \left( -\pi^2 \log \left( \frac{16e^3}{A^{36}\pi^3} \right) - 24(1 + \operatorname{Ci}(\pi) + \log(\pi)) \right)$$

EXAMPLE 5.92.

$$(5.92) \quad \int_0^\infty \left( \frac{2a\pi x}{(a^2\pi^2+x^2)^2} + \cot^{-1} \left( \frac{a\pi}{x} \right) \right) \log(1-e^{-2x}) \sinh(x) dx \\ = ie^{-ia\pi} (-\Gamma(0, -ia\pi) + e^{2ia\pi} \Gamma(0, ia\pi)) + \pi \log \left( \frac{(-1+a)\Gamma(\frac{1}{2}(-1+a))}{\sqrt{2}\sqrt{a}\Gamma(\frac{a}{2})} \right)$$

EXAMPLE 5.93.

$$(5.93) \quad \int_0^\infty e^{x/2} \left( \frac{e^{-x}(-8+a\pi(4i-3a\pi-6ix)+x(-4+3x))}{(a\pi+ix)^3} \right. \\ \left. + \frac{-a\pi(4+3ia\pi+6x)+i(-8+x(4+3x))}{(ia\pi+x)^3} \right) \log(1-e^{-2x}) \sinh(x) dx$$

$$= -\frac{4i}{a} + 8ie^{\frac{1}{2}(-3)ia\pi} \left( e^{2ia\pi} \Gamma \left( 0, \frac{ia\pi}{2} \right) + \Gamma \left( 0, \frac{1}{2}(-3)ia\pi \right) \right) - 8\Phi(-i, 1, 1+a)$$

EXAMPLE 5.94. Entry (2.4.14.11) in [8].

$$(5.94) \quad \int_{-\infty}^{\infty} \frac{e^{mx} x^k \cosh(\alpha)}{\sinh(x) + \sinh(\alpha)} dx \\ = ie^{\frac{ik\pi}{2} - m\alpha} \pi \left( (i\alpha)^k - e^{im\pi} \pi^k \left( \Phi \left( -e^{im\pi}, -k, 1 + \frac{i\alpha}{\pi} \right) \right. \right. \\ \left. \left. + e^{2m\alpha} \left( \Phi \left( -e^{im\pi}, -k, 1 - \frac{i\alpha}{\pi} \right) + \Phi \left( e^{im\pi}, -k, 1 - \frac{i\alpha}{\pi} \right) \right) - \Phi \left( e^{im\pi}, -k, 1 + \frac{i\alpha}{\pi} \right) \right) \right)$$

EXAMPLE 5.95. Entry (2.4.14.12) in [8].

$$(5.95) \quad \int_{-\infty}^{\infty} \frac{e^{mx} x^k}{(\sinh(x) + \sinh(\alpha))^2} dx \\ = \frac{e^{\frac{ik\pi}{2} - m\alpha}}{\alpha} \operatorname{sech}^2(\alpha) \left( e^{im\pi + 2m\alpha} k \pi^k \alpha \Phi \left( -e^{im\pi}, 1 - k, 1 - \frac{i\alpha}{\pi} \right) \right. \\ \left. - e^{im\pi} k \pi^k \alpha \Phi \left( -e^{im\pi}, 1 - k, 1 + \frac{i\alpha}{\pi} \right) + e^{im\pi + 2m\alpha} k \pi^k \alpha \Phi \left( e^{im\pi}, 1 - k, 1 - \frac{i\alpha}{\pi} \right) \right. \\ \left. + e^{im\pi} k \pi^k \alpha \Phi \left( e^{im\pi}, 1 - k, 1 + \frac{i\alpha}{\pi} \right) + ie^{im\pi + 2m\alpha} \pi^{1+k} \alpha \Phi \left( -e^{im\pi}, -k, 1 - \frac{i\alpha}{\pi} \right) (m - \tanh(\alpha)) \right. \\ \left. + ie^{im\pi + 2m\alpha} \pi^{1+k} \alpha \Phi \left( e^{im\pi}, -k, 1 - \frac{i\alpha}{\pi} \right) (m - \tanh(\alpha)) \right. \\ \left. - ie^{im\pi} \pi^{1+k} \alpha \Phi \left( -e^{im\pi}, -k, 1 + \frac{i\alpha}{\pi} \right) (m + \tanh(\alpha)) \right. \\ \left. + ie^{im\pi} \pi^{1+k} \alpha \Phi \left( e^{im\pi}, -k, 1 + \frac{i\alpha}{\pi} \right) (m + \tanh(\alpha)) - i\pi(i\alpha)^k (k - m\alpha - \alpha \tanh(\alpha)) \right)$$

EXAMPLE 5.96. Entry 2.4.14.14 in [8].

$$(5.96) \quad \int_{-\infty}^{\infty} e^{-imx} x^k \operatorname{csch}(x) dx = 2i(-i)^{-k} \pi^{1+k} \operatorname{Li}_{-k}(-e^{m\pi})$$

EXAMPLE 5.97. Frullani integral given in Eq. (2.4.14.15) in [8] and pp. 406-407 in [44].

$$(5.97) \quad \int_{-\infty}^{\infty} \frac{-e^{mx} + e^{px}}{x(\sinh(x) + \sinh(\alpha))} dx \\ = \frac{1}{\alpha} \left( ie^{-m\alpha} \pi - ie^{-p\alpha} \pi + e^{m(i\pi + \alpha)} \alpha \left( \Phi \left( -e^{im\pi}, 1, 1 - \frac{i\alpha}{\pi} \right) \right. \right. \\ \left. \left. + \Phi \left( e^{im\pi}, 1, 1 - \frac{i\alpha}{\pi} \right) + e^{-2m\alpha} \left( \Phi \left( -e^{im\pi}, 1, 1 + \frac{i\alpha}{\pi} \right) - \Phi \left( e^{im\pi}, 1, 1 + \frac{i\alpha}{\pi} \right) \right) \right) \right) \\ - e^{p(i\pi + \alpha)} \alpha \left( \Phi \left( -e^{ip\pi}, 1, 1 - \frac{i\alpha}{\pi} \right) + \Phi \left( e^{ip\pi}, 1, 1 - \frac{i\alpha}{\pi} \right) + e^{-2p\alpha} \left( \Phi \left( -e^{ip\pi}, 1, 1 + \frac{i\alpha}{\pi} \right) \right. \right.$$

$$-\Phi\left(e^{ip\pi}, 1, 1 + \frac{i\alpha}{\pi}\right)\right)\right) \operatorname{sech}(\alpha)$$

EXAMPLE 5.98. Highly oscillatory integrand.

$$(5.98) \quad \int_{-\infty}^{\infty} e^{ux} \operatorname{csch}^2(x) \sinh(mx) dx = \frac{\pi(u \sin(m\pi) - m \sin(\pi u))}{\cos(m\pi) - \cos(\pi u)}$$

EXAMPLE 5.99. Hilbert transform see section (1.14) in [3], in terms of the Hypergeometric function.

$$(5.99) \quad \int_{-\infty}^{\infty} \frac{\operatorname{csch}(x)(x \cos(mx) + a\pi \sin(mx))}{a^2\pi^2 + x^2} dx = \frac{1}{a} - 2e^{-m\pi} \Phi(-e^{-m\pi}, 1, 1 + a)$$

EXAMPLE 5.100.

$$(5.100) \quad \int_{-\infty}^{\infty} \frac{\pi \operatorname{csch}(x) (-2a\pi x \cos(mx) + (-a^2\pi^2 + x^2) \sin(mx))}{(a^2\pi^2 + x^2)^2} dx \\ = -\frac{1}{a^2} + 2e^{-m\pi} \Phi(-e^{-m\pi}, 2, 1 + a)$$

EXAMPLE 5.101.

$$(5.101) \quad \int_0^{\infty} \frac{x^{-1+s} \cosh(cx) \sinh(mx)}{3 + \cosh(2cx)} dx \\ = \frac{i(1 + \sqrt{2})^{-\frac{m}{c}} c^{-s} e^{-\frac{im\pi}{2c}} \pi^s}{8\sqrt{2}} \left( \Phi\left(-e^{-\frac{im\pi}{c}}, 1 - s, \frac{1}{2} - \frac{i \sinh^{-1}(1)}{\pi}\right) \right. \\ \left. + (1 + \sqrt{2})^{\frac{2m}{c}} \Phi\left(-e^{-\frac{im\pi}{c}}, 1 - s, \frac{1}{2} + \frac{i \sinh^{-1}(1)}{\pi}\right) \right. \\ \left. - e^{\frac{im\pi}{c}} \left( (1 + \sqrt{2})^{\frac{2m}{c}} \Phi\left(-e^{\frac{im\pi}{c}}, 1 - s, \frac{1}{2} - \frac{i \sinh^{-1}(1)}{\pi}\right) \right. \right. \\ \left. \left. + \Phi\left(-e^{\frac{im\pi}{c}}, 1 - s, \frac{1}{2} + \frac{i \sinh^{-1}(1)}{\pi}\right) \right) \right) \sec\left(\frac{\pi s}{2}\right)$$

EXAMPLE 5.102.

$$(5.102) \quad \int_0^{\infty} \frac{\cosh(cx) \cosh(mx)}{3 + \cosh(2cx)} dx = \frac{\pi \cosh\left(\frac{m \sinh^{-1}(1)}{c}\right) \sec\left(\frac{m\pi}{2c}\right)}{4\sqrt{2}c}$$

EXAMPLE 5.103.

$$(5.103) \quad \int_0^{\infty} \frac{x^{-1+s} \cosh(x)}{3 + \cosh(2x)} dx \\ = 2^{-\frac{7}{2}+s} \pi^s \csc\left(\frac{\pi s}{2}\right) \left( \zeta\left(1 - s, \frac{\pi - 2i \sinh^{-1}(1)}{4\pi}\right) + \zeta\left(1 - s, \frac{\pi + 2i \sinh^{-1}(1)}{4\pi}\right) \right) \\ - \zeta\left(1 - s, \frac{3}{4} - \frac{i \sinh^{-1}(1)}{2\pi}\right) - \zeta\left(1 - s, \frac{3}{4} + \frac{i \sinh^{-1}(1)}{2\pi}\right)$$

EXAMPLE 5.104.

$$(5.104) \quad \int_0^\infty \frac{x \cosh(cx) \sinh(mx)}{3 + \cosh(2cx)} dx$$

$$= \frac{\pi \sec\left(\frac{m\pi}{2c}\right) \left(2 \sinh^{-1}(1) \sinh\left(\frac{m \sinh^{-1}(1)}{c}\right) + \pi \cosh\left(\frac{m \sinh^{-1}(1)}{c}\right) \tan\left(\frac{m\pi}{2c}\right)\right)}{8\sqrt{2}c^2}$$

EXAMPLE 5.105.

$$(5.105) \quad \int_0^\infty \frac{x^{-2m} \left(\log^k\left(\frac{1}{x}\right) + x^{4m} \left(-\log\left(\frac{1}{x}\right)\right)^k\right)}{(-1+x)^2} dx$$

$$= 2^{1-k} \left( (4i\pi)^k (k\text{Li}_{1-k}(e^{4im\pi}) + 4im\pi \text{Li}_{-k}(e^{4im\pi})) \right)$$

EXAMPLE 5.106.

$$(5.106) \quad \int_0^\infty \frac{\log^2(x) \left(\log\left(\log\left(\frac{1}{x}\right)\right) + x \log(\log(x))\right)}{(-1+x)^2 \sqrt{x}} dx$$

$$= \frac{2}{3} \pi^2 \left( 9 + \log\left(\frac{16384}{A^{72}}\right) + 6 \log(i\pi) + 84i\pi \zeta'(-2) \right)$$

EXAMPLE 5.107.

$$(5.107) \quad \int_0^\infty \frac{\log^k\left(\frac{1}{x}\right) + x \log^k(x)}{(-1+x)^2 \sqrt{x}} dx = 2^{1+k} (i\pi)^k \left( (-1+2^k) k\zeta(1-k) + i(-1+2^{1+k}) \pi \zeta(-k) \right)$$

EXAMPLE 5.108.

$$(5.108) \quad \int_0^\infty \frac{-2a \log(a) + (a - 2 \log(x)) \log(a - 2 \log(x)) + (a + 2 \log(x)) \log(a + 2 \log(x))}{(-1+x)^2} dx$$

$$= a(-2 - i\pi - 2 \log(4\pi) + 2 \log(a))$$

$$+ 2\pi \left( \pi - 4i \log(-ia) + 2i \log(8\pi^2 a) \right) - 8i\pi \log \Gamma\left(-\frac{ai}{4\pi}\right)$$

EXAMPLE 5.109.

$$(5.109) \quad \int_0^\infty \frac{\sin(mx) \left(-1 + \tanh\left(\frac{x\alpha}{2}\right)\right)}{x^2 + a^2} dx$$

$$= \frac{1}{2a} \left( -ie^{-am} \pi + e^{-\frac{m\pi}{\alpha}} \Phi\left(e^{-\frac{2m\pi}{\alpha}}, 1, \frac{\pi + a\alpha}{2\pi}\right) \right)$$

$$- e^{-\frac{m\pi}{\alpha}} \Phi\left(e^{\frac{2m\pi}{\alpha}}, 1, \frac{\pi + a\alpha}{2\pi}\right) + 2\text{Chi}(am) \sinh(am) - 2 \cosh(am) \text{Shi}(am)$$

EXAMPLE 5.110.

$$(5.110) \quad \int_0^\infty x^{-1+s} \sin(mx) \left(-1 + \tanh\left(\frac{x\alpha}{2}\right)\right) dx$$

$$\begin{aligned}
&= \frac{1}{2} \csc\left(\frac{\pi s}{2}\right) \left( (-1 + e^{-i\pi s}) m^{-s} \Gamma(s) \right. \\
&+ e^{-\frac{m\pi}{\alpha}} (2\pi)^s \left(\frac{1}{\alpha}\right)^s \left( \Phi\left(e^{-\frac{2m\pi}{\alpha}}, 1-s, \frac{1}{2}\right) - e^{\frac{2m\pi}{\alpha}} \Phi\left(e^{\frac{2m\pi}{\alpha}}, 1-s, \frac{1}{2}\right) \right) \left. \right)
\end{aligned}$$

EXAMPLE 5.111. Cosine transform.

$$\begin{aligned}
(5.111) \quad & \int_0^\infty \cos(mx) \left(-1 + \tanh\left(\frac{x\alpha}{2}\right)\right) dx \\
&= \frac{i}{m} + \frac{2e^{-\frac{m\pi}{\alpha}} \left( \Phi'\left(e^{-\frac{2m\pi}{\alpha}}, 0, \frac{1}{2}\right) + e^{\frac{2m\pi}{\alpha}} \Phi'\left(e^{\frac{2m\pi}{\alpha}}, 0, \frac{1}{2}\right) \right)}{\alpha}
\end{aligned}$$

EXAMPLE 5.112.

$$\begin{aligned}
(5.112) \quad & \int_0^\infty \left( (-ix + \log(a))^k + (ix + \log(a))^k \right) \sin(mx) \left(-1 + \tanh\left(\frac{x\alpha}{2}\right)\right) dx \\
&= -\frac{a^{-m} (-m)^{-k} \Gamma(1+k, -m \log(a)) + a^m m^{-k} \Gamma(1+k, m \log(a))}{m} \\
&\quad - e^{-\frac{m\pi}{\alpha}} (2\pi)^{1+k} \left(\frac{1}{\alpha}\right)^{1+k} \left( -\Phi\left(e^{-\frac{2m\pi}{\alpha}}, -k, \frac{\pi + \alpha \log(a)}{2\pi}\right) \right. \\
&\quad \left. + e^{\frac{2m\pi}{\alpha}} \Phi\left(e^{\frac{2m\pi}{\alpha}}, -k, \frac{\pi + \alpha \log(a)}{2\pi}\right) \right)
\end{aligned}$$

EXAMPLE 5.113.

$$\begin{aligned}
(5.113) \quad & \int_0^\infty \frac{(b - i \log(x)) \log\left(x^t \left(1 + \frac{1}{x}\right)_t\right)}{x (a^2 + b^2 - 2ib \log(x) - \log^2(x))^2} dx \\
&= \sum_{m=1}^t \frac{i \left( \psi^{(0)}\left(\frac{\pi - i \log(e^{-a+ib}) + i \log(m)}{2\pi}\right) - \psi^{(0)}\left(\frac{\pi - i \log(e^{a+ib}) + i \log(m)}{2\pi}\right) \right)}{4a}
\end{aligned}$$

EXAMPLE 5.114.

$$(5.114) \quad \int_0^\infty \frac{(4\pi^4 - 3 \log^4(x)) \log(1+x)}{x (4\pi^4 + \log^4(x))^2} dx = \frac{2 - \pi \coth\left(\frac{\pi}{2}\right)}{4\pi^2}$$

EXAMPLE 5.115.

$$\begin{aligned}
(5.115) \quad & \int_0^\infty \log(x^2 + a^2) \log(1 + \cos(\alpha) \operatorname{sech}(x)) dx \\
&= \frac{1}{4} (\pi^2 - 4\alpha^2) (-1 + \log(2) + \log(\pi)) + 4\pi^2 \left( -\zeta'\left(-1, \frac{\pi - \alpha + a}{2\pi}\right) \right. \\
&\quad \left. - \zeta'\left(-1, \frac{\pi + \alpha + a}{2\pi}\right) + \zeta'\left(-1, \frac{\pi + 2a}{4\pi}\right) + \zeta'\left(-1, \frac{3}{4} + \frac{a}{2\pi}\right) \right)
\end{aligned}$$

EXAMPLE 5.116.

$$(5.116) \quad \int_0^\infty x^{-1+s} \log(1 + \cos(\alpha) \operatorname{sech}(x)) dx$$



$$= \frac{2^{-s}\pi^{1+s} \csc\left(\frac{\pi s}{2}\right) \left(4^s \zeta\left(-s, \frac{\pi-\alpha}{2\pi}\right) + 4^s \zeta\left(-s, \frac{\pi+\alpha}{2\pi}\right) + (-1+2^s)\zeta(-s)\right)}{s}$$

EXAMPLE 5.117.

$$(5.117) \quad \int_0^\infty x \log(1 + \cos(\alpha)\operatorname{sech}(x)) dx \\ = -\frac{1}{16}(3\zeta(3)) + 4\pi^2 \left( \zeta' \left( -2, \frac{\pi-\alpha}{2\pi} \right) + \zeta' \left( -2, \frac{\pi+\alpha}{2\pi} \right) \right)$$

EXAMPLE 5.118. Errata for equation (4.4.4) in [13].

$$(5.118) \quad \int_0^\infty \frac{x^{-1+m} \log(x)}{x+\alpha} dx = \pi \alpha^{-1+m} \csc(m\pi) (-\pi \cot(m\pi) + \log(\alpha))$$

EXAMPLE 5.119.

$$(5.119) \quad \int_0^\infty \frac{i^{-2m} x^{1-2m} (\pi i^{2m+1} (x^{4m} - 1) + 2(1+i^{2m})(-1+i^{2m}x^{4m}) \log(x))}{2 \log(x)(2 \log(x) + i\pi)(\cos(x) + \cosh(x))} dx \\ = \sum_{p=0}^\infty \frac{\left(\frac{i}{2}\right)^{-m} \pi^{2-2m} (-1)^p (2p+1)^{1-2m} \left(-1 + \left(\frac{i}{2}\right)^{2m} (2\pi p + \pi)^{4m}\right) \operatorname{sech}\left(\pi\left(p + \frac{1}{2}\right)\right)}{\log\left(\frac{1}{2}i(2\pi p + \pi)^2\right)}$$

EXAMPLE 5.120.

$$(5.120) \quad \int_{-\infty}^\infty \frac{e^{\frac{3x}{2}}}{(-i+e^x)(1+\sqrt[4]{-1}e^x)x} dx \\ = -\frac{1}{2}(-1+\sqrt[4]{-1})\pi + \sqrt{2} \log\left(\cot\left(\frac{3\pi}{16}\right)\right) + \log\left(\cot\left(\frac{\pi}{8}\right)\cot\left(\frac{3\pi}{16}\right)\tan\left(\frac{\pi}{16}\right)\right) \\ + (-1)^{3/4} \log\left(\tan\left(\frac{\pi}{8}\right)\right)$$

EXAMPLE 5.121.

$$(5.121) \quad \int_{-\infty}^\infty \frac{e^{\frac{5x}{4}} \log(-ix + \log(a))}{(1+e^x\alpha)(1+e^x\beta)} dx \\ = \frac{\sqrt{2}\pi}{\sqrt[4]{\alpha}(\alpha-\beta)\sqrt[4]{\beta}} \left( -\sqrt[4]{\beta} \log(2\pi) + \sqrt[4]{\alpha} \log(8\pi) \right) \\ + (1+i)\sqrt[4]{\beta} \left( -i \log\left(\frac{\Gamma\left(\frac{\pi+\log(a)+i\log(\alpha)}{8\pi}\right)}{2\Gamma\left(\frac{5\pi+\log(a)+i\log(\alpha)}{8\pi}\right)}\right) + \log\left(\frac{\Gamma\left(\frac{3\pi+\log(a)+i\log(\alpha)}{8\pi}\right)}{2\Gamma\left(\frac{7\pi+\log(a)+i\log(\alpha)}{8\pi}\right)}\right) \right) \\ - (1-i)\sqrt[4]{\alpha} \left( \log\left(\frac{\Gamma\left(\frac{\pi+\log(a)+i\log(\beta)}{8\pi}\right)}{\Gamma\left(\frac{5\pi+\log(a)+i\log(\beta)}{8\pi}\right)}\right) + i \log\left(\frac{\Gamma\left(\frac{3\pi+\log(a)+i\log(\beta)}{8\pi}\right)}{\Gamma\left(\frac{7\pi+\log(a)+i\log(\beta)}{8\pi}\right)}\right) \right) \right)$$

EXAMPLE 5.122.

$$(5.122) \quad \int_{-\infty}^\infty \frac{e^{\frac{3x}{2}} \log(-ix + \log(a))}{(1+e^x\alpha)(1+e^x\beta)} dx$$

$$\begin{aligned}
&= \frac{2\pi}{\sqrt{\alpha}(\alpha-\beta)\sqrt{\beta}} \left( \frac{1}{2} (\sqrt{\alpha} - \sqrt{\beta}) \log(4\pi) + \sqrt{\beta}(\log(-3\pi + \log(a) + i \log(\alpha)) \right. \\
&\quad \left. - \log(-\pi + \log(a) + i \log(\alpha))) + \sqrt{\alpha}(-\log(-3\pi + \log(a) + i \log(\beta)) \right. \\
&\quad \left. + \log(-\pi + \log(a) + i \log(\beta))) + \sqrt{\beta} \left( \log \Gamma \left( \frac{-3\pi + \log(a) + i \log(\alpha)}{4\pi} \right) \right. \right. \\
&\quad \left. \left. - \log \Gamma \left( \frac{-\pi + \log(a) + i \log(\alpha)}{4\pi} \right) \right) + \sqrt{\alpha} \left( -\log \Gamma \left( \frac{-3\pi + \log(a) + i \log(\beta)}{4\pi} \right) \right. \right. \\
&\quad \left. \left. + \log \Gamma \left( \frac{-\pi + \log(a) + i \log(\beta)}{4\pi} \right) \right) \right)
\end{aligned}$$

EXAMPLE 5.123.

$$\begin{aligned}
(5.123) \quad &\int_{-\infty}^{\infty} \frac{e^{\frac{3x}{2}} \log(-ix + \log(a))}{(1 + e^x \alpha)(1 + e^x \beta)(-ix + \log(a))} dx \\
&= \frac{\log(4\pi)}{2\sqrt{\alpha}(\alpha-\beta)\sqrt{\beta}} \left( \sqrt{\beta} \left( \psi^{(0)} \left( \frac{\pi + \log(a) + i \log(\alpha)}{4\pi} \right) - \psi^{(0)} \left( \frac{3\pi + \log(a) + i \log(\alpha)}{4\pi} \right) \right) \right. \\
&\quad \left. + \sqrt{\alpha} \left( -\psi^{(0)} \left( \frac{\pi + \log(a) + i \log(\beta)}{4\pi} \right) + \psi^{(0)} \left( \frac{3\pi + \log(a) + i \log(\beta)}{4\pi} \right) \right) \right) \\
&\quad + \sqrt{\beta} \left( -\gamma_1 \left( \frac{\pi + \log(a) + i \log(\alpha)}{4\pi} \right) + \gamma_1 \left( \frac{3\pi + \log(a) + i \log(\alpha)}{4\pi} \right) \right) \\
&\quad + \sqrt{\alpha} \left( \gamma_1 \left( \frac{\pi + \log(a) + i \log(\beta)}{4\pi} \right) - \gamma_1 \left( \frac{3\pi + \log(a) + i \log(\beta)}{4\pi} \right) \right)
\end{aligned}$$

EXAMPLE 5.124.

$$\begin{aligned}
(5.124) \quad &\int_{-\infty}^{\infty} \frac{-e^{x(2-im-\lambda)} + e^{x(2-ir-\lambda)}}{x(1 + e^x \alpha)(1 + e^x \beta)} dx \\
&= \frac{e^{-i\pi\lambda}}{\alpha(\alpha-\beta)\beta} \left( e^{m\pi} \alpha^{im+\lambda} \beta \Phi \left( e^{2\pi(m-i\lambda)}, 1, \frac{\pi + i \log(\alpha)}{2\pi} \right) \right. \\
&\quad \left. - e^{m\pi} \alpha \beta^{im+\lambda} \Phi \left( e^{2\pi(m-i\lambda)}, 1, \frac{\pi + i \log(\beta)}{2\pi} \right) + e^{\pi r} \left( -\alpha^{ir+\lambda} \beta \Phi \left( e^{2\pi(r-i\lambda)}, 1, \frac{\pi + i \log(\alpha)}{2\pi} \right) \right. \right. \\
&\quad \left. \left. + \alpha \beta^{ir+\lambda} \Phi \left( e^{2\pi(r-i\lambda)}, 1, \frac{\pi + i \log(\beta)}{2\pi} \right) \right) \right)
\end{aligned}$$

EXAMPLE 5.125.

$$\begin{aligned}
(5.125) \quad &\int_{-\infty}^{\infty} \frac{e^{-x(-2+\lambda)} \cos(mx)(-ix + \log(a))^k}{(1 + e^x \alpha)(1 + e^x \beta)} dx \\
&= -\frac{i2^k e^{-\pi(m+i\lambda)} \pi^{1+k} \alpha^{-1-im} \beta^{-1-im}}{\alpha-\beta} \\
&\quad \left( \alpha^\lambda \beta^{1+im} \left( e^{2m\pi} \alpha^{2im} \Phi \left( e^{2\pi(m-i\lambda)}, -k, \frac{\pi + \log(a) + i \log(\alpha)}{2\pi} \right) \right. \right. \\
&\quad \left. \left. + \Phi \left( e^{-2\pi(m+i\lambda)}, -k, \frac{\pi + \log(a) + i \log(\alpha)}{2\pi} \right) \right) \right)
\end{aligned}$$

$$-\alpha^{1+im}\beta^\lambda \left( e^{2m\pi}\beta^{2im}\Phi \left( e^{2\pi(m-i\lambda)}, -k, \frac{\pi + \log(a) + i\log(\beta)}{2\pi} \right) \right. \\ \left. + \Phi \left( e^{-2\pi(m+i\lambda)}, -k, \frac{\pi + \log(a) + i\log(\beta)}{2\pi} \right) \right)$$

EXAMPLE 5.126.

$$(5.126) \quad \int_0^{\frac{1}{2}} \left( \sum_{p=0}^{\infty} \sum_{q=0}^{\infty} \frac{(-\frac{1}{a})^{p+q} v\Gamma(1+p-v)\Gamma(q+v)(1-k)_{-1+p+q}}{\Gamma(1+p)\Gamma(1+q)} \right) dv = -\frac{2aCe^a E_{-k}(a)}{k\pi}$$

EXAMPLE 5.127.

$$(5.127) \quad \int_0^{\infty} x^{-1+s} \log(1-e^{-x\alpha}) (mx \cos(mx) + s \sin(mx)) dx \\ = \frac{1}{2} \left( e^{\frac{i\pi s}{2}} m^{-1-s} \alpha \Gamma(1+s) - \left( \frac{2}{\alpha} \right)^s \pi^{1+s} \left( \text{Li}_{-s} \left( e^{-\frac{2m\pi}{\alpha}} \right) - \text{Li}_{-s} \left( e^{\frac{2m\pi}{\alpha}} \right) \right) \sec \left( \frac{\pi s}{2} \right) \right)$$

EXAMPLE 5.128.

$$(5.128) \quad \int_0^{\infty} q^{-\frac{ix\alpha}{2\pi}} x^{-1+s} \log(1-e^{-x\alpha}) \left( 2i\pi s + x\alpha \log(q) + q^{\frac{ix\alpha}{\pi}} (-2i\pi s + x\alpha \log(q)) \right) dx \\ = e^{\frac{i\pi s}{2}} \pi \alpha (\alpha \log(q))^{-1-s} \left( 2^{2+s} \pi^{1+s} \Gamma(1+s) + ie^{-\frac{1}{2}i\pi(k+s)} (2\pi)^{-k+s} \left( \frac{1}{\alpha} \right)^s \Gamma(1+k) \right. \\ \left. \left( \zeta \left( 1+k, -\frac{i\log(q)}{2\pi} \right) - \zeta \left( 1+k, \frac{i\log(q)}{2\pi} \right) \right) \right. \\ \left. + e^{ik\pi} \left( \zeta \left( 1+k, 1 - \frac{i\log(q)}{2\pi} \right) - \zeta \left( 1+k, 1 + \frac{i\log(q)}{2\pi} \right) \right) \right) \log(q) (\alpha \log(q))^s \sec \left( \frac{\pi s}{2} \right)$$

EXAMPLE 5.129.

$$(5.129) \quad \int_0^{\infty} q^{-\frac{ix\alpha}{2\pi}} x^{-1+s} \log(1-e^{-x\alpha}) \left( 2i\pi s + x\alpha \log(q) + q^{\frac{ix\alpha}{\pi}} (-2i\pi s + x\alpha \log(q)) \right) dx \\ = e^{\frac{i\pi s}{2}} (2\pi)^{2+s} \alpha \Gamma(1+s) (\alpha \log(q))^{-1-s} - i2^{1+s} \pi^{2+s} \left( \frac{1}{\alpha} \right)^s (\pi - i\log(q)) \sec \left( \frac{\pi s}{2} \right)$$

EXAMPLE 5.130.

$$(5.130) \quad \int_0^{\infty} \frac{\log(1-e^{-x\alpha}) (m(a^2+x^2) \cos(mx) - 2x \sin(mx))}{(a^2+x^2)^2} dx \\ = \frac{\alpha}{4a} \left( -e^{-am} \Gamma(0, -am) + e^{am} \Gamma(0, am) - e^{-\frac{2m\pi}{\alpha}} \Phi \left( e^{-\frac{2m\pi}{\alpha}}, 1, 1 + \frac{a\alpha}{2\pi} \right) \right. \\ \left. + e^{\frac{2m\pi}{\alpha}} \Phi \left( e^{\frac{2m\pi}{\alpha}}, 1, 1 + \frac{a\alpha}{2\pi} \right) \right)$$

EXAMPLE 5.131.

$$\begin{aligned}
(5.131) \quad & \int_0^\infty e^{-mx} x^{-1+k} \left( (-1)^k (-k + mx) + e^{2mx} (k + mx) \right) \coth^{-1}(e^{x\alpha}) dx \\
& = \frac{1}{2} \left( - \left( \frac{2\pi i}{\alpha} \right)^{1+k} \right) \alpha \left( e^{\frac{im\pi}{\alpha}} \Phi \left( e^{\frac{2im\pi}{\alpha}}, -k, \frac{1}{2} \right) - \text{Li}_{-k} \left( e^{\frac{2im\pi}{\alpha}} \right) \right)
\end{aligned}$$

EXAMPLE 5.132.

$$\begin{aligned}
(5.132) \quad & \int_0^\infty x^{-1+k} \coth^{-1}(e^{x\alpha}) (mx \cos(mx) + k \sin(mx)) dx \\
& = -2^{-2+k} \pi^{1+k} \sec \left( \frac{k\pi}{2} \right) \left( e^{-\frac{m\pi}{\alpha}} \left( \frac{1}{\alpha} \right)^k \left( \Phi \left( e^{-\frac{2m\pi}{\alpha}}, -k, \frac{1}{2} \right) - e^{\frac{2m\pi}{\alpha}} \Phi \left( e^{\frac{2m\pi}{\alpha}}, -k, \frac{1}{2} \right) \right) \right. \\
& \quad \left. + \alpha^{-k} \left( -\text{Li}_{-k} \left( e^{-\frac{2m\pi}{\alpha}} \right) + \text{Li}_{-k} \left( e^{\frac{2m\pi}{\alpha}} \right) \right) \right)
\end{aligned}$$

EXAMPLE 5.133.

$$(5.133) \quad \int_0^\infty \frac{\coth^{-1}(e^{x\alpha})}{a^2 + x^2} dx = \frac{\pi \log \left( \frac{\sqrt{a}\sqrt{\alpha}\Gamma\left(\frac{a\alpha}{2\pi}\right)}{\sqrt{2\pi}\Gamma\left(\frac{\pi+a\alpha}{2\pi}\right)} \right)}{2a}$$

EXAMPLE 5.134.

$$(5.134) \quad \int_0^\infty \frac{\coth^{-1}(e^{b \sinh(t)})}{\cosh(t)} dt = \frac{1}{2} \pi \log \left( \frac{\sqrt{b}\Gamma\left(\frac{b}{2\pi}\right)}{\sqrt{2\pi}\Gamma\left(\frac{b+\pi}{2\pi}\right)} \right)$$

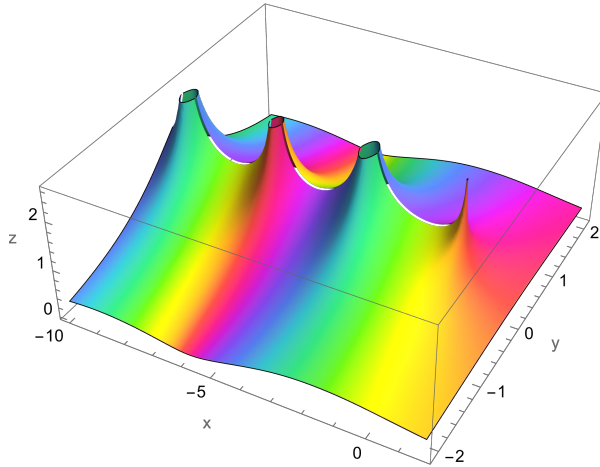

FIGURE 2. Plot of  $f(b) = \log \left( \frac{\sqrt{b}\Gamma\left(\frac{b}{2\pi}\right)}{\sqrt{2\pi}\Gamma\left(\frac{b+\pi}{2\pi}\right)} \right)$ ,  $b \in \mathbb{C}$ .

EXAMPLE 5.135.

$$(5.135) \quad \int_0^\infty q^{-x} \coth^{-1}(e^{2\pi x\alpha}) \left( -\frac{\alpha + (-ib + x\alpha) \log(q)}{(b + ix\alpha)^2} + \frac{q^{2x}(-\alpha + (ib + x\alpha) \log(q))}{(b - ix\alpha)^2} \right) dx$$

$$= \frac{1}{2}\pi \left( \frac{1}{b} + 2q^{-\frac{i}{2\alpha}} \Phi \left( q^{-\frac{i}{\alpha}}, 1, \frac{1}{2} - b \right) - 2q^{-\frac{i}{\alpha}} \Phi \left( q^{-\frac{i}{\alpha}}, 1, 1 - b \right) \right)$$

EXAMPLE 5.136.

$$(5.136) \quad \int_0^\infty q^x \log(1 - e^{-2\pi x \alpha}) \left( \frac{-1 + (-a+x)\log(q)}{(a-x)^2} + \frac{q^{-2x}(-1 - (a+x)\log(q))}{(a+x)^2} \right) dx$$

$$= \frac{\pi \left( i + 2aq^a \alpha \Gamma(0, a \log(q)) - aq^{i/\alpha} \alpha \left( \Phi \left( q^{\frac{2i}{\alpha}}, 1, \frac{1}{2} + \frac{ia\alpha}{2} \right) + q^{i/\alpha} \Phi \left( q^{\frac{2i}{\alpha}}, 1, 1 + \frac{ia\alpha}{2} \right) \right) \right)}{a}$$

EXAMPLE 5.137.

$$(5.137) \quad \int_0^\infty q^{-x} x^{k-1} (-k + x \log(q) + (-1)^{-k} q^{2x} (k + x \log(q))) \log(1 - q^{-4x}) dx$$

$$= i^{-k} \left( -4\Gamma(1+k)(-i \log(q))^{-k} + 2\pi \log^{-k}(q) \left( (2\pi)^k \left( \zeta \left( -k, \frac{1}{4} \right) - \zeta \left( -k, \frac{3}{4} \right) \right) - i(-1 + 2^{1+k}) \pi^k \zeta(-k) \right) \right)$$

EXAMPLE 5.138.

$$(5.138) \quad \int_0^\infty q^x ((-ix + \log(a))^{-1+k} + q^{-2x} (ix + \log(a))^{-1+k} + \frac{i((-ix + \log(a))^k + q^{-2x} (ix + \log(a))^k) \log(q)}{k}) \log(1 - q^{-4x}) dx$$

$$= \frac{1}{k} \left( \pi \log^k(a) - 4ia^{-i \log(q)} \Gamma(1+k, -i \log(a) \log(q)) (-i \log(q))^{-k} + (2\pi)^{1+k} \left( -\zeta \left( -k, \frac{\pi + \log(a) \log(q)}{2\pi} \right) + i \left( \zeta \left( -k, \frac{\pi + 2 \log(a) \log(q)}{4\pi} \right) - \zeta \left( -k, \frac{3}{4} + \frac{\log(a) \log(q)}{2\pi} \right) \right) + \zeta \left( -k, 1 + \frac{\log(a) \log(q)}{2\pi} \right) \right) \log^{-k}(q) \right)$$

EXAMPLE 5.139.

$$(5.139) \quad \int_0^\infty q^x \left( \frac{1}{(a-ix)^2} + \frac{q^{-2x}}{(a+ix)^2} - i \left( \frac{1}{a-ix} + \frac{q^{-2x}}{a+ix} \right) \log(q) \right) \log(1 - q^{-4x}) dx$$

$$= -\frac{\pi}{a} + 4q^{-ia} \Gamma(0, -ia \log(q)) \log(q) - \log(q) \psi^{(0)} \left( \frac{\pi + a \log(q)}{2\pi} \right) + i \log(q) \psi^{(0)} \left( \frac{\pi + 2a \log(q)}{4\pi} \right) - i \log(q) \psi^{(0)} \left( \frac{3}{4} + \frac{a \log(q)}{2\pi} \right) + \log(q) \psi^{(0)} \left( 1 + \frac{a \log(q)}{2\pi} \right)$$

EXAMPLE 5.140.

$$(5.140) \quad \int_0^\infty \frac{e^{-mx} \log(1 - e^{-4mx})}{a^2 + x^2} (a + e^{2mx} (a + ix) - ix + im(a^2 + x^2) (e^{2mx} \log(a - ix) + \log(a + ix))) dx$$

$$= \log \left( \left( \frac{1}{a} \right)^{4i} a^\pi e^{-4ie^{-iam}\Gamma(0, -iam)} m^{(1-i)\pi} (2\pi)^{(-1+i)\pi} \left( \frac{\Gamma\left(\frac{am+\pi}{2\pi}\right) \left(\frac{\Gamma\left(\frac{3}{4} + \frac{am}{2\pi}\right)\right)^i}{\Gamma\left(1 + \frac{am}{2\pi}\right)} \right)^{2\pi} \right)$$

EXAMPLE 5.141. Mellin transform.

$$(5.141) \quad \int_0^\infty x^{-1+s} \operatorname{sech}(cx) \sinh(mx) \tanh(cx) dx \\ = \frac{1}{2} i^s c^{-1-s} e^{-\frac{im\pi}{2c}} \pi^{-1+s} \left( -i + \cot\left(\frac{\pi s}{2}\right) \right) \left( m\pi \Phi\left(-e^{-\frac{im\pi}{c}}, 1-s, \frac{1}{2}\right) \right. \\ \left. + ic(-1+s) \Phi\left(-e^{-\frac{im\pi}{c}}, 2-s, \frac{1}{2}\right) + e^{\frac{im\pi}{c}} \left( m\pi \Phi\left(-e^{-\frac{im\pi}{c}}, 1-s, \frac{1}{2}\right) \right. \right. \\ \left. \left. - ic(-1+s) \Phi\left(-e^{-\frac{im\pi}{c}}, 2-s, \frac{1}{2}\right) \right) \right)$$

EXAMPLE 5.142.

$$(5.142) \quad \int_0^\infty \left( \frac{\tanh(mx)}{x} \right)^2 dx = \frac{14m\zeta(3)}{\pi^2}$$

EXAMPLE 5.143.

$$(5.143) \quad \int_0^\infty \frac{-2x + 2^{1+2n}x + 3 \coth(2x) - 3 \times 2^n \coth(2^{1+n}x)}{x^3} dx = \frac{12(-1 + 2^{3n})\zeta(3)}{\pi^2}$$

EXAMPLE 5.144.

$$(5.144) \quad \int_0^\infty \frac{3 + x^2 - 3x \coth(x)}{3x^4} dx = \frac{\zeta(3)}{\pi^2}$$

EXAMPLE 5.145.

$$(5.145) \quad \int_0^\infty x^2 \operatorname{sech}(2mx) \sinh(mx) \tanh(2mx) dx = \frac{\pi^2(8 + 3\pi)}{64\sqrt{2}m^3}$$

EXAMPLE 5.146.

$$(5.146) \quad \int_0^\infty (-2 + \cosh(2mx)) \operatorname{sech}^4(mx) dx = 0$$

EXAMPLE 5.147.

$$(5.147) \quad \int_0^\infty \left( \frac{1}{x^2} + \left( -2 - \frac{1}{x^2} \right) \operatorname{sech}^2(mx) + 3 \operatorname{sech}^4(mx) \right) dx = \frac{14m\zeta(3)}{\pi^2}$$

EXAMPLE 5.148.

$$(5.148) \quad \prod_{p=1}^n \int_0^\infty \frac{2^p (2^p x - \tanh(2^p x))}{x^3} dx = 2^{\frac{3}{2}n(1+n)} \pi^{-2n} (7\zeta(3))^n$$

EXAMPLE 5.149.

$$(5.149) \quad 2^{\frac{3}{2}n(1+n)} \prod_{p=1}^n \int_0^\infty \frac{2^{-p} (2^{-p}x - \tanh(2^{-p}x))}{x^3} dx = \left( \frac{7\zeta(3)}{\pi^2} \right)^n$$

EXAMPLE 5.150.

$$(5.150) \quad \int_0^\infty \frac{\log(x) \tanh^2(mx)}{x^2} dx = -\frac{m((7 + 16 \log(2) + 14 \log(m) - 14 \log(\pi))\zeta(3) + 14\zeta'(3))}{\pi^2}$$

EXAMPLE 5.151.

$$(5.151) \quad \int_0^\infty \log(x) \operatorname{sech}(2mx) \sinh(mx) \tanh(2mx) dx = \frac{4 \coth^{-1}(\sqrt{2}) + \sqrt{2}\pi \log\left(\frac{2\pi\Gamma(\frac{5}{8})\Gamma(\frac{7}{8})}{m\Gamma(\frac{1}{8})\Gamma(\frac{3}{8})}\right)}{8m}$$

EXAMPLE 5.152.

$$(5.152) \quad \int_0^\infty \frac{\log^2(x) \tanh^2(mx)}{x^2} dx \\ = \frac{m}{2\pi^2} \left( (7\pi^2 + 32 \log(2)(1 + \log(2)) + 4 \log\left(\frac{m}{\pi}\right) (7 + 16 \log(2) + 7 \log(m) - 7 \log(\pi))) \right. \\ \left. \zeta(3) + 4 \left( 7 + 16 \log(2) + 14 \log\left(\frac{m}{\pi}\right) \right) \zeta'(3) + 28\zeta''(3) \right)$$

EXAMPLE 5.153.

$$(5.153) \quad \int_0^\infty x^{-1+s} \tanh^2(mx) dx = -4^{1-s} (-4 + 2^s) m^{-s} \Gamma(s) \zeta(-1 + s)$$

EXAMPLE 5.154.

$$(5.154) \quad \int_0^\infty x^{-1+s} \left( \frac{mx}{x} - \frac{\tanh(mx)}{x} \right) dx = 4^{1-s} (-4 + 2^s) m^{1-s} \Gamma(-1 + s) \zeta(-1 + s)$$

EXAMPLE 5.155.

$$(5.155) \quad \int_0^\infty x^{-1+s} (-2x + 2^{1+2n}x + 3 \coth(2x) - 3 \times 2^n \coth(2^{1+n}x)) dx \\ = -3 \times 2^{3-2(1+s)} (2^{1+n})^{-1-s} (2^{1+2n+s} - (2^{1+n})^{1+s}) \Gamma(s) \zeta(s)$$

EXAMPLE 5.156.

$$(5.156) \quad \int_0^\infty \log(a^2 - x^2) \operatorname{sech}(c\pi x) \sin(mx) \tanh(c\pi x) dx \\ = -\frac{e^{\frac{m}{c}}}{c^2\pi} \left( -c\Phi\left(-e^{m/c}, 1, \frac{1}{2} - iac\right) - \frac{2m \log\left(\frac{i}{c}\right)}{1 + e^{m/c}} + e^{-\frac{m}{c}} \left( c\Phi\left(-e^{-\frac{m}{c}}, 1, \frac{1}{2} - iac\right) \right. \right. \\ \left. \left. + m\Phi'\left(-e^{-\frac{m}{c}}, 0, \frac{1}{2} - iac\right) \right) + m\Phi'\left(-e^{m/c}, 0, \frac{1}{2} - iac\right) \right)$$

EXAMPLE 5.157.

$$\begin{aligned}
(5.157) \quad & \int_0^\infty \tanh^{-1}\left(\frac{x}{a}\right) \cos(mx) \operatorname{sech}(c\pi x) \tanh(c\pi x) dx \\
&= -\frac{ie^{-\frac{m}{2c}}}{2c^2\pi} \left( c\Phi\left(-e^{-\frac{m}{c}}, 1, \frac{1}{2} - iac\right) + m\Phi'\left(-e^{-\frac{m}{c}}, 0, \frac{1}{2} - iac\right) \right. \\
&\quad \left. + e^{m/c} \left( c\Phi\left(-e^{m/c}, 1, \frac{1}{2} - iac\right) - m\Phi'\left(-e^{m/c}, 0, \frac{1}{2} - iac\right) \right) \right)
\end{aligned}$$

EXAMPLE 5.158.

$$\begin{aligned}
(5.158) \quad & \int_0^\infty \frac{\cosh(mx) \operatorname{sech}(cx) \tanh(cx)}{x} dx \\
&= -\frac{ie^{-\frac{im\pi}{2c}}}{2c\pi} \left( -2e^{\frac{im\pi}{2c}} m\pi \tan^{-1}\left(e^{-\frac{im\pi}{2c}}\right) + ic\Phi\left(-e^{-\frac{im\pi}{c}}, 2, \frac{1}{2}\right) \right. \\
&\quad \left. + e^{\frac{im\pi}{c}} \left( 2e^{-\frac{im\pi}{2c}} m\pi \tan^{-1}\left(e^{\frac{im\pi}{2c}}\right) + ic\Phi\left(-e^{\frac{im\pi}{c}}, 2, \frac{1}{2}\right) \right) \right)
\end{aligned}$$

EXAMPLE 5.159.

$$\begin{aligned}
(5.159) \quad & \int_0^\infty \frac{\operatorname{sech}(2mx) \sinh(mx) \tanh(2mx)}{-a^2 + x^2} dx \\
&= \frac{(-1)^{3/4}}{4a\pi} \left( \pi\Phi\left(-i, 1, \frac{1}{2} - \frac{2iam}{\pi}\right) + 2i\Phi\left(-i, 2, \frac{1}{2} - \frac{2iam}{\pi}\right) \right. \\
&\quad \left. - i\pi\Phi\left(i, 1, \frac{1}{2} - \frac{2iam}{\pi}\right) - 2\Phi\left(i, 2, \frac{1}{2} - \frac{2iam}{\pi}\right) \right)
\end{aligned}$$

EXAMPLE 5.160.

$$\begin{aligned}
(5.160) \quad & \int_0^\infty \frac{q^{x/2} (-1 + q^x)^2 (1 + q^x)}{(1 + q^{2x})^2 (-a^2 + x^2)} dx \\
&= \frac{\sqrt[4]{-1}}{4a\pi} \left( i\pi\Phi\left(-i, 1, \frac{1}{2} - \frac{ia \log(q)}{\pi}\right) - 2\Phi\left(-i, 2, \frac{1}{2} - \frac{ia \log(q)}{\pi}\right) \right. \\
&\quad \left. + \pi\Phi\left(i, 1, \frac{1}{2} - \frac{ia \log(q)}{\pi}\right) - 2i\Phi\left(i, 2, \frac{1}{2} - \frac{ia \log(q)}{\pi}\right) \right)
\end{aligned}$$

EXAMPLE 5.161.

$$\begin{aligned}
(5.161) \quad & \int_0^\infty \frac{(a^2\pi^2 + x^2) \sec(cx) \sinh(mx) \tan(cx)}{(-a^2\pi^2 + x^2)^2} dx \\
&= \frac{ie^{-\frac{m\pi}{2c}}}{2\pi^2} \left( m\pi\Phi\left(-e^{-\frac{m\pi}{c}}, 2, \frac{1}{2} + ac\right) + 2c\Phi\left(-e^{-\frac{m\pi}{c}}, 3, \frac{1}{2} + ac\right) \right. \\
&\quad \left. + e^{\frac{m\pi}{c}} \left( m\pi\Phi\left(-e^{\frac{m\pi}{c}}, 2, \frac{1}{2} + ac\right) - 2c\Phi\left(-e^{\frac{m\pi}{c}}, 3, \frac{1}{2} + ac\right) \right) \right)
\end{aligned}$$

EXAMPLE 5.162.

$$(5.162) \quad \int_0^\infty \frac{(a^2\pi^2 + x^2) \tanh^2(mx)}{(-a^2\pi^2 + x^2)^2} dx = \frac{m}{\pi^2} \psi^{(2)}\left(\frac{1}{2} + iam\right)$$



EXAMPLE 5.163.

$$(5.163) \quad \int_0^\infty \frac{(-1+q^x)^2 (a^2\pi^2+x^2)}{(1+q^x)^2 (-a^2\pi^2+x^2)^2} dx = \frac{\log(q)\psi^{(2)}\left(\frac{1}{2} + \frac{1}{2}ia \log(q)\right)}{2\pi^2}$$

EXAMPLE 5.164.

$$(5.164) \quad \int_0^\infty \frac{(4\pi^2-x^2) \tanh^2(mx)}{(4\pi^2+x^2)^2} dx = -\frac{m\psi^{(2)}\left(\frac{1}{2}-2m\right)}{\pi^2}$$

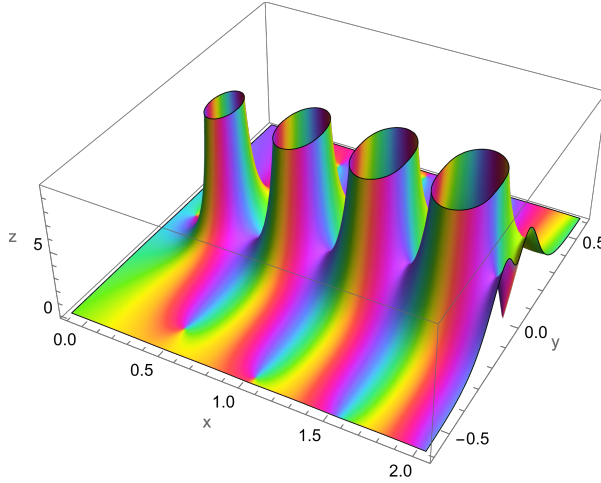
FIGURE 3. Plot of  $f(m) = \frac{m\psi^{(2)}\left(\frac{1}{2}-2m\right)}{\pi^2}$ ,  $m \in \mathbb{C}$ .

EXAMPLE 5.165.

$$(5.165) \quad \int_0^\infty \frac{(a^2\pi^2+x^2) \operatorname{sech}(2mx) \sinh(mx) \tanh(2mx)}{(-a^2\pi^2+x^2)^2} dx$$

$$= \frac{\sqrt[4]{-1}m}{2\pi^2} \left( \pi\Phi\left(-i, 2, \frac{1}{2} + 2iam\right) + 4i\Phi\left(-i, 3, \frac{1}{2} + 2iam\right) - i\pi\Phi\left(i, 2, \frac{1}{2} + 2iam\right) - 4\Phi\left(i, 3, \frac{1}{2} + 2iam\right) \right)$$

EXAMPLE 5.166.

$$(5.166) \quad \int_0^\infty \frac{(-\pi^2+x^2) \operatorname{sech}(2mx) \sinh(mx) \tanh(2mx)}{(\pi^2+x^2)^2} dx$$

$$= \frac{\sqrt[4]{-1}m}{2\pi^2} \left( \pi\Phi\left(-i, 2, \frac{1}{2} - 2m\right) + 4i\Phi\left(-i, 3, \frac{1}{2} - 2m\right) - i\pi\Phi\left(i, 2, \frac{1}{2} - 2m\right) - 4\Phi\left(i, 3, \frac{1}{2} - 2m\right) \right)$$

EXAMPLE 5.167.

$$(5.167) \quad \int_0^\infty \frac{(-\pi^2 + x^2) \operatorname{sech}\left(\frac{x}{2}\right) \sinh\left(\frac{x}{4}\right) \tanh\left(\frac{x}{2}\right)}{(\pi^2 + x^2)^2} dx = \frac{-48C\pi + 5\pi^3 - 18\zeta(3)}{192\sqrt{2}\pi^2}$$

EXAMPLE 5.168.

$$(5.168) \quad \int_0^\pi \cot(x) \log\left(\frac{\sinh(m-ix) \sinh(r+ix)}{\sinh(r-ix) \sinh(m+ix)}\right) dx = 2\pi i \log\left(\frac{e^{r-m} \sinh(m)}{\sinh(r)}\right)$$

EXAMPLE 5.169.

$$(5.169) \quad \frac{i}{2\pi} \int_0^\pi \frac{\cot(x)}{e^{2ix}} (\Phi'(-e^{-2ix}, 0, a) - e^{4ix} \Phi'(-e^{2ix}, 0, a)) dx = \log\left(\frac{\Gamma\left(\frac{a}{2}\right)}{\sqrt{2}\Gamma\left(\frac{1+a}{2}\right)}\right)$$

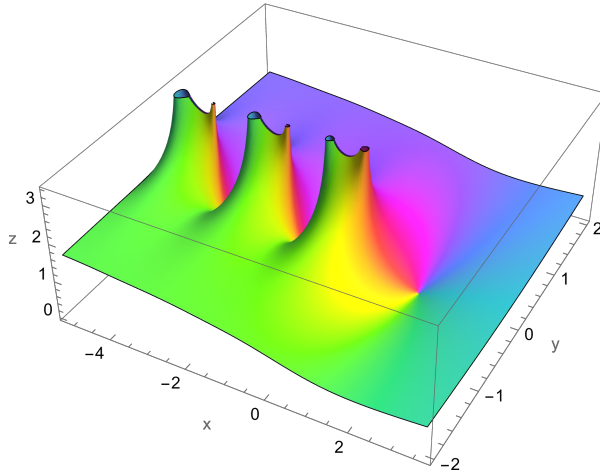
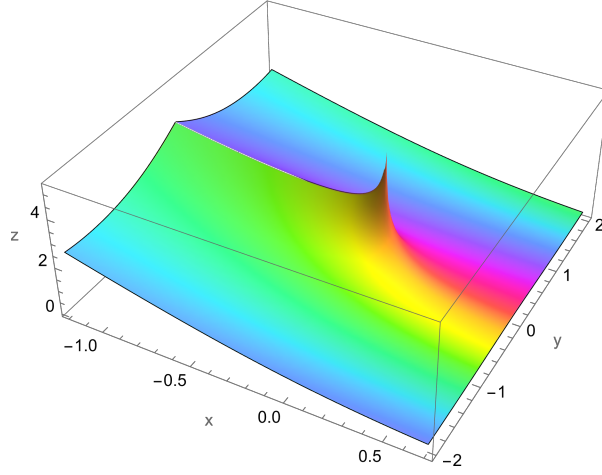

FIGURE 4. Plot of  $f(a) = \log\left(\frac{\Gamma\left(\frac{a}{2}\right)}{\sqrt{2}\Gamma\left(\frac{a+1}{2}\right)}\right)$ ,  $a \in \mathbb{C}$ .

EXAMPLE 5.170.

$$(5.170) \quad \int_0^\pi \log\left(\frac{\left(\frac{\sinh(m-ix)}{\sinh(m+ix)}\right)^{\frac{i \cot(x)}{2\pi}}}{\cosh\left(\frac{x \cot(x)}{\pi}\right) + \sinh\left(\frac{x \cot(x)}{\pi}\right)}\right) dx = \log\left(\frac{1}{2}(1 + \coth(m))\right)$$

FIGURE 5. Plot of  $f(m) = \log\left(\frac{1}{2}(\coth(m) + 1)\right)$ ,  $m \in \mathbb{C}$ .

EXAMPLE 5.171.

(5.171)

$$\int_0^\pi \log \left( \frac{\left( \frac{(-1+e^{2ix}z)(e^{2ix}-z^2)}{(e^{2ix}-z)(-1+e^{2ix}z^2)} \right)^{\frac{ie^{-2ix}\cot(x)}{4\pi}} \left( \frac{(e^{2ix}-z)(-1+e^{2ix}z)}{z^2+e^{4ix}z^2-e^{2ix}(1+z^4)} \right)^{\frac{1}{2\pi}}}{\left( \frac{(e^{2ix}-z)(-1+e^{2ix}z^2)}{(-1+e^{2ix}z)(e^{2ix}-z^2)} \right)^{\frac{ie^{2ix}\cot(x)}{4\pi}} \left( \frac{1+z^4-2z^2\cos(2x)}{1+z^2-2z\cos(2x)} \right)^{\frac{\cos(2x)}{2\pi}}} \right) dx = \log\left(\frac{1}{1+z}\right)$$

EXAMPLE 5.172.

$$(5.172) \quad \frac{i}{8\pi} \int_0^\pi \frac{\cot(x)}{e^{2ix}} \left( \Phi\left(-e^{-2ix}, 2, \frac{1}{2}\right) - e^{4ix} \Phi\left(-e^{2ix}, 2, \frac{1}{2}\right) \right) dx = C$$

EXAMPLE 5.173.

(5.173)

$$\int_0^\pi \frac{\cot(x)}{e^{2ix}} \left( e^{4ix} \Phi'\left(-e^{2ix}, 1, \frac{1}{2}\right) - \Phi'\left(-e^{-2ix}, 1, \frac{1}{2}\right) \right) dx = i\pi^2 \left( \gamma + \log\left(\frac{8\pi^3}{\Gamma\left(\frac{1}{4}\right)^4}\right) \right)$$

EXAMPLE 5.174.

(5.174)

$$\int_0^\pi e^{-2ix} \cot(x) \left( -\Phi'\left(-e^{-2ix}, 1, a\right) + e^{4ix} \Phi'\left(-e^{2ix}, 1, a\right) \right) dx = 2i\pi \log\left(\frac{\Gamma\left(\frac{a}{2}\right)}{\sqrt{2}\Gamma\left(\frac{1+a}{2}\right)}\right)$$

EXAMPLE 5.175.

$$(5.175) \quad \int_0^\pi \cot(x) \left( \text{Li}_{-k}\left(\frac{e^{-2ix}}{q}\right) - \text{Li}_{-k}\left(\frac{e^{2ix}}{q}\right) \right) dx = -2i\pi \text{Li}_{-k}\left(\frac{1}{q}\right)$$

EXAMPLE 5.176.

$$(5.176) \quad \int_0^\pi \cot(x) \left( -\zeta \left( 1+k, \frac{2x-i\log(q)}{2\pi} \right) + \zeta \left( 1+k, -\frac{2x+i\log(q)}{2\pi} \right) \right. \\ \left. + i^{2k} \left( \zeta \left( 1+k, \frac{2\pi-2x+i\log(q)}{2\pi} \right) - \zeta \left( 1+k, \frac{2(\pi+x)+i\log(q)}{2\pi} \right) \right) \right) dx \\ = 2i\pi \left( \zeta \left( 1+k, -\frac{i\log(q)}{2\pi} \right) - i^{2k} \zeta \left( 1+k, 1+\frac{i\log(q)}{2\pi} \right) \right)$$

EXAMPLE 5.177.

$$(5.177) \quad \frac{1}{2i\pi} \int_0^\pi \cot(x) \log \left( \frac{e^{-2ix}-q}{e^{2ix}-q} \right) dx = \log \left( \frac{q}{q-1} \right)$$

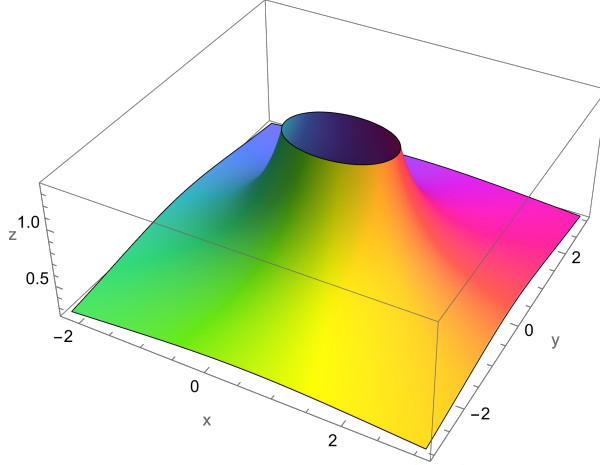

FIGURE 6. Plot of  $f(q) = \log \left( \frac{q}{q-1} \right)$ ,  $q \in \mathbb{C}$ .

EXAMPLE 5.178. A Mellin transform.

$$(5.178) \quad \int_0^\infty x^{-1+k} \log \left( \frac{1+\cosh(cx)}{\cos(b)+\cosh(cx)} \right) (-k \cos(mx) + mx \sin(mx)) dx \\ = \frac{1}{2} c^{-k} e^{-\frac{m(b+\pi)}{c}} \pi \csc \left( \frac{k\pi}{2} \right) \left( -2^{1+k} e^{\frac{bm}{c}} \pi^k \left( \Phi \left( e^{-\frac{2m\pi}{c}}, -k, \frac{1}{2} \right) + e^{\frac{2m\pi}{c}} \Phi \left( e^{\frac{2m\pi}{c}}, -k, \frac{1}{2} \right) \right) \right. \\ \left. + (2\pi)^k \left( e^{\frac{2bm}{c}} \Phi \left( e^{-\frac{2m\pi}{c}}, -k, \frac{-b+\pi}{2\pi} \right) + \Phi \left( e^{-\frac{2m\pi}{c}}, -k, \frac{b+\pi}{2\pi} \right) \right. \right. \\ \left. \left. + e^{\frac{2m\pi}{c}} \left( \Phi \left( e^{\frac{2m\pi}{c}}, -k, \frac{-b+\pi}{2\pi} \right) + e^{\frac{2bm}{c}} \Phi \left( e^{\frac{2m\pi}{c}}, -k, \frac{b+\pi}{2\pi} \right) \right) \right) \right)$$

EXAMPLE 5.179.

$$(5.179) \quad \int_0^\infty x^{-1+s} \log \left( \frac{1+\cosh(cx)}{\cos(2b\pi)+\cosh(cx)} \right) dx \\ = \frac{c^{-s} \pi^{1+s} \csc \left( \frac{\pi s}{2} \right) \left( -2\zeta(-s) + 2^s \left( \zeta \left( -s, \frac{1}{2} - b \right) + \zeta \left( -s, \frac{1}{2} + b \right) + 2\zeta(-s) \right) \right)}{s}$$

EXAMPLE 5.180.

$$\begin{aligned}
 (5.180) \quad & \int_0^\infty x^{-1+k} \log \left( \frac{1 + \cosh(2mx)}{\cos(b) + \cosh(2mx)} \right) (-k \cosh(mx) - mx \sinh(mx)) dx \\
 &= \frac{1}{2} e^{-\frac{1}{2}i(b+\pi)} m^{-k} \pi^{1+k} \csc \left( \frac{k\pi}{2} \right) \left( -2^k \zeta \left( -k, \frac{-b+\pi}{4\pi} \right) + 2^k \zeta \left( -k, \frac{b+\pi}{4\pi} \right) \right. \\
 &+ 2^k \zeta \left( -k, \frac{1}{2} \left( 1 + \frac{-b+\pi}{2\pi} \right) \right) + e^{ib} \left( 2^k \zeta \left( -k, \frac{-b+\pi}{4\pi} \right) - 2^k \zeta \left( -k, \frac{1}{2} \left( 1 + \frac{-b+\pi}{2\pi} \right) \right) \right) \\
 &\left. - 2^k \zeta \left( -k, \frac{1}{2} \left( 1 + \frac{b+\pi}{2\pi} \right) \right) - e^{ib} \left( 2^k \zeta \left( -k, \frac{b+\pi}{4\pi} \right) - 2^k \zeta \left( -k, \frac{1}{2} \left( 1 + \frac{b+\pi}{2\pi} \right) \right) \right) \right)
 \end{aligned}$$

EXAMPLE 5.181. Frullani integral see (3.434) in [4].

$$(5.181) \quad \int_0^\infty \frac{\log \left( \frac{(\cosh(2b\pi) + \cosh(cx))(1 + \cosh(dx))}{(1 + \cosh(cx))(\cosh(2b\pi) + \cosh(dx))} \right)}{x} dx = 2 \log \left( \frac{c}{d} \right) \log(\operatorname{sech}(b\pi))$$

EXAMPLE 5.182.

$$\begin{aligned}
 (5.182) \quad & \int_0^\infty \log \left( \frac{(b^2 + 2^x b^x) (1 + 2^x b^{2+x}) (1 + (1 + b^2)^x)^2}{(1 + 2^x b^x)^2 (b^2 + (1 + b^2)^x) (1 + b^2 (1 + b^2)^x)} \right) \frac{dx}{2x} \\
 &= \log \left( \frac{2b}{1 + b^2} \right) \log \left( \frac{\log(2b)}{\log(1 + b^2)} \right)
 \end{aligned}$$

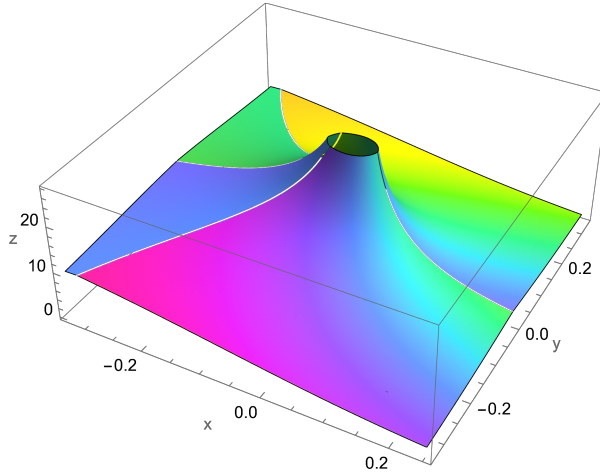

FIGURE 7. Plot of  $f(b) = \log \left( \frac{2b}{b^2+1} \right) \log \left( \frac{\log(2b)}{\log(b^2+1)} \right)$ ,  $b \in \mathbb{C}$ .

EXAMPLE 5.183.

$$(5.183) \quad \int_0^\infty \log \left( \frac{1 + \cosh(x)}{\frac{1}{\sqrt{2}} + \cosh(x)} \right) \frac{((\pi^2 + x^2) \cosh \left( \frac{x}{2} \right) \log(\pi^2 + x^2) + 4x \sinh \left( \frac{x}{2} \right))}{\pi^2 + x^2} dx$$

$$= \pi \left( \log(256) + 2\sqrt{2 + \sqrt{2}} \log \left( \frac{4 \tan \left( \frac{\pi}{16} \right)}{\pi} \right) \right)$$

EXAMPLE 5.184.

$$(5.184) \quad \int_0^\infty \frac{\log \left( \frac{1 + \cosh(x)}{\frac{1}{\sqrt{2}} + \cosh(x)} \right) \left( (\pi^2 + x^2) \cosh \left( \frac{x}{2} \right) - 4x \sinh \left( \frac{x}{2} \right) \right)}{(\pi^2 + x^2)^2} dx$$

$$= \frac{\log(256) + \sqrt{2 + \sqrt{2}} \left( -16 - \psi^{(0)} \left( \frac{1}{16} \right) + \psi^{(0)} \left( \frac{7}{16} \right) + \psi^{(0)} \left( \frac{9}{16} \right) - \psi^{(0)} \left( \frac{15}{16} \right) \right)}{4\pi}$$

EXAMPLE 5.185.

$$(5.185) \quad \int_0^\infty \frac{\log(1 + \operatorname{sech}(x)) \left( (\pi^2 + x^2) \cosh \left( \frac{x}{2} \right) - 4x \sinh \left( \frac{x}{2} \right) \right)}{(\pi^2 + x^2)^2} dx = \frac{-2\sqrt{2} + \log(12 + 8\sqrt{2})}{\pi}$$

EXAMPLE 5.186.

$$(5.186) \quad \int_0^\infty \frac{\log \left( \frac{2(1 + \cosh(x))}{\sqrt{2} + 2 \cosh(x)} \right) \left( (\pi^2 + x^2) \cosh \left( \frac{x}{2} \right) \log(\pi^2 + x^2) + 4x \sinh \left( \frac{x}{2} \right) \right)}{\pi^2 + x^2} dx$$

$$= 2\pi \left( \log(16) + \sqrt{2 + \sqrt{2}} \log \left( \frac{4 \tan \left( \frac{\pi}{16} \right)}{\pi} \right) \right)$$

EXAMPLE 5.187.

$$(5.187) \quad \int_0^\infty \frac{\log \left( 1 + \frac{1}{1 + 2 \cosh(x)} \right) \left( (4\pi^2 + x^2) \cosh \left( \frac{x}{2} \right) - 4x \sinh \left( \frac{x}{2} \right) \right)}{(4\pi^2 + x^2)^2} dx = \frac{16 - 9\sqrt{3}}{8\pi}$$

EXAMPLE 5.188.

$$(5.188) \quad \int_0^\infty \frac{\log \left( \frac{1 + 2 \cosh(x)}{2 + 2 \cosh(x)} \right) \left( (4\pi^2 + x^2) \cosh \left( \frac{x}{2} \right) \log(4\pi^2 + x^2) + 4x \sinh \left( \frac{x}{2} \right) \right)}{4\pi^2 + x^2} dx$$

$$= \log \left( 3^{-4(2 + \sqrt{3})\pi} 4^{2(2 + \sqrt{3})\pi} \pi^{-2(-2 + \sqrt{3})\pi} \left( \frac{\Gamma \left( -\frac{1}{4} \right)}{\Gamma \left( -\frac{3}{4} \right)} \right)^{8\pi} \left( \frac{5\Gamma \left( -\frac{5}{6} \right) \Gamma \left( -\frac{2}{3} \right)}{\Gamma \left( -\frac{1}{3} \right) \Gamma \left( -\frac{1}{6} \right)} \right)^{2\sqrt{3}\pi} \right)$$

EXAMPLE 5.189.

$$(5.189) \quad \int_0^\infty \frac{\log \left( \frac{1 + \cosh(x)}{\cos(2b\pi) + \cosh(x)} \right)}{a^2\pi^2 + x^2} \left( (a\pi + ix)^k (ia\pi + x) \left( (a\pi + ix) \cosh \left( \frac{x}{2} \right) + 2ik \sinh \left( \frac{x}{2} \right) \right) \right.$$

$$\left. + (a\pi - ix)^k (a\pi + ix) \left( (ia\pi + x) \cosh \left( \frac{x}{2} \right) + 2k \sinh \left( \frac{x}{2} \right) \right) \right) dx$$

$$\begin{aligned}
&= -i(4\pi)^{1+k} \left( -2\zeta \left( -k, \frac{1+a}{4} \right) + 2\zeta \left( -k, \frac{3+a}{4} \right) \right. \\
&+ \cos(b\pi) \left( \zeta \left( -k, \frac{1}{4}(1+a-2b) \right) - \zeta \left( -k, \frac{1}{4}(3+a-2b) \right) \right. \\
&\quad \left. \left. + \zeta \left( -k, \frac{1}{4}(1+a+2b) \right) - \zeta \left( -k, \frac{1}{4}(3+a+2b) \right) \right) \right)
\end{aligned}$$

EXAMPLE 5.190.

$$\begin{aligned}
(5.190) \quad &\int_0^\infty \frac{\log \left( \frac{1+\cosh(x)}{\cos(2b\pi)+\cosh(x)} \right) \left( (a^2\pi^2 + x^2) \cosh \left( \frac{x}{2} \right) - 4x \sinh \left( \frac{x}{2} \right) \right)}{(a^2\pi^2 + x^2)^2} dx \\
&= \frac{1}{2a\pi} \left( -2\psi^{(0)} \left( \frac{1+a}{4} \right) + 2\psi^{(0)} \left( \frac{3+a}{4} \right) + \cos(b\pi) \left( \psi^{(0)} \left( \frac{1}{4}(1+a-2b) \right) \right. \right. \\
&\quad \left. \left. - \psi^{(0)} \left( \frac{1}{4}(3+a-2b) \right) + \psi^{(0)} \left( \frac{1}{4}(1+a+2b) \right) - \psi^{(0)} \left( \frac{1}{4}(3+a+2b) \right) \right) \right)
\end{aligned}$$

EXAMPLE 5.191.

$$\begin{aligned}
(5.191) \quad &\int_0^\infty \frac{\log \left( \frac{1+\cosh(x)}{\cos(2b\pi)+\cosh(x)} \right) \left( (a^2\pi^2 + x^2) \cosh \left( \frac{x}{2} \right) \log(a^2\pi^2 + x^2) + 4x \sinh \left( \frac{x}{2} \right) \right)}{a^2\pi^2 + x^2} dx \\
&= 8\pi \log \left( \frac{2\sqrt{\pi}\Gamma \left( \frac{3+a}{4} \right)}{\Gamma \left( \frac{1+a}{4} \right)} \right) + 4\pi \cos(b\pi) \log \left( \frac{\Gamma \left( \frac{1}{4}(1+a-2b) \right) \Gamma \left( \frac{1}{4}(1+a+2b) \right)}{4\pi\Gamma \left( \frac{1}{4}(3+a-2b) \right) \Gamma \left( \frac{1}{4}(3+a+2b) \right)} \right)
\end{aligned}$$

5.1.1. *Examples derived from Eq.s (4.38) and (4.38).*

EXAMPLE 5.192.

$$\begin{aligned}
(5.192) \quad &\int_0^\infty e^{-imx} \tanh^{-1}(\alpha^2 \operatorname{sech}^2(x)) \left( (-ix + \log(a))^{-1+k} + e^{2imx} (ix + \log(a))^{-1+k} \right. \\
&\quad \left. + \frac{m \left( (-ix + \log(a))^k + e^{2imx} (ix + \log(a))^k \right)}{k} \right) dx \\
&= -\frac{\pi^{1+k}}{k} \left( e^{m(\cos^{-1}(\alpha)+2\sin^{-1}(\alpha))} \Phi \left( e^{m\pi}, -k, \frac{\pi - \cos^{-1}(\alpha) + \log(a)}{\pi} \right) \right. \\
&\quad \left. + e^{m\cos^{-1}(\alpha)} \Phi \left( e^{m\pi}, -k, \frac{\cos^{-1}(\alpha) + \log(a)}{\pi} \right) \right) \\
&- e^{\frac{m\pi}{2}} \left( \alpha + \sqrt{1+\alpha^2} \right)^{-im} \left( \Phi \left( e^{m\pi}, -k, \frac{\pi - 2i \sinh^{-1}(\alpha) + 2\log(a)}{2\pi} \right) \right. \\
&\quad \left. + \left( \alpha + \sqrt{1+\alpha^2} \right)^{2im} \Phi \left( e^{m\pi}, -k, \frac{\pi + 2i \sinh^{-1}(\alpha) + 2\log(a)}{2\pi} \right) \right)
\end{aligned}$$

EXAMPLE 5.193.

$$(5.193) \quad \int_0^\infty e^{-imx} \left( (-ix + \log(a))^{-1+k} + e^{2imx} (ix + \log(a))^{-1+k} \right)$$

$$\begin{aligned}
& + \frac{m \left( (-ix + \log(a))^k + e^{2imx} (ix + \log(a))^k \right)}{k} \log(1 - \alpha^4 \operatorname{sech}^4(x)) \, dx \\
& = \frac{2e^{\frac{m\pi}{2}} \pi^{1+k}}{k} \left( e^{m \sin^{-1}(\alpha)} \Phi \left( e^{m\pi}, -k, \frac{\pi - \cos^{-1}(\alpha) + \log(a)}{\pi} \right) \right. \\
& \quad \left. + e^{-m \sin^{-1}(\alpha)} \Phi \left( e^{m\pi}, -k, \frac{\cos^{-1}(\alpha) + \log(a)}{\pi} \right) \right) \\
& + \left( \alpha + \sqrt{1 + \alpha^2} \right)^{-im} \Phi \left( e^{m\pi}, -k, \frac{\pi - 2i \sinh^{-1}(\alpha) + 2 \log(a)}{2\pi} \right) \\
& + \left( \alpha + \sqrt{1 + \alpha^2} \right)^{im} \Phi \left( e^{m\pi}, -k, \frac{\pi + 2i \sinh^{-1}(\alpha) + 2 \log(a)}{2\pi} \right) \\
& \quad - 4\Phi \left( e^{m\pi}, -k, \frac{1}{2} + \frac{\log(a)}{\pi} \right)
\end{aligned}$$

EXAMPLE 5.194.

$$\begin{aligned}
(5.194) \quad & \int_0^\infty x^{k-1} \tanh^{-1}(\alpha^2 \operatorname{sech}^2(x)) \, dx \\
& = -\frac{\pi^{1+k} \csc\left(\frac{k\pi}{2}\right)}{2k} \left( \zeta \left( -k, \frac{\cos^{-1}(\alpha)}{\pi} \right) + \zeta \left( -k, 1 - \frac{\cos^{-1}(\alpha)}{\pi} \right) \right. \\
& \quad \left. - \zeta \left( -k, \frac{1}{2} - \frac{i \sinh^{-1}(\alpha)}{\pi} \right) - \zeta \left( -k, \frac{1}{2} + \frac{i \sinh^{-1}(\alpha)}{\pi} \right) \right)
\end{aligned}$$

EXAMPLE 5.195.

$$\begin{aligned}
(5.195) \quad & \int_0^\infty x^{k-1} \log(1 - \alpha^4 \operatorname{sech}^4(x)) \, dx \\
& = \frac{\pi^{1+k} \csc\left(\frac{k\pi}{2}\right)}{k} \left( \zeta \left( -k, \frac{\cos^{-1}(\alpha)}{\pi} \right) + \zeta \left( -k, 1 - \frac{\cos^{-1}(\alpha)}{\pi} \right) \right. \\
& \quad \left. + \zeta \left( -k, \frac{1}{2} - \frac{i \sinh^{-1}(\alpha)}{\pi} \right) + \zeta \left( -k, \frac{1}{2} + \frac{i \sinh^{-1}(\alpha)}{\pi} \right) - 4(-1 + 2^{-k}) \zeta(-k) \right)
\end{aligned}$$

EXAMPLE 5.196.

$$\begin{aligned}
(5.196) \quad & \int_0^\infty e^{-x} x^{-1+k} (-k + x + (-1)^{-k} e^{2x} (k + x)) \tanh^{-1}(\alpha^2 \operatorname{sech}^2(x)) \, dx \\
& = i^{1-k} 2^k \pi^{1+k} \left( e^{i \cos^{-1}(\alpha)} \left( \zeta \left( -k, \frac{\cos^{-1}(\alpha)}{2\pi} \right) - \zeta \left( -k, \frac{\pi + \cos^{-1}(\alpha)}{2\pi} \right) \right) \right. \\
& \quad \left. + e^{-i \cos^{-1}(\alpha)} \left( \zeta \left( -k, 1 - \frac{\cos^{-1}(\alpha)}{2\pi} \right) - \zeta \left( -k, \frac{\pi + 2 \sin^{-1}(\alpha)}{4\pi} \right) \right) \right) \\
& - i \left( \alpha + \sqrt{1 + \alpha^2} \right) \left( \zeta \left( -k, \frac{\pi - 2i \sinh^{-1}(\alpha)}{4\pi} \right) - \zeta \left( -k, \frac{3}{4} - \frac{i \sinh^{-1}(\alpha)}{2\pi} \right) \right. \\
& \quad \left. + \frac{\zeta \left( -k, \frac{\pi + 2i \sinh^{-1}(\alpha)}{4\pi} \right) - \zeta \left( -k, \frac{3}{4} + \frac{i \sinh^{-1}(\alpha)}{2\pi} \right)}{(\alpha + \sqrt{1 + \alpha^2})^2} \right)
\end{aligned}$$



## 5.1.2. Examples derived from (4.40).

EXAMPLE 5.197.

$$\begin{aligned}
(5.197) \quad & \int_0^\infty x^{-1+k} \cot^{-1}(\sinh(bx)) \left( -k \cos\left(\frac{k\pi}{2} + mx\right) + k \cos\left(\frac{k\pi}{2} + px\right) \right. \\
& \quad \left. + mx \sin\left(\frac{k\pi}{2} + mx\right) - px \sin\left(\frac{k\pi}{2} + px\right) \right) dx \\
& = -\left(\frac{1}{b}\right)^k \pi^{1+k} \left( e^{\frac{m\pi}{2b}} \Phi\left(-e^{\frac{m\pi}{b}}, -k, \frac{1}{2}\right) - e^{\frac{p\pi}{2b}} \Phi\left(-e^{\frac{p\pi}{b}}, -k, \frac{1}{2}\right) \right)
\end{aligned}$$

EXAMPLE 5.198.

$$\begin{aligned}
(5.198) \quad & \int_0^\infty \frac{(\cot^{-1}(\sinh(bx)) - \cot^{-1}(\sinh(cx))) (mx \cos(mx) - px \cos(px) - \sin(mx) + \sin(px))}{x^2} dx \\
& = 2 \left( b \tan^{-1}\left(e^{\frac{m\pi}{2b}}\right) - c \tan^{-1}\left(e^{\frac{m\pi}{2c}}\right) - b \tan^{-1}\left(e^{\frac{p\pi}{2b}}\right) + c \tan^{-1}\left(e^{\frac{p\pi}{2c}}\right) \right)
\end{aligned}$$

EXAMPLE 5.199.

$$(5.199) \quad \int_0^\infty x^{-1+k} \cot^{-1}(\sinh(bx)) dx = \frac{\pi}{k} \left(\frac{2\pi}{b}\right)^k \left( \zeta\left(-k, \frac{1}{4}\right) - \zeta\left(-k, \frac{3}{4}\right) \right) \sec\left(\frac{k\pi}{2}\right)$$

EXAMPLE 5.200.

$$(5.200) \quad \int_0^\infty \frac{-\cot^{-1}(\sinh(bx)) + \cot^{-1}(\sinh(cx))}{x} dx = \frac{1}{2} \pi \log\left(\frac{b}{c}\right)$$

EXAMPLE 5.201.

$$\begin{aligned}
(5.201) \quad & \int_0^\infty \cot^{-1}(\sinh(bx)) \left( \frac{\log(a\pi - ix)}{a\pi - ix} - \frac{\log(a\pi + ix)}{a\pi + ix} \right) dx \\
& = \frac{1}{8} i\pi \left( (2 - 4ab) \log^2\left(\frac{1}{b}\right) + 4(1 - 2ab) \log\left(\frac{1}{b}\right) \log(2\pi) - 4 \log^2(a\pi) \right. \\
& \quad \left. + (2 + 4ab) \log^2\left(\frac{2\pi}{b}\right) + \log(4\pi^2) (\log(2\pi) - ab \log(4\pi^2)) \right) \\
& \quad + 16 \log\left(\frac{2\pi}{b}\right) \log\left(\frac{\Gamma\left(\frac{3}{4} + \frac{ab}{2}\right)}{\Gamma\left(\frac{1}{4} + \frac{ab}{2}\right)}\right) + 8\zeta''\left(0, \frac{1}{4} + \frac{ab}{2}\right) - 8\zeta''\left(0, \frac{3}{4} + \frac{ab}{2}\right)
\end{aligned}$$

EXAMPLE 5.202.

$$\begin{aligned}
(5.202) \quad & \int_0^\infty e^{\frac{bx}{2}} \cot^{-1}(\sinh(bx)) \left( \frac{1}{-ix + \log(a)} - \frac{e^{-bx}}{ix + \log(a)} \right. \\
& \quad \left. + \frac{1}{2} ib (\log(-ix + \log(a)) - e^{-bx} \log(ix + \log(a))) \right) dx \\
& = i\pi \left( \sqrt{2} \log\left(\frac{\pi}{b}\right) - 2\sqrt[4]{-1} \log\left(\frac{\Gamma\left(\frac{\pi+2b\log(a)}{8\pi}\right)}{2\Gamma\left(\frac{5}{8} + \frac{b\log(a)}{4\pi}\right)}\right) \right)
\end{aligned}$$

$$+2(-1)^{3/4} \log \left( \frac{\Gamma \left( \frac{3}{8} + \frac{b \log(a)}{4\pi} \right)}{2\Gamma \left( \frac{7}{8} + \frac{b \log(a)}{4\pi} \right)} - \log(\log(a)) \right)$$

EXAMPLE 5.203.

$$(5.203) \quad \int_0^\infty e^{-imx} \left( k \left( \left( \frac{\pi}{2b} - ix \right)^{-1+k} - e^{2imx} \left( \frac{\pi}{2b} + ix \right)^{-1+k} \right) \right. \\ \left. + m \left( \left( \frac{\pi}{2b} - ix \right)^k - e^{2imx} \left( \frac{\pi}{2b} + ix \right)^k \right) \cot^{-1}(\sinh(bx)) \right) dx \\ = -i \left( \frac{1}{b} \right)^k \pi \left( \left( \frac{\pi}{2} \right)^k + \frac{2^{-k} e^{-\frac{m\pi}{2b}} \Gamma(1+k) \left( i^{1+k} \zeta \left( 1+k, \frac{b-im}{2b} \right) + i^{-1-k} \zeta \left( 1+k, \frac{b+im}{2b} \right) \right)}{\pi} \right)$$

EXAMPLE 5.204.

$$(5.204) \quad \int_0^\infty e^{-imx} \left( \frac{e^{2imx}(b - m\pi - ibmx)}{(\pi + ibx)^2} + \frac{m\pi + b(-1 - imx)}{(\pi - ibx)^2} \right) \cot^{-1} \left( \sinh \left( \frac{bx}{2} \right) \right) dx \\ = -i + \frac{ie^{-\frac{m\pi}{b}} (m\pi + b \log(2 \cosh(\frac{m\pi}{b})))}{b}$$

EXAMPLE 5.205.

$$(5.205) \quad \int_0^\infty \cot^{-1}(\sinh(bx)) \log \left( \frac{\pi - 2ibx}{\pi + 2ibx} \right) dx = \frac{i\pi^2}{2b} \log \left( \frac{4\sqrt[3]{2}e}{A^{12}} \right)$$

EXAMPLE 5.206.

$$(5.206) \quad \int_0^\infty \tan^{-1} \left( \frac{2q^x}{-1 + q^{2x}} \right) \log \left( \frac{\pi - 2ix \log(q)}{\pi + 2ix \log(q)} \right) dx = \frac{(i\pi^2) \log \left( \frac{4\sqrt[3]{2}e}{A^{12}} \right)}{2 \log(q)}$$

EXAMPLE 5.207.

$$(5.207) \quad \int_0^\infty \cot^{-1}(\sinh(bx)) \left( -2ibx + (\pi - 2ibx) \log \left( \frac{\pi}{2b} - ix \right) - (\pi + 2ibx) \log \left( \frac{\pi}{2b} + ix \right) \right) dx \\ = -\frac{i\pi \left( \pi^2 \log \left( \frac{\pi}{2b} \right) + 14\zeta(3) \right)}{4b}$$

EXAMPLE 5.208.

$$(5.208) \quad \int_0^\infty \cot^{-1}(\sinh(bx)) dx = \frac{2C}{b}$$

EXAMPLE 5.209.

$$(5.209) \quad \frac{\log(q)}{2} \int_0^\infty \tan^{-1} \left( \frac{2q^x}{q^{2x} - 1} \right) dx = C$$

5.1.3. Example derived using equation (4.41).

EXAMPLE 5.210.

$$\begin{aligned}
 (5.210) \quad & \int_0^\infty x \cot^{-1}(e^{2x}) \sinh(x) dx \\
 &= \frac{1}{\sqrt{2}} \left( \log\left(\frac{15}{7}\right) - \log\Gamma\left(-\frac{7}{8}\right) + \log\Gamma\left(-\frac{5}{8}\right) + \log\Gamma\left(-\frac{3}{8}\right) - \log\Gamma\left(-\frac{1}{8}\right) \right. \\
 &\quad \left. + 2\pi \left( \zeta'\left(-1, \frac{1}{8}\right) + \zeta'\left(-1, \frac{3}{8}\right) - \zeta'\left(-1, \frac{5}{8}\right) - \zeta'\left(-1, \frac{7}{8}\right) \right) \right)
 \end{aligned}$$

EXAMPLE 5.211.

$$(5.211) \quad \int_0^\infty \cot^{-1}(e^{2x}) \sinh(x) dx = \frac{1}{4} (-\pi + \sqrt{2}\pi)$$

EXAMPLE 5.212.

$$\begin{aligned}
 (5.212) \quad & \int_0^\infty \frac{(\pi^6 - x^4(-6 + x^2) + \pi^4(6 + x^2) - \pi^2 x^2(36 + x^2)) \cot^{-1}(e^{2x}) \sinh(x)}{(\pi^2 + x^2)^4} dx \\
 &= \frac{13312 + 648\pi^3 - 6\pi(-320 + 9\sqrt{2} + 9\psi^{(1)}(\frac{1}{8}) + 9\psi^{(1)}(\frac{3}{8})) + 27\psi^{(2)}(\frac{1}{8}) - 27\psi^{(2)}(\frac{3}{8})}{216\sqrt{2}\pi^2}
 \end{aligned}$$

EXAMPLE 5.213.

$$\begin{aligned}
 (5.213) \quad & \int_0^\infty 15 \left( \frac{1}{(\pi - ix)^6} + \frac{1}{(\pi + ix)^6} + \frac{\pi^4 - 6\pi^2 x^2 + x^4}{10(\pi^2 + x^2)^4} \right) \cot^{-1}(e^{2x}) \sinh(x) \frac{dx}{2\pi} \\
 &= \frac{1}{20736\sqrt{2}\pi^5} \left( 31719424 + 124416\pi^5 - 6\pi(-335872 + 648\sqrt{2} \right. \\
 &\quad \left. + 27\psi^{(3)}(\frac{1}{8}) + 27\psi^{(3)}(\frac{3}{8}) \right) + 81\psi^{(4)}(\frac{1}{8}) - 81\psi^{(4)}(\frac{3}{8})
 \end{aligned}$$

EXAMPLE 5.214.

$$\begin{aligned}
 (5.214) \quad & \int_0^\infty \cot^{-1}(e^{2x}) \left( -2 + \frac{2(\pi^2 - x^2)}{(\pi^2 + x^2)^2} - \log(\pi^2 + x^2) \right) \sinh(x) dx \\
 &= \frac{4\sqrt{2}}{3} + \frac{\pi}{2} + \log \left( \pi^{\pi/2} \tan^2\left(\frac{\pi}{8}\right) \left( \frac{99\Gamma(-\frac{11}{8})\Gamma(-\frac{9}{8})}{70e\pi\Gamma(-\frac{7}{8})\Gamma(-\frac{5}{8})} \right)^{\frac{\pi}{\sqrt{2}}} \right)
 \end{aligned}$$

EXAMPLE 5.215.

$$\begin{aligned}
 (5.215) \quad & \int_0^\infty \frac{(\pi^4 + 256x^2(-6 + x^2) + 32\pi^2(1 + x^2)) \cot^{-1}(e^{2x}) \sinh(x)}{(\pi^2 + 16x^2)^3} dx \\
 &= \frac{48C + \pi(5\pi + 6(-4\sqrt{2} + \log(4)))}{96\sqrt{2}\pi^2}
 \end{aligned}$$

EXAMPLE 5.216.

$$\begin{aligned}
(5.216) \quad & \int_0^\infty \cot^{-1} \left( e^{2x} \left( \frac{32\pi}{\pi^2 + 16x^2} + 4ix \log \left( \frac{\pi + 4ix}{\pi - 4ix} \right) + \pi \left( -2 + \log \left( \frac{\pi^2}{16} + x^2 \right) \right) \right) \right) \sinh(x) dx \\
& = \log \left( \left( \left( 2^{1 + \frac{2\sqrt{2}}{3}} \sqrt{e} A^{-6\sqrt{2}} \pi^{-\frac{1}{2} + \frac{1}{\sqrt{2}}} \right)^\pi \exp(-2\sqrt{2}C) \left( \frac{9\Gamma\left(-\frac{3}{4}\right)^2}{\pi\Gamma\left(-\frac{1}{4}\right)^2} \right)^{\sqrt{2}} \right)^\pi \right)
\end{aligned}$$

EXAMPLE 5.217.

$$\begin{aligned}
(5.217) \quad & \int_0^\infty \left( \frac{96}{(\pi - 4ix)^4} + \frac{1}{(\pi - 4ix)^2} + \frac{96}{(\pi + 4ix)^4} + \frac{1}{(\pi + 4ix)^2} \right) \cot^{-1}(e^{2x}) \sinh(x) dx \\
& = \frac{-16\pi + \frac{48C\pi + 7\pi^3 - 18\zeta(3)}{6\sqrt{2}}}{32\pi^2}
\end{aligned}$$

EXAMPLE 5.218.

$$\begin{aligned}
(5.218) \quad & \int_0^\infty \frac{(\pi^4 + 256x^2(-6 + x^2) + 32\pi^2(1 + x^2)) \cot^{-1}(e^{2x}) \sinh(x)}{(\pi^2 + 16x^2)^3} dx \\
& = \frac{-4\pi + \frac{48C + \pi(5\pi + \log(4096))}{6\sqrt{2}}}{16\pi^2}
\end{aligned}$$

EXAMPLE 5.219.

$$\begin{aligned}
(5.219) \quad & \int_0^\infty \frac{4\pi(\pi^4 + 16x^2(-6 + x^2) + 8\pi^2(1 + x^2)) \cot^{-1}(e^{2x}) \sinh(x)}{(\pi^2 + 4x^2)^3} dx \\
& = -\frac{1}{4\sqrt{2}\pi} \left( \zeta\left(2, -\frac{1}{8}\right) + 2\pi \left( 2\sqrt{2} - \psi^{(0)}\left(-\frac{1}{8}\right) - \psi^{(0)}\left(\frac{1}{8}\right) + \psi^{(0)}\left(\frac{3}{8}\right) \right. \right. \\
& \quad \left. \left. + \psi^{(0)}\left(\frac{5}{8}\right) \right) - \psi^{(1)}\left(\frac{1}{8}\right) - \psi^{(1)}\left(\frac{3}{8}\right) + \psi^{(1)}\left(\frac{5}{8}\right) \right)
\end{aligned}$$

EXAMPLE 5.220.

$$\begin{aligned}
(5.220) \quad & \int_0^\infty \frac{(288\pi^2 + 81\pi^4 - 1536x^2 + 288\pi^2x^2 + 256x^4) \cot^{-1}(e^{2x}) \sinh(x)}{(9\pi^2 + 16x^2)^3} dx \\
& = \frac{-48\sqrt{2} + 48\sqrt{2}C - 16\pi + 24\sqrt{2}\pi - 5\sqrt{2}\pi^2 + 4\sqrt{2}\pi \log(8)}{576\pi^2}
\end{aligned}$$

EXAMPLE 5.221.

$$\begin{aligned}
(5.221) \quad & \int_0^\infty x^{-2+k} \cot^{-1}(e^{2x}) (-2kmx \cos(mx) + (k - k^2 + (1 + m^2)x^2) \sin(mx)) \sinh(x) dx \\
& = \frac{e^{-\frac{1}{4}(m\pi)} \pi^k \csc\left(\frac{k\pi}{2}\right)}{4\sqrt{2}} \left( -k\Phi\left(-e^{-m\pi}, 1 - k, \frac{1}{4}\right) + (1 + m)\pi\Phi\left(-e^{-m\pi}, -k, \frac{1}{4}\right) \right)
\end{aligned}$$

$$\begin{aligned}
& +e^{-\frac{1}{2}(m\pi)} \left( k\Phi \left( -e^{-m\pi}, 1-k, \frac{3}{4} \right) - (-1+m)\pi\Phi \left( -e^{-m\pi}, -k, \frac{3}{4} \right) \right) \\
& +e^{\frac{m\pi}{2}} \left( k\Phi \left( -e^{m\pi}, 1-k, \frac{1}{4} \right) + (-1+m)\pi\Phi \left( -e^{m\pi}, -k, \frac{1}{4} \right) \right. \\
& \left. -e^{\frac{m\pi}{2}} \left( k\Phi \left( -e^{m\pi}, 1-k, \frac{3}{4} \right) + (1+m)\pi\Phi \left( -e^{m\pi}, -k, \frac{3}{4} \right) \right) \right)
\end{aligned}$$

EXAMPLE 5.222.

$$\begin{aligned}
(5.222) \quad & \int_0^\infty \frac{\cot^{-1}(e^{2x}) (x^2(-6+x^2) + 2(1+x^2)\log^2(a) + \log^4(a)) \sinh(x)}{(x^2 + \log^2(a))^3} dx \\
& = \frac{1}{16\pi \log^2(a)} \left( -4\pi^2 + \sqrt{2}\log(a) \left( 2\pi \left( -\psi^{(0)} \left( \frac{\pi + 4\log(a)}{8\pi} \right) - \psi^{(0)} \left( \frac{3}{8} + \frac{\log(a)}{2\pi} \right) \right) \right. \right. \\
& \quad \left. \left. + \psi^{(0)} \left( \frac{5}{8} + \frac{\log(a)}{2\pi} \right) + \psi^{(0)} \left( \frac{7}{8} + \frac{\log(a)}{2\pi} \right) \right) + \psi^{(1)} \left( \frac{\pi + 4\log(a)}{8\pi} \right) \right. \\
& \quad \left. - \psi^{(1)} \left( \frac{3}{8} + \frac{\log(a)}{2\pi} \right) - \psi^{(1)} \left( \frac{5}{8} + \frac{\log(a)}{2\pi} \right) + \psi^{(1)} \left( \frac{7}{8} + \frac{\log(a)}{2\pi} \right) \right)
\end{aligned}$$

EXAMPLE 5.223.

$$\begin{aligned}
(5.223) \quad & \int_0^\infty e^{-imx} \cot^{-1}(e^{2x}) \left( \frac{e^{2imx}(i - iam\pi + mx)}{(-ia\pi + x)^3} + \frac{-i + iam\pi + mx}{(ia\pi + x)^3} \right. \\
& \quad \left. + \frac{e^{imx}(1+m^2)(a\pi \cos(mx) + x \sin(mx))}{a^2\pi^2 + x^2} \right) \sinh(x) dx \\
& = \frac{1}{4} \left( -\frac{1}{a} + \frac{\sqrt{2}e^{\frac{m\pi}{4}}}{\pi} \left( (\pi - m\pi)\Phi \left( -e^{m\pi}, 1, \frac{1}{4} + a \right) + \Phi \left( -e^{m\pi}, 2, \frac{1}{4} + a \right) \right. \right. \\
& \quad \left. \left. + e^{\frac{m\pi}{2}} \left( (1+m)\pi\Phi \left( -e^{m\pi}, 1, \frac{3}{4} + a \right) - \Phi \left( -e^{m\pi}, 2, \frac{3}{4} + a \right) \right) \right) \right)
\end{aligned}$$

EXAMPLE 5.224.

$$\begin{aligned}
(5.224) \quad & \int_0^\infty e^x \left( \frac{e^{-2x}(1-i\pi+x)}{(\pi+ix)^3} + \frac{i(-1+i\pi+x)}{(i\pi+x)^3} \right) \cot^{-1}(e^{2x}) \sinh(x) dx \\
& = -\frac{19}{12} + \frac{4i((-8+10i)+9C)}{9\pi} + \pi
\end{aligned}$$

EXAMPLE 5.225.

$$\begin{aligned}
(5.225) \quad & \int_0^\infty e^x \left( \frac{8-4i\pi-8x}{(\pi-2ix)^3} - \frac{4ie^{-2x}(\pi+2i(1+x))}{(\pi+2ix)^3} \right) \cot^{-1}(e^{2x}) \sinh(x) dx \\
& = \frac{3}{2} - \frac{4i((-1-i)+C)}{\pi}
\end{aligned}$$

EXAMPLE 5.226.

$$(5.226) \quad \int_0^\infty e^x \left( \frac{\left( \frac{\pi}{4} - ix \right)^{-2+k} (-1+k + \frac{i\pi}{2} + 2x)}{-1+k} \right)$$

$$\begin{aligned}
& +e^{-2x} \left( \frac{\pi}{4} + ix \right)^{-2+k} \left( 1 - \frac{2 \left( -\frac{1}{4}(i\pi) + x \right)}{-1+k} \right) \cot^{-1} (e^{2x}) \sinh(x) dx \\
& = -\frac{2^{-1-2k} \pi^k (\pi + 2^{1+k} ((1+i) - i2^k) k \zeta(1-k) + 2^{1+k} (-1 + 2^{1+k}) \pi \zeta(-k))}{(-1+k)k}
\end{aligned}$$

EXAMPLE 5.227.

$$\begin{aligned}
(5.227) \quad & \int_0^\infty e^x \left( \frac{16(4 - i\pi - 4x)}{(\pi - 4ix)^3} - \frac{16ie^{-2x}(\pi + 4i(1+x))}{(\pi + 4ix)^3} \right) \cot^{-1} (e^{2x}) \sinh(x) dx \\
& = -1 + \left( \frac{1}{6} + \frac{i}{12} \right) \pi + \log(2)
\end{aligned}$$

EXAMPLE 5.228.

$$\begin{aligned}
(5.228) \quad & \int_0^\infty e^x \cot^{-1} (e^{2x}) \left( -i(\pi - 4ix)^{-1+k} + (-1+k)(\pi - 4ix)^{-2+k}(-2 + 2k + i\pi + 4x) \right. \\
& \left. \log \left( \frac{1}{4}(\pi - 4ix) \right) + e^{-2x}(\pi + 4ix)^{-2+k}(-i\pi + 4x + (-1+k)(-2 + 2k + i\pi - 4x) \right. \\
& \quad \left. \log \left( \frac{1}{4}(\pi + 4ix) \right) \right) \sinh(x) dx \\
& = \frac{1}{16k^2} \left( \pi^{1+k} \left( -1+k \left( 2+k \log \left( \frac{4}{\pi} \right) + \log \left( \frac{\pi}{4} \right) \right) \right) \right. \\
& \quad + 2\pi \left( (2\pi)^k \left( 1 + (-1+k)k \log \left( \frac{\pi}{2} \right) \right) \right. \\
& \quad \left. - 2^{1+k} \pi^k (k + 2^k(1 - 2k + (-1+k)k \log(\pi))) \zeta(-k) \right. \\
& \quad \left. + 4k \cos \left( \frac{k\pi}{2} \right) \Gamma(1+k) \left( (1+i) \left( 1+k \log \left( \frac{2}{\pi} \right) + \log \left( \frac{\pi}{2} \right) \right) \right. \right. \\
& \quad \left. \left. + i2^k(-1 + (-1+k) \log(\pi)) \zeta(k) + 2^{1+k}(-1+k)k\pi^k \left( ((1+i) - i2^k) k \zeta'(1-k) \right. \right. \right. \\
& \quad \left. \left. \left. + (-1 + 2^{1+k}) \pi \zeta'(-k) \right) \right) \right)
\end{aligned}$$

5.1.4. *Examples derived from Eq. (429410).*

EXAMPLE 5.229.

$$\begin{aligned}
(5.229) \quad & \int_0^\infty \frac{x^{-1+m} \tan^{-1}(bx)}{ai + \log(x)} dx \\
& = \sum_{y=0}^\infty (e^{ia})^{-m} \pi \left( \Gamma \left( 0, -im \left( a + \pi + 2\pi y - i \log \left( -\frac{i}{b} \right) \right) \right) \right. \\
& \quad \left. - \Gamma \left( 0, -im \left( a + \pi + 2\pi y - i \log \left( \frac{i}{b} \right) \right) \right) \right)
\end{aligned}$$

EXAMPLE 5.230.

$$(5.230) \quad \int_0^\infty \frac{x^{-1+m} \tan^{-1}(bx) \log(\log(x))}{\sqrt{\log(x)}} dx$$

$$\begin{aligned}
&= \sum_{y=0}^{\infty} \left( 4\pi {}_2F_2 \left( \frac{1}{2}, \frac{1}{2}; \frac{3}{2}, \frac{3}{2}; m \left( i(\pi + 2\pi y) + \log \left( -\frac{i}{b} \right) \right) \right) \sqrt{i(\pi + 2\pi y) + \log \left( -\frac{i}{b} \right)} \right. \\
&\quad \left. - 4\pi {}_2F_2 \left( \frac{1}{2}, \frac{1}{2}; \frac{3}{2}, \frac{3}{2}; m \left( i(\pi + 2\pi y) + \log \left( \frac{i}{b} \right) \right) \right) \sqrt{i\pi(1 + 2y) + \log \left( \frac{i}{b} \right)} \right. \\
&\quad \left. + \frac{\pi^{3/2}}{\sqrt{m}} \left( -\operatorname{erfi} \left( \sqrt{m} \sqrt{i(\pi + 2\pi y) + \log \left( -\frac{i}{b} \right)} \right) \log \left( i(\pi + 2\pi y) + \log \left( -\frac{i}{b} \right) \right) \right. \right. \\
&\quad \left. \left. + \operatorname{erfi} \left( \sqrt{m} \sqrt{i(\pi + 2\pi y) + \log \left( \frac{i}{b} \right)} \right) \log \left( i(\pi + 2\pi y) + \log \left( \frac{i}{b} \right) \right) \right) \right)
\end{aligned}$$

EXAMPLE 5.231.

(5.231)

$$\int_0^{\infty} \frac{\tan^{-1}(x)}{x^{3/2} \sqrt[3]{\log(x)}} dx = \sum_{y=0}^{\infty} 2^{2/3} \pi \left( -\Gamma \left( \frac{2}{3}, \frac{1}{4} i\pi(3 + 4y) \right) + \Gamma \left( \frac{2}{3}, \frac{1}{4} i(\pi + 4\pi y) \right) \right)$$

EXAMPLE 5.232.

(5.232)

$$\int_0^{\infty} \frac{\tan^{-1}(x)}{x^{5/3} \sqrt[4]{\log(x)}} dx = \sum_{y=0}^{\infty} \left( \frac{3}{2} \right)^{3/4} \pi \left( -\Gamma \left( \frac{3}{4}, \frac{1}{3} i\pi(3 + 4y) \right) + \Gamma \left( \frac{3}{4}, \frac{1}{3} i(\pi + 4\pi y) \right) \right)$$

5.1.5. Equations in this section are derived using (4.43).

EXAMPLE 5.233.

$$\begin{aligned}
(5.233) \quad &\int_0^{\infty} \frac{\tan^{-1} \left( \frac{x}{a} \right) \sinh(mx)}{b + \cosh(cx)} dx \\
&= \frac{e^{-\frac{m(i\pi + \cosh^{-1}(b))}{c}}}{2\sqrt{-1 + b^2}c} \pi \left( \Phi' \left( e^{-\frac{2im\pi}{c}}, 0, \frac{ac + \pi - i \cosh^{-1}(b)}{2\pi} \right) \right. \\
&\quad \left. - \left( b + \sqrt{-1 + b\sqrt{1 + b}} \right)^{\frac{2m}{c}} \left( \Phi' \left( e^{-\frac{2im\pi}{c}}, 0, \frac{ac + \pi + i \cosh^{-1}(b)}{2\pi} \right) \right) \right) \\
&+ e^{\frac{2im\pi}{c}} \Phi' \left( e^{\frac{2im\pi}{c}}, 0, \frac{ac + \pi - i \cosh^{-1}(b)}{2\pi} \right) + e^{\frac{2im\pi}{c}} \Phi' \left( e^{\frac{2im\pi}{c}}, 0, \frac{ac + \pi + i \cosh^{-1}(b)}{2\pi} \right)
\end{aligned}$$

EXAMPLE 5.234.

$$\begin{aligned}
(5.234) \quad &\int_0^{\infty} \frac{\cosh(mx) \log(-x^2 + \log^2(a))}{b + \cosh(cx)} dx \\
&= \frac{i\pi(-1 - i \cot(\frac{m\pi}{c}))}{2\sqrt{-1 + b^2}c} \left( \cos \left( \frac{m(\pi - i \cosh^{-1}(b))}{c} \right) - i \sin \left( \frac{m(\pi - i \cosh^{-1}(b))}{c} \right) \right) \\
&\quad \left( 2e^{\frac{2im\pi}{c}} \log \left( \frac{2i\pi}{c} \right) \left( -1 + \cosh \left( \frac{2m \cosh^{-1}(b)}{c} \right) + \sinh \left( \frac{2m \cosh^{-1}(b)}{c} \right) \right) \right. \\
&\quad \left. - \left( -1 + e^{\frac{2im\pi}{c}} \right) \left( \cosh \left( \frac{2m \cosh^{-1}(b)}{c} \right) + \sinh \left( \frac{2m \cosh^{-1}(b)}{c} \right) \right) \right)
\end{aligned}$$

$$\begin{aligned}
& \Phi' \left( e^{-\frac{2im\pi}{c}}, 0, \frac{\pi + i \cosh^{-1}(b) - ic \log(a)}{2\pi} \right) \\
& + \left( -1 + e^{\frac{2im\pi}{c}} \right) \left( \Phi' \left( e^{-\frac{2im\pi}{c}}, 0, -\frac{i(i\pi + \cosh^{-1}(b) + c \log(a))}{2\pi} \right) \right. \\
& \quad + e^{\frac{2im\pi}{c}} \left( -\Phi' \left( e^{\frac{2im\pi}{c}}, 0, \frac{\pi + i \cosh^{-1}(b) - ic \log(a)}{2\pi} \right) \right. \\
& \quad \left. \left. + \left( \cosh \left( \frac{2m \cosh^{-1}(b)}{c} \right) + \sinh \left( \frac{2m \cosh^{-1}(b)}{c} \right) \right) \right. \right. \\
& \quad \left. \left. \left. \Phi' \left( e^{\frac{2im\pi}{c}}, 0, -\frac{i(i\pi + \cosh^{-1}(b) + c \log(a))}{2\pi} \right) \right) \right) \right)
\end{aligned}$$

EXAMPLE 5.235.

$$\begin{aligned}
(5.235) \quad & \int_0^\infty \frac{x^{-1+s} \sinh(mx)}{b + \cosh(cx)} dx \\
& = \frac{2^{-2+s} (b + \sqrt{-1+b}\sqrt{1+b})^{-\frac{m}{c}} c^{-s} e^{-\frac{im\pi}{c}} \pi^s}{\sqrt{-1+b^2}} \left( \Phi \left( e^{-\frac{2im\pi}{c}}, 1-s, \frac{\pi - i \cosh^{-1}(b)}{2\pi} \right) \right. \\
& \quad \left. - (b + \sqrt{-1+b}\sqrt{1+b})^{\frac{2m}{c}} \left( \Phi \left( e^{-\frac{2im\pi}{c}}, 1-s, \frac{\pi + i \cosh^{-1}(b)}{2\pi} \right) \right) \right. \\
& \quad \left. + e^{\frac{2im\pi}{c}} \Phi \left( e^{\frac{2im\pi}{c}}, 1-s, \frac{\pi - i \cosh^{-1}(b)}{2\pi} \right) \right) + e^{\frac{2im\pi}{c}} \Phi \left( e^{\frac{2im\pi}{c}}, 1-s, \frac{\pi + i \cosh^{-1}(b)}{2\pi} \right) \sec \left( \frac{\pi s}{2} \right)
\end{aligned}$$

EXAMPLE 5.236.

$$\begin{aligned}
(5.236) \quad & \int_0^\infty \frac{x^{-1+s} \cosh(mx)}{b + \cosh(cx)} dx \\
& = \frac{i2^{-2+s} (b + \sqrt{-1+b}\sqrt{1+b})^{-\frac{m}{c}} c^{-s} e^{-\frac{im\pi}{c}} \pi^s \csc \left( \frac{\pi s}{2} \right)}{\sqrt{-1+b^2}} \\
& \quad \left( -\Phi \left( e^{-\frac{2im\pi}{c}}, 1-s, \frac{\pi - i \cosh^{-1}(b)}{2\pi} \right) + (b + \sqrt{-1+b}\sqrt{1+b})^{\frac{2m}{c}} \right. \\
& \quad \left. \left( \Phi \left( e^{-\frac{2im\pi}{c}}, 1-s, \frac{\pi + i \cosh^{-1}(b)}{2\pi} \right) - e^{\frac{2im\pi}{c}} \Phi \left( e^{\frac{2im\pi}{c}}, 1-s, \frac{\pi - i \cosh^{-1}(b)}{2\pi} \right) \right) \right. \\
& \quad \left. + e^{\frac{2im\pi}{c}} \Phi \left( e^{\frac{2im\pi}{c}}, 1-s, \frac{\pi + i \cosh^{-1}(b)}{2\pi} \right) \right)
\end{aligned}$$

EXAMPLE 5.237.

$$\begin{aligned}
(5.237) \quad & \int_0^\infty \frac{e^{mx} x^{-1+s}}{\cos(b\pi) + \cosh(cx)} dx \\
& = 2^{-1+s} c^{-s} e^{-\frac{i\pi(2(1+b)m+cs)}{2c}} \pi^s \csc(b\pi) \csc(\pi s) \left( e^{\frac{i\pi(2bm+cs)}{c}} \Phi \left( e^{-\frac{2im\pi}{c}}, 1-s, \frac{1}{2} - \frac{b}{2} \right) \right. \\
& \quad \left. - e^{i\pi s} \Phi \left( e^{-\frac{2im\pi}{c}}, 1-s, \frac{1+b}{2} \right) + e^{\frac{2im\pi}{c}} \Phi \left( e^{\frac{2im\pi}{c}}, 1-s, \frac{1}{2} - \frac{b}{2} \right) \right)
\end{aligned}$$



$$-e^{\frac{2i(1+b)m\pi}{c}} \Phi\left(e^{\frac{2im\pi}{c}}, 1-s, \frac{1+b}{2}\right)$$

EXAMPLE 5.238.

$$(5.238) \quad \int_0^\infty \frac{\sinh(rx) - \sinh(mx)}{x(b + \cosh(cx))} dx$$

$$= \frac{1}{2\sqrt{-1+b^2}} \left( e^{\frac{m(\pi + \cosh^{-1}(b))}{c}} \Phi\left(e^{\frac{2im\pi}{c}}, 1, \frac{\pi - i \cosh^{-1}(b)}{2\pi}\right) \right.$$

$$- e^{\frac{im(\pi + i \cosh^{-1}(b))}{c}} \Phi\left(e^{\frac{2im\pi}{c}}, 1, \frac{\pi + i \cosh^{-1}(b)}{2\pi}\right) - e^{\frac{r(\pi + \cosh^{-1}(b))}{c}} \Phi\left(e^{\frac{2ir\pi}{c}}, 1, \frac{\pi - i \cosh^{-1}(b)}{2\pi}\right)$$

$$\left. + e^{\frac{ir(\pi + i \cosh^{-1}(b))}{c}} \Phi\left(e^{\frac{2ir\pi}{c}}, 1, \frac{\pi + i \cosh^{-1}(b)}{2\pi}\right) \right)$$

EXAMPLE 5.239. Eq. (2.4.7.8) in [8].

$$(5.239) \quad \int_0^\infty \frac{\cosh(bx)}{(x^2 + z^2)(\cos(t) + \cosh(cx))} dx$$

$$= \frac{e^{-\frac{ib(\pi+t)}{c}} \csc(t)}{4z} \left( e^{\frac{2ibt}{c}} \Phi\left(e^{-\frac{2ib\pi}{c}}, 1, \frac{\pi-t+Cz}{2\pi}\right) - \Phi\left(e^{-\frac{2ib\pi}{c}}, 1, \frac{\pi+t+Cz}{2\pi}\right) \right.$$

$$\left. + e^{\frac{2ib\pi}{c}} \left( \Phi\left(e^{\frac{2ib\pi}{c}}, 1, \frac{\pi-t+Cz}{2\pi}\right) - e^{\frac{2ibt}{c}} \Phi\left(e^{\frac{2ib\pi}{c}}, 1, \frac{\pi+t+Cz}{2\pi}\right) \right) \right)$$

5.1.6. *Derived from equation (4.44).*

EXAMPLE 5.240.

$$(5.240) \quad \int_0^\infty \frac{\log^k(ab) - \log^k(ax)}{(b-x)\sqrt{x}} dx$$

$$= \frac{i4^k e^{\frac{ik\pi}{2}} \pi^{1+k} \left( -2\zeta\left(-k, \frac{2\pi - i \log(a) - i \log(b)}{4\pi}\right) + \zeta\left(-k, \frac{4\pi - i \log(a) - i \log(b)}{4\pi}\right) + \zeta\left(-k, -\frac{i(\log(a) + \log(b))}{4\pi}\right) \right)}{\sqrt{b}}$$

EXAMPLE 5.241.

$$(5.241) \quad \int_0^\infty \frac{\log(\log(ax))}{\sqrt{x}(-b+x)} dx = -\frac{i\pi \log}{\sqrt{b}} \left( \frac{\Gamma\left(-\frac{i \log(ab)}{4\pi}\right) \Gamma\left(1 - \frac{i \log(ab)}{4\pi}\right) \log(ab)}{\Gamma\left(\frac{1}{2} - \frac{i \log(ab)}{4\pi}\right)^2} \right)$$

EXAMPLE 5.242.

$$(5.242) \quad \int_0^1 \frac{(1+x) \log\left(\log\left(\frac{1}{x}\right)\right)}{\sqrt{x}(b+x)(1+bx)} dx$$

$$- \frac{\sqrt{b}\pi \log\left(\frac{(i+\sqrt{b})\Gamma\left(\frac{1}{2} - \frac{i \log(-b)}{4\pi}\right)^2}{(-i+\sqrt{b})\Gamma\left(-\frac{i \log(-b)}{4\pi}\right)\Gamma\left(1 - \frac{i \log(-b)}{4\pi}\right)}\right)}{b(1+b)} + \frac{\pi \log(\log(-b))}{\sqrt{b}(1+b)}$$

EXAMPLE 5.243.

$$(5.243) \quad \int_0^\infty \frac{x^{-1-m+\alpha} (-1+x^{2m})}{(1+x)\log(x)} dx = \log \left( \frac{\tan\left(\frac{1}{2}\pi(\alpha+m)\right)}{\tan\left(\frac{1}{2}\pi(\alpha-m)\right)} \right)$$

5.1.7. *Derived using equation (4.45).*

EXAMPLE 5.244.

$$(5.244) \quad \int_0^\infty \frac{x^{-1-m-\alpha+\beta} (x^{2m}-1)(x^{2\alpha}-1)}{(x^{2\beta}-1)\log(x)} dx = \log \left( \frac{1 + \cos\left(\frac{\pi(m-\alpha)}{\beta}\right)}{1 + \cos\left(\frac{\pi(m+\alpha)}{\beta}\right)} \right)$$

EXAMPLE 5.245.

$$(5.245) \quad \int_0^\infty \frac{x^{-1+m-\alpha+\beta} (-1+x^{2\alpha})}{(-1+x^{2\beta})(a^2\pi^2 + \log^2(x))} dx \\ = -\frac{i}{2a\pi} \left( e^{\frac{i\pi(m-\alpha)}{\beta}} \left( \Phi\left(-e^{\frac{i\pi(m-\alpha)}{\beta}}, 1, 1-a\beta\right) - \Phi\left(-e^{\frac{i\pi(m-\alpha)}{\beta}}, 1, 1+a\beta\right) \right) \right. \\ \left. + e^{\frac{i\pi(m+\alpha)}{\beta}} \left( -\Phi\left(-e^{\frac{i\pi(m+\alpha)}{\beta}}, 1, 1-a\beta\right) + \Phi\left(-e^{\frac{i\pi(m+\alpha)}{\beta}}, 1, 1+a\beta\right) \right) \right)$$

EXAMPLE 5.246.

$$(5.246) \quad \int_0^\infty \frac{x^{-1+\alpha} \log(ia\pi + \log(x))}{1+x^{2\alpha}} dx = -\frac{\pi}{2\alpha} \log \left( -\frac{i\alpha\Gamma\left(\frac{1}{4} + \frac{a\alpha}{2}\right)^2}{2\pi\Gamma\left(\frac{3}{4} + \frac{a\alpha}{2}\right)^2} \right)$$

EXAMPLE 5.247.

$$(5.247) \quad \int_0^\infty \frac{x^{-1-m-\alpha+\beta} (1-x^{2m})(-1+x^{2\alpha})}{(-1+x^{2\beta})\log(x)} dx = 2 \log \left( \frac{\cos\left(\frac{\pi(m+\alpha)}{2\beta}\right)}{\cos\left(\frac{\pi(m-\alpha)}{2\beta}\right)} \right)$$

EXAMPLE 5.248.

$$(5.248) \quad \int_0^\infty \frac{x^{-1+m-\alpha+\beta} (-1+x^{2\alpha}) \log^k(x)}{-1+x^{2\beta}} dx \\ = i^{1+k} \pi^{1+k} \beta^{-1-k} \left( -\text{Li}_{-k}\left(-e^{\frac{i\pi(m-\alpha)}{\beta}}\right) + \text{Li}_{-k}\left(-e^{\frac{i\pi(m+\alpha)}{\beta}}\right) \right)$$

5.1.8. *Derived from equation (4.50).*

EXAMPLE 5.249.

$$(5.249) \quad \int_0^\infty x^{-1+m} (1+x^q\beta^{-q})^{-n} \log^k(x) dx \\ = \sum_{t=0}^{-1+n} \sum_{j=0}^{-1+n} \frac{(-1)^{j+t} e^{\frac{im\pi}{q}} (2\pi)^{1+k-t} \left(-\frac{1}{q}\right)^t \left(\frac{i}{q}\right)^{-1+k-t} (\beta^{-q})^{-\frac{m}{q}} \left(-\frac{m-q}{q}\right)_{-1-j+n} (1+k-t)_t S_j^{(t)}}{q^2 j! (-1-j+n)!} \\ \Phi \left( e^{\frac{2im\pi}{q}}, -k+t, \frac{\pi + i \log(\beta^{-q})}{2\pi} \right)$$

EXAMPLE 5.250.

$$\begin{aligned}
 (5.250) \quad & \int_0^\infty x^{-1+\frac{m}{2}} (1+x^q)^{-n} \log^{2k}(x) dx \\
 &= \sum_{t=0}^{-1+n} \sum_{j=0}^{-1+n} \frac{(-1)^{j+t} e^{\frac{im\pi}{2q}} (2\pi)^{1+2k-t} \left(-\frac{1}{q}\right)^t \left(\frac{i}{q}\right)^{-1+2k-t} \left(-\frac{\frac{m}{2}-q}{q}\right)_{-1-j+n} (1+2k-t)_t S_j^{(t)}}{q^2 j! (-1-j+n)!} \\
 & \qquad \qquad \qquad \Phi\left(e^{\frac{im\pi}{q}}, -2k+t, \frac{1}{2}\right)
 \end{aligned}$$

5.1.9. The following were derived using equation (4.51).

EXAMPLE 5.251.

$$\begin{aligned}
 (5.251) \quad & \int_0^\infty \frac{\log\left(\log\left(ax\left(b+x+\sqrt{x(2b+x)}\right)\right)\right)}{x^{3/4}\sqrt{2b+x}\sqrt[4]{b+x+\sqrt{x(2b+x)}}} dx \\
 &= \frac{\pi}{2^{3/4}\sqrt{b}} \left( i\pi + \log(64) + 2\log(\pi) + 4\log\left(\frac{-2\pi + i\log(2) - i\log(ab^2)}{-6\pi + i\log(2) - i\log(ab^2)}\right) \right. \\
 & \qquad \qquad \qquad \left. -4\log\Gamma\left(-\frac{3}{4} - \frac{i\log\left(\frac{ab^2}{2}\right)}{8\pi}\right) + 4\log\Gamma\left(-\frac{1}{4} - \frac{i\log\left(\frac{ab^2}{2}\right)}{8\pi}\right) \right)
 \end{aligned}$$

EXAMPLE 5.252.

$$\begin{aligned}
 (5.252) \quad & \int_0^\infty \frac{\log\left(\log\left(\frac{2x(b+x+\sqrt{x(2b+x)})}{b^2}\right)\right)}{x^{3/4}\sqrt{2b+x}\sqrt[4]{b+x+\sqrt{x(2b+x)}}} dx \\
 &= \frac{\pi\left(i\pi + 2\log\left(\frac{8\pi}{9}\right) - 4\log\Gamma\left(-\frac{3}{4}\right) + 4\log\Gamma\left(-\frac{1}{4}\right)\right)}{2^{3/4}\sqrt{b}}
 \end{aligned}$$

EXAMPLE 5.253.

$$(5.253) \quad \int_0^\infty \frac{1}{x^{3/4}\sqrt{2b+x}\sqrt[4]{b+x+\sqrt{x(2b+x)}} \log^2\left(\frac{2x(b+x+\sqrt{x(2b+x)})}{b^2}\right)} dx = -\frac{C}{2^{3/4}\sqrt{b}\pi}$$

EXAMPLE 5.254.

$$(5.254) \quad \int_0^\infty \frac{\log\left(\frac{2x(b+x+\sqrt{x(2b+x)})}{b^2}\right) \log\left(\log\left(\frac{2x(b+x+\sqrt{x(2b+x)})}{b^2}\right)\right)}{x^{3/4}\sqrt{2b+x}\sqrt[4]{b+x+\sqrt{x(2b+x)}}} dx = -\frac{8i\sqrt[4]{2}C\pi}{\sqrt{b}}$$

EXAMPLE 5.255.

(5.255)

$$\int_0^\infty \frac{x^{-1+m} (b+x+\sqrt{x(2b+x)})^{-\frac{1}{2}+m}}{\sqrt{2b+x} \log\left(\frac{2x(b+x+\sqrt{x(2b+x)})}{b^2}\right)} dx = -2^{-\frac{1}{2}-m} b^{-1+2m} \log(i \cot(m\pi))$$

EXAMPLE 5.256.

$$(5.256) \quad -\frac{\int_0^\infty \frac{\log^2(2x(-1+x+\sqrt{(-2+x)x})) \log(\log(2x(-1+x+\sqrt{(-2+x)x})))}{\sqrt{-2+x} x^{3/4} \sqrt[4]{-1+x+\sqrt{(-2+x)x}}} dx}{56i\sqrt[4]{2}\pi} = \zeta(3)$$

EXAMPLE 5.257.

$$(5.257) \quad \int_0^\infty \frac{\log^2\left(\frac{2x(b+x+\sqrt{x(2b+x)})}{b^2}\right) \log\left(\log\left(\frac{2x(b+x+\sqrt{x(2b+x)})}{b^2}\right)\right)}{x^{3/4} \sqrt{2b+x} \sqrt[4]{b+x+\sqrt{x(2b+x)}}} dx \\ = \frac{\sqrt[4]{2}\pi((4\pi^2+0^2)\log(4i\pi)+32\pi^2\Phi'(-1,-2,\frac{1}{2}))}{\sqrt{b}}$$

EXAMPLE 5.258.

(5.258)

$$\int_0^\infty \frac{\log(2x(-1+x+\sqrt{(-2+x)x})) \log(\log(2x(-1+x+\sqrt{(-2+x)x})))}{\sqrt{-2+x} x^{3/4} \sqrt[4]{-1+x+\sqrt{(-2+x)x}}} dx \\ = -\frac{i\pi\left(-16i\pi \log\left(\frac{A^3}{\sqrt[3]{2}\sqrt[4]{e}}\right) + i\pi(2i\pi + \log(256\pi^4))\right)}{2^{3/4}}$$

EXAMPLE 5.259.

(5.259)

$$\int_0^\infty \frac{x^{-1+m} (-1+x+\sqrt{(-2+x)x})^{-\frac{1}{2}+m} \log^k(2x(-1+x+\sqrt{(-2+x)x}))}{\sqrt{-2+x}} dx \\ = i2^{\frac{3}{2}+2k-m} e^{\frac{ik\pi}{2}} \pi^{1+k} \text{Li}_{-k}(e^{4im\pi})$$

EXAMPLE 5.260.

(5.260)

$$\int_0^\infty \frac{x^{-1+m} (-1+x+\sqrt{(-2+x)x})^{-\frac{1}{2}+m} \log^k(2x(-1+x+\sqrt{(-2+x)x}))}{\sqrt{-2+x}} dx \\ = 2^{\frac{1}{2}+k-m} \Gamma(1+k) (\zeta(1+k, -2m) - e^{ik\pi} \zeta(1+k, 1+2m))$$

5.1.10. *These were derived using equation (4.55).*

EXAMPLE 5.261.

$$\begin{aligned}
 (5.261) \quad & \int_0^\infty \frac{\log^k(ax(x + \sqrt{b^2 + x^2}))}{\sqrt{x}(x + \sqrt{b^2 + x^2})^{3/2}} dx \\
 &= \frac{2^{-\frac{3}{2}+k} e^{\frac{1}{2}i(1+k)\pi} \pi^k}{b} \left( k \left( 2^{-1+k} \zeta \left( 1-k, -\frac{i(i\pi + \log(\frac{a}{2}) + \log(b^2))}{4\pi} \right) \right. \right. \\
 &\quad \left. \left. - 2^{-1+k} \zeta \left( 1-k, \frac{1}{2} \left( 1 - \frac{i(i\pi + \log(\frac{a}{2}) + \log(b^2))}{2\pi} \right) \right) \right) \right) \\
 &\quad - 3i\pi \left( 2^k \zeta \left( -k, -\frac{i(i\pi + \log(\frac{a}{2}) + \log(b^2))}{4\pi} \right) \right. \\
 &\quad \left. \left. - 2^k \zeta \left( -k, \frac{1}{2} \left( 1 - \frac{i(i\pi + \log(\frac{a}{2}) + \log(b^2))}{2\pi} \right) \right) \right) \right)
 \end{aligned}$$

EXAMPLE 5.262.

$$\begin{aligned}
 (5.262) \quad & \int_0^\infty \frac{\log^k(ax(x + \sqrt{b^2 + x^2}))}{x^{3/4}(x + \sqrt{b^2 + x^2})^{7/4}} dx \\
 &= \frac{2^{-\frac{5}{4}+k} e^{\frac{1}{2}i(\frac{1}{2}+k)\pi} \pi^k}{b^{3/2}} \left( k\Phi \left( i, 1-k, -\frac{i(i\pi + \log(\frac{a}{2}) + \log(b^2))}{2\pi} \right) \right. \\
 &\quad \left. - \frac{7}{2} i\pi\Phi \left( i, -k, -\frac{i(i\pi + \log(\frac{a}{2}) + \log(b^2))}{2\pi} \right) \right)
 \end{aligned}$$

EXAMPLE 5.263.

$$\begin{aligned}
 (5.263) \quad & \int_0^\infty x^{-1+m} (x + \sqrt{1+x^2})^{-2+m} \log^k(-2x(x + \sqrt{1+x^2})) dx \\
 &= 2^{-1+k-m} e^{\frac{1}{2}i(k+2m)\pi} \pi^k \left( e^{-2im\pi} k\text{Li}_{1-k}(e^{2im\pi}) + 2ie^{-2im\pi}(-2+m)\pi\text{Li}_{-k}(e^{2im\pi}) \right)
 \end{aligned}$$

EXAMPLE 5.264.

$$(5.264) \quad \int_0^\infty \frac{1}{\sqrt{x}(x + \sqrt{1+x^2})^{3/2} \log^2(-2x(x + \sqrt{1+x^2}))} dx = -\frac{\pi^3 - 6i\zeta(3)}{32\sqrt{2}\pi^2}$$

EXAMPLE 5.265.

$$(5.265) \quad \int_0^\infty \frac{1}{\sqrt{x}(x + \sqrt{1+x^2})^{3/2} \log(-2x(x + \sqrt{1+x^2}))} dx = -\frac{\pi + 36i \log(2)}{48\sqrt{2}}$$

EXAMPLE 5.266.

$$(5.266) \quad \int_0^\infty \frac{\log(-2x(x + \sqrt{1+x^2})) \log(\log(-2x(x + \sqrt{1+x^2})))}{\sqrt{x}(x + \sqrt{1+x^2})^{3/2}} dx$$

$$\begin{aligned}
& - \frac{i \left( \frac{1}{2} - \frac{3i\pi}{4} \right) \pi^2}{2\sqrt{2}} - \frac{\left( \frac{1}{2} - \frac{3i\pi}{4} \right) \pi \log(2)}{\sqrt{2}} - \frac{\left( \frac{1}{2} - \frac{3i\pi}{4} \right) \pi \log(\pi)}{\sqrt{2}} \\
& - \frac{\pi \left( \frac{1}{2} + 3i\pi \log \left( \frac{A^3}{\sqrt[3]{2}\sqrt[4]{e}} \right) - \Phi'(-1, 0, 1) \right)}{\sqrt{2}}
\end{aligned}$$

EXAMPLE 5.267.

$$\begin{aligned}
(5.267) \quad & \int_0^\infty \frac{\log^2(-2x(x + \sqrt{1+x^2})) \log(\log(-2x(x + \sqrt{1+x^2})))}{\sqrt{x}(x + \sqrt{1+x^2})^{3/2}} dx \\
& = \frac{\pi^3}{2\sqrt{2}} - \frac{i\pi^2 \log(2)}{\sqrt{2}} - \frac{i\pi^2 \log(\pi)}{\sqrt{2}} - i\sqrt{2}\pi^2 \left( \frac{1}{4} - 2 \log \left( \frac{A^3}{\sqrt[3]{2}\sqrt[4]{e}} \right) + \frac{21i\zeta(3)}{4\pi} \right)
\end{aligned}$$

EXAMPLE 5.268.

$$\begin{aligned}
(5.268) \quad & \int_0^\infty \frac{\log(\log(2x(x + \sqrt{1+x^2})))}{\sqrt{x}(x + \sqrt{1+x^2})^{3/2} \log(2x(x + \sqrt{1+x^2}))} dx \\
& = \frac{8C(2 - i\pi - 2 \log(2\pi)) + 3\pi^2 \left( 2i\gamma + \pi + i \log \left( \frac{16\pi^4}{\Gamma(\frac{1}{4})^8} \right) \right) + 4\Phi'(-1, 2, \frac{1}{2})}{16\sqrt{2}\pi}
\end{aligned}$$

EXAMPLE 5.269.

$$\begin{aligned}
(5.269) \quad & \int_0^\infty e^{(m-2)t} \cosh(t) \log^k(ae^t \sinh(t)) \sinh^{m-1}(t) dt \\
& = 2^{-1+k-m} e^{\frac{1}{2}i(k+2m)\pi} \pi^k \left( k\Phi \left( e^{2im\pi}, 1-k, \frac{\pi - i \log(\frac{a}{2})}{2\pi} \right) \right. \\
& \quad \left. + 2i(-2+m)\pi\Phi \left( e^{2im\pi}, -k, \frac{\pi - i \log(\frac{a}{2})}{2\pi} \right) \right)
\end{aligned}$$

EXAMPLE 5.270.

$$\begin{aligned}
(5.270) \quad & \int_0^\infty e^{(-2+m)t} \cosh(t) \log^k(-2e^t \sinh(t)) \sinh^{-1+m}(t) dt \\
& =, 2^{-1+k-m} e^{\frac{1}{2}i(k+2m)\pi} \pi^k \left( e^{-2im\pi} k\text{Li}_{1-k}(e^{2im\pi}) + 2ie^{-2im\pi}(-2+m)\pi\text{Li}_{-k}(e^{2im\pi}) \right)
\end{aligned}$$

EXAMPLE 5.271.

$$\begin{aligned}
(5.271) \quad & \int_0^\infty \frac{e^{(-2+m)t} \cosh(t) \sinh^{-1+m}(t)}{ia + t + \log(\sinh(t))} dt \\
& = \frac{2^{-2-m} e^{\frac{1}{2}i(-1+2m)\pi}}{\pi} \left( 2i(-2+m)\pi\Phi \left( e^{2im\pi}, 1, \frac{\pi - i \log(\frac{e^{ia}}{2})}{2\pi} \right) \right. \\
& \quad \left. - \Phi \left( e^{2im\pi}, 2, \frac{\pi - i \log(\frac{e^{ia}}{2})}{2\pi} \right) \right)
\end{aligned}$$

EXAMPLE 5.272.

$$\begin{aligned}
(5.272) \quad & \int_0^\infty \frac{e^{(-2+m)t} \cosh(t) \sinh^{-1+m}(t)}{(ia-b+t+\log(\sinh(t)))(ia+b+t+\log(\sinh(t)))} dt \\
& = -\frac{2^{-3-m} e^{im\pi}}{b\pi} \left( 2(-2+m)\pi \left( \Phi \left( e^{2im\pi}, 1, \frac{a-ib+\pi+i\log(2)}{2\pi} \right) \right. \right. \\
& \quad \left. \left. - \Phi \left( e^{2im\pi}, 1, \frac{a+ib+\pi+i\log(2)}{2\pi} \right) \right) + i \left( \Phi \left( e^{2im\pi}, 2, \frac{a-ib+\pi+i\log(2)}{2\pi} \right) \right. \right. \\
& \quad \left. \left. - \Phi \left( e^{2im\pi}, 2, \frac{a+ib+\pi+i\log(2)}{2\pi} \right) \right) \right)
\end{aligned}$$

EXAMPLE 5.273.

$$\begin{aligned}
(5.273) \quad & \int_0^\infty \frac{e^{-\frac{3t}{2}} \cosh(t)}{(ia-b+t+\log(\sinh(t)))(ia+b+t+\log(\sinh(t)))\sqrt{\sinh(t)}} dt \\
& = -\frac{6i\pi}{32\sqrt{2}b\pi} \left( \psi^{(0)} \left( \frac{a-ib+\pi+i\log(2)}{4\pi} \right) - \psi^{(0)} \left( \frac{a+ib+\pi+i\log(2)}{4\pi} \right) \right. \\
& \quad \left. - \psi^{(0)} \left( \frac{a-ib+3\pi+i\log(2)}{4\pi} \right) + \psi^{(0)} \left( \frac{a+ib+3\pi+i\log(2)}{4\pi} \right) \right) \\
& \quad + \psi^{(1)} \left( \frac{a-ib+\pi+i\log(2)}{4\pi} \right) - \psi^{(1)} \left( \frac{a+ib+\pi+i\log(2)}{4\pi} \right) \\
& \quad - \psi^{(1)} \left( \frac{a-ib+3\pi+i\log(2)}{4\pi} \right) + \psi^{(1)} \left( \frac{a+ib+3\pi+i\log(2)}{4\pi} \right)
\end{aligned}$$

EXAMPLE 5.274.

$$\begin{aligned}
(5.274) \quad & \int_0^\infty \frac{e^{-\frac{3t}{2}} \cosh(t)}{\left( 2i\pi+t+\log\left(\frac{\sinh(t)}{2}\right) \right) (2i\pi+t+\log(2\sinh(t)))\sqrt{\sinh(t)}} dt \\
& = \frac{16-16C-6i\pi\left(-4+\pi+H_{\frac{\pi+2i\log(2)}{4\pi}}-H_{-\frac{1}{4}+\frac{i\log(2)}{2\pi}}\right)-\psi^{(1)}\left(\frac{3}{4}+\frac{i\log(2)}{2\pi}\right)+\psi^{(1)}\left(\frac{5}{4}+\frac{i\log(2)}{2\pi}\right)}{32\sqrt{2}\pi\log(2)}
\end{aligned}$$

5.1.11. Following derived using equation (4.57).

EXAMPLE 5.275.

$$\begin{aligned}
(5.275) \quad & \int_0^\infty \frac{e^{-x} \log\left(\log\left(\frac{ae^{-x}}{\sqrt[8]{-1+\cosh(8x)}}\right)\right)}{\sqrt[8]{-1+\cosh(8x)}} dx \\
& = \frac{\pi}{8 \times 2^{3/8}} \left( i\pi + \log\left(\frac{\pi^2}{4}\right) - (2-2i) \left( \log\left(\frac{\Gamma\left(-\frac{i(2i\pi+\log(2)+8\log(a))}{16\pi}\right)}{2\Gamma\left(-\frac{i(10i\pi+\log(2)+8\log(a))}{16\pi}\right)}\right) \right. \right. \\
& \quad \left. \left. + i \log\left(\frac{\Gamma\left(-\frac{i(6i\pi+\log(2)+8\log(a))}{16\pi}\right)}{2\Gamma\left(-\frac{i(14i\pi+\log(2)+8\log(a))}{16\pi}\right)}\right) \right) \right)
\end{aligned}$$

5.1.12. *This section is derived from equation (4.58).*

EXAMPLE 5.276.

$$\begin{aligned}
 (5.276) \quad & \int_0^\infty x^{-1+s} \log(1 - e^{-2x}) \left( -2m(1+s)x \cos(mx) + (-s(1+s) + (1+m^2)x^2) \sin(mx) \right) \\
 & \quad \sinh(x) dx \\
 & = \frac{1}{2} \left( (-(-i-m))^{-2-s} - (i-m)^{-2-s} + (-i+m)^{-2-s} + (i+m)^{-2-s} \right) \Gamma(2+s) \\
 & \quad + \pi^{2+s} \left( -\text{Li}_{-1-s}(-e^{-m\pi}) + \text{Li}_{-1-s}(e^{m\pi}) \right) \sec\left(\frac{1}{2}\pi(1+s)\right)
 \end{aligned}$$

EXAMPLE 5.277.

$$\begin{aligned}
 (5.277) \quad & \int_0^\infty \left( \tan^{-1}\left(\frac{x}{a}\right) + \frac{2xa}{(a^2+x^2)^2} \right) \log(1 - e^{-2x}) \sinh(x) dx \\
 & = -ie^{-ia}\Gamma(0, -ia) + ie^{ia}\Gamma(0, ia) + \pi \log\left(\frac{\sqrt{2\pi}\Gamma\left(\frac{a+\pi}{2\pi}\right)}{\sqrt{a}\Gamma\left(\frac{a}{2\pi}\right)}\right)
 \end{aligned}$$

EXAMPLE 5.278.

$$\begin{aligned}
 (5.278) \quad & \int_0^\infty e^{-imx} \left( \frac{8}{(\pi - 2ix)^3} - \frac{8e^{2imx}}{(\pi + 2ix)^3} + \frac{-4m + \pi + m^2\pi - 2i(1+m^2)x}{(\pi - 2ix)^2} \right. \\
 & \quad \left. - \frac{e^{2imx}(-4m + \pi + m^2\pi + 2i(1+m^2)x)}{(\pi + 2ix)^2} \right) \log(1 - e^{-2x}) \sinh(x) dx \\
 & = i + e^{-\frac{1}{2}(m\pi)} \left( -2i \tan^{-1}\left(e^{\frac{m\pi}{2}}\right) - \Gamma\left(0, -\frac{1}{2}(-i+m)\pi\right) + \Gamma\left(0, -\frac{1}{2}(i+m)\pi\right) \right)
 \end{aligned}$$

EXAMPLE 5.279.

$$\begin{aligned}
 (5.279) \quad & \int_0^\infty x^{-1+s} \log(1 - e^{-2x}) \left( (-s(1+s) + (1+m^2)x^2) \cos(mx) + 2m(1+s)x \sin(mx) \right) \\
 & \quad \sinh(x) dx \\
 & = \frac{1}{2} \left( (-(-i-m))^{-2-s} - (i-m)^{-2-s} - (-i+m)^{-2-s} - (i+m)^{-2-s} \right) \Gamma(2+s) \\
 & \quad + \pi^{2+s} \left( \text{Li}_{-1-s}(-e^{-m\pi}) + \text{Li}_{-1-s}(e^{m\pi}) \right) \sec\left(\frac{\pi s}{2}\right)
 \end{aligned}$$

EXAMPLE 5.280.

$$\begin{aligned}
 (5.280) \quad & \int_0^\infty \left( \tan^{-1}\left(\frac{x}{a}\right) + \frac{2xa}{(a^2+x^2)^2} \right) \log(1 - e^{-2x}) \sinh(x) dx \\
 & = -ie^{-ia}\Gamma(0, -ia) + ie^{ia}\Gamma(0, ia) + \pi \log\left(\frac{\sqrt{2\pi}\Gamma\left(\frac{a+\pi}{2\pi}\right)}{\sqrt{a}\Gamma\left(\frac{a}{2\pi}\right)}\right)
 \end{aligned}$$



EXAMPLE 5.281.

$$\begin{aligned}
(5.281) \quad & \int_0^\infty e^{-imx} \left( \frac{8}{(\pi - 2ix)^3} - \frac{8e^{2imx}}{(\pi + 2ix)^3} + \frac{-4m + \pi + m^2\pi - 2i(1 + m^2)x}{(\pi - 2ix)^2} \right. \\
& \left. - \frac{e^{2imx}(-4m + \pi + m^2\pi + 2i(1 + m^2)x)}{(\pi + 2ix)^2} \right) \log(1 - e^{-2x}) \sinh(x) dx \\
& = i + e^{-\frac{1}{2}(m\pi)} \left( -2i \tan^{-1} \left( e^{\frac{m\pi}{2}} \right) - \Gamma \left( 0, -\frac{1}{2}(-i + m)\pi \right) + \Gamma \left( 0, -\frac{1}{2}(i + m)\pi \right) \right)
\end{aligned}$$

EXAMPLE 5.282.

$$\begin{aligned}
(5.282) \quad & \int_0^\infty x^{-1+s} \log(1 - e^{-2x}) \left( (-s(1 + s) + (1 + m^2)x^2) \cos(mx) + 2m(1 + s)x \sin(mx) \right) \\
& \quad \sinh(x) dx \\
& = \frac{1}{2} \left( (-(-i - m)^{-2-s} - (i - m)^{-2-s} - (-i + m)^{-2-s} - (i + m)^{-2-s} \right) \Gamma(2 + s) \\
& \quad + \pi^{2+s} \left( \text{Li}_{-1-s}(-e^{-m\pi}) + \text{Li}_{-1-s}(-e^{m\pi}) \right) \sec \left( \frac{\pi s}{2} \right)
\end{aligned}$$

EXAMPLE 5.283.

$$\begin{aligned}
(5.283) \quad & \int_0^\infty e^{-\frac{x}{2}} \log(1 - e^{-2x}) \left( -9(-1 + e^x)\pi^2 + x(-16 - 9x + e^x(-16 + 9x)) \right. \\
& + 2i\pi(8 + 9x + e^x(-8 + 9x)) + 2e^x(8 + 3\pi^2 + 2i\pi(4 - 3x) + (8 - 3x)x) \log(\pi - ix) \\
& \quad \left. - 2(8 + 3\pi^2 + 2i\pi(4 + 3x) - x(8 + 3x)) \log(\pi + ix) \right) \sinh(x) dx \\
& = \frac{8}{27} i \left( 32 \left( -27\Gamma \left( 0, \frac{i\pi}{2} \right) + \Gamma \left( 0, -\frac{1}{2}(3i\pi) \right) + 26i \log(\pi) \right) \right. \\
& \quad \left. - 480\pi(-1 + \log(\pi)) + 9\pi^2 \left( (-4i + 3\pi)(-3 + 2\log(\pi)) + 6i\pi \text{Li}'_{-2}(-i) \right) \right)
\end{aligned}$$

EXAMPLE 5.284.

$$\begin{aligned}
(5.284) \quad & \int_0^\infty i e^{-imx} \left( (-1 + k)k(-ix + \log(a))^{-2+k} - e^{2imx}(-1 + k)k(ix + \log(a))^{-2+k} \right. \\
& \quad \left. + 2km \left( (-ix + \log(a))^{-1+k} - e^{2imx}(ix + \log(a))^{-1+k} \right) \right. \\
& \quad \left. + (1 + m^2) \left( (-ix + \log(a))^k - e^{2imx}(ix + \log(a))^k \right) \log(1 - e^{-2x}) \sinh(x) dx \right. \\
& \quad \left. = 2a^{-i-m}k \left( -a^{2i}(i - m)^{-1-k} \Gamma(k, -((-i + m)\log(a))) \right. \right. \\
& \quad \left. \left. - (-i - m)^{-1-k} \Gamma(k, -((i + m)\log(a))) \right) + \pi \left( -2e^{m\pi} \pi^k \Phi \left( -e^{m\pi}, -k, \frac{\pi + \log(a)}{\pi} \right) + \log^k(a) \right) \right. \\
& \quad \left. - 2im \left( -(i - m)^{-1-k} \left( -((-i + m)\log(a))^k + (-i - m)^{-1-k} \left( -((i + m)\log(a))^k \right) \right) \right) \right)
\end{aligned}$$

EXAMPLE 5.285.

$$\begin{aligned}
(5.285) \quad & \int_0^\infty \log(1 - e^{-2x}) \left( \frac{1}{-ix + \log(a)} - \frac{1}{ix + \log(a)} + (-ix + \log(a)) \log(-ix + \log(a)) \right. \\
& \quad \left. - (ix + \log(a)) \log(ix + \log(a)) \right) \sinh(x) dx \\
& = -i \left( 4 + 2a^{-i} \left( a^i \log(-i \log(a)) + G_{1,2}^{2,0} \left( -i \log(a) \middle| \begin{matrix} 1 \\ 0, 0 \end{matrix} \right) \right) \right. \\
& \quad \left. + a^{2i} \left( a^{-i} \log(i \log(a)) + G_{1,2}^{2,0} \left( i \log(a) \middle| \begin{matrix} 1 \\ 0, 0 \end{matrix} \right) \right) \right) \\
& + \pi \left( -2\pi \left( 2\zeta \left( -1, \frac{\pi + \log(a)}{2\pi} \right) - 2\zeta \left( -1, \frac{1}{2} \left( 1 + \frac{\pi + \log(a)}{\pi} \right) \right) \right) \log(\pi) \right. \\
& \quad \left. + \log(a) \log(\log(a)) + 2\pi \Phi' \left( -1, -1, \frac{\pi + \log(a)}{\pi} \right) \right)
\end{aligned}$$

EXAMPLE 5.286.

$$\begin{aligned}
(5.286) \quad & \int_0^\infty \log(1 - e^{-2x}) \left( 80 \left( -\frac{1}{(\pi - 2ix)^4} + \frac{1}{(\pi + 2ix)^4} \right) \right. \\
& \quad \left. + \frac{4(24 + (\pi - 2ix)^2) \log\left(\frac{1}{2}(\pi - 2ix)\right)}{(\pi - 2ix)^4} \right. \\
& \quad \left. - \frac{4(24 + (\pi + 2ix)^2) \log\left(\frac{1}{2}(\pi + 2ix)\right)}{(\pi + 2ix)^4} \right) \sinh(x) dx \\
& = \frac{i}{2\pi} \left( \pi \text{Ci} \left( \frac{\pi}{2} \right) (4 + \log(256) - 8 \log(\pi)) \right. \\
& + 8\pi \left( G_{2,3}^{3,0} \left( -\frac{1}{2}(i\pi) \middle| \begin{matrix} 1, 1 \\ -2, 0, 0 \end{matrix} \right) + G_{2,3}^{3,0} \left( \frac{i\pi}{2} \middle| \begin{matrix} 1, 1 \\ -2, 0, 0 \end{matrix} \right) \right) \\
& \quad \left. - 4 \left( 2 + \log(4) - 6 \log(\pi) + 4C \log(\pi) + \Phi' \left( -1, 2, \frac{3}{2} \right) \right) \right)
\end{aligned}$$

EXAMPLE 5.287.

$$\begin{aligned}
(5.287) \quad & \int_0^\infty \frac{\log(1 - e^{-2x}) \sinh(x)}{(\pi^2 + x^2)^3} (4mx(\pi^2 + x^2) \cos(mx) + ((1 + m^2)\pi^4 - 6x^2 + (1 + m^2)x^4 \\
& \quad + 2\pi^2(1 + (1 + m^2)x^2)) \sin(mx) dx \\
& = \frac{1}{2\pi} (e^{-m\pi} (\Gamma(0, -((-i + m)\pi)) + \Gamma(0, -((i + m)\pi)) \\
& - e^{2m\pi} (\Gamma(0, (-i + m)\pi) + \Gamma(0, (i + m)\pi) + \log(1 + e^{-m\pi})) + \log(1 + e^{m\pi}))
\end{aligned}$$

5.1.13. *Formaule derived using equation (4.59).*

EXAMPLE 5.288.

$$\begin{aligned}
(5.288) \quad & \int_0^z \frac{x^{-1+m} \log^k \left( ax (-x^{2m} + z^{2m})^{-\frac{1}{2m}} \right)}{\sqrt{-x^{2m} + z^{2m}}} dx \\
& = -i \left( \frac{i}{m} \right)^{1+k} \pi^{1+k} \left( 2^k \zeta \left( -k, \frac{\pi - 2im \log(a)}{4\pi} \right) - 2^k \zeta \left( -k, \frac{1}{2} \left( 1 + \frac{\pi - 2im \log(a)}{2\pi} \right) \right) \right)
\end{aligned}$$

EXAMPLE 5.289.

$$\begin{aligned}
(5.289) \quad & \int_0^z \frac{x^{-1+m} \log \left( \log \left( ax (-x^{2m} + z^{2m})^{-\frac{1}{2m}} \right) \right)}{\sqrt{-x^{2m} + z^{2m}}} dx \\
&= \frac{\pi}{2m} \left( \log \left( \frac{2i\pi}{m} \right) - 2 \log(-3\pi - 2im \log(a)) + 2 \log(-\pi - 2im \log(a)) \right. \\
&\quad \left. + 2 \log \Gamma \left( -\frac{\pi + 2im \log(a)}{4\pi} \right) - 2 \log \Gamma \left( -\frac{3}{4} - \frac{im \log(a)}{2\pi} \right) \right)
\end{aligned}$$

EXAMPLE 5.290.

$$(5.290) \quad \int_0^z \frac{x^{-1+m} \log^k \left( ax (-x^m + z^m)^{-1/m} \right)}{-x^m + z^m} dx = \left( \frac{i}{m} \right)^{1+k} (2\pi)^{1+k} \zeta \left( -k, \frac{\pi - im \log(a)}{2\pi} \right)$$

EXAMPLE 5.291.

$$\begin{aligned}
(5.291) \quad & \int_0^z \frac{x^{-1+m} \log \left( \log \left( ax (-x^m + z^m)^{-1/m} \right) \right)}{-x^m + z^m} dx \\
&= \frac{i}{m} \left( im \log(a) \log \left( \frac{2i\pi}{m} \right) + \pi(\log(8) + 3 \log(\pi)) \right. \\
&\quad \left. - 2 \log(-\pi - im \log(a)) - 2\pi \log \Gamma \left( -\frac{\pi + im \log(a)}{2\pi} \right) \right)
\end{aligned}$$

EXAMPLE 5.292.

$$\begin{aligned}
(5.292) \quad & \int_0^z x^{-1+m} (-x^u + z^u)^{-\frac{m}{u}} \log^k \left( e^{\frac{i\pi}{u}} x (-x^u + z^u)^{-1/u} \right) dx \\
&= -e^{-\frac{im\pi}{u}} (2\pi)^{1+k} \left( \frac{i}{u} \right)^{1+k} \text{Li}_{-k} \left( e^{\frac{2im\pi}{u}} \right)
\end{aligned}$$

EXAMPLE 5.293.

$$\begin{aligned}
(5.293) \quad & \int_0^z x^{-1+m} (-x^u + z^u)^{-\frac{m}{u}} \log^k \left( e^{\frac{i\pi}{u}} x (-x^u + z^u)^{-1/u} \right) dx \\
&= \frac{i^{-k} e^{-\frac{im\pi}{u}} \left( \frac{i}{u} \right)^k \Gamma(1+k) \left( -\zeta \left( 1+k, -\frac{m}{u} \right) + i^{2k} \zeta \left( 1+k, \frac{m+u}{u} \right) \right)}{u}
\end{aligned}$$

EXAMPLE 5.294.

$$\begin{aligned}
(5.294) \quad & \int_0^z \frac{x^{-1+m} (-x^u + z^u)^{-\frac{m}{u}}}{i\pi + u \log \left( x (-x^u + z^u)^{-1/u} \right)} dx \\
&= \frac{e^{-\frac{im\pi}{u}}}{2u^2} \left( i\pi(2m+u) + u \log(4\pi^2) \right. \\
&\quad \left. - 2u \left( \log \left( \frac{m}{u} \right) + \log \left( -\frac{m+u}{u} \right) \right) - 2u \left( \log \Gamma \left( \frac{m}{u} \right) + \log \Gamma \left( -\frac{m+u}{u} \right) \right) \right)
\end{aligned}$$

EXAMPLE 5.295.

$$(5.295) \quad \int_0^z \frac{x^m (-x^u + z^u)^{-\frac{m}{u}} - x^r (-x^u + z^u)^{-\frac{r}{u}}}{x \log \left( x (-x^u + z^u)^{-1/u} \right)} dx = \log \left( \frac{\tan \left( \frac{m\pi}{2u} \right)}{\tan \left( \frac{r\pi}{2u} \right)} \right)$$

EXAMPLE 5.296.

$$(5.296) \quad \int_0^z \frac{x^{-1+m} \log \left( e^{\frac{i\pi}{2m}} x (-x^{2m} + z^{2m})^{-\frac{1}{2m}} \right) \log \left( \log \left( e^{\frac{i\pi}{2m}} x (-x^{2m} + z^{2m})^{-\frac{1}{2m}} \right) \right)}{\sqrt{-x^{2m} + z^{2m}}} dx \\ = -\frac{i\pi \left( 4\pi \log \left( \frac{A^3}{\sqrt[3]{2}\sqrt[4]{e}} \right) - \pi \log \left( \frac{i\pi}{m} \right) \right)}{4m^2}$$

EXAMPLE 5.297.

$$(5.297) \quad \int_0^z \frac{x^{-1+m} \log^2 \left( e^{\frac{i\pi}{2m}} x (-x^{2m} + z^{2m})^{-\frac{1}{2m}} \right) \log \left( \log \left( e^{\frac{i\pi}{2m}} x (-x^{2m} + z^{2m})^{-\frac{1}{2m}} \right) \right)}{\sqrt{-x^{2m} + z^{2m}}} dx \\ = \frac{7\pi\zeta(3)}{4m^3}$$

EXAMPLE 5.298.

$$(5.298) \quad \int_0^z \frac{x^{-1+m}}{\sqrt{-x^{2m} + z^{2m}} \log^2 \left( x (-x^{2m} + z^{2m})^{-\frac{1}{2m}} \right)} dx = -\frac{4Cm}{\pi}$$

EXAMPLE 5.299.

$$(5.299) \quad \int_0^z \frac{x^{-1+m} \log \left( x (-x^{2m} + z^{2m})^{-\frac{1}{2m}} \right) \log \left( \log \left( x (-x^{2m} + z^{2m})^{-\frac{1}{2m}} \right) \right)}{\sqrt{-x^{2m} + z^{2m}}} dx = -\frac{iC\pi}{m^2}$$

5.1.14. From equation (4.63).

EXAMPLE 5.300.

$$(5.300) \quad \int_0^\infty \int_0^\infty \frac{y^5 \Gamma(4i+x) \sqrt{\log \left( \frac{iy}{\sqrt[8]{x}} \right)}}{\sqrt[4]{x} (1+y^8) \Gamma((4+4i)+x)} dy dx \\ = \left( -\frac{7}{10200} + \frac{11i}{10200} \right) \pi^{5/2} \left( (30+15i)(1+4i)^{3/4} \sqrt{2} \zeta \left( -\frac{1}{2}, \frac{3}{4} + \frac{i \log(1+4i)}{8\pi} \right) \right. \\ \left. - (30+15i)(1+4i)^{3/4} \sqrt{2} \zeta \left( -\frac{1}{2}, \frac{5}{4} + \frac{i \log(1+4i)}{8\pi} \right) \right. \\ \left. + (39-48i) \sqrt[4]{-22-4i} \zeta \left( -\frac{1}{2}, \frac{3}{4} + \frac{i \log(2+4i)}{8\pi} \right) \right. \\ \left. + (48+39i)(1+2i)^{3/4} \sqrt[4]{2} \zeta \left( -\frac{1}{2}, \frac{5}{4} + \frac{i \log(2+4i)}{8\pi} \right) \right)$$

$$\begin{aligned}
& + (6 + 7i) \left( \sqrt{4 + 22i} \zeta \left( -\frac{1}{2}, \frac{3}{4} + \frac{i \log(3 + 4i)}{8\pi} \right) \right. \\
& - \sqrt{4 + 22i} \zeta \left( -\frac{1}{2}, \frac{5}{4} + \frac{i \log(3 + 4i)}{8\pi} \right) + (3 + 4i)(-1)^{7/8} \left( \zeta \left( -\frac{1}{2}, \frac{11}{16} + \frac{i \log(4)}{8\pi} \right) \right. \\
& \left. \left. \left. - \zeta \left( -\frac{1}{2}, \frac{19}{16} + \frac{i \log(4)}{8\pi} \right) \right) \right) \right)
\end{aligned}$$

EXAMPLE 5.301.

$$\begin{aligned}
(5.301) \quad & \int_0^\infty \int_0^\infty \frac{y^2 \Gamma(3i + x) \log \left( \log \left( \frac{iy}{\sqrt[4]{x}} \right) \right)}{\sqrt[4]{x} (1 + 3y^4) \Gamma((3 + 3i) + x)} dy dx \\
& = \left( \frac{2}{195} + \frac{i}{780} \right) \pi^2 \left( -\frac{1}{2} \left( (1 + 8i)(-1)^{7/8} + (5 + i)(1 + 3i)^{3/4} \sqrt[4]{3} \right. \right. \\
& - (2 + i)(2 + 3i)^{3/4} \sqrt[4]{3} \left. \left. \right) (\pi - 2i \log(2\pi)) + 2 \left( (8 - i)(-1)^{7/8} \log \left( \frac{\Gamma \left( \frac{7}{16} + \frac{i \log(3)}{4\pi} \right)}{\Gamma \left( \frac{15}{16} + \frac{i \log(3)}{4\pi} \right)} \right) \right. \right. \\
& + \sqrt[4]{3} \left( (1 - 5i)(1 + 3i)^{3/4} \log \left( \frac{\Gamma \left( \frac{8\pi - 2 \tan^{-1}(3) + i \log(90)}{16\pi} \right)}{\Gamma \left( \frac{16\pi - 2 \tan^{-1}(3) + i \log(90)}{16\pi} \right)} \right) \right. \\
& \left. \left. \left. - (1 - 2i)(2 + 3i)^{3/4} \log \left( \frac{\Gamma \left( \frac{7\pi + \tan^{-1}(\frac{12}{5}) + i \log(117)}{16\pi} \right)}{\Gamma \left( \frac{15\pi + \tan^{-1}(\frac{12}{5}) + i \log(117)}{16\pi} \right)} \right) \right) \right) \right)
\end{aligned}$$

EXAMPLE 5.302.

$$\begin{aligned}
(5.302) \quad & \int_0^\infty \int_0^\infty \frac{y^2 \Gamma(1 + x) \log \left( \log \left( -\frac{y}{\sqrt[4]{x}} \right) \right)}{\sqrt[4]{x} (1 + y^4) \Gamma(4 + x)} dy dx \\
& = \frac{1}{24} \pi^2 \left( i \left( 3 - 3 \times 2^{3/4} + 3^{3/4} \right) \pi - 18 \log(2) + 3^{3/4} \log(4) \right. \\
& \left. + 2 \left( \left( 3 + 3^{3/4} \right) \log(\pi) - 3 \times 2^{3/4} \log(2\pi) \right) \right. \\
& \left. + \log \left( \frac{\Gamma \left( \frac{1}{4} \right)^6 \left( \frac{\Gamma \left( \frac{3}{4} + \frac{i \log(2)}{8\pi} \right)}{\Gamma \left( \frac{5}{4} + \frac{i \log(2)}{8\pi} \right)} \right)^{6 \times 2^{3/4}} \left( \frac{\Gamma \left( \frac{3}{4} + \frac{i \log(3)}{8\pi} \right)}{\Gamma \left( \frac{5}{4} + \frac{i \log(3)}{8\pi} \right)} \right)^{-2 \times 3^{3/4}}}{\Gamma \left( \frac{3}{4} \right)^6} \right) \right)
\end{aligned}$$

EXAMPLE 5.303.

$$\begin{aligned}
(5.303) \quad & \int_0^\infty \int_0^\infty \frac{y^2 \Gamma(1 + x) \log \left( \log \left( \frac{iy}{\sqrt[4]{x}} \right) \right)}{\sqrt[4]{x} (1 + y^4) \Gamma(4 + x)} dy dx \\
& = \frac{1}{24} \pi^2 \left( i \left( 3 - 3 \times 2^{3/4} + 3^{3/4} \right) \pi + 3^{3/4} \log(4) - \left( -1 + 2^{3/4} \right) \log(64) \right)
\end{aligned}$$

$$\begin{aligned}
& +2 \left( -3 \times 2^{3/4} + 3^{3/4} \right) \log(\pi) + 12 \times 2^{3/4} \log \left( \frac{\Gamma \left( \frac{1}{2} + \frac{i \log(2)}{8\pi} \right)}{\Gamma \left( 1 + \frac{i \log(2)}{8\pi} \right)} \right) \\
& \qquad - 4 \times 3^{3/4} \log \left( \frac{\Gamma \left( \frac{1}{2} + \frac{i \log(3)}{8\pi} \right)}{\Gamma \left( 1 + \frac{i \log(3)}{8\pi} \right)} \right)
\end{aligned}$$

5.1.15. *Formulae derived using equation (4.64).*

EXAMPLE 5.304.

$$(5.304) \quad \int_0^\infty \int_0^\infty \int_0^\infty \int_0^\infty \frac{e^{-4(t+y^4+z^4)} y^3 z^3 K \left( \frac{1-x}{2} \right) \theta(1-x)}{\sqrt{t} \sqrt{x} \log \left( -\frac{2xy^2z^2}{t} \right)} dt dz dy dx = -\frac{i\pi^{3/2} \log(2)}{1024\sqrt{2}}$$

EXAMPLE 5.305.

$$(5.305) \quad \int_0^\infty \int_0^\infty \int_0^\infty \int_0^\infty \frac{e^{-\pi(t+y^4+z^4)} y^3 z^3 K \left( \frac{1-x}{2} \right) \theta(1-x)}{\sqrt{t} \sqrt{x} \log^2 \left( -\frac{2xy^2z^2}{t} \right)} dt dz dy dx = -\frac{1}{768\sqrt{2}}$$

EXAMPLE 5.306.

$$(5.306) \quad \int_0^\infty \int_0^\infty \int_0^\infty \int_0^\infty \frac{e^{-t-y^4-z^4} y^3 z^3 K \left( \frac{1-x}{2} \right) \theta(1-x)}{\sqrt{t} \sqrt{x} \log^3 \left( -\frac{2xy^2z^2}{t} \right)} dt dz dy dx = \frac{3i\zeta(3)}{512\sqrt{2\pi}}$$

EXAMPLE 5.307.

$$\begin{aligned}
(5.307) \quad & \int_0^\infty \int_0^\infty \int_0^\infty \int_0^\infty \frac{e^{-t-y^4-z^4} y^3 z^3 K \left( \frac{1-x}{2} \right) \theta(1-x) \log \left( -\frac{2xy^2z^2}{t} \right) \log \left( \log \left( -\frac{2xy^2z^2}{t} \right) \right)}{\sqrt{t} \sqrt{x}} dt dz dy dx \\
& = -\frac{\pi^{9/2}}{64\sqrt{2}} + \frac{i\pi^{7/2} \log(2)}{32\sqrt{2}} - \frac{i\pi^{7/2} \log \left( \frac{A^3}{\sqrt[3]{2} \sqrt[4]{e}} \right)}{8\sqrt{2}} + \frac{i\pi^{7/2} \log(\pi)}{32\sqrt{2}}
\end{aligned}$$

EXAMPLE 5.308.

$$\begin{aligned}
(5.308) \quad & \int_0^\infty \int_0^\infty \int_0^\infty \int_0^\infty \frac{e^{-t-y^4-z^4} y^3 z^3 K \left( \frac{1-x}{2} \right) \theta(1-x) \log^2 \left( -\frac{2xy^2z^2}{t} \right) \log \left( \log \left( -\frac{2xy^2z^2}{t} \right) \right)}{\sqrt{t} \sqrt{x}} dt dz dy dx \\
& = \frac{7\pi^{5/2} \zeta(3)}{16\sqrt{2}}
\end{aligned}$$

EXAMPLE 5.309.

(5.309)

$$\int_0^\infty \int_0^\infty \int_0^\infty \int_0^\infty \frac{e^{-t-y^4-z^4} y^3 z^3 K\left(\frac{1-x}{2}\right) \theta(1-x) \log\left(\frac{2xy^2z^2}{t}\right) \log\left(\log\left(\frac{2xy^2z^2}{t}\right)\right)}{\sqrt{t}\sqrt{x}} dt dz dy dx = -\frac{iC\pi^{5/2}}{8\sqrt{2}}$$

5.1.16. *Formulae derived using equation (4.65).*

EXAMPLE 5.310.

$$(5.310) \quad \int_{-1}^1 \int_{-1}^1 \frac{\left(\frac{1+y}{1-y}\right)^{3/4}}{\left(-1 + \frac{2}{1+x}\right)^{5/8} (1+y^2) \log\left(\frac{\sqrt{-1+\frac{2}{1+x}}(1+y)}{-1+y}\right)} dy dx = -\frac{1}{96} \sqrt[4]{-1} (48C + \pi(29i\pi + 60 \log(2)))$$

EXAMPLE 5.311.

(5.311)

$$\int_{-1}^1 \int_{-1}^1 \frac{\sqrt{\frac{y+1}{1-y}}}{\left(\frac{2}{x+1} - 1\right)^{3/4} (y^2 + 1) \log\left(\frac{\sqrt{\frac{2}{x+1}-1}(y+1)}{y-1}\right)} dy dx = -\frac{1}{24} \pi(\pi + 36i \log(2))$$

EXAMPLE 5.312.

$$(5.312) \quad \int_{-1}^1 \int_{-1}^1 \frac{\sqrt{\frac{y+1}{1-y}} \log^k\left(\frac{\sqrt{\frac{2}{x+1}-1}(y+1)}{y-1}\right)}{\left(\frac{2}{x+1} - 1\right)^{3/4} (y^2 + 1)} dy dx = 2^k e^{\frac{1}{2}i\pi(k+1)} \pi^{k+1} \left( (1-2^k) k\zeta(1-k) + 3i\pi(2^{k+1}-1)\zeta(-k) \right)$$

EXAMPLE 5.313.

$$(5.313) \quad \int_{-1}^1 \int_{-1}^1 \frac{\sqrt{\frac{1+y}{1-y}} \log\left(\log\left(\frac{\sqrt{-1+\frac{2}{1+x}}(1+y)}{-1+y}\right)\right)}{\left(-1 + \frac{2}{1+x}\right)^{3/4} (1+y^2) \log\left(\frac{\sqrt{-1+\frac{2}{1+x}}(1+y)}{-1+y}\right)} dy dx = \frac{1}{48} \pi \left( -i\pi^2 + 2\pi(1 + \gamma + 19 \log(2) - 12 \log(A)) + 36i \log(2) \left( 2\gamma + \log\left(\frac{1}{8\pi^2}\right) \right) \right)$$

EXAMPLE 5.314.

$$(5.314) \quad \int_{-1}^1 \int_{-1}^1 \frac{(1+x) \left( \sqrt[4]{-1 + \frac{2}{1+x}} \sqrt{\frac{1+y}{1-y}} - \sqrt[3]{-1 + \frac{2}{1+x}} \left(\frac{1+y}{1-y}\right)^{2/3} \right)}{(-1+x)(1+y^2) \log\left(\frac{\sqrt{-1+\frac{2}{1+x}}(1+y)}{1-y}\right)} dy dx = 2C + \frac{3i\pi^2}{4} - \frac{8}{3} \pi \tanh^{-1}\left((-1)^{2/3}\right) - \frac{1}{2} \sqrt[6]{-1} \Phi\left(-\sqrt[3]{-1}, 2, \frac{1}{2}\right)$$

EXAMPLE 5.315.

$$(5.315) \quad \int_{-1}^1 \int_{-1}^1 \frac{\sqrt{\frac{1+y}{1-y}} \left( \log \left( -1 + \frac{2}{1+x} \right) + 2 \log \left( \frac{1+y}{1-y} \right) \right)}{2 \left( -1 + \frac{2}{1+x} \right)^{3/4} (1+y^2) \log \left( \frac{\sqrt{-1 + \frac{2}{1+x}}(1+y)}{-1+y} \right)} dy dx$$

$$= \frac{1}{24} \pi^2 (36 + i\pi - 36 \log(2))$$

EXAMPLE 5.316.

$$(5.316) \quad \int_{-1}^1 \int_{-1}^1 \frac{\sqrt{\frac{1+y}{1-y}}}{\left( -1 + \frac{2}{1+x} \right)^{3/4} (1+y^2) \log^2 \left( \frac{\sqrt{-1 + \frac{2}{1+x}}(1+y)}{-1+y} \right)} dy dx = -\frac{\pi^3 - 6i\zeta(3)}{16\pi}$$

EXAMPLE 5.317.

$$(5.317) \quad \int_{-1}^1 \int_{-1}^1 -\frac{k \sqrt{\frac{1+y}{1-y}} \log^{-1+k} \left( \frac{\sqrt{-1 + \frac{2}{1+x}}(1+y)}{-1+y} \right)}{\left( -1 + \frac{2}{1+x} \right)^{3/4} (1+y^2)} dy dx$$

$$= e^{\frac{ik\pi}{2}} \pi \Gamma(1+k) \left( (-2 + 2^k) \sin \left( \frac{k\pi}{2} \right) \zeta(-1+k) - 3i(-1 + 2^k) \cos \left( \frac{k\pi}{2} \right) \zeta(k) \right)$$

EXAMPLE 5.318.

$$(5.318) \quad \int_{-1}^1 \int_{-1}^1 \frac{\sqrt{\frac{1+y}{1-y}}}{\left( -1 + \frac{2}{1+x} \right)^{3/4} (1+y^2) \sqrt{\log \left( \frac{\sqrt{-1 + \frac{2}{1+x}}(1+y)}{-1+y} \right)}} dy dx$$

$$= \left( \frac{1}{2} + \frac{i}{2} \right) \pi^{3/2} \left( -(-2 + \sqrt{2}) \zeta \left( -\frac{1}{2} \right) + 3i(-1 + \sqrt{2}) \zeta \left( \frac{1}{2} \right) \right)$$

EXAMPLE 5.319.

$$(5.319) \quad \int_{-1}^1 \int_{-1}^1 \frac{\left( \frac{1+y}{1-y} \right)^{3/4}}{\left( -1 + \frac{2}{1+x} \right)^{5/8} (1+y^2) \log^2 \left( \frac{\sqrt{-1 + \frac{2}{1+x}}(1+y)}{-1+y} \right)} dy dx$$

$$= \frac{\sqrt[4]{-1} (-240C\pi + 11i\pi^3 + 18\zeta(3))}{384\pi}$$

5.1.17. Derived from equation (4.60).

EXAMPLE 5.320.

$$(5.320) \quad \int_0^\infty \frac{(e^{mx} + (-1)^{1+k} e^{(-m+p)x}) x^k}{-1 + e^{px}} dx = \frac{i\pi \left( 2^{1+k} \left( \frac{i}{p} \right)^k \pi^k \text{Li}_{-k} \left( e^{\frac{2im\pi}{p}} \right) \right)}{p}$$



EXAMPLE 5.321.

$$(5.321) \quad \int_0^{\infty} \frac{x^2 \coth(x) \operatorname{csch}(x)}{\pi^2 + x^2} dx = \frac{1}{12} (-6 + \pi^2)$$

EXAMPLE 5.322.

$$(5.322) \quad \int_0^{\infty} \frac{x \operatorname{csch}(x)}{\pi^2 + 4x^2} dx = \frac{1}{8} (-2 + \pi)$$

EXAMPLE 5.323.

$$(5.323) \quad \int_0^{\infty} \frac{x^2 \coth(x) \operatorname{csch}(x)}{\pi^2 + 4x^2} dx = \frac{1}{4} (-1 + 2C)$$

EXAMPLE 5.324.

$$(5.324) \quad \int_0^{\infty} \tanh^{-1}\left(\frac{x}{a}\right) \operatorname{csch}(mx) dx = -\frac{i\pi \log\left(-\frac{iam\Gamma\left(-\frac{iam}{2\pi}\right)^2}{2\pi\Gamma\left(\frac{-iam+\pi}{2\pi}\right)^2}\right)}{2m}$$

EXAMPLE 5.325.

$$(5.325) \quad \int_0^{\infty} x^k \operatorname{csch}(mx) dx = (-1 + 2^{1+k}) \left(\frac{i}{m}\right)^{2+k} m\pi^{1+k} \left(-i + \cot\left(\frac{k\pi}{2}\right)\right) \zeta(-k)$$

EXAMPLE 5.326.

$$(5.326) \quad \int_0^{\infty} \frac{x^2 \coth(x) \operatorname{csch}(x)}{a^2 + x^2} dx = \frac{\pi}{2a} + \frac{a(\psi^{(1)}\left(1 + \frac{a}{2\pi}\right) - \psi^{(1)}\left(\frac{a+\pi}{2\pi}\right))}{4\pi}$$

EXAMPLE 5.327.

$$(5.327) \quad \int_0^{\infty} \left(-\left(\frac{i\pi}{m} - x\right)^k + \left(\frac{i\pi}{m} + x\right)^k\right) \operatorname{csch}(mx) dx \\ = \frac{\left(\frac{i}{m}\right)^{-1+k} \pi^{1+k} (1 + (-2 + 2^{2+k}) \zeta(-k))}{m^2}$$

EXAMPLE 5.328.

$$(5.328) \quad \int_0^{\infty} \frac{x \operatorname{csch}(mx)}{\pi^2 + m^2 x^2} dx = \frac{-1 + \log(4)}{2m^2}$$

EXAMPLE 5.329.

$$(5.329) \quad \int_0^{\infty} \frac{x \operatorname{csch}(mx)}{(\pi^2 + m^2 x^2)^2} dx = \frac{-6 + \pi^2}{24m^2 \pi^2}$$

EXAMPLE 5.330.

$$(5.330) \quad \int_0^{\infty} \frac{-2i\pi x \operatorname{csch}(x) + \pi^2 \operatorname{sech}(x) - x^2 \operatorname{sech}(x)}{(\pi^2 + x^2)^2} dx = \frac{(48 + 6i) - 48C - i\pi^2}{12\pi}$$

EXAMPLE 5.331.

$$(5.331) \quad \int_0^\infty \frac{(\pi-x)(\pi+x)\operatorname{sech}(x)}{(\pi^2+x^2)^2} dx = \frac{4-4C}{\pi}$$

EXAMPLE 5.332.

$$(5.332) \quad \int_0^\infty \operatorname{csch}(mx) \left( \frac{\log(-x+\log(a))}{x-\log(a)} + \frac{\log(x+\log(a))}{x+\log(a)} \right) dx \\ = \left( -H_{-\frac{im\log(a)}{2\pi}} + H_{-\frac{\pi+im\log(a)}{2\pi}} \right) \log\left(\frac{2i\pi}{m}\right) + \frac{i\pi \log(\log(a))}{m \log(a)} \\ - \gamma_1 \left( \frac{\pi-im\log(a)}{2\pi} \right) + \gamma_1 \left( 1 - \frac{im\log(a)}{2\pi} \right)$$

EXAMPLE 5.333.

$$(5.333) \quad \int_0^\infty \left( \frac{i\pi x \operatorname{csch}(x)}{\pi^2+x^2} - \frac{2\pi \tan^{-1}\left(\frac{x}{\pi}\right) \operatorname{csch}(x)}{\pi^2+x^2} + \frac{x \operatorname{csch}(x) \log(\pi^2+x^2)}{\pi^2+x^2} \right) dx \\ = \log(i\pi) - H_{\frac{1}{2}} \log(2i\pi) - \gamma_1 + \gamma_1 \left( \frac{3}{2} \right)$$

EXAMPLE 5.334.

$$(5.334) \quad \int_0^\infty \frac{x \operatorname{csch}(x)}{\pi^2+x^2} dx = -\frac{1}{2} + \log(2)$$

EXAMPLE 5.335.

$$(5.335) \quad \int_0^\infty \frac{\operatorname{csch}(x) \left( -2\pi \tan^{-1}\left(\frac{x}{\pi}\right) + x \log(\pi^2+x^2) \right)}{\pi^2+x^2} dx \\ = \log(\pi) + (-2 + \log(4)) \log(2\pi) - \gamma_1 + \gamma_1 \left( \frac{3}{2} \right)$$

EXAMPLE 5.336.

$$(5.336) \quad \int_0^\infty \frac{-e^{3mx} \log(-x+\log(a)) + e^{mx} \log(x+\log(a))}{-1+e^{4mx}} dx \\ = \frac{\pi}{4m} \left( (-1-i) \log\left(\frac{i}{m}\right) + (1+i)(\log(2) - \log(\pi)) + i \log(\log(a)) \right) \\ + 2 \left( \log \left( \frac{\Gamma\left(\frac{1}{4}\left(1 - \frac{2im\log(a)}{\pi}\right)\right)}{2\Gamma\left(\frac{1}{4}\left(3 - \frac{2im\log(a)}{\pi}\right)\right)} \right) + i \log \left( \frac{\Gamma\left(\frac{1}{4}\left(2 - \frac{2im\log(a)}{\pi}\right)\right)}{2\Gamma\left(\frac{1}{4}\left(4 - \frac{2im\log(a)}{\pi}\right)\right)} \right) \right)$$

where  $\operatorname{Re}(a) < 0$ 

EXAMPLE 5.337.

$$(5.337) \quad \int_0^\infty \frac{-e^{(-m+p)x} (2a\pi-x)^k + e^{mx} (2a\pi+x)^k}{-1+e^{px}} dx \\ = \frac{i\pi \left( a^k (2\pi)^k + 2^{1+k} e^{\frac{2im\pi}{p}} \left(\frac{i}{p}\right)^k \pi^k \Phi\left(e^{\frac{2im\pi}{p}}, -k, 1-iap\right) \right)}{p}$$

EXAMPLE 5.338.

$$\begin{aligned}
(5.338) \quad & \int_0^\infty \frac{-e^{x/4}(2i\pi - x) \log(2i\pi - x) + e^{x/4}(2i\pi + x) \log(2i\pi + x)}{-1 + e^{x/2}} dx \\
& = 2i\pi (-\pi^2 - 4i\pi \log(2)) \\
& \quad - 4i\pi \left( \frac{i\pi}{2} + \log(2) \right) - 4i\pi \log(\pi) + 2i\pi \log(2\pi) + 8i\pi \Phi' \left( -1, -1, \frac{3}{2} \right)
\end{aligned}$$

EXAMPLE 5.339.

$$\begin{aligned}
(5.339) \quad & \int_0^\infty \frac{e^{x/2}((-i\pi + x) \log(i\pi - x) + (i\pi + x) \log(i\pi + x))}{-1 + e^x} dx \\
& = \frac{1}{2}\pi^2 \left( i\pi + \log(16\pi^2) - 8\Phi' \left( -1, -1, \frac{3}{2} \right) \right)
\end{aligned}$$

EXAMPLE 5.340.

$$(5.340) \quad \int_0^\infty \frac{x(-1 + x \coth(x)) \operatorname{csch}(x)}{(\pi^2 + x^2)^3} dx = \frac{7}{960} - \frac{\pi^2 + 18\zeta(3)}{48\pi^4}$$

EXAMPLE 5.341.

$$(5.341) \quad \int_0^\infty \frac{x(-1 + x \coth(x)) \operatorname{csch}(x)}{(\pi^2 + 4x^2)^3} dx = -\frac{512C + 32\pi^3 - \psi^{(3)}\left(\frac{1}{4}\right) + \psi^{(3)}\left(\frac{3}{4}\right)}{4096\pi^4}$$

EXAMPLE 5.342.

$$\begin{aligned}
(5.342) \quad & \int_0^\infty \frac{x \operatorname{csch}(mx)}{(a^2 + x^2)^3} dx \\
& = \frac{3\pi}{16a^5m} + \frac{m \left( 2\pi\psi^{(1)}\left(1 + \frac{am}{2\pi}\right) - 2\pi\psi^{(1)}\left(\frac{am+\pi}{2\pi}\right) + am \left( -\psi^{(2)}\left(1 + \frac{am}{2\pi}\right) + \psi^{(2)}\left(\frac{am+\pi}{2\pi}\right) \right) \right)}{64a^3\pi^2}
\end{aligned}$$

EXAMPLE 5.343.

$$(5.343) \quad \int_0^\infty x \tan^{-1}\left(\frac{2x}{\pi}\right) \coth\left(\frac{2x}{3}\right) \operatorname{csch}\left(\frac{2x}{3}\right) dx = \frac{1}{8}(-3)\pi \log\left(\frac{3456e^{3-\frac{2\pi}{\sqrt{3}}}\Gamma\left(-\frac{1}{3}\right)^6}{15625\Gamma\left(-\frac{5}{6}\right)^6}\right)$$

EXAMPLE 5.344.

$$(5.344) \quad \int_0^\infty \frac{x^2 \operatorname{csch}^3\left(\frac{x}{2}\right) \sinh(x)}{\pi^2 + x^2} dx = -4 + 8C$$

EXAMPLE 5.345.

$$(5.345) \quad \int_0^\infty \frac{x^2 \operatorname{csch}^3\left(\frac{x}{2}\right) \sinh(x)}{\pi^2 + 4x^2} dx = \frac{1}{16} \left( -32 + \psi^{(1)}\left(\frac{1}{8}\right) - \psi^{(1)}\left(\frac{5}{8}\right) \right)$$

5.1.18. *Formulae derived from equation (4.66).*

EXAMPLE 5.346.

$$(5.346) \quad \int_0^1 \int_0^\infty \frac{x^n (-1 + \sqrt{-1 + x^{-1-n}y})}{\sqrt[4]{-1 + x^{-1-n}} \sqrt{y} (1 + y^2) \log((-1 + x^{-1-n})y^2)} dy dx = \frac{C}{1+n}$$

EXAMPLE 5.347.

$$(5.347) \quad \int_0^1 \int_0^\infty \frac{x^n \sqrt[4]{-1 + x^{-1-n}} \sqrt{y}}{(1 + y^2) \log((1 - x^{-1-n})y^2)} dy dx \\ = \frac{2i\pi (\psi^{(0)}(\frac{3}{8}) - \psi^{(0)}(\frac{7}{8})) + \psi^{(1)}(\frac{3}{8}) - \psi^{(1)}(\frac{7}{8})}{32(1+n)}$$

EXAMPLE 5.348.

$$(5.348) \quad \int_0^1 \int_0^\infty \frac{x^n \sqrt[4]{-1 + x^{-1-n}} \sqrt{y} \log(\log(a(-1 + x^{-1-n})y^2))}{1 + y^2} dy dx \\ = \frac{\pi}{8(1+n)} (\pi(i\pi + \log(64) + 2 \log(\pi) - 4 \log(-6\pi - i \log(a)) + 4 \log(-2\pi - i \log(a))) \\ - 4\pi \log \Gamma\left(-\frac{3}{4} - \frac{i \log(a)}{8\pi}\right) + 4\pi \log \Gamma\left(-\frac{1}{4} - \frac{i \log(a)}{8\pi}\right) + 2i\psi^{(0)}\left(\frac{1}{4} - \frac{i \log(a)}{8\pi}\right) \\ - 2i\psi^{(0)}\left(\frac{3}{4} - \frac{i \log(a)}{8\pi}\right))$$

EXAMPLE 5.349.

$$(5.349) \quad \int_0^1 \int_0^\infty \frac{\sqrt[4]{-1 + \frac{1}{x^2}} x \sqrt{y} \log(\log((1 - \frac{1}{x^2})y^2))}{1 + y^2} dy dx \\ = \frac{1}{16}\pi \left( \pi \left( i\pi + \log\left(\frac{64\pi^2 \Gamma(-\frac{1}{8})^4}{625 \Gamma(-\frac{5}{8})^4}\right) \right) + 2i \left( \psi^{(0)}\left(\frac{3}{8}\right) - \psi^{(0)}\left(\frac{7}{8}\right) \right) \right)$$

EXAMPLE 5.350.

$$(5.350) \quad \int_0^1 \int_0^\infty \frac{\sqrt[4]{-1 + \frac{1}{x^2}} x \sqrt{y} \log((-1 + \frac{1}{x^2})y^2) \log(\log((-1 + \frac{1}{x^2})y^2))}{1 + y^2} dy dx \\ = \frac{1}{4}\pi^2 \left( 2 - 4iC + \log \left( \exp(\pi i) \left(\frac{8\pi}{9}\right)^2 \left(\frac{\Gamma(-\frac{1}{4})}{\Gamma(-\frac{3}{4})}\right)^4 \right) \right)$$

EXAMPLE 5.351.

$$(5.351) \quad \int_0^1 \int_0^\infty \frac{\sqrt[4]{-1 + \frac{1}{x}} \sqrt{y}}{(1 + y^2) \log\left(\frac{(-1+x)y^2}{x}\right)} dy dx$$

$$= \frac{1}{32} \left( -2i\sqrt{2}\pi \left( \pi + 2 \log \left( \tan \left( \frac{\pi}{8} \right) \right) \right) + \psi^{(1)} \left( \frac{3}{8} \right) - \psi^{(1)} \left( \frac{7}{8} \right) \right)$$

EXAMPLE 5.352.

$$(5.352) \quad \int_0^1 \int_0^\infty \frac{\sqrt[4]{-1 + \frac{1}{x}\sqrt{y}}}{(1+y^2)\sqrt{\log\left(\frac{(-1+x)y^2}{x}\right)}} dy dx$$

$$= \left( \frac{1}{32} + \frac{i}{32} \right) \sqrt{\pi} \left( -4i\pi \left( \zeta \left( \frac{1}{2}, \frac{3}{8} \right) - \zeta \left( \frac{1}{2}, \frac{7}{8} \right) \right) + \zeta \left( \frac{3}{2}, \frac{3}{8} \right) - \zeta \left( \frac{3}{2}, \frac{7}{8} \right) \right)$$

EXAMPLE 5.353.

$$(5.353) \quad \int_0^1 \int_0^\infty \frac{\sqrt[4]{-1 + \frac{1}{x}\sqrt{y}} \log^i \left( \frac{(-1+x)y^2}{x} \right)}{1+y^2} dy dx$$

$$= i^i 2^{-2+3i} \pi^{1+i} \left( 2\pi \left( \zeta \left( -i, \frac{3}{8} \right) - \zeta \left( -i, \frac{7}{8} \right) \right) + \zeta \left( 1-i, \frac{3}{8} \right) - \zeta \left( 1-i, \frac{7}{8} \right) \right)$$

EXAMPLE 5.354.

$$(5.354) \quad \int_0^1 \int_0^\infty \frac{\sqrt[4]{-1 + \frac{1}{x}\sqrt{y}} (\log(-1 + \frac{1}{x}) + 2 \log(y))}{(1+y^2) \log(i(-1 + \frac{1}{x})y^2)} dy dx$$

$$= \frac{1}{64} \pi \left( -i \left( \psi^{(1)} \left( \frac{5}{16} \right) - \psi^{(1)} \left( \frac{13}{16} \right) \right) + 4\pi \left( 4 + 2 \cos \left( \frac{\pi}{8} \right) \log \left( \tan \left( \frac{3\pi}{16} \right) \right) \right. \right.$$

$$\left. \left. - \left( \sqrt{2}\pi + 2 \log \left( \tan \left( \frac{\pi}{16} \right) \right) \right) \sin \left( \frac{\pi}{8} \right) \right) \right)$$

EXAMPLE 5.355.

$$(5.355) \quad \int_0^1 \int_0^\infty \frac{\left( 1 - \sqrt{-1 + \frac{1}{x}y} \right) \log^2 \left( (-1 + \frac{1}{x})y^2 \right) \log \left( \log \left( (-1 + \frac{1}{x})y^2 \right) \right)}{\sqrt[4]{-1 + \frac{1}{x}\sqrt{y}} (1+y^2)} dy dx = 32iC\pi^2$$

EXAMPLE 5.356.

$$(5.356) \quad \int_0^1 \int_0^\infty \frac{i \log^3 \left( (-1 + \frac{1}{x})y^2 \right) \log \left( \log \left( (-1 + \frac{1}{x})y^2 \right) \right)}{18\pi^2 (1+y^2)} dy dx = \zeta(3)$$

EXAMPLE 5.357.

$$(5.357) \quad \int_0^1 \int_0^\infty \frac{15 \log^4 \left( (-1 + \frac{1}{x})y^2 \right) \log \left( \log \left( (-1 + \frac{1}{x})y^2 \right) \right)}{2\pi^5 (1+y^2)} dy dx$$

$$= 7 + 14i\pi + 60 \log(2) + 28 \log(\pi) - 3360\zeta'(-3)$$

5.1.19. *Formulae derived using equation (4.67).*

EXAMPLE 5.358.

$$(5.358) \quad \int_{\mathbb{R}_+^4} \frac{\sqrt[4]{r+s} e^{-3r-2s-3x-2y} \left( \pi^2 - 4 \log^2 \left( \frac{\sqrt{r+s}\sqrt{xy}}{\sqrt{rs}\sqrt{x+y}} \right) \right)}{(rs)^{3/4} \sqrt[4]{xy} \sqrt[4]{x+y} \left( 4 \log^2 \left( \frac{\sqrt{r+s}\sqrt{xy}}{\sqrt{rs}\sqrt{x+y}} \right) + \pi^2 \right)^2} dx dy dr ds = \frac{48C + \pi^2}{576\sqrt{2}}$$

and

$$(5.359) \quad \int_{\mathbb{R}_+^4} \frac{\sqrt[4]{rs} \sqrt[4]{r+s} (xy)^{3/4} e^{-3r-2s-3x-2y} \log \left( \frac{\sqrt{r+s}\sqrt{xy}}{\sqrt{rs}\sqrt{x+y}} \right)}{rsxy \sqrt[4]{x+y} \left( 4 \log^2 \left( \frac{\sqrt{r+s}\sqrt{xy}}{\sqrt{rs}\sqrt{x+y}} \right) + \pi^2 \right)^2} dx dy dr ds \\ = \frac{1}{16\pi} \left( \frac{C}{3\sqrt{2}} - \frac{\pi^2}{144\sqrt{2}} \right)$$

EXAMPLE 5.359.

$$(5.360) \quad \int_{\mathbb{R}_+^4} \frac{\sqrt{rs}\sqrt{xy} e^{-3r-2s-3x-2y}}{rsxy \left( \log^2 \left( \frac{\sqrt{r+s}\sqrt{xy}}{\sqrt{rs}\sqrt{x+y}} \right) + \pi^2 \right)} dx dy dr ds = \frac{4-\pi}{6}$$

and

$$(5.361) \quad \int_{\mathbb{R}_+^4} \frac{\sqrt{rs}\sqrt{xy} e^{-3r-2s-3x-2y} \log \left( \frac{\sqrt{r+s}\sqrt{xy}}{\sqrt{rs}\sqrt{x+y}} \right)}{rsxy \left( \log^2 \left( \frac{\sqrt{r+s}\sqrt{xy}}{\sqrt{rs}\sqrt{x+y}} \right) + \pi^2 \right)} dx dy dr ds = 0$$

EXAMPLE 5.360.

$$(5.362) \quad \int_{\mathbb{R}_+^4} \frac{e^{-2r-3s-2x-3y} \left( (r+s)^{3/8} \sqrt[4]{xy} - \sqrt[4]{rs} \sqrt[8]{r+s} \sqrt[4]{x+y} \right)}{(rs)^{7/8} (xy)^{3/8} (x+y)^{3/8} \log \left( \frac{\sqrt{r+s}\sqrt{xy}}{\sqrt{rs}\sqrt{x+y}} \right)} dx dy dr ds \\ = \frac{2}{3} \pi \tanh^{-1} \left( \cos \left( \frac{\pi}{8} \right) - \sin \left( \frac{\pi}{8} \right) \right)$$

EXAMPLE 5.361.

$$(5.363) \quad \int_{\mathbb{R}_+^4} \frac{e^{-r-s-x-y} \left( \sqrt[6]{r+s} \sqrt[24]{xy} - \sqrt[24]{rs} \sqrt[8]{r+s} \sqrt[24]{x+y} \right)}{(rs)^{2/3} (xy)^{3/8} \sqrt[6]{x+y} \log \left( \frac{\sqrt{r+s}\sqrt{xy}}{\sqrt{rs}\sqrt{x+y}} \right)} dx dy dr ds \\ = 2\pi \log \left( \sqrt{3} \tan \left( \frac{3\pi}{16} \right) \right)$$

EXAMPLE 5.362.

$$(5.364) \quad \int_{\mathbb{R}_+^4} \frac{e^{-r-2(s+y)-x}}{\sqrt{rs}\sqrt{xy} \left( \log \left( \frac{\sqrt{r+s}\sqrt{xy}}{\sqrt{rs}\sqrt{x+y}} \right) + i\pi \right)^2} dx dy dr ds = 4(C-1)$$

EXAMPLE 5.363.

$$(5.365) \quad \int_{\mathbb{R}_+^4} \frac{e^{-r-2(s+y)-x}}{\sqrt{rs}\sqrt{xy} \left( \log \left( \frac{\sqrt{r+s}\sqrt{xy}}{\sqrt{rs}\sqrt{x+y}} \right) + i\pi \right)^3} dx dy dr ds = -\frac{i(\pi^3 - 32)}{4\pi}$$

PROPOSITION 5.364. For all  $a, k, p, q \in \mathbb{C}$  then,

$$(5.366) \quad \int_{\mathbb{R}_+^4} \frac{e^{-p(r+x)-q(s+y)} \log^k \left( \frac{a\sqrt{r+s}\sqrt{xy}}{\sqrt{rs}\sqrt{x+y}} \right)}{\sqrt{rs}\sqrt{xy}} dx dy dr ds$$

$$= \frac{2ie^{\frac{1}{2}i\pi(k-1)} \pi^{k+2} \left( 2^k \zeta \left( -k, \frac{1}{2} \left( \frac{1}{2} - \frac{i \log(a)}{\pi} \right) \right) - 2^k \zeta \left( -k, \frac{1}{2} \left( \frac{3}{2} - \frac{i \log(a)}{\pi} \right) \right) \right)}{pq}$$

PROPOSITION 5.365. For all  $k \in \mathbb{C}$  then,

$$(5.367) \quad \int_{\mathbb{R}_+^4} \frac{e^{-r-s-x-y} \log^k \left( \frac{i\sqrt{r+s}\sqrt{xy}}{\sqrt{rs}\sqrt{x+y}} \right)}{\sqrt{rs}\sqrt{xy}} dx dy dr ds = -2(2^{k+1} - 1) e^{\frac{i\pi k}{2}} \pi^{k+2} \zeta(-k)$$

EXAMPLE 5.366.

$$(5.368) \quad \int_{\mathbb{R}_+^4} \frac{e^{-r-s-x-y} \sqrt{\log \left( \frac{i\sqrt{r+s}\sqrt{xy}}{\sqrt{rs}\sqrt{x+y}} \right)}}{\sqrt{rs}\sqrt{xy}} dx dy dr ds$$

$$= -2(2\sqrt{2} - 1) e^{\frac{i\pi}{4}} \pi^{5/2} \zeta \left( -\frac{1}{2} \right)$$

EXAMPLE 5.367.

$$(5.369) \quad \int_{\mathbb{R}_+^4} \frac{e^{-3(r+x)-4(s+y)}}{\sqrt{rs}\sqrt{xy} \log \left( \frac{i\sqrt{r+s}\sqrt{xy}}{\sqrt{rs}\sqrt{x+y}} \right)} dx dy dr ds = -\frac{1}{6} i\pi \log(2)$$

EXAMPLE 5.368.

$$(5.370) \quad \int_{\mathbb{R}_+^4} \frac{e^{-r-s-x-y} \log \left( \log \left( \frac{i\sqrt{r+s}\sqrt{xy}}{\sqrt{rs}\sqrt{x+y}} \right) \right)}{\sqrt{rs}\sqrt{xy}} dx dy dr ds = \frac{1}{2} \pi^2 (\log(4) + i\pi)$$

EXAMPLE 5.369.

$$(5.371) \quad \int_{\mathbb{R}_+^4} \frac{e^{-r-s-x-y} \log \left( \log \left( \frac{i\sqrt{r+s}\sqrt{xy}}{\sqrt{rs}\sqrt{x+y}} \right) \right)}{\sqrt{rs}\sqrt{xy} \log \left( \frac{i\sqrt{r+s}\sqrt{xy}}{\sqrt{rs}\sqrt{x+y}} \right)} dx dy dr ds = \pi \log(2) (2i\gamma + \pi - i(\log(2) + 2\log(\pi)))$$

EXAMPLE 5.370.

$$(5.372) \quad \int_{\mathbb{R}_+^4} \frac{e^{-r-s-x-y} \log \left( \log \left( \frac{i\sqrt{r+s}\sqrt{xy}}{\sqrt{rs}\sqrt{x+y}} \right) \right)}{\sqrt{rs}\sqrt{xy} \log^2 \left( \frac{i\sqrt{r+s}\sqrt{xy}}{\sqrt{rs}\sqrt{x+y}} \right)} dx dy dr ds = \frac{1}{12} \pi^2 (-24 \log(A) + 2\gamma - i\pi + \log(16))$$

PROPOSITION 5.371. For all  $a, p, q \in \mathbb{C}, \operatorname{Re}(a) > 0$  then,

$$(5.373) \quad \int_{\mathbb{R}_+^4} \frac{\log \left( \log \left( \frac{a\sqrt{r+s}\sqrt{xy}}{\sqrt{rs}\sqrt{x+y}} \right) \right) e^{-p(r+x)-q(s+y)}}{\sqrt{rs}\sqrt{xy}} dx dy dr ds$$

$$= \frac{\pi^2 \left( 4 \log \left( \frac{\sqrt{2\pi}\Gamma\left(\frac{3}{4} - \frac{i \log(a)}{2\pi}\right)}{\Gamma\left(\frac{\pi - 2i \log(a)}{4\pi}\right)} \right) + i\pi \right)}{2pq}$$

5.1.20. *Formulae derived using equation (4.68).*

EXAMPLE 5.372. The Polylogarithm Function  $Li_k(z)$ ,

$$(5.374) \quad \int_{\mathbb{R}_+^4} y^m x^{u-1} D_u(t) e^{-\frac{t^2}{4} - 2(y+z^2)} (qx^v + 1)^{-m-1} t^{-m + \frac{u}{v} - 1} z^{u(\frac{1}{v}-1) - m}$$

$$\log^k \left( -\frac{y}{tz(qx^v + 1)} \right) dx dy dz dt$$

$$= \frac{1}{v} i^{k+1} \pi^{k + \frac{3}{2}} e^{-i\pi(m - \frac{u}{v})} \left( \frac{1}{q} \right)^{u/v} \Gamma \left( \frac{u}{v} \right) 2^{\frac{1}{2}(2k+m - \frac{u}{v} + u) - \frac{(m+3)v+u(-v)+u}{2v}} Li_{-k} \left( e^{2i\pi(m - \frac{u}{v})} \right)$$

EXAMPLE 5.373. Catalan's Constant  $K$ ,

$$(5.375) \quad \int_{\mathbb{R}_+^4} \frac{D_1(t) e^{-\frac{t^2}{4} - 2(y+z^2)}}{\sqrt[4]{t}\sqrt{x^4+1}\sqrt{y}\sqrt[4]{z} \log^2 \left( -\frac{y}{t(x^4+1)z} \right)} dx dy dz dt = -\frac{ie^{\frac{3i\pi}{4}} \left( -\frac{\pi^2}{48} + iK \right) \Gamma \left( \frac{1}{4} \right)}{16 \cdot 2^{3/4} \sqrt{\pi}}$$

EXAMPLE 5.374. The Hurwitz zeta function  $\zeta(s, v)$ ,

$$(5.376) \quad \int_{\mathbb{R}_+^4} \frac{D_{\frac{1}{2}}(t\alpha) e^{-b(y+z^2) - \frac{1}{4}\alpha^2 t^2} \log^k \left( \frac{ay}{tz(p+qx^3)} \right)}{\sqrt{t}\sqrt{x}\sqrt[3]{y} (p+qx^3)^{2/3}} dx dy dz dt$$

$$= -\frac{1}{3\sqrt{\alpha} b^{7/6} p^{2/3}} i i^{k+1} 2^k \pi^{k + \frac{3}{2}} \Gamma \left( \frac{1}{6} \right) \sqrt[6]{\frac{p}{q}}$$

$$\left( 2^k \zeta \left( -k, -\frac{i(2 \log(a) - \log(b) - 2 \log(p) + 2 \log(\alpha) + \log(2) + 2i\pi)}{8\pi} \right) \right.$$

$$\left. - 2^k \zeta \left( -k, \frac{1}{2} \left( 1 - \frac{i(2 \log(a) - \log(b) - 2 \log(p) + 2 \log(\alpha) + \log(2) + 2i\pi)}{4\pi} \right) \right) \right)$$

EXAMPLE 5.375. The Riemann zeta function  $\zeta(s)$ ,

$$(5.377) \quad \int_{\mathbb{R}_+^4} \frac{D_{\frac{1}{2}}(t) e^{-\frac{t^2}{4} - 2(y+z^2)} \log^k \left( -\frac{y}{tz(qx^3+1)} \right)}{\sqrt{t}\sqrt{x}\sqrt[3]{y} (qx^3+1)^{2/3}} dx dy dz dt$$

$$= -\frac{1}{3} i i^{k+1} 2^{k - \frac{7}{6}} \pi^{k + \frac{3}{2}} \sqrt[6]{\frac{1}{q}} \Gamma \left( \frac{1}{6} \right) (2^k (2^{-k} - 1) \zeta(-k) - 2^k \zeta(-k))$$



EXAMPLE 5.376. Euler's constant  $\gamma$

$$(5.378) \quad \int_{\mathbb{R}_+^4} \frac{D_{\frac{1}{2}}(t) e^{-\frac{t^2}{4} - 2(y+z^2)} \log\left(\log\left(-\frac{y}{tx^3z+tz}\right)\right)}{\sqrt{t}\sqrt{x}(x^3+1)^{2/3} \sqrt[3]{y} \log\left(-\frac{y}{tx^3z+tz}\right)} dx dy dz dt$$

$$= \frac{\sqrt{\pi} \log(2) (2i\gamma + \pi - i \log(8\pi^2)) \Gamma\left(\frac{1}{6}\right)}{24 \sqrt[6]{2}}$$

EXAMPLE 5.377. Glaisher's constant  $A$

$$(5.379) \quad \int_{\mathbb{R}_+^4} \frac{D_{\frac{1}{2}}(t) e^{-\frac{t^2}{4} - 2(y+z^2)} \log\left(\log\left(-\frac{y}{tx^3z+tz}\right)\right)}{\sqrt{t}\sqrt{x}(x^3+1)^{2/3} \sqrt[3]{y} \log^2\left(-\frac{y}{tx^3z+tz}\right)} dx dy dz dt$$

$$= \frac{\pi^{3/2} \Gamma\left(\frac{1}{6}\right) (-24 \log(A) + 2\gamma - i\pi + \log(4))}{576 \sqrt[6]{2}}$$

EXAMPLE 5.378. The Constant  $\log(2)$ ,

$$(5.380) \quad \int_{\mathbb{R}_+^4} \frac{D_{\frac{1}{2}}(t) e^{\frac{1}{4}(-t^2 - 8(y+z^2))}}{\sqrt{t}\sqrt{x}(x^3+1)^{2/3} \sqrt[3]{y} \log\left(-\frac{y}{tx^3z+tz}\right)} dx dy dz dt = -\frac{i\sqrt{\pi} \log(2) \Gamma\left(\frac{1}{6}\right)}{12 \sqrt[6]{2}}$$

EXAMPLE 5.379. The Inverse Hyperbolic Tangent  $\tanh^{-1}(z)$ ,

$$(5.381) \quad \int_{\mathbb{R}_+^4} \frac{y^m x^{u-1} t^{-m+\frac{u}{v}-1} z^{u(\frac{1}{v}-1)-m} D_u(t\alpha) (p+qx^v)^{-m-1} e^{-\frac{1}{4}\alpha^2\left(\frac{8(y+z^2)}{p^2}+t^2\right)}}{\log\left(-\frac{y}{ptz+qtzx^v}\right)} dx dy dz dt$$

$$= \frac{\sqrt{\pi} p^{-m-1} 2^{-\frac{u}{v}+u-\frac{3}{2}} \Gamma\left(\frac{u}{v}\right) \alpha^{m-\frac{u}{v}} \tanh^{-1}\left(e^{i\pi\left(m-\frac{u}{v}\right)}\right) \left(\frac{p}{q}\right)^{u/v} \left(\frac{\alpha^2}{p^2}\right)^{-\frac{(m+3)v+u(-v)+u}{2v}}}{v}$$

EXAMPLE 5.380.

$$(5.382) \quad \int_{\mathbb{R}_+^4} \frac{\alpha t^{3/4} e^{-b(y+z^2) - \frac{1}{2}\alpha^2 t^2} \log\left(\log\left(\frac{ay}{ptz+qtz^4}\right)\right)}{\sqrt{y}\sqrt[4]{z}\sqrt{p+qx^4}} dx dy dz dt$$

$$= \frac{\pi^{3/2} \Gamma\left(\frac{1}{4}\right) \sqrt[4]{\frac{p}{q}}}{8 \cdot 2^{3/8} \alpha^{3/4} b^{7/8} \sqrt{p}} \left( (-2+2i) \log\left(\frac{\Gamma\left(\frac{-2i \log(a)+i \log\left(\frac{b}{2}\right)+2i \log(p)-2i \log(\alpha)+2\pi}{16\pi}\right)}{\Gamma\left(\frac{-2i \log(a)+i \log\left(\frac{b}{2}\right)+2i \log(p)-2i \log(\alpha)+10\pi}{16\pi}\right)}\right) \right.$$

$$\left. - (2+2i) \log\left(\frac{\Gamma\left(\frac{-2i \log(a)+i \log\left(\frac{b}{2}\right)+2i \log(p)-2i \log(\alpha)+6\pi}{16\pi}\right)}{\Gamma\left(\frac{-2i \log(a)+i \log\left(\frac{b}{2}\right)+2i \log(p)-2i \log(\alpha)+14\pi}{16\pi}\right)}\right) + i\pi + 2 \log(\pi) + \log(64) \right)$$

EXAMPLE 5.381.

$$\begin{aligned}
(5.383) \quad & \int_{\mathbb{R}_+^4} \frac{\sqrt{x} D_{\frac{3}{2}}(t\alpha) e^{-b(y+z^2) - \frac{1}{4}\alpha^2 t^2} \log\left(\log\left(\frac{ay}{ptz+qt x^3 z}\right)\right)}{\sqrt[4]{t} \sqrt[4]{y} z^{3/4} (p+qx^3)^{3/4}} dx dy dz dt \\
&= \frac{\pi^2 \sqrt{\frac{p}{q}}}{6 \sqrt[8]{2} \alpha^{3/4} b^{7/8} p^{3/4}} \left( (-2+2i) \log\left(\frac{\Gamma\left(\frac{-2i \log(a)+i \log(\frac{b}{2})+2i \log(p)-2i \log(\alpha)+2\pi}{16\pi}\right)}{\Gamma\left(\frac{-2i \log(a)+i \log(\frac{b}{2})+2i \log(p)-2i \log(\alpha)+10\pi}{16\pi}\right)}\right) \right. \\
&\quad \left. - (2+2i) \log\left(\frac{\Gamma\left(\frac{-2i \log(a)+i \log(\frac{b}{2})+2i \log(p)-2i \log(\alpha)+6\pi}{16\pi}\right)}{\Gamma\left(\frac{-2i \log(a)+i \log(\frac{b}{2})+2i \log(p)-2i \log(\alpha)+14\pi}{16\pi}\right)}\right) + i\pi + 2 \log(\pi) + \log(64) \right)
\end{aligned}$$

EXAMPLE 5.382.

$$\begin{aligned}
(5.384) \quad & \int_{\mathbb{R}_+^4} \frac{x^{u-1} z^{\frac{3}{4}-u} D_u(t\alpha) e^{-b(y+z^2) - \frac{1}{4}\alpha^2 t^2} \log\left(\log\left(\frac{ay}{ptz+qt z x^{4u}}\right)\right)}{\sqrt[4]{t} \sqrt[4]{y} \sqrt{p+qx^{4u}}} dx dy dz dt \\
&= \frac{\pi^{3/2} 2^{\frac{u}{2} - \frac{31}{8}} \Gamma\left(\frac{1}{4}\right) b^{\frac{u}{2} - \frac{11}{8}} \sqrt[4]{\frac{p}{q}}}{\alpha^{3/4} \sqrt{pu}} \left( (-2+2i) \log\left(\frac{\Gamma\left(-\frac{i(2 \log(a)-\log(b)-2 \log(p)+2 \log(\alpha)+\log(2)+2i\pi)}{16\pi}\right)}{2\Gamma\left(\frac{1}{2} - \frac{i(2 \log(a)-\log(b)-2 \log(p)+2 \log(\alpha)+\log(2)+2i\pi)}{16\pi}\right)}\right) \right. \\
&\quad \left. - (2+2i) \log\left(\frac{\Gamma\left(\frac{1}{4} - \frac{i(2 \log(a)-\log(b)-2 \log(p)+2 \log(\alpha)+\log(2)+2i\pi)}{16\pi}\right)}{2\Gamma\left(\frac{3}{4} - \frac{i(2 \log(a)-\log(b)-2 \log(p)+2 \log(\alpha)+\log(2)+2i\pi)}{16\pi}\right)}\right) + i\pi + \log(4\pi^2) \right)
\end{aligned}$$

EXAMPLE 5.383.

$$\begin{aligned}
(5.385) \quad & \int_{\mathbb{R}_+^4} \frac{\sqrt{x} D_{\frac{3}{2}}(t) e^{-\frac{t^2}{4} - 2(y+z^2)} \log\left(\log\left(\frac{iy}{tx^6 z + tz}\right)\right)}{\sqrt[4]{t} \sqrt{x^6+1} \sqrt[4]{y} z^{3/4}} dx dy dz dt \\
&= \frac{\pi^{3/2} \Gamma\left(\frac{1}{4}\right) \left( i\pi + \log(64\pi^2) - (2-2i) \left( \log\left(\frac{\Gamma\left(\frac{3}{16}\right)}{\Gamma\left(\frac{11}{16}\right)}\right) + i \log\left(\frac{\Gamma\left(\frac{7}{16}\right)}{\Gamma\left(\frac{15}{16}\right)}\right) \right) \right)}{12 \cdot 2^{3/4}}
\end{aligned}$$

EXAMPLE 5.384.

$$\begin{aligned}
(5.386) \quad & \int_{\mathbb{R}_+^4} \frac{x^{2/3} D_{\frac{5}{3}}(t) e^{-\frac{t^2}{4} - 2(y+z^2)} \log\left(\log\left(\frac{iy}{2tx^{20/3}z+tz}\right)\right)}{\sqrt[4]{t} \sqrt{2x^{20/3}+1} \sqrt[4]{y} z^{11/12}} dx dy dz dt \\
&= \frac{3\pi^{3/2} \Gamma\left(\frac{1}{4}\right)}{40 \cdot 2^{5/6}} \left( i\pi + \log(64) + 2 \log(\pi) \right. \\
&\quad \left. - (2-2i) \left( \log\left(\Gamma\left(\frac{3}{16}\right)\right) - \log\left(\Gamma\left(\frac{11}{16}\right)\right) + i \log\left(\frac{\Gamma\left(\frac{7}{16}\right)}{\Gamma\left(\frac{15}{16}\right)}\right) \right) \right)
\end{aligned}$$

EXAMPLE 5.385.

$$(5.387) \quad \int_{\mathbb{R}_+^4} \frac{x^{\frac{\pi}{2}-1} z^{\frac{3}{4}-\frac{\pi}{2}} D_{\frac{\pi}{2}}(t) e^{-\frac{t^2}{4}-2(y+z^2)} \log\left(\log\left(-\frac{y}{2tx^{2\pi}z+tz}\right)\right)}{\sqrt[4]{t}\sqrt{2x^{2\pi}+1}\sqrt{y}} dx dy dz dt$$

$$= 2^{\frac{1}{2}(\pi-9)} \sqrt{\pi} \Gamma\left(\frac{1}{4}\right) \left( i\pi + \log(64) + (1-i) \log\left(\frac{\pi\Gamma\left(\frac{3}{4}\right)^2}{\Gamma\left(\frac{1}{4}\right)^2}\right) \right)$$

EXAMPLE 5.386.

$$(5.388) \quad \int_{\mathbb{R}_+^4} \frac{x^{\frac{2\pi}{5}-1} z^{\frac{3}{4}-\frac{2\pi}{5}} D_{\frac{2\pi}{5}}(t) e^{-\frac{t^2}{4}-2(y+z^2)} \log\left(\log\left(-\frac{y}{3tx^{8\pi/5}z+tz}\right)\right)}{\sqrt[4]{t}\sqrt{3x^{8\pi/5}+1}\sqrt{y}} dx dy dz dt$$

$$= \frac{5 \times 2^{\frac{2\pi}{5}-\frac{25}{4}} \sqrt{\pi} \Gamma\left(\frac{1}{4}\right) \left( i\pi + \log(64) + (1-i) \log\left(\frac{\pi\Gamma\left(\frac{3}{4}\right)^2}{\Gamma\left(\frac{1}{4}\right)^2}\right) \right)}{\sqrt[4]{3}}$$

EXAMPLE 5.387.

$$(5.389) \quad \int_{\mathbb{R}_+^4} \frac{x^{\frac{2\pi}{5}-1} z^{\frac{3}{4}-\frac{2\pi}{5}} D_{\frac{2\pi}{5}}(t) e^{-\frac{t^2}{4}-2(y+z^2)} \log\left(\log\left(-\frac{y}{4tx^{8\pi/5}z+tz}\right)\right)}{\sqrt[4]{t}\sqrt{4x^{8\pi/5}+1}\sqrt{y}} dx dy dz dt$$

$$= 5 \cdot 2^{\frac{2\pi}{5}-\frac{27}{4}} \sqrt{\pi} \Gamma\left(\frac{1}{4}\right) \left( i\pi + \log(64) + (1-i) \log\left(\frac{\pi\Gamma\left(\frac{3}{4}\right)^2}{\Gamma\left(\frac{1}{4}\right)^2}\right) \right)$$

EXAMPLE 5.388.

$$(5.390) \quad \int_{\mathbb{R}_+^4} \frac{\sqrt{x} D_{\frac{6}{5}}(t) e^{-\frac{t^2}{4}-2(y+z^2)} \log\left(\log\left(\frac{iy}{\pi tx^{24/5}z+tz}\right)\right)}{\sqrt[4]{t}\sqrt{\pi x^{24/5}+1}\sqrt{y} z^{9/20}} dx dy dz dt$$

$$= \frac{5\pi^{5/4}\Gamma\left(\frac{1}{4}\right)}{96\sqrt[20]{2}} (i\pi + \log(64) + 2\log(\pi)$$

$$- (2-2i) \left( \log\left(\Gamma\left(\frac{3}{16}\right)\right) - \log\left(\Gamma\left(\frac{11}{16}\right)\right) + i \log\left(\frac{\Gamma\left(\frac{7}{16}\right)}{\Gamma\left(\frac{15}{16}\right)}\right) \right))$$

EXAMPLE 5.389.

$$(5.391) \quad \int_{\mathbb{R}_+^4} \frac{D_{\frac{1}{2}}\left(\frac{t}{\sqrt{2}}\right) e^{-\frac{t^2}{8}-y-z^2} \log\left(\log\left(-\frac{y}{tx^4z+tz}\right)\right)}{\sqrt{t}\sqrt{x}(x^4+1)^{5/8} y^{3/8} \log\left(-\frac{y}{tx^4z+tz}\right)} dx dy dz dt$$

$$= \frac{\sqrt{\pi} \log(2) (2i\gamma + \pi - i \log(8\pi^2)) \Gamma\left(\frac{9}{8}\right)}{2^{3/4}}$$

EXAMPLE 5.390.

$$(5.392) \quad \int_{\mathbb{R}_+^4} \frac{D_{\frac{1}{2}}\left(\frac{t}{\sqrt{2}}\right) e^{-\frac{t^2}{8}-y-z^2} \log\left(\log\left(-\frac{y}{tx^4z+tz}\right)\right)}{\sqrt{t}\sqrt{x}(x^4+1)^{5/8}y^{3/8}\log^2\left(-\frac{y}{tx^4z+tz}\right)} dx dy dz dt$$

$$= \frac{\pi^{3/2}\Gamma\left(\frac{1}{8}\right)(-24\log(A)+2\gamma-i\pi+\log(4))}{192\ 2^{3/4}}$$

EXAMPLE 5.391.

$$(5.393) \quad \int_{\mathbb{R}_+^4} \frac{D_{\frac{1}{4}}\left(\frac{t}{\sqrt{2}}\right) e^{-\frac{t^2}{8}-y-z^2}}{t^{3/4}x^{3/4}(x^4+1)^{13/16}y^{3/16}\log^2\left(-\frac{y}{tx^4z+tz}\right)} dx dy dz dt$$

$$= \frac{(-1)^{3/4}(\pi^2+48iC)\Gamma\left(\frac{1}{16}\right)}{384\ 2^{7/8}\sqrt{\pi}}$$

EXAMPLE 5.392.

$$(5.394) \quad \int_{\mathbb{R}_+^4} t^{-\frac{1}{2}+\frac{i}{2}}x^{-\frac{1}{2}+\frac{i}{2}}(x^4+1)^{-\frac{5}{8}+\frac{3i}{8}}y^{-\frac{3}{8}-\frac{3i}{8}}D_{\frac{1}{2}+\frac{i}{2}}\left(\frac{t}{\sqrt{2}}\right)$$

$$e^{-\frac{t^2}{8}-y-z^2}\log\left(-\frac{y}{tx^4z+tz}\right) dx dy dz dt$$

$$= \frac{i2^{-\frac{3}{4}+\frac{i}{4}}e^{\pi/2}\pi^{5/2}\Gamma\left(\frac{1}{8}+\frac{i}{8}\right)}{(1+e^\pi)^2}$$

EXAMPLE 5.393.

$$(5.395) \quad \int_{\mathbb{R}_+^4} \frac{t^{-\frac{3}{4}+\frac{i}{4}}x^{-\frac{3}{4}+\frac{i}{4}}(\sqrt{3}x^4+1)^{-\frac{13}{16}+\frac{3i}{16}}y^{-\frac{3}{16}-\frac{3i}{16}}D_{\frac{1}{4}+\frac{i}{4}}\left(\frac{t}{\sqrt{2}}\right) e^{-\frac{t^2}{8}-y-z^2}}{\log\left(-\frac{y}{\sqrt{3}tx^4z+tz}\right)} dx dy dz dt$$

$$= -(-1)^{\frac{1}{4}+\frac{i}{4}}2^{-\frac{23}{8}+\frac{i}{8}}3^{-\frac{1}{32}-\frac{i}{32}}\sqrt{\pi}\log\left(1+ie^{\pi/2}\right)\Gamma\left(\frac{1}{16}+\frac{i}{16}\right)$$

EXAMPLE 5.394. Definite integral in terms of the Hurwitz zeta function  $\zeta(s, v)$ .

$$(5.396) \quad \int_0^\infty \int_0^\infty \int_0^\infty \frac{y^5 e^{-y^6-z} \text{Ai}(x\alpha)^2 \log^k\left(-\frac{xy^2}{z}\right)}{\sqrt{x}\sqrt{z}} dx dy dz$$

$$= \frac{1}{9\sqrt{\alpha}} 2^{2k-1} e^{\frac{i\pi k}{2}} \pi^{k+\frac{1}{2}} \left( \zeta\left(-k, \frac{i(3\log(\alpha)+\log(12)-6i\pi)}{12\pi}\right) \right.$$

$$\left. - \zeta\left(-k, \frac{i(3\log(\alpha)+\log(12)-12i\pi)}{12\pi}\right) \right)$$

EXAMPLE 5.395. Definite integral in terms of the Hurwitz zeta function  $\zeta(s, v)$ .

$$(5.397) \quad \int_0^\infty \int_0^\infty \int_0^\infty \frac{y^5 \text{Ai}(x)^2 e^{-\frac{y^6}{12} - z} \log^k \left( \frac{ixy^2}{z} \right)}{\sqrt{x}\sqrt{z}} dx dy dz \\ = \frac{1}{3} 2^{2k+1} e^{\frac{i\pi k}{2}} \pi^{k+\frac{1}{2}} \left( \zeta \left( -k, \frac{3}{8} \right) - \zeta \left( -k, \frac{7}{8} \right) \right)$$

EXAMPLE 5.396.

$$(5.398) \quad \int_0^\infty \int_0^\infty \int_0^\infty \frac{y^5 \text{Ai} \left( \frac{x}{2^{2/3} \sqrt[3]{3}} \right)^2 e^{-y^6 - z}}{\sqrt{x}\sqrt{z} \left( \log^2 \left( \frac{xy^2}{z} \right) + \pi^2 \right)} dx dy dz = \frac{\log(2)}{6 \cdot 2^{2/3} 3^{5/6} \pi^{3/2}}$$

and

$$(5.399) \quad \int_0^\infty \int_0^\infty \int_0^\infty \frac{y^5 \text{Ai} \left( \frac{x}{2^{2/3} \sqrt[3]{3}} \right)^2 e^{-y^6 - z} \log \left( \frac{xy^2}{z} \right)}{\sqrt{x}\sqrt{z} \left( \log^2 \left( \frac{xy^2}{z} \right) + \pi^2 \right)} dx dy dz = 0$$

EXAMPLE 5.397.

$$(5.400) \quad \int_0^\infty \int_0^\infty \int_0^\infty \frac{y^5 \text{Ai}(x)^2 e^{-\frac{y^6}{12} - z}}{\sqrt{x}\sqrt{z} \left( 4 \log^2 \left( \frac{xy^2}{z} \right) + \pi^2 \right)} dx dy dz = \frac{\psi^{(0)} \left( \frac{7}{8} \right) - \psi^{(0)} \left( \frac{3}{8} \right)}{12\pi^{3/2}}$$

and

$$(5.401) \quad \int_0^\infty \int_0^\infty \int_0^\infty \frac{y^5 \text{Ai}(x)^2 e^{-\frac{y^6}{12} - z} \log \left( \frac{xy^2}{z} \right)}{\sqrt{x}\sqrt{z} \left( \log^2 \left( \frac{xy^2}{z} \right) + \frac{\pi^2}{4} \right)} dx dy dz = 0$$

5.1.21. Derived using equation (4.71).

EXAMPLE 5.398.

$$(5.402) \quad \int_0^1 \int_0^1 \frac{x^n (-1 + x^{-1-n})^{-m} y^n (-1 + y^{-1-n})^{\frac{1}{2}-m} \left( 1 - (-1 + x^{-1-n})^{2m} (-1 + y^{-1-n})^{2m} \right)}{\log \left( (-1 + x^{-1-n}) (-1 + y^{-1-n}) \right)} dy dx \\ = \frac{e^{-2im\pi}}{8(1+n)^2\pi} \left( -8e^{2im\pi} m\pi^2 \left( (-1 + 2m) \coth^{-1} \left( e^{2im\pi} \right) - (1 + 2m) \tanh^{-1} \left( e^{2im\pi} \right) \right) \right. \\ \left. + \Phi \left( e^{-4im\pi}, 3, \frac{1}{2} \right) + i \left( (-1 + 4m)\pi \Phi \left( e^{-4im\pi}, 2, \frac{1}{2} \right) \right. \right. \\ \left. \left. + e^{4im\pi} \left( (\pi + 4m\pi)\Phi \left( e^{4im\pi}, 2, \frac{1}{2} \right) + i\Phi \left( e^{4im\pi}, 3, \frac{1}{2} \right) \right) \right) \right)$$

EXAMPLE 5.399.

$$(5.403) \quad \int_0^1 \int_0^1 \frac{x^n y^n \sqrt[4]{-1 + y^{-1-n}}}{\sqrt[4]{-1 + x^{-1-n}} \log \left( -((-1 + x^{-1-n}) (-1 + y^{-1-n})) \right)} dy dx$$

$$= -\frac{i\left(\zeta\left(3, \frac{3}{8}\right) - \zeta\left(3, \frac{7}{8}\right) + 2\sqrt{2}\pi^2\left(\pi + 2\log\left(\tan\left(\frac{\pi}{8}\right)\right)\right)\right)}{64(1+n)^2\pi}$$

EXAMPLE 5.400.

$$(5.404) \quad \int_0^1 \int_0^1 \frac{x^n y^n \sqrt[4]{-1+y^{-1-n}} \log\left(\log\left(a(-1+x^{-1-n})(-1+y^{-1-n})\right)\right)}{\sqrt[4]{-1+x^{-1-n}}} dy dx$$

$$= \frac{1}{16(1+n)^2} \left( \pi^2(i\pi + \log(64)) + 2\log(\pi) - 4\log(-6\pi - i\log(a)) + 4\log(-2\pi - i\log(a)) \right)$$

$$+ 4\pi^2 \left( -\log\Gamma\left(-\frac{3}{4} - \frac{i\log(a)}{8\pi}\right) + \log\Gamma\left(-\frac{1}{4} - \frac{i\log(a)}{8\pi}\right) \right) - \psi^{(1)}\left(\frac{1}{4} - \frac{i\log(a)}{8\pi}\right)$$

$$+ \psi^{(1)}\left(\frac{3}{4} - \frac{i\log(a)}{8\pi}\right)$$

EXAMPLE 5.401.

$$(5.405) \quad \int_0^1 \int_0^1 x^n y^n \sqrt{-1+y^{-1-n}} \log\left(\log\left(a(-1+x^{-1-n})(-1+y^{-1-n})\right)\right) dy dx$$

$$= \frac{\pi}{2(1+n)^2} \left( 2 + i\pi + \log(a) + \frac{1}{2}i\pi \log(a) + 2\log(2)(2 - i\pi + \log(a)) + 2\log(\pi) \right.$$

$$\left. - 2i\pi \log(\pi) + \log(a) \log(\pi) + 4i\pi \log\left(-\frac{1}{2} - \frac{i\log(a)}{4\pi}\right) \right.$$

$$\left. + 4i\pi \log\Gamma\left(-\frac{1}{2} - \frac{i\log(a)}{4\pi}\right) + 2\psi^{(0)}\left(\frac{1}{2} - \frac{i\log(a)}{4\pi}\right) \right)$$

EXAMPLE 5.402.

$$(5.406) \quad \int_0^1 \int_0^1 x^n y^n \sqrt{-1+y^{-1-n}} \log^2\left(a(-1+x^{-1-n})(-1+y^{-1-n})\right)$$

$$\log\left(\log\left(a(-1+x^{-1-n})(-1+y^{-1-n})\right)\right) dy dx$$

$$= \frac{4\pi^2}{(1+n)^2} \left( \frac{(4\pi^2 + 3\log^2(a))(1 + i\pi + \log(16) + 2\log(\pi))}{48\pi} \right.$$

$$\left. + \frac{\log(a)(3 + i\pi + \log(16) + 2\log(\pi))}{4\pi} + 2i \left( -\frac{1}{2} \log(2\pi) + \log\left(-\frac{1}{2} - \frac{i\log(a)}{4\pi}\right) \right) \right.$$

$$\left. + \log\Gamma\left(-\frac{1}{2} - \frac{i\log(a)}{4\pi}\right) \right) - 4\pi\zeta'\left(-1, \frac{1}{2} - \frac{i\log(a)}{4\pi}\right)$$

5.1.22. *Derived using equation (4.62).*

EXAMPLE 5.403.

$$(5.407) \quad \int_0^1 \frac{x^n (-1+x^{-1-n})^{-\frac{1}{2}-m} \left(-1 + (-1+x^{-1-n})^{2m}\right)}{\log(-1+x^{-1-n})} dx$$

$$= \frac{1}{2(1+n)\pi} \left( 2i\pi \left( (1+2m) \cot^{-1}(e^{im\pi}) + (-1+2m) \tan^{-1}(e^{im\pi}) \right) \right. \\ \left. + e^{-im\pi} \Phi \left( -e^{-2im\pi}, 2, \frac{1}{2} \right) - e^{im\pi} \Phi \left( -e^{2im\pi}, 2, \frac{1}{2} \right) \right)$$

EXAMPLE 5.404.

$$(5.408) \quad \int_0^1 \frac{x^n \log^k(1-x^{-1-n})}{\sqrt{-1+x^{-1-n}}} dx \\ = \frac{e^{\frac{ik\pi}{2}} (-2^k (-1+2^{1+k}) \pi^{1+k} \zeta(-k) - 2i(-1+2^k) \cos(\frac{k\pi}{2}) \Gamma(1+k) \zeta(k))}{1+n}$$

EXAMPLE 5.405.

$$(5.409) \quad \int_0^1 \frac{x^n}{\sqrt{-1+x^{-1-n}} \log^2(1-x^{-1-n})} dx = -\frac{\pi^3 - 18i\zeta(3)}{48(1+n)\pi^2}$$

EXAMPLE 5.406.

$$(5.410) \quad \int_0^1 \frac{x^n \log(1-x^{-1-n}) \log(\log(1-x^{-1-n}))}{\sqrt{-1+x^{-1-n}}} dx \\ = -\frac{\pi \left( i\pi + \frac{\pi^2}{2} \right)}{2(1+n)} \\ + \frac{i \left( i\pi - 2\pi^2 \log \left( \frac{A^3}{\sqrt[3]{2^4} \sqrt{e}} \right) + i\pi \log(2\pi) + \frac{1}{2}\pi^2 \log(2\pi) - 2i\pi \Phi'(-1, 0, 1) \right)}{1+n}$$

EXAMPLE 5.407.

$$(5.411) \quad \int_0^1 \frac{x^n \log^2(1-x^{-1-n}) \log(\log(1-x^{-1-n}))}{\sqrt{-1+x^{-1-n}}} dx \\ = \frac{\pi^3}{1+n} - \frac{i\pi^2 - 8i\pi^2 \log \left( \frac{A^3}{\sqrt[3]{2^4} \sqrt{e}} \right) + 2i\pi^2 \log(2\pi) - 7\pi\zeta(3)}{1+n}$$

EXAMPLE 5.408.

$$(5.412) \quad \int_0^1 \frac{x^n \log(\log(1-x^{-1-n}))}{\sqrt{-1+x^{-1-n}} \log(1-x^{-1-n})} dx \\ = \frac{\pi \left( 12i \log(2) \left( 2\gamma + \log \left( \frac{1}{8\pi^2} \right) \right) + \pi \left( 2 - i\pi + \log(1024) - 2 \log(\pi) \right) \right) - 24Li_2'(-1)}{48(1+n)\pi}$$

EXAMPLE 5.409.

$$(5.413) \quad \int_0^1 x^n \log^k(a(-1+x^{-1-n})) dx = -\frac{e^{\frac{ik\pi}{2}} k(2\pi)^k \zeta \left( 1-k, \frac{\pi-i \log(a)}{2\pi} \right)}{1+n}$$

EXAMPLE 5.410.

$$\begin{aligned}
 (5.414) \quad & \int_0^1 x^n \log(a(-1+x^{-1-n})) \log(\log(a(-1+x^{-1-n}))) dx \\
 &= \frac{1}{1+n} \left( \log(a) + \frac{1}{2} i\pi \log(a) + \log(a)(\log(2) + \log(\pi)) \right. \\
 & \left. + 2i\pi \left( -\frac{1}{2} \log(2\pi) + \log\left(-1 + \frac{\pi - i \log(a)}{2\pi}\right) + \log\Gamma\left(-1 + \frac{\pi - i \log(a)}{2\pi}\right) \right) \right)
 \end{aligned}$$

EXAMPLE 5.411.

$$(5.415) \quad \int_0^1 x^n \log(1-x^{-1-n}) \log(\log(1-x^{-1-n})) dx = -\frac{\pi(-2i+\pi)}{2(1+n)}$$

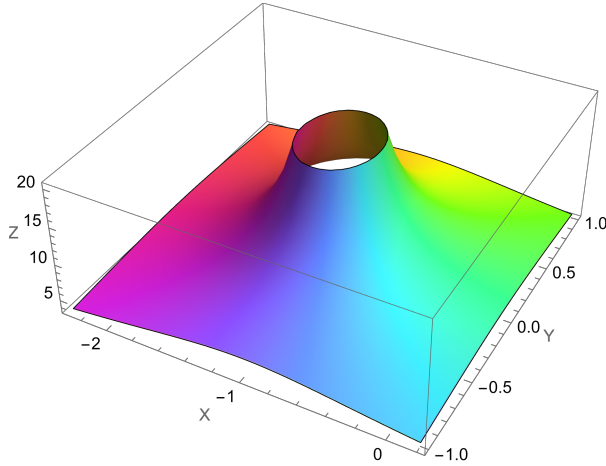
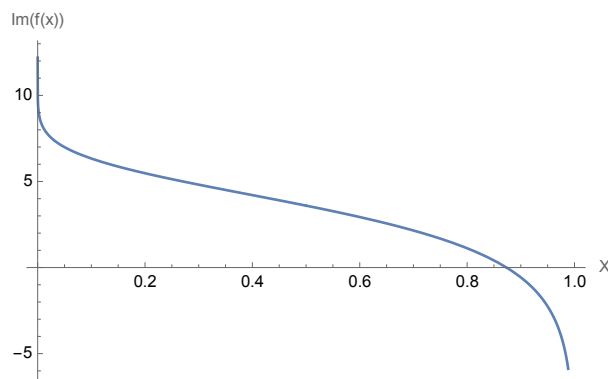
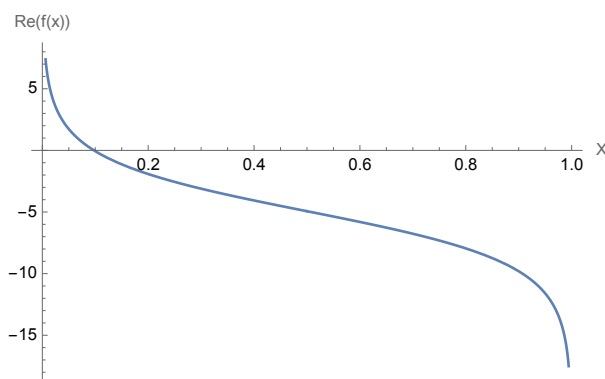

FIGURE 8. Plot of  $f(n) = -\frac{\pi(-2i+\pi)}{2(1+n)}$ ,  $n \in \mathbb{C}$ .

EXAMPLE 5.412.

$$(5.416) \quad \int_0^1 \log\left(\frac{x-1}{x}\right) \log\left(\log\left(\frac{x-1}{x}\right)\right) dx = \frac{1}{2}\pi(2i-\pi)$$



FIGURE 9. Plot of  $f(x) = \log\left(\frac{x-1}{x}\right) \log\left(\log\left(\frac{x-1}{x}\right)\right)$ ,  $x \in \mathbb{R}$ .FIGURE 10. Plot of  $f(x) = \log\left(\frac{x-1}{x}\right) \log\left(\log\left(\frac{x-1}{x}\right)\right)$ ,  $x \in \mathbb{R}$ .

EXAMPLE 5.413.

$$(5.417) \quad \int_0^1 \frac{x^n}{a^2 \pi^2 - \log^2(-1 + x^{-1-n})} dx = \frac{i(-\psi^{(1)}\left(\frac{1}{2} - \frac{ia}{2}\right) + \psi^{(1)}\left(\frac{1}{2} + \frac{ia}{2}\right))}{4a(1+n)\pi^2}$$

where  $Im(a) \leq 0, Im(n) < 0$ 

EXAMPLE 5.414.

$$(5.418) \quad \int_0^1 \frac{x^n \log(-1 + x^{-1-n})}{a^2 - \log^2(-1 + x^{-1-n})} dx = \begin{cases} \frac{i\pi}{2(1+n)(1+\cosh(a))}; & Im(n) > 0 \\ -\frac{i\pi}{2(1+n)(1+\cosh(a))}; & Im(n) < 0 \end{cases}$$

EXAMPLE 5.415.

$$(5.419) \quad \int_0^1 \frac{x^n \log(-1 + x^{-1-n})}{(a^2 - \log^2(-1 + x^{-1-n}))^2} dx = \begin{cases} \frac{i\pi \sinh(a)}{4a(1+n)(1+\cosh(a))^2}; & Im(n) > 0 \\ -\frac{i\pi \sinh(a)}{4a(1+n)(1+\cosh(a))^2}; & Im(n) < 0 \end{cases}$$

EXAMPLE 5.416.

$$(5.420) \quad \int_0^1 x^n \log^k(1 - x^{-1-n}) dx = -\frac{(1 + e^{ik\pi})}{1+n} \Gamma(1+k) \zeta(k)$$

EXAMPLE 5.417.

$$(5.421) \quad \int_0^1 x^n \log(\log(1 - x^{-1-n})) dx = \frac{i\pi + \log(4e^{-2\gamma}\pi^2)}{2(1+n)}$$

EXAMPLE 5.418.

$$(5.422) \quad \int_0^1 \frac{x^n}{\log(1 - x^{-1-n})} dx = \begin{cases} \frac{i\pi}{12(1+n)}; & \text{Im}(n) > 0 \\ -\frac{i\pi}{12(1+n)}; & \text{Im}(n) < 0 \end{cases}$$

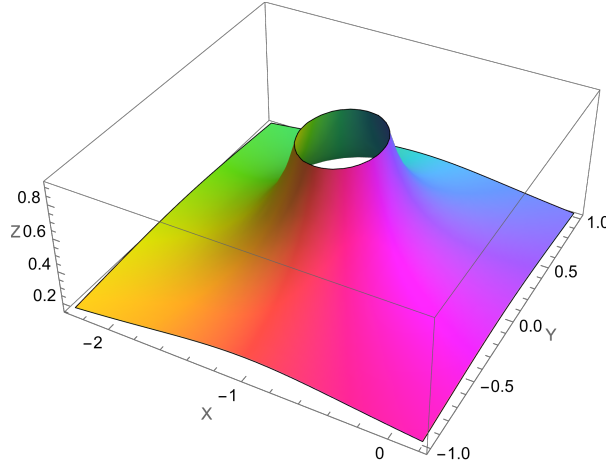
FIGURE 11. Plot of  $f(n) = -\frac{i\pi}{12(1+n)}$ ,  $n \in \mathbb{C}$ .

EXAMPLE 5.419.

$$(5.423) \quad \int_0^1 \frac{x^n \log(\log(1 - x^{-1-n}))}{\log(1 - x^{-1-n})} dx = \begin{cases} \frac{\pi(\pi + 2i \log(\frac{e^{1+\gamma}}{A^{12}}))}{24(1+n)}; & \text{Im}(n) < 0 \\ -\frac{\pi(\pi + 2i \log(\frac{e^{1+\gamma}}{A^{12}}))}{24(1+n)}; & \text{Im}(n) > 0 \end{cases}$$

EXAMPLE 5.420.

$$(5.424) \quad \int_0^1 \frac{x^n \log(x^{-1-n} - 1)}{(a^2\pi^2 - \log^2(x^{-1-n} - 1))^2} dx = \begin{cases} \frac{icsch^3(a\pi) \sinh^4(\frac{a\pi}{2})}{a(1+n)}; & \text{Im}(n) > 0 \\ -\frac{icsch^3(a\pi) \sinh^4(\frac{a\pi}{2})}{a(1+n)}; & \text{Im}(n) < 0 \end{cases}$$

5.1.23. Derived using equation (4.81).

EXAMPLE 5.421.

$$(5.425) \quad \int_0^1 \left( \sum_{s=1}^n \frac{s^{-m} \left(1 - s^{2m} \left(-1 + \frac{1}{x}\right)^{2m}\right) \left(-1 + \frac{1}{x}\right)^{-m}}{\log\left(s \left(-1 + \frac{1}{x}\right)\right)} \right) dx$$

$$= \sum_{c=1}^n \frac{c^{-m} e^{-im\pi}}{2\pi} \left( 2m\pi\Phi\left(e^{-2im\pi}, 1, \frac{\pi - i \log(c)}{2\pi}\right) - i\Phi\left(e^{-2im\pi}, 2, \frac{\pi - i \log(c)}{2\pi}\right) \right)$$

$$+c^{2m}e^{2im\pi} \left( 2m\pi\Phi \left( e^{2im\pi}, 1, \frac{\pi - i \log(c)}{2\pi} \right) + i\Phi \left( e^{2im\pi}, 2, \frac{\pi - i \log(c)}{2\pi} \right) \right)$$

EXAMPLE 5.422.

$$(5.426) \quad \int_0^1 \left( \sum_{s=1}^n \sqrt{s} \sqrt{-1 + \frac{1}{x}} \log^k \left( as \left( -1 + \frac{1}{x} \right) \right) \right) dx$$

$$= \sum_{c=1}^n 2^{-1+2k} \sqrt{c} e^{\frac{ik\pi}{2}} \pi^k \left( -ik \left( \zeta \left( 1-k, \frac{\pi - i \log(a) - i \log(c)}{4\pi} \right) \right. \right.$$

$$\left. \left. - \zeta \left( 1-k, \frac{3\pi - i \log(a) - i \log(c)}{4\pi} \right) \right) + 2\pi \left( \zeta \left( -k, \frac{\pi - i \log(a) - i \log(c)}{4\pi} \right) \right.$$

$$\left. \left. - \zeta \left( -k, \frac{3\pi - i \log(a) - i \log(c)}{4\pi} \right) \right) \right)$$

EXAMPLE 5.423.

$$(5.427) \quad \int_0^1 \left( \sum_{s=1}^n \log^k \left( as \left( -1 + \frac{1}{x} \right) \right) \right) dx = - \sum_{c=1}^n k(2i\pi)^k \zeta \left( 1-k, \frac{\pi - i \log(a) - i \log(c)}{2\pi} \right)$$

EXAMPLE 5.424.

$$(5.428) \quad \int_0^1 \left( \sum_{s=1}^n \log \left( as \left( -1 + \frac{1}{x} \right) \right) \log \left( \log \left( as \left( -1 + \frac{1}{x} \right) \right) \right) \right) dx$$

$$= \sum_{c=1}^n \frac{1}{2} (\log(a) (2 + i\pi + \log(4\pi^2)) + \log(c) (2 + i\pi + \log(4\pi^2)))$$

$$- 2i\pi (\log(8\pi^3) - 2 \log(-\pi - i \log(a) - i \log(c))) + 4i\pi \log \Gamma \left( -\frac{\pi + i \log(a) + i \log(c)}{2\pi} \right)$$

EXAMPLE 5.425.

$$(5.429) \quad \int_0^1 \left( \sum_{s=1}^n \frac{\log(\log(s(1 - \frac{1}{x})))}{\sqrt{s} \sqrt{-1 + \frac{1}{x}}} \right) dx$$

$$= \sum_{c=1}^n \left( \frac{i\Phi \left( -1, 1, \frac{2\pi - i \log(c)}{2\pi} \right)}{\sqrt{c}} + \frac{\pi \log(2i\pi)}{2\sqrt{c}} - \frac{\pi\Phi' \left( -1, 0, \frac{2\pi - i \log(c)}{2\pi} \right)}{\sqrt{c}} \right)$$

EXAMPLE 5.426.

$$(5.430) \quad \int_0^1 \left( \sum_{s=1}^n \frac{\log \left( \frac{s(-1+x)}{x} \right) \log \left( \log \left( \frac{s(-1+x)}{x} \right) \right)}{\sqrt{s} \sqrt{-1 + \frac{1}{x}}} \right) dx$$

$$= \sum_{c=1}^n \frac{\pi}{2\sqrt{c}} \left( -2 + (-2 + i\pi + \log(c)) \log(2i\pi) - 4i\pi\Phi' \left( -1, -1, 1 - \frac{i \log(c)}{2\pi} \right) \right)$$

$$+4\Phi' \left( -1, 0, 1 - \frac{i \log(c)}{2\pi} \right)$$

EXAMPLE 5.427.

$$(5.431) \quad \int_0^1 \left( \sum_{s=1}^n \frac{\log \left( \log \left( \frac{s(-1+x)}{x} \right) \right)}{\sqrt{s} \sqrt{-1 + \frac{1}{x} \log \left( \frac{s(-1+x)}{x} \right)}} \right) dx$$

$$= \sum_{c=1}^n \frac{1}{8\sqrt{c\pi}} \left( -4i\pi\Phi \left( -1, 1, 1 - \frac{i \log(c)}{2\pi} \right) \log(2i\pi) \right.$$

$$\left. -(-1 + \log(2i\pi)) \left( \psi^{(1)} \left( \frac{1}{2} - \frac{i \log(c)}{4\pi} \right) - \psi^{(1)} \left( 1 - \frac{i \log(c)}{4\pi} \right) \right) \right.$$

$$\left. +4i\pi\Phi' \left( -1, 1, 1 - \frac{i \log(c)}{2\pi} \right) + 4\Phi' \left( -1, 2, 1 - \frac{i \log(c)}{2\pi} \right) \right)$$

5.1.24. *Derived using equation (4.72).*

EXAMPLE 5.428.

$$(5.432) \quad \int_0^1 \int_0^1 \frac{(-((-1+x)x))^{-\frac{1}{2}-m} y^n (-1+y^{-1-n})^{-m} \left( (1-x)^{2m} - x^{2m} (-1+y^{-1-n})^{2m} \right)}{(1+px) \log \left( \frac{x(-1+y^{-1-n})}{1-x} \right)} dy dx$$

$$= \frac{e^{-2im\pi} (1+p)^{-\frac{1}{2}-m}}{4(1+n)} \left( (1+p)^{2m} \left( 4m\pi\Phi \left( e^{-4im\pi}, 1, \frac{1}{2} + \frac{i \log(1+p)}{4\pi} \right) \right. \right.$$

$$\left. -i\Phi \left( e^{-4im\pi}, 2, \frac{1}{2} + \frac{i \log(1+p)}{4\pi} \right) \right) + e^{4im\pi} \left( 4m\pi\Phi \left( e^{4im\pi}, 1, \frac{1}{2} + \frac{i \log(1+p)}{4\pi} \right) \right.$$

$$\left. +i\Phi \left( e^{4im\pi}, 2, \frac{1}{2} + \frac{i \log(1+p)}{4\pi} \right) \right)$$

EXAMPLE 5.429.

$$(5.433) \quad \int_0^1 \int_0^1 \frac{y^n \left( a + ib + \log \left( \frac{x(-1+y^{-1-n})}{1-x} \right) \right)^k}{\sqrt{-((-1+x)x)(1+px)}} dy dx$$

$$= -\frac{(4i)^k k\pi^{1+k} \zeta \left( 1-k, -\frac{i(a+ib+2i\pi-\log(1+p))}{4\pi} \right)}{(1+n)\sqrt{1+p}}$$

EXAMPLE 5.430.

$$(5.434) \quad \int_0^1 \int_0^1 \frac{y^n \left( ib + apx + \log \left( \frac{x(-1+y^{-1-n})}{1-x} \right) \right)}{\sqrt{(1-x)x} (p^2x^2 - 1) \left( a^2 + b^2 - 2ib \log \left( \frac{x(-1+y^{-1-n})}{1-x} \right) - \log^2 \left( \frac{x(-1+y^{-1-n})}{1-x} \right) \right)} dy dx$$

$$= -\frac{i \left( \sqrt{1+p} \psi^{(1)} \left( \frac{ia+b+2\pi+i \log(1-p)}{4\pi} \right) + \sqrt{1-p} \psi^{(1)} \left( \frac{-ia+b+2\pi+i \log(1+p)}{4\pi} \right) \right)}{8(1+n)\sqrt{1-p^2}}$$

where  $-1 < \operatorname{Re}(p) < 1$

EXAMPLE 5.431.

(5.435)

$$\begin{aligned} \int_0^1 \int_0^1 \frac{2i\pi + x \log(2) + 2 \log\left(\frac{x(-1+y)}{(-1+x)y}\right)}{\sqrt{1-x}\sqrt{x}(-4+x^2) \left(\pi^2 + \log^2(2) - 2i\pi \log\left(\frac{x(-1+y)}{(-1+x)y}\right) - \log^2\left(\frac{x(-1+y)}{(-1+x)y}\right)\right)} dy dx \\ = -\frac{i \left( \sqrt{3}(-8C + \pi^2) + \psi^{(1)}\left(\frac{3}{4} - \frac{i \log(\frac{4}{3})}{4\pi}\right) \right)}{8\sqrt{6}} \end{aligned}$$

EXAMPLE 5.432.

(5.436)

$$\begin{aligned} \int_0^1 \int_0^1 \frac{2i\pi + \frac{1}{2}x \log(2) + \log\left(\frac{x(-1+y)}{(-1+x)y}\right)}{\sqrt{-((-1+x)x)}(-4+x^2) \left(\log^2(2) + \left(2\pi - i \log\left(\frac{x(-1+y)}{(-1+x)y}\right)\right)^2\right)} dy dx \\ = -\frac{i \left( \pi^2 + 2\sqrt{3}\psi^{(1)}\left(1 - \frac{i \log(\frac{4}{3})}{4\pi}\right) \right)}{96\sqrt{2}} \end{aligned}$$

EXAMPLE 5.433.

(5.437)

$$\begin{aligned} \int_0^1 \int_0^1 \frac{y^n \left( a + ib + \log\left(\frac{x(-1+y^{-1-n})}{1-x}\right) \right) \log\left( a + ib + \log\left(\frac{x(-1+y^{-1-n})}{1-x}\right) \right)}{\sqrt{-((-1+x)x)}(1+px)} dy dx \\ = \frac{\pi}{2(1+n)\sqrt{1+p}} (-b\pi + \log(1+p)(-i\pi - 2\log(4e\pi)) + 2ib\log(4e\pi)) \\ + a \left( i\pi + \log(16e^2\pi^2) \right) - 4i\pi \left( \log(32\pi^3) - 2\log(-ia + b - 2\pi + i \log(1+p)) \right) \\ + 8i\pi \log\Gamma\left(\frac{-ia + b - 2\pi + i \log(1+p)}{4\pi}\right) \end{aligned}$$

EXAMPLE 5.434.

$$\begin{aligned} (5.438) \quad \int_0^1 \int_0^1 \frac{\log\left(\log\left(-\frac{x(-1+y)}{(-1+x)y}\right)\right)}{\sqrt[4]{1-xx^3/4}\sqrt[4]{-1+\frac{1}{y}}} dy dx \\ = \frac{1}{4}\pi \left( -4i\sqrt{2} \log\left(\cot\left(\frac{\pi}{8}\right)\right) + \pi \left( 2i\sqrt{2} + i\pi + 2\log(4\pi) - 4\Phi'\left(-1, 0, \frac{3}{4}\right) \right) \right) \end{aligned}$$

EXAMPLE 5.435.

$$(5.439) \quad \int_0^1 \int_0^1 \frac{\log\left(\log\left(\frac{ix(-1+y)}{(-1+x)y}\right)\right)}{\sqrt[4]{1-xx^3/4}\sqrt[4]{-1+\frac{1}{y}}} dy dx$$

$$\begin{aligned}
&= \frac{1}{4}\pi \left( 8i \left( \cos\left(\frac{\pi}{8}\right) \log\left(\cot\left(\frac{3\pi}{16}\right)\right) + \log\left(\tan\left(\frac{\pi}{16}\right)\right) \sin\left(\frac{\pi}{8}\right) \right) \right. \\
&\quad \left. + \pi \left( i\pi + i \cot\left(\frac{3\pi}{16}\right) + \log(16) + 2\log(\pi) + i \tan\left(\frac{3\pi}{16}\right) - 4\Phi' \left(-1, 0, \frac{5}{8}\right) \right) \right)
\end{aligned}$$

EXAMPLE 5.436.

$$\begin{aligned}
(5.440) \quad &\int_0^1 \int_0^1 \frac{\log\left(\frac{2x(-1+y)}{(-1+x)y}\right) \log\left(\log\left(\frac{2x(-1+y)}{(-1+x)y}\right)\right)}{\sqrt[4]{1-xx^{3/4}}(1+x)^4 \sqrt[4]{-1+\frac{1}{y}}} dy dx \\
&= \frac{\pi^2(-2-4iC-i\pi-2\log(4\pi)+4\Phi'(-1,0,\frac{1}{2}))}{\sqrt[4]{2}}
\end{aligned}$$

EXAMPLE 5.437.

$$\begin{aligned}
(5.441) \quad &\int_0^1 \int_0^1 \frac{\sqrt[4]{-1+\frac{1}{y}} \log\left(\log\left(-\frac{x(-1+y)}{(-1+x)y}\right)\right)}{(1-x)^{3/4} \sqrt[4]{x}} dy dx \\
&= \frac{1}{4}\pi \left( 4i\sqrt{2} \log\left(\cot\left(\frac{\pi}{8}\right)\right) + \pi \left( -2i\sqrt{2} + i\pi + 2\log(4\pi) - 4\Phi' \left(-1, 0, \frac{3}{4}\right) \right) \right)
\end{aligned}$$

EXAMPLE 5.438. A limiting case involving a nested logarithm function.

$$\begin{aligned}
(5.442) \quad &\int_0^1 \int_0^1 \frac{y^n \log\left(\log\left(\frac{ax(-1+y^{-1-n})}{1-x}\right)\right)}{\sqrt[4]{1-xx^{3/4}}(1+px)^4 \sqrt[4]{-1+y^{-1-n}}} dy dx \\
&= \frac{\pi}{4(1+n)\sqrt[4]{1+p}} \left( \pi(i\pi + \log(64) + 2\log(\pi) - 4\log(-6\pi - i\log(a) + i\log(1+p))) \right. \\
&\quad \left. + 4\log(-2\pi - i\log(a) + i\log(1+p)) \right) + 4\pi \log\Gamma\left(-\frac{2\pi + i\log(a) - i\log(1+p)}{8\pi}\right) \\
&\quad - 4\pi \log\Gamma\left(-\frac{6\pi + i\log(a) - i\log(1+p)}{8\pi}\right) - 2i\psi^{(0)}\left(\frac{2\pi - i\log(a) + i\log(1+p)}{8\pi}\right) \\
&\quad \quad \quad + 2i\psi^{(0)}\left(\frac{6\pi - i\log(a) + i\log(1+p)}{8\pi}\right)
\end{aligned}$$

EXAMPLE 5.439.

$$\begin{aligned}
(5.443) \quad &\int_0^1 \int_0^1 \frac{\log\left(\log\left(-\frac{x(-1+y)}{(-1+x)y}\right)\right)}{\sqrt[4]{1-xx^{3/4}} \sqrt[4]{-1+\frac{1}{y}}} dy dx \\
&= \frac{1}{4}\pi \left( \pi \left( i\pi + 2\log\left(\frac{8\pi}{25}\right) - 4\log\Gamma\left(-\frac{5}{8}\right) + 4\log\Gamma\left(-\frac{1}{8}\right) \right) \right. \\
&\quad \left. - 2i \left( \psi^{(0)}\left(\frac{3}{8}\right) - \psi^{(0)}\left(\frac{7}{8}\right) \right) \right)
\end{aligned}$$

EXAMPLE 5.440.

$$\begin{aligned}
(5.444) \quad & \int_0^1 \int_0^1 \frac{\log \left( \log \left( \frac{2x(-1+y)}{(-1+x)y} \right) \right)}{\sqrt[4]{1-xx^{3/4}(1+x)} \sqrt[4]{-1+\frac{1}{y}}} dy dx \\
& = \frac{\pi^2 \left( 2i + i\pi + \log \left( \frac{64\pi^2}{81} \right) - 4\log\Gamma \left( -\frac{3}{4} \right) + 4\log\Gamma \left( -\frac{1}{4} \right) \right)}{4\sqrt[4]{2}}
\end{aligned}$$

5.1.25. *Derived using equations (4.73) and (4.74).*

EXAMPLE 5.441.

$$\begin{aligned}
(5.445) \quad & \int_0^\infty \int_0^\infty \int_0^\infty \frac{e^{-\frac{x}{4}-\frac{y}{4}} \text{Ei}(-z)}{\sqrt[4]{xy} \sqrt[4]{x+yz^{3/4}} \log \left( \frac{i\sqrt{xy}}{\sqrt{x+y\sqrt{z}}} \right)} dz dy dx \\
& = \sum_{y=0}^\infty -16(-1)^{3/4} \pi^{3/2} \Gamma \left( 0, \frac{1}{2} i\pi(1+y) \right)
\end{aligned}$$

EXAMPLE 5.442.

$$(5.446) \quad \int_0^\infty \int_0^\infty \int_0^\infty \frac{e^{-\frac{x}{4}-\frac{y}{4}} \text{Ei}(-z)}{\sqrt[4]{xy} \sqrt[4]{x+yz^{3/4}} \log \left( -\frac{\sqrt{xy}}{\sqrt{x+y\sqrt{z}}} \right)} dz dy dx = \sum_{y=0}^\infty 16\pi^{3/2} \Gamma \left( 0, \frac{1}{4} i\pi(3+2y) \right)$$

EXAMPLE 5.443.

$$(5.447) \quad \int_0^\infty \int_0^\infty \int_0^\infty \frac{e^{-\frac{x}{4}-\frac{y}{4}} \text{Ei}(-z)}{\sqrt[4]{xy} \sqrt[4]{x+yz^{3/4}} \log^2 \left( -\frac{\sqrt{xy}}{\sqrt{x+y\sqrt{z}}} \right)} dz dy dx = \sum_{y=0}^\infty 8\pi^{3/2} \Gamma \left( -1, \frac{1}{4} i\pi(3+2y) \right)$$

EXAMPLE 5.444.

$$\begin{aligned}
(5.448) \quad & \int_0^\infty \int_0^\infty \int_0^\infty \frac{e^{-\frac{x}{4}-\frac{y}{4}} \text{Ei}(-2z)}{\sqrt[4]{xy} \sqrt[4]{x+yz^{3/4}} \log^2 \left( \frac{i\sqrt{xy}}{\sqrt{x+y\sqrt{z}}} \right)} dz dy dx \\
& = \sum_{y=0}^\infty -8(-1)^{3/4} \pi^{3/2} \Gamma \left( -1, \frac{1}{4} (2i\pi(1+y) + \log(2)) \right)
\end{aligned}$$

EXAMPLE 5.445.

$$\begin{aligned}
(5.449) \quad & \int_0^\infty \int_0^\infty \int_0^\infty \frac{e^{-\frac{x}{4}-\frac{y}{4}} \text{Ei}(-z) \log \left( \log \left( -\frac{\sqrt{xy}}{\sqrt{x+y\sqrt{z}}} \right) \right)}{\sqrt{xy} \sqrt{z} \log \left( -\frac{\sqrt{xy}}{\sqrt{x+y\sqrt{z}}} \right)} dz dy dx \\
& = \sum_{y=0}^\infty 16i\pi^{3/2} \left( \Gamma \left( 0, \frac{1}{2} i\pi(3+2y) \right) \log \left( \frac{1}{2} i\pi(3+2y) \right) + G_{2,3}^{3,0} \left( \frac{1}{2} i\pi(3+2y) \mid \begin{matrix} 1, 1 \\ 0, 0, 0 \end{matrix} \right) \right)
\end{aligned}$$

EXAMPLE 5.446.

$$(5.450) \quad \int_0^\infty \int_0^\infty \int_0^\infty \frac{e^{-\frac{x}{4}-\frac{y}{4}} \text{Ei}(-z) \left(-2 - \log\left(\frac{i\sqrt{xy}}{\sqrt{x+y}\sqrt{z}}\right)\right)}{\sqrt{xy}\sqrt{z} \log^3\left(\frac{i\sqrt{xy}}{\sqrt{x+y}\sqrt{z}}\right)} dz dy dx = -\frac{1}{3} \left(4\pi^{3/2}\right)$$

EXAMPLE 5.447.

$$(5.451) \quad \int_0^\infty \int_0^\infty \int_0^\infty \frac{e^{-\frac{x}{4}-\frac{y}{4}} \text{Ei}(-z) \left(3 + \log\left(\frac{i\sqrt{xy}}{\sqrt{x+y}\sqrt{z}}\right)\right)}{\sqrt{xy}\sqrt{z} \log^4\left(\frac{i\sqrt{xy}}{\sqrt{x+y}\sqrt{z}}\right)} dz dy dx = -\frac{12i\zeta(3)}{\pi^{3/2}}$$

EXAMPLE 5.448.

$$(5.452) \quad \int_0^\infty \int_0^\infty \int_0^\infty \frac{e^{-\frac{x}{4}-\frac{y}{4}} \text{Ei}(-z) \left(\frac{1}{2} - \log\left(\frac{i\sqrt{xy}}{\sqrt{x+y}\sqrt{z}}\right)\right)}{\sqrt{xy}\sqrt{z} \sqrt{\log\left(\frac{i\sqrt{xy}}{\sqrt{x+y}\sqrt{z}}\right)}} dz dy dx \\ = 4\sqrt[4]{-1} \left(-1 + 2\sqrt{2}\right) \pi \zeta\left(\frac{3}{2}\right)$$

EXAMPLE 5.449.

$$(5.453) \quad \int_0^\infty \int_0^\infty \int_0^\infty \frac{e^{-\frac{x}{4}-\frac{y}{4}} \text{Ei}(-z) \left(1 + \log\left(-\frac{\sqrt{xy}}{\sqrt{x+y}\sqrt{z}}\right)\right)}{\sqrt{xy}\sqrt{z} \log^2\left(-\frac{\sqrt{xy}}{\sqrt{x+y}\sqrt{z}}\right)} dz dy dx = -8i(-4 + \pi)\sqrt{\pi}$$

5.1.26. *Derived using equation (4.75).*

EXAMPLE 5.450.

$$(5.454) \quad \int_0^{\frac{\pi}{4}} \int_0^{\frac{\pi}{4}} \int_0^{\frac{\pi}{4}} \frac{\sec(x) \sec^2(z)}{\sqrt{\cos(2x)} \left(\pi^2 + \log^2\left(\frac{2 \sin(2y) \sin(z) \tan(2x)}{(\cos(y)+\sin(y))^2(\cos(z)-\sin(z))}\right)\right) (\cos(y) + \sin(y)) \sqrt{\sin(2y)}} dz dy dx \\ = \frac{-\psi^{(0)}\left(\frac{5}{8}\right) + \psi^{(0)}\left(\frac{7}{8}\right)}{4\sqrt{2}}$$

EXAMPLE 5.451.

$$(5.455) \quad \int_0^{\frac{\pi}{4}} \int_0^{\frac{\pi}{4}} \int_0^{\frac{\pi}{4}} \frac{\log\left(\frac{2 \sin(2y) \sin(z) \tan(2x)}{(\cos(y)+\sin(y))^2(\cos(z)-\sin(z))}\right) \sec(x) \sec^2(z)}{\sqrt{\cos(2x)} \left(\pi^2 + \log^2\left(\frac{2 \sin(2y) \sin(z) \tan(2x)}{(\cos(y)+\sin(y))^2(\cos(z)-\sin(z))}\right)\right) (\cos(y) + \sin(y)) \sqrt{\sin(2y)}} dz dy dx = 0$$

5.1.27. *Derived using equation (4.76).*

EXAMPLE 5.452.

$$(5.456) \quad \int_0^{\frac{\pi}{2}} \int_0^1 \int_0^{\frac{\pi}{2}} \int_0^1 \frac{1}{\pi^2 + \log^2\left(\frac{\sqrt{\log(y)} \sin(x)}{\sqrt{\log(r)} \sin(z)}\right)} dr dz dy dx = 1 - \frac{\pi}{4}$$



EXAMPLE 5.453.

$$(5.457) \quad \int_0^{\frac{\pi}{2}} \int_0^1 \int_0^{\frac{\pi}{2}} \int_0^1 \frac{-\pi^2 + \log^2 \left( \frac{\sqrt{\log(y)} \sin(x)}{\sqrt{\log(r)} \sin(z)} \right)}{\left( \pi^2 + \log^2 \left( \frac{\sqrt{\log(y)} \sin(x)}{\sqrt{\log(r)} \sin(z)} \right) \right)^2} dr dz dy dx = 2(-1 + C)$$

5.1.28. *Derived using equation (4.77).*

EXAMPLE 5.454.

$$(5.458) \quad \int_0^\infty \int_1^\infty \frac{1 + (-4 + x)x}{(1 + x)^4 \sqrt{-1 + yy} \log(x(1 - y))} dy dx = \frac{i\psi^{(3)}\left(\frac{3}{4}\right)}{64\pi^2}$$

EXAMPLE 5.455.

$$(5.459) \quad \int_0^\infty \int_1^\infty \frac{1}{(1 + x)^2 \sqrt{-1 + yy} (\pi^2 + \log^2(x(-1 + y)))} dy dx = -\frac{2C}{\pi} + \frac{\pi}{4}$$

EXAMPLE 5.456.

$$(5.460) \quad \int_0^\infty \int_1^\infty \frac{1}{(1 + x)^2 \sqrt{-1 + yy} \log(x(1 - y))} dy dx = -\frac{1}{4}i(-8C + \pi^2)$$

5.1.29. *Derived using equation (4.78).*

EXAMPLE 5.457.

$$(5.461) \quad \int_0^\infty \int_0^\infty \int_0^\infty \int_0^\infty \frac{e^{-t^6 - y^6} t^5 y^5 \text{Ai}\left(\frac{x}{2}\right)^2 \text{Ai}\left(\frac{z}{3}\right)^2}{\sqrt{x}\sqrt{z} \left(\pi^2 + \log^2\left(\frac{3xy^2}{2t^2z}\right)\right)} dt dz dy dx = \frac{\log(2)}{216\sqrt{6}\pi^2}$$

EXAMPLE 5.458.

$$(5.462) \quad \int_0^\infty \int_0^\infty \int_0^\infty \int_0^\infty \frac{e^{-t^6 - y^6} t^5 y^5 \text{Ai}\left(\frac{x}{2}\right)^2 \text{Ai}\left(\frac{z}{3}\right)^2}{\sqrt{x}\sqrt{z} \log^2\left(-\frac{3xy^2}{2t^2z}\right)} dt dz dy dx = -\frac{1}{5184\sqrt{6}}$$

EXAMPLE 5.459.

$$(5.463) \quad \int_0^\infty \int_0^\infty \int_0^\infty \int_0^\infty \frac{e^{-t^6 - y^6} t^5 y^5 \text{Ai}\left(\frac{x}{2}\right)^2 \text{Ai}\left(\frac{z}{3}\right)^2}{\sqrt{x}\sqrt{z} \log^3\left(-\frac{3xy^2}{2t^2z}\right)} dt dz dy dx = \frac{i\zeta(3)}{1152\sqrt{6}\pi^3}$$

5.1.30. *Derived using equations (4.79) and (4.80).*

EXAMPLE 5.460.

$$(5.464) \quad \int_0^1 \int_0^1 \frac{\log\left(-\frac{\sqrt{-1+\frac{1}{y}}}{x}\right) + x \log\left(-x\sqrt{-1+\frac{1}{y}}\right)}{\sqrt{x}(1+x^2) \sqrt[4]{-1+\frac{1}{y}} \log\left(-\frac{\sqrt{-1+\frac{1}{y}}}{x}\right) \log\left(-x\sqrt{-1+\frac{1}{y}}\right)} dy dx \\ = -\frac{1}{48}\pi(\pi + 12i \log(2))$$

EXAMPLE 5.461.

$$\begin{aligned}
(5.465) \quad & \int_0^1 \int_0^1 \frac{\log\left(\frac{-1+y}{xy}\right) \log\left(\log\left(\frac{-1+y}{xy}\right)\right) + \log\left(\frac{x(-1+y)}{y}\right) \log\left(\log\left(\frac{x(-1+y)}{y}\right)\right)}{\sqrt{x}(1+x)} dy dx \\
& = i\pi^2 \left( 1 + \frac{i\pi}{2} + \log(4) + \log(\pi) + 4 \left( i\pi - \log(4) - \frac{1}{2} \log(2\pi) + \log\Gamma\left(-\frac{1}{4}\right) \right) \right)
\end{aligned}$$

EXAMPLE 5.462.

$$(5.466) \quad \int_0^1 \int_0^1 \frac{\frac{1}{x+\frac{x}{-1+y}} + \frac{1}{\log\left(x-\frac{x}{y}\right)}}{\sqrt{x}(1+x)} dy dx = \frac{\pi^2 - 8C}{4i}$$

EXAMPLE 5.463.

$$\begin{aligned}
(5.467) \quad & \int_0^1 \int_0^1 \frac{y^s \left( \frac{x \log\left(\log\left(-\frac{\sqrt{-1+y^{-1-s}}}{x}\right)\right)}{\log\left(-\frac{\sqrt{-1+y^{-1-s}}}{x}\right)} + \frac{\log\left(\log\left(-x\sqrt{-1+y^{-1-s}}\right)\right)}{\log\left(-x\sqrt{-1+y^{-1-s}}\right)} \right)}{\sqrt{x}(1+x^2) \sqrt[4]{-1+y^{-1-s}}} dy dx \\
& = \frac{-i\pi^3 + 12i\pi \log(2)(2\gamma - \log(8) - 2\log(\pi)) + \pi^2(2 + \log(4096) - 2\log(\pi)) + 12\zeta'(2)}{96(1+s)}
\end{aligned}$$

EXAMPLE 5.464.

$$\begin{aligned}
(5.468) \quad & \int_0^1 \int_0^1 \int_0^1 \frac{z^s \sqrt[4]{-1+z^{-1-s}} \log^k\left(\frac{a(-1+z^{-1-s}) \log(x)}{\log(y)}\right)}{\sqrt[4]{\log(x)} \log^{\frac{3}{4}}(y)} dz dy dx \\
& = \frac{i^k 2^{-1+3k} \pi^{1+k}}{1+s} \left( ik \left( \zeta\left(1-k, \frac{1}{4} - \frac{i \log(a)}{8\pi}\right) - \zeta\left(1-k, \frac{3}{4} - \frac{i \log(a)}{8\pi}\right) \right) \right. \\
& \quad \left. + 2\pi \left( -\zeta\left(-k, \frac{1}{4} - \frac{i \log(a)}{8\pi}\right) + \zeta\left(-k, \frac{3}{4} - \frac{i \log(a)}{8\pi}\right) \right) \right)
\end{aligned}$$

EXAMPLE 5.465.

$$\begin{aligned}
(5.469) \quad & \int_0^1 \int_0^1 \int_0^1 \frac{z^s \sqrt[4]{-1+z^{-1-s}} \log\left(\log\left(\frac{a(-1+z^{-1-s}) \log(x)}{\log(y)}\right)\right)}{\sqrt[4]{\log(x)} \log^{\frac{3}{4}}(y)} dz dy dx \\
& = \frac{\pi}{4(1+s)} \left( \pi \left( -i\pi + \log\left(\frac{1}{64\pi^2}\right) + 4\log(-6\pi - i \log(a)) - 4\log(-2\pi - i \log(a)) \right) \right. \\
& \quad \left. + 4\pi \log\Gamma\left(-\frac{3}{4} - \frac{i \log(a)}{8\pi}\right) - 4\pi \log\Gamma\left(-\frac{1}{4} - \frac{i \log(a)}{8\pi}\right) \right. \\
& \quad \left. - 2i\psi^{(0)}\left(\frac{1}{4} - \frac{i \log(a)}{8\pi}\right) + 2i\psi^{(0)}\left(\frac{3}{4} - \frac{i \log(a)}{8\pi}\right) \right)
\end{aligned}$$

EXAMPLE 5.466.

(5.470)

$$\begin{aligned} & \int_0^1 \int_0^1 \int_0^1 \frac{z^s \sqrt[4]{-1+z^{-1-s}} \log\left(\frac{a(-1+z^{-1-s})\log(x)}{\log(y)}\right) \log\left(\log\left(\frac{a(-1+z^{-1-s})\log(x)}{\log(y)}\right)\right)}{\sqrt[4]{\log(x)} \log^{\frac{3}{4}}(y)} dz dy dx \\ &= \frac{\pi^2}{4(1+s)} \left( -8 - 4i\pi + \log\left(\frac{1}{16777216\pi^8}\right) + \log(a) \left( -i\pi + \log\left(\frac{1}{64\pi^2}\right) \right) \right. \\ & \quad + 16 \log(-6\pi - i \log(a)) - 16 \log(-2\pi - i \log(a)) + 16 \log \Gamma\left(-\frac{3}{4} - \frac{i \log(a)}{8\pi}\right) \\ & \quad \left. - 16 \log \Gamma\left(-\frac{1}{4} - \frac{i \log(a)}{8\pi}\right) + 32i\pi \left( \zeta'\left(-1, \frac{1}{4} - \frac{i \log(a)}{8\pi}\right) - \zeta'\left(-1, \frac{3}{4} - \frac{i \log(a)}{8\pi}\right) \right) \right) \end{aligned}$$

EXAMPLE 5.467.

$$\begin{aligned} (5.471) \quad & \int_0^1 \int_0^1 \int_0^1 \frac{z^s \sqrt[8]{-1+z^{-1-s}} \log\left(\log\left(-\frac{(-1+z^{-1-s})\log(x)}{\log(y)}\right)\right)}{\log^{\frac{3}{8}}(x) \log^{\frac{5}{8}}(y)} dz dy dx \\ &= \frac{\pi}{12\sqrt{2}(1+s)} \left( (16 + 16i) {}_2F_1\left(\frac{3}{4}, 1; \frac{7}{4}; i\right) - 3i\pi(\pi - 2i \log(4\pi)) \right. \\ & \quad \left. + (2 + 2i) \left( \log\left(\Gamma\left(\frac{3}{16}\right)\right) - \log\left(2\Gamma\left(\frac{11}{16}\right)\right) - i \log\left(\frac{2\Gamma\left(\frac{15}{16}\right)}{\Gamma\left(\frac{7}{16}\right)}\right) \right) \right) \end{aligned}$$

EXAMPLE 5.468.

(5.472)

$$\begin{aligned} & \int_0^1 \int_0^1 \int_0^1 \frac{z^s (-1+z^{-1-s})^{-m} \log^{-\frac{1}{2}-m}(x) \log^{-\frac{1}{2}-m}(y) \left( -(-1+z^{-1-s})^{2m} \log^{2m}(x) + \log^{2m}(y) \right)}{\log\left(\frac{(-1+z^{-1-s})\log(x)}{\log(y)}\right)} dz dy dx \\ &= \frac{1}{4(1+s)} \left( -8m\pi (\coth^{-1}(e^{2im\pi}) + \tanh^{-1}(e^{2im\pi})) \right. \\ & \quad \left. + ie^{-2im\pi} \left( \Phi\left(e^{-4im\pi}, 2, \frac{1}{2}\right) - e^{4im\pi} \Phi\left(e^{4im\pi}, 2, \frac{1}{2}\right) \right) \right) \end{aligned}$$

EXAMPLE 5.469.

(5.473)

$$\int_0^1 \int_0^1 \int_0^1 \frac{z^s \left( -\sqrt{-1+z^{-1-s}} \sqrt{\log(x)} + \sqrt{\log(y)} \right)}{\sqrt[4]{-1+z^{-1-s}} \log^{\frac{3}{4}}(x) \log^{\frac{3}{4}}(y) \log\left(\frac{(-1+z^{-1-s})\log(x)}{\log(y)}\right)} dz dy dx = \frac{2C}{1+s}$$

EXAMPLE 5.470.

(5.474)

$$\int_0^1 \int_0^1 \int_0^1 \frac{z^s \left( \sqrt{-1+z^{-1-s}} \sqrt{\log(x)} - \sqrt{\log(y)} \right)}{\sqrt[4]{-1+z^{-1-s}} \log^{\frac{3}{4}}(x) \log^{\frac{3}{4}}(y) \log\left(\frac{(-1+z^{-1-s})\log(x)}{\log(y)}\right)} dz dy dx = -\frac{2C}{1+s}$$

EXAMPLE 5.471.

$$\begin{aligned}
(5.475) \quad & \int_0^1 \int_0^1 \int_0^1 \frac{z^s \sqrt[4]{-1+z^{-1-s}} \log \left( \log \left( -\frac{(-1+z^{-1-s}) \log(x)}{\log(y)} \right) \right)}{\sqrt[4]{\log(x)} \log^{\frac{3}{4}}(y)} dz dy dx \\
&= \frac{\pi(-4i\sqrt{2} \log(\cot(\frac{\pi}{8})) + \pi(2i\sqrt{2} - i\pi - 2\log(4\pi) + 4\Phi'(-1, 0, \frac{3}{4})))}{4(1+s)}
\end{aligned}$$

EXAMPLE 5.472.

$$(5.476) \quad \int_0^1 \int_0^1 \int_0^1 \frac{z^s \log^k \left( \frac{a(-1+z^{-1-s}) \log(x)}{\log(y)} \right)}{\sqrt{\log(x)} \sqrt{\log(y)}} dz dy dx = \frac{(4i)^k k \pi^{1+k} \zeta \left( 1 - k, \frac{1}{2} - \frac{i \log(a)}{4\pi} \right)}{1+s}$$

EXAMPLE 5.473.

$$(5.477) \quad \int_0^1 \int_0^1 \int_0^1 \frac{z^s}{\sqrt{\log(x)} \sqrt{\log(y)} \left( a + ib + \log \left( \frac{(-1+z^{-1-s}) \log(x)}{\log(y)} \right) \right)} dz dy dx = \frac{i\psi^{(1)} \left( \frac{-ia+b+2\pi}{4\pi} \right)}{4(1+s)}$$

EXAMPLE 5.474.

$$\begin{aligned}
(5.478) \quad & \int_0^1 \int_0^1 \int_0^1 \frac{z^s}{\sqrt{\log(x)} \sqrt{\log(y)} \left( a^2 + b^2 - 2ib \log \left( \frac{(-1+z^{-1-s}) \log(x)}{\log(y)} \right) - \log^2 \left( \frac{(-1+z^{-1-s}) \log(x)}{\log(y)} \right) \right)} dz dy dx \\
&= -\frac{i \left( -\psi^{(1)} \left( \frac{-ia+b+2\pi}{4\pi} \right) + \psi^{(1)} \left( \frac{ia+b+2\pi}{4\pi} \right) \right)}{8a(1+s)}
\end{aligned}$$

EXAMPLE 5.475.

$$\begin{aligned}
(5.479) \quad & \int_0^1 \int_0^1 \int_0^1 \frac{z^s}{\sqrt{\log(x)} \sqrt{\log(y)} \left( 3\pi^2 + 4i\pi \log \left( \frac{(-1+z^{-1-s}) \log(x)}{\log(y)} \right) - \log^2 \left( \frac{(-1+z^{-1-s}) \log(x)}{\log(y)} \right) \right)} dz dy dx \\
&= \frac{2(-1+C)}{\pi(1+s)}
\end{aligned}$$

EXAMPLE 5.476.

$$\begin{aligned}
(5.480) \quad & \int_0^1 \int_0^1 \int_0^1 \frac{z^s \log \left( \frac{a(-1+z^{-1-s}) \log(x)}{\log(y)} \right) \log \left( \log \left( \frac{a(-1+z^{-1-s}) \log(x)}{\log(y)} \right) \right)}{\sqrt{\log(x)} \sqrt{\log(y)}} dz dy dx \\
&= \frac{\pi}{2(1+s)} (\log(a)(-i\pi - 2(1 + \log(4) + \log(\pi))) \\
&\quad - 8i\pi \left( -\frac{1}{2} \log(2\pi) + \log \left( -\frac{1}{2} - \frac{i \log(a)}{4\pi} \right) + \log \Gamma \left( -\frac{1}{2} - \frac{i \log(a)}{4\pi} \right) \right))
\end{aligned}$$

EXAMPLE 5.477.

$$(5.481) \quad \int_0^1 \int_0^1 \int_0^1 \frac{z^s \left( \log \left( -a + ib + \log \left( \frac{(-1+z^{-1-s}) \log(x)}{\log(y)} \right) \right) + \log \left( a + ib + \log \left( \frac{(-1+z^{-1-s}) \log(x)}{\log(y)} \right) \right) \right)}{\sqrt{\log(x)} \sqrt{\log(y)}} dz dy dx$$

$$= - \frac{\pi \left( i\pi + 2 \log(4\pi) + \psi^{(0)} \left( \frac{-ia+b+2\pi}{4\pi} \right) + \psi^{(0)} \left( \frac{ia+b+2\pi}{4\pi} \right) \right)}{1+s}$$

EXAMPLE 5.478.

$$(5.482) \quad \int_0^1 \int_0^1 \int_0^1 \frac{z^s \log \left( \frac{-a+ib+\log \left( \frac{(-1+z^{-1-s}) \log(x)}{\log(y)} \right)}{a+ib+\log \left( \frac{(-1+z^{-1-s}) \log(x)}{\log(y)} \right)} \right)}{\sqrt{\log(x)} \sqrt{\log(y)}} dz dy dx$$

$$= \frac{\pi \left( \psi^{(0)} \left( \frac{-ia+b+2\pi}{4\pi} \right) - \psi^{(0)} \left( \frac{ia+b+2\pi}{4\pi} \right) \right)}{1+s}$$

EXAMPLE 5.479.

**5.2. Products.**

EXAMPLE 5.480.

$$(5.483) \quad \prod_{p=1}^{\infty} \left( 1 - \frac{4ip\pi}{2ip\pi + a\alpha} \right)^{\frac{i\pi}{2\alpha^2} \left( \coth \left( \frac{p\pi^2}{\alpha^2} \right) - 1 \right)} \left( \frac{2a}{a + 2p\alpha} - 1 \right)^{\frac{1}{2} (1 - \coth(p\alpha^2))}$$

$$= \frac{a^{\frac{i(\pi+i\alpha^2)}{2\alpha^2}} e^{\frac{-4\alpha+a\pi(\pi-ia\alpha)}{4a\alpha^2}} \alpha^{\frac{i\pi+2a\alpha+\alpha^2}{2\alpha^2}} \Gamma \left( 1 + \frac{a}{2\alpha} \right)}{\pi^{\frac{a+\alpha}{2\alpha}} \Gamma \left( 1 - \frac{ia\alpha}{2\pi} \right)^{\frac{i\pi}{\alpha^2}}}$$

EXAMPLE 5.481.

$$(5.484) \quad \Gamma \left( \frac{7}{4} \right) = - \frac{\left( \pi^{5/4} \Gamma \left( \frac{\pi-12i}{\pi} \right)^{\frac{i\pi}{16}} \right)}{(-1)^{5/8} 2^{\frac{1}{32}} (112+3i\pi) 3^{\frac{1}{32}} i(16i+\pi) e^{\frac{1}{192}(-8+3\pi^2)}}$$

$$\prod_{p=1}^{\infty} \left( -1 + \frac{6}{3+4p} \right)^{\frac{1}{2}(1-\coth(16p))} \left( 1 + \frac{2p\pi}{12i-p\pi} \right)^{\frac{1}{32} i\pi (-1+\coth(\frac{p\pi^2}{16}))}$$

EXAMPLE 5.482.

$$(5.485) \quad \prod_{p=1}^{\infty} \frac{(a+2ip\beta) e^{-\frac{p\pi\beta}{2\alpha}} \beta (\coth(p\beta^2)-1)}{(a-2ip\beta) e^{\frac{p\pi\beta}{2\alpha}} \beta (\coth(p\beta^2)-1)} \left( \frac{(a-2p\alpha)^{(-1)^p}}{a+2p\alpha} \right)^{i^p \alpha (\coth(p\alpha^2)-1)}$$

$$= 2^{i((3+3i)\alpha+\beta-\beta \coth(\frac{\pi\beta}{4\alpha}))} a^{\frac{i\pi}{2\alpha} + \alpha - i\beta} e^{\frac{1}{2} \pi \beta (\coth(\frac{\pi\beta}{4\alpha}) - 1)} \alpha^{(-1+i)\alpha - i\beta (\coth(\frac{\pi\beta}{4\alpha}) - 1)}$$

$$\exp\left(\frac{2}{a} + 2ie^{-\frac{\pi\beta}{2\alpha}}\beta\Phi'\left(e^{-\frac{\pi\beta}{2\alpha}}, 0, 1 - \frac{ia}{2\beta}\right)\right) \left(\frac{\Gamma\left(\frac{1}{8}\left(4 + \frac{a}{\alpha}\right)\right)}{\Gamma\left(1 + \frac{a}{8\alpha}\right) \left(\frac{\Gamma\left(\frac{1}{8}\left(2 + \frac{a}{\alpha}\right)\right)}{\Gamma\left(\frac{1}{8}\left(6 + \frac{a}{\alpha}\right)\right)}\right)^i}\right)^{2\alpha}$$

EXAMPLE 5.483.

(5.486)

$$\begin{aligned} & \prod_{p=1}^{\infty} \frac{(6ip + 5\pi)e^{-\frac{3p}{2}} \operatorname{csch}(p)}{(5\pi - 6ip)^{ie^{p/2}(\coth(p)-1)}} \left(\frac{(5-6p)^{(-1)^p} \left(\frac{3}{\pi}\right)^{1-(-1)^p}}{5+6p}\right)^{i^p \pi(-1+\coth(p\pi^2))} \\ &= 2^{i(1+(3+3i)\pi-\coth(\frac{1}{4}))} 3^{\frac{i}{2} - \frac{2i}{-1+\sqrt{e}} - (1+2i)\pi - 2\psi_{\sqrt{e}}^{(0)}(1-i\pi) + 2\psi_{\sqrt{e}}^{(0)}(1+i\pi)} 5^{-\frac{i}{2} + \pi} \pi^{\frac{1}{2}i(-1+2\pi)} \\ & \exp\left(\frac{6}{5\pi} + \frac{1}{2}\pi\left(-1 + \coth\left(\frac{1}{4}\right)\right) + \frac{2i\Phi'\left(\frac{1}{\sqrt{e}}, 0, 1 - \frac{5i\pi}{6}\right)}{\sqrt{e}}\right) \\ & \left(\frac{\Gamma\left(\frac{23}{24}\right)}{\Gamma\left(\frac{11}{24}\right)}\right)^{2i\pi} \left(\frac{\Gamma\left(\frac{17}{24}\right)}{\Gamma\left(\frac{29}{24}\right)}\right)^{2\pi} \end{aligned}$$

EXAMPLE 5.484.

$$\begin{aligned} (5.487) \quad & \prod_{\beta=1}^q \sum_{p=1}^{\infty} p \left(-\beta^4 + \pi^2 \coth\left(\frac{\pi^2 p}{\beta^2}\right) + \beta^4 \coth(\beta^2 p) - \pi^2\right) \\ &= \frac{12^{-q}}{\pi^3} \sin\left(\pi\sqrt{3 - i\sqrt{\pi^2 - 9}}\right) \sin\left(\pi\sqrt{3 + i\sqrt{\pi^2 - 9}}\right) \\ & \Gamma\left(q - \sqrt{3 - i\sqrt{-9 + \pi^2}} + 1\right) \Gamma\left(q + \sqrt{3 - i\sqrt{-9 + \pi^2}} + 1\right) \\ & \Gamma\left(q - \sqrt{3 + i\sqrt{-9 + \pi^2}} + 1\right) \Gamma\left(q + \sqrt{3 + i\sqrt{-9 + \pi^2}} + 1\right) \end{aligned}$$

EXAMPLE 5.485. Triple product involving Euler's polynomial.

$$\begin{aligned} (5.488) \quad & \prod_{j=0}^{\infty} \prod_{l=0}^{\infty} \prod_{q=0}^{\infty} \exp\left(\frac{E_q(\alpha)2^{-2(j+l)+q-1} \left(-\frac{1}{x}\right)^{2(j+l)+q} \Gamma(2j+2l+q+1)}{x\Gamma(l+1)\Gamma(q+1)\Gamma(2j+l+2)}\right) \\ &= \frac{2\Gamma\left(\frac{1}{4}(x+2\alpha+3)\right)}{\sqrt{2\alpha+x-1}\Gamma\left(\frac{1}{4}(x+2\alpha+1)\right)} \end{aligned}$$

EXAMPLE 5.486. Infinite product involving Euler's constant  $\gamma$ .

$$(5.489) \quad \prod_{p=1}^{\infty} \left(\frac{(2p+1)^{\frac{1}{2p+1}}}{(2p-1)^{\frac{1}{2p-1}}}\right)^{\frac{(-1)^p}{\pi}} = \frac{3e^{-\frac{\gamma}{2}} \Gamma\left(-\frac{3}{4}\right)}{\sqrt{2\pi} \Gamma\left(-\frac{1}{4}\right)}$$

EXAMPLE 5.487.

$$(5.490) \quad \prod_{k=0}^{n-1} \left(1 - i \cot\left(\frac{k\pi}{n} + ix\right) - \coth\left(\frac{k\pi}{n} + ix\right)\right)$$

$$= \frac{(-1)^n \left(-e^{2ix}; e^{\frac{2\pi}{n}}\right)_n \sin\left(\frac{1}{2}n(\pi + 2ix)\right)}{\left(e^{2ix}; e^{\frac{2\pi}{n}}\right)_n \sinh(nx)}$$

EXAMPLE 5.488.

$$(5.491) \quad \prod_{p=1}^{\infty} \left(\frac{a+ip-1}{a-ip-1}\right)^{i(\coth(\pi p)-1)} \left(\frac{a-p-1}{a+p-1}\right)^{\coth(\pi p)-1} \\ = -\frac{(2\pi)^{1-i}(-i(a-1))^{2i}(a-1)^{-1-i}e^{\frac{1}{\pi(a-1)}+\pi(-\frac{1}{2}+ia)}\Gamma(-i(a-1))^{2i}}{\Gamma(a-1)^2}$$

EXAMPLE 5.489. The exponential of the incomplete gamma function.

$$(5.492) \quad \prod_{p=1}^{\infty} \exp(\Gamma(0, i(p-im)\pi) + \Gamma(0, -i(im+p)\pi)) = \frac{1}{2}(\coth(\pi m) + 1)e^{-\Gamma(0, m\pi)}$$

EXAMPLE 5.490.

$$(5.493) \quad \prod_{p=1}^{\infty} 4^{-\frac{1}{2}i\pi(2a-1)(-1)^p} e^{\frac{m(-1)^{p+1}}{m^2-p^2}} ((m-p)(m+p))^{-\frac{1}{2}i\pi(2a-1)(-1)^p} \\ = e^{\frac{1}{2}(\frac{1}{m}-\pi \csc(\pi m))} \left(\frac{\sin^2\left(\frac{\pi m}{2}\right) \csc(\pi m)}{m}\right)^{\frac{1}{2}i\pi(1-2a)}$$

EXAMPLE 5.491.

$$(5.494) \quad \prod_{p=1}^{\infty} e^{\frac{(-1)^{p+1}}{2(\frac{1}{4}-p^2)}} 4^{-\frac{1}{2}i\pi(2a-1)(-1)^p} \left(\left(\frac{1}{2}-p\right)\left(p+\frac{1}{2}\right)\right)^{-\frac{1}{2}i\pi(2a-1)(-1)^p} = e^{\frac{2-\pi}{2}}$$

EXAMPLE 5.492.

$$(5.495) \quad \prod_{k=1}^n 2e^{\Gamma(0, \pi(\frac{2k}{n} + \frac{x}{\pi}))} \prod_{p=1}^{\infty} \exp\left(\Gamma\left(0, i\pi\left(p - i\left(\frac{2k}{n} + \frac{x}{\pi}\right)\right)\right) + \Gamma\left(0, -i\pi\left(p + i\left(\frac{2k}{n} + \frac{x}{\pi}\right)\right)\right)\right) \\ = \prod_{k=1}^n \left(\coth\left(\pi\left(\frac{2k}{n} + \frac{x}{\pi}\right)\right) + 1\right)$$

EXAMPLE 5.493.

$$(5.496) \quad \prod_{p=0}^{\infty} \exp\left(\frac{(-1)^p e^{-i\pi(2p+1)z} (\Gamma(-1, -i(2p+1)\pi z) + e^{2i\pi(2p+1)z} \Gamma(-1, i(2p+1)\pi z))}{\pi(2p+1)}\right) \\ = \frac{\sqrt{z}\Gamma\left(\frac{z}{2} + \frac{1}{4}\right)}{\sqrt{2}\Gamma\left(\frac{z}{2} + \frac{3}{4}\right)}$$

EXAMPLE 5.494.

(5.497)

$$\prod_{p=0}^{\infty} \exp(\Gamma(-1, ip\pi - \log(q)) + \Gamma(-1, -i\pi(p+1) - \log(q))) = e^{\frac{2q^2}{1-q^2}} (1 - q^2)$$

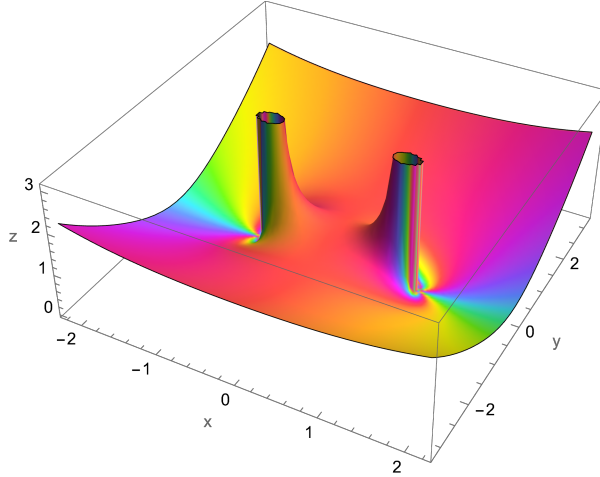

FIGURE 12. Plot of  $f(q) = e^{\frac{2q^2}{1-q^2}} (1 - q^2)$ ,  $q \in \mathbb{C}$ .

EXAMPLE 5.495.

(5.498)

$$\begin{aligned} \prod_{p=0}^{\infty} \exp \left( (-1)^p e^{-2i\pi a(p+1)} \left( \frac{e^{2i\pi a(2p+1)} \Gamma(0, \frac{1}{2}ia(4p+1)\pi)}{4p+1} + \frac{\Gamma(0, -\frac{1}{2}ia(4p+3)\pi)}{4p+3} \right) \right) \\ = \left( 2^{1-i} a^{-\frac{1}{2} + \frac{i}{2}} \right)^{\frac{1}{2}} \sqrt[4]{-1} \pi i^{-a} \left( \frac{\Gamma\left(\frac{a}{4} + \frac{5}{8}\right) \left(\frac{\Gamma\left(\frac{a}{4} + \frac{3}{8}\right)}{\Gamma\left(\frac{a}{4} + \frac{7}{8}\right)}\right)^i}{\Gamma\left(\frac{a}{4} + \frac{1}{8}\right)} \right)^{\frac{1}{2}} \sqrt[4]{-1} \pi i^{-a} \end{aligned}$$

EXAMPLE 5.496.

(5.499)

$$\begin{aligned} \prod_{p=0}^{\infty} \exp \left( \frac{(-1)^p e^{-ia(2p+3)x}}{\pi(2p+1)^2(4p(p+1)-3)} \left( (2p+3)(1-2p)^2 e^{2ia(2p+1)x} \Gamma(-1, ia(2p-1)x) \right. \right. \\ \left. \left. - 8p(2p+3) e^{2ia(2p+1)x} \Gamma(0, ia(2p-1)x) - (2p-1)(2p+1)^2 \Gamma(0, -ia(2p+3)x) \right) \right) \\ = e^{\frac{c}{\pi ia x}} \frac{\sqrt{2\pi} \Gamma\left(\frac{2ax+3\pi}{4\pi}\right)}{\sqrt{ax} \Gamma\left(\frac{2ax+\pi}{4\pi}\right)} \end{aligned}$$

EXAMPLE 5.497.



$$(5.500) \quad \prod_{p=0}^{\infty} \exp \left( \frac{(-1)^p (\pi(1-2p)^2 z E_1(-i(2p+3)\pi z) + i(2p+3)e^{2i\pi(2p+1)z} E_2(i(2p-1)\pi z))}{e^{i\pi(2p+3)z} (2p+3)(\pi-2\pi p)^2 z} \right) \\ = e^{-\frac{i(C-1)}{\pi^2 z}} \frac{\sqrt{z} \Gamma\left(\frac{z}{2} + \frac{1}{4}\right)}{\sqrt{2} \Gamma\left(\frac{z}{2} + \frac{3}{4}\right)}$$

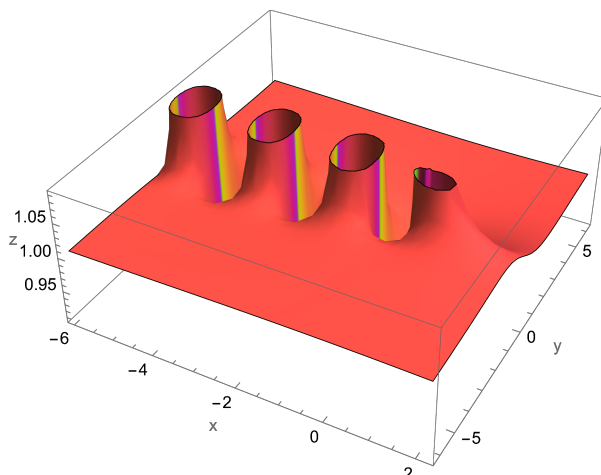

FIGURE 13. Plot of  $f(z) = \frac{\sqrt{2}e^{-\frac{iC}{\pi^2 z}}\Gamma\left(\frac{z}{2} + \frac{3}{4}\right)}{\sqrt{2}\Gamma\left(\frac{z}{2} + \frac{1}{4}\right)}$ ,  $z \in \mathbb{C}$ .

EXAMPLE 5.498.

$$(5.501) \quad \prod_{p=0}^{\infty} \exp \left( \frac{12}{\pi^2} \left( \frac{E_1\left(\frac{1}{2}i(2p-1)\pi\right)}{(1-2p)^2} + \frac{E_1\left(-\frac{1}{2}i(2p+3)\pi\right)}{(2p+3)^2} \right) \right) = \frac{128e^3}{A^{36}}$$

EXAMPLE 5.499.

$$(5.502) \quad \prod_{p=0}^{\infty} \exp \left( \frac{2iE_2\left(\frac{1}{2}i(2p-1)\pi\right)}{\pi(1-2p)^2} - \frac{E_1\left(-\frac{1}{2}i(2p+3)\pi\right)}{2p+3} \right) = 2^{-i\pi} \pi^{\frac{i\pi}{2}} e^{\frac{2(C-1)}{\pi}}$$

EXAMPLE 5.500.

$$(5.503) \quad \prod_{p=0}^{\infty} \exp \left( -\Gamma \left( 0, \frac{i\pi(im+x+2px)}{2x} \right) + \Gamma \left( 0, \frac{i\pi(ir+x+2px)}{2x} \right) \right. \\ \left. -\Gamma \left( 0, -\frac{\pi(m+i(x+2px))}{2x} \right) + \Gamma \left( 0, -\frac{\pi(r+i(x+2px))}{2x} \right) \right) \\ = e^{\frac{\pi(m-r)}{2x}} \frac{\cosh\left(\frac{m\pi}{2x}\right)}{\cosh\left(\frac{\pi r}{2x}\right)}$$

EXAMPLE 5.501.

$$\begin{aligned}
(5.504) \quad & \prod_{p=0}^{\infty} \exp \left( \Gamma \left( 0, \frac{i\pi (2px + x - \frac{i}{x})}{2x} \right) - \Gamma \left( 0, \frac{i\pi (2px + x + \frac{i}{x})}{2x} \right) \right) \\
& + \Gamma \left( 0, -\frac{\pi (i(2px + x) - \frac{1}{x})}{2x} \right) - \Gamma \left( 0, -\frac{\pi (i(2px + x) + \frac{1}{x})}{2x} \right) \Bigg) \\
& = e^{\frac{\pi}{x^2}}
\end{aligned}$$

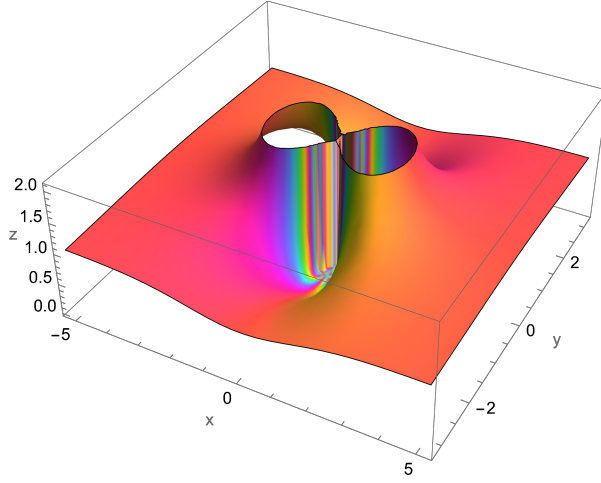
FIGURE 14. Plot of  $f(x) = e^{\frac{\pi}{x^2}}$ ,  $x \in \mathbb{C}$ .

EXAMPLE 5.502.

$$(5.505) \quad \prod_{p=0}^{\infty} \exp \left( \frac{(-1)^p \left(\frac{i}{a\pi}\right)^{2p} E_{2p+1}(x)}{(a\pi)(2p+1)} \right) = \frac{\Gamma\left(\frac{1}{2}(1+a\pi-x)\right) \Gamma\left(\frac{1}{2}(1+a\pi+x)\right)}{\Gamma\left(\frac{1}{2}(2+a\pi-x)\right) \Gamma\left(\frac{1}{2}(a\pi+x)\right)}$$

EXAMPLE 5.503. Asymptotic approximation where  $Re(x) < 0 < Re(a)$ . Similar forms and evaluations are given in the works of section (5.6) in [3].

$$(5.506) \quad \prod_{p=0}^{\infty} \exp \left( \frac{(-1)^p \left(\frac{i}{a\pi}\right)^{2p} E_{1+2p}(2x)}{a\pi(1+2p)} \right) < \frac{x^{\frac{1}{2}-x}}{\sqrt{-x}}$$

EXAMPLE 5.504.

$$\begin{aligned}
(5.507) \quad & \prod_{p=1}^n \left( \frac{\sin^3\left(\frac{1}{2}(1+p)x\right)}{\sin((1+p)x) \sin^2\left(\frac{1}{4}(1+p)x\right)} \right)^{\frac{1}{p+1}} \left( \frac{\sin((2+p)x) \sin^2\left(\frac{1}{4}(2+p)x\right)}{\sin^3\left(\frac{1}{2}(2+p)x\right)} \right)^{\frac{1}{p+2}} \\
& = \frac{\csc\left(\frac{x}{2}\right) \sin^{\frac{3}{2}}(x) \left( \frac{\tan\left(\frac{1}{4}(2+n)x\right)}{\tan\left(\frac{1}{2}(2+n)x\right)} \right)^{\frac{1}{2+n}}}{\sqrt{\sin(2x)}}
\end{aligned}$$

EXAMPLE 5.505.

$$(5.508) \quad \prod_{p=1}^n \left( \frac{\sin((1+p)q)}{\sin(m(1+p))} \right)^{\frac{1}{1+p}} \left( \frac{\sin(m(2+p))}{\sin((2+p)q)} \right)^{\frac{1}{2+p}}$$

$$= e^{-i(m-q)} \left( \frac{e^{i(2+n)(m-q)} \sin(m(2+n))}{\sin((2+n)q)} \right)^{\frac{1}{2+n}} \sqrt{\frac{\cos(q) \sin(q)}{\sin(m) \cos(m)}}$$

EXAMPLE 5.506.

$$(5.509) \quad \prod_{p=1}^n \frac{\sin^{\frac{3}{1+p}} \left( \frac{1}{2}(1+p)x \right) \sin^{\frac{2}{2+p}} \left( \frac{1}{4}(2+p)x \right) {}^{2+p}\sqrt{\sin((2+p)x)}}{\sin^{\frac{3}{2+p}} \left( \frac{1}{2}(2+p)x \right) {}^{1+p}\sqrt{\sin((1+p)x)} \sin^{\frac{2}{1+p}} \left( \frac{1}{4}(1+p)x \right)}$$

$$= \frac{\csc\left(\frac{x}{2}\right) \sin^{\frac{3}{2}}(x) \left( \frac{\tan\left(\frac{1}{4}(2+n)x\right)}{\tan\left(\frac{1}{2}(2+n)x\right)} \right)^{\frac{1}{2+n}}}{\sqrt{\sin(2x)}}$$

EXAMPLE 5.507.

$$(5.510) \quad \prod_{p=1}^n \sqrt{\frac{2+p}{1+p}} \left( \frac{(1+p)^{\frac{1}{1+p}}}{(2+p)^{\frac{1}{2+p}}} \right)^{2a} \frac{\Gamma\left(\frac{2a}{1+p}\right)}{\Gamma\left(\frac{2a}{2+p}\right)} = \sqrt{\frac{2+n}{2}} \left( \frac{2}{(2+n)^{\frac{2}{2+n}}} \right)^a \frac{\Gamma(a)}{\Gamma\left(\frac{2a}{2+n}\right)}$$

EXAMPLE 5.508.

$$(5.511) \quad \frac{\prod_{p=0}^n \Gamma\left(\frac{1}{2}(4^{-p}x+1)\right)^2}{\prod_{p=0}^{2n} \Gamma\left(\frac{1}{2}(2^{-p}x-1)\right)^{(-1)^p}} = \frac{\pi^{n+\frac{1}{2}}(x-1)2^{(4^{-n}-2)x+2n}\Gamma(x)\left(\frac{x}{4}; \frac{1}{4}\right)_{[n]}}{\Gamma(2^{-2n-1}x)\left(\frac{x}{2}; \frac{1}{4}\right)_{[n-\frac{1}{2}]+1}}$$

EXAMPLE 5.509.

$$(5.512) \quad \prod_{p=0}^{2n} \left( \frac{\tan(2^{-1+p}r)}{\tan(2^{-1+p}m)} \right)^{\left(-\frac{1}{2}\right)^p} \prod_{p=0}^n \left( \frac{\tan(2^{-1+2p}m)}{\tan(2^{-1+2p}r)} \right)^{2^{1-2p}}$$

$$= \left( \frac{\sin\left(\frac{m}{2}\right)}{\sin\left(\frac{r}{2}\right)} \right)^2 e^{i(m-r)} \left( \frac{e^{-i4^n(m-r)} \sin(4^n r)}{\sin(4^n m)} \right)^{4^{-n}}$$

EXAMPLE 5.510.

$$(5.513) \quad \prod_{p=0}^{2n} \left( 1 - \frac{2}{q^{2^p} + 1} \right)^{\left(-\frac{1}{2}\right)^p} \prod_{p=0}^n \left( \frac{2}{q^{4^p} - 1} + 1 \right)^{2^{1-2p}} = \frac{q^2 \left( 1 - q^{-2^{2n+1}} \right)^{4^{-n}}}{(q-1)^2}$$

EXAMPLE 5.511.

$$(5.514) \quad \prod_{p=0}^n \pi^{-(-1)^{4p}} 2^{(-1)^{4p}} 4^{-p(4pz-3 \ 4^p)} (2^{1-2p}z-1)^{2(-1)^{4p}} \Gamma\left(2^{-2p}z - \frac{1}{2}\right)^{2(-1)^{4p}}$$

$$\begin{aligned} \prod_{p=0}^{2n} \left(2^{-p}z - \frac{1}{2}\right)^{-(-1)^{p+2^p}} \Gamma\left(2^{-p}z - \frac{1}{2}\right)^{-(-1)^{p+2^p}} \\ = \frac{\pi 2^{-\frac{1}{8}2^{1-2n}} (9n+4^n - e^{2i\pi n} (3n+1)) z+n+1 \Gamma(z)}{\Gamma\left(z + \frac{1}{2}\right) \Gamma(4^{-n}z)} \end{aligned}$$

EXAMPLE 5.512.

$$(5.515) \quad \prod_{p=0}^{\infty} \left(\frac{2}{q^{2^p}-1} + 1\right)^{\left(-\frac{1}{2}\right)^p} \prod_{p=0}^{\infty} \left(\frac{2}{q^{4^p}-1} + 1\right)^{-2^{1-2^p}} = \left(1 - \frac{1}{q}\right)^2$$

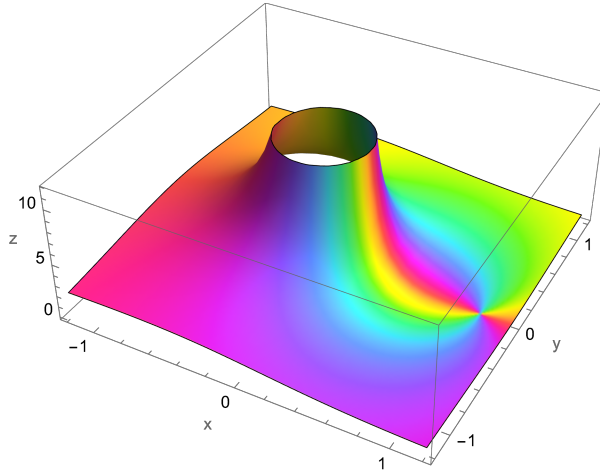

FIGURE 15. Plot of  $f(q) = \left(1 - \frac{1}{q}\right)^2$ ,  $q \in \mathbb{C}$ .

EXAMPLE 5.513.

$$\begin{aligned} (5.516) \quad \prod_{p=0}^n e^{2(\csc(2^{2^p-1}x) - \csc(4^p x))} \left(1 - \frac{1}{2} \sec^2(4^{p-1}x)\right)^{a2^{1-2^p}} \\ \prod_{p=0}^{2n} e^{(-1)^p (\csc(2^p x) - \csc(2^{p-1}x))} (\tan(2^{p-1}x) \cot(2^{p-2}x))^a \left(-\frac{1}{2}\right)^p \\ = \left(\frac{1}{1 + e^{\frac{ix}{2}}}\right)^{2a} \left(1 + e^{i4^n x}\right)^{a4^{-n}} e^{\csc(\frac{x}{2}) - \csc(4^n x)} \end{aligned}$$

EXAMPLE 5.514.

$$\begin{aligned} (5.517) \quad \prod_{p=0}^n \exp\left(\frac{4iq^{4^p}((q^{4^p}-1)q^{4^p}+1)}{q^{4^{p+1}}-1}\right) \left(\frac{q^{2^{2^p+1}}+1}{(q^{4^p}+1)^2}\right)^{2^{1-2^p}z} \\ \prod_{p=0}^{2n} \exp\left(-\frac{2i(-1)^p q^{2^p}((q^{2^p}-1)q^{2^p}+1)}{q^{2^{p+2}}-1}\right) \left(\frac{2q^{2^p}}{q^{2^{p+1}}+1} + 1\right)^{\left(-\frac{1}{2}\right)^p z} \end{aligned}$$

$$= \left( \frac{1}{q+1} \right)^{2z} \exp \left( -2i \left( \frac{q^{2^{2n+1}}}{q^{4^{n+1}} - 1} - \frac{q}{q^2 - 1} \right) \right) \left( q^{2^{2n+1}} + 1 \right)^{4^{-n}z}$$

EXAMPLE 5.515.

$$(5.518) \quad \sum_{q=2}^n \left( \prod_{p=0}^{\infty} \left( \frac{2}{q^{2^p} - 1} + 1 \right)^{\left(-\frac{1}{2}\right)^p} \prod_{p=0}^{\infty} \left( \frac{2}{q^{4^p} - 1} + 1 \right)^{-2^{1-2p}} \right) = -2H_n + H_n^{(2)} + n$$

EXAMPLE 5.516. The exponential of the Polylogarithm function.

$$(5.519) \quad \prod_{p=0}^{2n} e^{\left(-\frac{1}{4}\right)^p (\text{Li}_2(-q^{2^p}) - \text{Li}_2(q^{2^p}))} \prod_{p=0}^n e^{2^{1-4p} (\text{Li}_2(q^{4^p}) - \text{Li}_2(-q^{4^p}))} \\ = e^{2\text{Li}_2(q) - 2^{-4n-1}\text{Li}_2(q^{2^{2n+1}})}$$

EXAMPLE 5.517.

$$(5.520) \quad \prod_{p=0}^{\infty} e^{\left(-\frac{1}{4}\right)^p (\text{Li}_2(-q^{2^p}) - \text{Li}_2(q^{2^p}))} \prod_{p=0}^{\infty} e^{2^{1-4p} (\text{Li}_2(q^{4^p}) - \text{Li}_2(-q^{4^p}))} = e^{2\text{Li}_2(q)}$$

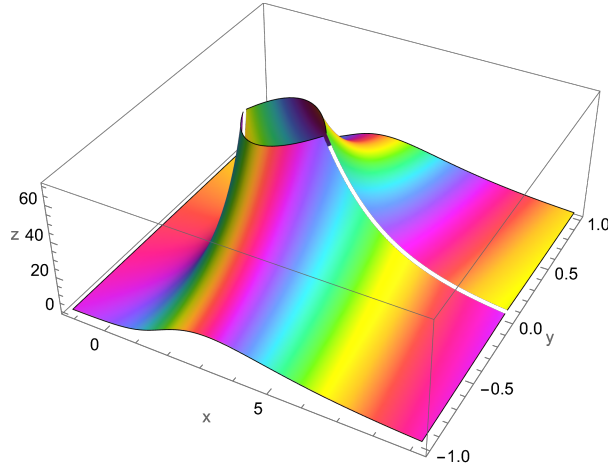

FIGURE 16. Plot of  $f(q) = e^{2\text{Li}_2(q)}$ ,  $q \in \mathbb{C}$ .

EXAMPLE 5.518.

$$(5.521) \quad \prod_{p=0}^{2n} \exp \left( \left( -\frac{1}{2} \right)^{p+1} z^{2^{p+1}-1} \Phi \left( z^{2^{p+2}}, 1, \frac{1}{4} (2 - 2^{-p}) \right) \right) \\ \prod_{p=0}^n \exp \left( 4^{-p} z^{2^{2p+1}-1} \Phi \left( z^{4^{p+1}}, 1, \frac{1}{4} (2 - 4^{-p}) \right) \right) \\ = \left( \frac{1+z}{1-z} \right) \exp \left( -2^{-2n-1} z^{4^{n+1}-1} \Phi \left( z^{4^{n+1}}, 1, 1 - 2^{-2(n+1)} \right) \right)$$

EXAMPLE 5.519.

$$(5.522) \quad \prod_{p=0}^n \left( \frac{\tan(2^p r)}{\tan(2^p m)} \right)^{2^{-p}} = \left( \frac{\sin(r)}{\sin(m)} \right)^2 \left( \frac{\sin(2^{1+n} m)}{\sin(2^{1+n} r)} \right)^{2^{-n}}$$

EXAMPLE 5.520.

$$(5.523) \quad \prod_{p=0}^{\infty} \left( \frac{\tan(2^p r)}{\tan(2^p m)} \right)^{2^{-p-1}} = \frac{\sin(r)}{\sin(m)}$$

EXAMPLE 5.521.

$$(5.524) \quad \prod_{p=0}^n \left( \frac{(m^{2^p} + 1)(r^{2^p} - 1)}{(m^{2^p} - 1)(r^{2^p} + 1)} \right)^{2^{-p}} = \frac{m}{r} \left( \frac{r-1}{m-1} \right)^2 \left( \frac{r^{2^n}(m^{2^{1+n}} - 1)}{m^{2^n}(r^{2^{1+n}} - 1)} \right)^{2^{-n}}$$

EXAMPLE 5.522.

$$(5.525) \quad \prod_{p=0}^{\infty} \left( \frac{q^{2^p} + 1}{q^{2^p} - 1} \right)^{2^{-p}} = \frac{q^2}{(q-1)^2}$$

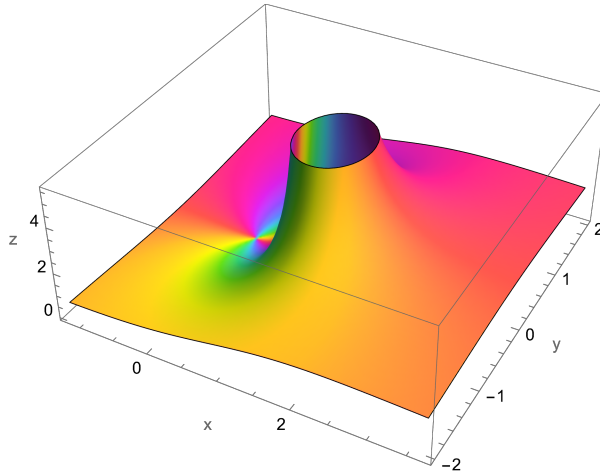
FIGURE 17. Plot of  $f(q) = \frac{q^2}{(q-1)^2}$ ,  $q \in \mathbb{C}$ .

EXAMPLE 5.523.

$$(5.526) \quad \prod_{p=0}^n e^{\csc(2^p z) - \csc(2^{1+p} z)} \left( \frac{\tan(2^{-1+p} z)}{\tan(2^p z)} \right)^{2^{-p} a}$$

$$= \exp \left( \int_{\frac{\pi}{2}}^z \frac{2^{2+n} + 2a \cot(x) - 2 \csc(x) (a \cos(x - 2^{2+n} x) + \csc(x) \sin^2(2^{1+n} x))}{-1 + \cos(2^{2+n} x)} dx \right)$$

EXAMPLE 5.524.

(5.527)

$$\begin{aligned} & \prod_{p=0}^n \exp \left( 2^p \left( (-1 + 4 \cos(2^p z)) \csc^2(2^p z) + \sec^2(2^p z) \right) \left( \frac{\tan(2^p z)}{\tan(2^{-1+p} z)} \right)^{2^{-p} a^2} \right) \\ &= 2^{2^{-n}(-1+2^{1+n})a^2} \exp \left( 2 \csc(z)(2 \cot(z) + \csc(z)) + 2^n (-3 \csc^2(2^n z) + \sec^2(2^n z)) \right) \\ & \qquad \qquad \qquad \cos^{2a^2} \left( \frac{z}{2} \right) \sec^{2^{-n} a^2} (2^n z) \end{aligned}$$

EXAMPLE 5.525.

(5.528)

$$\begin{aligned} & \prod_{p=0}^n \left( \frac{2z^{2^{p-1}}}{z^{2^p} + 1} + 1 \right)^{a^2 2^{-p}} \exp \left( \frac{2^{p+3} z^{2^{p-1}} \left( z^5 2^{p-1} - z^3 2^p + z^{2^{p-1}} - 3z^{2^p} - 3z^{2^{p+1}} - 1 \right)}{(z^{2^{p+1}} - 1)^2} \right) \\ & \qquad \qquad \qquad = \left( \sqrt[4]{z} + \frac{1}{\sqrt[4]{z}} \right)^{2a^2} \left( \frac{z^{2^{n-1}}}{z^{2^n} + 1} \right)^{a^2 2^{-n}} \\ & \exp \left( -8 \left( -\frac{2^{n+1} (z^{2^n} + z^{2^{n+1}} + 1) z^{2^n}}{(z^{2^{n+1}} - 1)^2} + \frac{z^{3/2}}{(z-1)^2} + \frac{z}{(z-1)^2} + \frac{\sqrt{z}}{(z-1)^2} \right) \right) \end{aligned}$$

EXAMPLE 5.526.

(5.529)

$$\begin{aligned} & \prod_{p=0}^{\infty} \left( \frac{2z^{2^{p-1}}}{z^{2^p} + 1} + 1 \right)^{a^2 2^{-p}} \exp \left( \frac{2^{p+3} z^{2^{p-1}} \left( z^5 2^{p-1} - z^3 2^p + z^{2^{p-1}} - 3z^{2^p} - 3z^{2^{p+1}} - 1 \right)}{(z^{2^{p+1}} - 1)^2} \right) \\ & \qquad \qquad \qquad = e^{-\frac{8(z^{3/2} + z + \sqrt{z})}{(z-1)^2}} \left( \sqrt[4]{z} + \frac{1}{\sqrt[4]{z}} \right)^{2a^2} z^{-\frac{a^2}{2}} \end{aligned}$$

EXAMPLE 5.527.

(5.530)

$$\begin{aligned} & \frac{2^{\frac{n}{2}+1} e^{-\frac{1}{4}\pi \cot(\pi 2^{-n-2})} \Gamma(2^{-n-3} a + 1)}{\Gamma\left(\frac{1}{8}(2^{-n} a + 4)\right)} \prod_{p=0}^n (i2^p)_{-1+e^{i\pi 2^{p-n}}}^{e^{i\pi 2^{-n+p-1}}} \\ & \exp \left( \frac{1}{2} e^{i\pi 2^{-n+p-1}} \left( \Phi' \left( -e^{i\pi 2^{-n+p-1}}, 0, a2^{-p-1} + 1 \right) + \Phi' \left( e^{i\pi 2^{-n+p-1}}, 0, a2^{-p-1} + 1 \right) \right) \right) \\ & \qquad \qquad \qquad = \exp \left( e^{i\pi 2^{-n-1}} \Phi' \left( e^{i\pi 2^{-n-1}}, 0, \frac{a}{2} + 1 \right) \right) \end{aligned}$$

EXAMPLE 5.528. For all  $j \in \mathbb{Z}_{\neq 0}$  then,

$$(5.531) \quad \prod_{p=0}^{\infty} \exp \left( \frac{2iE_2 \left( \frac{1}{2} i(-2j + 2p + 1)\pi \right)}{\pi(2j - 2p - 1)} + \Gamma \left( -1, -\frac{1}{2} i(2j + 2p + 1)\pi \right) \right) = \frac{2}{e}$$

EXAMPLE 5.529.

(5.532)

$$\begin{aligned} \prod_{p=0}^{n-1} \exp \left( \frac{i(-1)^p}{4ne^{\frac{im(1+2p)\pi}{2n\alpha}}} \left( -\Phi \left( e^{-\frac{2im\pi}{\alpha}}, 1, \frac{1+2p}{4n} \right) + e^{\frac{im(1-2n+2p)\pi}{n\alpha}} \Phi \left( e^{-\frac{2im\pi}{\alpha}}, 1, 1 - \frac{1+2p}{4n} \right) \right) \right. \\ \left. + e^{\frac{im(1+2p)\pi}{n\alpha}} \Phi \left( e^{\frac{2im\pi}{\alpha}}, 1, \frac{1+2p}{4n} \right) - e^{\frac{2im\pi}{\alpha}} \Phi \left( e^{\frac{2im\pi}{\alpha}}, 1, 1 - \frac{1+2p}{4n} \right) \right) \\ = \cot \left( \frac{\pi(m+n\alpha)}{4n\alpha} \right) \end{aligned}$$

EXAMPLE 5.530.

(5.533)

$$\begin{aligned} \prod_{p=0}^{n-1} \exp \left( \frac{i \csc \left( \frac{m\pi}{n\alpha} \right)}{4ne^{\frac{i\pi(m+2mp-np\alpha)}{n\alpha}}} \left( \Phi \left( e^{-\frac{4im\pi}{\alpha}}, 1, \frac{1+p}{2n} \right) - e^{\frac{2im(1-2n+2p)\pi}{n\alpha}} \Phi \left( e^{-\frac{4im\pi}{\alpha}}, 1, 1 - \frac{p}{2n} \right) \right) \right. \\ \left. - e^{\frac{2im(1+2p)\pi}{n\alpha}} \Phi \left( e^{\frac{4im\pi}{\alpha}}, 1, \frac{1+p}{2n} \right) + e^{\frac{4im\pi}{\alpha}} \Phi \left( e^{\frac{4im\pi}{\alpha}}, 1, 1 - \frac{p}{2n} \right) \right) \\ = \frac{1}{2} e^{\frac{m\pi \cot \left( \frac{m\pi}{n\alpha} \right)}{n\alpha}} \sec \left( \frac{m\pi}{n\alpha} \right) \end{aligned}$$

EXAMPLE 5.531.

(5.534)

$$\begin{aligned} \prod_{p=0}^{n-1} \left( \frac{(1+2p+n(4-2a\alpha))(1+2p+2n(-2+a\alpha))}{(1+2p-2a\alpha)(1+2p+2n(-4+a\alpha))} \right)^{(-1)^p e^{-\frac{ip\pi}{2n}}} \left( -1 + e^{\frac{i(1+2p)\pi}{2n}} \right) \\ \left( \frac{\Gamma \left( -\frac{1+4n+2p-2a\alpha}{8n} \right)}{\Gamma \left( -\frac{1+2p-2a\alpha}{8n} \right)} \right)^{(-1)^p e^{-\frac{ip\pi}{2n}}} \left( -1 + e^{\frac{i(1+2p)\pi}{2n}} \right) \\ \left( \frac{\Gamma \left( \frac{1-4n+2p+2a\alpha}{8n} \right)}{\Gamma \left( -1 + \frac{1+2p+2a\alpha}{8n} \right)} \right)^{(-1)^p e^{-\frac{ip\pi}{2n}}} \left( -1 + e^{\frac{i(1+2p)\pi}{2n}} \right) \\ = \exp \left( \Phi' \left( -e^{-\frac{i\pi}{2n}}, 0, \frac{1}{2} + a\alpha \right) - e^{\frac{i\pi}{2n}} \Phi' \left( -e^{\frac{i\pi}{2n}}, 0, \frac{1}{2} + a\alpha \right) \right) \end{aligned}$$

EXAMPLE 5.532.

$$\begin{aligned} \prod_{p=0}^{n-1} \left( \frac{1}{\Gamma \left( \frac{1+2p+2a\alpha}{4n} \right) \Gamma \left( \frac{-1-2p+2n(2+a\alpha)}{4n} \right)} \right)^{(-1)^{\frac{(-1+n)p}{n}}} \left( -1 + (-1)^{\frac{1+2p}{n}} \right) \\ = \exp \left( \Phi' \left( -(-1)^{-1/n}, 0, \frac{1}{2} + a\alpha \right) - (-1)^{1/n} \Phi' \left( -(-1)^{1/n}, 0, \frac{1}{2} + a\alpha \right) \right) \end{aligned}$$

EXAMPLE 5.533.

$$(5.536) \quad \prod_{p=0}^{n-1} \frac{\Gamma \left( \frac{1}{2} (1+2^p x) \right)}{\Gamma \left( \frac{1}{4} (2+2^p x) \right)^2} = \frac{2^{-n+\frac{1}{2}(-1+2^n)x} \pi^{-\frac{n}{2}} \Gamma \left( \frac{x}{4} \right) \Gamma \left( \frac{1}{4} (2+2^n x) \right)}{\Gamma (2^{-2+n} x) \Gamma \left( \frac{2+x}{4} \right)}$$



EXAMPLE 5.534.

$$(5.537) \quad \prod_{p=0}^{n-1} \left( \frac{q^{2^{-1-p}}}{1+q^{2^{-p}}} \right)^{-2^{1+p}} \left( \frac{1}{q^{-2^{-p}}+q^{2^{-p}}} \right)^{2^p} = \frac{q \left( \frac{1}{q^{-2^{-n}}+q^{2^{-n}}} \right)^{-2^n}}{1+q^2}$$

EXAMPLE 5.535.

$$(5.538) \quad \prod_{p=0}^{n-1} \frac{1}{8\pi^3} \left( \frac{\pi x}{n} - \cos^{-1} \left( \cos \left( \frac{(1+2p)\pi}{2n} \right) \right) \right) \left( \pi \left( -2 + \frac{x}{n} \right) + \cos^{-1} \left( \cos \left( \frac{(1+2p)\pi}{2n} \right) \right) \right) \\ \Gamma \left( \frac{1}{4} \left( -2 + \frac{2x}{n} + \frac{i \left( \pi + 2 \sin^{-1} \left( \cos \left( \frac{(1+2p)\pi}{2n} \right) \right) \right) \sqrt{-1 - \cos \left( \frac{(1+2p)\pi}{2n} \right)}}{\pi \sqrt{1 + \cos \left( \frac{(1+2p)\pi}{2n} \right)}} \right) \right) \\ \Gamma \left( \frac{1}{4} \left( -2 + \frac{2x}{n} + \frac{i \left( \pi + 2 \sin^{-1} \left( \cos \left( \frac{(1+2p)\pi}{2n} \right) \right) \right) \sqrt{1 + \cos \left( \frac{(1+2p)\pi}{2n} \right)}}{\pi \sqrt{-1 - \cos \left( \frac{(1+2p)\pi}{2n} \right)}} \right) \right) \\ = \frac{\Gamma \left( \frac{1}{2} + x \right)}{(2n)^x \sqrt{2\pi}}$$

EXAMPLE 5.536.

$$(5.539) \quad \prod_{j=0}^{\infty} \prod_{n=0}^{\infty} \prod_{p=0}^{\infty} \exp \left( \frac{2^{1+2p} (-t)^{j+2p} t u^n \binom{-1+n+j(-1+\alpha)}{-j+n} E_{1+2p}(x) \Gamma(1+j+2p)}{\Gamma(1+j)\Gamma(2+2p)} \right) \\ = \frac{\Gamma \left( \frac{1}{4} \left( 2 + \frac{1}{t} + (1-u)^{-\alpha} u - 2x \right) \right) \Gamma \left( \frac{1}{4} \left( 2 + \frac{1}{t} + (1-u)^{-\alpha} u + 2x \right) \right)}{\Gamma \left( \frac{1}{4} \left( 4 + \frac{1}{t} + (1-u)^{-\alpha} u - 2x \right) \right) \Gamma \left( \frac{1}{4} \left( \frac{1}{t} + (1-u)^{-\alpha} u + 2x \right) \right)}$$

EXAMPLE 5.537.

$$(5.540) \quad \prod_{p=0}^n \frac{1 + \cos(2^{-p}(b+m))}{1 + \cos(2^{-p}(b-m))} = \left( \frac{\sin(b+m) \sin(2^{-1-n}(b-m))}{\sin(2^{-1-n}(b+m)) \sin(b-m)} \right)^2$$

EXAMPLE 5.538.

$$(5.541) \quad \prod_{p=0}^n \frac{\cos(2^{-1-p}(b+m))}{\cos(2^{-1-p}(b-m))} = \frac{\sin(2^{-1-n}(b-m)) \sin(b+m)}{\sin(b-m) \sin(2^{-1-n}(b+m))}$$

EXAMPLE 5.539.

$$(5.542) \quad \prod_{p=0}^n \exp \left( -2^{-1-p} e^{-i2^{1-p}m} \left( \Phi' \left( -e^{-i2^{1-p}m}, 0, 1 + 2^p a \right) \right. \right. \\ \left. \left. + e^{i2^{2-p}m} \Phi' \left( -e^{i2^{1-p}m}, 0, 1 + 2^p a \right) \right) \right)$$

$$\begin{aligned}
& \left( \frac{\Gamma\left(\frac{1}{2}(1+2^p a)\right)}{\Gamma(1+2^{-1+p} a)} \right)^{2^{-p}} \\
&= \frac{\left( i^a 2^{2-2^{-n}-a(1+n)} \pi^{1-2^{-1-n}} \Gamma(1+2^n a)^{2^{-n}} \right)}{\Gamma\left(\frac{2+a}{2}\right)^2} \\
& \exp\left(-\frac{1}{2} i a \pi + e^{-4im} \Phi'\left(e^{-4im}, 0, 1 + \frac{a}{2}\right) + e^{4im} \Phi'\left(e^{4im}, 0, 1 + \frac{a}{2}\right)\right) \\
& - 2^{-1-n} e^{-i2^{1-n} m} \left( \Phi'\left(e^{-i2^{1-n} m}, 0, 1 + 2^n a\right) + e^{i2^{2-n} m} \Phi'\left(e^{i2^{1-n} m}, 0, 1 + 2^n a\right) \right)
\end{aligned}$$

EXAMPLE 5.540.

$$(5.543) \quad \prod_{p=0}^n \frac{\cos(2^{-p} b) + \cos(2^{-p} m)}{\cos(2^{-1-p} b) + \cos(2^{-1-p} m)} = \frac{\cos(b) + \cos(m)}{\cos(2^{-1-n} b) + \cos(2^{-1-n} m)}$$

EXAMPLE 5.541. See Eq. (1.432) in [4].

$$(5.544) \quad \prod_{p=0}^{\infty} \frac{\cos(2^{-p} b) + \cos(2^{-p} m)}{\cos(2^{-1-p} b) + \cos(2^{-1-p} m)} = \frac{1}{2} (\cos(b) + \cos(m))$$

EXAMPLE 5.542.

$$(5.545) \quad \prod_{p=0}^{\infty} \frac{\cos\left(\frac{2^{-p}}{m}\right) + \cos(2^{-p} m)}{\cos\left(\frac{2^{-1-p}}{m}\right) + \cos(2^{-1-p} m)} = \frac{1}{2} \left( \cos\left(\frac{1}{m}\right) + \cos(m) \right)$$

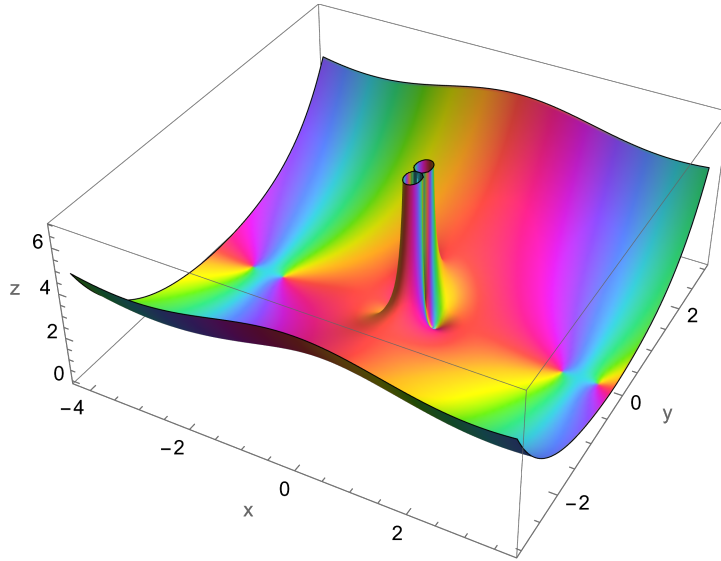

FIGURE 18. Plot of  $f(m) = \frac{1}{2} (\cos(\frac{1}{m}) + \cos(m))$ ,  $m \in \mathbb{C}$ .

EXAMPLE 5.543.

$$(5.546) \quad \prod_{p=0}^{\infty} \frac{q^{-2^{-p}} \left( 1 + q^{2^{2^{-p}}} + 2q^{2^{1-p}} \cosh \left( \frac{2^{-1-p}}{\log(q)} \right) \right)}{1 + q^{2^{1-p}} + 2q^{2^{-p}} \cosh \left( \frac{2^{-2-p}}{\log(q)} \right)} = \frac{1 + q^4 + 2q^2 \cosh \left( \frac{1}{2\log(q)} \right)}{4q^2}$$

EXAMPLE 5.544.

$$(5.547) \quad \prod_{j=1}^{\infty} \frac{\cosh(2^{-j}m) \cosh^2 \left( \frac{2^{-1-j}m}{b} \right) \cosh^4 \left( \frac{2^{-2-j}m}{b} \right)}{\cosh \left( \frac{2^{-j}m}{b} \right) \cosh^2(2^{-1-j}m) \cosh^4(2^{-2-j}m)} \\ = \frac{b^5 \left( \sinh \left( \frac{m}{b} \right) \tanh^2 \left( \frac{m}{4b} \right) \tanh^2 \left( \frac{m}{2b} \right) \right)}{\tanh^2 \left( \frac{m}{4} \right) \tanh^2 \left( \frac{m}{2} \right) \sinh(m)}$$

EXAMPLE 5.545.

$$(5.548) \quad \prod_{j=1}^{\infty} \frac{\cos^4(2^{-4-j}\pi) \cos(2^{-1-j}\pi)}{\cos^2(2^{-3-j}\pi) \cos^3(2^{-2-j}\pi)} = 16 \left( 8 + 7\sqrt{2} - 4\sqrt{10 + 7\sqrt{2}} \right)$$

EXAMPLE 5.546.

$$(5.549) \quad \prod_{j=1}^{\infty} \frac{\cos^4 \left( \frac{1}{3}2^{-3-j}\pi \right) \cos \left( \frac{2^{-j}\pi}{3} \right)}{\cos^2 \left( \frac{1}{3}2^{-2-j}\pi \right) \cos^3 \left( \frac{1}{3}2^{-1-j}\pi \right)} = 32 \left( 24 + 15\sqrt{3} - 2\sqrt{2} \left( 9 + 5\sqrt{3} \right) \right)$$

EXAMPLE 5.547.

$$(5.550) \quad \prod_{j=1}^{\infty} \frac{\cos^4(2^{-5-j}\pi) \cos(2^{-2-j}\pi)}{\cos^2(2^{-4-j}\pi) \cos^3(2^{-3-j}\pi)} = 16 \left( 2 + \sqrt{2} \right)^{3/2} \left( -1 + \frac{4}{2 + \sqrt{2 + \sqrt{2 + \sqrt{2}}}} \right)$$

EXAMPLE 5.548.

$$(5.551) \quad \prod_{j=1}^{\infty} \frac{\cos^4 \left( \frac{1}{5}2^{-3-j}\pi \right) \cos \left( \frac{2^{-j}\pi}{5} \right)}{\cos^2 \left( \frac{1}{5}2^{-2-j}\pi \right) \cos^3 \left( \frac{1}{5}2^{-1-j}\pi \right)} \\ = \frac{-16\sqrt{2} \left( 5 + 3\sqrt{5} \right) + 32\sqrt{5 + \sqrt{5}} \left( -2 + 3\sqrt{2} - \sqrt{5} + \sqrt{10} \right)}{4 + \sqrt{2 \left( 4 + \sqrt{2 \left( 5 + \sqrt{5} \right)} \right)}}$$

EXAMPLE 5.549.

$$(5.552) \quad \prod_{j=1}^{\infty} \frac{\cos^4 \left( \frac{1}{3}2^{-4-j}\pi \right) \cos \left( \frac{1}{3}2^{-1-j}\pi \right)}{\cos^2 \left( \frac{1}{3}2^{-3-j}\pi \right) \cos^3 \left( \frac{1}{3}2^{-2-j}\pi \right)} = 16\sqrt{2} \left( 5 + 3\sqrt{3} \right) \tan^2 \left( \frac{\pi}{48} \right)$$

EXAMPLE 5.550.

$$(5.553) \quad \prod_{j=1}^{\infty} \frac{\left( 1 - 2 \cos(2^{-2-j}\pi) \right)^4 \left( 1 - 2 \cos(2^{-1-j}\pi) \right)^2}{-1 + 2 \cos(2^{-j}\pi)} = \frac{1}{243} \left( -17 - 12\sqrt{2} \right)$$

EXAMPLE 5.551.

$$(5.554) \quad \prod_{j=1}^{\infty} \frac{\cos^2\left(\frac{1}{5}2^{1-j}\pi\right) \cos^5\left(\frac{2^{-j}\pi}{5}\right)}{\cos^4\left(\frac{1}{5}2^{-2-j}\pi\right) \cos^2\left(\frac{1}{5}2^{-1-j}\pi\right) \cos\left(\frac{1}{5}2^{2-j}\pi\right)} = \frac{5\left(95 + 42\sqrt{5} + 2\sqrt{4450 + 1990\sqrt{5}}\right)}{1024}$$

EXAMPLE 5.552.

$$(5.555) \quad \prod_{j=1}^{\infty} \frac{\cos^2\left(\frac{1}{5}2^{1-j}\pi\right) \cos^3\left(\frac{1}{5}2^{2-j}\pi\right)}{\cos\left(\frac{1}{5}2^{3-j}\pi\right) \cos^4\left(\frac{2^{-j}\pi}{5}\right)} = \frac{1}{64}(-1 - \sqrt{5})$$

EXAMPLE 5.553.

$$(5.556) \quad \prod_{j=1}^{\infty} \frac{\cos^2\left(\frac{5}{7}2^{-1-j}\pi\right) \cos^3\left(\frac{5}{7}2^{-j}\pi\right)}{\cos^4\left(\frac{5}{7}2^{-2-j}\pi\right) \cos\left(\frac{5}{7}2^{1-j}\pi\right)} = \frac{\left(\cos\left(\frac{\pi}{28}\right) + \sin\left(\frac{3\pi}{28}\right)\right)^2}{16\sqrt{2}\left(\cos\left(\frac{\pi}{28}\right) - \sin\left(\frac{\pi}{28}\right)\right)\left(-1 + \sin\left(\frac{\pi}{7}\right)\right)}$$

EXAMPLE 5.554.

$$(5.557) \quad \prod_{j=1}^{\infty} \frac{\cos^4\left(\frac{3}{7}2^{-2-j}\pi\right) \cos\left(\frac{3}{7}2^{1-j}\pi\right)}{\cos^2\left(\frac{3}{7}2^{-1-j}\pi\right) \cos^3\left(\frac{3}{7}2^{-j}\pi\right)} \\ = \frac{128\sqrt{2}\left(1 + 2\cos\left(\frac{\pi}{14}\right)\right)^2 \sin^3\left(\frac{\pi}{28}\right)}{-2 + 2\cos\left(\frac{\pi}{14}\right) - 3\cos\left(\frac{\pi}{7}\right) + \cot\left(\frac{\pi}{28}\right) - 3\sin\left(\frac{\pi}{7}\right)}$$

EXAMPLE 5.555.

$$(5.558) \quad \prod_{j=1}^{\infty} \frac{\cos^2\left(\frac{3}{5}2^{1-j}\pi\right) \cos^5\left(\frac{3}{5}2^{-j}\pi\right)}{\cos^4\left(\frac{3}{5}2^{-2-j}\pi\right) \cos^2\left(\frac{3}{5}2^{-1-j}\pi\right) \cos\left(\frac{3}{5}2^{2-j}\pi\right)} \\ = \frac{5\left(95 - 42\sqrt{5} + 2\sqrt{4450 - 1990\sqrt{5}}\right)}{1024}$$

EXAMPLE 5.556.

$$(5.559) \quad \prod_{j=1}^{\infty} \frac{\cos^4\left(\frac{1}{7}2^{-2-j}\pi\right) \cos\left(\frac{1}{7}2^{1-j}\pi\right)}{\cos^2\left(\frac{1}{7}2^{-1-j}\pi\right) \cos^3\left(\frac{2^{-j}\pi}{7}\right)} = \frac{32\left(1 + \sin\left(\frac{3\pi}{14}\right)\right) \tan^2\left(\frac{\pi}{28}\right)}{\cos\left(\frac{\pi}{7}\right) - \sin\left(\frac{\pi}{14}\right)}$$

EXAMPLE 5.557.

$$(5.560) \quad \prod_{j=1}^{\infty} \frac{\cos^3\left(\frac{3}{7}2^{1-j}\pi\right) \cos^2\left(\frac{3}{7}2^{-j}\pi\right)}{\cos^4\left(\frac{3}{7}2^{-1-j}\pi\right) \cos\left(\frac{3}{7}2^{2-j}\pi\right)} = -\frac{\cos^4\left(\frac{\pi}{14}\right)}{2\left(1 + 2\cos\left(\frac{\pi}{7}\right)\right)^3}$$

EXAMPLE 5.558.

$$(5.561) \quad -i \prod_{j=1}^{\infty} \sqrt{\frac{\cos^3\left(\frac{1}{3}2^{1-j}\pi\right) \cos^2\left(\frac{2^{-j}\pi}{3}\right)}{\cos^4\left(\frac{1}{3}2^{-1-j}\pi\right) \cos\left(\frac{1}{3}2^{2-j}\pi\right)}} = \frac{3}{4\sqrt{2}}$$

EXAMPLE 5.559.

$$(5.562) \quad -i \prod_{j=1}^{\infty} \frac{\cos(2^{-1-j}\pi) \cos^4(2^{-4-j}\pi)}{\cos^2(2^{-3-j}\pi) \cos^3(2^{-2-j}\pi)} = 16 \left( 8 + 7\sqrt{2} - 4\sqrt{10 + 7\sqrt{2}} \right)$$

EXAMPLE 5.560.

$$(5.563) \quad \prod_{j=1}^{\infty} \frac{e^{2^{-j}(-m+r)} (\cosh(2^{-j}m) \cosh^2(2^{-1-j}r) \cosh^4(2^{-2-j}r))}{\cosh(2^{-j}r) \cosh^2(2^{-1-j}m) \cosh^4(2^{-2-j}m)}$$

$$= \frac{e^{-m+r} m^5 (\sinh(m) \sinh^2(\frac{r}{2}) \sinh^4(\frac{r}{4}))}{r^5 (\sinh(r) \sinh^2(\frac{m}{2}) \sinh^4(\frac{m}{4}))}$$

EXAMPLE 5.561.

$$(5.564) \quad \prod_{j=1}^{\infty} \cos^4(2^{-4-j}\pi) \cos(2^{-1-j}\pi) \sec^2(2^{-3-j}\pi) \sec^3(2^{-2-j}\pi)$$

$$= 64\sqrt{2} \csc^2\left(\frac{\pi}{8}\right) \sin^4\left(\frac{\pi}{16}\right)$$

EXAMPLE 5.562.

$$(5.565) \quad \prod_{j=1}^{\infty} \cos^4(2^{-4-j}\pi) \cos^2(2^{-3-j}\pi) \cos\left(\frac{2^{-j}\pi}{3}\right)$$

$$\sec^4\left(\frac{1}{3}2^{-2-j}\pi\right) \sec(2^{-2-j}\pi) \sec^2\left(\frac{1}{3}2^{-1-j}\pi\right)$$

$$= \frac{8192}{81} \sqrt{\frac{2}{3}} (1 + \sqrt{3})^4 \sin^4\left(\frac{\pi}{16}\right) \sin^2\left(\frac{\pi}{8}\right)$$

EXAMPLE 5.563.

$$(5.566) \quad \prod_{j=1}^{\infty} \cos^4\left(\frac{1}{3}2^{-3-j}\pi\right) \cos\left(\frac{2^{-j}\pi}{3}\right) \sec^2\left(\frac{1}{3}2^{-2-j}\pi\right) \sec^3\left(\frac{1}{3}2^{-1-j}\pi\right)$$

$$= 512 (3 + 2\sqrt{3}) \sin^4\left(\frac{\pi}{24}\right)$$

EXAMPLE 5.564.

$$(5.567) \quad \prod_{j=1}^{\infty} \cos^4\left(\frac{1}{3}2^{-3-j}\pi\right) \cos^2\left(\frac{1}{3}2^{-2-j}\pi\right) \cos(2^{-2-j}\pi)$$

$$\sec^4(2^{-4-j}\pi) \sec^2(2^{-3-j}\pi) \sec\left(\frac{1}{3}2^{-1-j}\pi\right)$$

$$= \frac{243}{64} \sqrt{\frac{7}{2}} - 2\sqrt{3} \csc^4\left(\frac{\pi}{16}\right) \csc^2\left(\frac{\pi}{8}\right) \sin^4\left(\frac{\pi}{24}\right)$$

EXAMPLE 5.565.

$$(5.568) \quad \prod_{j=1}^{\infty} \sqrt{\frac{\left(1 - 2 \cos\left(\frac{2^{-j}\pi}{3}\right)\right)^2}{\left(1 - 2 \cos\left(\frac{1}{3}2^{-2-j}\pi\right)\right)^8 \left(1 - 2 \cos\left(\frac{1}{3}2^{-1-j}\pi\right)\right)^4}} \\ = \sqrt{59049 \left(7 - 4\sqrt{3}\right) \csc^8\left(\frac{\pi}{8}\right) \sin^8\left(\frac{\pi}{24}\right)}$$

EXAMPLE 5.566.

$$(5.569) \quad \prod_{j=1}^n \frac{e^{2^{2-j}(-m+r)} \left(\cosh(2^{2-j}m) \cosh^2(2^{1-j}r) \cosh^4(2^{-j}r)\right)}{\cosh(2^{2-j}r) \cosh^2(2^{1-j}m) \cosh^4(2^{-j}m)} \\ \frac{e^{4(-1+2^{-n})(m-r)} \left(\cosh(2m) \cosh(2^{-n}m) \cosh(r) \cosh(2^{1-n}r) \sinh^5(2^{-n}m) \sinh^5(r)\right)}{\cosh(m) \cosh(2^{1-n}m) \cosh(2r) \cosh(2^{-n}r) \sinh^5(m) \sinh^5(2^{-n}r)}$$

EXAMPLE 5.567.

$$(5.570) \quad \prod_{p=0}^{n-1} \left(\frac{1 - \cos(2^{-1-p}m)}{1 + \cos(2^{-1-p}m)}\right)^{2^p} = \frac{2^{-1+2^n} (1 - \cos(2^{-n}m))^{2^n}}{1 - \cos(m)}$$

EXAMPLE 5.568.

$$(5.571) \quad \prod_{p=0}^{n-1} \exp\left(i4^p e^{-i2^{-1-p}m} \left(\Phi\left(e^{-i2^{-p}m}, 2, \frac{1}{2}\right) - e^{i2^{-p}m} \Phi\left(e^{i2^{-p}m}, 2, \frac{1}{2}\right)\right)\right) \\ \tan^{2^{1+p}m}(2^{-2-p}m) \\ = \exp\left(-i\left(\text{Li}_2(e^{-im}) - \text{Li}_2(e^{im}) + 4^n \left(-\text{Li}_2(e^{-i2^{-n}m}) + \text{Li}_2(e^{i2^{-n}m})\right)\right)\right) \\ \left(\frac{(2 - 2 \cos(2^{-n}m))^{2^n}}{2 - 2 \cos(m)}\right)^m$$

EXAMPLE 5.569.

$$(5.572) \quad \prod_{p=0}^{n-1} \Gamma\left(\frac{1}{6} + 2^p x\right) \Gamma\left(\frac{5}{6} + 2^p x\right) = \frac{2^{n-4(-1+2^n)x} 27^{x-2^n x} \pi^n \Gamma(x) \Gamma(3 \times 2^n x)}{\Gamma(3x) \Gamma(2^n x)}$$

EXAMPLE 5.570.

$$(5.573) \quad \prod_{p=1}^n \frac{2(-1)^{-2^{1-p}x} (2^{1+p})^{-2^{1-p}x} \pi}{\Gamma\left(\frac{1}{6} + 2^{-p}x\right) \Gamma\left(\frac{5}{6} + 2^{-p}x\right)} \\ = \frac{(-1)^{2^{1-n}x} 2^{-2(1-2^{-n}(1+n))x} 3^{(3-3 \cdot 2^{-n})x} e^{-2i\pi x} \Gamma(x) \Gamma(3 \times 2^{-n}x)}{\Gamma(3x) \Gamma(2^{-n}x)}$$

EXAMPLE 5.571.

$$(5.574) \quad \prod_{p=1}^{\infty} \frac{(-1)^{2^{1-p}x} (2^{1+p})^{2^{1-p}x} \Gamma\left(\frac{1}{6} + 2^{-p}x\right) \Gamma\left(\frac{5}{6} + 2^{-p}x\right)}{2\pi} = \frac{3^{1-3x} 4^x e^{2i\pi x} \Gamma(3x)}{\Gamma(x)}$$

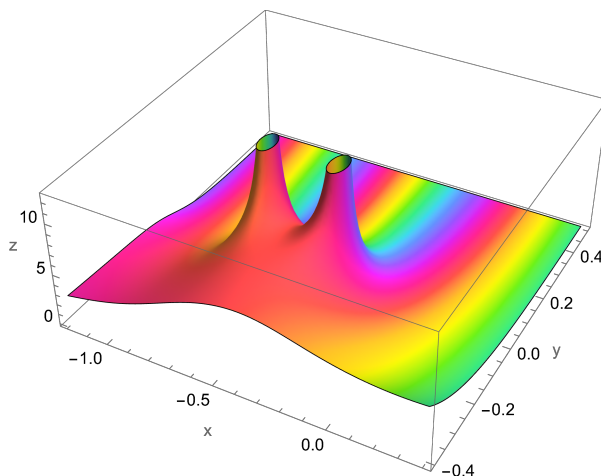

FIGURE 19. Plot of  $f(x) = \frac{3^{1-3x} 4^x e^{2i\pi x} \Gamma(3x)}{\Gamma(x)}$ ,  $x \in \mathbb{C}$ .

EXAMPLE 5.572. Gauss's Multiplication Formula over even numbers.

$$(5.575) \quad \prod_{r=1}^{\frac{n-2}{2}} \Gamma\left(-\frac{r}{n} + z + 1\right) \Gamma\left(\frac{r}{n} + z\right) = \frac{\pi^{\frac{n}{2}-1} 2^{\frac{1}{2}(n+4z-3)} n^{\frac{1}{2}-nz} \Gamma(nz)}{\Gamma(2z)}$$

EXAMPLE 5.573.

$$(5.576) \quad \prod_{r=1}^{\frac{n-2}{2}} \left( \frac{\Gamma\left(\frac{zn+n-r}{2n}\right)}{\Gamma\left(\frac{1}{2}\left(-\frac{r}{n} + z + 2\right)\right)} \right)^{e^{-\frac{i\pi r}{n}}} \left( \frac{\Gamma\left(\frac{zn+n+r}{2n}\right)}{\Gamma\left(\frac{r+nz}{2n}\right)} \right)^{e^{\frac{i\pi r}{n}}} \\ = \frac{2^{-1+e^{\frac{i\pi}{n}}} n^{-1+e^{\frac{i\pi}{n}}} \left( \frac{\Gamma\left(\frac{z}{2} + \frac{1}{4}\right)}{\Gamma\left(\frac{z}{2} + \frac{3}{4}\right)} \right)^i \Gamma\left(\frac{z}{2}\right)}{\Gamma\left(\frac{z+1}{2}\right)} e^{-\Phi'\left(e^{\frac{i\pi}{n}}, 0, nz\right)}$$

EXAMPLE 5.574. Gauss's Multiplication Formula over odd numbers.

$$(5.577) \quad \prod_{r=1}^{\frac{n-1}{2}} \Gamma\left(\frac{1}{2}\left(1 - \frac{2r}{n} + z\right)\right) \Gamma\left(\frac{1}{2}\left(1 + \frac{2r}{n} + z\right)\right) = \frac{n^{-\frac{1}{2}(nz)} (2\pi)^{\frac{1}{2}(-1+n)} \Gamma\left(\frac{1}{2}(1+nz)\right)}{\Gamma\left(\frac{1+z}{2}\right)}$$

EXAMPLE 5.575.

$$(5.578) \quad \prod_{r=1}^{\frac{n-1}{2}} \left( \frac{\Gamma\left(\frac{(3+a-b)n-2r}{4n}\right)}{\Gamma\left(\frac{n+an-bn-2r}{4n}\right)} \right)^{e^{-\frac{i\pi r}{n}}} \left( \frac{\Gamma\left(\frac{(3+a-b)n+2r}{4n}\right)}{\Gamma\left(\frac{n+an-bn+2r}{4n}\right)} \right)^{e^{\frac{i\pi r}{n}}} \\ = \frac{1}{(2n)^{\frac{1}{2} \csc\left(\frac{\pi}{2n}\right)}} \frac{\Gamma\left(\frac{1}{4}(1+a-b)\right)}{\Gamma\left(\frac{1}{4}(3+a-b)\right)} \exp\left(ie^{\frac{i\pi}{2n}} \Phi'\left(e^{\frac{i\pi}{n}}, 0, \frac{1}{2}(1+an-bn)\right)\right)$$

EXAMPLE 5.576.

$$\begin{aligned}
(5.579) \quad & \prod_{r=1}^{\frac{n-1}{2}} \exp \left( e^{-\frac{i\pi mr}{n}} \left( \Phi \left( e^{-im\pi}, 1, \frac{r}{n} + \frac{1}{2} \right) - \Phi \left( e^{im\pi}, 1, \frac{1}{2} - \frac{r}{n} \right) \right. \right. \\
& \quad \left. \left. + e^{\frac{2i\pi mr}{n}} \left( \Phi \left( e^{-im\pi}, 1, \frac{1}{2} - \frac{r}{n} \right) - \Phi \left( e^{im\pi}, 1, \frac{r}{n} + \frac{1}{2} \right) \right) \right) \right) \\
& = \left( -i \tan \left( \frac{\pi m}{4} \right) \right)^{e^{\frac{i\pi m}{2}}} \left( -i \cot \left( \frac{\pi m}{4} \right) \right)^{e^{-\frac{1}{2}i\pi m}} \left( i \tan \left( \frac{\pi m}{4n} \right) \right)^{e^{-\frac{1}{2}i\pi m}} \left( i \cot \left( \frac{\pi m}{4n} \right) \right)^{e^{\frac{i\pi m}{2}n}}
\end{aligned}$$

EXAMPLE 5.577. Gauss's Multiplication Formula over integers.

$$\begin{aligned}
(5.580) \quad & \prod_{r=0}^{n-1} \Gamma \left( a - \frac{2\pi r + t}{2n\pi} + 1 \right) \Gamma \left( a + \frac{2\pi r + t}{2n\pi} \right) \\
& = (2\pi)^{n-1} n^{-2an} \Gamma \left( an - \frac{t}{2\pi} + 1 \right) \Gamma \left( an + \frac{t}{2\pi} \right)
\end{aligned}$$

EXAMPLE 5.578.

$$\begin{aligned}
(5.581) \quad & \prod_{r=0}^{n-1} \left( \frac{\Gamma \left( \frac{2\pi(n+an+r)+t}{4n\pi} \right)}{\Gamma \left( \frac{2\pi(an+r)+t}{4n\pi} \right)} \right)^{e^{\frac{i(\pi r+t)}{n}}} \left( \frac{\Gamma \left( \frac{-2(1+a)n\pi+2\pi r+t}{4n\pi} \right)}{\Gamma \left( \frac{1}{4} \left( 4 + 2a - \frac{2\pi r+t}{n\pi} \right) \right)} \right)^{e^{-\frac{i\pi r}{n}}} \\
& = \exp \left( -e^{\frac{i\pi}{n}} \Phi' \left( e^{\frac{i\pi}{n}}, 0, 1 + an - \frac{t}{2\pi} \right) - e^{\frac{it}{n}} \Phi' \left( e^{\frac{i\pi}{n}}, 0, an + \frac{t}{2\pi} \right) \right) (2n)^{-ie^{\frac{it}{2n}} \cos \left( \frac{\pi-t}{2n} \right) \csc \left( \frac{\pi}{2n} \right)}
\end{aligned}$$

EXAMPLE 5.579.

$$\begin{aligned}
(5.582) \quad & \prod_{r=0}^{n-1} \left( \frac{\Gamma \left( \frac{1}{4} \left( 1 + a - \frac{2\pi r+t}{2n\pi} \right) \right)}{\Gamma \left( \frac{1}{4} \left( 3 + a - \frac{2\pi r+t}{2n\pi} \right) \right)} \right)^{e^{\frac{\pi(n+r)}{2n\pi}}} \left( \frac{\Gamma \left( \frac{1}{4} \left( 2 + a - \frac{2\pi r+t}{2n\pi} \right) \right)}{\Gamma \left( \frac{1}{4} \left( 4 + a - \frac{2\pi r+t}{2n\pi} \right) \right)} \right)^{e^{-\frac{i\pi r}{2n}}} \\
& \quad \left( \frac{\Gamma \left( \frac{2\pi(an+r)+t}{8n\pi} \right)}{\Gamma \left( \frac{1}{4} \left( 2 + a + \frac{r+\frac{t}{2\pi}}{n} \right) \right)} \right)^{-e^{\frac{i(\pi r+t)}{2n}}} \left( \frac{\Gamma \left( \frac{1}{4} \left( 1 + a + \frac{r+\frac{t}{2\pi}}{n} \right) \right)}{\Gamma \left( \frac{1}{4} \left( 3 + a + \frac{r+\frac{t}{2\pi}}{n} \right) \right)} \right)^{\exp \left( \frac{\pi - \frac{\pi r+t}{2i}}{2i} \right)} \\
& = \exp \left( -e^{\frac{i\pi}{2n}} \Phi' \left( e^{\frac{i\pi}{2n}}, 0, 1 + an - \frac{t}{2\pi} \right) - e^{\frac{it}{2n}} \Phi' \left( e^{\frac{i\pi}{2n}}, 0, an + \frac{t}{2\pi} \right) \right) \\
& \quad (4n)^{-ie^{\frac{it}{4n}} \cos \left( \frac{\pi-t}{4n} \right) \csc \left( \frac{\pi}{4n} \right)}
\end{aligned}$$

EXAMPLE 5.580.

$$\begin{aligned}
(5.583) \quad & \prod_{p=1}^{n-1} \left( \frac{\Gamma \left( \frac{an+p}{2n} \right)}{\Gamma \left( \frac{1}{2} \left( 2 + a - \frac{p}{n} \right) \right)} \right)^{(-1)^p \sin \left( \frac{p\pi}{n} \right)} \\
& = (2n)^{-\frac{1}{2} \tan \left( \frac{\pi}{2n} \right)} \exp \left( \frac{1}{2} i e^{-\frac{i\pi}{n}} \left( -\Phi' \left( -e^{-\frac{i\pi}{n}}, 0, 1 + an \right) + e^{\frac{2i\pi}{n}} \Phi' \left( -e^{\frac{i\pi}{n}}, 0, 1 + an \right) \right) \right)
\end{aligned}$$



EXAMPLE 5.581.

$$\begin{aligned}
(5.584) \quad & \prod_{p=1}^{n-1} \exp \left( i(-1)^p e^{-\frac{p\pi(m+r)}{n}} \left( -e^{\frac{\pi(2m(-n+p)+pr)}{n}} \Phi \left( e^{2m\pi}, 1, \frac{p}{2n} \right) \right. \right. \\
& + e^{\frac{p\pi r}{n}} \Phi \left( e^{2m\pi}, 1, 1 - \frac{p}{2n} \right) + e^{\frac{\pi(mp-2nr+2pr)}{n}} \Phi \left( e^{2\pi r}, 1, \frac{p}{2n} \right) \\
& \left. \left. - e^{\frac{m\pi r}{n}} \Phi \left( e^{2\pi r}, 1, 1 - \frac{p}{2n} \right) \right) \sin \left( \frac{p\pi}{n} \right) \right) \\
& = \left( \frac{e^{\frac{i\pi}{n}} \cosh \left( \frac{(i+m)\pi}{2n} \right)}{\cosh \left( \frac{(-i+m)\pi}{2n} \right)} \right)^{e^{-2m\pi n}} \left( \frac{e^{-\frac{i\pi}{n}} \cosh \left( \frac{\pi(-i+r)}{2n} \right)}{\cosh \left( \frac{\pi(i+r)}{2n} \right)} \right)^{e^{-2\pi r n}}
\end{aligned}$$

EXAMPLE 5.582.

$$\begin{aligned}
(5.585) \quad & \prod_{p=1}^{n-1} (8\pi)^{2ie^{ip\pi} \sin^2 \left( \frac{p\pi}{n} \right)} \left( \left( a - \frac{p}{n} \right) \Gamma \left( \frac{1}{2} \left( a - \frac{p}{n} \right) \right) \right)^{2(-1)^p e^{-\frac{ip\pi}{n}} \sin \left( \frac{p\pi}{n} \right)} \\
& \left( \left( -2 + a + \frac{p}{n} \right) \Gamma \left( \frac{1}{2} \left( -2 + a + \frac{p}{n} \right) \right) \right)^{i(-1)^p \left( -1 + e^{\frac{2ip\pi}{n}} \right)} \\
& = 2^{\frac{1}{2}(-i+\tan(\frac{\pi}{n}))} \exp \left( -ie^{\frac{2i\pi}{n}} \Phi' \left( -e^{\frac{2i\pi}{n}}, 0, 1 + an \right) \right) n^{\frac{1}{2} \tan \left( \frac{\pi}{n} \right)} \left( \frac{\Gamma \left( \frac{1}{2}(1 + an) \right)}{\Gamma \left( 1 + \frac{an}{2} \right)} \right)^i
\end{aligned}$$

EXAMPLE 5.583.

$$\begin{aligned}
(5.586) \quad & \prod_{p=1}^{n-1} \exp \left( 2(-1)^p e^{-\frac{ip\pi}{n}} \log \Gamma \left( \frac{1}{2} \left( -2 + a + \frac{p}{n} \right) \right) \sin \left( \frac{p\pi}{n} \right) \right) \left( -2 + a + \frac{p}{n} \right)^{2(-1)^p e^{-\frac{ip\pi}{n}} \sin \left( \frac{p\pi}{n} \right)} \\
& \Gamma \left( \frac{1}{2} \left( 2 + a - \frac{p}{n} \right) \right)^{i(-1)^p \left( -1 + e^{\frac{2ip\pi}{n}} \right)} \\
& = 2^{\frac{1}{2}(-i+(-2+e^{in\pi}) \tan(\frac{\pi}{n}))} \exp \left( -ie^{-\frac{2i\pi}{n}} \Phi' \left( -e^{-\frac{2i\pi}{n}}, 0, 1 + an \right) \right) \\
& n^{-\frac{1}{2} \tan \left( \frac{\pi}{n} \right)} \pi^{\frac{1}{2} i \sin(n\pi)(i+\tan(\frac{\pi}{n}))} \left( \frac{\Gamma \left( \frac{1}{2}(1 + an) \right)}{\Gamma \left( 1 + \frac{an}{2} \right)} \right)^i
\end{aligned}$$

EXAMPLE 5.584.

$$\begin{aligned}
(5.587) \quad & \prod_{p=0}^{n-1} \left( \frac{\Gamma \left( \frac{-1+2(2+a)n-2p}{4n} \right)}{\Gamma \left( \frac{1+2an+2p}{4n} \right)} \right)^{(-1)^p \cos \left( \frac{j(1+2p)\pi}{2n} \right)} \\
& = \exp \left( \frac{1}{2} e^{-\frac{3ij\pi}{2n}} \left( -e^{\frac{ij\pi}{n}} \Phi' \left( e^{-\frac{2ij\pi}{n}}, 0, \frac{1}{4}(1+2an) \right) + \Phi' \left( e^{-\frac{2ij\pi}{n}}, 0, \frac{1}{4}(3+2an) \right) \right) \right. \\
& \left. - e^{\frac{2ij\pi}{n}} \Phi' \left( e^{\frac{2ij\pi}{n}}, 0, \frac{1}{4}(1+2an) \right) + e^{\frac{3ij\pi}{n}} \Phi' \left( e^{\frac{2ij\pi}{n}}, 0, \frac{1}{4}(3+2an) \right) \right) n^{-\frac{1}{2} \sec \left( \frac{j\pi}{2n} \right)}
\end{aligned}$$

EXAMPLE 5.585.

(5.588)

$$\begin{aligned}
& \prod_{p=0}^{n-1} 2^{-(-1)^p e^{\frac{ip\pi}{2n}} \left(-1 + e^{\frac{i(-1+2n-2p)\pi}{2n}}\right) \cos\left(\frac{j(1+2p)\pi}{2n}\right)} \left( \frac{\Gamma\left(\frac{-1+2(2+a)n-2p}{8n}\right)}{\Gamma\left(\frac{-1+2(4+a)n-2p}{8n}\right)} \right)^{2(-1)^p e^{\frac{i(-1+2n-p)\pi}{2n}} \cos\left(\frac{j(1+2p)\pi}{2n}\right)} \\
& \left( \frac{\Gamma\left(\frac{1+2(2+a)n+2p}{8n}\right)}{\Gamma\left(\frac{1+2an+2p}{8n}\right)} \right)^{2(-1)^p e^{\frac{ip\pi}{2n}} \cos\left(\frac{j(1+2p)\pi}{2n}\right)} \\
& = \exp\left( e^{\frac{i(1-3j)\pi}{2n}} \left( -e^{\frac{i(-1+2j)\pi}{2n}} \Phi'\left( e^{\frac{i(1-2j)\pi}{n}}, 0, \frac{1}{4}(1+2an) \right) + \Phi'\left( e^{\frac{i(1-2j)\pi}{n}}, 0, \frac{1}{4}(3+2an) \right) \right. \right. \\
& \quad \left. \left. - e^{\frac{i(-1+4j)\pi}{2n}} \Phi'\left( e^{\frac{i(1+2j)\pi}{n}}, 0, \frac{1}{4}(1+2an) \right) + e^{\frac{3ij\pi}{n}} \Phi'\left( e^{\frac{i(1+2j)\pi}{n}}, 0, \frac{1}{4}(3+2an) \right) \right) \right) \\
& \quad \quad \quad - \frac{2e^{-\frac{i\pi}{4n}} \cos\left(\frac{\pi}{4n}\right) \cos\left(\frac{j\pi}{2n}\right)}{n \cos\left(\frac{\pi}{2n}\right) + \cos\left(\frac{j\pi}{n}\right)}
\end{aligned}$$

EXAMPLE 5.586.

$$(5.589) \quad \prod_{p=1}^n \frac{\Gamma\left(\frac{1}{2}(1+2^p x)\right)^2}{\Gamma\left(\frac{1}{2}+2^p x\right)} = \frac{2^{n-2(-1+2^n)x} \pi^{n/2} \Gamma(2^n x) \Gamma\left(\frac{1}{2}+x\right)}{\Gamma(x) \Gamma\left(\frac{1}{2}+2^n x\right)}$$

EXAMPLE 5.587.

(5.590)

$$\prod_{p=1}^n \left( \frac{\cos(2^{-p}m) (1 + \cos(2^{-p}r)) \sec(2^{-p}r)}{1 + \cos(2^{-p}m)} \right)^{2^p} = \frac{(1 + \cos(m)) \left( \frac{1 + \cos(2^{-n}r)}{1 + \cos(2^{-n}m)} \right)^{2^n}}{1 + \cos(r)}$$

EXAMPLE 5.588.

$$(5.591) \quad \prod_{p=1}^n \left( \frac{1 + q^{2^{-p}}}{\sqrt{1 + q^{2^{1-p}}}} \right)^{2^p} = \frac{(1 + q^{2^{-n}})^{2^n}}{1 + q}$$

EXAMPLE 5.589.

(5.592)

$$\begin{aligned}
& \prod_{p=1}^n \left( e^{i2^{1-p}m\pi} \right)^{-2^{-1+p}} \left( 32\pi^6 (1 + i \tan(2^{-p}m\pi)) \right)^{2^p} \left( 4\pi^3 \sec(2^{-1-p}m\pi) \right)^{-2^{p+1}} \\
& = \frac{2^{2^{1+n}} \left( e^{i2^{-n}m\pi} \right)^{2^n} \sec^{-2^{1+n}}(2^{-1-n}m\pi)}{(1 + e^{im\pi})^2}
\end{aligned}$$

EXAMPLE 5.590.

(5.593)

$$\prod_{p=1}^n (q^{2^{1-p}})^{2^{-1+p}} (1 + q^{2^{1-p}})^{-2^p} \left( \frac{q^{2^{-1-p}}}{1 + q^{2^{-p}}} \right)^{-2^{1+p}} = \frac{(q^{2^{-n}})^{2^n} \left( \frac{q^{2^{-1-n}}}{1 + q^{2^{-n}}} \right)^{-2^{1+n}}}{(1 + q)^2}$$

EXAMPLE 5.591.

(5.594)

$$\prod_{n=0}^{\infty} \prod_{p=0}^{\infty} \prod_{q=0}^{\infty} \exp \left( \frac{(-1)^{2n+p+2q} 2^p (a + n\alpha)^{-1-n-p-2q} \beta (n\alpha + \beta)^{-1+n} E_p(x) \Gamma(1 + n + p + 2q)}{\Gamma(1 + n) \Gamma(1 + p) \Gamma(2 + 2q)} \right) \\ = \frac{(-1 + a + 2x - \beta) \Gamma \left( \frac{1}{4} (-1 + a + 2x - \beta) \right)^2}{4 \Gamma \left( \frac{1}{4} (1 + a + 2x - \beta) \right)^2}$$

EXAMPLE 5.592.

$$(5.595) \quad \prod_{p=0}^{\infty} \left( 1 + \frac{2(m-r)(\alpha + 2p\alpha)}{(m + \alpha + 2p\alpha)(r - (1 + 2p)\alpha)} \right)^{(-1)^p \cos((1+2p)x)} \\ = \exp \left( \frac{1}{2} i \left( e^{\frac{im(\pi-2x)}{2\alpha}} \Phi \left( -e^{\frac{im\pi}{\alpha}}, 1, \frac{1}{2} - \frac{x}{\pi} \right) + e^{\frac{im(\pi+2x)}{2\alpha}} \Phi \left( -e^{\frac{im\pi}{\alpha}}, 1, \frac{1}{2} + \frac{x}{\pi} \right) \right. \right. \\ \left. \left. - e^{\frac{ir(\pi-2x)}{2\alpha}} \Phi \left( -e^{\frac{i\pi r}{\alpha}}, 1, \frac{1}{2} - \frac{x}{\pi} \right) - e^{\frac{ir(\pi+2x)}{2\alpha}} \Phi \left( -e^{\frac{i\pi r}{\alpha}}, 1, \frac{1}{2} + \frac{x}{\pi} \right) \right) \right)$$

EXAMPLE 5.593.

$$(5.596) \quad \prod_{p=0}^{\infty} \exp \left( \frac{e^{ip\pi} \alpha (2m - i(m^2 - (\alpha + 2p\alpha)^2) \log(a)) \sin(x + 2px)}{(-m + \alpha + 2p\alpha)^2 (m + \alpha + 2p\alpha)^2} \right) \\ = \exp \left( \frac{\pi \sec \left( \frac{m\pi}{2\alpha} \right) \left( 2mx \cos \left( \frac{mx}{\alpha} \right) + \sin \left( \frac{mx}{\alpha} \right) (-2\alpha + 2im\alpha \log(a) + m\pi \tan \left( \frac{m\pi}{2\alpha} \right)) \right)}{8m^2\alpha} \right)$$

EXAMPLE 5.594.

(5.597)

$$\prod_{p=0}^{\infty} \exp \left( \frac{2(-1)^p e^{-i(1+2p)\alpha} \cos((1 + 2p)x) (E_1(-i(1 + 2p)\alpha) + e^{2i(\alpha+2p\alpha)} E_1(i(1 + 2p)\alpha))}{(1 + 2p)\pi} \right) \\ = \frac{2\pi \Gamma \left( \frac{3\pi-2x+2\alpha}{4\pi} \right) \Gamma \left( \frac{3\pi+2x+2\alpha}{4\pi} \right)}{\alpha \Gamma \left( \frac{\pi-2x+2\alpha}{4\pi} \right) \Gamma \left( \frac{\pi+2x+2\alpha}{4\pi} \right)}$$

EXAMPLE 5.595.

$$(5.598) \quad \prod_{p=0}^{\infty} \left( \frac{m - (1 + 2p)\alpha}{m + \alpha + 2p\alpha} \right)^{\frac{(-1)^p \cos(x+2px)}{(-m+\alpha+2p\alpha)^2}} \\ = \exp \left( \frac{\pi}{8\alpha^2} \left( (-2 + 2\gamma - i\pi) \sec \left( \frac{m\pi}{2\alpha} \right) \left( -2x \sin \left( \frac{mx}{\alpha} \right) + \pi \cos \left( \frac{mx}{\alpha} \right) \tan \left( \frac{m\pi}{2\alpha} \right) \right) \right. \right. \\ \left. \left. - 4i\pi \left( e^{\frac{im(\pi-2x)}{2\alpha}} \Phi' \left( -e^{\frac{im\pi}{\alpha}}, -1, \frac{1}{2} - \frac{x}{\pi} \right) + e^{\frac{im(\pi+2x)}{2\alpha}} \Phi' \left( -e^{\frac{im\pi}{\alpha}}, -1, \frac{1}{2} + \frac{x}{\pi} \right) \right) \right) \right)$$

$$\pi \frac{\sec\left(\frac{m\pi}{2\alpha}\right) \left(-2x \sin\left(\frac{m\pi}{\alpha}\right) + \pi \cos\left(\frac{m\pi}{\alpha}\right) \tan\left(\frac{m\pi}{2\alpha}\right)\right)}{4\alpha^2} \left(\frac{1}{\alpha}\right) \frac{\pi \sec\left(\frac{m\pi}{2\alpha}\right) \left(-2x \sin\left(\frac{m\pi}{\alpha}\right) + \pi \cos\left(\frac{m\pi}{\alpha}\right) \tan\left(\frac{m\pi}{2\alpha}\right)\right)}{4\alpha^2}$$

EXAMPLE 5.596.

(5.599)

$$\prod_{p=0}^{\infty} \exp \left( \frac{4i(-1)^{\frac{1}{4}+p} e^{-\frac{1}{2}(ix)} \cos(x+2px) \left( \frac{a^{4im(1+2p)} \Gamma(0, im(1+4p) \log(a))}{1+4p} + \frac{\Gamma(0, -im(3+4p) \log(a))}{3+4p} \right)}{a^{im(3+4p)} \pi} \right)$$

$$(im(1+4p))^{-\frac{4i(-1)^{\frac{1}{4}+p} e^{-\frac{1}{2}(ix)} \cos(x+2px)}{\pi+4p\pi}} (-im(3+4p))^{-\frac{4i(-1)^{\frac{1}{4}+p} e^{-\frac{1}{2}(ix)} \cos(x+2px)}{(3+4p)\pi}}$$

$$(im(1+4p) \log(a))^{\frac{4i(-1)^{\frac{1}{4}+p} e^{-\frac{1}{2}(ix)} \cos(x+2px)}{\pi+4p\pi}} (-im(3+4p) \log(a))^{\frac{4i(-1)^{\frac{1}{4}+p} e^{-\frac{1}{2}(ix)} \cos(x+2px)}{(3+4p)\pi}}$$

$$= \frac{\left( \frac{\Gamma\left(\frac{\pi-2x+4m \log(a)}{8\pi}\right)}{\Gamma\left(\frac{5\pi-2x+4m \log(a)}{8\pi}\right)} \right)^{e^{-ix}} \left( \frac{\Gamma\left(\frac{3\pi-2x+4m \log(a)}{8\pi}\right)}{\Gamma\left(\frac{7\pi-2x+4m \log(a)}{8\pi}\right)} \right)^{-ie^{-ix}} \Gamma\left(\frac{\pi+2x+4m \log(a)}{8\pi}\right) \left( \frac{\Gamma\left(\frac{3\pi+2x+4m \log(a)}{8\pi}\right)}{\Gamma\left(\frac{7\pi+2x+4m \log(a)}{8\pi}\right)} \right)^{-i}}{\Gamma\left(\frac{5\pi+2x+4m \log(a)}{8\pi}\right)}$$

$$\left(\frac{1}{m}\right)^{\left(-\frac{1}{2}+\frac{i}{2}\right)(1+e^{-ix})} (2\pi)^{\left(-\frac{1}{2}+\frac{i}{2}\right)(1+e^{-ix})}$$

EXAMPLE 5.597.

$$(5.600) \quad \prod_{p=1}^n \frac{\Gamma(3^{-p}z)}{\Gamma(3^{1-p}z)} = \frac{\Gamma(3^{-n}z)}{\Gamma(z)}$$

EXAMPLE 5.598.

$$(5.601) \quad \prod_{p=1}^n \left( 1 - \frac{3m3^{-1+p}}{1+m3^{-1+p}+m2 \times 3^{-1+p}} \right)^{3^{-p}} = (1-m) \left( \frac{1}{1-m3^n} \right)^{3^{-n}}$$

EXAMPLE 5.599.

$$(5.602) \quad \prod_{p=1}^n (1+2 \cos(2 \times 3^{-p}m)) = \frac{\sin(m)}{\sin(3^{-n}m)}$$

EXAMPLE 5.600.

(5.603)

$$\prod_{p=1}^n \exp \left( 3^{-p} e^{i3^{-p}\pi} \left( \frac{(2+e^{-i3^{-p}\pi}) \log(i3^{-p})}{1+2 \cos(3^{-p}\pi)} - \sqrt[3]{-1} \Phi' \left( -\sqrt[3]{-1} e^{i3^{-p}\pi}, 0, 1+2 \times 3^p z \right) \right. \right.$$

$$\left. \left. + (-1)^{2/3} \Phi' \left( (-1)^{2/3} e^{i3^{-p}\pi}, 0, 1+2 \times 3^p z \right) \right) \right)$$

$$= \frac{(1+i)(i3^{-n})^{-3^{-n}} \left( 1 + \frac{1}{-1+e^{i3^{-n}\pi}} \right) \exp \left( -3^{-n} e^{i3^{-n}\pi} \Phi' \left( e^{i3^{-n}\pi}, 0, 1+2 \times 3^n z \right) \right) z \Gamma(z)}{\Gamma\left(\frac{1}{2}+z\right)}$$

EXAMPLE 5.601.

$$(5.604) \quad \prod_{p=1}^n \left(1 + q^{3^{-p}} + q^{2 \times 3^{-p}}\right) = \frac{q-1}{q^{3^{-n}} - 1}$$

EXAMPLE 5.602.

$$(5.605) \quad \prod_{p=1}^n \frac{\Gamma(3^p x)}{\Gamma(3^{-1+p} x)} = \frac{3^{3^n(1+n)x} (3^{-1-n})^{3^n x} \Gamma(3^n x)}{\Gamma(x)}$$

EXAMPLE 5.603.

$$(5.606) \quad \prod_{p=1}^n \left( \frac{\left(1 + m^{3^{-p}} + m^{2 \times 3^{-p}}\right) \left(-1 + r^{3^{-p}}\right)^2}{\left(-1 + m^{3^{-p}}\right)^2 \left(1 + r^{3^{-p}} + r^{2 \times 3^{-p}}\right)} \right)^{3^p} = \frac{(-1+m)^3 \left(\frac{-1+r^{3^{-n}}}{-1+m^{3^{-n}}}\right)^{3^{1+n}}}{(-1+r)^3}$$

EXAMPLE 5.604.

$$(5.607) \quad \prod_{p=1}^n \left(1 + q^{3^p} + q^{2 \times 3^p}\right) = \frac{-1 + q^{3^{1+n}}}{-1 + q^3}$$

EXAMPLE 5.605.

$$(5.608) \quad \prod_{p=1}^n \frac{1}{\left(1 + q^{3^{-p}} + q^{2 \times 3^{-p}}\right) \left(1 + q^{3^p} + q^{2 \times 3^p}\right)} = \frac{(1+q+q^2) \left(-1 + q^{3^{-n}}\right)}{-1 + q^{3^{1+n}}}$$

EXAMPLE 5.606.

$$(5.609) \quad \prod_{p=1}^n \exp \left( \frac{1}{2} 3^{-\frac{3}{2}+p} \left( \left(3i + \sqrt{3}\right) \Phi' \left( -\frac{1}{2} i \left(-i + \sqrt{3}\right), 0, 1 + 3^{1-p} z \right) \right. \right. \\ \left. \left. + \left(-3i + \sqrt{3}\right) \Phi' \left( \frac{1}{2} i \left(i + \sqrt{3}\right), 0, 1 + 3^{1-p} z \right) \right) \right) \\ = 3^{\frac{3}{4} + \frac{1}{4} 3^n (-1+2n)+z} \left(3^{1+n}\right)^{-\frac{3^n}{2}-z} (2\pi)^{\frac{1}{2}(-1+3^n)} z \Gamma(z) \Gamma(1 + 3^{-n} z)^{-3^n}$$

EXAMPLE 5.607.

$$(5.610) \quad \prod_{p=1}^n \frac{1 + q^{3^{-p}} + q^{2 \times 3^{-p}}}{1 + q^{3^p} + q^{2 \times 3^p}} = \frac{(-1+q) (-1+q^3)}{(-1+q^{3^{-n}}) (-1+q^{3^{1+n}})}$$

EXAMPLE 5.608. Telescoping series involving the gamma function see Eq. (5.5.5) in [3].

$$(5.611) \quad \prod_{p=1}^n \frac{\Gamma\left(\frac{1}{6} + \frac{3^{-p}x}{2}\right) \Gamma\left(\frac{5}{6} + \frac{3^{-p}x}{2}\right)}{2\pi} = \frac{3^{\frac{3}{4}(-1+3^{-n})x} \Gamma\left(\frac{1+x}{2}\right)}{\Gamma\left(\frac{1}{2}(1+3^{-n}x)\right)}$$

EXAMPLE 5.609.

$$(5.612) \quad \prod_{p=1}^{\infty} \frac{\Gamma\left(\frac{1}{6} + \frac{3^{-p}x}{2}\right) \Gamma\left(\frac{5}{6} + \frac{3^{-p}x}{2}\right)}{2\pi} = \frac{3^{-\frac{3x}{4}} \Gamma\left(\frac{1+x}{2}\right)}{\sqrt{\pi}}$$

EXAMPLE 5.610.

$$(5.613) \quad \prod_{p=1}^n \left( \frac{(1+q^{3^p})^2 (1+q^{3^p} + q^{2 \times 3^p})}{(-1+q^{3^p})^2 (1-q^{3^p} + q^{2 \times 3^p})} \right)^{3^{-p}} = -\frac{(1+q^3)}{-1+q^3} \left( \frac{1-q^{3^{1+n}}}{1+q^{3^{1+n}}} \right)^{3^{-n}}$$

EXAMPLE 5.611.

$$(5.614) \quad \prod_{p=1}^{\infty} \left( \frac{(1+q^{3^p})^2 (1+q^{3^p} + q^{2 \times 3^p})}{(-1+q^{3^p})^2 (1-q^{3^p} + q^{2 \times 3^p})} \right)^{3^{-p}} = \frac{1+q^3}{1-q^3}$$

EXAMPLE 5.612.

$$(5.615) \quad \prod_{p=1}^n (q^{2 \times 3^{-p}} - q^{3^{-p}} + 1) = \frac{q+1}{q^{3^{-n}} + 1}$$

EXAMPLE 5.613.

$$(5.616) \quad \prod_{p=1}^{\infty} (1 - q^{3^{-p}} + q^{2 \times 3^{-p}}) = \frac{1+q}{2}$$

EXAMPLE 5.614.

$$(5.617) \quad \prod_{p=1}^{\infty} \prod_{k=1}^n \left( 1 - (-aq^k)^{3^{-p}} + (-aq^k)^{2 \times 3^{-p}} \right) = \frac{2^{-n}}{1-a} (a; q)_{1+n}$$

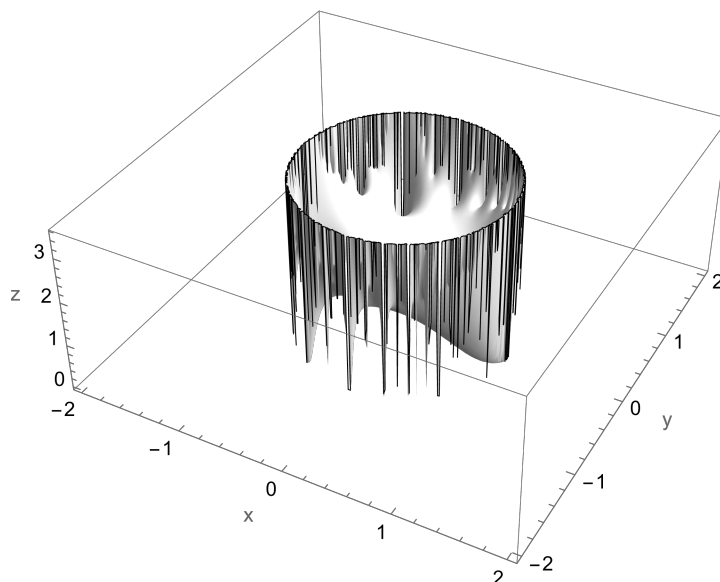

FIGURE 20. Plot of  $f(z) = (z; z)_\infty$ ,  $z \in \mathbb{C}$ .

EXAMPLE 5.615.

$$\begin{aligned}
 (5.618) \quad & \prod_{p=1}^n \exp \left( \sqrt[3]{-1} 3^{-p} \left( -\Phi' \left( \sqrt[3]{-1}, 0, 1 + 3^p a \right) + \sqrt[3]{-1} \Phi' \left( -(-1)^{2/3}, 0, 1 + 3^p a \right) \right) \right) \\
 & = \frac{2^{\frac{1}{2}(1+3^{-n})} 3^{\frac{3}{4}(-1+3^{-n})} \Gamma \left( \frac{1+a}{2} \right) \left( \frac{\Gamma(1+\frac{3^n a}{2})}{\Gamma(\frac{1}{2}(1+3^n a))} \right)^{3^{-n}}}{a \Gamma \left( \frac{a}{2} \right)}
 \end{aligned}$$

EXAMPLE 5.616.

$$\begin{aligned}
 (5.619) \quad & \prod_{p=1}^{\infty} \exp \left( \sqrt[3]{-1} 3^{-p} \left( -\Phi' \left( \sqrt[3]{-1}, 0, 1 + 3^p a \right) + \sqrt[3]{-1} \Phi' \left( -(-1)^{2/3}, 0, 1 + 3^p a \right) \right) \right) \\
 & = \frac{\Gamma \left( \frac{1+a}{2} \right)}{\sqrt{2} 3^{3/4} \Gamma \left( 1 + \frac{a}{2} \right)}
 \end{aligned}$$

EXAMPLE 5.617.

$$(5.620) \quad \prod_{p=1}^n \left( \frac{(1 + q^{3^{-p}})^2 (1 + q^{3^{-p}} + q^{2 \times 3^{-p}})}{(-1 + q^{3^{-p}})^2 (1 - q^{3^{-p}} + q^{2 \times 3^{-p}})} \right)^{3^p} = -\frac{(-1+q)^3}{(1+q)^3} \left( -1 - \frac{2}{-1 + q^{3^{-n}}} \right)^{3^{1+n}}$$

EXAMPLE 5.618.

$$(5.621) \quad \prod_{p=1}^n \frac{\Gamma\left(\frac{1}{6} + 3^p x\right) \Gamma\left(\frac{5}{6} + 3^p x\right)}{2\pi} = \frac{3^{\frac{1}{2}(-9)(-1+3^n)x} \Gamma\left(\frac{1}{2} + 3^{1+n} x\right)}{\Gamma\left(\frac{1}{2} + 3x\right)}$$

EXAMPLE 5.619.

$$(5.622) \quad \sum_{p=1}^{\infty} \frac{9^p q^{3^{-1+p}} \left(1 + q^{3^{-1+p}} \left(-4 + q^{3^{-1+p}}\right)\right)}{\left(1 + q^{3^{-1+p}} \left(-1 + q^{3^{-1+p}}\right)\right)^2} = \frac{9q}{(1+q)^2}$$

EXAMPLE 5.620.

$$(5.623) \quad \prod_{p=1}^n \left(1 - q^{3^{-1+p}} + q^{2 \times 3^{-1+p}}\right) = \frac{1 + q^{3^n}}{1 + q}$$

EXAMPLE 5.621.

$$(5.624) \quad \prod_{p=1}^n \exp\left(\sqrt[3]{-1} 3^{-1+p} \left(-\Phi'(\sqrt[3]{-1}, 0, 1 + 2 \cdot 3^{1-p} x) + \sqrt[3]{-1} \Phi'(-(-1)^{2/3}, 0, 1 + 2 \cdot 3^{1-p} x)\right)\right)$$

$$= \frac{2^{\frac{1}{2} - \frac{3^n}{2}} 3^{\frac{1}{4}(3+3^n(-3+2n))} \Gamma(1+x) \left(\frac{3^{n/2} \Gamma\left(\frac{1}{2} + 3^{-n} x\right)}{x \Gamma(3^{-n} x)}\right)^{3^n}}{\Gamma\left(\frac{1}{2} + x\right)}$$

EXAMPLE 5.622.

$$(5.625) \quad \prod_{p=0}^{\infty} \left(1 + \frac{2(m-r)(\alpha + 2p\alpha)}{(m + \alpha + 2p\alpha)(r - (1 + 2p)\alpha)}\right)^{(-1)^p \cos((1+2p)x)}$$

$$= \exp\left(\frac{1}{2} i \left(e^{\frac{im(\pi-2x)}{2\alpha}} \Phi\left(-e^{\frac{im\pi}{\alpha}}, 1, \frac{1}{2} - \frac{x}{\pi}\right) + e^{\frac{im(\pi+2x)}{2\alpha}} \Phi\left(-e^{\frac{im\pi}{\alpha}}, 1, \frac{1}{2} + \frac{x}{\pi}\right) - e^{\frac{ir(\pi-2x)}{2\alpha}} \Phi\left(-e^{\frac{ir\pi}{\alpha}}, 1, \frac{1}{2} - \frac{x}{\pi}\right) - e^{\frac{ir(\pi+2x)}{2\alpha}} \Phi\left(-e^{\frac{ir\pi}{\alpha}}, 1, \frac{1}{2} + \frac{x}{\pi}\right)\right)\right)$$

EXAMPLE 5.623.

$$(5.626) \quad \prod_{p=0}^{\infty} \exp\left(\frac{e^{ip\pi} \alpha (2m - i(m^2 - (\alpha + 2p\alpha)^2) \log(a)) \sin(x + 2px)}{(-m + \alpha + 2p\alpha)^2 (m + \alpha + 2p\alpha)^2}\right)$$

$$= \exp\left(\frac{\pi \sec\left(\frac{m\pi}{2\alpha}\right) \left(2mx \cos\left(\frac{mx}{\alpha}\right) + \sin\left(\frac{mx}{\alpha}\right) (-2\alpha + 2im\alpha \log(a) + m\pi \tan\left(\frac{m\pi}{2\alpha}\right))\right)}{8m^2 \alpha}\right)$$

EXAMPLE 5.624.

$$(5.627) \quad \prod_{p=0}^{\infty} \exp\left(\frac{2(-1)^p e^{-i(1+2p)\alpha} \cos((1+2p)x) (E_1(-i(1+2p)\alpha) + e^{2i(\alpha+2p\alpha)} E_1(i(1+2p)\alpha))}{(1+2p)\pi}\right)$$

$$= \frac{2\pi \Gamma\left(\frac{3\pi-2x+2\alpha}{4\pi}\right) \Gamma\left(\frac{3\pi+2x+2\alpha}{4\pi}\right)}{\alpha \Gamma\left(\frac{\pi-2x+2\alpha}{4\pi}\right) \Gamma\left(\frac{\pi+2x+2\alpha}{4\pi}\right)}$$



EXAMPLE 5.625.

$$\begin{aligned}
 (5.628) \quad & \prod_{p=0}^{\infty} \left( \frac{m - (1 + 2p)\alpha}{m + \alpha + 2p\alpha} \right)^{\frac{(-1)^p \cos(x+2px)}{(-m+\alpha+2p\alpha)^2}} \\
 &= \exp \left( \frac{\pi}{8\alpha^2} \left( (-2 + 2\gamma - i\pi) \sec \left( \frac{m\pi}{2\alpha} \right) \left( -2x \sin \left( \frac{mx}{\alpha} \right) + \pi \cos \left( \frac{mx}{\alpha} \right) \tan \left( \frac{m\pi}{2\alpha} \right) \right) \right. \right. \\
 & \quad \left. \left. - 4i\pi \left( e^{-\frac{im(\pi-2x)}{2\alpha}} \Phi' \left( -e^{-\frac{im\pi}{\alpha}}, -1, \frac{1}{2} - \frac{x}{\pi} \right) + e^{\frac{im(\pi+2x)}{2\alpha}} \Phi' \left( -e^{-\frac{im\pi}{\alpha}}, -1, \frac{1}{2} + \frac{x}{\pi} \right) \right) \right) \right) \\
 & \quad \frac{\pi \sec \left( \frac{m\pi}{2\alpha} \right) \left( -2x \sin \left( \frac{mx}{\alpha} \right) + \pi \cos \left( \frac{mx}{\alpha} \right) \tan \left( \frac{m\pi}{2\alpha} \right) \right)}{4\alpha^2} \left( \frac{1}{\alpha} \right)^{\frac{\pi \sec \left( \frac{m\pi}{2\alpha} \right) \left( -2x \sin \left( \frac{mx}{\alpha} \right) + \pi \cos \left( \frac{mx}{\alpha} \right) \tan \left( \frac{m\pi}{2\alpha} \right) \right)}{4\alpha^2}}
 \end{aligned}$$

EXAMPLE 5.626.

$$\begin{aligned}
 (5.629) \quad & \prod_{p=0}^{\infty} \exp \left( \frac{4i(-1)^{\frac{1}{4}+p} e^{-\frac{1}{2}(ix)} \cos(x + 2px) \left( \frac{a^{4im(1+2p)} \Gamma(0, im(1+4p) \log(a))}{1+4p} + \frac{\Gamma(0, -im(3+4p) \log(a))}{3+4p} \right)}{a^{im(3+4p)} \pi} \right) \\
 & \quad (im(1 + 4p))^{-\frac{4i(-1)^{\frac{1}{4}+p} e^{-\frac{1}{2}(ix)} \cos(x+2px)}{\pi+4p\pi}} (-im(3 + 4p))^{-\frac{4i(-1)^{\frac{1}{4}+p} e^{-\frac{1}{2}(ix)} \cos(x+2px)}{(3+4p)\pi}} \\
 & \quad (im(1+4p) \log(a))^{\frac{4i(-1)^{\frac{1}{4}+p} e^{-\frac{1}{2}(ix)} \cos(x+2px)}{\pi+4p\pi}} (-im(3+4p) \log(a))^{\frac{4i(-1)^{\frac{1}{4}+p} e^{-\frac{1}{2}(ix)} \cos(x+2px)}{(3+4p)\pi}} \\
 & = \frac{\left( \frac{\Gamma \left( \frac{\pi - 2x + 4m \log(a)}{8\pi} \right)}{\Gamma \left( \frac{5\pi - 2x + 4m \log(a)}{8\pi} \right)} \right) e^{-ix} \left( \frac{\Gamma \left( \frac{3\pi - 2x + 4m \log(a)}{8\pi} \right)}{\Gamma \left( \frac{7\pi - 2x + 4m \log(a)}{8\pi} \right)} \right)^{-ie^{-ix}} \Gamma \left( \frac{\pi + 2x + 4m \log(a)}{8\pi} \right) \left( \frac{\Gamma \left( \frac{3\pi + 2x + 4m \log(a)}{8\pi} \right)}{\Gamma \left( \frac{7\pi + 2x + 4m \log(a)}{8\pi} \right)} \right)^{-i}}{\Gamma \left( \frac{5\pi + 2x + 4m \log(a)}{8\pi} \right)} \\
 & \quad \left( \frac{1}{m} \right)^{\left( -\frac{1}{2} + \frac{i}{2} \right) (1 + e^{-ix})} (2\pi)^{\left( -\frac{1}{2} + \frac{i}{2} \right) (1 + e^{-ix})}
 \end{aligned}$$

EXAMPLE 5.627.

$$(5.630) \quad \prod_{p=0}^{\infty} \left( 1 - \frac{2(1 + 2p)(m - r)\beta}{(m + (1 + 2p)\beta)(-r + (1 + 2p)\beta)} \right)^{(-1)^p} = \frac{\tan \left( \frac{\pi(r+\beta)}{4\beta} \right)}{\tan \left( \frac{\pi(m+\beta)}{4\beta} \right)}$$

EXAMPLE 5.628.

$$(5.631) \quad \prod_{p=0}^{\infty} e^{-\frac{8(-1)^p(1+2p)}{3+16p+16p^2}} \left( \frac{(3 + 4p)^2}{(1 + 4p)^2} \right)^{(-1)^p} = (3 + 2\sqrt{2}) e^{-\frac{\pi}{\sqrt{2}}}$$

EXAMPLE 5.629.

$$(5.632) \quad \prod_{p=0}^{\infty} \exp \left( -\frac{2(-1)^p(1 + 2p)}{2 + 9p(1 + p)} \right) \left( \frac{-(2 + 3p)^2}{-(1 + 3p)^2} \right)^{\frac{2(-1)^p}{3}} = 3^{2/3} e^{-\frac{4\pi}{9\sqrt{3}}}$$

EXAMPLE 5.630.

(5.633)

$$\prod_{p=0}^{\infty} \exp\left(-\frac{8(-1)^p(1+2p)}{(3+8p)(5+8p)}\right) \left(\frac{-(5+8p)^2}{-(3+8p)^2}\right)^{\frac{(-1)^p}{2}} = \left(-1 + \sqrt{2} + \sqrt{4-2\sqrt{2}}\right) e^{-\frac{\pi}{4\sqrt{2+\sqrt{2}}}}$$

EXAMPLE 5.631.

$$(5.634) \quad \prod_{p=0}^{\infty} \exp\left(-\frac{160(-1)^p(1+2p)}{-39+100p+100p^2}\right) \left(\frac{(13+10p)^2}{(3-10p)^2}\right)^{(-1)^p} \\ \frac{1}{5} \left(5 - \sqrt{5} + \sqrt{5(5-2\sqrt{5})}\right)^2 e^{\frac{8}{5}(-1+\sqrt{5})\pi}$$

EXAMPLE 5.632.

$$(5.635) \quad \prod_{p=0}^{\infty} e^{-\frac{12(-1)^p(1+2p)}{5+36p+36p^2}} \left(\frac{(5+6p)^2}{(1+6p)^2}\right)^{\frac{(-1)^p}{2}} (2+\sqrt{3}) e^{-\frac{2\pi}{3}}$$

EXAMPLE 5.633.

(5.636)

$$\prod_{p=0}^{\infty} \exp\left(-\Gamma\left(0, -\frac{1}{2}i(\pi+2p\pi) - \log(q)\right) - \Gamma\left(0, \frac{1}{2}i(\pi+2p\pi+2i\log(q))\right)\right) = 1+q^2$$

EXAMPLE 5.634.

$$(5.637) \quad \prod_{p=0}^{\infty} \exp\left(-\Gamma\left(0, \frac{i\pi(-2m+\beta+2p\beta)}{2\beta}\right) - \Gamma\left(0, -\frac{i\pi(2m+\beta+2p\beta)}{2\beta}\right)\right) \\ + \Gamma\left(0, \frac{i\pi(-2r+\beta+2p\beta)}{2\beta}\right) + \Gamma\left(0, -\frac{i\pi(2r+\beta+2p\beta)}{2\beta}\right) \\ = e^{\frac{i\pi(m-r)}{\beta}} \cos\left(\frac{m\pi}{\beta}\right) \sec\left(\frac{\pi r}{\beta}\right)$$

EXAMPLE 5.635.

$$(5.638) \quad \prod_{p=0}^{\infty} (-2m+\beta+2p\beta)^{-\frac{(-1)^p}{-2m+\beta+2p\beta}} \\ (-2r+\beta+2p\beta)^{-\frac{(-1)^p}{-2r+\beta+2p\beta}} (-2m-(1+2p)\beta)^{\frac{(-1)^p}{2m+\beta+2p\beta}} (-2r-(1+2p)\beta)^{-\frac{(-1)^p}{-2r+\beta+2p\beta}} \\ = \exp\left(\frac{\pi}{\beta}\left(-\frac{1}{2}\left(\gamma + \log\left(\frac{i\pi}{\beta}\right)\right)\right)\right) \left(\sec\left(\frac{m\pi}{\beta}\right) - \sec\left(\frac{\pi r}{\beta}\right)\right) \\ + e^{\frac{im\pi}{\beta}} \Phi'\left(-e^{\frac{2im\pi}{\beta}}, 0, \frac{1}{2}\right) - e^{\frac{i\pi r}{\beta}} \Phi'\left(-e^{\frac{2i\pi r}{\beta}}, 0, \frac{1}{2}\right)$$

EXAMPLE 5.636.

(5.639)

$$\prod_{p=0}^{\infty} \exp \left( \frac{(-1)^p e^{-i a (\frac{1}{2} + p) \pi \beta} (E_1 (-\frac{1}{2} i a (1 + 2p) \pi \beta) + e^{i a (1 + 2p) \pi \beta} E_1 (\frac{1}{2} i a (1 + 2p) \pi \beta))}{(1 + 2p) \pi} \right) = \frac{2 \Gamma (\frac{1}{4} (3 + a \beta))}{\sqrt{a} \sqrt{\beta} \Gamma (\frac{1}{4} (1 + a \beta))}$$

EXAMPLE 5.637.

(5.640)

$$\prod_{p=0}^{\infty} \exp \left( \frac{(-1)^p e^{-i (\frac{1}{2} + p) \pi x} (E_1 (-\frac{1}{2} i (1 + 2p) \pi x) + e^{i (1 + 2p) \pi x} E_1 (\frac{1}{2} i (1 + 2p) \pi x))}{(1 + 2p) \pi} \right) = \frac{2 \Gamma (\frac{3+x}{4})}{\sqrt{x} \Gamma (\frac{1+x}{4})}$$

EXAMPLE 5.638. Application of Gautschi's Inequality using equation (5.6.4) in [3].

(5.641)

$$\frac{2\sqrt{x}}{\sqrt{1+4x}} < \prod_{p=0}^{\infty} \exp \left( \frac{E_1 (-\frac{1}{2} i (1 + 2p) \pi (1 + 4x)) + e^{i (1 + 2p) \pi (1 + 4x)} E_1 (\frac{1}{2} i (1 + 2p) \pi (1 + 4x))}{(-1)^{-p} e^{i (\frac{1}{2} + p) \pi (1 + 4x)} (1 + 2p) \pi} \right) < \frac{2\sqrt{1+x}}{\sqrt{1+4x}}$$

EXAMPLE 5.639.

(5.642)

$$\prod_{p=0}^{\infty} \exp \left( \frac{2(-1)^p \sqrt{2} a^{-((\frac{1}{4} + p) \beta)} \left( \frac{\Gamma(0, -\frac{1}{4}(1+4p)\beta \log(a))}{1+4p} + \frac{a^{\beta+2p\beta} \Gamma(0, \frac{1}{4}(3+4p)\beta \log(a))}{3+4p} \right)}{\pi} \right) = \frac{8i\pi \left( \frac{\Gamma(\frac{\pi - i\beta \log(a)}{8\pi})}{\Gamma(\frac{5}{8} - \frac{i\beta \log(a)}{8\pi})} \right)^{-1+i} \left( \frac{\Gamma(\frac{3}{8} - \frac{i\beta \log(a)}{8\pi})}{\Gamma(\frac{7}{8} - \frac{i\beta \log(a)}{8\pi})} \right)^{-1-i}}{\log(a)\beta}$$

EXAMPLE 5.640.

(5.643)

$$\prod_{p=0}^{\infty} \exp \left( - \frac{(-1)^p \left( e^{\frac{i\pi x}{2}} (3 + 2p) E_1 (\frac{1}{2} i (1 - 2p) \pi x) + e^{\frac{1}{2} i (3 + 4p) \pi x} (-1 + 2p) E_1 (\frac{1}{2} i (3 + 2p) \pi x) \right)}{e^{ip\pi x} (-3 + 4p(1 + p)) \pi} \right) = \frac{2 \Gamma (\frac{3+x}{4})}{\sqrt{x} \Gamma (\frac{1+x}{4})}$$

EXAMPLE 5.641.

(5.644)

$$\prod_{p=0}^{\infty} \exp \left( \frac{(-1)^p e^{-i(\frac{3}{2}+p)\pi x} (e^{i(1+2p)\pi x} (3+2p) E_1(\frac{1}{2}i(-1+2p)\pi x) + (-1+2p) E_1(-\frac{1}{2}i(3+2p)\pi x))}{(-3+4p(1+p))\pi} \right) = \frac{\sqrt{x}\Gamma(\frac{1+x}{4})}{2\Gamma(\frac{3+x}{4})}$$

EXAMPLE 5.642.

$$(5.645) \quad \prod_{p=0}^{\infty} \exp \left( \Gamma \left( 0, \pi \left( -\frac{i}{2} - ip + \frac{m}{\beta} \right) \right) + \Gamma \left( 0, \pi \left( \frac{i}{2} + ip + \frac{m}{\beta} \right) \right) \right) = \frac{1}{2} \left( 1 + \tanh \left( \frac{m\pi}{\beta} \right) \right)$$

EXAMPLE 5.643.

$$(5.646) \quad \prod_{j=1}^n \left( \prod_{p=0}^{\infty} \exp \left( -\Gamma \left( 0, -\frac{1}{2}i(\pi + 2p\pi) - \log(q^j) \right) - \Gamma \left( 0, \frac{1}{2}i(\pi + 2p\pi + 2i \log(q^j)) \right) \right) \right) = \frac{1}{2} (-1; q^2)_{1+n}$$

EXAMPLE 5.644.

$$(5.647) \quad \prod_{p=1}^n \left( 1 + \frac{2q^{2^{-p}}}{1+q^{2^{1-p}}} \right) = \frac{(-1+q)(1+q^{2^{-n}})}{(1+q)(-1+q^{2^{-n}})}$$

EXAMPLE 5.645.

$$(5.648) \quad \prod_{p=1}^n \pi^{-2^{-1-p}} \left( \frac{2^{\frac{1}{2}(-1+2^p z)} \Gamma(\frac{1}{4}(2+2^p z))^2}{\Gamma(\frac{1}{2}(1+2^p z))} \right)^{2^{-p}} = 2^{\frac{1}{2}(-1+2^{-n}+nz)} \pi^{\frac{1}{2}(-1+2^{-n})} \Gamma\left(\frac{1+z}{2}\right) \Gamma\left(\frac{1}{2}(1+2^n z)\right)^{-2^{-n}}$$

EXAMPLE 5.646.

$$(5.649) \quad \prod_{p=1}^n \left( 1 + \frac{2q^{2^{-1+p}}}{1+q^{2^p}} \right)^{2^{-p}} = (1+q)(1+q^{2^n})^{-2^{-n}}$$

EXAMPLE 5.647. An infinite product two-ways.

$$(5.650) \quad \prod_{p=1}^{\infty} \left( 1 + \frac{2q^{2^{-1+p}}}{1+q^{2^p}} \right)^{2^{-p}} = \begin{cases} 1 + \frac{1}{q}; & q \in \mathbb{C} \\ 1 + q; & q \in \mathbb{R} \end{cases}$$

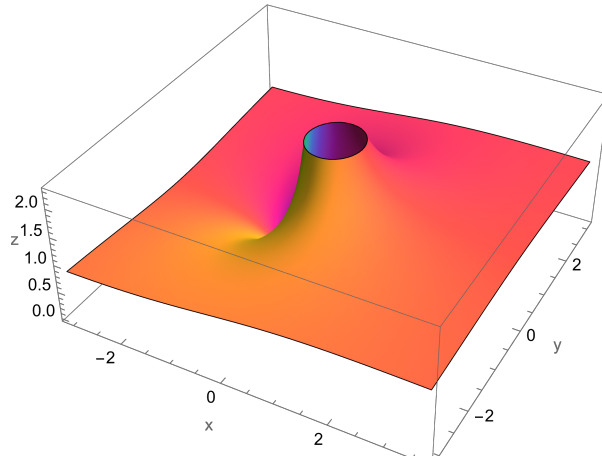

FIGURE 21. Plot of  $f(q) = 1 + \frac{1}{q}$ ,  $x \in \mathbb{C}$ .

EXAMPLE 5.648.

$$(5.651) \quad \prod_{j=1}^m \prod_{p=1}^{\infty} \left( 1 + \frac{2q^{j2^{-1+p}}}{1 + q^{j2^p}} \right)^{2^{-p}} = \begin{cases} \frac{1}{2} \left( -1; \frac{1}{q} \right)_{1+m} & q \in \mathbb{C} \\ \frac{1}{2} (-1; q)_{1+m} & q \in \mathbb{R} \end{cases}$$

EXAMPLE 5.649.

$$(5.652) \quad \prod_{p=1}^n \frac{\Gamma\left(\frac{1}{4}(2 + 2^{-p}z)\right)^2}{\sqrt{\pi}\Gamma\left(\frac{1}{2}(1 + 2^{-p}z)\right)} = \frac{2^{n+\frac{1}{2}}(-1+2^{-n})z\Gamma\left(\frac{z}{4}\right)\Gamma\left(\frac{1}{4}(2 + 2^{-n}z)\right)}{\Gamma(2^{-2-n}z)\Gamma\left(\frac{2+z}{4}\right)}$$

5.2.1. *Examples derived using equation (4.155).*

EXAMPLE 5.650.

$$(5.653) \quad \prod_{p=1}^{2n} \exp\left((-1)^{-n+p} e^{\frac{ip\pi}{n}} q^{\frac{1+n}{2}} \Phi\left(-e^{\frac{ip\pi}{n}} \sqrt{q}, 1, 1+n\right)\right) = 1 - q^n$$

EXAMPLE 5.651.

$$(5.654) \quad \prod_{n=1}^{\infty} \left( \prod_{p=1}^{2n} \exp\left((-1)^{-n+p} e^{\frac{ip\pi}{n}} q^{\frac{1+n}{2}} \Phi\left(-e^{\frac{ip\pi}{n}} \sqrt{q}, 1, 1+n\right)\right) \right) = (q; q)_{\infty}$$

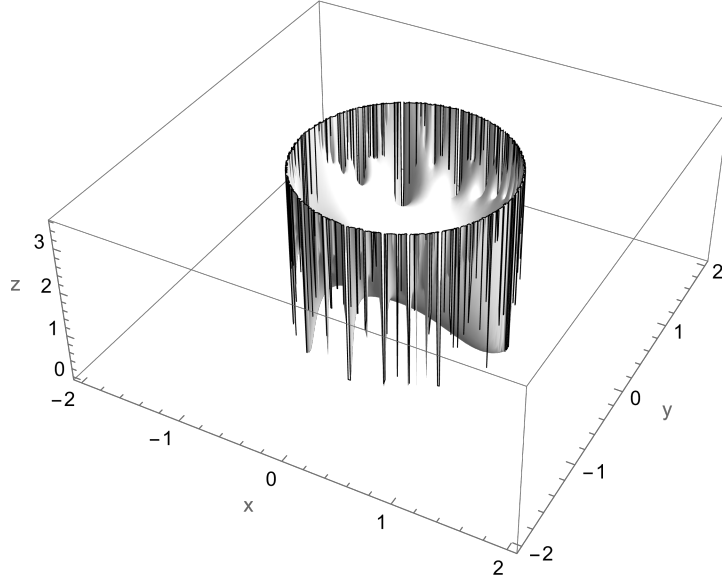
FIGURE 22. Plot of  $f(z) = (z; z)_\infty$ ,  $z \in \mathbb{C}$ .

EXAMPLE 5.652.

$$(5.655) \quad \prod_{p=1}^{2n} \left(1 + e^{\frac{ip\pi}{n}} q\right)^{(-1)^p} = \left(\frac{1 - q^n}{1 + q^n}\right)^{(-1)^n}$$

EXAMPLE 5.653.

$$(5.656) \quad \prod_{n=1}^{\infty} \left(\prod_{p=1}^{2n} \left(1 + e^{\frac{ip\pi}{n}} q\right)^{(-1)^p}\right) = \frac{(-q; q^2)_\infty (q^2; q^2)_\infty}{(q; q^2)_\infty (-q^2; q^2)_\infty}$$

EXAMPLE 5.654.

$$(5.657) \quad \prod_{p=1}^{2n} \exp\left(\frac{(-1)^{-n+p} e^{-\frac{i(-1+n-2p)\pi}{2n}} \Phi'\left(-e^{\frac{i(1+2p)\pi}{2n}}, 0, a\right)}{2n}\right) = \frac{2\sqrt{n}\Gamma\left(\frac{-1+a+3n}{4n}\right)}{\Gamma\left(\frac{-1+a+n}{4n}\right)}$$

EXAMPLE 5.655.

$$(5.658) \quad \prod_{p=1}^{2n} \left(\frac{e^{-i(m-r)} \cos\left(\frac{p\pi}{2n} + r\right)}{\cos\left(m + \frac{p\pi}{2n}\right)}\right)^{(-1)^p} = \left(\frac{\tan(nr)}{\tan(mn)}\right)^{(-1)^n}$$

EXAMPLE 5.656.

$$(5.659) \quad \prod_{n=1}^{\infty} \left(\prod_{p=1}^{2n} \left(\frac{1 + e^{\frac{ip\pi}{n}} r}{1 + e^{\frac{ip\pi}{n}} m}\right)^{(-1)^{-n+p}}\right) = \frac{(-1; m)_\infty (r; r)_\infty}{(-1; r)_\infty (m; m)_\infty}$$

EXAMPLE 5.657. A telescoping series similar to Eq. (5.5.6) in [3].

$$(5.660) \quad \prod_{p=0}^n 3^{\frac{1}{2}(-2^p+3x)} (2\pi)^{-2^p} \left( \frac{\Gamma(2^{-1-p}x) \Gamma(\frac{1}{6} + 2^{-1-p}x) \Gamma(\frac{5}{6} + 2^{-1-p}x)}{\Gamma(3 \times 2^{-1-p}x)} \right)^{2^p} \\ = \frac{3^{\frac{1}{2}-2^n} (2^{1+n})^{-2x} \Gamma(3x) \left( \frac{\Gamma(2^{-1-n}x)}{\Gamma(3 \times 2^{-1-n}x)} \right)^{2^{1+n}}}{\Gamma(x)}$$

### 5.3. Series.

EXAMPLE 5.658.

$$(5.661) \quad \alpha \sum_{p=1}^{\infty} \left( (\coth(\alpha^2 p) - 1) ((\log(a) + 2\alpha p)^k - (\log(a) - 2\alpha p)^k) \right. \\ \left. + \frac{i\beta (\coth(\beta^2 p) - 1) ((\log(a) - 2i\beta p)^k - (\log(a) + 2i\beta p)^k)}{\alpha} \right) \\ = -2^{k+1} \alpha^{k+1} \zeta \left( -k, \frac{\log(a)}{2\alpha} + 1 \right) + 2^{k+1} (i\beta)^{k+1} \zeta \left( -k, 1 - \frac{i\log(a)}{2\beta} \right) \\ - \left( \log^{k-1}(a) (2k + (\alpha - i\beta) \log(a)) \right)$$

EXAMPLE 5.659.

$$(5.662) \quad \sum_{p=1}^{\infty} \frac{(\coth(\alpha^2 p) - 1) \cosh(2\alpha mp) - (\coth(\beta^2 p) - 1) \cos(2\beta mp)}{p} \\ = \log(\sinh(\alpha m) \csc(\beta m)) - m^2$$

EXAMPLE 5.660. Ramanujan-Berndt type transformation in terms of the cotangent function.

$$(5.663) \quad \sum_{p=1}^{\infty} \left( \frac{\alpha^2 p \coth(\alpha^2 p)}{a^2 - \alpha^2 p^2} + \frac{\beta^2 p \coth(\beta^2 p)}{a^2 + \beta^2 p^2} \right) + \frac{1}{2a^2} - \log \left( \frac{i\beta}{\alpha} \right) \\ = \begin{cases} \frac{1}{2} \pi (\cot(a\beta) - i \coth(a\alpha)), & \text{if } \operatorname{Re}(a) \geq 0, \\ -\frac{1}{2} \pi (\cot(a\beta) - i \coth(a\alpha)), & \text{if } \operatorname{Re}(a) < 0. \end{cases}$$

EXAMPLE 5.661.

$$(5.664) \quad \sum_{p=1}^{\infty} \left( \alpha (\coth(\alpha^2 p) - 1) \left( \frac{\log(a + 2\alpha p)}{a + 2\alpha p} - \frac{\log(a - 2\alpha p)}{a - 2\alpha p} \right) \right. \\ \left. + i\beta (\coth(\beta^2 p) - 1) \left( \frac{\log(a - 2i\beta p)}{a - 2i\beta p} - \frac{\log(a + 2i\beta p)}{a + 2i\beta p} \right) \right) \\ = \frac{1}{2} \left( \frac{-4 + \log(a)(-2a\alpha + 2ia\beta + 4)}{\log^2(e^a)} - 2 \log(2i\beta) \psi^{(0)} \left( 1 - \frac{ia}{2\beta} \right) \right. \\ \left. + \log(\alpha) \log(4\alpha) - 2 \log^2(2i\beta) + \log(i\beta) \log(4i\beta) + 2 \log^2(2) \right)$$

$$+ \log(2\alpha)\psi^{(0)}\left(\frac{a}{2\alpha} + 1\right) - \gamma_1\left(\frac{a}{2\alpha} + 1\right) + \gamma_1\left(1 - \frac{ia}{2\beta}\right)$$

EXAMPLE 5.662.

$$(5.665) \quad \sum_{p=1}^{\infty} \left( \left( \frac{e^{-\frac{p\pi\beta}{\alpha}}}{ia - 2p\beta} - \frac{e^{\frac{p\pi\beta}{\alpha}}}{ia + 2p\beta} \right) \beta (-1 + \coth(p\beta^2)) \right. \\ \left. - \frac{4(-1)^p p \alpha^2 (-1 + \coth(p\alpha^2))}{a^2 - 4p^2 \alpha^2} \right) \\ = \frac{1}{2} \left( \frac{-2ia\pi + 4\alpha - 2a\alpha^2 + 2ia\alpha\beta}{a^2 \alpha} \right. \\ \left. - H_{\frac{1}{4}(-2 + \frac{a}{\alpha})} + H_{\frac{a}{4\alpha}} + 2e^{-\frac{\pi\beta}{\alpha}} \Phi \left( e^{-\frac{\pi\beta}{\alpha}}, 1, 1 - \frac{ia}{2\beta} \right) \right)$$

EXAMPLE 5.663.

$$(5.666) \quad \sum_{p=1}^{\infty} (\coth(\beta^2 p) - 1) \sinh\left(\frac{\pi\beta p}{\alpha}\right) = \frac{1}{2} \left( \coth\left(\frac{\pi\beta}{2\alpha}\right) - \frac{\pi}{\alpha\beta} \right)$$

EXAMPLE 5.664.

$$(5.667) \quad \sum_{p=1}^{\infty} p \left( (-1)^p \left( \coth\left(\frac{\pi p}{\beta}\right) - 1 \right) \frac{\pi}{\beta} + \pi\beta \cosh(\pi\beta p) (\coth(\pi\beta p) - 1) \right) \\ = \frac{1}{4} \left( \frac{\pi}{\beta} - \pi\beta \operatorname{csch}^2\left(\frac{\pi\beta}{2}\right) - 2 \right)$$

EXAMPLE 5.665.

$$(5.668) \quad \sum_{p=1}^{\infty} p^2 (\coth(\beta^2 p) - 1) \sinh\left(\frac{\pi\beta p}{\alpha}\right) = \frac{1}{8} \sinh\left(\frac{\pi\beta}{\alpha}\right) \operatorname{csch}^4\left(\frac{\pi\beta}{2\alpha}\right)$$

EXAMPLE 5.666.

$$(5.669) \quad \sum_{p=1}^{\infty} (e^{-2imp}(3\pi - 2ip)^{-s} (\coth(p) - 1) - e^{2imp}(3\pi + 2ip)^{-s} (\coth(p) - 1) \\ + i\pi (e^{-2\pi mp}(3\pi - 2\pi p)^{-s} (\coth(\pi^2 p) - 1) - e^{2\pi mp}(2\pi p + 3\pi)^{-s} (\coth(\pi^2 p) - 1))) \\ = -i \left( e^{2im} (2i)^{1-s} \Phi \left( e^{2im}, s, 1 - \frac{3i\pi}{2} \right) - e^{2\pi m} (2\pi)^{1-s} \Phi \left( e^{2m\pi}, s, \frac{5}{2} \right) \right. \\ \left. + (3\pi)^{-s-1} (2s - 3\pi(2m + \pi - i)) \right)$$

EXAMPLE 5.667.

$$(5.670) \quad \sum_{p=1}^{\infty} p (\coth(p) + \pi^2 \coth(\pi^2 p) - \pi^2 - 1) = \frac{1}{12} (\pi^2 - 5)$$



EXAMPLE 5.668.

$$(5.671) \quad \sum_{p=1}^{\infty} \left( \frac{4ip (\coth(\pi^2 p) - 1)}{9 - 4p^2} + \frac{1 - \coth(p)}{3\pi + 2ip} + \frac{\coth(p) - 1}{3\pi - 2ip} \right) \\ = \frac{-4i + 6\pi - 9\pi^3 + 6i\pi^2 (-7 + 3\gamma + \log(64) - 3\log(\pi) + 3\psi^{(0)}(1 - \frac{3i\pi}{2}))}{18\pi^2}$$

EXAMPLE 5.669.

$$(5.672) \quad \sum_{p=1}^{\infty} \left( \tan^{-1} \left( \frac{2p}{3\pi} \right) (-1 + \coth(p)) + \pi \tanh^{-1} \left( \frac{2p}{3} \right) (-1 + \coth(p\pi^2)) \right) \\ = \log \left( \sqrt{\frac{\left( \frac{3\pi^3}{16} \right)^\pi \left( \frac{\Gamma(\frac{3i\pi}{2})}{\Gamma(-\frac{1}{2}(3i\pi))} \right)^i}{e^{\frac{2}{3\pi} + \frac{5\pi}{2}}}} \right)$$

EXAMPLE 5.670.

$$(5.673) \quad \sum_{p=1}^{\infty} p (\alpha^2 (\coth(\alpha^2 p) - 1) + \beta^2 (\coth(\beta^2 p) - 1)) = \frac{1}{12} (\alpha^2 + \beta^2 - 6)$$

EXAMPLE 5.671.

$$(5.674) \quad \log \left( \sqrt[4]{-\frac{i\alpha}{\beta} e^{-\frac{a\alpha + ia\beta + 2}{4a^2}}} \right) - \sum_{p=1}^{\infty} \left( \frac{\alpha^2 p (\coth(\alpha^2 p) - 1)}{4\alpha^2 p^2 - a^2} - \frac{\beta^2 p (\coth(\beta^2 p) - 1)}{a^2 + 4\beta^2 p^2} \right) \\ = \frac{1}{4} \left( H_{-\frac{ia}{2\beta}} - H_{\frac{a}{2\alpha}} \right)$$

EXAMPLE 5.672.

$$(5.675) \quad \sum_{n=-\infty}^{\infty} \frac{n \sinh(2m) e^{\alpha n}}{\cosh(2m) + \cosh(2\alpha n)} \\ = - \sum_{n=-\infty}^{\infty} \frac{\pi \cosh(m) \operatorname{sech} \left( \frac{\pi^2 n}{\alpha} \right) \left( \pi \tanh \left( \frac{\pi^2 n}{\alpha} \right) \sin \left( \frac{2\pi mn}{\alpha} \right) - 2m \cos \left( \frac{2\pi mn}{\alpha} \right) \right)}{2\alpha^2}$$

EXAMPLE 5.673.

$$(5.676) \quad \sum_{n=-\infty}^{\infty} \frac{\operatorname{sech}^2(m + n\alpha)}{e^{n\alpha}} = \sum_{n=-\infty}^{\infty} \frac{e^m \pi \operatorname{sech} \left( \frac{n\pi^2}{\alpha} \right) \left( \alpha \cos \left( \frac{2mn\pi}{\alpha} \right) - 2n\pi \sin \left( \frac{2mn\pi}{\alpha} \right) \right)}{\alpha^2}$$

EXAMPLE 5.674.

$$(5.677) \quad \sum_{n=-\infty}^{\infty} e^{\alpha(-n)} \tanh(m + \alpha n) = \frac{\pi e^m}{\alpha} \sum_{n=-\infty}^{\infty} \operatorname{sech} \left( \frac{\pi^2 n}{\alpha} \right) \cos \left( \frac{2\pi mn}{\alpha} \right)$$

EXAMPLE 5.675. A Dieckmann series in terms of the  $q$ -digamma function derived using [25] and equation (5.677).

$$(5.678) \quad \sum_{n=-\infty}^{\infty} \frac{\tanh(n\pi\alpha)}{e^{n\pi\alpha}} = -\frac{1}{\alpha} + \frac{2i \left( \psi_{e^{-\frac{\pi}{\alpha}}}^{(0)} \left( -\frac{1}{2}(i\alpha) \right) - \psi_{e^{-\frac{\pi}{\alpha}}}^{(0)} \left( \frac{i\alpha}{2} \right) \right)}{\pi}$$

EXAMPLE 5.676.

$$(5.679) \quad \sum_{p=1}^{\infty} (-1)^p \left( \frac{\log(2p-1)}{1-2p} + \frac{\log(2p+1)}{2p+1} \right) = -\frac{1}{2}\pi \log \left( \frac{2e^{\gamma}\pi\Gamma\left(-\frac{1}{4}\right)^2}{9\Gamma\left(-\frac{3}{4}\right)^2} \right)$$

EXAMPLE 5.677.

$$(5.680) \quad \sum_{p=1}^{\infty} \left( \frac{e^{imp}}{(-1+a+p)^s} - \frac{e^{-imp}}{(-1+a-p)^s} + i \left( \frac{e^{mp}}{(-1+a-ip)^s} - \frac{e^{-mp}}{(-1+a+ip)^s} \right) \right) \\ (-1 + \coth(p\pi)) \\ = \frac{-i(-1+a)(m - (1+i)\pi) + s}{\pi(-1+a)^{s+1}} + 2ie^{-m-\frac{i\pi s}{2}} \Phi(e^{-m}, s, (1+i) - ia) \\ - 2e^{im} \Phi(e^{im}, s, a)$$

EXAMPLE 5.678.

$$(5.681) \quad \left( 1 - \frac{2p}{2a+p-1} \right)^{\frac{1}{2}(-1)^p(\coth(p\pi)-1)} \left( \frac{(2a+ip-1)e^{-2p\pi}}{2a-ip-1} \right)^{\frac{1}{2}i\operatorname{csch}(p\pi)} \\ = \frac{\exp\left(\frac{1}{2}\left(\frac{\pi}{e^{\pi}-1} + \frac{1}{(2a-1)\pi} + 2ie^{-\pi}\Phi'(e^{-\pi}, 0, (1+i) - 2ia)\right)\right) \Gamma(a)}{\sqrt{a - \frac{1}{2}}\Gamma\left(a - \frac{1}{2}\right)}$$

EXAMPLE 5.679.

$$(5.682) \quad \sum_{p=1}^{\infty} \left( \frac{e^{imp}}{(-1+a+p)^s} - \frac{e^{-imp}}{(-1+a-p)^s} + i \left( \frac{e^{mp}}{(-1+a-ip)^s} - \frac{e^{-mp}}{(-1+a+ip)^s} \right) \right) \\ (-1 + \coth(p\pi)) \\ = \frac{-i(-1+a)(m - (1+i)\pi) + s}{\pi(-1+a)^{s+1}} + 2ie^{-m-\frac{i\pi s}{2}} \Phi(e^{-m}, s, (1+i) - ia) \\ - 2e^{im} \Phi(e^{im}, s, a)$$

EXAMPLE 5.680.

$$(5.683) \quad \sum_{p=1}^{\infty} \coth(\pi p) - 1 \left( \log \left( \frac{a-p-1}{a+p-1} \right) + i \log \left( \frac{a+ip-1}{a-ip-1} \right) \right) \\ = \log \left( -\frac{(2\pi)^{1-i}(-i(a-1))^{2i} \exp\left(2i\log\Gamma(-i(a-1)) + \pi\left(-\frac{1}{2} + ia\right) + \frac{1}{\pi(a-1)}\right)}{(a-1)^{1+i}\Gamma(a-1)^2} \right)$$

EXAMPLE 5.681.

$$\begin{aligned}
(5.684) \quad \sum_{p=1}^{\infty} (\coth(\pi p) - 1) & \left( \frac{\log(a-p-1)}{a-p-1} - \frac{\log(a+p-1)}{a+p-1} \right. \\
& \left. + i \left( \frac{\log(a-ip-1)}{-a+ip+1} + \frac{\log(a+ip-1)}{a+ip-1} \right) \right) \\
& = -2\gamma_1((1+i) - ia) + 2\gamma_1(a) \\
& + \frac{-\pi^3(a-1)^2 + (-4 + (4-4i)\pi(a-1)) \log(a-1) + 4}{4\pi(a-1)^2} \\
& \qquad \qquad \qquad + i\pi\psi^{(0)}((1+i) - ia)
\end{aligned}$$

EXAMPLE 5.682.

$$\begin{aligned}
(5.685) \quad \sum_{p=1}^{\infty} (\coth(\pi p) - 1) & \left( \sin\left(\frac{\pi p}{3}\right) + \sinh\left(\frac{\pi p}{3}\right) \right) = \frac{1}{6} \left( -1 - 3\sqrt{3} + 3 \coth\left(\frac{\pi}{6}\right) \right)
\end{aligned}$$

EXAMPLE 5.683.

$$(5.686) \quad \sum_{p=1}^{\infty} p(\coth(\pi p) - 1) \left( \cos\left(\frac{\pi p}{3}\right) + \cosh\left(\frac{\pi p}{3}\right) \right) = \frac{1}{4} \left( 5 - \frac{2}{\pi} - \coth^2\left(\frac{\pi}{6}\right) \right)$$

EXAMPLE 5.684. Infinite series involving the incomplete beta function  $B_x(a, b)$ .

$$\begin{aligned}
(5.687) \quad \sum_{p=1}^{\infty} p \left( \frac{(-1)^p}{p^2 - a^2} - \frac{e^{-\pi p}}{a^2 + p^2} \right) \coth(\pi p) \\
= \frac{1}{2} \left( \frac{1}{\pi a^2} + 2e^{-\pi} \Phi(e^{-\pi}, 1, 1 - ia) - \pi \csc(\pi a) \right. \\
\left. - e^{-i\pi a} B_{e^{-\pi}}(1 - ia, 0) + e^{i\pi a} B_{e^{-\pi}}(ia + 1, 0) \right)
\end{aligned}$$

EXAMPLE 5.685.

$$\begin{aligned}
(5.688) \quad \sum_{p=1}^{\infty} \left( -\frac{4e^{-i\pi p}}{(9-2p)^2} + \frac{e^{i\pi p}}{(p+\frac{9}{2})^2} - \frac{4ie^{\pi p}}{(2p+9i)^2} + \frac{4ie^{\pi(-p)}}{(-2p+9i)^2} \right) (\coth(\pi p) - 1) \\
\approx -8C - 2ie^{-\pi} \Phi\left(e^{-\pi}, 2, 1 - \frac{9i}{2}\right) + \frac{726052}{99225} + \frac{16}{729\pi}
\end{aligned}$$

EXAMPLE 5.686.

$$\begin{aligned}
(5.689) \quad \sum_{p=1}^{\infty} (\Gamma(0, i(p-m)\pi) + \Gamma(0, -i(m+p)\pi)) \\
= \log\left(\frac{1}{2}(1 + i \cot(\pi m))\right) - \Gamma(0, -im\pi)
\end{aligned}$$

EXAMPLE 5.687.

$$(5.690) \quad \sum_{p=1}^{\infty} \left( \frac{\Gamma(1+k, i(p-m)\pi)}{(p-m)^{k+1}} + \frac{\Gamma(1+k, -i(m+p)\pi)}{(-m-p)^{k+1}} \right) \\ = \frac{(-1)^k \Gamma(1+k, -im\pi)}{m^{k+1}} + \Gamma(1+k) \left( -(-1)^k \zeta(1+k, 1+m) + \zeta(1+k, -m) \right)$$

EXAMPLE 5.688.

$$(5.691) \quad \sum_{p=1}^{\infty} (-1)^p (E_2(i(1-2p)\pi) + E_2(i(2p+1)\pi)) = -4iC + (1+4i) + i\pi\Gamma(0, i\pi)$$

EXAMPLE 5.689.

$$(5.692) \quad \sum_{p=1}^{\infty} \frac{p(a^4 + p^4) \coth(\pi p)}{(a^4 - p^4)^2} = \frac{\pi^3 a^3 \csc^2(\pi a) - i\pi^3 a^3 \operatorname{csch}^2(\pi a) - 2}{8\pi a^4}$$

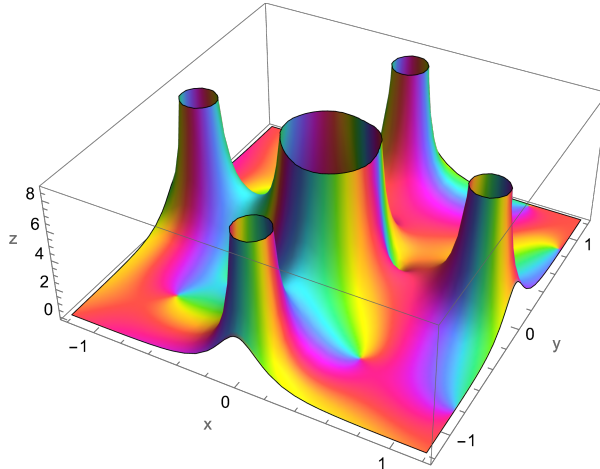

FIGURE 23. Plot of  $f(a) = \frac{\pi^3 a^3 \csc^2(\pi a) - i\pi^3 a^3 \operatorname{csch}^2(\pi a) - 2}{8\pi a^4}$ ,  $a \in \mathbb{C}$ .

EXAMPLE 5.690.

$$(5.693) \quad \sum_{p=1}^{\infty} \frac{(-2p+i)E_1\left(\frac{\pi}{2} - ip\pi\right) + (2p+i)E_1\left(ip\pi + \frac{\pi}{2}\right)}{4p^2 + 1} \\ = i \left( -\pi Li'_0(e^{-\pi}) + \operatorname{Ei}\left(-\frac{\pi}{2}\right) + \frac{\pi \log(2)}{e^\pi - 1} \right)$$

EXAMPLE 5.691.

$$(5.694) \quad \sum_{p=1}^{\infty} \left( \frac{E_1\left(\frac{1}{2}(2ip + (1-i))\pi\right)}{(1+i)p - i} - \frac{E_1\left(\frac{1}{2}((1-i) - 2ip)\pi\right)}{(1+i)p + i} \right)$$

$$= -(1+i)\pi \left( Li'_0(-e^{-\pi}) + \frac{\log(2)}{1+e^\pi} \right) - iE_1 \left( \left( \frac{1}{2} - \frac{i}{2} \right) \pi \right)$$

EXAMPLE 5.692. The generalized hypergeometric function  ${}_3F_3(a, a, a; b, b, b; z)$ .

$$\begin{aligned} (5.695) \quad & \sum_{p=1}^{\infty} 2 \left( 3\pi(-1-2ip) {}_3F_3 \left( 1, 1, 1; 2, 2, 2; \left( -ip - \frac{1}{2} \right) \pi \right) \right. \\ & \quad \left. + 3\pi(-1+2ip) {}_3F_3 \left( 1, 1, 1; 2, 2, 2; \left( ip - \frac{1}{2} \right) \pi \right) \right. \\ & \quad \left. + 6 \log \left( -\frac{i}{\pi} \right) \left( \text{Ei} \left( \left( -ip - \frac{1}{2} \right) \pi \right) + \text{Ei} \left( \left( ip - \frac{1}{2} \right) \pi \right) \right) \right. \\ & \quad \left. + 3 \left( \log^2 \left( \frac{1}{2} \pi(1-2ip) \right) + \log^2 \left( \frac{1}{2} \pi(1+2ip) \right) + 2\gamma \log \left( \frac{1}{2} \pi(1-2ip) \right) \right. \right. \\ & \quad \quad \left. \left. + 2\gamma \log \left( \frac{1}{2} \pi(1+2ip) \right) \right) + \pi^2 + 6\gamma^2 \right) \\ & = 6\pi \left( {}_3F_3 \left( 1, 1, 1; 2, 2, 2; -\frac{\pi}{2} \right) + i \text{Ei} \left( -\frac{\pi}{2} \right) + \log(4) - i \log(e^\pi - 1) + 2 \log(\pi) \right) \\ & \quad - 6 \left( 2 \text{PolyLog}^{(1,0)}(1, e^{-\pi}) + \log(\pi) \left( -2 \text{Ei} \left( -\frac{\pi}{2} \right) + 2 \log(e^\pi - 1) + \log(\pi) \right) \right. \\ & \quad \quad \left. + \log^2(2) + \log(4) (\log(e^\pi - 1) - \log(\pi)) \right) + (-1 + 6i)\pi^2 \\ & \quad \quad \quad - 6\gamma \left( \gamma + \log \left( \frac{\pi^2}{4} \right) \right) \end{aligned}$$

EXAMPLE 5.693. Sum product formula in terms of  $q$ -digamma function.

$$\begin{aligned} (5.696) \quad & \sum_{k=1}^n 2e^{\Gamma(0, \pi(\frac{2k}{n} + \frac{x}{\pi}))} \prod_{p=1}^{\infty} \exp \left( \Gamma \left( 0, i\pi \left( p - i \left( \frac{2k}{n} + \frac{x}{\pi} \right) \right) \right) + \Gamma \left( 0, -i\pi \left( p + i \left( \frac{2k}{n} + \frac{x}{\pi} \right) \right) \right) \right) \\ & = \frac{n}{2\pi} \left( -\psi_{e^{\frac{2\pi}{n}}}^{(0)} \left( \frac{nx}{2\pi} + 1 \right) + \psi_{e^{\frac{2\pi}{n}}}^{(0)} \left( \frac{xn}{2\pi} + n + 1 \right) - \psi_{e^{\frac{2\pi}{n}}}^{(0)} \left( \frac{1}{2}n \left( \frac{x}{\pi} - i \right) + 1 \right) \right. \\ & \quad \quad \quad \left. + \psi_{e^{\frac{2\pi}{n}}}^{(0)} \left( \frac{1}{2}n \left( \frac{x}{\pi} + (2-i) \right) + 1 \right) \right) \end{aligned}$$

EXAMPLE 5.694. The digamma function  $\psi^{(0)}(z+1)$ .

$$(5.697) \quad \psi^{(0)}(z+1) = -\frac{\zeta'(1-z)}{\zeta(1-z)} - \frac{\zeta'(z)}{\zeta(z)} + \frac{1}{z} + \frac{1}{2}\pi \tan \left( \frac{\pi z}{2} \right) + \log(2\pi)$$

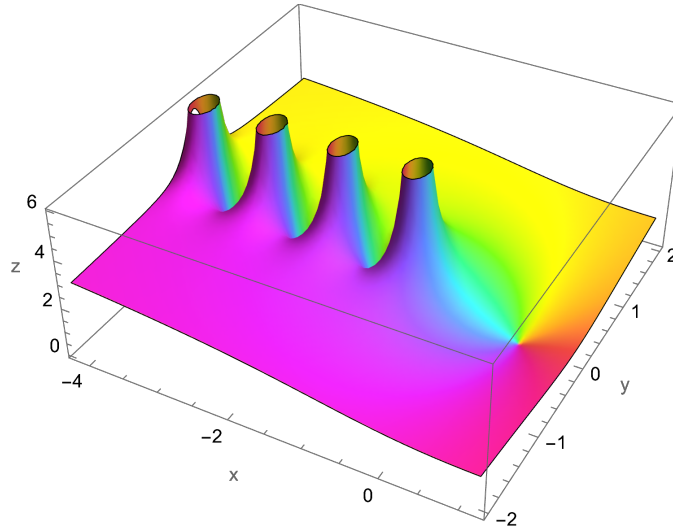
FIGURE 24. Plot of  $f(z) = \psi^{(0)}(z+1)$ ,  $z \in \mathbb{C}$ .

EXAMPLE 5.695.

$$(5.698) \quad \sum_{p=0}^{\infty} \left( \Gamma \left( -1, \frac{i\pi(im - (2p+1)x)}{2x} \right) + \Gamma \left( -1, \frac{i\pi(im + (2p+1)x)}{2x} \right) \right) \\ = \log \left( \frac{2 \cosh \left( \frac{\pi m}{2x} \right) \left( \sinh \left( \frac{\pi m}{2x} - \tanh \left( \frac{\pi m}{2x} \right) \right) + \cosh \left( \frac{\pi m}{2x} - \tanh \left( \frac{\pi m}{2x} \right) \right) \right)}{e} \right)$$

EXAMPLE 5.696.

$$(5.699) \quad \sum_{p=0}^{\infty} (-1)^p \left( \frac{E_1 \left( \frac{1}{2}i(4p+1)\pi \right)}{4p+1} + \frac{E_1 \left( -\frac{1}{2}i(4p+3)\pi \right)}{4p+3} \right) \\ = \frac{1}{2}(-1)^{3/4}\pi \left( \log \left( \Gamma \left( \frac{3}{8} \right) \right) - \log \left( 2\Gamma \left( \frac{7}{8} \right) \right) + i \log \left( \frac{2\Gamma \left( \frac{9}{8} \right)}{\Gamma \left( \frac{5}{8} \right)} \right) \right)$$

EXAMPLE 5.697.

$$(5.700) \quad \sum_{p=0}^{\infty} \left( \frac{E_1 \left( \frac{1}{2}i(2p-1)\pi \right)}{(2p-1)^3} - \frac{G_{2,3}^{3,0} \left( -\frac{1}{2}i(2p+3)\pi \mid \begin{matrix} 1, 1 \\ 0, 0, 2 \end{matrix} \right)}{(2p+3)^3} \right) \\ = \frac{1}{16}i(-14\pi\zeta(3) + 16 + \pi^3)$$

EXAMPLE 5.698. .

$$(5.701) \quad \sum_{p=0}^{\infty} \frac{(-1)^p \left( \frac{i}{a\pi} \right)^{2p} E_{1+2p}(x) (2)_{2p}}{\Gamma(2+2p)}$$

$$= -\frac{1}{2}a^2\pi^2 \left( \psi^{(0)} \left( \frac{1}{2}(1+a\pi-x) \right) - \psi^{(0)} \left( \frac{1}{2}(2+a\pi-x) \right) \right. \\ \left. - \psi^{(0)} \left( \frac{1}{2}(a\pi+x) \right) + \psi^{(0)} \left( \frac{1}{2}(1+a\pi+x) \right) \right)$$

EXAMPLE 5.699.

$$(5.702) \quad \sum_{p=0}^{\infty} \frac{(-1)^p \left(\frac{i}{a\pi}\right)^{2p} E_{1+2p}(x) (2)_{2p} (-1+\gamma+\psi^{(0)}(2+2p))}{\Gamma(2+2p)} \\ = -\frac{1}{2}a^2\pi^2 \left( -\psi^{(0)} \left( \frac{1}{2}(1+a\pi-x) \right) - \log(2)\psi^{(0)} \left( \frac{1}{2}(1+a\pi-x) \right) \right. \\ \left. - \log\left(\frac{1}{a}\right)\psi^{(0)} \left( \frac{1}{2}(1+a\pi-x) \right) + \log(\pi)\psi^{(0)} \left( \frac{1}{2}(1+a\pi-x) \right) \right. \\ \left. + \psi^{(0)} \left( \frac{1}{2}(2+a\pi-x) \right) + \log(2)\psi^{(0)} \left( \frac{1}{2}(2+a\pi-x) \right) + \log\left(\frac{1}{a}\right)\psi^{(0)} \left( \frac{1}{2}(2+a\pi-x) \right) \right. \\ \left. - \log(\pi)\psi^{(0)} \left( \frac{1}{2}(2+a\pi-x) \right) + \psi^{(0)} \left( \frac{1}{2}(a\pi+x) \right) + \log(2)\psi^{(0)} \left( \frac{1}{2}(a\pi+x) \right) \right. \\ \left. + \log\left(\frac{1}{a}\right)\psi^{(0)} \left( \frac{1}{2}(a\pi+x) \right) - \log(\pi)\psi^{(0)} \left( \frac{1}{2}(a\pi+x) \right) - \psi^{(0)} \left( \frac{1}{2}(1+a\pi+x) \right) \right. \\ \left. - \log(2)\psi^{(0)} \left( \frac{1}{2}(1+a\pi+x) \right) - \log\left(\frac{1}{a}\right)\psi^{(0)} \left( \frac{1}{2}(1+a\pi+x) \right) \right. \\ \left. + \log(\pi)\psi^{(0)} \left( \frac{1}{2}(1+a\pi+x) \right) + \gamma_1 \left( \frac{1}{2}(1+a\pi-x) \right) \right. \\ \left. - \gamma_1 \left( \frac{1}{2}(2+a\pi-x) \right) - \gamma_1 \left( \frac{1}{2}(a\pi+x) \right) + \gamma_1 \left( \frac{1}{2}(1+a\pi+x) \right) \right)$$

EXAMPLE 5.700.

$$(5.703) \quad \sum_{p=0}^{\infty} \frac{E_{2p+1} \left(-\frac{1}{2}\right) (1-k)_{2p}}{\Gamma(2p+2)} = -\frac{2^{-k} (3^k - 1)}{k}$$

EXAMPLE 5.701.

$$(5.704) \quad \sum_{p=0}^{2n} (-1)^{p+2p} 4^{-p} \Phi \left( (-1)^{2^{p+1}}, 2, \frac{1}{4} (2-2^{-p}) \right) \\ - \sum_{p=0}^n (-1)^{4p} 2^{1-4p} \Phi \left( (-1)^{2^{2p+1}}, 2, \frac{1}{4} (2-4^{-p}) \right) \\ = 16C + (-1)^{2^{2n+1}} 2^{-4n} \Phi \left( (-1)^{2^{2n+1}}, 2, 1-2^{-2(n+1)} \right)$$

EXAMPLE 5.702.

$$(5.705) \quad \sum_{p=0}^n 2^{-p-1} \left( \log \Gamma(i2^p m) + \log \Gamma(-i2^p m - 1) - \log \Gamma \left( -i2^p m - \frac{1}{2} \right) \right)$$

$$\begin{aligned}
& -\log\Gamma\left(i2^p m - \frac{1}{2}\right) + \log\left(\frac{m2^p - i}{m^2 4^{p+1} + 1}\right) \\
= & \log\left(\frac{i2^{2^{1-n}-4}\pi^{2^{-n-1}}(m2^{n+1} - i)^{-2^{-n-1}} \operatorname{csch}(\pi m)}{m}\right) \\
& - 2^{-n-1}(\log\Gamma(i2^{n+1}m) + \log\Gamma(-i2^{n+1}m - 1))
\end{aligned}$$

EXAMPLE 5.703.

$$\begin{aligned}
(5.706) \quad & -\sum_{p=0}^n 4^{-p} e^{i\pi 2^p} \left(\Phi\left(-e^{i2^p\pi}, 2, 1 - 2^{-p-1}\right) + \Phi\left(e^{i2^p\pi}, 2, 1 - 2^{-p-1}\right)\right) \\
& = 8C + 2^{-2n-1} e^{i\pi 2^{n+1}} \Phi\left(e^{i2^{n+1}\pi}, 2, 1 - 2^{-n-2}\right)
\end{aligned}$$

EXAMPLE 5.704.

$$\begin{aligned}
(5.707) \quad & \sum_{p=0}^n \frac{4^p e^{i\pi 2^{-n+p-1}}}{(-1 + e^{i\pi 2^{p-n}})^3} \left(\left(-1 + e^{i\pi 2^{p-n}}\right)^3 \Phi'\left(-e^{i\pi 2^{-n+p-1}}, -2, 1\right)\right. \\
& \left. + \left(-1 + e^{i\pi 2^{p-n}}\right)^3 \Phi'\left(e^{i\pi 2^{-n+p-1}}, -2, 1\right) + 2\left(6e^{i\pi 2^{p-n}} + e^{i\pi 2^{-n+p+1}} + 1\right) \log(i2^p)\right) \\
& = 2e^{i\pi 2^{-n-1}} \Phi'\left(e^{i\pi 2^{-n-1}}, -2, 1\right) + \frac{7 \cdot 2^{2n+1} \zeta(3)}{\pi^2} - \frac{1}{4} \pi \cot(\pi 2^{-n-2}) \operatorname{csc}^2(\pi 2^{-n-2})
\end{aligned}$$

EXAMPLE 5.705.

$$\begin{aligned}
(5.708) \quad & -\sum_{p=0}^n \frac{1}{2} i e^{-i\pi 2^{-n+p-1}} \operatorname{csc}^2(\pi 2^{-n+p-1}) \left(\log(i2^p) \left(2^{p+1} \left(1 + e^{i\pi 2^{p-n}}\right)\right.\right. \\
& \left. \left. + i\left(-1 + e^{i\pi 2^{p-n}}\right) \log\left(e^{-i2^{n+1}}\right)\right) - 2^p \left(-1 + e^{i\pi 2^{p-n}}\right)^2 \right. \\
& \left. \left(\Phi'\left(-e^{i\pi 2^{-n+p-1}}, -1, 1 - i2^{-p-1} \log\left(e^{-i2^{n+1}}\right)\right)\right.\right. \\
& \left. \left. + \Phi'\left(e^{i\pi 2^{-n+p-1}}, -1, 1 - i2^{-p-1} \log\left(e^{-i2^{n+1}}\right)\right)\right)\right) \\
& = \frac{1}{2} \left(-i2^{n+4} \Phi'\left(-1, -1, 1 - i2^{-n-2} \log\left(e^{-i2^{n+1}}\right)\right)\right. \\
& \left. - 8ie^{i\pi 2^{-n-1}} \Phi'\left(e^{i\pi 2^{-n-1}}, -1, 1 - \frac{1}{2}i \log\left(e^{-i2^{n+1}}\right)\right)\right) \\
& \quad + i2^{n+2} \log(i2^{n+1}) + \pi \operatorname{csc}^2(\pi 2^{-n-2}) \\
& \quad - \log\left(e^{-i2^{n+1}}\right) \left(\pi \cot(\pi 2^{-n-2}) + i\right) - 2 \log(i2^{n+1})
\end{aligned}$$

EXAMPLE 5.706.

$$\begin{aligned}
(5.709) \quad & \lim_{n \rightarrow \infty} \sum_{j=1}^n \frac{1}{j} \left(\operatorname{sech}\left(\frac{bj}{n}\right) \cosh\left(\frac{cj}{n}\right) \sinh\left(\frac{jm}{n}\right) + \operatorname{sech}\left(\frac{bn}{j}\right) \cosh\left(\frac{cn}{j}\right) \sinh\left(\frac{mn}{j}\right)\right) \\
& = \frac{1}{2} \log\left(\tan\left(\frac{\pi(b-c+m)}{4b}\right) \tan\left(\frac{\pi(b+c+m)}{4b}\right)\right)
\end{aligned}$$



EXAMPLE 5.707.

$$\begin{aligned}
 (5.710) \quad & \sum_{p=0}^{n-1} \frac{(-1)^p}{\sin^2\left(\frac{m\pi}{\alpha}\right)} \left( (1+2p) \sin\left(\frac{m(-1+4n-2p)\pi}{2n\alpha}\right) + (1-4n+2p) \sin\left(\frac{m(1+2p)\pi}{2n\alpha}\right) \right) \\
 & = -\sec\left(\frac{m\pi}{2n\alpha}\right) \tan\left(\frac{m\pi}{2n\alpha}\right)
 \end{aligned}$$

EXAMPLE 5.708.

$$\begin{aligned}
 (5.711) \quad & \sum_{p=0}^{n-1} e^{ip\pi\left(1-\frac{m}{n\alpha}\right)} \left( e^{\frac{2im\pi}{\alpha}}(-1+4n-2p) + e^{\frac{4im\pi}{\alpha}}(1+2p) \right. \\
 & \quad \left. - e^{\frac{im(1+2p)\pi}{n\alpha}}(1+2p) + e^{\frac{im(1+2n+2p)\pi}{n\alpha}}(1-4n+2p) \right) \csc^3\left(\frac{m\pi}{\alpha}\right) \\
 & = -\frac{2ie^{\frac{im(1+4n)\pi}{2n\alpha}} \tan\left(\frac{m\pi}{2n\alpha}\right)}{\sin\left(\frac{m\pi}{\alpha}\right) \cos\left(\frac{m\pi}{2n\alpha}\right)}
 \end{aligned}$$

EXAMPLE 5.709.

$$\begin{aligned}
 (5.712) \quad & \sum_{p=0}^{n-1} 2^{-p} (2 \sec^2(2^{1-p}m) - \sec^2(2^{-p}m) - 2 \sec^2(2^{1-p}r) + \sec^2(2^{-p}r)) \\
 & = 2 (\sec^2(2m) - \sec^2(2r) + 2^{-n} (-\sec^2(2^{1-n}m) + \sec^2(2^{1-n}r)))
 \end{aligned}$$

EXAMPLE 5.710.

$$\begin{aligned}
 (5.713) \quad & \sum_{p=0}^{n-1} 2^{-p} \left( -\frac{m^{2^{-p}}}{(1+m^{2^{-p}})^2} + \frac{2}{(m^{-2^{-p}}+m^{2^{-p}})^2} + \frac{r^{2^{-p}}}{(1+r^{2^{-p}})^2} - \frac{2}{(r^{-2^{-p}}+r^{2^{-p}})^2} \right) \\
 & = 2 \left( \frac{m^2}{(1+m^2)^2} - \frac{r^2}{(1+r^2)^2} + 2^{-n} \left( -\frac{1}{(m^{-2^{-n}}+m^{2^{-n}})^2} + \frac{1}{(r^{-2^{-n}}+r^{2^{-n}})^2} \right) \right)
 \end{aligned}$$

EXAMPLE 5.711.

$$\begin{aligned}
 (5.714) \quad & \sum_{p=0}^{\infty} 2^{-p} \left( -\frac{m^{2^{-p}}}{(1+m^{2^{-p}})^2} + \frac{2}{(m^{-2^{-p}}+m^{2^{-p}})^2} + \frac{r^{2^{-p}}}{(1+r^{2^{-p}})^2} - \frac{2}{(r^{-2^{-p}}+r^{2^{-p}})^2} \right) \\
 & = \frac{2m^2}{(1+m^2)^2} - \frac{2r^2}{(1+r^2)^2}
 \end{aligned}$$

EXAMPLE 5.712.

$$\begin{aligned}
 (5.715) \quad & \sum_{p=0}^{n-1} 2^{-p} \left( -\frac{2}{((im)^{-2^{-p}}+(im)^{2^{-p}})^2} + \frac{(im)^{2^{-p}}}{(1+(im)^{2^{-p}})^2} - \frac{m^{2^{-p}}}{(1+m^{2^{-p}})^2} + \frac{2}{(m^{-2^{-p}}+m^{2^{-p}})^2} \right) \\
 & = \frac{4(m^2+m^6)}{(-1+m^4)^2}
 \end{aligned}$$

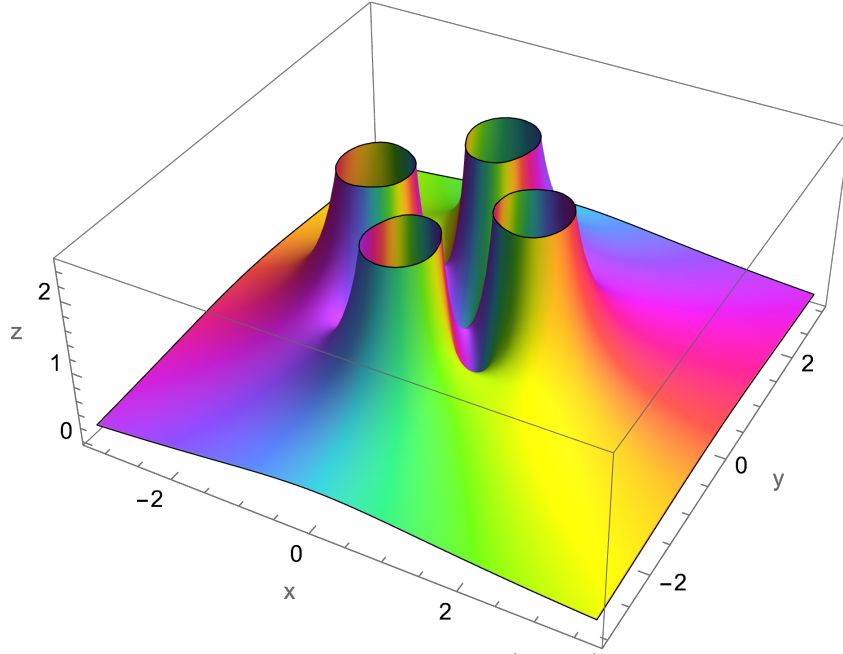

FIGURE 25. Plot of  $f(m) = \frac{4(m^6+m^2)}{(m^4-1)^2}$ ,  $m \in \mathbb{C}$ .

EXAMPLE 5.713. From Eq. (41.2.24) in [24] and Eq. (4.16).

$$(5.716) \quad \sum_{k=0}^{n-1} (-1)^k \sinh \left( a \cosh^{-1} \left( -\cos \left( \frac{\pi + 2k\pi}{2n} \right) \right) \right) = \frac{i \sin(a\pi)}{2 \cos \left( \frac{a\pi}{2n} \right)}$$

EXAMPLE 5.714.

$$(5.717) \quad \sum_{p=0}^{n-1} (-1)^p \exp \left( \frac{m (i(1-2n)\pi - 2n \cosh^{-1} (-\cos(\frac{\pi+2p\pi}{2n})))}{2cn} \right) \sqrt{-1 + \cos \left( \frac{\pi + 2p\pi}{n} \right)}$$

$$\csc \left( \frac{\pi + 2p\pi}{2n} \right) \left( e^{\frac{2m \cosh^{-1} (-\cos(\frac{\pi+2p\pi}{2n}))}{c}} \Phi \left( e^{-\frac{2im\pi}{c}}, -k, \frac{\pi + i \cosh^{-1} (-\cos(\frac{\pi+2p\pi}{2n})) - ic \log(a)}{2\pi} \right) \right.$$

$$\left. - \Phi \left( e^{-\frac{2im\pi}{c}}, -k, -\frac{i(i\pi + \cosh^{-1} (-\cos(\frac{\pi+2p\pi}{2n})) + c \log(a))}{2\pi} \right) \right.$$

$$\left. - e^{\frac{2im\pi}{c}} \Phi \left( e^{\frac{2im\pi}{c}}, -k, \frac{\pi + i \cosh^{-1} (-\cos(\frac{\pi+2p\pi}{2n})) - ic \log(a)}{2\pi} \right) \right.$$

$$\left. + \exp \left( \frac{2m (i\pi + \cosh^{-1} (-\cos(\frac{\pi+2p\pi}{2n})))}{c} \right) \right.$$

$$\left. \Phi \left( e^{\frac{2im\pi}{c}}, -k, -\frac{i(i\pi + \cosh^{-1} (-\cos(\frac{\pi+2p\pi}{2n})) + c \log(a))}{2\pi} \right) \right)$$

$$= i2^{\frac{1}{2}-k}n^{-k} \left( \Phi \left( -e^{-\frac{im\pi}{cn}}, -k, \frac{1}{2} - \frac{icn \log(a)}{\pi} \right) - e^{\frac{im\pi}{cn}} \Phi \left( -e^{\frac{im\pi}{cn}}, -k, \frac{1}{2} - \frac{icn \log(a)}{\pi} \right) \right)$$

EXAMPLE 5.715.

$$(5.718) \quad \sum_{p=0}^{n-1} \sqrt{-1 + \cos \left( \frac{\pi + 2p\pi}{n} \right)} \operatorname{csc} \left( \frac{\pi + 2p\pi}{2n} \right) \left( \zeta \left( -k, \frac{\pi + b\pi - i \cosh^{-1} \left( -\cos \left( \frac{\pi + 2p\pi}{2n} \right) \right)}{2\pi} \right) + \zeta \left( -k, \frac{\pi + b\pi + i \cosh^{-1} \left( -\cos \left( \frac{\pi + 2p\pi}{2n} \right) \right)}{2\pi} \right) \right) = i2^{\frac{1}{2}-k}n^{-k} \zeta \left( -k, \frac{1}{2} + bn \right)$$

EXAMPLE 5.716.

$$(5.719) \quad \sum_{p=0}^{n-1} \frac{2^{-p} (2 + 4 \cos (2^{1-p}m) - 2 \cos (2^{2-p}m) + 2^p \log(a) \sin (2^{2-p}m))}{(\cos (2^{-p}m) + \cos (3 \cdot 2^{-p}m))^2} = \frac{2 (4 - 2^{3-n} \cos^2(2m) + 4 \cos (2^{2-n}m) + \log(a) (\sin(4m) - \sin (2^{2-n}m) + \sin (4 (1 - 2^{-n}) m)))}{2 + 2 \cos(4m) + 2 \cos (2^{2-n}m) + \cos (4 (1 - 2^{-n}) m) + \cos (4 (1 + 2^{-n}) m)}$$

EXAMPLE 5.717.

$$(5.720) \quad \sum_{p=0}^{n-1} \left( 2^p \log \left( \frac{1 - \tan^2 (2^{-p}x)}{1 - \tan^2 (2^{1-p}x)} \right) + \frac{2 (\sec (2^{-p}x) \tan (2^{1-p}x) - \sec (2^{1-p}x) \tan (2^{-p}x))}{\log(a)} \right) = - \int_{\frac{x}{2}}^x \frac{4 (4 - 2^{3-n} \cos^2(2m) + 4 \cos (2^{2-n}m) + \log(a) (\sin(4m) - \sin (2^{2-n}m) + \sin (4 (1 - 2^{-n}) m)))}{(2 + 2 \cos(4m) + 2 \cos (2^{2-n}m) + \cos (4 (1 - 2^{-n}) m) + \cos (4 (1 + 2^{-n}) m)) \log(a)} dm$$

EXAMPLE 5.718.

$$(5.721) \quad \sum_{p=0}^{n-1} \frac{4^{-p} q^{2^{-p}} \left( -1 + q^{2^{-p}} \left( 5 + q^{2^{-p}} \left( 9 + q^{2^{-p}} \left( 11 + q^{2^{-p}} \left( -11 + q^{2^{-p}} \left( -9 + q^{2^{-p}} \left( -5 + q^{2^{-p}} \right) \right) \right) \right) \right) \right) \right) \right)}{(1 + q^{2^{1-p}})^3 (1 + q^{2^{-p}})^3} = 4 \left( \frac{q^2}{(1 + q^2)^3} - \frac{q^4}{(1 + q^2)^3} + \frac{4^{-n} q^{2^{1-n}} (-1 + q^{2^{1-n}})}{(1 + q^{2^{1-n}})^3} \right)$$

EXAMPLE 5.719.

$$(5.722) \quad \sum_{j=0}^{\infty} \sum_{n=0}^{\infty} \sum_{p=0}^{\infty} \frac{4^p (-t)^{j+2p} u^n \binom{-1+n+j(-1+\alpha)}{-j+n} E_{1+2p}(x) \Gamma(1 + j + 2p)}{\Gamma(1 + j) \Gamma(2 + 2p)}$$

$$= \frac{\log \left( \frac{\Gamma(\frac{1}{4}(2+\frac{1}{t}+(1-u)^{-\alpha}u-2x))\Gamma(\frac{1}{4}(2+\frac{1}{t}+(1-u)^{-\alpha}u+2x))}{\Gamma(\frac{1}{4}(4+\frac{1}{t}+(1-u)^{-\alpha}u-2x))\Gamma(\frac{1}{4}(\frac{1}{t}+(1-u)^{-\alpha}u+2x))} \right)}{2t}$$

EXAMPLE 5.720.

$$(5.723) \quad \sum_{p=0}^n \frac{4^{-p}b^{2^{-p}}(-1+b^{2^{1-p}})m^{2^{-p}}(-1+m^{2^{1-p}})}{(b^{2^{-p}}+m^{2^{-p}})^2(1+b^{2^{-p}}m^{2^{-p}})^2}$$

$$= 2^{-1-2n}(bm)^{-2^{-n}} \left( \frac{(bm)^{2^{1-n}}}{(-1+b^{2^{-n}}m^{2^{-n}})^3} + b^{2^{-n}}m^{2^{-n}} \left( \frac{2b^{2^{1-n}}}{(b^{2^{-n}}-m^{2^{-n}})^2} + \frac{2}{-1+b^{2^{-n}}m^{2^{-n}}} \right. \right.$$

$$\left. \left. - \frac{1}{(-1+b^{2^{-n}}m^{2^{-n}})^3} - \frac{3}{(-1+b^{2^{-n}}m^{2^{-n}})^2} - \frac{2}{-1+b^{2^{-n}}m^{2^{-n}}} \right. \right.$$

$$\left. \left. + 2^{3+2n}b^2m^2 \left( \frac{m^2}{(b^2-m^2)^3} - \frac{1}{(-1+b^2m^2)^3} \right) + 2^{3+2n}b^4m^2 \left( -\frac{1}{(b^2-m^2)^3} \right. \right.$$

$$\left. \left. + \frac{m^2}{(-1+b^2m^2)^3} \right) \right)$$

EXAMPLE 5.721.

$$(5.724) \quad \sum_{p=0}^{\infty} \frac{4^{-p}b^{2^{-p}}(-1+b^{2^{1-p}})m^{2^{-p}}(-1+m^{2^{1-p}})}{(b^{2^{-p}}+m^{2^{-p}})^2(1+b^{2^{-p}}m^{2^{-p}})^2}$$

$$= -\frac{4b^2(-1+b^4)m^2(-1+m^4)}{(-b^2+m^2+b^4m^2-b^2m^4)^2} + \frac{1}{\log^2(\frac{b}{m})} - \frac{1}{\log^2(bm)}$$

EXAMPLE 5.722.

$$(5.725) \quad \sum_{p=0}^{\infty} \frac{4^{-p} \left( -1 + \left( \frac{1}{q} \right)^{2^{1-p}} \right) \left( -1 + (iq)^{2^{1-p}} \right) \left( \frac{1}{q} \right)^{2^{-p}} (iq)^{2^{-p}}}{\left( \left( \frac{1}{q} \right)^{2^{-p}} + (iq)^{2^{-p}} \right)^2 \left( 1 + \left( \frac{1}{q} \right)^{2^{-p}} (iq)^{2^{-p}} \right)^2}$$

$$= \frac{4}{\pi^2} - \frac{(-1+q^4)^2}{(1+q^4)^2} + \frac{1}{\log^2\left(-\frac{i}{q^2}\right)}$$

EXAMPLE 5.723.

$$(5.726) \quad -\sum_{p=0}^{\infty} \frac{16^{-p}b^{2^{-1-p}}(-1+b^{2^{-p}})m^{2^{-1-p}}(-1+m^{2^{-p}})}{(b^{2^{-1-p}}+m^{2^{-1-p}})^4(1+b^{2^{-1-p}}m^{2^{-1-p}})^4}$$

$$\left( m^{2^{-p}} + b^{2^{1-p}}m^{2^{-p}} - 4b^{2^{-1-p}}m^{2^{-1-p}}(1+m^{2^{-p}}) - 4b^3 2^{-1-p}m^{2^{-1-p}}(1+m^{2^{-p}}) \right.$$

$$\left. + b^{2^{-p}}(1+m^{2^{-p}}(-20+m^{2^{-p}})) \right)$$

$$= 16 \left( 4b^2m^2 \left( \frac{1}{(b-m)^4} - \frac{1}{(-1+bm)^4} \right) + b \left( \frac{m^3}{(b-m)^4} - \frac{m}{(-1+bm)^4} \right) \right)$$

$$+b^3 \left( \frac{m}{(b-m)^4} - \frac{m^3}{(-1+bm)^4} \right) - \frac{6}{\log^4\left(\frac{b}{m}\right)} + \frac{6}{\log^4(bm)}$$

EXAMPLE 5.724.

$$(5.727) \quad \sum_{j=1}^{\infty} 4^{-j} (\operatorname{sech}^2(2^{-2-j}x) + 2\operatorname{sech}^2(2^{-1-j}x) - 4\operatorname{sech}^2(2^{-j}x)) \\ = \frac{1}{4} \left( \frac{80}{x^2} - \frac{8}{1+\cosh(x)} - 5\operatorname{csch}^2\left(\frac{x}{4}\right) + \operatorname{sech}^2\left(\frac{x}{4}\right) \right)$$

EXAMPLE 5.725.

$$(5.728) \quad \sum_{p=0}^n \frac{4^{-p}m^{2^{-1-p}} \left( 4^{1+p}a^2(-1+m^{2^{-p}})^2 + (1+m^{2^{-p}}(6+m^{2^{-p}}))\pi^2 \right)}{(-1+m^{2^{-p}})^3} \\ = 4a^2 \left( \frac{1}{1-m} + \frac{1}{-1+m^{2^{-1-n}}} \right) - \frac{4m(1+m)\pi^2}{(-1+m)^3} + \frac{4^{-n}m^{2^{-1-n}}(1+m^{2^{-1-n}})\pi^2}{(-1+m^{2^{-1-n}})^3}$$

EXAMPLE 5.726.

$$(5.729) \quad \sum_{p=0}^n \frac{16^{-p}m^{2^{-1-p}}}{(-1+m^{2^{-p}})^5} \left( 1 + 16^{1+p}a^4(-1+m^{2^{-p}})^4 \right. \\ \left. + 3 \times 2^{3+2p}a^2(-1+m^{2^{-p}})^2(1+m^{2^{-p}}(6+m^{2^{-p}})) \right. \\ \left. + m^{2^{-p}}(76+m^{2^{-p}}(230+m^{2^{-p}}(76+m^{2^{-p}}))) \right) \\ = \frac{2^{-4n}(1+m^{2^{-1-n}})}{(-1+m^{2^{-1-n}})^5} \left( m^{2^{-1-n}} + 3 \times 2^{3+2n}a^2m^{2^{-1-n}}(-1+m^{2^{-1-n}})^2 \right. \\ \left. + 2^{3+4n}a^4(-1+m^{2^{-1-n}})^4 + m^{2^{-n}}(10+m^{2^{-1-n}}) \right) \\ - \frac{8(1+m)(a^4(-1+m)^4 + 12a^2(-1+m)^2m + 2m(1+m(10+m)))}{(-1+m)^5}$$

EXAMPLE 5.727.

$$(5.730) \quad \sum_{p=0}^{n-1} \frac{2^{-p}m^{2^{-1-p}} \left( 2^{1+p} + \log(m) + m^{2^{-p}}(-2^{1+p} + \log(m)) \right)}{(-1+m^{2^{-p}})^2} \\ = 2 \left( \frac{1}{-1+m} + \frac{1}{1-m^{2^{-n}}} + \left( -\frac{m}{(-1+m)^2} + \frac{2^{-n}m^{2^{-n}}}{(-1+m^{2^{-n}})^2} \right) \log(m) \right)$$

EXAMPLE 5.728.

(5.731)

$$\sum_{p=0}^{\infty} \frac{2^{-p} m^{2^{-1-p}} \left( 2^{1+p} + \log(m) + m^{2^{-p}} (-2^{1+p} + \log(m)) \right)}{(-1 + m^{2^{-p}})^2} = \frac{-1 + m^2 - 2m \log(m)}{(-1 + m)^2}$$

EXAMPLE 5.729.

(5.732)

$$\begin{aligned} \sum_{p=0}^{\infty} \frac{8^{-p} m^{2^{-1-p}}}{(-1 + m^{2^{-p}})^4} & \left( -3 \times 4^{1+p} (-1 + m^{2^{-p}})^2 a^2 \left( 2^{1+p} (-1 + m^{2^{-p}}) - (1 + m^{2^{-p}}) \log(m) \right) \right. \\ & \quad + \pi^2 \left( 3 \times 2^{1+p} (-1 + m^{2^{-p}}) \left( 1 + m^{2^{-p}} (6 + m^{2^{-p}}) \right) \right. \\ & \quad \left. \left. - (1 + m^{2^{-p}}) \left( 1 + m^{2^{-p}} (22 + m^{2^{-p}}) \right) \log(m) \right) \right) \\ & = \frac{12(-1 + m^2)}{(-1 + m)^4} (a^2(-1 + m)^2 - 2m\pi^2) + 8m(-3a^2(-1 + m)^2 \\ & \quad + (1 + 4m + m^2) \pi^2) \log(m) \end{aligned}$$

EXAMPLE 5.730.

$$\begin{aligned} (5.733) \quad \sum_{p=0}^{n-1} 4^p \left( \psi^{(1)} \left( \frac{1}{6} - 2^{p-2} \right) + \psi^{(1)} \left( \frac{5}{6} - 2^{p-2} \right) \right) \\ = 4^n (9\zeta(2, -32^{n-2}) - \zeta(2, -2^{n-2})) - 8(10C + \pi^2) \end{aligned}$$

EXAMPLE 5.731.

$$(5.734) \quad \sum_{k=1}^{\infty} \frac{k^k (ae^{-a})^k}{(k+3)!} = -\frac{4 - 15a + 18a^2 + 18a^3 - 54a^2 e^a + 27ae^{2a} - 4e^{3a}}{108a^3}$$

EXAMPLE 5.732.

$$(5.735) \quad \sum_{k=1}^{\infty} \frac{k^{k+2} (a \exp(-a))^k}{(k+1)!} = \frac{1 - 2a - e^a + 3ae^a - 3a^2 e^a + a^3 e^a}{(-1 + a)^3 a}$$

EXAMPLE 5.733.

$$(5.736) \quad \sum_{k=1}^{\infty} \frac{k^{k+2} (a \exp(-a))^k}{k!} = \frac{a(2a + 1)}{(1 - a)^5}$$

EXAMPLE 5.734.

$$\begin{aligned} (5.737) \quad \sum_{j=0}^{\infty} \sum_{n=0}^{\infty} \sum_{l=0}^{\infty} \sum_{p=0}^{\infty} \frac{t^{j+l+n+p}}{(1+j+n)(1+l+p)(1-k)_{1-l-p}(k)_{1-j-n}} \\ = \sum_{m=0}^{\infty} \sum_{q=0}^{\infty} \frac{\pi t^{m+q} \csc(k\pi)}{\Gamma(1+k-m)\Gamma(2-k-q)} \end{aligned}$$

EXAMPLE 5.735.

$$\begin{aligned}
(5.738) \quad & \sum_{j=0}^{\infty} \sum_{m=0}^{\infty} \frac{(-1)^j t^{2j+m} \Gamma(c+j-\alpha) \Gamma(j+m+\alpha) \Gamma(2j+m+\beta) \Gamma(j+\beta-\gamma) \Gamma(j+\gamma)}{(1+2j+m) \Gamma(1+j) \Gamma(c+j) \Gamma(1-2j+k-m) \Gamma(1+m) \Gamma(c+2j+m) \Gamma(2j+\beta)} \\
& = \sum_{p=0}^{\infty} \sum_{n=0}^{\infty} \frac{t^{n+p} \Gamma(c-\alpha) \Gamma(n+\alpha) \Gamma(p+\alpha) \Gamma(p+\beta-\gamma) \Gamma(n+\gamma)}{(1+n+p) \Gamma(1+n) \Gamma(c+n) \Gamma(1+k-n-p) \Gamma(1+p) \Gamma(c+p) \Gamma(\alpha)}
\end{aligned}$$

EXAMPLE 5.736.

$$(5.739) \quad \sum_{k=0}^{\infty} \frac{(1-b)_k t^k {}_3F_2(-k, a-k, c; b-k, d; x)}{(k+1)! (1-a)_k} = \int_0^t \frac{{}_1F_1(1-b; 1-a; s) {}_1F_1(c; d; -xs)}{t} ds$$

EXAMPLE 5.737.

$$\begin{aligned}
(5.740) \quad & \sum_{p=1}^{n-1} e^{ip\pi} \csc\left(\frac{\pi}{n}\right) \operatorname{csch}^2(m\pi) \sin\left(\frac{p\pi}{n}\right) \left( an \cosh\left(\frac{mp\pi}{n}\right) \right. \\
& \quad \left. - an \cosh\left(m\left(2-\frac{p}{n}\right)\pi\right) + (-2n+p) \sinh\left(\frac{mp\pi}{n}\right) + p \sinh\left(m\left(2-\frac{p}{n}\right)\pi\right) \right) \\
& = \frac{an \left( \cos\left(\frac{\pi}{n}\right) + \cosh\left(\frac{m\pi}{n}\right) \right) - \sinh\left(\frac{m\pi}{n}\right)}{\left( \cos\left(\frac{\pi}{n}\right) + \cosh\left(\frac{m\pi}{n}\right) \right)^2}
\end{aligned}$$

EXAMPLE 5.738.

$$\begin{aligned}
(5.741) \quad & \sum_{p=1}^n \frac{(-1)^p e^{-\frac{ip\pi}{n}} \left( -1 + e^{\frac{2ip\pi}{n}} \right) m^{-1-\frac{p}{2n}}}{(-1+m)^2} \left( m((-2+a(-1+m))n+p-mp) \right. \\
& \quad \left. + m^{p/n} (2mn+a(n-mn)+p-mp) \right) \\
& = - \frac{2ie^{\frac{2i\pi}{n}} m^{-1+\frac{1}{2n}} \left( 1+an+m^{1/n}(-1+an)+2am^{\frac{1}{2n}}n \cos\left(\frac{\pi}{n}\right) \right) \sin\left(\frac{\pi}{n}\right)}{\left( e^{\frac{i\pi}{n}} + m^{\frac{1}{2n}} \right)^2 \left( 1 + e^{\frac{i\pi}{n}} m^{\frac{1}{2n}} \right)^2}
\end{aligned}$$

EXAMPLE 5.739.

$$\begin{aligned}
(5.742) \quad & \sum_{p=0}^{n-1} (-1)^p \cos\left(\frac{j(1+2p)\pi}{2n}\right) \left( 2an \cosh\left(\frac{m(-1+4n-2p)\pi}{2n}\right) \right. \\
& \quad \left. - 2an \cosh\left(\frac{m(1+2p)\pi}{2n}\right) - (1+2p) \sinh\left(\frac{m(-1+4n-2p)\pi}{2n}\right) \right. \\
& \quad \left. + (-1+4n-2p) \sinh\left(\frac{m(1+2p)\pi}{2n}\right) \right) \\
& = \frac{2 \cos\left(\frac{j\pi}{2n}\right) \sinh^2(m\pi)}{\left( \cos\left(\frac{j\pi}{n}\right) + \cosh\left(\frac{m\pi}{n}\right) \right)^2} \left( 2an \cosh\left(\frac{m\pi}{2n}\right) \left( \cos\left(\frac{j\pi}{n}\right) + \cosh\left(\frac{m\pi}{n}\right) \right) \right. \\
& \quad \left. + \left( -2 + \cos\left(\frac{j\pi}{n}\right) - \cosh\left(\frac{m\pi}{n}\right) \right) \sinh\left(\frac{m\pi}{2n}\right) \right)
\end{aligned}$$

EXAMPLE 5.740.

(5.743)

$$\sum_{p=1}^n \frac{2^{-p} q^{2^{-p}} \left( -\pi \left( 1 + q^{2^{-p}} \left( -2 + q^{2^{-p}} \left( -2 + q^{2^{-p}} \left( -2 + q^{2^{-p}} \right) \right) \right) \right) \right) - i 2^p \left( -1 + q^{2^{-p}} \right) a}{\left( 1 + q^{2^{1-p}} + q^{2^{-p}} + q^3 2^{-p} \right)^2}$$

$$= \pi \left( \frac{q}{(1+q)^2} - \frac{2^{-n} q^{2^{-n}}}{(1+q^{2^{-n}})^2} \right) - i \left( -\frac{1}{1+q} + \frac{1}{1+q^{2^{-n}}} \right) a$$

EXAMPLE 5.741.

(5.744)

$$\sum_{p=1}^{\infty} \frac{2^{-p} q^{2^{-p}} \left( 2^p a \left( -1 + q^{2^{-p}} \right) - \pi \left( 1 + q^{2^{-p}} \left( -2 + q^{2^{-p}} \left( -2 + q^{2^{-p}} \left( -2 + q^{2^{-p}} \right) \right) \right) \right) \right)}{\left( 1 + q^{2^{1-p}} + q^{2^{-p}} + q^3 2^{-p} \right)^2}$$

$$\frac{2\pi q + a(-1+q^2)}{2(1+q)^2}$$

EXAMPLE 5.742.

$$(5.745) \quad \sum_{k=0}^{\infty} \frac{(b+ak)^k (-1)^k e^{ayk} y^k}{(k+1)!} = \frac{e^{-ay-by} (e^{ay} - e^{by})}{(a-b)y}$$

EXAMPLE 5.743.

$$(5.746) \quad \sum_{k=0}^{\infty} \frac{(b+ak)^k (-1)^k e^{ayk} y^k}{(k+2)!}$$

$$= \frac{e^{(a-b)y-2(ay+\log(y))} \left( -e^{by} y + \frac{e^{ay}(a-b+2a^2y-aby)}{(-2a+b)^2} \right)}{a-b} + \frac{e^{-2(ay+\log(y))} (-1)}{(-2a+b)^2}$$

EXAMPLE 5.744.

(5.747)

$$\sum_{n=0}^{\infty} \sum_{p=0}^{\infty} \sum_{q=0}^{\infty} \frac{(-1)^{2n+p+2q} 2^p (a+n\alpha)^{-1-n-p-2q} (n\alpha+\beta)^{-1+n} E_p(x) \Gamma(1+n+p+2q)}{\Gamma(1+n)\Gamma(1+p)\Gamma(2+2q)}$$

$$= \frac{\log \left( \frac{4 \left( \frac{\Gamma\left(\frac{1}{4}(-1+a+2x-\beta)\right)(-1+a+2x-\beta)}{\Gamma\left(\frac{1}{4}(-2-1+a+2x-\beta)\right)(-2-1+a+2x-\beta)} \right)^2}{-1+a+2x-\beta} \right)}{\beta}$$

EXAMPLE 5.745.

$$(5.748) \quad \sum_{k=1}^{\infty} \frac{(ae^{-a})^k k^{-2+k}}{k!} = a - \frac{a^2}{2}$$



EXAMPLE 5.746.

$$(5.749) \quad \sum_{k=1}^{\infty} \frac{(ae^{-a})^k k^{-2+k}}{(k+1)!} = \frac{-2-2a-a^3}{2a} + \frac{e^a}{a}$$

EXAMPLE 5.747.

$$(5.750) \quad \sum_{k=0}^{\infty} \frac{a^k E_k}{(k+1)!} = \frac{2 \tan^{-1}(\tanh(\frac{a}{2}))}{a}$$

EXAMPLE 5.748.

$$(5.751) \quad \sum_{n=0}^{\infty} \frac{\zeta(-n+s)z^n}{(n+1)!} = -\frac{(-z)^s \Gamma(-s) + \text{Li}_{1+s}(1) - \text{Li}_{1+s}(e^z)}{z}$$

EXAMPLE 5.749.

$$(5.752) \quad \sum_{n=0}^{\infty} \frac{\zeta(-n+s)z^n}{(n+2)!} = \frac{(-z)^s z \Gamma(-1-s) - z \text{Li}_{1+s}(1) - \text{Li}_{2+s}(1) + \text{Li}_{2+s}(e^z)}{z^2}$$

EXAMPLE 5.750.

$$(5.753) \quad \sum_{r=0}^{\infty} \frac{z^r \zeta(-r+s, v)}{r!} = s(-z)^{-1+s} \Gamma(-s) + e^{vz} \Phi(e^z, s, v)$$

EXAMPLE 5.751.

$$(5.754) \quad \sum_{r=0}^{\infty} \frac{z^r \zeta(-r+s, v)}{(r+1)!} = \int_0^z \frac{e^{vt} \Phi(e^t, s, v) + s \Gamma(-s)(-t)^{-1+s}}{z} dt$$

EXAMPLE 5.752.

$$(5.755) \quad \sum_{k=1}^{\infty} \frac{x^{2k} E_{2k}}{(2k+1)!} = \frac{-x + 2 \tan^{-1}(\tanh(\frac{x}{2}))}{x}$$

EXAMPLE 5.753.

$$(5.756) \quad \sum_{k=0}^{\infty} \frac{p^k \cos(kx)}{(k+1)!} = \frac{-\cos(x) + e^{p \cos(x)} \cos(x - p \sin(x))}{p}$$

EXAMPLE 5.754.

$$(5.757) \quad \sum_{n=0}^{\infty} \frac{s^n (c)_n {}_2F_1(-n, a; c; z)}{(n+1)!} \\ = \frac{{}_2F_1(1, 2-c; 2-a; \frac{1}{z}) - (1-s)^{1+a-c} (1+s(-1+z))^{1-a} {}_2F_1(1, 2-c; 2-a; \frac{1+s(-1+z)}{z})}{(-1+a)sz}$$

EXAMPLE 5.755.

$$(5.758) \quad \sum_{k=0}^{\infty} \frac{{}_2F_1(a-k, b; c; x) ((c-a)_k y^k)}{(k+1)!}$$

$$= -\frac{\left(\frac{-1+x}{x}\right)^{-a-b-c} {}_2F_1\left(1-b, -a-b-c; 2-b; \frac{1}{x}\right)}{((-1+b)(-1+x))y}$$

$$\frac{(1-y)^{a+b+c} \left(-\frac{(-1+x)(-1+y)}{x}\right)^{-a-b-c} (1+(-1+x)y)^{1-b} {}_2F_1\left(1-b, -a-b-c; 2-b; \frac{1+(-1+x)y}{x}\right)}{(-1+b)(-1+x)y}$$

EXAMPLE 5.756.

(5.759)

$$\sum_{k=0}^{\infty} \frac{y^k {}_2F_1(a, -k; b+ck; x)(b)_{k+ck}}{k!(b)_{ck}} = \frac{(1+(1+v)^{1+cy})^b (1+(1+v)^{1+cy}xy)^{-a}}{1-c(1+v)^{1+cy}}$$

EXAMPLE 5.757.

$$(5.760) \quad \sum_{k=0}^{\infty} \frac{y^k {}_2F_1(a, -k; b+ck; x)(b)_{k+ck}}{(k+1)!(b)_{ck}}$$

$$= \frac{1}{y} \left( \frac{1}{(a-b)c} (1+v)^{-1-c} (1+(1+v)^{1+cy})^b (1+(1+v)^{1+cy}xy)^{-a} \right.$$

$$\left. \left( 1 + \frac{1+c}{-1+c(1+v)^{1+cy}} \right)^{-b} \left( 1 + \frac{c+x}{x(-1+c(1+v)^{1+cy})} \right)^a \right.$$

$$\left. F_1\left(a-b; -b, a; 1+a-b; -\frac{1+c}{-1+c(1+v)^{1+cy}}, -\frac{c+x}{x(-1+c(1+v)^{1+cy})}\right) \right.$$

$$\left. - \frac{(-c)^{-b}(1+v)^{-1-c} \left(1 - \frac{c+x}{x}\right)^a F_1\left(a-b; -b, a; 1+a-b; 1+c, \frac{c+x}{x}\right)}{(a-b)c} \right)$$

EXAMPLE 5.758.

$$(5.761) \quad \sum_{k=0}^{\infty} \frac{((a)_k(b)_k)t^k {}_2F_1(a+k, b+k; c+k; x)}{(k+1)!(c)_k}$$

$$= \frac{(-1+c)(-{}_2F_1(-1+a, -1+b; -1+c; x) + {}_2F_1(-1+a, -1+b; -1+c; t+x))}{(-1+a)(-1+b)t}$$

EXAMPLE 5.759.

$$(5.762) \quad \sum_{k=0}^{\infty} \frac{(c-a)_k t^k {}_2F_1(a-k, b; c; x)}{(k+1)!}$$

$$= \frac{(1-x)^{-b} \left( {}_2F_1\left(b, -1-a+c; c; \frac{x}{-1+x}\right) - (1-t)^{1+a-c} {}_2F_1\left(b, -1-a+c; c; -\frac{x}{(-1+t)(-1+x)}\right) \right)}{(1+a-c)t}$$

EXAMPLE 5.760.

$$(5.763) \quad \sum_{n=0}^{\infty} \frac{(1+a)_n {}_2F_1(-n, 1+a+b+n; 1+a; \frac{1-x}{2}) z^n}{(n+1)!}$$

$$= \int_0^z \frac{2^{a+b} (1-s+\sqrt{1+s^2-2sx})^{-a} (1+s+\sqrt{1+s^2-2sx})^{-b}}{\sqrt{1+s^2-2sx}} ds$$

EXAMPLE 5.761.

$$(5.764) \quad \sum_{j=1}^{\infty} \frac{(-j)^j (-j+t)^{-j}}{1+j} = -1 - e^t \Gamma(0, t) + (1+t) \log \left( \frac{1+t}{t} \right)$$

EXAMPLE 5.762.

$$(5.765) \quad \sum_{j=1}^{\infty} \frac{(-j)^j j (-j+t)^{-1-j}}{1+j} = e^t \Gamma(0, t) + \log \left( \frac{t}{1+t} \right)$$

EXAMPLE 5.763.

$$(5.766) \quad \sum_{j=1}^{\infty} \frac{(-j)^j (t-j)^{k-j} (1-k)_{j-1}}{\Gamma(j+1)} = -e^t \Gamma(k, t)$$

EXAMPLE 5.764.

$$(5.767) \quad \sum_{p=0}^{\infty} (-1)^p \left( \frac{1}{(m+(1+2p)\alpha)^{k+1}} - \frac{1}{(m-(1+2p)\alpha)^{k+1}} \right) \cos((1+2p)x) \\ = - \frac{(-i)^k e^{\frac{im(\pi-2x)}{2\alpha}} \left( \frac{\pi}{\alpha} \right)^{1+k} \left( \Phi \left( -e^{\frac{im\pi}{\alpha}}, -k, \frac{1}{2} - \frac{x}{\pi} \right) + e^{\frac{2imx}{\alpha}} \Phi \left( -e^{\frac{im\pi}{\alpha}}, -k, \frac{1}{2} + \frac{x}{\pi} \right) \right)}{2\Gamma(1+k)}$$

EXAMPLE 5.765.

$$(5.768) \quad \sum_{p=1}^n \frac{9^{-p} q^{3^{-p}} \left( -1 - q^{3^{-p}} \left( 4 + q^{3^{-p}} \right) - 3^p a \left( 1 + 2q^{3^{-p}} \right) \left( 1 + q^{3^{-p}} + q^{2 \cdot 3^{-p}} \right) \right)}{\left( 1 + q^{3^{-p}} + q^{2 \cdot 3^{-p}} \right)^2} \\ = \frac{q(1+a-aq)}{(-1+q)^2} + \frac{9^{-n} q^{3^{-n}} \left( -1 + 3^n a \left( -1 + q^{3^{-n}} \right) \right)}{(-1+q^{3^{-n}})^2}$$

EXAMPLE 5.766.

$$(5.769) \quad \sum_{p=1}^{\infty} \frac{9^{-p} q^{3^{-p}} \left( -1 - q^{3^{-p}} \left( 4 + q^{3^{-p}} \right) - 3^p a \left( 1 + 2q^{3^{-p}} \right) \left( 1 + q^{3^{-p}} + q^{2 \times 3^{-p}} \right) \right)}{\left( 1 + q^{3^{-p}} + q^{2 \times 3^{-p}} \right)^2} \\ = \frac{q(1+a-aq)}{(-1+q)^2} + \frac{-1+a \log(q)}{\log^2(q)}$$

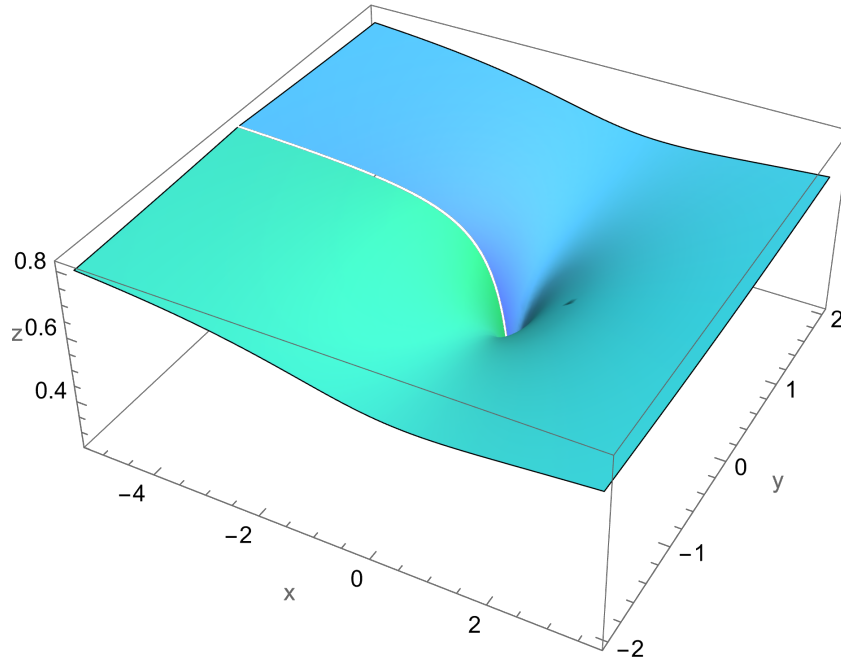

FIGURE 26. Plot of  $f(q) = \frac{1}{(q-1)^2} + \frac{\log(q)-1}{\log^2(q)} - 1$ ,  $q \in \mathbb{C}$ .

EXAMPLE 5.767.

(5.770)

$$\begin{aligned} & \sum_{p=1}^n 3^{-3p} q^{3^{-p}} \left( \frac{\sqrt[3]{-1} (1 + 3^p a)^2 + (-1 + 2 \times 3^p a (1 + 3^p a)) q^{3^{-p}} - (-1)^{2/3} 9^p a^2 q^{2 \times 3^{-p}}}{(-1 + (-1)^{2/3} q^{3^{-p}})^3} \right. \\ & \quad \left. + \frac{2 + (-1 + 2 \times 3^p a) (1 + \sqrt[3]{-1} q^{3^{-p}}) + 9^p (a + \sqrt[3]{-1} a q^{3^{-p}})^2}{(1 + \sqrt[3]{-1} q^{3^{-p}})^3} \right) \\ & = (-1)^{2/3} \left( -\frac{q(1 + a(-2 + a(-1 + q))(-1 + q) + q)}{(-1 + q)^3} \right. \\ & \quad \left. + \frac{3^{-3n} q^{3^{-n}} (1 + q^{3^{-n}} + 3^n a (-1 + q^{3^{-n}}) (-2 + 3^n a (-1 + q^{3^{-n}})))}{(-1 + q^{3^{-n}})^3} \right) \end{aligned}$$

EXAMPLE 5.768.

(5.771)

$$\begin{aligned} & \sum_{p=1}^{\infty} 3^{-3p} q^{3^{-p}} \left( \frac{\sqrt[3]{-1} (1 + 3^p a)^2 + (-1 + 2 \times 3^p a (1 + 3^p a)) q^{3^{-p}} - (-1)^{2/3} 9^p a^2 q^{2 \times 3^{-p}}}{(-1 + (-1)^{2/3} q^{3^{-p}})^3} \right. \\ & \quad \left. + \frac{2 + (-1 + 2 \times 3^p a) (1 + \sqrt[3]{-1} q^{3^{-p}}) + 9^p (a + \sqrt[3]{-1} a q^{3^{-p}})^2}{(1 + \sqrt[3]{-1} q^{3^{-p}})^3} \right) \end{aligned}$$

$$= (-1)^{2/3} \left( -\frac{q(1+a(-2+a(-1+q))(-1+q)+q)}{(-1+q)^3} + \frac{2+a \log(q)(-2+a \log(q))}{\log^3(q)} \right)$$

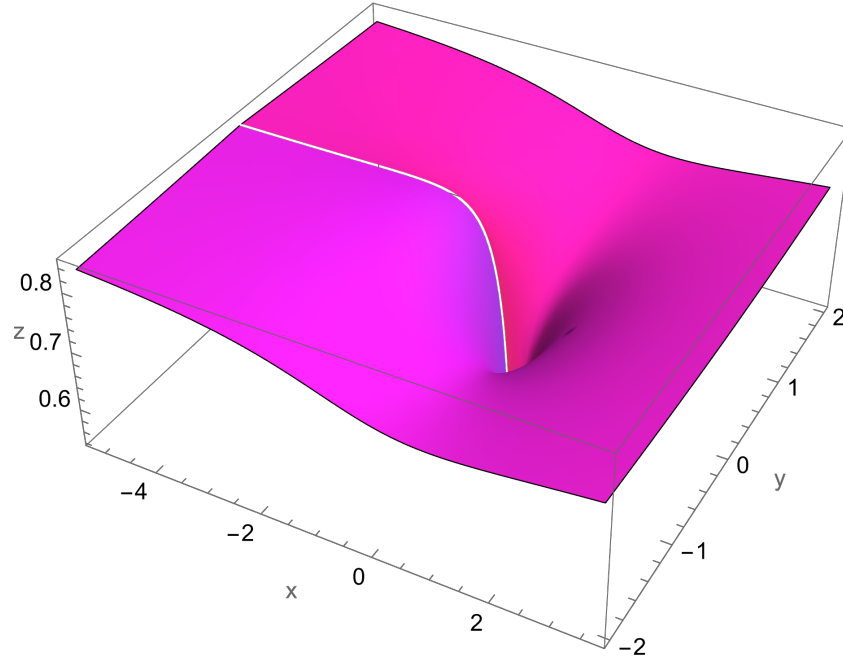

FIGURE 27. Plot of  $f(q) = (-1)^{2/3} \left( \frac{(\log(q)-2) \log(q)+2}{\log^3(q)} - \frac{q((q-3)(q-1)+q+1)}{(q-1)^3} \right)$ ,  $q \in \mathbb{C}$ .

EXAMPLE 5.769.

$$(5.772) \quad \sum_{p=1}^n \frac{3^p r^{3^p} (a(1+2r^{3^p})(1+r^{3^p}+r^{2 \times 3^p})+3^p(1+r^{3^p}(4+r^{3^p})))}{(1+r^{3^p}+r^{2 \times 3^p})^2} = 3 \left( \frac{r^3(3+a-ar^3)}{(-1+r^3)^2} - \frac{3^n r^{3^{1+n}}(3^{1+n}+a-ar^{3^{1+n}})}{(-1+r^{3^{1+n}})^2} \right)$$

EXAMPLE 5.770.

$$(5.773) \quad \sum_{p=1}^{\infty} \frac{3^p r^{3^p} (a(1+2r^{3^p})(1+r^{3^p}+r^{2 \times 3^p})+3^p(1+r^{3^p}(4+r^{3^p})))}{(1+r^{3^p}+r^{2 \times 3^p})^2} = \frac{3r^3(3+a-ar^3)}{(-1+r^3)^2}$$

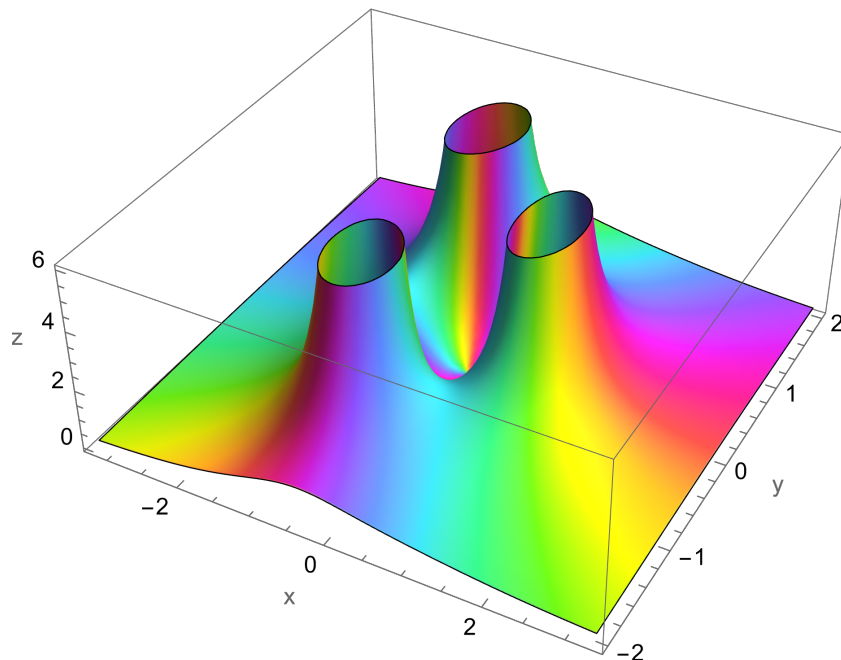

FIGURE 28. Plot of  $f(r) = \frac{9r^3}{(r^3-1)^2}$ ,  $r \in \mathbb{C}$ .

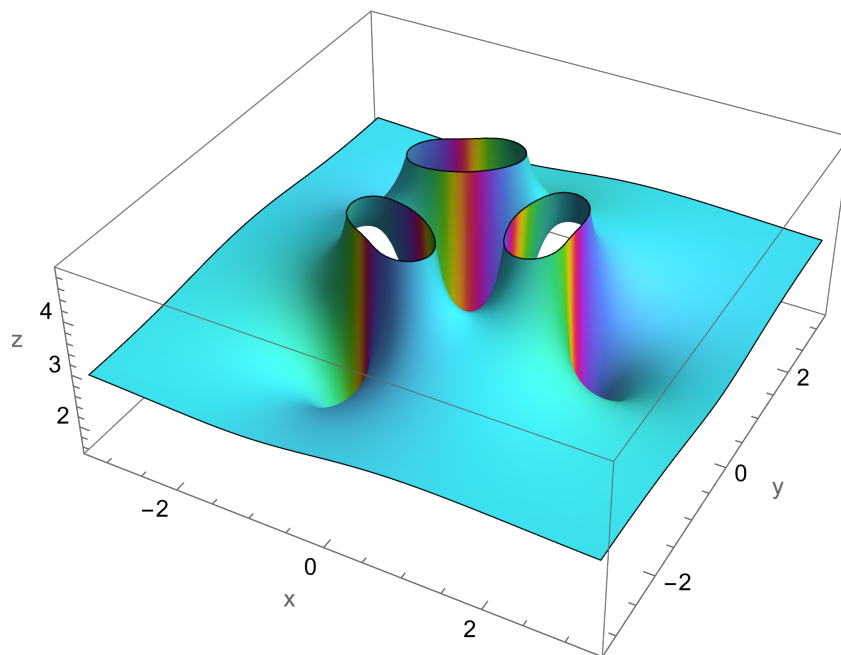

FIGURE 29. Plot of  $f(r) = \frac{3r^3(4-r^3)}{(r^3-1)^2}$ ,  $r \in \mathbb{C}$ .

EXAMPLE 5.771.

$$\begin{aligned}
(5.774) \quad & \sum_{p=1}^n 3^p r^{3^p} \left( \frac{(-1)^{2/3} (3^p + a)^2 + (9^p - 2a(3^p + a)) r^{3^p} - \sqrt[3]{-1} a^2 r^{2 \times 3^p}}{(1 + \sqrt[3]{-1} r^{3^p})^3} \right. \\
& + \frac{-(3^p + a)^2 + (-1)^{2/3} (-9^p + 2a(3^p + a)) r^{3^p} + \sqrt[3]{-1} a^2 r^{2 \times 3^p}}{(-1 + (-1)^{2/3} r^{3^p})^3} \Bigg) \\
& = -3 \sqrt[3]{-1} \left( \frac{(3 + a)^2 r^3 + (9 - 2a(3 + a)) r^6 + a^2 r^9}{(-1 + r^3)^3} \right. \\
& \left. + \frac{3^n r^{3^{1+n}} \left( -9^{1+n} (1 + r^{3^{1+n}}) + a (-1 + r^{3^{1+n}}) (2 \times 3^{1+n} + a - ar^{3^{1+n}}) \right)}{(-1 + r^{3^{1+n}})^3} \right)
\end{aligned}$$

EXAMPLE 5.772.

$$\begin{aligned}
(5.775) \quad & \sum_{j=1}^n \sum_{p=1}^n \frac{3^{-2j+p} q^{3^{-j}+3^p}}{(1 + q^{3^{-j}} + q^2 3^{-j})^2 (1 + q^{3^p} + q^2 3^p)^2} \left( 1 + q^{3^{-j}} (4 + q^{3^{-j}}) \right. \\
& \left. + 3^j a (1 + 2q^{3^{-j}}) (1 + q^{3^{-j}} + q^2 3^{-j}) \right) \left( a (1 + 2q^{3^p}) (1 + q^{3^p} + q^2 3^p) + 3^p (1 + q^{3^p} (4 + q^{3^p})) \right) \\
& = -3 \left( \frac{q^3 (3 + a - aq^3)}{(-1 + q^3)^2} - \frac{3^n q^{3^{1+n}} (3^{1+n} + a - aq^{3^{1+n}})}{(-1 + q^{3^{1+n}})^2} \right) \\
& \quad \left( \frac{q(1 + a - aq)}{(-1 + q)^2} + \frac{9^{-n} q^{3^{-n}} (-1 + 3^n a (-1 + q^{3^{-n}}))}{(-1 + q^{3^{-n}})^2} \right)
\end{aligned}$$

EXAMPLE 5.773.

$$\begin{aligned}
(5.776) \quad & \sum_{j=1}^{\infty} \sum_{p=1}^{\infty} \frac{3^{-2j+p} q^{3^{-j}+3^p}}{(1 + q^{3^{-j}} + q^2 3^{-j})^2 (1 + q^{3^p} + q^2 3^p)^2} \left( 1 + q^{3^{-j}} (4 + q^{3^{-j}}) \right. \\
& \left. + 3^j a (1 + 2q^{3^{-j}}) (1 + q^{3^{-j}} + q^2 3^{-j}) \right) \left( a (1 + 2q^{3^p}) (1 + q^{3^p} + q^2 3^p) + 3^p (1 + q^{3^p} (4 + q^{3^p})) \right) \\
& = - \frac{3q^3 (3 + a - aq^3) \left( \frac{q(1+a-aq)}{(-1+q)^2} + \frac{-1+a \log(q)}{\log^2(q)} \right)}{(-1 + q^3)^2}
\end{aligned}$$

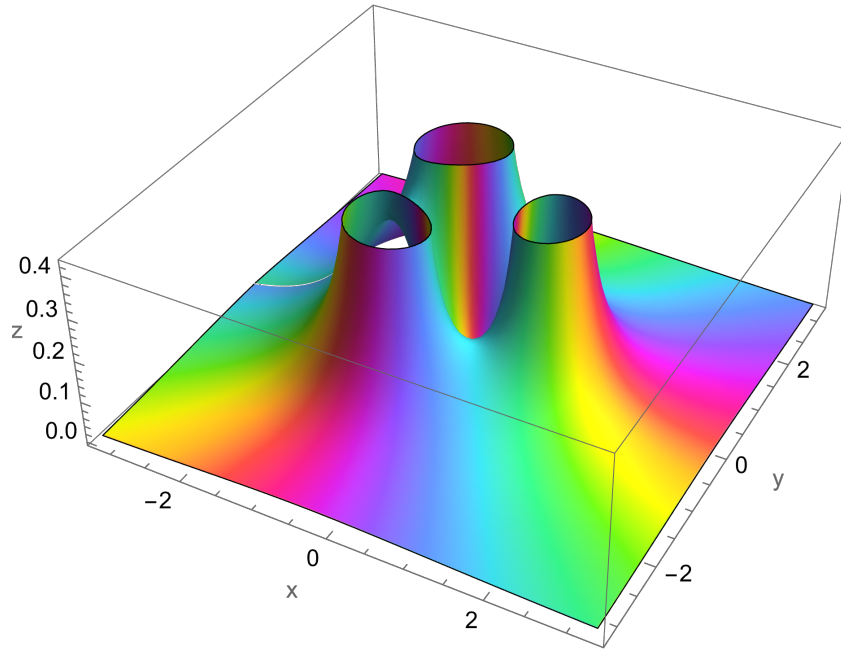

FIGURE 30. Plot of  $f(q) = \frac{9q^3 \left( \frac{1}{\log^2(q)} - \frac{q}{(q-1)^2} \right)}{(q^3-1)^2}$ ,  $q \in \mathbb{C}$ .

EXAMPLE 5.774.

(5.777)

$$\sum_{p=1}^n \frac{q^{\frac{3^{-1+p}}{2}} \left( -3a \left( -1 + q^{2 \times 3^{-1+p}} \left( -1 + q^{3^{-1+p}} + q^{3^p} \right) \right) + i3^p \left( 1 + q^{2 \times 3^{-1+p}} \left( 5 + 5q^{3^{-1+p}} + q^{3^p} \right) \right) \right)}{(-1 + q^{3^p})^2}$$

$$= 3i \left( \frac{\sqrt{q}(1 + ia(-1 + q) + q)}{(-1 + q)^2} - \frac{q^{\frac{3^n}{2}} (ia(-1 + q^{3^n}) + 3^n(1 + q^{3^n}))}{(-1 + q^{3^n})^2} \right)$$

EXAMPLE 5.775.

(5.778) 
$$\sum_{p=1}^n \frac{3q^{\frac{3^{-1+p}}{2}}}{-1 + q^{3^p}} \left( 1 + q^{2 \times 3^{-1+p}} \right) = \frac{3\sqrt{q}}{-1 + q} - \frac{3q^{\frac{3^n}{2}}}{-1 + q^{3^n}}$$

EXAMPLE 5.776.

(5.779) 
$$\sum_{p=1}^{\infty} \frac{q^{\frac{3^{-1+p}}{2}}}{-1 + q^{3^p}} \left( 1 + q^{2 \times 3^{-1+p}} \right) = \frac{\sqrt{q}}{-1 + q}$$

EXAMPLE 5.777.



(5.780)

$$\sum_{p=1}^n \frac{9^{-p} (1 + i\sqrt{3}) q^{3^{-p}} \left( -1 - q^{3^{-p}} (-4 + q^{3^{-p}}) + 3^p a (-1 + 2q^{3^{-p}}) (1 + q^{3^{-p}} (-1 + q^{3^{-p}})) \right)}{(1 + q^{3^{-p}} (-1 + q^{3^{-p}}))^2}$$

$$= 2\sqrt[3]{-1} \left( \frac{q(1 + a + aq)}{(1 + q)^2} - \frac{9^{-n} q^{3^{-n}} (1 + 3^n a (1 + q^{3^{-n}}))}{(1 + q^{3^{-n}})^2} \right)$$

EXAMPLE 5.778.

(5.781)

$$\sum_{p=1}^{\infty} \frac{9^{-p} (1 + i\sqrt{3}) q^{3^{-p}} \left( -1 - q^{3^{-p}} (-4 + q^{3^{-p}}) + 3^p a (-1 + 2q^{3^{-p}}) (1 + q^{3^{-p}} (-1 + q^{3^{-p}})) \right)}{(1 + q^{3^{-p}} (-1 + q^{3^{-p}}))^2}$$

$$= \frac{(1 + i\sqrt{3}) q(1 + a + aq)}{(1 + q)^2}$$

EXAMPLE 5.779.

(5.782)

$$\sum_{p=1}^n 3^{-3p} q^{3^{-p}} \left( \frac{2}{(1 + (-1)^{2/3} q^{3^{-p}})^3} + \frac{-1 + 2 \times 3^p a}{(1 + (-1)^{2/3} q^{3^{-p}})^2} + \frac{9^p a^2}{1 + (-1)^{2/3} q^{3^{-p}}} \right.$$

$$\left. + \frac{-(-1)^{2/3} (1 + 3^p a)^2 + (1 - 2 \times 3^p a (1 + 3^p a)) q^{3^{-p}} + \sqrt[3]{-1} 9^p a^2 q^{2 \times 3^{-p}}}{(-1 + \sqrt[3]{-1} q^{3^{-p}})^3} \right)$$

$$= \sqrt[3]{-1} \left( -\frac{q(1 - q + a(1 + q))(2 + a + aq)}{(1 + q)^3} \right.$$

$$\left. + \frac{3^{-3n} q^{3^{-n}} (1 - q^{3^{-n}} + 3^n a (1 + q^{3^{-n}}) (2 + 3^n a (1 + q^{3^{-n}})))}{(1 + q^{3^{-n}})^3} \right)$$

EXAMPLE 5.780.

(5.783)

$$\sum_{p=1}^{\infty} 3^{-3p} q^{3^{-p}} \left( \frac{2}{(1 + (-1)^{2/3} q^{3^{-p}})^3} + \frac{-1 + 2 \times 3^p a}{(1 + (-1)^{2/3} q^{3^{-p}})^2} + \frac{9^p a^2}{1 + (-1)^{2/3} q^{3^{-p}}} \right.$$

$$\left. + \frac{-(-1)^{2/3} (1 + 3^p a)^2 + (1 - 2 \times 3^p a (1 + 3^p a)) q^{3^{-p}} + \sqrt[3]{-1} 9^p a^2 q^{2 \times 3^{-p}}}{(-1 + \sqrt[3]{-1} q^{3^{-p}})^3} \right)$$

$$= -\frac{\sqrt[3]{-1} q(1 - q + a(1 + q))(2 + a + aq)}{(1 + q)^3}$$

EXAMPLE 5.781.

(5.784)

$$\sum_{p=1}^{\infty} \frac{9^p q^{3^{-1+p}} (1 + q^{3^{-1+p}} (-4 + q^{3^{-1+p}}))}{(1 + q^{3^{-1+p}} (-1 + q^{3^{-1+p}}))^2} = \frac{9q}{(1 + q)^2}$$

EXAMPLE 5.782.

$$(5.785) \quad \sum_{p=0}^{\infty} (-1)^p \left( \frac{1}{(m+(1+2p)\alpha)^{k+1}} - \frac{1}{(m-(1+2p)\alpha)^{k+1}} \right) \cos((1+2p)x) \\ = - \frac{(-i)^k e^{\frac{im(\pi-2x)}{2\alpha}} \left(\frac{\pi}{\alpha}\right)^{1+k} \left( \Phi\left(-e^{\frac{im\pi}{\alpha}}, -k, \frac{1}{2} - \frac{x}{\pi}\right) + e^{\frac{2imx}{\alpha}} \Phi\left(-e^{\frac{im\pi}{\alpha}}, -k, \frac{1}{2} + \frac{x}{\pi}\right) \right)}{2\Gamma(1+k)}$$

EXAMPLE 5.783.

$$(5.786) \quad \sum_{p=0}^{\infty} (-1)^p \left( \frac{1}{(-2m+(1+2p)\beta)^{k+1}} + \frac{(-1)^k}{(2m+(1+2p)\beta)^{k+1}} \right) \\ = \frac{e^{\frac{im\pi}{\beta}} \pi^{1+k} \left(\frac{i}{\beta}\right)^k \Phi\left(-e^{\frac{2im\pi}{\beta}}, -k, \frac{1}{2}\right)}{\beta\Gamma(1+k)}$$

EXAMPLE 5.784.

$$(5.787) \quad \sum_{p=0}^{\infty} \frac{(-1)^p ((-1+2p)\log(-3-2p) + (3+2p)\log(1-2p))}{-3+4p(1+p)} \\ = \frac{1}{2}\pi \left( 2i + \gamma - i\pi + \log\left(\frac{2\pi\Gamma(-\frac{1}{4})^2}{9\Gamma(-\frac{3}{4})^2}\right) \right)$$

EXAMPLE 5.785.

$$(5.788) \quad \sum_{p=0}^{\infty} (-1)^p (1+2p) \left( \frac{16x}{4x^2 - (\beta+2p\beta)^2} - \frac{2\log\left(\frac{(-2x+\beta+2p\beta)^2}{(2x+\beta+2p\beta)^2}\right)}{\beta+2p\beta} \right) \\ = \frac{2i\log(a) \left( \text{Li}_2\left(-ie^{-\frac{i\pi x}{\beta}}\right) - \text{Li}_2\left(ie^{-\frac{i\pi x}{\beta}}\right) - \text{Li}_2\left(-ie^{\frac{i\pi x}{\beta}}\right) + \text{Li}_2\left(ie^{\frac{i\pi x}{\beta}}\right) \right)}{\pi} \\ + \frac{2i\pi x\beta \log(a) + 4\beta \log\left(-i + \frac{2}{-i+e^{\frac{i\pi x}{\beta}}}\right) - 4\pi x \sec\left(\frac{\pi x}{\beta}\right)}{\beta^2}$$

EXAMPLE 5.786.

$$(5.789) \quad \sum_{p=0}^{\infty} \left( \frac{\Gamma\left(k, \frac{i\pi(-2m+\beta+2p\beta)}{2\beta}\right)}{(-2m+\beta+2p\beta)^k} + \frac{\Gamma\left(k, -\frac{i\pi(2m+\beta+2p\beta)}{2\beta}\right)}{(-2m-(1+2p)\beta)^k} \right) = \left(\frac{\pi i}{\beta}\right)^k \text{Li}_{1-k}\left(-e^{\frac{2im\pi}{\beta}}\right)$$

EXAMPLE 5.787.

$$(5.790) \quad \sum_{p=0}^{\infty} \left( \frac{\Gamma\left(k, \frac{1}{2}i(-1+2p)\pi\right)}{(1-2p)^k} + \frac{\Gamma\left(k, -\frac{1}{2}i(3+2p)\pi\right)}{(3+2p)^k} \right) = (-1+2^k) (-i\pi)^k \zeta(1-k)$$

EXAMPLE 5.788.

$$\begin{aligned}
(5.791) \quad & \sum_{p=0}^{\infty} \left( \left( \Gamma \left( 0, \frac{1}{2}i(-1+2p)\pi \right) + \Gamma \left( 0, -\frac{1}{2}i(3+2p)\pi \right) \right) \log \left( -\frac{1}{2}(i\pi) \right) \right. \\
& \left. + G_{2,3}^{3,0} \left( \frac{1}{2}i(-1+2p)\pi \left| \begin{matrix} 1, 1 \\ 0, 0, 0 \end{matrix} \right. \right) + G_{2,3}^{3,0} \left( -\frac{1}{2}i(3+2p)\pi \left| \begin{matrix} 1, 1 \\ 0, 0, 0 \end{matrix} \right. \right) \right) \\
& = \frac{1}{2} \log(2) \left( 2\gamma + i\pi + \log \left( \frac{1}{2\pi^2} \right) \right)
\end{aligned}$$

EXAMPLE 5.789.

$$(5.792) \quad \sum_{p=0}^{\infty} \left( E_{-k} \left( \frac{1}{2}i(-1+2p)\pi \right) + E_{-k} \left( -\frac{1}{2}i(3+2p)\pi \right) \right) = 2^{1+k} (-1 + 2^{1+k}) \zeta(-k)$$

EXAMPLE 5.790.

$$\begin{aligned}
(5.793) \quad & \sum_{p=1}^n \left( \frac{2^p}{(1+q^{2^{-1+p}})^2} + \frac{-2^p+a}{1+q^{2^{-1+p}}} - \frac{2^{1+p}}{(1+q^{2^p})^2} + \frac{2^{1+p}-a}{1+q^{2^p}} \right) \\
& = \frac{a+(-2+a)q}{(1+q)^2} + \frac{2^{1+n}q^{2^n}}{(1+q^{2^n})^2} - \frac{a}{1+q^{2^n}}
\end{aligned}$$

EXAMPLE 5.791.

$$(5.794) \quad \sum_{p=1}^{\infty} \left( \frac{2^p}{(1+q^{2^{-1+p}})^2} + \frac{-2^p+a}{1+q^{2^{-1+p}}} - \frac{2^{1+p}}{(1+q^{2^p})^2} + \frac{2^{1+p}-a}{1+q^{2^p}} \right) = -\frac{q(2+a+aq)}{(1+q)^2}$$

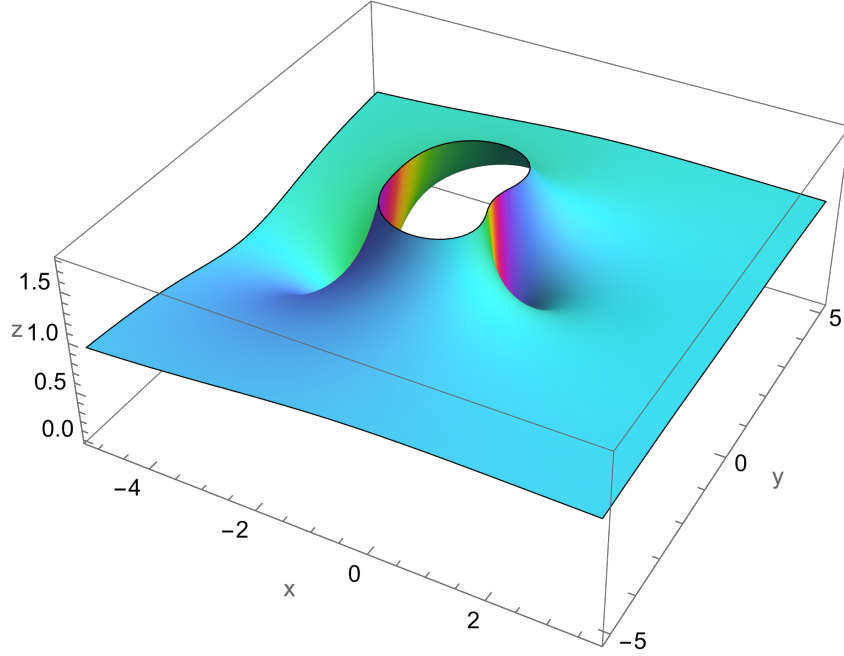

FIGURE 31. Plot of  $f(q) = -\frac{q(q+3)}{(q+1)^2}$ ,  $q \in \mathbb{C}$ .

EXAMPLE 5.792.

$$(5.795) \quad \sum_{p=1}^n 4^{-p} \left( \frac{1}{(1+q^{2^{-1-p}})^2} + \frac{-1+2^{1+p}a}{1+q^{2^{-1-p}}} - \frac{2}{(1+q^{2^{-p}})^2} - \frac{2(-1+2^p a)}{1+q^{2^{-p}}} \right)$$

$$= \frac{\sqrt{q}(1-2a(-1+q)+q)}{(-1+q)^2} + \frac{4^{-n}q^{2^{-1-n}}(-1-2^{1+n}a+(-1+2^{1+n}a)q^{2^{-n}})}{(-1+q^{2^{-n}})^2}$$

EXAMPLE 5.793.

$$(5.796) \quad \sum_{p=1}^{\infty} 4^{-p} \left( \frac{1}{(1+q^{2^{-1-p}})^2} + \frac{-1+2^{1+p}a}{1+q^{2^{-1-p}}} - \frac{2}{(1+q^{2^{-p}})^2} - \frac{2(-1+2^p a)}{1+q^{2^{-p}}} \right)$$

$$= \frac{\sqrt{q}(1-2a(-1+q)+q)}{(-1+q)^2} + \frac{2(-1+a \log(q))}{\log^2(q)}$$

EXAMPLE 5.794.

$$(5.797) \quad -\frac{(\beta^{-q})^{-\frac{m}{q}} \Gamma\left(n - \frac{m}{q}\right) \Gamma\left(\frac{m}{q}\right) \left(\log(\beta^{-q}) + \psi^{(0)}\left(n - \frac{m}{q}\right) - \psi^{(0)}\left(\frac{m}{q}\right)\right)}{q^2 \Gamma(n)}$$

$$= \sum_{t=0}^{-1+n} \sum_{j=0}^{-1+n} \frac{(-1)^{j+t} e^{\frac{im\pi}{q}} (2\pi)^{2-t} \left(-\frac{1}{q}\right)^t \left(\frac{i}{q}\right)^{-t} (\beta^{-q})^{-\frac{m}{q}} \left(-\frac{m-q}{q}\right)_{-1-j+n} (2-t)_t \mathcal{S}_j^{(t)}}{q^2 j! (-1-j+n)!}$$

$$\Phi \left( e^{\frac{2im\pi}{q}}, -1 + t, \frac{\pi + i \log(\beta^{-q})}{2\pi} \right)$$

EXAMPLE 5.795.

$$\begin{aligned} (5.798) \quad & \frac{(\beta^{-q})^{-\frac{m}{q}} \Gamma \left( n - \frac{m}{q} \right) \Gamma \left( \frac{m}{q} \right)}{q\Gamma(n)} \left( \log^2(\beta^{-q}) + \psi^{(0)} \left( n - \frac{m}{q} \right)^2 \right. \\ & + 2\psi^{(0)} \left( n - \frac{m}{q} \right) \left( \log(\beta^{-q}) - \psi^{(0)} \left( \frac{m}{q} \right) \right) - 2\log(\beta^{-q}) \psi^{(0)} \left( \frac{m}{q} \right) + \psi^{(0)} \left( \frac{m}{q} \right)^2 \\ & \left. + \psi^{(1)} \left( n - \frac{m}{q} \right) + \psi^{(1)} \left( \frac{m}{q} \right) \right) \\ = & \sum_{t=0}^{-1+n} \sum_{j=0}^{-1+n} \frac{(-1)^{j+t} e^{\frac{im\pi}{q}} (2\pi)^{3-t} \left( -\frac{1}{q} \right)^t \left( \frac{i}{q} \right)^{1-t} (\beta^{-q})^{-\frac{m}{q}} \left( -\frac{m-q}{q} \right)_{-1-j+n} (3-t)_t S_j^{(t)}}{j! (-1-j+n)!} \\ & \Phi \left( e^{\frac{2im\pi}{q}}, -2 + t, \frac{\pi + i \log(\beta^{-q})}{2\pi} \right) \end{aligned}$$

5.3.1. Formulae derived from equation (4.168) and section (7) in [2].

EXAMPLE 5.796.

$$(5.799) \quad \sum_{k=0}^{\infty} \frac{(k+1)^{k-1} (y \exp(-y))^k}{(k+2)!} = -\frac{e^y (2 - 2e^y + 2y + y^3)}{2y^2}$$

EXAMPLE 5.797.

$$(5.800) \quad \sum_{k=0}^{\infty} \frac{(k+1)^{k-1} (y \exp(-y))^k}{(k+3)!} = -\frac{e^y (-1 + e^{2y} - 16e^y y + 2y(1+y)(7+2y^2))}{16y^3}$$

EXAMPLE 5.798.

$$(5.801) \quad \sum_{k=0}^{\infty} \frac{(k+1)^{k-1} (y \exp(-y))^k}{(k+4)!} = \frac{e^y (-16 + 16e^{3y} - 243e^{2y}y + 1944e^y y^2 - 3y(-65 + 6y(85 + y(85 + 6y(5 + 3y)))))}{3888y^4}$$

EXAMPLE 5.799.

$$(5.802) \quad \sum_{k=0}^{\infty} \frac{(k+1)^{k-1} (y \exp(-y))^k}{(k+5)!} = \frac{e^y}{995328y^5} (243 - 243e^{4y} + 4096e^{3y}y - 31104e^{2y}y^2 + 165888e^y y^3 - 4y(781 + 6y(-865 + 12y(415 + y(415 + 12y(13 + 6y))))))$$

EXAMPLE 5.800.

$$\begin{aligned}
(5.803) \quad & \sum_{k=0}^{\infty} \frac{(k+1)^{k-1}(y \exp(-y))^k}{(k+6)!} \\
&= \frac{e^y}{77760000000y^6} (-995328 + 995328e^{5y} - 18984375e^{4y}y + 160000000e^{3y}y^2 \\
&\quad - 810000000e^{2y}y^3 + 324000000e^y y^4 - 5y(-2801547 \\
&\quad + 20y(965041 + 30y(-153713 + 60y(12019 + y(12019 + 60y(77 + 30y))))))
\end{aligned}$$

EXAMPLE 5.801.

$$\begin{aligned}
(5.804) \quad & \sum_{k=0}^{\infty} \frac{(k+1)^{k-1}(y \exp(-y))^k}{(k+7)!} \\
&= \frac{e^y}{4199040000000y^7} (2500000 - 2500000e^{6y} + 53747712e^{5y}y \\
&\quad - 512578125e^{4y}y^2 + 2880000000e^{3y}y^3 - 10935000000e^{2y}y^4 + 34992000000e^y y^5 \\
&\quad - 3y(12915904 + 15y(-6418657 + 20y(1568371 + 90y(-66801 + 20y(13489 \\
&\quad + y(13489 + 180y(29 + 10y))))))
\end{aligned}$$

EXAMPLE 5.802.

$$\begin{aligned}
(5.805) \quad & \sum_{k=0}^{\infty} \frac{(k+1)^{k-1}(y \exp(-y))^k}{(k+8)!} \\
&= \frac{e^y}{16944640993728000000y^8} (-4199040000000 + 4199040000000e^{7y} \\
&\quad + 71490737500000y - 100884017500000e^{6y}y - 582029398598592y^2 \\
&\quad + 1084457023598592e^{5y}y^2 + 3048374148022665y^3 - 6894792071015625e^{4y}y^3 \\
&\quad - 11819395880919900y^4 + 29054597040000000e^{3y}y^4 + 38514655699821000y^5 \\
&\quad - 88253338509000000e^{2y}y^5 - 138426709885380000y^6 + 235342236024000000e^y y^6 \\
&\quad - 138426709885380000y^7 - 53552365952400000y^8 - 16810159716000000y^9)
\end{aligned}$$

EXAMPLE 5.803.

$$\begin{aligned}
(5.806) \quad & \sum_{k=0}^{\infty} \frac{(k+1)^{k-1}(y \exp(-y))^k}{(k+9)!} \\
&= -\frac{e^y}{22209679843299164160000000y^9} (-20684376213046875 + 20684376213046875e^{8y} \\
&\quad + 384901561175625000y - 550376570880000000e^{7y}y - 3420799013537500000y^2 \\
&\quad + 6611534970880000000e^{6y}y^2 + 19430599723471550208y^3 - 47380650332371550208e^{5y}y^3 \\
&\quad - 80099863968742248960y^4 + 225928546583040000000e^{4y}y^4 + 261589888296724377600y^5 \\
&\quad - 761648828645376000000e^{3y}y^5 - 750777617069512704000y^6 + 1927923597508608000000e^{2y}y^6 \\
&\quad + 2455119676203909120000y^7 - 4406682508591104000000e^y y^7 + 2455119676203909120000y^8 \\
&\quad + 946256377960857600000y^9 + 275417656786944000000y^{10})
\end{aligned}$$

5.3.2. *Formulae derived from equation (4.169) and section (7) in [2].*

EXAMPLE 5.804.

$$(5.807) \quad \sum_{k=0}^{\infty} \frac{(k+2)^k (y \exp(-y))^{k+1}}{(k+3)!} = -\frac{2e^y - 2e^{2y} + 2e^y y + y^2 + e^y y^3}{2y^2}$$

EXAMPLE 5.805.

$$(5.808) \quad \sum_{k=0}^{\infty} \frac{(k+2)^k (y \exp(-y))^{k+1}}{(k+4)!} = -\frac{3e^{3y} - 48e^{2y}y + 8y^3 + 3e^y(-1 + 2y(1+y)(7+2y^2))}{48y^3}$$

EXAMPLE 5.806.

$$(5.809) \quad \sum_{k=0}^{\infty} \frac{(k+2)^k (y \exp(-y))^{k+1}}{(k+5)!} \\ = -\frac{1}{24} - \frac{5e^y}{36} - \frac{e^y}{243y^4} + \frac{e^{4y}}{243y^4} + \frac{65e^y}{1296y^3} - \frac{e^{3y}}{16y^3} - \frac{85e^y}{216y^2} + \frac{e^{2y}}{2y^2} - \frac{85e^y}{216y} - \frac{e^y y}{12}$$

EXAMPLE 5.807.

$$(5.810) \quad \sum_{k=0}^{\infty} \frac{(k+2)^k (y \exp(-y))^{k+1}}{(k+6)!} \\ = -\frac{1}{120} - \frac{13e^y}{288} + \frac{e^y}{4096y^5} - \frac{e^{5y}}{4096y^5} - \frac{781e^y}{248832y^4} + \frac{e^{4y}}{243y^4} + \frac{865e^y}{41472y^3} - \frac{e^{3y}}{32y^3} - \frac{415e^y}{3456y^2} \\ + \frac{e^{2y}}{6y^2} - \frac{415e^y}{3456y} - \frac{e^y y}{48}$$

5.3.3. *Formulae derived using equation (4.171) and section (7) in [2].*

EXAMPLE 5.808.

$$(5.811) \quad \sum_{k=1}^{\infty} \frac{k^{k-1} (y \exp(-y))^k}{(k+2)!} = \frac{-1 + e^{2y} + 6y - 8e^y y + 6y^2 + 4y^3}{8y^2}$$

EXAMPLE 5.809.

$$(5.812) \quad \sum_{k=1}^{\infty} \frac{k^{k-1} (y \exp(-y))^k}{(k+3)!} = \frac{8 - 8e^{3y} - 57y + 81e^{2y}y + 198y^2 - 324e^y y^2 + 198y^3 + 108y^4}{648y^3}$$

EXAMPLE 5.810.

$$(5.813) \quad \sum_{k=1}^{\infty} \frac{k^{k-1} (y \exp(-y))^k}{(k+4)!} \\ = \frac{-81 + 81e^{4y} + 700y - 1024e^{3y}y - 2760y^2 + 5184e^{2y}y^2 + 7200y^3 - 13824e^y y^3 + 7200y^4 + 3456y^5}{82944y^4}$$

EXAMPLE 5.811.

$$\begin{aligned}
(5.814) \quad & \sum_{k=1}^{\infty} \frac{k^{k-1} (y \exp(-y))^k}{(k+5)!} \\
&= \frac{1}{1296000000y^5} (82944 - 82944e^{5y} - 850905y + 1265625e^{4y}y + 3974300y^2 \\
&\quad - 8000000e^{3y}y^2 - 11397000y^3 + 27000000e^{2y}y^3 + 24660000y^4 - 54000000e^y y^4 \\
&\quad + 24660000y^5 + 10800000y^6)
\end{aligned}$$

## 6. Table of arctangent definite integrals

$f(x)$	$\int_0^{\infty} f(x) dx$
$\cos(mx) \tan^{-1}(\sinh(\alpha)\operatorname{sech}(bx))$	$\frac{\pi \operatorname{sech}(\frac{\pi m}{2b}) \sin(\frac{\alpha m}{b})}{2m}$
$\frac{(x^2-1) \tanh^{-1}(\operatorname{sech}(\pi x))}{(x^2+1)^2}$	$-\frac{1}{2} \pi (\log(4) - 1)$
$\frac{(12x^2-1) \tanh^{-1}(\operatorname{sech}(\pi x))}{(4x^2+1)^3}$	$\frac{1}{8} (\pi - 2\pi C)$
$\frac{(x^4-6x^2+1) \tanh^{-1}(\operatorname{sech}(\pi x))}{(x^2+1)^4}$	$\frac{1}{12} \pi (3\zeta(3) - 2)$
$\left( \frac{1}{(1+ix)^6} - \frac{1}{(x+i)^6} \right) \tanh^{-1}(\operatorname{sech}(\pi x))$	$\frac{1}{40} \pi (15\zeta(5) - 8)$
$\left( \frac{1}{(1+ix)^{3/2}} + \frac{1}{(1-ix)^{3/2}} \right) \tanh^{-1}(\operatorname{sech}(\pi x))$	$-4(\sqrt{2}-1) \pi \zeta\left(\frac{1}{2}\right) - 2\pi$
$\left( \frac{1}{\sqrt{1+ix}} + \frac{1}{\sqrt{1-ix}} \right) \tanh^{-1}(\operatorname{sech}(\pi x))$	$(1-2\sqrt{2}) \zeta\left(\frac{3}{2}\right) + 2\pi$
$\frac{\tan^{-1}(\sinh(\alpha)\operatorname{sech}(bx))}{\log^2(a)+x^2}$	$-\frac{i\pi \log\left(\frac{\Gamma\left(\frac{-2i\alpha+2b \log(a)+\pi}{4\pi}\right) \Gamma\left(\frac{2i\alpha+2b \log(a)+3\pi}{4\pi}\right)}{\Gamma\left(\frac{-2i\alpha+2b \log(a)+3\pi}{4\pi}\right) \Gamma\left(\frac{2i\alpha+2b \log(a)+\pi}{4\pi}\right)}\right)}{2 \log(a)}$
$\frac{\tanh^{-1}(\operatorname{sech}(\pi x))}{x^2+1}$	$-\frac{1}{2} \pi \log\left(\frac{2}{\pi}\right)$
$\frac{\tanh^{-1}(\sin(\alpha)\operatorname{sech}(bx))}{a^2+x^2}$	$-\frac{\pi \log\left(\frac{\Gamma\left(\frac{2ab-2\alpha+3\pi}{4\pi}\right) \Gamma\left(\frac{2ab+2\alpha+\pi}{4\pi}\right)}{\Gamma\left(\frac{2ab-2\alpha+\pi}{4\pi}\right) \Gamma\left(\frac{2ab+2\alpha+3\pi}{4\pi}\right)}\right)}{2a}$
$\frac{\tanh^{-1}(\operatorname{sech}(x))}{(x^2+\pi^2)^2}$	$\frac{\log\left(\frac{2\pi}{e}\right)}{4\pi^2}$
$\frac{\coth^{-1}(\sqrt{2} \cosh(9\pi x))}{x^2+4}$	$-\frac{1}{4} \pi \log\left(\frac{\Gamma\left(\frac{75}{8}\right) \Gamma\left(\frac{77}{8}\right)}{\Gamma\left(\frac{73}{8}\right) \Gamma\left(\frac{79}{8}\right)}\right)$
$\operatorname{sech}(t) \tanh^{-1}(\sin(\alpha)\operatorname{sech}(ab \sinh(t)))$	$-\frac{1}{2} \pi \log\left(\frac{\Gamma\left(\frac{2ab-2\alpha+3\pi}{4\pi}\right) \Gamma\left(\frac{2ab+2\alpha+\pi}{4\pi}\right)}{\Gamma\left(\frac{2ab-2\alpha+\pi}{4\pi}\right) \Gamma\left(\frac{2ab+2\alpha+3\pi}{4\pi}\right)}\right)$
$\operatorname{sech}(t) \tanh^{-1}\left(\operatorname{sech}\left(\frac{1}{4}\pi \sinh(t)\right)\right)$	$-\frac{1}{2} \pi \log\left(\frac{\Gamma\left(\frac{5}{8}\right)^2}{\Gamma\left(\frac{1}{8}\right) \Gamma\left(\frac{9}{8}\right)}\right)$



$f(x_1 \dots x_{j+1})$	$\int_0^\infty \dots \int_0^\infty f(x_1 \dots x_{j+1}) dx_1 \dots dx_{j+1}$
$\frac{\frac{x_1^{m-1}}{x_1^n+1} \left( \prod_{l=1}^j \frac{x_{l+1}^{2^{l-1}m+\frac{n}{2}-1}}{x_{l+1}^n+1} \right)}{x_1^p \left( \prod_{l=1}^j \frac{x_{l+1}^{2^{l-1}p+\frac{n}{2}-1}}{x_{l+1}^n+1} \right) - x_1^m \left( \prod_{l=1}^j \frac{x_{l+1}^{2^{l-1}m+\frac{n}{2}-1}}{x_{l+1}^n+1} \right)}$ $\frac{\sqrt[6]{x_1} \left( \prod_{l=1}^j \frac{x_{l+1}^{2^{j-1}+\frac{2^l}{3}-1}}{x_{l+1}^{2^j}+1} \right) - \prod_{l=1}^j \frac{x_{l+1}^{2^{j-1}+2^{l-2}-1}}{x_{l+1}^{2^j}+1}}{\sqrt{x_1}(x_1^{2^j}+1) \log(x_1(\prod_{l=1}^j x_{l+1}^{2^{l-1}}))}$ $\frac{\prod_{l=1}^j \frac{x_{l+1}^{2^{j-1}+2^{l-2}-1}}{x_{l+1}^{2^j}+1} \log^k(x_1(-\prod_{l=1}^j x_{l+1}^{2^{l-1}}))}{\sqrt{x_1}(x_1^{2^j}+1)}$ $\frac{\prod_{l=1}^j \frac{x_{l+1}^{2^{j-1}+2^{l-2}-1}}{x_{l+1}^{2^j}+1}}{\sqrt{x_1}(x_1^{2^j}+1) \log(x_1(-\prod_{l=1}^j x_{l+1}^{2^{l-1}}))}$ $\frac{\prod_{l=1}^j \frac{x_{l+1}^{2^{j-1}+2^{l-2}-1}}{x_{l+1}^{2^j}+1}}{\sqrt{x_1}(x_1^{2^j}+1) \log^3(x_1(-\prod_{l=1}^j x_{l+1}^{2^{l-1}}))}$ $\frac{\prod_{l=1}^j \frac{x_{l+1}^{2^{j-1}+2^{l-2}-1}}{x_{l+1}^{2^j}+1}}{\sqrt{x_1}(x_1^{2^j}+1) \log^5(x_1(-\prod_{l=1}^j x_{l+1}^{2^{l-1}}))}$ $\frac{\prod_{l=1}^j \frac{x_{l+1}^{2^{j-1}+2^{l-2}-1}}{x_{l+1}^{2^j}+1} \log(\log(x_1(-\prod_{l=1}^j x_{l+1}^{2^{l-1}})))}{\sqrt{x_1}(x_1^{2^j}+1) \log(x_1(-\prod_{l=1}^j x_{l+1}^{2^{l-1}}))}$ $\frac{\prod_{l=1}^j \frac{x_{l+1}^{2^{j-1}+2^{l-2}-1}}{x_{l+1}^{2^j}+1} \log(\log(x_1(-\prod_{l=1}^j x_{l+1}^{2^{l-1}})))}{\sqrt{x_1}(x_1^{2^j}+1) \log^2(x_1(-\prod_{l=1}^j x_{l+1}^{2^{l-1}}))}$ $\frac{\prod_{l=1}^j \frac{x_{l+1}^{2^{j-1}+2^{l-3}-1}}{x_{l+1}^{2^j}+1} \log(\log(ax_1(\prod_{l=1}^j x_{l+1}^{2^{l-1}})))}{x_1^{3/4}(x_1^{2^j}+1)}$	$2^j \pi^{j+1} n^{-j-1} \operatorname{csc}\left(\frac{\pi 2^j m}{n}\right)$ $2\pi^j n^{-j} \left( \tanh^{-1}\left(e^{\frac{i\pi 2^j m}{n}}\right) - \tanh^{-1}\left(e^{\frac{i\pi 2^j p}{n}}\right) \right)$ $\frac{1}{2} (2^j)^{-j} \pi^j \log(3)$ $(2^j)^{-j-1} i^k (1-2^{k+1}) (2\pi)^{j+k+1} \zeta(-k)$ $-i (2^j)^{-j} \pi^j \log(2)$ $\frac{3}{16} i (2^j)^{-j} \pi^{j-2} \zeta(3)$ $-\frac{15}{256} i (2^j)^{-j} \pi^{j-4} \zeta(5)$ $\frac{1}{2} (2^j)^{-j} \pi^j \log(2) (2i\gamma + \pi - i \log(8\pi^2))$ $\frac{1}{48} (2^j)^{-j} \pi^{j+1} (-24 \log(A) + 2\gamma - i\pi + \log(4))$ $\frac{(2^j)^{-j} \pi^{j+1} (i\pi + \log(64) + 2 \log(\pi))}{\sqrt{2}} +$ $(-1 +$ $i) \sqrt{2} (2^j)^{-j} \pi^{j+1} \log\left(\frac{\Gamma\left(\frac{\pi-i \log(a)}{8\pi}\right)}{\Gamma\left(\frac{5}{8} - \frac{i \log(a)}{8\pi}\right)}\right) +$ $(-1 -$ $i) \sqrt{2} (2^j)^{-j} \pi^{j+1} \log\left(\frac{\Gamma\left(\frac{3}{8} - \frac{i \log(a)}{8\pi}\right)}{\Gamma\left(\frac{7}{8} - \frac{i \log(a)}{8\pi}\right)}\right)$

References

[1] Reynolds, R.; Stauffer, A. A Method for Evaluating Definite Integrals in Terms of Special Functions with Examples. *Int. Math. Forum* (2020), 15, 235-244, doi:10.12988/imf.2020.91272

[2] Reynolds R, Stauffer A (2023) *Chebyshev series: Derivation and evaluation*. PLoS ONE 18(3): e0282703. <https://doi.org/10.1371/journal.pone.0282703>

- [3] Olver, F.W.J.; Lozier, D.W.; Boisvert, R.F.; Clark, C.W. (Eds.) *NIST Digital Library of Mathematical Functions*; U.S. Department of Commerce, National Institute of Standards and Technology: Washington, DC, USA; Cambridge University Press: Cambridge, UK, 2010; With 1 CD-ROM (Windows, Macintosh and UNIX). MR 2723248 (**2012a**:33001).
- [4] Gradshteyn, I.S.; Ryzhik, I.M. *Tables of Integrals, Series and Products*, 6th ed.; Academic Press: Cambridge, MA, USA, (**2000**).
- [5] Bruce C. Berndt, *Ramanujan's Notebooks Part II*, (**1989**), Springer-Verlag New York Entry (23)
- [6] Bateman, Harry, and Bateman Manuscript Project. (**1954**). *Tables of Integral Transforms* (version Published). Volume 1, New York: McGraw-Hill Book Company. Eq. (1.9.51)
- [7] Brychkov, Y., Marichev, O., & Savischenko, N. (**2018**). *Handbook of Mellin Transforms* (1st ed.). Chapman and Hall/CRC. <https://doi.org/10.1201/9780429434259> Eq. (2.1.5.7)
- [8] A. P. Prudnikov, Yu. A. Brychkov, and O. I. Marichev (**1986b**) *Integrals and Series: Special Functions, Vol. 2.*, Gordon & Breach Science Publishers, New York.
- [9] D. Bierens de Haan (**1939**) *Nouvelles Tables d'Intégrales Définies*. G.E. Stechert & Co., New York.
- [10] Ernst Schröder, *Zeitschrift für Mathematik und Physik*, vol. 25, pp. 106–117 (**1880**).
- [11] F. Oberhettinger (**1990**) *Tables of Fourier Transforms and Fourier Transforms of Distributions*. Springer-Verlag, Berlin.
- [12] Bateman, Harry, and Bateman Manuscript Project. (**1954**). *Tables of Integral Transforms* (version Published). Volume I, New York: McGraw-Hill Book Company.
- [13] Andrei D. Polyanin, Alexander V. Manzhirov, *Handbooks of mathematical equations, Handbook of integral equations*, Chapman & Hall CRC (**2008**). Eq. (4.3.10)
- [14] Berndt, B.C. *Integrals associated with Ramanujan and elliptic functions*. *Ramanujan J* 41, 369-389 (2016). <https://doi.org/10.1007/s11139-016-9793-1>
- [15] von Anton Winckler, *Über die Eigenschaften einiger bestimmten Integrale*, (vorgelegt in der Sitzung vom 3. Jänner **1861**), K. K. Court and State Dr., 1861, pp.359
- [16] A. P. Prudnikov, Yu. A. Brychkov, and O. I. Marichev (**1986b**) *Integrals and Series: Special Functions, Vol. 2.*, Gordon & Breach Science Publishers, New York.
- [17] A. P. Prudnikov, Yu. A. Brychkov, and O. I. Marichev (**1990**) *Integrals and Series: More Special Functions, Vol. 3.*, Gordon and Breach Science Publishers, New York.
- [18] A. P. Prudnikov, Yu. A. Brychkov, and O. I. Marichev (1992a) *Integrals and Series: Direct Laplace Transforms*, Vol. 4. Gordon and Breach Science Publishers, New York.
- [19] A. P. Prudnikov, Yu. A. Brychkov, and O. I. Marichev (1992b) *Integrals and Series: Inverse Laplace Transforms*, Vol. 5. Gordon and Breach Science Publishers, New York.
- [20] Yu. A. Brychkov & P. C. Sofotasios (**2023**) *On some properties of the Neumann polynomials*, *Integral Transforms and Special Functions*, 34:4, 316-333, DOI:10.1080/10652469.2022.2118738. Eq. (1.4)
- [21] Bromwich, T.J., Watson, G.N., *An Introduction to the Theory of Infinite Series*. *Nature* 78, 242 (**1908**). <https://doi.org/10.1038/078242a0>
- [22] S. K. Chatterjea, *On a generating function of Laguerre polynomials.*, *Bollettino dell'Unione Matematica Italiana, Serie 3, Vol. 17, (1962)*, n.2, p. 179-182.
- [23] H. Buchholz (**1969**) *The Confluent Hypergeometric Function with Special Emphasis on Its Applications*. Springer-Verlag, New York.
- [24] E. R. Hansen (**1975**) *A Table of Series and Products*. Prentice-Hall, Englewood Cliffs, N.J..
- [25] Dieckmann, A. A Collection of Infinite Products and Series. Available online: <http://www-elsa.physik.uni-bonn.de/~dieckman/InfProd/InfProd.html> (accessed on 2 November **2023**).
- [26] G. E. Andrews, R. Askey, and R. Roy (**1999**) *Special Functions. Encyclopedia of Mathematics and its Applications*, Vol. 71, Cambridge University Press, Cambridge. Eq. (2) on page 626
- [27] Bruce C. Berndt *Modular transformations and generalizations of several formulae of Ramanujan,* *Rocky Mountain Journal of Mathematics*, *Rocky Mountain J. Math.* 7(1), 147-190, (Winter **1977**) Eq. (3.31)
- [28] A. R. Vasishtha, Dr. S. K. Sharma, A. K. Vasishtha, *Krishna's Series Trigonometry and Algebra: For the Degree Part First Students of C.C.S. University, Meerut and all other Indian Universities and for various Competitive Examination like I.A.S., P.C.S., etc.*, Krishna Prakashan Media. 6th Edition, (**2009**).

- [29] Hind, John. *The Elements of Plane and Spherical Trigonometry*. United Kingdom: Deighton, Bell & Company, (1855). pp. 170 exercise 9.
- [30] Bedford, T., Quigley, J., Walls, L., Alkali, B., Daneshkhah, A., Hardman, G. , *Advances in Mathematical Modeling for Reliability*. Iran: IOS Press, (2008).
- [31] Jolley, L. B. W. (Leonard Benjamin William), *Summation of series, b*, New York, Dover Publications, (1886)
- [32] Edwards, Joseph, 1854-1931. *Differential Calculus With Applications And Numerous Examples: an Elementary Treatise.*, London, etc: Macmillan and co., (1886). pp.71.
- [33] Brafman, Fred. "Generating Functions of Jacobi and Related Polynomials.", *Proceedings of the American Mathematical Society* 2, no. 6 (1951): 942[49]. <https://doi.org/10.2307/2031712>.
- [34] C. V. Durell and A. Robson, *Advanced Trigonometry*, Courier Corporation, 352 pages, (1882).
- [35] Hall, Henry Sinclair., Knight, Samuel Ratcliffe. *Elementary Trigonometry*. India: Macmillan and Company, (1893.) Eq. (18) pp. 292
- [36] Hobson, Ernest William (1856-1933), *A treatise on plane trigonometry*, (1918), Cambridge, England, University Press
- [37] Borwein, J. M. and Borwein, P. B. *Evaluation of Sums of Reciprocals of Fibonacci Sequences.* §3.7 in *Pi & the AGM: A Study in Analytic Number Theory and Computational Complexity*. New York: Wiley, pp. 91-101, (1987).
- [38] Bruce C. Berndt, *Ramanujan's Notebooks Part II*, (1989), Springer-Verlag New York Entry (23)
- [39] Berndt, B. C. "*q-Series.*", Ch. 27 in *Ramanujan's Notebooks, Part IV*. New York: Springer-Verlag, pp. 261-286, (1994).
- [40] Bateman, Harry, and Bateman Manuscript Project. (1954). *Tables of Integral Transforms* (version Published). Volume 1., New York: McGraw-Hill Book Company.
- [41] Bateman, Harry, and Bateman Manuscript Project. (1954). *Tables of Integral Transforms* (version Published). Volume 2., New York: McGraw-Hill Book Company.
- [42] R. S. Pathak. O. P. Singh. "*Finite Hankel transforms of distributions.*" *Pacific J. Math.* 99 (2) 439 - 458, (1982).
- [43] Blagouchine, I.V. *Rediscovery of Malmsten's integrals, their evaluation by contour integration methods and some related results.* *Ramanujan J* 35, 21-110 (2014). <https://doi.org/10.1007/s11139-013-9528-5>
- [44] Jeffreys, H. and Jeffreys, B. S. *Frullani's Integrals. §12.16 in Methods of Mathematical Physics*, 3rd ed. Cambridge, England: Cambridge University Press, pp. 406-407, (1988).

(Robert Reynolds) DEPARTMENT OF MATHEMATICS AND STATISTICS, YORK UNIVERSITY, TORONTO, ON, CANADA, M3J1P3

Email address, Corresponding author: milver73@gmail.com