

# ON HOMOMORPHISMS AND GENERICALLY $\tau$ -REDUCED COMPONENTS FOR SKEWED-GENTLE ALGEBRAS

CHRISTOF GEISS

ABSTRACT. Let  $k$  be an algebraically closed field with  $\text{char}(k) \neq 2$ , and  $A$  a skewed-gentle  $k$ -algebra. In this case, Crawley-Boevey's description of the indecomposable  $A$ -modules becomes particularly easy. This allows us to provide an explicit basis for the homomorphisms between any two indecomposable representations in terms of the corresponding admissible words in the sense of Qiu and Zhou [QZ17]. Previously [Ge99], such a basis was only available when no asymmetric band modules were involved. We also extend a relaxed version of fringing and kisses from Brüstle et al. [BrY20] to the setting of skewed-gentle algebras. With this at hand, we obtain convenient formulae for the E-invariant and g-vector for indecomposable  $A$ -modules, similar to the known expressions for gentle algebras, see also [PPP21]. Note however, that we allow in our context also band-modules. As an application, we describe the indecomposable, generically  $\tau$ -reduced irreducible components of the representation varieties of  $A$  as well as the generic values of the E-invariant between them in terms tagged admissible words.

## 1. INTRODUCTION

1.1. **Context.** W. Crawley-Boevey [CrB89b] introduced clans and clannish algebras and gave a parametrization of their indecomposable representations over any field with at least three elements. Later, V. Bondarenko [Bo91] and B. Deng [De00] gave a description, which works over any field. This description of the indecomposable representations, in terms of symmetric resp. asymmetric strings and bands, is in general notoriously more involved than the well-known classification of modules for string algebras [BuR87]. Motivated by the works [CrB89a] and [Kr91] we gave in [Ge99] a partial answer to the description of homomorphisms between representations of clans in the description of Deng. This was good enough to describe their Auslander-Reiten theory. However, the description of homomorphisms between indecomposable modules, which involve asymmetric bands in [Ge99] is incomplete, due to combinatorial difficulties.

As pointed out by Crawley-Boevey [CrB89b], the indecomposable representations of clannish algebras can be described easily in terms of certain clans. Skewed-gentle algebras are a special case of clannish algebras. Motivated by the properties of gentle algebras, they were introduced in [GP99] because their derived category can be described in terms of the representations of a clannish algebra. So, skewed-gentle algebras are in particular derived tame. However, unlike gentle algebras, the class of skewed gentle algebras is not closed under derived equivalence.

Let  $\Sigma = (\Sigma, \mathbb{M}, \mathbb{P})$  a marked surface in the sense of [FST08] with marked points  $\mathbb{M} \subset \partial\Sigma$  and punctures  $\mathbb{P} \subset \Sigma \setminus \partial\Sigma$ . It is straight forward to construct in case  $\mathbb{M} \neq \emptyset$  a tagged triangulation  $T$  of signature 0. With the non-degenerate Labardini potential [LF09]  $W(T)$  for the quiver  $Q(T)$  of  $T$  the Jacobian algebra  $A(T) := \mathcal{P}_{\mathbb{C}}(Q(T), W(T))$  is easily identified as a skewed gentle algebra. In modern language, Qiu and Zhu outlined in [QZ17] that the tagged arcs for  $\Sigma$  correspond naturally to the decorated, indecomposable  $\tau$ -rigid representations of  $A(T)$ , and the E-invariant between two such modules is 0 if and

only if the (tagged) intersection number between the corresponding arcs vanishes. See also [AmP22] for more details.

It is our aim to show in a forthcoming paper, that the generic basis of the cluster algebra of such a marked surface  $\Sigma$  with  $|\mathbb{M}| \geq 2$  can be identified with the bangle basis from [MSW13]. In order to attack this problem, we need as a starting point a convenient description of the indecomposable, generically  $\tau$ -reduced irreducible components of the representation varieties of a skewed-gentle algebras, and we also need to understand how those components add up to arbitrary  $\tau$ -reduced irreducible components. In other words, we need to calculate the generic values of the E-invariant between *all* indecomposable, generically  $\tau$ -reduced irreducible components. Because of the above mentioned incomplete description of the homomorphisms between representations of skewed-gentle algebras in [Ge99], some extra work is needed. In the present manuscript we overcome those difficulties, by describing the homomorphisms for a particularly nice special case of Crawley-Boevey's description of the indecomposable modules of skewed gentle algebras, which works only over fields with characteristic different from 2.

We take here the opportunity to extend the notions of fringing and kisses for gentle algebras from [BrY20] to skewed-gentle algebras. This allows us to calculate the (generic) E-invariant between (irreducible components of) representations of skewed gentle algebras in an efficient way. This description will turn out to be convenient for the interpretation of the generic E-invariant as a kind of intersection number.

**1.2. Overview.** In Section 2 we introduce (admissible) polarized quivers and as a special case skewed-gentle polarized quivers. The latter ones are the combinatorial avatars of the above mentioned skewed-gentle algebras. Skewed-gentle polarized quivers contain a bit of redundant information if one just wants to recover skewed gentle algebras. However, the involved choices are convenient for our combinatorial study, and can be traced back at least to the work of Butler and Ringel [BuR87]. In the case of the Jacobian algebras coming from a tagged triangulation  $T = (\tau_1, \dots, \tau_n)$  of signature 0, the corresponding skewed-polarized quiver  $\underline{Q}(T)$  retains the information about the orientation of each of the arcs  $\tau_i$  for  $i = 1, 2, \dots, n$ .

The more general admissible polarized quivers turn out to be convenient for the description of the indecomposable representation of skewed gentle algebras over fields with  $\text{char } k \neq 2$ . Section 2 serves mainly to fix our notation, and to introduce asymmetric resp. symmetric strings and bands for skewed-gentle polarized quivers. Moreover, we introduce the combinatorial aspects of the Auslander-Reiten translation for representations of skewed-gentle algebras.

In Section 3 we study *admissible words* for a skewed-gentle polarized quiver  $\underline{Q}$ . These are a class of strings and bands for an auxiliary quiver  $\widehat{\underline{Q}}$ , where all special loops are considered as ordinary loops. However, the orientation of the letters, corresponding to those loops, have to fulfill a certain consistency rule, which involves possibly the orientation of other letters of this kind. Our Proposition 3.1 states, that this orientation problem can be solved uniquely by the rule, which was used for example by Crawley-Boevey [CrB89b, Sec. 3] in his description of the indecomposable representations of clannish algebras.

While finishing the present manuscript, we became aware of U. Hansper's PhD thesis [Ha22]. She showed, in Section 3.3 of her work, and with a different terminology, our Proposition 3.1. In her terminology the words of the form  $\text{Adm}(\mathbf{w})$  with  $\mathbf{w} \in \text{St}(\underline{Q}) \cup \text{pBa}'(\underline{Q})$  have a weakly consistent orientation, whilst the elements of  $\text{Adm}(\underline{Q})$  have a consistent orientation. We include anyway our (shorter) proof of this result in Appendix B.

Qiu and Zhou introduced in [QZ17, Sec. 2.5] admissible strings. They use them, without any further comment, in order to parametrize a large class of (indecomposable) representations for skewed-gentle algebras. Qiu and Zhou observed (without proof) in *loc. cit.* that admissible strings are very convenient to describe the homotopy classes of curves *without kinks* on punctured surfaces with  $\mathbb{M} \neq \emptyset$ . Apparently, they assumed silently the validity of our Proposition 3.1. We believe that this is a quite non-trivial fact.

In Section 4 we introduce, following Crawley-Boevey [CrB89b, Sec. 3], a quiver  $H(\mathbf{x})$  for each admissible word  $\mathbf{x}$  of a skewed-gentle quiver. The quivers  $H(\mathbf{x})$  should be seen as blue-prints for the indecomposable modules over the corresponding skewed-gentle algebra. We also introduce, inspired by [Ge99], a decorated quiver  $H_{\underline{Q}}(\mathbf{x}, \mathbf{y})$  for each pair of admissible words  $\mathbf{x}$  and  $\mathbf{y}$ . We will see from  $H_{\underline{Q}}(\mathbf{x}, \mathbf{y})$  it is possible to read off a basis of the homomorphisms between the representations corresponding to  $\mathbf{x}$  and  $\mathbf{y}$ . More precisely, we showed in [Ge99] that in many situations the *real h-lines* give rise to such a basis. Our first main result, Proposition 4.6, states that real h-lines are in bijection with *long h-lines*. The point is, that real h-lines are for example convenient to describe intersections between curves on punctured surfaces, as observed by Qiu and Zhou in [QZ17], and they seem to be the natural objects for study the homomorphisms between representations of clans (or skewed gentle algebras) over an arbitrary field. On the other hand, long h-lines *do not* depend on the orientation of the special letters. For this reason they are much easier to deal with. We will see in Theorem 5.5 that they parametrize a basis for the homomorphisms between *any* two indecomposable representations of skewed-gentle algebras over a field with characteristic different from 2. The notion of fringing and kisses, which was introduced in [BrY20] in order to calculate in a convenient way the  $E$ -invariant  $\dim \text{Hom}_A(M, \tau N) + \dim \text{Hom}_A(M, N)$  between string modules for gentle algebras. We extend this combinatorial device to strings and bands for skewed-gentle polarized quivers, see Section 4.9. We use the opportunity to relax by the the conditions on a fringing, which will be convenient for the study of skewed-gentle polarized quivers which come from admissible triangulation's of punctured surfaces.

In Section 5 we explain how to obtain from a skewed-gentle polarized quiver  $\underline{Q}$  and a field  $k$  with  $\text{char}(k) \neq 2$  a skewed gentle algebra  $k\underline{Q}$ . We also describe  $k\underline{Q}$  in terms of its Gabriel quiver  $\tilde{Q}$  and an admissible ideal. Then we apply our constructions to the module category of the skewed-gentle algebra  $k\underline{Q}$ . Under the hypothesis  $\text{char}(k) \neq 2$  Crawley-Boevey's description of the indecomposable modules for  $k\underline{Q}$  becomes quite easy, see Theorem 5.3. In particular, one has not to deal with the orientation of the special letters. This allows us to describe the homomorphisms between the indecomposable representations in terms of the above mentioned long resp. real h-lines, see Theorem 5.5. With this at hand, we deduce in Section 5.5 a convenient formula for the  $E$ -invariant between indecomposable representations of skewed-gentle algebras. The same Theorem, together with our theory of fringing, allows also, to deduce in Section 5.6 a formula for the  $g$ -vector of any indecomposable module over a skewed-gentle, algebra, which is inspired by shear coordinates.

Finally, in Section 6 let  $k$  an algebraically closed field with  $\text{char}(k) \neq 2$  and  $\underline{Q}$  a skewed-gentle polarized quiver. we give a combinatorial description of the set  $\text{Irr}_{\text{ind}}^{\tau} k\underline{Q}$  of indecomposable, generically  $\tau$ -reduced irreducible components for a skewed-gentle algebra  $k\underline{Q}$ . To this end we introduce the set of *tagged* admissible words  $\text{Adm}^*(\underline{Q})$ , and construct for each  $(\mathbf{x}, s) \in \text{Adm}^*(\underline{Q})$  a natural closed subset  $\overline{M}_{(\mathbf{x}, s)}^o \subset \text{rep}_{k\underline{Q}}^{\mathbf{d}(\mathbf{x}, s)}(k)$  of the corresponding representation variety of  $k\underline{Q}$ . Each  $\overline{M}_{(\mathbf{x}, s)}^o$  contains a dense subset of indecomposable

representations. Moreover, we introduce functions

$$e_{\underline{Q}}: \text{Adm}^*(\underline{Q}) \times \text{Adm}^*(\underline{Q}) \rightarrow \mathbb{N} \text{ and } \mathbf{g}_{\underline{Q}}: \text{Adm}^*(\underline{Q}) \rightarrow \mathbb{Z}^{\tilde{Q}_0},$$

which are combinatorially defined in terms of a fringing  $\underline{Q}^f$  and our notion of kisses. Our main result, Theorem 6.4, states that  $e_{\underline{Q}}((\mathbf{x}, s), (\mathbf{y}, t))$  gives the generic value of the  $E$ -invariant  $E_{k\underline{Q}}$  on  $\overline{M}_{(\mathbf{x}, s)}^o \times \overline{M}_{(\mathbf{y}, t)}^o$ , whilst  $\mathbf{g}_{\underline{Q}}(\mathbf{x}, s)$  gives the generic value of the  $g$ -vector  $\mathbf{g}_{k\underline{Q}}$  on  $\overline{M}_{(\mathbf{x}, s)}^o$ . Most importantly, with

$$\text{Adm}_\tau^*(\underline{Q}) := \{(\mathbf{x}, s) \in \text{Adm}^*(\underline{Q}) \mid e_{\underline{Q}}((\mathbf{x}, s), (\mathbf{x}, s)) = 0\},$$

our construction  $\overline{M}_\tau^o$  induces a bijection

$$([\text{Adm}_\tau^*(\underline{Q})]/\simeq) \rightarrow \text{Irr}_{\text{ind}}^\tau(k\underline{Q}), \quad [(\mathbf{x}, s)] \mapsto \overline{M}_{(\mathbf{x}, s)}^o$$

for an adequate equivalence relation on  $\text{Adm}^*(\underline{Q})$ .

In order to fix notation, and for the convenience of the reader we discuss in Appendix A in detail the indecomposable representations of the infinite dihedral group over an algebraically closed field  $k$  with  $\text{char}(K) \neq 2$ . This is in our context fundamental for the description of the indecomposable representations attached to symmetric bands.

## 2. POLARIZED QUIVERS AND THEIR COMBINATORICS

**2.1. Polarized quivers.** We introduce polarized quivers as a tool to study the combinatorics of representations of skewed-gentle algebras.

**Definition 2.1.** A *polarized quiver* is a tuple  $\underline{Q} = (Q_0, Q_1^{\text{sp}} \amalg Q_1^{\text{ord}}, \underline{s}, \underline{t})$ , where  $Q_0$  is the (finite) set of vertices,  $Q_1 = Q_1^{\text{sp}} \cup Q_1^{\text{ord}}$  is the set of arrows, which contains a (possibly empty) subset of “special” arrows  $Q_1^{\text{sp}}$ , and

$$\underline{s}, \underline{t}: Q_1 \rightarrow Q_0 \times \{-1, 1\}$$

are a pair of injective maps, which we write as  $\underline{s} = (s, s_1)$  and  $\underline{t} = (t, t_1)$ . Moreover, for each  $\varepsilon \in Q_1^{\text{sp}}$  there exists, by definition, a unique  $\varepsilon' \in Q_1^{\text{sp}}$  with  $\underline{s}(\varepsilon') = \underline{t}(\varepsilon)$  and  $\underline{t}(\varepsilon') = \underline{s}(\varepsilon)$ , and we request  $s_1(\varepsilon) = -1 = t_1(\varepsilon)$ .

An *admissible path* for  $\underline{Q}$  is a sequence of arrows  $\alpha_1 \alpha_2 \cdots \alpha_l$  such that  $\underline{s}(\alpha_i) = -\underline{t}(\alpha_{i+1})$  for  $i = 1, 2, \dots, l-1$ , where  $-\underline{t}(\alpha) := (t(\alpha), -t_1(\alpha))$ .  $\underline{Q}$  is *admissible* if it has only finitely many admissible paths.  $\underline{Q}$  is *skewed-gentle* resp. *gentle* if moreover  $Q_1^{\text{sp}}$  is contained in the set of loops of  $\underline{Q}$ , resp.  $Q_1^{\text{sp}} = \emptyset$ . A *homomorphism of polarized quivers*  $F: \underline{Q} \rightarrow \underline{Q}'$  consists of a pair of maps  $F_0: Q_0 \rightarrow Q'_0$  and  $F_1: Q_1 \rightarrow Q'_1$  such that for each arrow  $\alpha \in Q_1$  we have

$$\underline{s}'(F_1(\alpha)) = (F_0(s(\alpha)), s_1(\alpha)), \quad \underline{t}'(F_1(\alpha)) = (F_0(t(\alpha)), t_1(\alpha)) \text{ and } F(Q_1^{\text{sp}}) \subset (Q')^{\text{sp}}.$$

If moreover  $F(Q_1^{\text{ord}}) \subset (Q')^{\text{ord}}$ , we say that  $F$  is *strict*.

We will see later, that the polarizations are a, somehow redundant, way to codify the relations of a skewed-gentle algebra.

**Remark 2.2.** We observe that for a polarized quiver  $\underline{Q}$ , in the underlying quiver  $Q := (Q_0, Q_1, s, t)$  at each given vertex there start at most two arrows and there end at most two arrows. Let  $\varepsilon \in Q_1^{\text{sp}}$  and  $\varepsilon'$  the corresponding “dual” special arrow, then  $(\varepsilon')' = \varepsilon$ . Moreover we note that if a special arrow  $\varepsilon$  is a loop then  $\varepsilon = \varepsilon'$ . If  $\phi: \underline{Q} \rightarrow \underline{Q}'$  is a homomorphism of polarized quivers, and  $\alpha, \beta \in Q_1$  are two different arrows with  $s(\alpha) = s(\beta)$  or with  $t(\alpha) = t(\beta)$ , then  $\phi(\alpha) \neq \phi(\beta)$ . Thus, homomorphisms between polarized quivers automatically fulfill the property (W1) of a winding from [Kr91].

If  $\underline{Q}$  is skewed-gentle polarized quiver there is at each vertex  $i \in Q_o$  at most one special loop  $\varepsilon_i$ . It will be sometimes convenient to set

$$Q_0^{\text{sp}} := \{i \in Q_0 \mid \text{there is a special loops at } i\} \quad \text{and} \quad Q_0^{\text{ord}} := Q_0 \setminus Q_0^{\text{sp}}.$$

**2.2. Letters.** Associated to a polarized quiver  $\underline{Q}$  we have a set  $\mathcal{L} = \mathcal{L}(\underline{Q})$  of letters, which come in 5 types. We describe them in the Table 1. In particular, we extend the functions  $\underline{s}$  and  $\underline{t}$  from arrows to letters.

type	symbol	condition	$\underline{s}$	$\underline{t}$	inverse
ordinary	$\alpha$	$\alpha \in Q_1^{\text{ord}}$	$\underline{s}(\alpha)$	$\underline{t}(\alpha)$	$\alpha^{-1}$
inverse	$\alpha^{-1}$	$\alpha \in Q_1^{\text{ord}}$	$\underline{t}(\alpha)$	$\underline{s}(\alpha)$	$\alpha$
special	$\varepsilon^*$	$\varepsilon \in Q_1^{\text{sp}}$	$(s(\varepsilon), -1)$	$(t(\varepsilon), -1)$	$\varepsilon'^*$
trivial	$\mathbb{1}_{i,\rho}$	$(i, \rho) \in Q_0 \times \{-1, 1\} \setminus \{\underline{s}(\varepsilon) \mid \varepsilon \in Q_1^{\text{sp}}\}$	*	$(i, \rho)$	$\mathbb{1}_{i,\rho}^{-1}$
trivial inverse	$\mathbb{1}_{i,\rho}^{-1}$	$(i, \rho) \in Q_0 \times \{-1, 1\} \setminus \{\underline{s}(\varepsilon) \mid \varepsilon \in Q_1^{\text{sp}}\}$	$(i, \rho)$	*	$\mathbb{1}_{i,\rho}$

TABLE 1. Letters for a polarized quiver

We note that for each  $(i, \rho) \in Q_0 \times \{-1, 1\}$  the set

$$\mathcal{L}_{(i,\rho)}(\underline{Q}) := \{x \in \mathcal{L}(\underline{Q}) \mid \underline{t}(x) = (i, \rho)\}$$

consists either of a single special letter, or else it is, by definition, a linearly ordered set of one of the following forms:

$$\{\mathbb{1}_{i,\rho}\}, \{\alpha < \mathbb{1}_{i,\rho}\}, \{\mathbb{1}_{i,\rho} < \beta^{-1}\}, \{\alpha < \mathbb{1}_{i,\rho} < \beta^{-1}\}$$

for certain ordinary arrows  $\alpha, \beta \in Q_1^{\text{ord}}$ .

In particular, if  $\underline{Q}$  is a skewed-gentle polarized quiver and  $i \in Q_0^{\text{sp}}$ , then there is a unique special letter  $\varepsilon_i^*$  with  $\underline{s}(\varepsilon_i^*) = (i, -1) = \underline{t}(\varepsilon_i^*)$ , and there is only a trivial letter  $\mathbb{1}_{i,+1}$  but *no*  $\mathbb{1}_{i,-1}$ .

**2.3. Words.** A *word* for  $\underline{Q}$  is a sequence of letters  $\mathbf{w} = w_1 w_2 \cdots w_m$  with the  $w_i \in \mathcal{L}_{\underline{Q}}$  such that  $\underline{s}(w_i) = -\underline{t}(w_{i+1})$  for  $i = 1, 2, \dots, m-1$ . In this case we set

$$\begin{aligned} \mathbf{w}_{[k]} &:= w_1 w_2 \cdots w_k, & \underline{s}(\mathbf{w}) &:= \underline{s}(w_m), \\ \mathbf{w}^{[k]} &:= w_k w_{k+1} \cdots w_m, & \underline{t}(\mathbf{w}) &:= \underline{t}(w_1), \\ \mathbf{w}^{-1} &:= w_m^{-1} w_{m-1}^{-1} \cdots w_1^{-1}, & l(\mathbf{w}) &:= m. \end{aligned}$$

If  $\mathbf{v} = v_1 v_2 \cdots v_l$  is an other word with  $\underline{t}(\mathbf{v}) = -\underline{s}(\mathbf{w})$  we can form the concatenated word  $\mathbf{wv} = w_1 \cdots w_m v_1 \cdots v_l$ .

Finally,  $\mathbf{w}$  is *right inextensible* if  $w_m = \mathbb{1}_{i,\rho}$  for some  $(i, \rho) \in Q_0 \times \{-1, 1\}$ , and it is *left inextensible* if  $\mathbf{w}^{-1}$  is right inextensible.

**2.4. Lexicographic order.** The lexicographic order on all words, which is induced by the partial order on the letters, gives a poset with poor properties. For example, if  $\mathbf{v} = \mathbf{v}'\mathbf{v}''$  is a non-trivial factorization of a word  $\mathbf{v}$ , then  $\mathbf{v}'$  and  $\mathbf{v}$  are *not* comparable.

Note however, that two right inextensible words with comparable first letter are comparable under this lexicographical order. The same is true for two words of the same length: they are comparable if their respective first letters are comparable. In fact, if two words are comparable, say  $\mathbf{v} < \mathbf{w}$  then there exists a unique word  $\mathbf{v}'$  and comparable letters  $v < w$  such that  $\mathbf{v} = \mathbf{v}'v\mathbf{v}''$  and  $\mathbf{w} = \mathbf{v}'w\mathbf{w}''$ . In this case we write  $\Delta(\mathbf{v}, \mathbf{w}) = l(\mathbf{v}')$ . In

particular,  $v$  is an ordinary letter, or  $w$  is an inverse ordinary letter. In the first case  $w$  can be trivial or inverse, whilst in the second case  $v$  can be direct or trivial. Note, that the words  $\mathbf{v}''$  and  $\mathbf{w}''$  may be empty.

Similarly, if we have factorizations  $\mathbf{v} = \mathbf{v}'\mathbf{v}''$  and  $\mathbf{w} = \mathbf{w}'\mathbf{w}''$ , then  $\mathbf{v}' < \mathbf{w}'$  implies  $\mathbf{v} < \mathbf{w}$ .

**2.5. Strings and Bands.** A *string* for  $\underline{Q}$  is a word which is left- and right inextensible. Thus the first letter of a string is always a trivial inverse letter. We denote the set of strings for  $\underline{Q}$  by  $\text{St}(\underline{Q})$ , and  $\text{St}_{(i,\rho)}(\underline{Q})$  denotes the subset of strings which have as first letter  $\mathbb{1}_{i,\rho}^{-1}$ . This set is linearly ordered by the lexicographic order, see Section 2.4. A string  $\mathbf{w}$  is *symmetric* if  $\mathbf{w} = \mathbf{w}^{-1}$ . It is easy to see that in this case there exists a unique left inextensible word  $\mathbf{v}$  and a special letter  $\varepsilon^* = (\varepsilon^*)^{-1}$  such that  $\mathbf{w} = \mathbf{v}\varepsilon^*\mathbf{v}^{-1}$ .

A *band* is a word  $\mathbf{w}$  such that  $\mathbf{w}\mathbf{w}$  is also word. A band is *primitive* if there is no word  $\mathbf{v}$  such that  $\mathbf{w} = \mathbf{v}^n$  for some  $n \geq 2$ . If  $\mathbf{w}$  is a (primitive) band, then so are all its *rotations*  $\mathbf{w}^{[k+1]}\mathbf{w}_{[k]}$ . A primitive band is *symmetric* if  $\mathbf{w}^{-1} = \mathbf{w}^{[k+1]}\mathbf{w}_{[k]}$  for some  $k$ . This is the case if and only if some rotation of  $\mathbf{w}$  is of the form  $\varepsilon^*\mathbf{v}\zeta^*\mathbf{v}^{-1}$  for some word  $\mathbf{v}$  and special letters  $\varepsilon^*$  and  $\zeta^*$ . Note, that a special letter  $\varepsilon^*$  alone is not a symmetric band, since  $\varepsilon^*\varepsilon^*$  is not a word.

We denote by  $\text{pBa}(\underline{Q})$  resp.  $\text{Ba}(\underline{Q})$  the set of (primitive) bands for  $\underline{Q}$ . Two strings are *equivalent*, in symbols  $\mathbf{v} \sim \mathbf{w}$  if  $\mathbf{v} \in \{\mathbf{w}, \mathbf{w}^{-1}\}$ . Two bands are *equivalent*, in symbols  $\mathbf{v} \sim \mathbf{w}$  if  $\mathbf{v}^\rho = \mathbf{w}^{[k+1]}\mathbf{w}_{[k]}$  for some  $\rho \in \{-1, +1\}$  and  $k = 0, 1, \dots, l-1$ . We denote by  $\text{pBa}'_{\underline{Q}}$  the set of primitive bands in *standard form*. By definition,  $\text{pBa}' \subset \text{pBa}$  consists of all asymmetric primitive bands, and of the symmetric (primitive) bands, which are of the form  $\varepsilon^*\mathbf{v}\zeta^*\mathbf{v}^{-1}$ , as above.

Sometimes we will also consider the equivalence classes of (primitive) bands modulo rotations, which we will denote by  $[\text{pBa}(\underline{Q})]$  resp.  $[\text{Ba}(\underline{Q})]$ .

**2.6. Projective strings, injective strings, and the operator  $\tau_{\underline{Q}}$ .** Let  $\underline{Q}$  be a skewed-gentle polarized quiver. Then for each  $(i, \rho) \in Q_0 \times \{-1, 1\} \setminus \{\underline{g}(\varepsilon^*) \mid \varepsilon \in Q_1^{\text{sp}}\}$  the linearly ordered set  $\text{St}_{(i,\rho)}(\underline{Q})$  has a (unique) maximal element  $\mathbb{1}_{i,\rho}^{-1}\mathbf{w}_{i,\rho}^{\text{max}}$  and a minimal element  $\mathbb{1}_{i,\rho}^{-1}\mathbf{w}_{i,\rho}^{\text{min}}$ . For example,  $\mathbf{w}_{i,\rho}^{\text{min}}$  is the unique right inextensible word of maximal length, which contains no inverse letter, and with  $\underline{t}(\mathbf{w}_{i,\rho}^{\text{min}}) = (i, -\rho)$ . This allows to define the following projective, resp. injective strings:

$$\begin{aligned} \tilde{\mathbf{p}}_{i,\rho} &:= (\mathbf{w}_{i,-\rho}^{\text{max}})^{-1}\mathbf{w}_{i,\rho}^{\text{max}}, & \text{for } (i, \rho) \in Q_0^{\text{ord}} \times \{-1, 1\}, \\ \tilde{\mathbf{p}}_i &:= (\mathbf{w}_{i,1}^{\text{max}})^{-1}\varepsilon_i^*\mathbf{w}_{i,1}^{\text{max}} & \text{for } i \in Q_0^{\text{sp}}, \\ \tilde{\mathbf{q}}_{i,\rho} &:= \mathbf{w}_{i,-\rho}^{\text{min}}\mathbf{w}_{i,\rho}^{\text{min}} & \text{for } (i, \rho) \in Q_0^{\text{ord}} \times \{-1, 1\}, \\ \tilde{\mathbf{q}}_i &:= (\mathbf{w}_{i,1}^{\text{min}})^{-1}\varepsilon_i^*\mathbf{w}_{i,1}^{\text{min}} & \text{for } i \in Q_0^{\text{sp}}. \end{aligned}$$

We note that  $\tilde{\mathbf{p}}_{i,\rho}^{-1} = \tilde{\mathbf{p}}_{i,-\rho}$  and  $\tilde{\mathbf{q}}_{i,\rho}^{-1} = \tilde{\mathbf{q}}_{i,\rho}$ , whilst  $\tilde{\mathbf{p}}_i$  and  $\tilde{\mathbf{q}}_i$  for  $i \in Q_0^{\text{sp}}$  are symmetric strings.

Moreover, each string  $\mathbf{w} = \mathbb{1}_{i,\rho}^{-1}\mathbf{w}'\mathbb{1}_{j,\sigma}$  with  $\mathbf{w}' \neq \mathbf{w}_{i,\rho}^{\text{max}}$  has a unique successor  $\mathbf{w}[1]$ . More precisely, if there exists an inverse letter  $\alpha^{-1}$  with  $\underline{t}(\alpha^{-1}) = (j, \sigma)$ , then

$$\begin{aligned} \mathbf{w}[1] &= \mathbb{1}_{i,\rho}\mathbf{w}'\alpha^{-1}\mathbf{w}_{-\underline{g}(\alpha^{-1})}^{\text{min}}, & \text{otherwise} \\ \mathbf{w} &= \mathbb{1}_{i,\rho}(\mathbf{w}[1])'\beta\mathbf{w}_{-\underline{g}(\beta)}^{\text{max}} & \text{for some } \beta \in Q_1^{\text{ord}}. \end{aligned}$$

In the first case we say that  $\mathbf{w}[1]$  is obtained from  $\mathbf{w}$  by *adding a co-hook* on the right. In the second case we say that  $\mathbf{w}[1]$  is obtained from  $\mathbf{w}$  by *removing a hook* on the right.

This allows us to define a bijection

$$\tau_Q: \text{St}(\underline{Q}) \setminus \mathcal{P}(\underline{Q}) \rightarrow \text{St}(\underline{Q}) \setminus \mathcal{Q}(\underline{Q}),$$

$$\mathbf{w} \mapsto \begin{cases} [1](\mathbf{w}[1]) & \text{if } \mathbf{w} \neq \mathbf{w}_{i,\rho}^{\max} \text{ for some } (i, \rho) \in Q_o \times \{-1, +1\}, \\ ([1]\mathbf{w})[1] & \text{if } \mathbf{w}^{-1} \neq \mathbf{w}_{i,\rho}^{\max} \text{ for some } (i, \rho) \in Q_o \times \{-1, +1\}. \end{cases}$$

where we set

$$\begin{aligned} \mathcal{P}(\underline{Q}) &:= \{\tilde{\mathbf{p}}_{i,\rho} \mid (i, \rho) \in Q_0^{\text{ord}} \times \{-1, +1\}\} \cup \{\tilde{\mathbf{p}}_i \mid i \in Q_0^{\text{SP}}\}, \\ \mathcal{Q}(\underline{Q}) &:= \{\tilde{\mathbf{q}}_{i,\rho} \mid (i, \rho) \in Q_0^{\text{ord}} \times \{-1, +1\}\} \cup \{\tilde{\mathbf{q}}_i \mid i \in Q_0^{\text{SP}}\}, \\ [1]\mathbf{w} &:= (\mathbf{w}^{-1}[1])^{-1}. \end{aligned}$$

It is not hard to see that this is a well defined bijection. In particular  $([1]\mathbf{w})[1] = [1](\mathbf{w}[1])$  if neither  $\mathbf{w}$  nor  $\mathbf{w}^{-1}$  is of the form  $\mathbf{w}_{i,\rho}^{\max}$  for some  $(i, \rho) \in Q_o \times \{-1, +1\}$ .

We agree that for each band  $\mathbf{w} \in \text{pBa}(\underline{Q})$  we have  $\tau_Q(\mathbf{w}) = \mathbf{w}$ .

**2.7. Example.** In the following display, we show a skewed-gentle polarized quiver  $\underline{Q}$  with  $Q_1^{\text{SP}} = \{\varepsilon\}$  by indicating for each non-special arrow the values of the polarization close to the respective end of the arrow. Moreover, we display, as an example, the elements of the linearly ordered set  $\text{St}_{1,-}(\underline{Q})$  in descending order.

$\underline{Q} =$

$\text{St}_{1,-}(\underline{Q}) :$

$$\begin{aligned} \tilde{\mathbf{p}}_{1,-1} &= \mathbb{1}_{1,-}^{-1} \alpha^{-1} \varepsilon^* \beta^{-1} \gamma^{-1} \mathbb{1}_{1,-} \\ \tilde{\mathbf{q}}_{3,-1} &= \mathbb{1}_{1,-}^{-1} \alpha^{-1} \varepsilon^* \beta^{-1} \mathbb{1}_{3,+} \\ &\quad \mathbb{1}_{1,-}^{-1} \alpha^{-1} \varepsilon^* \mathbb{1}_{2,+} \\ \tilde{\mathbf{q}}_2 &= \mathbb{1}_{1,-}^{-1} \alpha^{-1} \varepsilon^* \alpha \mathbb{1}_{1,-} \\ \tilde{\mathbf{s}}_1 &= \mathbb{1}_{1,-}^{-1} \mathbb{1}_{1,+} \\ \tilde{\mathbf{p}}_{3,+1} &= \mathbb{1}_{1,-}^{-1} \gamma \mathbb{1}_{3,-} \\ \tilde{\mathbf{p}}_2 &= \mathbb{1}_{1,-}^{-1} \gamma \beta \varepsilon^* \beta^{-1} \gamma^{-1} \mathbb{1}_{1,-} \\ &\quad \mathbb{1}_{1,-}^{-1} \gamma \beta \varepsilon^* \beta^{-1} \mathbb{1}_{3,+} \\ &\quad \mathbb{1}_{1,-}^{-1} \gamma \beta \varepsilon^* \mathbb{1}_{2,+} \\ \tilde{\mathbf{p}}_{1,+1} &= \mathbb{1}_{1,-}^{-1} \gamma \beta \varepsilon^* \alpha \mathbb{1}_{1,-} \end{aligned}$$

Note, that  $\text{St}_{1,-}(\underline{Q})$  contains precisely two symmetric strings, and that  $\text{Ba}(\underline{Q}) = \emptyset$ .

### 3. ADMISSIBLE WORDS FOR $\underline{Q}$

**3.1. Orders within strings and bands.** Let  $\underline{Q}$  be a polarized quiver for which all special letters are loops. For a string  $\mathbf{w} = w_0 w_1 \cdots w_l \in \text{St}(\underline{Q})$  with  $w_k = \varepsilon_i^*$  a special letter we have  $\underline{t}(\mathbf{w}_{[k-1]}^{-1}) = \underline{t}(\mathbf{w}^{[k+1]}) = (i, +)$ . Since moreover the words  $\mathbf{w}_{[k-1]}$  and  $\mathbf{w}^{[k+1]}$  are right inextensible, they are comparable in the induced lexicographical order. We write then  $\Delta_{\mathbf{w}}(k) := \Delta(\mathbf{w}_{[k-1]}^{-1}, \mathbf{w}^{[k+1]})$ , see Section 2.4. In this situation  $\mathbf{w}_{[k-1]}^{-1} = \mathbf{w}^{[k+1]}$  occurs if and only if  $\mathbf{w}$  is a symmetric string and  $\mathbf{w} = \mathbf{w}_{[k-1]} \varepsilon_j^* \mathbf{w}_{[k-1]}^{-1}$ .

Similarly, for a primitive band  $\mathbf{w} = w_0 w_1 \cdots w_l \in \text{pBa}$  with  $w_k = \varepsilon_i^*$  a special letter,  $\mathbf{w}_{[k-1]}^{-1} (\mathbf{w}^{[k+1]})^{-1} = (\mathbf{w}^{[k+1]} \mathbf{w}_{[k-1]})^{-1}$  and  $\mathbf{w}^{[k+1]} \mathbf{w}_{[k+1]}$  are comparable because then  $\underline{t}(\mathbf{w}^{[k+1]} \mathbf{w}_{[k-1]}) = \underline{t}(\mathbf{w}_{[k-1]}^{-1} (\mathbf{w}^{[k+1]})^{-1}) = (i, +)$  and both words have the same length  $l$ . We write then also  $\Delta_{\mathbf{w}}(k) := \Delta(\mathbf{w}^{[k+1]} \mathbf{w}_{[k-1]}, \mathbf{w}_{[k-1]}^{-1} (\mathbf{w}^{[k+1]})^{-1})$ . Note that in this situation  $\mathbf{w}_{[k-1]}^{-1} (\mathbf{w}^{[k+1]})^{-1} = \mathbf{w}_{[k+1]} \mathbf{w}^{[k-1]}$  implies that  $\mathbf{w}_{[k+1]} \mathbf{w}^{[k-1]} = \mathbf{x} \varepsilon_j^* \mathbf{x}^{-1}$  for a unique word  $\mathbf{x}$  and a special letter  $\varepsilon_j^*$ . Thus  $\mathbf{w}$  is a symmetric band.

3.2.  **$\widehat{Q}$  and construction of  $A(\mathbf{w})$  for strings and bands.** Following [Ge99, Sec. 3.2], the *associated gentle polarized quiver*  $\widehat{Q} = (\widehat{Q}_0, \widehat{Q}_1, \underline{s}, \underline{t})$  of a skewed-gentle polarized quiver  $\underline{Q}$  is obtained by taking  $\widehat{Q}_0 = Q_0$ ,  $\widehat{Q}_1^{\text{ord}} = Q_1^{\text{ord}} \cup Q_1^{\text{sp}}$ ,  $\widehat{Q}_1^{\text{sp}} = \emptyset$  and otherwise the same functions  $\underline{s}, \underline{t}$ . Thus we have a morphism

$$F: \widehat{Q} \rightarrow \underline{Q}$$

of polarized quivers, which is bijective on vertices and arrows. We will apply to  $\widehat{Q}$  our construction from Section 2.2 to  $\widehat{Q}$ . In particular we have now for each special arrow  $\varepsilon_i \in Q_1^{\text{sp}}$  a linearly ordered set

$$\mathcal{L}_{(i,-1)}(\widehat{Q}) = \{\varepsilon_i \prec \mathbb{1}_{i,-1} \prec \varepsilon_i^{-1}\}$$

of letters. We can extend  $F$  to a surjective morphism between the corresponding sets of words, which is compatible with the concatenation of words. In particular  $F^{-1}(\varepsilon_i^*) = \mathcal{L}_{(i,-1)}(\widehat{Q})$  for each special letter  $\varepsilon_i^*$  and  $F^{-1}(l) = \{l\}$  for each letter  $l$  which is not special. Following [QZ17, Sec. 2.3] we call the trivial letters for  $\widehat{Q}$  which are of the form  $\mathbb{1}_{i,-1}^{\pm 1}$  with  $i \in Q_0^{\text{sp}}$  *punctured letters*. We say that a string  $\mathbf{x} = x_0 x_1 \cdots x_l \in \text{St}(\widehat{Q})$  is of *type*  $(a, b) \in \{u, p\}^2$ , with  $a = p$  if and only if  $x_0$  is punctured and  $b = p$  if and only if  $x_l$  is punctured. Similarly, we say that the elements of  $\text{pBa}(\widehat{Q})$  are of *type*  $(b)$ .

Note that we use the symbol  $\prec$  for the partial order on the letters for  $\widehat{Q}$  as well as on the induced lexicographic order on the corresponding words, rather than the symbol  $\leq$  which we reserve for the strings and bands of  $\underline{Q}$ .

We construct now, closely inspired by [CrB89b, Sec. 3], for each  $\mathbf{w} \in \text{St}(\underline{Q}) \cup \text{pBa}'(\underline{Q})$  an element  $A(\mathbf{w}) \in \text{St}(\widehat{Q}) \cup \text{pBa}(\widehat{Q})$ .

For  $\mathbf{w} = w_0 w_1 \cdots w_n$  an **asymmetric string**,  $A(w) := a_0 a_1 \cdots a_n$  with  $a_i = w_i$  whenever  $w_i$  is not a special letter. If however  $w_i = \varepsilon^*$  is a special letter, then  $a_i = \varepsilon$  if  $(\mathbf{w}_{[i-1]})^{-1} > \mathbf{w}^{[i+1]}$ , and  $a_i = \varepsilon^{-1}$  if  $(\mathbf{w}_{[i-1]})^{-1} < \mathbf{w}^{[i+1]}$ .

For  $\mathbf{w} = v_0 v_1 \cdots v_{m-1} \varepsilon_b^* v_{m-1}^{-1} \cdots v_0^{-1}$  with  $b \in Q_0^{\text{sp}}$ , a **symmetric string**,  $A(\mathbf{w}) = a_0 a_1 \cdots a_{m-1} \mathbb{1}_{b,-1}$  with  $a_i = w_i$  if  $w_i$  is not a special letter. If, however  $w_i = \varepsilon^*$  is a special letter, then  $a_i = \varepsilon$  if  $(\mathbf{w}_{[i-1]})^{-1} > \mathbf{w}^{[i+1]}$ , and  $a_i = \varepsilon^{-1}$  if  $(\mathbf{w}_{[i-1]})^{-1} < \mathbf{w}^{[i+1]}$ .

For  $\mathbf{w} = w_0 w_1 \cdots w_n$  an **asymmetric band**,  $A(\mathbf{w}) = a_0 a_1 \cdots a_n$  with  $a_i = w_i$  if  $w_i$  is not a special letter. If, however  $w_i = \varepsilon^*$  is a special letter, then  $a_i := \varepsilon$  if  $\mathbf{w}_{[i-1]}^{-1} (\mathbf{w}^{[i-1]})^{-1} > \mathbf{w}^{[i+1]} \mathbf{w}_{[i-1]}$  and  $a_i := \varepsilon^{-1}$  if  $\mathbf{w}_{[i-1]}^{-1} (\mathbf{w}^{[i-1]})^{-1} < \mathbf{w}^{[i+1]} \mathbf{w}_{[i-1]}$ .

For  $\mathbf{w} = \varepsilon_a^* v_1 v_2 \cdots v_{n-1} \varepsilon_b^* v_{n-1}^{-1} \cdots v_1^{-1}$  a **symmetric band** in standard form,  $A(\mathbf{w}) = \mathbb{1}_{a,-1}^{-1} a_1 a_2 \cdots a_{n-1} \mathbb{1}_{b,-1}$  with  $a_i = v_i$  if  $v_i$  is not a special letter. Else, for  $v_i = \varepsilon^*$  special, we set  $a_i = \varepsilon$  if  $\mathbf{w}_{[i-1]}^{-1} (\mathbf{w}^{[i+1]})^{-1} > \mathbf{w}^{[i+1]} \mathbf{w}_{[i-1]}$  and  $a_i = \varepsilon^{-1}$  if  $\mathbf{w}_{[i-1]}^{-1} (\mathbf{w}^{[i+1]})^{-1} < \mathbf{w}^{[i+1]} \mathbf{w}_{[i-1]}$ .

3.3. **Admissible words vs. strings and bands.** Let  $\underline{Q}$  be a skewed-gentle polarized quiver, and  $\widehat{Q}$  the associated gentle polarized quiver from Section 3.2. We recall that  $F: \widehat{Q} \rightarrow \underline{Q}$  induces a surjective map between the respective sets of words, which we also denote by  $F$ . However,  $F$  does not restrict directly to a map between the respective sets of strings and (primitive) bands. For example, for  $i \in Q_0^{\text{sp}}$  we have  $\mathbb{1}_{i,-1}^{-1} \mathbb{1}_{i,+} \in \text{St}(\widehat{Q})$ , however  $F(\mathbb{1}_{i,-1}^{-1} \mathbb{1}_{i,+}) = \varepsilon_i^* \mathbb{1}_{i,+} \notin \text{St}(\underline{Q})$ .



Thus we define the completion  $\bar{?}: \text{St}(\widehat{Q}) \cup \text{Ba}(\widehat{Q}) \rightarrow \text{St}(Q) \cup \text{Ba}(Q)$  by

$$(3.1) \quad \mathbf{x} = x_0 x_1 \cdots x_l \mapsto \begin{cases} F(\mathbf{x}) & \text{if } \mathbf{x} \in \text{St}(\widehat{Q}) \text{ is of type } (u, u), \\ F(\mathbf{x})F(x_{l-1}^{-1} \cdots x_1^{-1} x_0^{-1}) & \text{if } \mathbf{x} \in \text{St}(\widehat{Q}) \text{ is of type } (u, p), \\ F(x_l^{-1} \cdots x_2^{-1} x_1^{-1})F(\mathbf{x}) & \text{if } \mathbf{x} \in \text{St}(\widehat{Q}) \text{ is of type } (p, u), \\ F(\mathbf{x})F(x_{l-1}^{-1} \cdots x_2^{-1} x_1^{-1}) & \text{if } \mathbf{x} \in \text{St}(\widehat{Q}) \text{ is of type } (p, p), \\ F(\mathbf{x}) & \text{if } \mathbf{x} \in \text{Ba}(\widehat{Q}). \end{cases}$$

In the first three cases  $\bar{\mathbf{x}} \in \text{St}(Q)$ , whilst  $\bar{\mathbf{x}} \in \text{Ba}(Q)$  in the last two cases. Note, that for a primitive band  $\mathbf{x} \in \text{pBa}(\widehat{Q})$  possibly  $\bar{\mathbf{x}} \in \text{Ba}(Q)$  is not primitive.

Following Qiu and Zhou [QZ17, Sec. 2.5] a string  $\mathbf{x} = x_0 x_1 \cdots x_n$  for  $\widehat{Q}$  is *admissible* (with respect to  $F$ ) if it fulfills the following two conditions:

- For any  $k \in \{1, 2, \dots, n-1\}$  with  $F(x_k) \in Q_1^{\text{sp}}$  we have  $\mathbf{x}_{[k-1]}^{-1} \neq \mathbf{x}^{[k]}$  and in this situation  $x_k$  is direct if and only if  $\mathbf{x}_{[k-1]}^{-1} \succ \mathbf{x}^{[k+1]}$ .
- If  $\mathbf{x}$  is of type  $(p, p)$  then  $\bar{\mathbf{x}}$  is a primitive band.

Observe that a string  $\mathbf{x}$  is admissible if and only if  $\mathbf{x}^{-1}$  is admissible.

Similarly, we say that a band  $\mathbf{x} = x_0 x_1 \cdots x_n$  for  $\widehat{Q}$  is *admissible* (with respect to  $F$ ), if the following two conditions are fulfilled:

- For any  $k \in \{1, 2, \dots, n\}$  with  $F(x_k) \in Q_1^{\text{sp}}$  we have  $(\mathbf{x}^{[k-1]})^{-1} \mathbf{x}_{[k-1]}^{-1} \neq \mathbf{x}^{[k+1]} \mathbf{x}_{[k-1]}$ , and in this situation  $x_k$  is direct if and only if  $(\mathbf{x}^{[k-1]})^{-1} \mathbf{x}_{[k-1]}^{-1} \succ \mathbf{x}^{[k+1]} \mathbf{x}_{[k-1]}$ ,
- $F(\mathbf{x})$  is a primitive asymmetric band for  $Q$ .

**Proposition 3.1.** *Let  $Q$  be a skewed-gentle polarized quiver and  $F: \widehat{Q} \rightarrow Q$  the canonical morphism starting in the corresponding gentle polarized quiver  $\widehat{Q}$ . Then  $\mathbf{x} \in \text{St}(\widehat{Q}) \cup \text{pBa}(\widehat{Q})$  is admissible if and only if  $\mathbf{x} = A(\mathbf{w})^{\pm 1}$  for some  $\mathbf{w} \in \text{St}(Q) \cup \text{pBa}'(Q)$ .*

*In particular, all the  $A(\mathbf{w})$  are admissible strings or bands, and we have obviously  $\overline{A(\mathbf{w})} = \mathbf{w}$ .*

We will prove Proposition 3.1 in Appendix B. As mentioned in the Introduction, a similar result can be found in the recent PhD thesis of U. Hansper [Ha22]

**Definition 3.2.** Let us denote by  $\text{AdmSt}(Q) \subset \text{St}(\widehat{Q})$  resp.  $\text{AdmBa}(Q) \subset \text{pBa}(\widehat{Q})$  the set of strings and bands for  $\widehat{Q}$  which are admissible with respect to  $F$ , and abbreviate  $\text{Adm}(Q) := \text{AdmSt}(Q) \cup \text{AdmBa}(Q)$ . It is clear that  $\text{AdmBa}(Q)$  is stable under rotations, see 2.5 for the definition. Thus we may consider the equivalence classes  $[\text{AdmBa}(Q)]$  of  $\text{AdmBa}(Q)$  under rotations. We will use frequently the following abbreviations:

$$\begin{aligned} \text{Adm}_s(Q) &:= \{\mathbf{x} \in \text{AdmSt}(Q) \mid \mathbf{x} \text{ is not of type } (p, p)\}, \\ [\text{Adm}_b(Q)] &:= \{\mathbf{x} \in \text{AdmSt}(Q) \mid \mathbf{x} \text{ is of type } (p, p)\} \cup [\text{AdmBa}(Q)]. \end{aligned}$$

Thus  $\bar{?}$  induces a map

$$(\bar{?})_s: \text{Adm}_s(Q) \rightarrow \text{St}(Q), \mathbf{x} \mapsto \bar{\mathbf{x}}.$$

By Proposition 3.1, this map is surjective and  $(\bar{\mathbf{x}})_s = (\bar{\mathbf{y}})_s$  implies either  $\mathbf{x} = \mathbf{y}$ , or else  $\mathbf{x} = \mathbf{y}^{-1}$  maps to a symmetric string. Similarly,  $\bar{?}$  induces a map

$$[\bar{?}]: [\text{Adm}_b(Q)] \rightarrow [\text{pBa}(Q)],$$

which is also surjective. Moreover  $[\bar{\mathbf{x}}] = [\bar{\mathbf{y}}]$  implies  $\mathbf{x} = \mathbf{y}$ , or  $\mathbf{x} = \mathbf{y}^{-1}$  maps to a symmetric band in  $\text{pBa}'(Q)$ , again by Proposition 3.1. The situation may be visualized as follows:

$$\begin{array}{ccc}
\text{St}(\widehat{Q}) \supset \text{AdmSt}(\underline{Q}) & \left. \begin{array}{l} (u, u) \\ (u, p) \\ (p, u) \\ (p, p) \end{array} \right\} & \text{Adm}_s(\underline{Q}) \xrightarrow{\bar{?}} \text{St}(\underline{Q}) \\
\text{pBa}(\widehat{Q}) \supset \text{AdmBa}(\underline{Q}) & & \text{Adm}_b(\underline{Q}) \xrightarrow{\bar{?}} \text{pBa}'(\underline{Q}) \\
& & \text{Adm}(\underline{Q})
\end{array}$$

**3.4. AR-translate for admissible words.** We say that  $\mathbf{x} \in \text{Adm}(\underline{Q})$  is *projective* resp. *injective* if  $\mathbf{x}^{\pm 1} = A(\mathbf{p})$  for some  $\mathbf{p} \in \mathcal{P}(\underline{Q})$  resp.  $\mathbf{x}^{\pm 1} = A(\mathbf{q})$  for some  $\mathbf{q} \in \mathcal{Q}(\underline{Q})$ , with the notion of projective resp. injective strings from Section 2.6.

In view of Proposition 3.1 it makes sense to define also for  $\mathbf{x} \in \text{Adm}(\underline{Q})$  non-projective the operator  $\tau_{\underline{Q}}$  as follows:

$$\tau_{\underline{Q}}(\mathbf{x}) := \begin{cases} A(\tau_{\underline{Q}}(\mathbf{w})) & \text{if } \mathbf{x} = A(\mathbf{w}) \text{ for some } \mathbf{w} \in \text{St}(\underline{Q}) \cup \text{pBa}'(\underline{Q}), \\ A(\tau_{\underline{Q}}(\mathbf{w}))^{-1} & \text{if } \mathbf{x} = A(\mathbf{w})^{-1} \text{ for some } \mathbf{w} \in \text{St}(\underline{Q}), \end{cases}$$

where we used the AR-operator  $\tau_{\underline{Q}}$  from Section 2.6.

**Remark 3.3.** This is well defined, since the map  $A: \text{St}(\underline{Q}) \cup \text{pBa}'(\underline{Q}) \rightarrow \text{Adm}(\underline{Q})$  is by construction injective. Note that if  $\mathbf{x} \in \text{Adm}(\underline{Q})$  is a *string* of type  $(p, p)$ , we have  $\tau_{\underline{Q}}(\mathbf{x}) = \mathbf{x}$ . If  $\mathbf{x}$  is a string of type  $(a, b) \in \{u, p\}^2$  then  $\tau_{\underline{Q}}(\mathbf{x})$  is also of type  $(a, b)$ . Note also, that if  $\mathbf{x} \in \text{Adm}(\underline{Q})$  is not projective and of type  $(p, u)$ , we have  $\tau_{\underline{Q}}(\mathbf{x}) = \mathbf{x}[1]$  and similarly  $\tau_{\underline{Q}}(\mathbf{x}) = [1]\mathbf{x}$  if  $\mathbf{x}$  is of type  $(u, p)$ ; If  $\mathbf{x} \in \text{Adm}(\underline{Q})$  is non-projective of type  $(u, u)$ , at least one of  $([1]\mathbf{x})[1]$  and  $[1](\mathbf{x})[1]$  is defined, and accordingly  $\tau_{\underline{Q}}(\mathbf{x}) = ([1]\mathbf{x})[1]$  or  $\tau_{\underline{Q}}(\mathbf{x}) = [1](\mathbf{x}[1])$ . In all these cases, the operator  $?[1]$  corresponds to taking the successor in the corresponding linearly ordered set  $\text{St}_{i,\rho}(\widehat{Q})$ .

**3.5. Reading admissible strings and bands.** For the combinatorial description of homomorphisms between representations of skewed-gentle algebras we need the following, slightly unwieldy, definitions. For  $\mathbf{x} = x_0x_1 \cdots x_l \in \text{Adm}(\underline{Q})$  we set

$$\bar{\bar{\mathbf{x}}} := \begin{cases} \bar{\mathbf{x}} & \text{if } \mathbf{x} \in \text{Adm}_s(\underline{Q}), \\ \cdots \bar{\bar{\mathbf{x}}}\bar{\bar{\mathbf{x}}}\cdots & \text{else.} \end{cases}$$

Here we agree, that we have  $\bar{\bar{\mathbf{x}}}_i = F(x_i)$  for  $i = 0, 1, \dots, l$ . For example, if  $\mathbf{x}$  is a string of type  $(p, u)$ , we have  $\bar{\bar{\mathbf{x}}} = v_{-l}v_{-l+1} \cdots v_l$  with  $v_{-i} = F(w_i)^{-1}$  and  $v_i = F(x_i)$  for  $i = 1, 2, \dots, l$  and  $v_0 = \varepsilon_p^*$  for some  $p \in Q_0^{\text{sp}}$ . Next, for  $(i, \rho) \in \{1, \dots, l\} \times \{-1, +1\}$  we set

$$\bar{\bar{\mathbf{x}}}(i, \rho) := \begin{cases} \bar{\bar{\mathbf{x}}}^{[i]} & \text{if } t_1(\bar{\bar{\mathbf{x}}}_i) = \rho, \\ \bar{\bar{\mathbf{x}}}_{[i-1]}^{-1} & \text{if } t_1(\bar{\bar{\mathbf{x}}}_i) = -\rho. \end{cases}$$

We will need also  $\bar{\bar{\mathbf{w}}}(0, \rho)$  in case  $\mathbf{w} \in \text{pBa}(\widehat{Q})$ , which is then defined correspondingly.

Similarly, we define for  $\delta \in \{-, +\}$  and  $\mathbf{x} = x_0x_1 \cdots x_l \in \text{Adm}(\underline{Q})$  the, possibly infinite, words

$$\widehat{\mathbf{x}}^\delta := \begin{cases} \mathbf{x} & \text{if } \mathbf{x} \text{ is of type } (u, u), \\ \mathbf{x}' \varepsilon_{t(x_l)}^{\delta 1} (\mathbf{x}')^{-1} & \text{if } \mathbf{x} \text{ is of type } (u, p), \\ (\mathbf{x}')^{-1} \varepsilon_{s(x_0)}^{\delta 1} \mathbf{x}' & \text{if } \mathbf{x} \text{ is of type } (p, u), \\ \cdots (\mathbf{x}')^{-1} \varepsilon_{s(x_0)}^{\delta 1} \mathbf{x}' \varepsilon_{t(x_l)}^{\delta 1} (\mathbf{x}')^{-1} \cdots & \text{if } \mathbf{x} \text{ is of type } (p, p), \\ \cdots \mathbf{xxx} \cdots & \text{if } \mathbf{x} \text{ is of type } (b) \end{cases}$$

where  $\mathbf{x}'$  is obtained from  $\mathbf{x}$  by removing the punctured letters. Again, we agree that  $\widehat{\mathbf{x}}_i^\delta = x_i$  for  $i = 1, 2, \dots, l-1$ . Next, for  $(i, \rho) \in \{1, \dots, l\} \times \{-1, +1\}$  we set

$$\widehat{\mathbf{x}}^\delta(i, \rho) := \begin{cases} (\widehat{\mathbf{x}}^\delta)^{[i]} & \text{if } t_1(\widehat{\mathbf{x}}_i^\delta) = \rho, \\ (\widehat{\mathbf{x}}_{[i-1]}^\delta)^{-1} & \text{if } t_1(\widehat{\mathbf{x}}_i^\delta) = -\rho. \end{cases}$$

We will need also  $\widehat{\mathbf{x}}^\delta(0, \rho)$  in case  $\mathbf{x} \in \text{pBa}(\widehat{Q})$ , which is then defined correspondingly. We observe, that we have trivially

$$(3.2) \quad \widehat{\mathbf{x}}^+(i, \rho) \prec \widehat{\mathbf{x}}^-(i, \rho),$$

whenever this is defined.

#### 4. QUIVERS FOR MODULES AND HOMOMORPHISMS

**4.1. Quivers for admissible words.** Let from now on  $\underline{Q}$  be a skewed-gentle quiver. Thus, in particular all special arrows are loops. Following closely [CrB89b, Sec. 3] we construct for each admissible  $\mathbf{x} \in \text{Adm}(\underline{Q})$  a morphism

$$G_{\mathbf{x}}: \underline{H}(\mathbf{x}) \rightarrow \underline{Q}.$$

polarized quivers. Recall, that the elements of  $\text{Adm}(\underline{Q})$  are precisely those strings or bands for the associated gentle quiver  $\widehat{Q}$  which are of the form  $A(\mathbf{w})^{\pm 1}$  for  $\mathbf{w} \in \text{St}(\underline{Q}) \cup \text{pBa}(\underline{Q})$ , see Proposition 3.1.

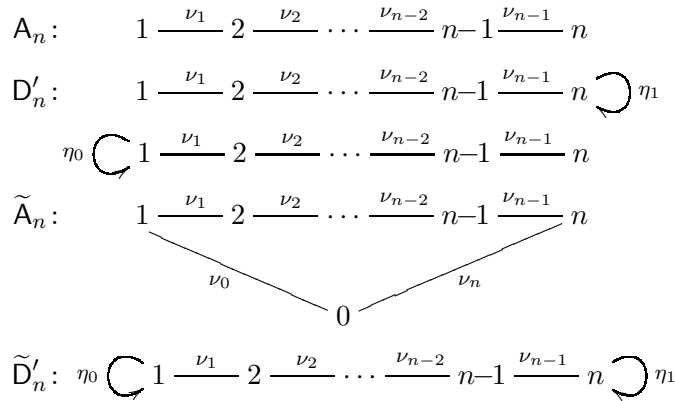

TABLE 2. Underlying graphs of the quivers  $\underline{H}(\mathbf{x})$

We consider first the case when  $\mathbf{x} = x_0x_1 \cdots x_n$  is a string (for  $\widehat{Q}$ ). Then the underlying graph of  $H(\mathbf{x})$  is a subgraph of the diagram  $\widetilde{D}'_n$  from Table 2. If  $x_0$  is unpunctured, we remove the loop  $\eta_0$ , else  $G(\eta_0) = \varepsilon_{s(x_0)}^*$ . Similarly, if  $x_n$  is unpunctured, the loop  $\eta_1$  is removed and else  $G_{\mathbf{x}}(\eta_1) = \varepsilon_{t(x_n)}^*$ . For  $i = 1, 2, \dots, n-1$  the edge  $\nu_i$  is oriented to the left

if and only if  $w_i$  is a direct letter and we set  $G_{\mathbf{x}}(\nu_i) = x_i$ . Else,  $\nu_i$  is oriented to the right and we set  $G_{\mathbf{x}}(\nu_i) = x_i^{-1}$ . Finally  $G_{\mathbf{x}}(i) := t(x_i)$  for  $i = 1, 2, \dots, n$ .

If  $\mathbf{x} = x_0 x_1 \cdots x_n$  is a band for  $\widehat{Q}$ , the underlying graph of  $H(\mathbf{x})$  is of type  $\widetilde{A}_n$  from Table 2. In this case all letters of  $\mathbf{x}$  are direct or inverse ordinary letters. For  $i = 0, 1, \dots, n$  we orient  $\nu_i$  anti-clockwise if  $x_i$  is a direct letter and set  $G_{\mathbf{x}}(\nu_i) = x_i$ . Else,  $\nu_i$  is oriented clockwise and we set  $G_{\mathbf{x}}(\nu_i) = x_i^{-1}$ . As for the vertices, we set  $G_{\mathbf{x}}(i) := t(x_i)$  for  $i = 0, 1, \dots, n$ .

We can upgrade  $H(\mathbf{x})$  to a polarized quiver  $\underline{H}(\mathbf{x})$  by declaring the loops to be the only special arrows, and taking  $s_1(\alpha) = s_1(G_{\mathbf{x}}(\alpha))$  as well as  $t_1(\alpha) = t_1(G(\alpha))$  for all arrows  $\alpha \in H_1(\mathbf{x})$ .

By definition, the *boundary vertices* of  $\underline{H}(\mathbf{x})$  are precisely the vertices of valency 1.

**4.2. The quiver  $H_Q(\mathbf{x}, \mathbf{y})$ .** To each pair of elements  $\mathbf{x}, \mathbf{y} \in \text{Adm}(Q)$  we construct, starting from  $G_{\mathbf{x}}: \underline{H}(\mathbf{x}) \rightarrow Q$  and  $G_{\mathbf{y}}: \underline{H}(\mathbf{y}) \rightarrow Q$  a decorated quiver  $H_Q(\mathbf{x}, \mathbf{y})$  with *three* kinds of arrows. It is closely related to the construction of  $H^{\mathbf{y}, \mathbf{x}}$  in [Ge99, Sec. 3.3].

$$\begin{aligned} H_0(\mathbf{x}, \mathbf{y}) &:= \{(j, i) \in H(\mathbf{y}) \times H(\mathbf{x}) \mid G_{\mathbf{y}}(j) = G_{\mathbf{x}}(i)\}, \\ H_{1,+}(\mathbf{x}, \mathbf{y}) &:= \{(\nu, \mu)_+ \in H_1^{\text{ord}}(\mathbf{y}) \times H_1^{\text{ord}}(\mathbf{x}) \cup H_1^{\text{sp}}(\mathbf{y}) \times H_1^{\text{sp}}(\mathbf{x}) \mid G_{\mathbf{y}}(\nu) = G_{\mathbf{x}}(\mu)\}, \\ H_{1,\times}(\mathbf{x}, \mathbf{y}) &:= \{(\nu, \mu)_{\times} \in H_1^{\text{ord}}(\mathbf{y}) \times H_1^{\text{ord}}(\mathbf{x}) \mid G_{\mathbf{y}}(\nu) = G_{\mathbf{x}}(\mu) \in Q_1^{\text{sp}}\}, \\ H_{1,o}(\mathbf{x}, \mathbf{y}) &:= \{(\nu, \eta)_{\ominus} \in H_1^{\text{ord}}(\mathbf{y}) \times H_1^{\text{sp}}(\mathbf{x}) \mid G_{\mathbf{y}}(\nu) = G_{\mathbf{x}}(\eta)\} \\ &\quad \cup \{(\eta, \mu)_{\oplus} \in H_1^{\text{sp}}(\mathbf{y}) \times H_1^{\text{ord}}(\mathbf{x}) \mid G_{\mathbf{y}}(\eta) = G_{\mathbf{x}}(\mu)\}, \\ H_1(\mathbf{x}, \mathbf{y}) &:= H_{1,+} \cup H_{1,\times} \cup H_{1,o}, \end{aligned}$$

with start- and endpoints of the arrows given by

$$\begin{aligned} s(\nu, \mu)_+ &= (s(\nu), s(\mu)), & t(\nu, \mu)_+ &= (t(\nu), t(\mu)), \\ s(\nu, \mu)_{\times} &= (t(\nu), s(\mu)), & t(\nu, \mu)_{\times} &= (s(\nu), t(\mu)), \\ s(\nu, \eta)_{\ominus} &= (t(\nu), s(\eta)), & t(\nu, \eta)_{\ominus} &= (s(\nu), t(\eta)), \\ s(\eta, \mu)_{\oplus} &= (s(\eta), s(\mu)), & t(\eta, \mu)_{\oplus} &= (t(\eta), t(\mu)). \end{aligned}$$

Finally, we highlight certain vertices of  $H(\mathbf{x}, \mathbf{y})$  by one of the following colors: red, orange and purple. For the red vertices we use the notation from Section 3.5.

$$\begin{aligned} H_0^{\text{red}} &:= \{(j, i) \in H_0(\mathbf{x}, \mathbf{y}) \mid \overline{\mathbf{y}}(j, \rho) > \overline{\mathbf{x}}(i, \rho) \text{ and } \Delta(\overline{\mathbf{y}}(j, \rho), \overline{\mathbf{x}}(i, \rho)) = 0 \\ &\quad \text{for some } \rho \in \{-1, 1\}\}, \\ H_0^{\text{ora}} &:= \{t(\nu, \mu)_{\times} \mid (\nu, \mu)_{\times} \in H_{1,\times}(\mathbf{x}, \mathbf{y})\}, \\ H_0^{\text{pur}} &:= \{t(\nu, \mu)_{*} \mid (\nu, \mu)_{*} \in H_{1,o}(\mathbf{x}, \mathbf{y})\}. \end{aligned}$$

Note, that a red vertex can receive also an orange label, or a purple label. It can even receive a second red label, if it is an isolated vertex. However, an orange and a purple label never occur at the same vertex.

For  $(j, i) \in H_0(\mathbf{x}, \mathbf{y})$  we define  $\text{val}(j, i)$  to be the number of arrows in  $H(j, i)$  which are incident with  $(j, i)$ . Moreover, we say that  $(j, i)$  is a *boundary point* of  $H(\mathbf{x}, \mathbf{y})$  is  $j$  is a boundary point of  $H(\mathbf{y})$  or  $i$  is a boundary point of  $H(\mathbf{x})$  in the sense of the end of Section 4.1. See Section 4.6 for an example.

**Remark 4.1.** We observe that for each  $(j, i) \in H_0(\mathbf{x}, \mathbf{y})$  we have  $\text{val}(j, i) \leq 2$ .

It follows from the definitions, that for  $(j, i) \in H_0(\mathbf{x}, \mathbf{y})$  and  $\rho \in \{-1, +1\}$  the right inextensible (or right periodic) words  $\bar{v}(i, \rho)$  and  $\bar{w}(j, \rho)$  are comparable.

Finally we observe, that  $(j, i) \in H_0^{\text{red}}(\mathbf{x}, \mathbf{y})$  implies  $\text{val}(j, i) \leq 1$ .

**4.3. h-lines and kisses.** For  $\mathbf{x}, \mathbf{y} \in \text{Adm}(\underline{Q})$  we look at the connected components of the quiver  $H_{\underline{Q}}(\mathbf{x}, \mathbf{y})$  from the previous section.

**Definition 4.2.** A connected component of the quiver  $H_{\underline{Q}}^+ := (H_0(\mathbf{x}, \mathbf{y}), H_{1,+}(\mathbf{x}, \mathbf{y}))$ , which contains no red, orange or purple vertex, is a *real h-line*. We write  $\mathcal{R}_{\underline{Q}}(\mathbf{x}, \mathbf{y})$  for the set of real h-lines of  $H_{\underline{Q}}(\mathbf{x}, \mathbf{y})$ .

A connected component of the quiver  $H_{\underline{Q}}^+(\mathbf{x}, \mathbf{y})$ , such that its connected component in  $(H_0(\mathbf{x}, \mathbf{y}), H_{1,+}(\mathbf{x}, \mathbf{y}) \cup H_{1,o}(\mathbf{x}, \mathbf{y}))$  contains no red or orange vertex, is a *h-line*.

A connected component of the quiver  $H_{\underline{Q}}(\mathbf{x}, \mathbf{y})$ , which contains no red vertex, is a *long h-line*. We write  $\mathcal{H}_{\underline{Q}}(\mathbf{x}, \mathbf{y})$  for the set of long h-lines in  $H_{\underline{Q}}(\mathbf{x}, \mathbf{y})$ .

A real h-line  $L \in \mathcal{R}_{\underline{Q}}(\mathbf{x}, \mathbf{y})$ , is a *kiss* if none of its (at most 2) endpoints is a boundary point of  $H_{\underline{Q}}(\mathbf{x}, \mathbf{y})$ .

**Remark 4.3.** (1) Let  $\mathbf{x}, \mathbf{y} \in \text{Adm}(\underline{Q})$  and suppose that for  $(j, i) \in H_0(\mathbf{y}) \times H_0(\mathbf{x})$  we have

$$\bar{y}(j, \rho) = \bar{x}(i, \rho) \text{ for both } \rho \in \{-1, +1\},$$

then it is easy to see that we have necessarily  $\mathbf{x} \sim \mathbf{y}$  and  $(j, i)$  lies on a component  $L$  of  $H(\mathbf{x}, \mathbf{y})$ , whose underlying quiver is isomorphic to the one of  $H(\mathbf{x}) \cong H(\mathbf{y})$ . We say that in this situation  $L$  is a *generalized diagonal*. Such a component is in particular a real h-line.

(2) More generally, If  $L$  is a connected component of the quiver  $H(\mathbf{x}, \mathbf{y})$ , then the underlying graph of  $L$  is one of the types  $A_n, D'_n, \tilde{A}_n$  or  $\tilde{D}'_n$  for some  $n$ . If  $L$  is of type  $\tilde{A}_n$  or of type  $\tilde{D}'_n$ , then  $\mathbf{x} \sim \mathbf{y}$  is a band, and  $L$  is a generalized diagonal of  $H(\mathbf{x}, \mathbf{y})$ . This follows easily, since all vertices of  $(j, i) \in H_0(\mathbf{x}, \mathbf{y})$  have  $\text{val}(j, i) \leq 2$ , as we already observed. In particular, a vertex with a loop is incident to at most one other arrow.

(3) If  $Q_1^{\text{sp}} = \emptyset$ , i.e. if  $\underline{Q}$  is a gentle polarized quiver, the three notions of h-lines coincide. In this case they are in bijection with the isomorphism classes of Krause's admissible triples [Kr91, p. 189]. See also Section 4.7.

(4) If  $\mathbf{x}$  and  $\mathbf{y}$  both don't have punctured letters the quiver  $H_{\underline{Q}}(\mathbf{x}, \mathbf{y})$  has no loops, and thus each h-line is a real h-line.

(5) If  $\mathbf{x}, \mathbf{y} \in \text{Adm}_b(\underline{Q})$ , i.e. if  $H_{\underline{Q}}(\mathbf{x}, \mathbf{y})$  has no boundary vertices, then trivially *all* real h-lines are kisses, i.e.  $\mathcal{K}_{\underline{Q}}(\mathbf{x}, \mathbf{y}) = \mathcal{R}_{\underline{Q}}(\mathbf{x}, \mathbf{y})$ . On the other hand, if  $\mathbf{x} \in \text{AdmSt}_s(\underline{Q})$ , then the diagonal  $\text{id}_{\mathbf{x}} \in \mathcal{H}_{\underline{Q}}(\mathbf{x}, \mathbf{x})$  is *not* a kiss, since it involves boundary points. If  $\underline{Q}$  is gentle, our notion of a kiss equivalent to the notion of a kiss in [BrY20, Sec. 4], though we also allow kisses, which involve bands.

With the notation from Section 3.5 we have the following characterization of the different types of h-lines, which follows directly from the definitions

**Lemma 4.4.** *Let  $\underline{Q}$  be a skewed-gentle polarized quiver and  $\mathbf{x}, \mathbf{y} \in \text{Adm}(\underline{Q})$ .*

- (a) *A connected component  $L$  of  $(H(\mathbf{x}, \mathbf{y}), H_{1,+}(\mathbf{x}, \mathbf{y}))$  is a real h-line if for some vertex  $(j, i)$  of  $L$  we have*

$$(4.1) \quad \hat{\mathbf{y}}^\delta(j, \rho) \preceq \hat{\mathbf{x}}^\delta(i, \rho) \text{ for all } \delta \in \{+, -\} \text{ and all } \rho \in \{-1, +1\}.$$

*Moreover, condition (4.1) is independent of the choice of the vertex  $(j, i)$  on  $L$ .*

- (b) A connected component  $L'$  of  $(H_0(\mathbf{x}, \mathbf{y}), H_{1,+}(\mathbf{x}, \mathbf{y}) \cup H_{1,o}(\mathbf{x}, \mathbf{y}))$  consists of h-lines if and only if for some vertex  $(j, i)$  on  $L'$  we have

$$(4.2) \quad \widehat{\mathbf{y}}^+(j, \rho) \preceq \widehat{\mathbf{x}}^-(i, \rho) \text{ for both } \rho \in \{-1, +1\}.$$

Moreover, condition (4.2) is independent of the choice of the vertex  $(j, i)$  on  $L'$ .

- (c) A connected component  $L''$  of  $H(\mathbf{x}, \mathbf{y})$  is a long h-line if for some vertex  $(j, i)$  on  $L''$  we have

$$(4.3) \quad \overline{\mathbf{y}}(j, \rho) \leq \overline{\mathbf{x}}(i, \rho) \text{ for both } \rho \in \{-1, +1\}.$$

Moreover, condition (4.2) is independent of the choice of the vertex  $(j, i)$  on  $L''$ .

**4.4. The combinatorics of h-lines.** Let us also restate the following crucial result [Ge99, Prp. 3 (d)] in a more symmetric form:

**Lemma 4.5.** *Let  $\mathbf{x}, \mathbf{y} \in \text{Adm}(\underline{Q})$  and suppose that for  $(j, i) \in H_0(\mathbf{y}) \times H_0(\mathbf{x})$  we have*

$$\widehat{\mathbf{y}}^-(j, \rho) \preceq \widehat{\mathbf{x}}^-(i, \rho) \text{ for both } \rho \in \{-1, +1\},$$

then we have also

$$\overline{\mathbf{y}}(j, \rho) \leq \overline{\mathbf{x}}(i, \rho) \text{ for both } \rho \in \{-1, +1\}.$$

This allows us to prove the following crucial result.

**Proposition 4.6.** *Let  $\underline{Q}$  be a skewed-gentle polarized quiver and  $\mathbf{x}, \mathbf{y} \in \text{Adm}(\underline{Q})$ . Then the decorated quiver  $H_{\underline{Q}}(\mathbf{x}, \mathbf{y})$  has the following properties:*

- (a) *If  $L'$  is the connected component in  $(H_0(\mathbf{x}, \mathbf{y}), H_1(\mathbf{x}, \mathbf{y}) \cup H_{1,o}(\mathbf{x}, \mathbf{y}))$  of a h-line  $L$ , then  $L'$  contains exactly one real h-line.*
- (b) *Each real h-line is contained in a long h-line, and each long h-line contains exactly one real h-line.*

We have in particular a natural bijection  $\mathcal{R}_{\underline{Q}}(\mathbf{x}, \mathbf{y}) \rightarrow \mathcal{H}_{\underline{Q}}(\mathbf{x}, \mathbf{y})$  between real h-lines and long h-lines, which preserves the different types.

*Proof.* (a) By Lemma 4.4 (a) and (b) combined with (3.2) each real h-line is a h-line, as the name suggests. Conversely, let  $L'$  be a component of  $(H_0(\mathbf{x}, \mathbf{y}), H_1(\mathbf{x}, \mathbf{y}) \cup H_{1,o}(\mathbf{x}, \mathbf{y}))$ , which contains no red or orange vertex, and  $L$  a connected component of the quiver which remains from  $L'$  after removing the arrows from  $H_{1,o}(\mathbf{x}, \mathbf{y})$ , then  $L$  is obviously a real h-line if and only if no arrow from  $H_{1,o}(\mathbf{x}, \mathbf{y})$  ends at an (extremal) vertex of  $L$ . We may assume that  $L'$  is not a generalized diagonal. Then the underlying graph of  $L'$  is of type  $A_n$  or of type  $D'_n$  and the components of  $L'$  become a poset under the relation generated by  $L'' > L'$  iff there is an arrow in  $H_{1,o}(\mathbf{x}, \mathbf{y})$  from a point in  $L''$  to a point in  $L'$ . A maximal component under this relation is a real h-line. In particular,  $L'$  contains at least one real h-line. By the same token, if  $L'$  would contain two different real h-lines, it would contain also an h-line  $M$  which contains endpoints of two different arrows from  $H_{1,o}(\mathbf{x}, \mathbf{y})$ . However, this implies that for any vertex  $(j, i) \in M_0$  we have

$$\widehat{\mathbf{y}}^-(j, \rho) \succ \widehat{\mathbf{x}}^+(i, \rho) \text{ for any } \rho \in \{-1, +1\}.$$

Since  $(j, i)$  lies also on the h-line  $M$ , we conclude from Lemma 4.5 that

$$\overline{\mathbf{y}}(j, \rho) = \overline{\mathbf{x}}(i, \rho) \text{ for all } \rho \in \{-1, +1\}.$$

This implies however that  $\mathbf{x} \sim \mathbf{y}$  and  $(j, i)$  is lying on the (permuted) diagonal, contradicting our assumption.

(b) The first claim follows from Lemma 4.5 and our characterization of real resp. long h-lines in Lemma 4.4. Let  $L'$  be a connected component of  $H(\mathbf{x}, \mathbf{y})$ , which contains no red vertex, and which is not a generalized diagonal. Consider a connected component of the quiver which is obtained from  $L'$  after removing the arrows from  $H_{1,\times}(\mathbf{x}, \mathbf{y})$ . Then

$L$  is (the connected component of) a h-line if and only if none of its extremal vertices is orange, by definition. Conversely, if each extremal vertex of  $L$  is orange, for any vertex  $(j, i) \in L_0$  we have

$$\widehat{\mathbf{y}}^-(j, \rho) \succ \widehat{\mathbf{x}}^-(i, \rho) \text{ for any } \rho \in \{-1, +1\}.$$

By Lemma 4.5 this implies

$$\overline{\mathbf{y}}(j, \rho) > \overline{\mathbf{x}}(i, \rho) \text{ for any } \rho \in \{-1, +1\}.$$

On the other hand, by the characterization of long h-lines we have

$$\overline{\mathbf{y}}(j, \rho) \leq \overline{\mathbf{x}}(i, \rho) \text{ for any } \rho \in \{-1, +1\}.$$

Thus  $(j, i)$  lies on a generalized diagonal, a contradiction. Now we can conclude with the same post argument as in the proof of (a).  $\square$

**4.5. Dual h-lines.** Given  $\mathbf{x}, \mathbf{y} \in \text{Adm}(\underline{Q})$ , for the calculation of E-invariant it will be convenient to read off from  $H_{\underline{Q}}(\mathbf{x}, \mathbf{y})$  the different types of h-lines in  $H_{\underline{Q}}(\mathbf{y}, \mathbf{x})$ . To this purpose we need to introduce a further set of color labels for the vertices of  $H_{\underline{Q}}(\mathbf{x}, \mathbf{y})$ , namely by the colors blue, cyan and teal.

$$\begin{aligned} H_0^{\text{blu}} &:= \{(j, i) \in H_o(\mathbf{x}, \mathbf{y}) \mid \overline{\mathbf{y}}(j, \rho) < \overline{\mathbf{x}}(i, \rho) \text{ and } \Delta(\overline{\mathbf{y}}(j, \rho), \overline{\mathbf{x}}(i, \rho)) = 0 \\ &\hspace{15em} \text{for some } \rho \in \{-1, 1\}\}, \\ H_0^{\text{cya}} &:= \{s(\nu, \mu)_{\times} \mid (\mu, \nu)_{\times} \in H_{1, \times}(\mathbf{x}, \mathbf{y})\}, \\ H_0^{\text{tea}} &:= \{s(\nu, \mu)_{*} \mid (\mu, \nu)_{*} \in H_{1, o}(\mathbf{x}, \mathbf{y})\}. \end{aligned}$$

Note, that a blue vertex can receive also cyan label, or a teal label. However, out of the labels orange, purple, cyan and teal, at most one can be attached to a given vertex. We note also, that in  $H_{\underline{Q}}^+(\mathbf{x}, \mathbf{y}) := (H_0(\mathbf{x}, \mathbf{y}), H_{1,+}(\mathbf{x}))$  all vertices  $(j, i) \in H_0(\mathbf{x}, \mathbf{y})$  of valency 1, where at least one of  $j$  and  $i$  is not a boundary vertex, have now assigned at least one color label. Only the isolated vertices of  $H_{\underline{Q}}(\mathbf{x}, \mathbf{y})$  can have assigned 2 (possibly the same) color labels from the colors blue and red.

A connected component of the quiver  $H_{\underline{Q}}^+(\mathbf{x}, \mathbf{y})$ , which contains no blue, cyan or teal vertex, is a *dual real h-line*. A connected component of the quiver  $H_{\underline{Q}}^+(\mathbf{x}, \mathbf{y})$ , such that its connected component in  $(H_0(\mathbf{x}, \mathbf{y}), H_{1,+}(\mathbf{x}, \mathbf{y}) \cup H_{1,o}(\mathbf{x}, \mathbf{y}))$  contains no blue or cyan vertex, is a *dual h-line*. A connected component of the quiver  $H(\mathbf{x}, \mathbf{y})$ , which contains no blue vertex, is a *dual long h-line*.

A dual real h-line  $L \in \mathcal{H}_{\underline{Q}}(\mathbf{x}, \mathbf{y})$ , is a *dual kiss* if none of its (at most 2) endpoints is a boundary point of  $H_{\underline{Q}}(\mathbf{x}, \mathbf{y})$  (see end of Section 4.2).

**Remark 4.7.** (1) It is easy to see that  $(j, i) \in H_0(\mathbf{x}, \mathbf{y})$  lies on a dual (real, long) h-line, resp. on a dual kiss if and only if  $(i, j) \in H_0(\mathbf{y}, \mathbf{x})$  lies on a (real, long) h-line resp. a kiss.

(2) Each loop of  $H_{\underline{Q}}(\mathbf{x}, \mathbf{y})$  belongs to a real h-line, or to a dual real h-line. Indeed, if the connected component of a loop is not a generalized diagonal, then its unique endpoint must have at least one color label. In particular, a real h-line of type  $D'$  is a kiss except if it is a diagonal, or a anti-diagonal.

(3) From the definitions it is clear, that the kisses are precisely the components, where each endpoint has one of the labels blue, cyan or teal, and where moreover vertices with blue label are not boundary vertices. By replacing blue by red, cyan by orange, and teal by purple, we obtain a corresponding characterization of the dual kisses.

4.6. **Example.** Consider the polarized quiver

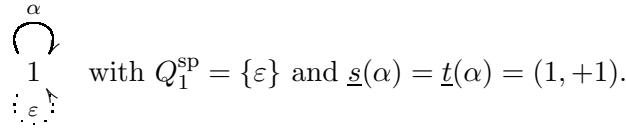

This is “almost” a skewed-gentle polarized quiver, except for the boundedness. It makes perfect sense to consider for this quiver admissible strings and bands and we can present for relatively short words an interesting quiver  $H_Q(\mathbf{x}, \mathbf{y})$ . Consider  $\mathbf{x} = \mathbb{1}_{1,1}^{-1}\varepsilon\alpha\varepsilon\alpha^{-1}\mathbb{1}_{1,-1}$ , which is admissible of type (u,p), and  $\mathbf{y} = \mathbb{1}_{1,-1}^{-1}\alpha\varepsilon\alpha\varepsilon^{-1}\mathbb{1}_{1,-1}$ , which is admissible of type (p,p). We display the quivers  $H(\mathbf{x}), H(\mathbf{y})$  and the decorated quiver  $H_Q(\mathbf{x}, \mathbf{y})$  with all the colored labels. Observe, that this is essentially the same situation as the one, which was considered in [Ge99, Sec. 3.4].

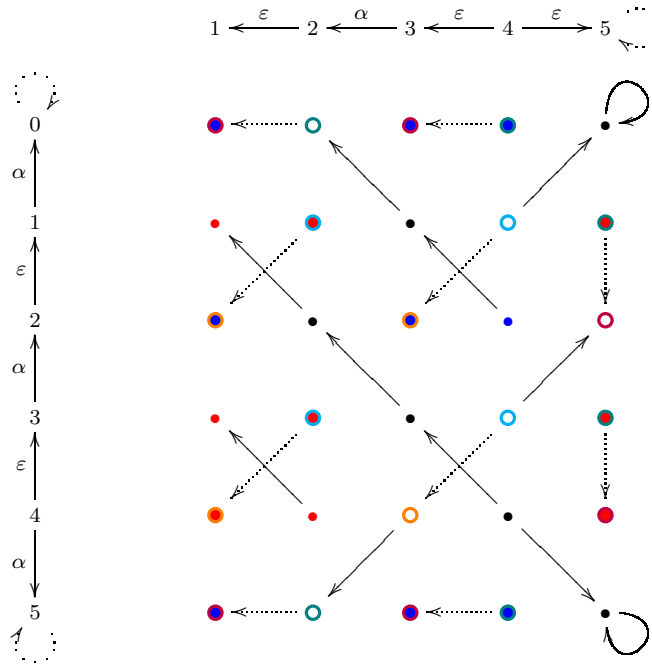

The vertices  $(0, 4), (2, 4)$  and  $(5, 4)$  lie on pairwise different real h-lines of type A, whilst  $(1, 4)$  lies on a real h-line of type D'. We leave it as an exercise to identify the different dual real h-lines.

4.7. **Triples and h-lines.** In [Kr91] Krause introduced admissible triples as a framework for the combinatorial description of homomorphisms between representations of gentle algebras. We adapt his construction here to the setting of skewed-gentle polarized quivers, and relate it to our construction in terms of the quiver  $H_Q(\mathbf{x}, \mathbf{y})$ .

A skewed-gentle polarized quiver  $\underline{H}$  is called *hereditary* if the following two conditions are fulfilled:

- The underlying graph of  $\underline{H}$  is one of the four types in Table 2 and all loops are special.
- If  $\alpha, \beta \in H_1$  are two different arrows with  $s(\alpha) = t(\beta)$ , then  $s_1(\alpha) = -t_1(\beta)$ .

In Section 5.1 we will assign to each skewed-gentle polarized quiver  $\underline{Q}$  a skewed-gentle  $k$ -algebra  $k\underline{Q}$ . This algebra is hereditary precisely, if  $\underline{Q}$  is hereditary in the above sense.



For a fixed, skewed-gentle polarized quiver  $\underline{Q}$  we are interested in the category of homomorphisms  $G: \underline{H} \rightarrow \underline{Q}$  where  $\underline{H}$  is hereditary. By definition, a *morphism*  $\phi: G \rightarrow G'$  between homomorphisms  $G: \underline{H} \rightarrow \underline{Q}$  and  $G': \underline{H}' \rightarrow \underline{Q}$  is given by a strict homomorphism  $\phi: \underline{H} \rightarrow \underline{H}'$  of skewed-gentle polarized quivers, such that  $G'\phi = G$ . Recall, that a homomorphism between polarized quivers is *strict*, if it sends ordinary arrows to ordinary arrows, see the definitions in Section 2.1.

Note, that if in this situation  $\underline{H}$  is of type  $\tilde{A}$  or of type  $\tilde{D}'$ , then  $\phi$  is surjective, and  $\underline{H}'$  is of the same type as  $\underline{H}$ .

A *winding* of the skewed-gentle quiver  $\underline{Q}$  is a homomorphism  $G: \underline{H} \rightarrow \underline{Q}$  of skewed-gentle polarized quivers, where  $\underline{H}$  is hereditary. If  $\underline{H}$  is of type  $\tilde{A}$  or of type  $\tilde{D}'$ , we request furthermore that any morphism of windings, which starts in  $G$  is an isomorphism. In view of Remark 2.2, our definition of windings is compatible with the one from [Kr91].

In particular, the morphisms  $G_x: \underline{H}(\mathbf{x}) \rightarrow \underline{Q}$  for  $\mathbf{x} \in \text{Adm}(\underline{Q})$  from Section 4.1 are windings. Observe that a winding may send an ordinary arrow to a special loop, whilst the morphisms between windings send ordinary arrows to ordinary arrows.

We consider the following properties of a morphism  $\phi: G \rightarrow G'$  of windings  $G: \underline{H} \rightarrow \underline{Q}$  and  $G': \underline{H}' \rightarrow \underline{Q}$ .

- (q) If  $j \in H_0$  is a boundary vertex and  $\alpha' \in (H'_1)^{\text{ord}}$  with  $s(\alpha') = \phi(j)$ , then there exists an arrow  $\alpha$  in  $\underline{H}$  with  $\phi(\alpha) = \alpha'$ .
- (s) If  $j \in H_0$  is a boundary vertex and  $\beta' \in (H'_1)^{\text{ord}}$  with  $t(\beta') = \phi(j)$ , then there exists an arrow  $\beta$  in  $\underline{H}$  with  $\phi(\beta) = \beta'$ .
- (K) If  $j \in H_0$  is a boundary vertex of  $\underline{H}$ , then  $\phi(j) \in H'_0$  is *not* a boundary vertex of  $\underline{H}'$ .

**Definition 4.8.** For  $\mathbf{x}, \mathbf{y} \in \text{Adm}(\underline{Q})$  a *H-triple*  $(G, \phi_q, \phi_s)$  for  $(\mathbf{x}, \mathbf{y})$  consists of a winding  $G: \underline{H}(G) \rightarrow \underline{Q}$ , together with a morphism  $\phi_q: G \rightarrow G_x$  with property (q), and a morphism  $G \rightarrow G_y$  with property (s). Moreover, we request that in case  $\phi_q(j) \in H_0^{\text{sp}}(\mathbf{x})$  and  $\phi_s(j) \in H_0^{\text{sp}}(\mathbf{y})$  that  $j \in H_0^{\text{sp}}$ . Recall, that by definition  $\phi_q$  and  $\phi_s$  are strict homomorphisms of polarized quivers. An H-triple  $(G, \phi_q, \phi_s)$  is a *K-triple*, if  $\phi_q$  and  $\phi_s$  have moreover property (K).

Two H-triples  $(G, \phi_q, \phi_s)$  and  $(G', \phi'_q, \phi'_s)$  are *equivalent*, if there is an isomorphism of windings  $\psi: G \rightarrow G'$  such that  $\phi_q = \phi'_q \psi$  and  $\phi_s = \phi'_s \psi$ . In other words, in the following diagram all triangles must be commutative.

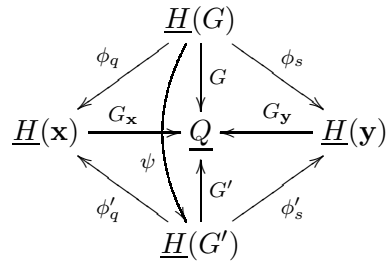

We denote the set of equivalence classes  $[(G, \phi_q, \phi_s)]$  of H-triples for  $(\mathbf{x}, \mathbf{y})$  by  $\mathcal{T}_{\underline{Q}}(\mathbf{x}, \mathbf{y})$ . The subset of classes of K-triples is denoted by  $\mathcal{K}_{\underline{Q}}(\mathbf{x}, \mathbf{y})$ .

The *type* of  $(G, \phi_q, \phi_s) \in \mathcal{T}(\mathbf{x}, \mathbf{y})$  is the *type* of this triple is underlying graph of  $\underline{H}(G)$ . Thus, the type of  $(G, \phi_q, \phi_s)$  belongs to the list from Table 2.

On the other hand, we define  $L(G, \phi_q, \phi_s)$  to be the following subquiver of  $\underline{H}_{\underline{Q}}^+(\mathbf{x}, \mathbf{y})$ : It consists of the vertices  $(\phi_q(h), \phi_s(h))$  for  $h \in H_0$  and has an arrow

$$(\phi_q(\alpha), \phi_s(\alpha)): (\phi_s(s(\alpha)), \phi_q(s(\alpha))) \rightarrow (\phi_s(t(\alpha)), \phi_q(t(\alpha)))$$

for each arrow  $\alpha$  of  $\underline{H}$ . In particular, as a quiver,  $L(G, \phi_q, \phi_s)$  is isomorphic to  $\underline{H}$ .

**Proposition 4.9.** *The map  $L$  induces a bijection*

$$\mathcal{T}_{\underline{Q}}(\mathbf{x}, \mathbf{y}) \rightarrow \mathcal{R}_{\underline{Q}}(\mathbf{x}, \mathbf{y}), \quad (G, \phi_q, \phi_s) \mapsto L(G, \phi_q, \phi_s),$$

from the equivalence classes of  $H$ -triples to the real  $h$ -lines of  $H_{\underline{Q}}(\mathbf{x}, \mathbf{y})$ . Under this correspondence,  $K$ -lines correspond precisely to kisses.

*Proof.* Clearly,  $L(G, \phi_q, \phi_s) = L(G', \phi'_q, \phi'_s)$  if  $(G', \phi'_q, \phi'_s)$  is equivalent to  $(G, \phi_q, \phi_s)$ . Moreover,  $L(G, \phi_q, \phi_s)$  is indeed a connected component of  $H_{\underline{Q}}^+(\mathbf{x}, \mathbf{y}) := (H_0(\mathbf{x}, \mathbf{y}), H_{1,+}(\mathbf{x}, \mathbf{y}))$ , which contains no red, orange or purple vertex, due to the properties (q) resp. (s) of  $\phi_q$  resp.  $\phi_s$ . Thus, the map is well-defined.

It is easy to see that the following construction yields an inverse to  $L$ . Let  $L$  is a real  $h$ -line, we can consider it as a quiver, together with projections  $\pi_s: L \rightarrow \underline{H}(\mathbf{y})$  and  $\pi_q: L \rightarrow \underline{H}(\mathbf{x})$ . For example,  $\pi_s(j, i) = j$  and  $\pi_s(\nu, \mu) = \nu$ . By the construction of  $H_{\underline{Q}}(\mathbf{x}, \mathbf{y})$  we have then  $G_x \pi_q = G_y \pi_s =: G$ , and  $(G, \pi_q, \pi_s)$  becomes an  $h$ -triple with  $G: L \rightarrow \underline{Q}$  a winding, where we can equip  $L$  with the canonical polarization compatible with  $G$ .  $\square$

**Example 4.10.** Let  $\mathbf{s}_i, \mathbf{x} \in \text{Adm}(\underline{Q})$ , where  $\mathbf{s}_i := \mathbb{1}_{i,+}^{-1} \mathbb{1}_{i,-}$  for some  $i \in Q_0$ . If  $i \in Q_0^{\text{ord}}$ , all (real, possibly dual)  $h$ -lines in  $H_{\underline{Q}}(\mathbf{s}_i, \mathbf{x})$  are of type  $A_1$ . In this situation the equivalence classes  $H$ -triples for  $(\mathbf{x}, \mathbf{s}_i)$  are (via projection) in bijection with morphisms  $G_{\mathbf{s}_i} \rightarrow G_{\mathbf{x}}$ , which have property (q). The reason is, that  $H(\mathbf{s}_i) = H$  consists of a single vertex 1, and thus the identity is the unique morphism  $\phi_s$  with property (s). For the same reason we don't have to deal with equivalence classes. The just mentioned morphisms with property (q) are obviously given by the sources  $j$  of  $\underline{H}(\mathbf{x})$  with  $G_{\mathbf{x}}(j) = i$ .

For  $i \in Q_0^{\text{sp}}$  the quiver  $\underline{H}(\mathbf{s}_i)$  is of type  $D'_1$ , i.e. it has only one vertex 1 with a single (special) loop  $\eta$ . In this case the real  $h$ -lines in  $H_{\underline{Q}}(\mathbf{x}, \mathbf{s}_i)$  are of type  $A_1$  or of type  $D'_1$ . All real  $h$ -lines of type  $A_1$  are contained in a long  $h$ -line of type  $A_2$ . Similar to the previous case, the real  $h$ -lines of type  $A_1$  are in bijection with morphisms  $\phi_q: G \rightarrow G_{\mathbf{x}}$  with property (q), where  $G: \{1\} \rightarrow \underline{Q}$  is given by  $1 \mapsto i$ . In this situation the map  $\phi_s: \{1\} \rightarrow \underline{H}(\mathbf{s}_i)$  is trivially given by the inclusion. The just mentioned morphisms  $\phi_q$  are also in bijection with the sources  $j$  of  $\underline{H}(\mathbf{x})$  with  $G_{\mathbf{x}}(j) = i$ .

On the other hand the  $h$ -lines of type  $D'_1$  are in bijection with the morphisms of windings  $\phi_q: \underline{H}(\mathbf{s}_i) \rightarrow \underline{H}(\mathbf{x})$  which have property (q). Those are also in bijection with the *special* vertices  $j$  of  $\underline{H}(\mathbf{x})$  where no ordinary arrow starts, and moreover  $G_{\mathbf{x}}(j) = i$ . Thus, there are at most two  $h$ -lines of type  $D'$ .

**4.8. Fringing.** Let  $\underline{Q}$  be a skewed-gentle polarized quiver. We extend and slightly generalize the notion of fringing from [BrY20, Sec. 3] to our setting of skewed-gentle polarized quivers.

**Definition 4.11.** Let  $\underline{Q} \subset \underline{Q}^f$  be an inclusion of skewed-gentle polarized quivers. We say that  $\underline{Q}^f$  is a *fringing* of  $\underline{Q}$  if the following two conditions hold:

- (1) For each interior vertex  $i \in \underline{Q}_0 \subset \underline{Q}_0^f$  we have

$$|\{\alpha \in \underline{Q}_1^f \mid s(\alpha) = i\}| + |\{\beta \in \underline{Q}_1^f \mid t(\beta) = i\}| = 4.$$

- (2) For each *fringe arrow*  $\alpha \in \underline{Q}_1^f \setminus \underline{Q}_1$  we have:  $s(\alpha) \in \underline{Q}_0$  implies  $t(\alpha) \in (\underline{Q}_0^f \setminus \underline{Q}_0) \times \{+1\}$ , and  $s(\alpha) \in \underline{Q}_0^f \setminus \underline{Q}_0$  implies  $s_1(\alpha) = +1$  and  $t(\alpha) \in \underline{Q}_0$ .

In particular, each fringe arrow connects a *fringe vertex*  $j \in \underline{Q}_0^f \setminus \underline{Q}_0$  with an interior vertex. Moreover, each fringe vertex has valency at most 2, since at a fringe vertex the

polarization is by definition always  $+1$ . It is clear that each skewed-gentle polarized quiver admits a fringing, however our fringing are not unique. For example, in the following display, two non-isomorphic fringing of the same skewed-gentle polarized quiver  $\underline{Q}$  with  $Q_0 = \{1, 2, 3\}$  and  $Q_1^{\text{SP}} = \{\varepsilon\}$ , from Section 2.7, are exhibited.

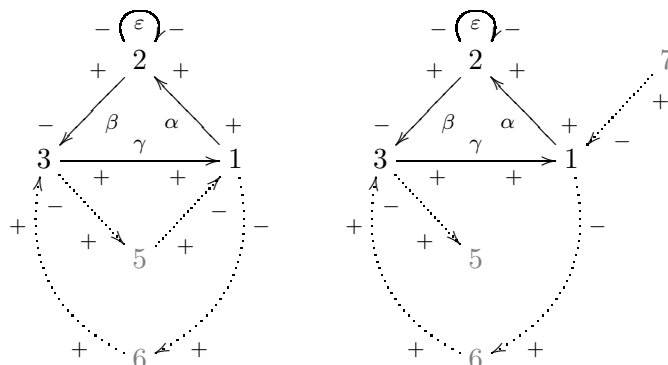

Note, that the operator  $\tau_{\underline{Q}^f}$  from Section 3.4 acts on  $\mathbf{x} \in \text{Adm}_s(\underline{Q})$  by replacing each unpunctured (trivial) letter by the corresponding cohook, which ends then in a fringe vertex. As observed in [BrY20], this regular behaves has several avengers.

**4.9. Kisses, K-triples and fringing.** Let  $\underline{Q} \subset \underline{Q}^f$  be a skewed-gentle polarized quiver with fringing. Recall from Section 3.4 that we have an operator  $\tau = \tau_{\underline{Q}}$  on  $\text{Adm}(\underline{Q})$ . Clearly  $\text{Adm}(\underline{Q}) \subset \text{Adm}(\underline{Q}^f)$ , and we abbreviate  $\tau_f = \tau_{\underline{Q}^f}$  for the corresponding operator on  $\text{Adm}(\underline{Q}^f)$ . For  $\mathbf{x} \in \text{Adm}(\underline{Q})$  we will consider frequently  $\iota_{G_{\mathbf{x}}}: \underline{H}(\mathbf{x}) \rightarrow \underline{Q}^f$  as a winding over  $\underline{Q}^f$ , where  $\iota$  is inclusion of  $\underline{Q}$  into  $\underline{Q}^f$ . See also Section 4.1.

**Remark 4.12.** Let  $\mathbf{x}, \mathbf{y} \in \text{Adm}(\underline{Q})$  with  $\mathbf{y}$  not projective. With the notation from Section 4.7 we have injective morphisms of windings

$$\pi_{\mathbf{x}}: G_{\mathbf{x}} \rightarrow G_{\tau_f \mathbf{x}} \quad \text{and} \quad \sigma_{\mathbf{y}}: G_{\tau_f \mathbf{y}} \rightarrow G_{\tau_f \mathbf{y}},$$

where  $\pi_x$  has properties (q) and (K), and  $\sigma_y$  has properties (s) and (K). This follows easily from Remark 3.3.

The following result is our adaption of [BrY20, Lem. 4.2] to the situation of skewed-gentle polarized quivers. We include the proof for the convenience of the reader, though the idea is very similar to original version.

**Lemma 4.13.** *With the notation, which was introduced above, we have the following:*

- (a) *For each  $\mathbf{x} \in \text{Adm}(\underline{Q})$ , composition with  $\pi_{\mathbf{x}}$  yields a bijection between the equivalence classes of morphisms of windings  $\phi: G \rightarrow G_{\mathbf{x}}$  with property (q) and morphisms of windings  $\phi': G' \rightarrow G_{\mathbf{x}}$  with property (q) and (K).*
- (b) *For each  $\mathbf{x} \in \text{Adm}(\underline{Q})$  which is not projective, composition with  $\sigma_{\mathbf{x}}$  yields a bijection between the equivalence classes of morphisms of windings  $\phi: G \rightarrow G_{\tau_f \mathbf{x}}$  with property (s) and morphisms of windings  $\phi': G \rightarrow G_{\tau_f \mathbf{x}}$  with property (s) and (k).*

*Proof.* The composition of morphisms of windings with property (q) resp. with property (s) has again this property. Thus, the maps described in (a) and (b) are injective by Remark 4.12. Thus it remains to prove surjectivity in both situations. We may assume that  $\mathbf{x} \in \text{Adm}_s(\underline{Q})$ , because otherwise we have  $\tau_f \mathbf{x} = \mathbf{x} = \tau \mathbf{x}$ , and our claim becomes trivial. For the same reason we may even assume that  $\mathbf{x} = \mathbb{1}_{i,\mu}^{-1} \mathbf{x}' \mathbb{1}_{j,\nu}$  with  $\mathbb{1}_{j,\nu}$  unpunctured. Thus

$$\tau_f \mathbf{x} = \begin{cases} \mathbb{1}_{i',\mu'}^{-1} \alpha_m^{-1} \cdots \alpha_2^{-1} \alpha_1 \mathbf{x}' \beta_1^{-1} \beta_2 \cdots \beta_n \mathbb{1}_{j',\nu'} & \text{if } \mathbb{1}_{i,\mu} \text{ is unpunctured,} \\ \mathbb{1}_{i,\nu}^{-1} \mathbf{x}' \beta_1^{-1} \beta_2 \cdots \beta_n \mathbb{1}_{j',\sigma'} & \text{if } \mathbb{1}_{i,\nu} \text{ is punctured,} \end{cases}$$

for certain arrows  $\alpha_1, \dots, \alpha_m, \beta_1, \dots, \beta_n$  with  $m, n \geq 1$ ,  $\alpha_1, \beta_1$  ordinary arrows, and  $\alpha_m, \beta_n \in \underline{Q}_1^f \setminus Q_1$ .

(a) Suppose for example in the second case that we have a morphism of windings  $\psi: G \rightarrow G_{\tau_f \mathbf{x}}$  with property (q), which does not factor of  $\pi_{\mathbf{x}}$ . Then  $G: \underline{H} \rightarrow \widehat{Q}$  must be given by  $H = H(\mathbb{1}_{i'', \mu''}^{-1} \mathbf{x}'' \beta_1^{-1} \beta_2 \cdots \beta_n \mathbb{1}_{j', \nu'})$  where  $\mathbf{x}' = \mathbf{y} \mathbf{x}''$ . However, in this case  $\psi$  does not have property (K). A contradiction. The first case is similar.

(b) Assume assume that  $\mathbb{1}_{i, \nu}$  is punctured, and thus  $\tau_f \mathbf{x} = \mathbb{1}_{i, \nu}^{-1} \mathbf{x}' \beta_1^{-1} \beta_2 \cdots \beta_{n-1} \beta_n \mathbb{1}_{j', \sigma'}$ . The other possibility is very similar. If  $n \geq 2$ , we have  $\tau \mathbf{x} = \mathbb{1}_{i, \nu}^{-1} \mathbf{x}' \beta_1^{-1} \beta_2 \cdots \beta_{n-1} \mathbb{1}_{j'', \sigma''}$ . If in this case we have  $\psi: G \rightarrow G_{\tau_f \mathbf{x}}$  which does not factor over  $\sigma_{\mathbf{x}}$ , then clearly  $\psi$  lacks property (k).

If  $n = 1$ , the string  $\tau \mathbf{x} \in \text{Adm}(\underline{Q})$  is obtained from  $\mathbf{x}$  by removing a hook. Thus, we have a factorization  $\mathbf{x}' = (\tau \mathbf{x})' \gamma_1 \gamma_2^{-1} \cdots \gamma_l^{-1}$  for certain arrows  $\gamma_1, \dots, \gamma_l$  with  $l \geq 1$ . Thus, if  $\psi: G \rightarrow G_{\tau_f \mathbf{x}}$  has properties (s) and (k), the winding  $G: H \rightarrow \widehat{Q}$  with  $H = H(\mathbf{y})$  must correspond actually to a substring  $\mathbf{y}'$  of  $(\tau \mathbf{x})'$ .  $\square$

The next result is a generalization of [BrY20, Thm. 4.3] to the our setting of skewed-gentle polarized quivers, and to our relaxed definition of fringing. Note, that we allow in our correspondence also bands. This makes it necessary to use a setup which is inspired by Krause's admissible triples from [Kr91], and which was prepared in the previous Lemma.

**Proposition 4.14.** *Let  $\underline{Q} \subset \underline{Q}^f$  be a skewed-gentle polarized quiver with a fringing, and  $\mathbf{x}, \mathbf{y} \in \text{Adm}(\underline{Q})$ .*

(a) *If  $\mathbf{y}$  is not projective, the map*

$$\underline{\mathcal{T}}_{\underline{Q}}(\mathbf{x}, \tau \mathbf{y}) \rightarrow \mathcal{K}_{\underline{Q}^f}(\tau_f \mathbf{x}, \tau_f \mathbf{y}), \quad (G, \phi_q, \phi_s) \mapsto (\iota G, \pi_{\mathbf{x}} \phi_q, \sigma_{\mathbf{y}} \phi_s)$$

*is a bijection from the  $h$ -triples for  $(\mathbf{x}, \tau \mathbf{y})$  to the  $k$ -triples for  $(\tau_f \mathbf{x}, \tau_f \mathbf{y})$ , which respects the types. If  $\mathbf{y}$  is projective,  $\mathcal{K}_{\underline{Q}^f}(\tau_f \mathbf{x}, \tau_f \mathbf{y}) = \emptyset$ .*

(b) *There is a natural bijection  $\mathcal{R}_{\underline{Q}}(\mathbf{x}, \tau \mathbf{y}) \rightarrow \mathcal{K}_{\underline{Q}^f}(\tau_f \mathbf{x}, \tau_f \mathbf{y})$ , between the set of real  $h$ -lines from  $\mathbf{x}$  to  $\tau \mathbf{y}$  and the set of kisses from  $\tau_f \mathbf{x}$  to  $\tau_f \mathbf{y}$ .*

*Proof.* (a) is a direct consequence of Lemma 4.13 and the definitions.

(b) Follows from (a) and Proposition 4.9.  $\square$

**Remark 4.15.** Let  $\mathbf{x}, \mathbf{y} \in \text{Adm}(\underline{Q})$ , and abbreviate  $\tilde{\mathbf{x}} := \tau_{\underline{Q}^f}(\mathbf{x})$ ,  $\tilde{\mathbf{y}} := \tau_{\underline{Q}^f}(\mathbf{y})$ . By the construction of  $\tau_{\underline{Q}^f}$  and of  $\underline{Q}^f$ , a vertex  $i \in H_0(\tilde{\mathbf{x}})$  is a boundary vertex if and only if  $G_{\tilde{\mathbf{x}}}(i)$  is a fringe vertex. The same statement holds, if we replace  $\tilde{\mathbf{x}}$  by  $\tilde{\mathbf{y}}$ . Thus, a vertex  $(j, i)$  of  $H_{\underline{Q}^f}(\tilde{\mathbf{x}}, \tilde{\mathbf{y}})$  is a boundary vertex if and only if  $G_{\tilde{\mathbf{y}}}(j) = G_{\tilde{\mathbf{x}}}(i)$  is a fringe vertex and in particular, both  $j$  and  $i$  are boundary vertices. Let us call such vertices of  $H_{\underline{Q}^f}(\tilde{\mathbf{x}}, \tilde{\mathbf{y}})$  *corner vertices*. Clearly,  $H_{\underline{Q}^f}(\tilde{\mathbf{x}}, \tilde{\mathbf{y}})$  has at most 4 corner vertices. The connected component in  $H_{\underline{Q}^f}^+(\tilde{\mathbf{x}}, \tilde{\mathbf{y}})$  of a corner vertex is clearly a real  $h$ -line, or a dual real  $h$ -line, and these are precisely the (possibly dual) real  $h$ -lines, which are not (possibly dual) kisses.

## 5. THE MODULE CATEGORY OF A SKEWED-GENTLE ALGEBRA

In this section  $k$  will be a field with  $\text{char}(k) \neq 2$ .

**5.1. Skewed-gentle algebras.** If  $\underline{Q}$  is a polarized quiver, we write  $k\underline{Q} := kQ / \langle \mathcal{R}(\underline{Q}) \rangle$  for the path algebra of the underlying quiver  $Q$  modulo the relations

$$\mathcal{R}(\underline{Q}) = \{\alpha\beta \mid \alpha, \beta \in Q_1^{\text{ord}} \text{ and } \underline{s}(\alpha) = \underline{t}(\beta)\} \cup \{\varepsilon' \varepsilon - e_{s(\varepsilon)} \mid \varepsilon \in Q_1^{\text{sp}}\}.$$

Here,  $e_i$  denotes the trivial path concentrated at the vertex  $i$ . If  $\underline{Q}$  is skewed-gentle, the second set of relations can be rewritten as  $\{\varepsilon_i^2 - e_i \mid i \in Q_0^{\text{SP}}\}$ . In this case  $k\underline{Q}$  is a skewed-gentle algebra in the sense of [GP99, Sec. 4.1]. In particular it is a clannish algebra in the sense of Crawley-Boevey [CrB89b], because the polynomial  $X^2 - 1$  has two different zeros,  $-1$  and  $1$ , in our  $k$ . If  $Q_1^{\text{SP}} = \emptyset$  clearly  $k\underline{Q}$  is a gentle algebra.

$k\underline{Q}$  admits an automorphism  $\chi$  of order 2 which acts on the arrows as follows:

$$\chi(\alpha) = \begin{cases} \alpha & \text{if } \alpha \in Q_1^{\text{ord}}, \\ -\alpha & \text{if } \alpha \in Q_1^{\text{SP}}. \end{cases}$$

For later use it will be convenient to recall how  $k\underline{Q}$  can be described in terms of a quiver  $\tilde{Q}$  and admissible relations  $\tilde{\mathcal{R}}$ . For this purpose we define for each vertex  $i \in Q_0$

$$\begin{aligned} S(i) &:= \begin{cases} \{+, -\} & \text{if } i \in Q_0^{\text{SP}} \\ \{o\} & \text{if } i \in Q_0^{\text{ord}}, \end{cases} \\ \tilde{Q}_0 &:= \{(i, \rho) \mid i \in Q_0 \text{ and } \rho \in S(i)\}, \\ \tilde{Q}_1 &:= \{\tau\alpha_\sigma \mid \alpha \in Q_1^{\text{ord}}, \tau \in S(t(\alpha)), \sigma \in S(s(\alpha))\}, \\ s(\tau\alpha_\sigma) &:= (s(\alpha), \sigma), \\ t(\tau\alpha_\sigma) &:= (t(\alpha), \tau), \\ \tilde{\mathcal{R}} &:= \bigcup_{\alpha\beta \in \mathcal{R}^{\text{ord}}} \left\{ \sum_{\sigma \in S(t(\beta))} \tau\alpha_\sigma\beta_\rho \mid \tau \in S(t(\alpha)) \text{ and } \rho \in S(s(\beta)) \right\}. \end{aligned}$$

Then it is not difficult to see that

$$\begin{aligned} \varphi_Q: k\underline{Q} &\rightarrow k\tilde{Q}/\langle \tilde{\mathcal{R}} \rangle, \text{ defined by} \\ e_i &\mapsto \sum_{\sigma \in S(i)} e_{(i,\sigma)} \text{ for all } i \in Q_0, \\ \alpha &\mapsto \sum_{\tau \in S(t(\alpha)), \sigma \in S(s(\alpha))} \tau\alpha_\sigma \text{ for all } \alpha \in Q_1^{\text{ord}}, \\ \varepsilon_i &\mapsto e_{(i,+)} - e_{(i,-)} \text{ for all } i \in Q_0^{\text{SP}}, \end{aligned}$$

is a  $k$ -algebra isomorphism. Note that  $\varphi_Q^{-1}(e_{(i,\pm)}) = 1/2(e_i \pm \varepsilon_i)$  for all  $i \in Q_0^{\text{SP}}$ . Moreover, for a representation  $M = ((M_i)_{i \in Q_0}, (M(\alpha))_{\alpha \in Q_1})$  of  $k\underline{Q}$  and  $i \in Q_0^{\text{SP}}$ , the decomposition  $M_i = \varphi_Q^{-1}(e_{(i,+)}M_i) \oplus \varphi_Q^{-1}(e_{(i,-)}M_i)$  corresponds precisely to the two eigenspaces of the involutive endomorphism  $M(\varepsilon_i)$  of  $M_i$ .

**5.2. Parametrization of the indecomposable modules.** Let from now on  $\underline{Q}$  be a skewed-gentle polarized quiver. Recall that by Proposition 3.1, the completion operation  $\tilde{\phantom{x}}$ , defined in Equation (3.1), induces a bijection between the equivalence classes of admissible words  $\text{Adm}(\underline{Q})$  and the equivalence classes of strings and bands  $\text{St}(\underline{Q}) \cup [\text{pBa}(\underline{Q})]$ . In Section 4.1 we constructed for each  $\mathbf{x} \in \text{Adm}(\underline{Q})$  a homomorphism of polarized quivers  $G_{\mathbf{x}}: \underline{H}(\mathbf{x}) \rightarrow \underline{Q}$ . These maps are the combinatorial skeleton of Crawley-Boevey's description of the indecomposable representations of a clannish algebra in terms of arbitrary defining quadratic polynomials  $q_i(X) = (X - a_i)(X - b_i)$  with  $a_i, b_i \in k^*$  and  $a_i \neq b_i$  for the special loops  $\varepsilon_i$ . We define now a simplified quiver  $\underline{H}^o(\mathbf{x})$  together with a homomorphism of polarized quivers

$$G_{\mathbf{x}}^o: \underline{H}^o(\mathbf{x}) \rightarrow \underline{Q},$$

where the orientation of the arrows in  $(G^o(\mathbf{x}))^{-1}(Q_1^{\text{sp}})$  does not depend on the relation  $>$  for words. Following Crawley-Boevey [CrB88], this simplified construction is sufficient to describe the indecomposable representations of the skewed-gentle algebras (a special case of clannish algebras) in our situation, where we consider  $k\underline{Q}$  with  $\text{char}(k) \neq 2$  and defining relations  $X^2 - 1$  for all special loops.

The quiver  $\underline{H}^o(\mathbf{x})$  is obtained from  $\underline{H}(\mathbf{x})$  by adding to each arrow  $a \xrightarrow{\nu_i} b$  with  $a \neq b$  and  $G_{\mathbf{x}}(\nu_i) \in Q_1^{\text{sp}}$  an additional arrow  $a \xleftarrow{\nu'_i} b$  with  $G_{\mathbf{x}}^o(\nu'_i) = G_{\mathbf{x}}(\nu_i)$ . In this case we declare the arrows  $\nu_i$  and  $\nu'_i$  to be special. The restriction of  $G_{\mathbf{x}}^o$  to  $\underline{H}(\mathbf{x})$  is  $G_{\mathbf{x}}$ .

In this situation we define now a  $k$ -algebra  $A_{\mathbf{x}}$  and assign to each arrow  $\alpha$  of  $H^o(\mathbf{x})$  an unit  $U_{\mathbf{x}}(\alpha)$  of  $A_{\mathbf{x}}$ . In Table 3 we list the algebras  $A_{\mathbf{x}}$  and the units which are not of the form  $U_{\mathbf{x}}(\alpha) = 1_{A_{\mathbf{x}}}$ , according to the possible types of admissible words.

We observe that for  $\mathbf{x}$  of type  $(u, p)$  or of type  $(p, u)$  the  $k$ -algebra  $A_{\mathbf{x}}$  from Table 3 can be identified with the group algebra of the cyclic group  $\langle \sigma \rangle$  of order 2. It is thus isomorphic to the semisimple algebra  $k \times k$ , since  $\text{char}(k) \neq 2$ . Moreover  $A_{\mathbf{x}} \otimes k \cong X^+ \oplus X^-$ , where  $X^{\pm}$  is the one-dimensional module on which  $T$  acts  $\pm 1$ .

In Appendix A we will discuss the algebras  $A_{\mathbf{x}}$  for admissible words which contain two punctured letters, in more detail.

type of $\mathbf{x}$	$A_{\mathbf{x}}$	non triv. values of $U_{\mathbf{x}}$	autom. $\chi$	autom. $\iota$
(u,u)	$k$	-	id	id
(u,p)	$k[T]/(T^2 - 1)$	$U_{\mathbf{x}}(\eta_1) = T$	$\chi(T) = -T$	id
(p,u)	$k[T]/(T^2 - 1)$	$U_{\mathbf{x}}(\eta_0) = T$	$\chi(T) = -T$	id
(p,p)	$\frac{k\langle S, T \rangle}{\langle S^2 - 1, T^2 - 1 \rangle}$	$U_{\mathbf{x}}(\eta_0) = S, U_{\mathbf{x}}(\eta_1) = T$	$\chi(S) = -S,$ $\chi(T) = -T$	$\iota(S) = T,$ $\iota(T) = S$
(b)	$k[T, T^{-1}]$	$U_{\mathbf{x}}(\nu_0) = \begin{cases} T & \text{if } x_0 \text{ dir.} \\ T^{-1} & \text{if } x_0 \text{ inv.} \end{cases}$	$\text{id}_{k[T, T^{-1}]}$	$\iota(T) = T^{-1}$

TABLE 3. Algebras  $A_{\mathbf{x}}$ , values of  $U_{\mathbf{x}}$ , automorphism  $\chi$  and  $\iota$

If we set furthermore  $U_{\mathbf{x}}(i) = A_{\mathbf{x}}$  for each vertex  $i \in \underline{H}_o^o(\mathbf{x})$ , we see that  $U_{\mathbf{x}}$  defines an  $k\underline{H}^o(\mathbf{x})$ - $A_{\mathbf{x}}$ -bimodule, which we denote, by a slight abuse of notation, also by  $U_{\mathbf{x}}$ . It is free as an  $A_{\mathbf{x}}$ -right module. On the other hand, since the morphism of polarized quivers  $G_{\mathbf{x}}^o: \underline{H}^o(\mathbf{x}) \rightarrow \underline{Q}$  sends ordinary arrows to ordinary arrows, it induces an exact push-forward functor

$$G_{\mathbf{x}, \lambda}^o: k\underline{H}^o\text{-mod} \rightarrow k\underline{Q}\text{-mod},$$

which is defined on a representation  $M$  of  $k\underline{H}^o(\mathbf{x})$  as

$$(G_{\mathbf{x}, \lambda} M)(a) := \bigoplus_{l \in G_{\mathbf{x}}^{-1}(a)} M(l) \quad \text{for } a \text{ either an arrow or a vertex of } \underline{Q}.$$

All together we obtain for each  $\mathbf{x} \in \text{Adm}(\underline{Q})$  a functor

$$M_{\mathbf{x}}^o: A_{\mathbf{x}}\text{-mod} \rightarrow k\underline{Q}\text{-mod}, X \mapsto G_{\mathbf{x}, \lambda}^o(U_{\mathbf{x}} \otimes_{A_{\mathbf{x}}} X).$$

**Remark 5.1.** Between the representations of  $k\underline{Q}$  of the form  $M_{\mathbf{x}}^o(X)$  there are a few obvious isomorphisms, which come from isomorphisms between the underlying quivers.

- If  $\mathbf{x} \in \text{Adm}_s(\underline{Q})$ , then  $M_{\mathbf{x}}^o(X)$  and  $M_{\mathbf{x}-1}^o(X)$  are naturally isomorphic. If  $\mathbf{x} \in \text{Adm}(\underline{Q})$  is of type  $(p, p)$ , then  $M_{\mathbf{x}}^o(X)$  and  $M_{\mathbf{x}-1}^o(X')$  are naturally isomorphic. Here,  $X'$  is obtained from  $X$  by twisting with the automorphism of  $A_{\mathbf{x}}$ , which swaps  $S$  and  $T$ . See Definition 3.2 for the definition of  $\text{Adm}_s(\underline{Q})$ .

- If  $\mathbf{x} \in \text{Adm}(\underline{Q})$  and  $\mathbf{x}' \in [\mathbf{x}]$ , then  $M_{\mathbf{x}}^o(X)$  and  $M_{\mathbf{x}'}^o(X)$  are naturally isomorphic. Moreover, in this case  $M_{\mathbf{x}^{-1}}^o(X)$  is naturally isomorphic to  $M_{\mathbf{x}}^o(X^\iota)$ . Here,  $X^\iota$  is obtained from  $X$  by twisting with the automorphism  $\iota$  of  $A_{\mathbf{w}}$ , which is defined in Table 3
- We have  $M_{\mathbf{x}}^o(X)^\chi \cong M_{\mathbf{x}}^o(X^{\chi'})$ , where  $\chi'$  is the automorphism  $\chi$  of  $A_{\mathbf{x}}$  from Table 3, except when  $\mathbf{x}$  is a primitive band, which contains an odd number of special letters. In that case  $\chi'(T) = -T$ . On the other hand,  $\chi$  is the canonical automorphism of  $k\underline{Q}$ , defined in Section 5.1, which changes the sign of all special loops.

This motivates the following:

**Definition 5.2.** Let  $k$  be a field with  $\text{char } k \neq 2$  and  $\underline{Q}$  a skewed-gentle polarized quiver. Then, with the notation from Definition 3.2, we set:

$$(5.1) \quad \text{Adm}^{(k)}(\underline{Q}) := \{(\mathbf{x}, X) \mid \mathbf{x} \in \text{Adm}(\underline{Q}) \text{ and } X \in A_{\mathbf{x}}\text{-ind}\},$$

$$(5.2) \quad [\text{Adm}^{(k)}(\underline{Q})] := \{([\mathbf{x}], X) \mid [\mathbf{x}] \in [\text{Adm}(\underline{Q})] \text{ and } X \in A_{\mathbf{x}}\text{-ind}\}.$$

$$(5.3)$$

Moreover, we consider the equivalence relation  $\simeq$  on  $[\text{Adm}^{(k)}(\underline{Q})]$ , which is defined by

$$([\mathbf{x}], X) \simeq ([\mathbf{x}^{-1}], X^\iota)$$

We are now ready to state the main result from [CrB89b] (see Section 3.8 in loc. cit.) for the special case of a field  $k$  with  $\text{char}(k) \neq 2$  and the choice of  $q_i(X) = X^2 - 1$  for all special loops  $\varepsilon_i$ , adapted to our notation. Recall, that module category of each skewed-gentle algebra (a special class of clannish algebras) can be embedded into the representations of a clan by adding kernels and cokernels [CrB89b, Sec. 2.5]. Moreover, recall, that in view of Proposition 3.1 we can replace the corresponding strings and bands by admissible words.

**Theorem 5.3** (Crawley-Boevey [CrB89b]). *Let  $\underline{Q}$  be a skewed-gentle polarized quiver and  $k$  a field with  $\text{char}(k) \neq 2$ . Then  $\underline{Q}$  the map*

$$\text{Adm}^{(k)}(\underline{Q}) \rightarrow k\underline{Q}\text{-mod}, (\mathbf{x}, X) \mapsto M_{\mathbf{x}}^o(X)$$

*induces a natural bijection between  $[\text{Adm}^{(k)}(\underline{Q})]/\simeq$  and the isomorphism classes of indecomposable representations of the skewed-gentle algebra  $k\underline{Q}$ .*

**Remark 5.4.** In case  $Q_1^{\text{sp}} = \emptyset$ , Theorem 5.3 is just the well-known classification of indecomposable representations of gentle algebras [AS87], which are in particular special biserial, see [BuR87], [WW85]. In this case no symmetric strings or bands occur. As observed in [GP99], in our situation ( $\text{char}(k) \neq 2$ ) the skewed-gentle algebra  $k\underline{Q}$  is Morita equivalent to a skew group algebra  $k\tilde{Q}\langle\sigma\rangle$  for a gentle polarized quiver  $\tilde{Q}$  with an involution  $\sigma$ . As hinted in [CrB88], one can deduce, with some extra effort, the above theorem from this observation, at least for  $k$  algebraically closed. See for example [AmP22], though there no effort was made to describe the indecomposable  $k\underline{Q}$ -modules explicitly.

**5.3. Description of the Homomorphisms.** Let  $\mathbf{x}, \mathbf{y} \in \text{Adm}(\underline{Q})$  and  $X \in A_{\mathbf{x}}\text{-mod}$ ,  $Y \in A_{\mathbf{y}}\text{-mod}$ . Our aim is to describe  $\text{Hom}_{k\underline{Q}}(M_{\mathbf{x}}^o(X), M_{\mathbf{y}}^o(Y))$  in terms of the quiver  $H_{\underline{Q}}(\mathbf{x}, \mathbf{y})$ . We consider

$$f = (f_i)_{i \in Q_0} \in \text{Hom}_{k\underline{Q}}(M_{\mathbf{x}}^o(X), M_{\mathbf{y}}^o(Y)) \text{ with } f_i \in \text{Hom}_k((M_{\mathbf{x}}^o(X))(i), (M_{\mathbf{y}}^o(Y))(i)),$$

such that we have

$$(5.4) \quad f_{t(\alpha)} \circ (M_{\mathbf{v}}^o(V))(\alpha) = (M_{\mathbf{w}}^o(W))(\alpha) \circ f_{s(\alpha)}$$

for each arrow  $\alpha \in Q_1$ . In view of the definition of  $M_{\mathbf{x}}^o(X)$  and  $M_{\mathbf{y}}^o(Y)$  we consider a block decomposition

$$f_i = (f_{m,l})_{(m,l) \in D(i)} \text{ for } D(i) := (G_{\mathbf{x}}^o)^{-1}(i) \times (G_{\mathbf{y}}^o)^{-1}(i),$$

where all  $f_{m,l} \in \text{Hom}_k(X, Y)$ . We observe that we have by definition

$$H_0(\mathbf{v}, \mathbf{w}) = \cup_{i \in Q_0} D(i).$$

For each long h-line  $L \in \mathcal{H}_{\underline{Q}}(\mathbf{v}, \mathbf{w})$  we define

$$(5.5) \quad \text{Hom}_{k\underline{Q}}(M_{\mathbf{x}}^o(X), M_{\mathbf{y}}^o(Y))_L := \{(f_{i,i})_{(j,i) \in H_0(\mathbf{x}, \mathbf{y})} \in \text{Hom}_{k\underline{Q}}(M_{\mathbf{x}}^o(X), M_{\mathbf{y}}^o(Y)) \mid f_{j,i} = 0 \text{ if } (j, i) \notin L_0\}.$$

We recall that the underlying graph of  $L$  is one of the type  $A_n, D'_n, \tilde{A}_n$  or  $\tilde{D}'_n$  for some  $n$ . Accordingly we define  $A_L$  to be one of the algebras from Table 3, corresponding to an asymmetric string, a symmetric string, an asymmetric band, or a symmetric band, respectively. We observe, that in this situation we have two natural injective algebra homomorphisms

$$f_{\mathbf{x}}: A_L \rightarrow A_{\mathbf{v}} \text{ and } f_{\mathbf{y}}: A_L \rightarrow A_{\mathbf{y}}.$$

In fact, if the underlying graph of  $L$  is of type  $\tilde{A}_n$  or  $\tilde{D}'_n$ , both morphisms are the identity. If  $L$  is of type  $A_n$ , both maps are just the usual structure homomorphisms of  $A_{\mathbf{x}}$  resp.  $A_{\mathbf{y}}$ . If  $L$  is of type  $D'_n$ , with loop  $(\eta_2, \eta_1)$ . We define then naturally  $f_{\mathbf{x}}(T) = U_{\mathbf{x}}(\eta_1)$  and  $f_{\mathbf{y}}(T) = U_{\mathbf{y}}(\eta_2)$ . In particular,  $A_{\mathbf{x}}$ - resp.  $A_{\mathbf{y}}$ -modules have a natural  $A_L$ -module structure.

**Theorem 5.5.** *Let  $\underline{Q}$  be a skewed-gentle polarized quiver. For  $\mathbf{x}, \mathbf{y} \in \text{Adm}(\underline{Q})$ ,  $X \in A_{\mathbf{x}}\text{-mod}$ ,  $Y \in A_{\mathbf{y}}\text{-mod}$  then*

$$(5.6) \quad \text{Hom}_{k\underline{Q}}(M_{\mathbf{x}}^o(X), M_{\mathbf{y}}^o(Y)) = \bigoplus_{L \in \mathcal{H}_{\underline{Q}}(\mathbf{x}, \mathbf{y})} \text{Hom}_{k\underline{Q}}(M_{\mathbf{x}}^o(X), M_{\mathbf{y}}^o(Y))_L \cong \bigoplus_{L' \in \mathcal{R}_{\underline{Q}}(\mathbf{x}, \mathbf{y})} \text{Hom}_{A_{L'}}(X, Y).$$

Here, for each  $L \in \mathcal{H}_{\underline{Q}}(\mathbf{x}, \mathbf{y})$  and  $(j, i) \in L_0$  the projection

$$(5.7) \quad \text{Hom}_{k\underline{Q}}(M_{\mathbf{x}}^o(X), M_{\mathbf{y}}^o(Y))_L \rightarrow \text{Hom}_{A_L}(X, Y), f \mapsto f_{j,i}$$

is a well-defined,  $k$ -linear isomorphism.

We will show this result in Section 5.4 below.

**Remark 5.6.** Recall from Proposition 4.6 that we have a natural bijection  $\iota: \mathcal{R}_{\underline{Q}}(\mathbf{v}, \mathbf{w}) \rightarrow \mathcal{H}_{\underline{Q}}(\mathbf{v}, \mathbf{w})$  from the set of real h-lines to the set of long h-lines. Thus, the isomorphism in (5.6) follows from (5.7).

**5.4. Proof of Theorem 5.5.** Since  $G_{\mathbf{v}}^o: \underline{H}^o(\mathbf{v}) \rightarrow \underline{Q}$  and  $G_{\mathbf{w}}^o: \underline{H}^o(\mathbf{w}) \rightarrow \underline{Q}$  are homomorphisms of polarized quivers, which send ordinary arrows to ordinary arrows, we can argue as in [Kr91] that equation (5.4) splits into the following system equations:

$$(5.8a) \quad f_{t(\nu), t(\mu)} \circ V(U_{\mathbf{v}}(\mu)) = W(U_{\mathbf{w}}(\nu)) \circ f_{s(\nu), s(\mu)} \quad (\nu, \mu)_+ \in H_{1,+}(\mathbf{v}, \mathbf{w}),$$

$$(5.8b) \quad f_{s(\nu), t(\mu)} = f_{t(\nu), s(\mu)} \quad (\nu, \mu)_{\times} \in H_{1,\times}(\mathbf{v}, \mathbf{w}),$$

$$(5.8c) \quad f_{t(\eta), t(\mu)} = W(U_{\mathbf{w}}(\eta)) \circ f_{s(\eta), s(\mu)} \quad (\eta, \mu)_{\oplus} \in H_{1,\oplus}(\mathbf{v}, \mathbf{w}),$$

$$(5.8d) \quad f_{s(\nu), t(\eta)} \circ V(U_{\mathbf{v}}(\eta)) = f_{t(\nu), s(\eta)} \quad (\nu, \eta)_{\ominus} \in H_{1,\ominus}(\mathbf{v}, \mathbf{w}),$$

$$(5.8e) \quad f_{j, t(\mu)} \circ V(U_{\mathbf{v}}(\mu)) = 0 \quad (j, \mu) \in H^l(\mathbf{v}, \mathbf{w}),$$

$$(5.8f) \quad 0 = W(U_{\mathbf{w}}(\nu)) \circ f_{s(\nu), i} \quad (\nu, i) \in H^r(\mathbf{v}, \mathbf{w}),$$



with

$$\begin{aligned} H^l(\mathbf{v}, \mathbf{w}) &= \{(j, \mu) \in H_0(\mathbf{w}) \times H_1(\mathbf{v}) \mid (j, t(\mu)) \in H_0(\mathbf{v}, \mathbf{w}) \setminus \{t(\nu, \mu) \mid (\nu, \mu) \in H_1(\mathbf{v}, \mathbf{w})\}\}, \\ H^r(\mathbf{v}, \mathbf{w}) &= \{(\nu, i) \in H_1(\mathbf{w}) \times H_0(\mathbf{v}) \mid (s(\nu), i) \in H_0(\mathbf{v}, \mathbf{w}) \setminus \{s(\nu, \mu) \mid (\nu, \mu) \in H_1(\mathbf{v}, \mathbf{w})\}\}. \end{aligned}$$

**Remark 5.7.** (1) We used in equations (5.8b), (5.8c) and (5.8d) that  $U_{\mathbf{x}}(\nu) = 1 = U_{\mathbf{x}}(\nu')$  if  $\nu \neq \nu'$  is a pair of special arrows in  $\underline{H}^o(\mathbf{x})$  with  $s(\nu) = t(\nu') \neq s(\nu') = t(\nu)$ .

(2) We observe, that for  $(\nu, \mu) \in H_{1,o}$ , we obtain from equation (5.4) in fact a pair of equivalent equations, and we skipped in equations (5.8c) and (5.8d) one from each such pair of equations. For example, if  $(\eta, \mu)_{\oplus} \in H_{1,o}(\mathbf{v}, \mathbf{w})$  with  $t(\eta, \mu)_{\oplus} = (j, i')$  and  $s(\eta, \mu)_{\oplus} = (j, i)$  with  $i \neq i'$ , then there is also an arrow  $\mu' \in \underline{H}_1(\mathbf{v})$  with  $s(\mu') = i'$  and  $t(\mu') = i$ . The corresponding equations become

$$f_{j,i'} = W(U_{\mathbf{w}}(\eta))f_{j,i} \quad \text{resp.} \quad f_{j,i} = W(U_{\mathbf{w}}(\eta))f_{j,i'},$$

since  $U_{\mathbf{v}}(\mu) = U_{\mathbf{v}}(\mu') = 1_{A_{\mathbf{v}}}$ . These two equations are equivalent since  $U_{\mathbf{w}}(\eta)^2 = 1_{A_{\mathbf{w}}}$ , and we skip in this case the second one in equation (5.8c).

Since the  $U_{\mathbf{v}}(\mu) \in A_{\mathbf{v}}$  and  $U_{\mathbf{w}}(\nu) \in A_{\mathbf{w}}$  are by construction units,  $V(U_{\mathbf{v}}(\mu)) \in \text{GL}(V)$  and  $W(U_{\mathbf{w}}(\nu)) \in \text{GL}(W)$ . Thus, we conclude from the system of equations (5.8) that for  $f = (f_{j,i})_{(j,i) \in H_0(\mathbf{v}, \mathbf{w})} \in \text{Hom}_{k\underline{Q}}(M_{\mathbf{v}}^o(V), M_{\mathbf{w}}^o(W))$  and  $(j, i), (j', i') \in H_0(\mathbf{v}, \mathbf{w})$  lying on the same connected component of  $H(\mathbf{v}, \mathbf{w})$  there exist  $A \in \text{GL}(V)$  and  $B \in \text{GL}(W)$  such that  $f_{j',i'} = Bf_{j,i}A^{-1}$ . In particular, if  $(j', i')$  does *not* lie on a long h-line then  $f_{j',i'} = 0$  by equations (5.8e) and (5.8f) and the definition of the red vertices in Section 4.2. This shows the first claim of Theorem 5.5, and we conclude that the projection

$$\Phi_L: \text{Hom}_{k\underline{Q}}(M_{\mathbf{v}}^o(V), M_{\mathbf{w}}^o(W))_L \rightarrow \text{Hom}_k(V, W), f \mapsto f_{j,i}$$

is injective for any long h-line  $L$  and  $(j, i) \in L_0$ . It remains to show that  $\text{Im}(\Phi_L) = \text{Hom}_{A_L}(V, W) \subset \text{Hom}_k(V, W)$ . To this end we go over the 4 possible types of  $L$ .

(A<sub>n</sub>) In this case,  $A_L = k$  and there are no restrictions on  $f_{j,i}$  since  $L$  contains no red points.

(D'<sub>n</sub>) In this case we may assume that  $(j, i) \in L_0$  is the unique vertex of  $L$  with loop  $(\eta', \eta) \in H_{1,+}(\mathbf{v}, \mathbf{w})$ . In this case equation 5.8a for  $(\eta', \eta)$  means

$$f_{j,i} \circ V(U_{\mathbf{v}}(\eta)) = W(U_{\mathbf{w}}(\eta')) \circ f_{j,i}.$$

Thus, in fact  $f_{j,i} \in \text{Hom}_{A_L}(V, W)$ .

( $\tilde{A}$ <sub>n</sub>) In this case we may assume that  $\mathbf{v} = \mathbf{w}$  is an asymmetric band and  $(j, i) = (0, 0)$ . Then the equations (5.8a) for  $(\nu_i, \nu_i)_+$  with  $i = 1, 2, \dots, n$  force  $f_{0,0} = f_{1,1}$  since  $U_{\mathbf{w}}(\nu_i) = 1$  for  $i = 1, 2, \dots, n$ . Thus equation (5.8a) for  $(\nu_0, \nu_0)_+$  implies

$$f_{0,0} \circ V(U_{\mathbf{v}}(\nu_0)) = W(U_{\mathbf{w}}(\nu_0)) \circ f_{0,0}.$$

Thus, in fact  $f_{0,0} \in \text{Hom}_{A_L}(V, W)$ .

( $\tilde{D}$ '<sub>n</sub>) In this case we may assume that  $\mathbf{v} = \mathbf{w}$  is an asymmetric band and  $(j, i) = (1, 1)$ . Then the equations (5.8a) for  $(\nu_i, \nu_i)_+$  with  $i = 1, 2, \dots, n-1$  force  $f_{1,1} = f_{n,n}$  since  $U_{\mathbf{w}}(\nu_i) = 1$  for  $i = 1, 2, \dots, n-1$ . Thus equation (5.8a) for  $(\eta_1, \eta_1)_+$  and  $(\eta_2, \eta_2)_+$  imply

$$f_{1,1} \circ V(U_{\mathbf{v}}(\eta_i)) = W(U_{\mathbf{w}}(\eta_i)) \circ f_{1,1} \quad \text{for } i = 1, 2.$$

Thus, in fact  $f_{1,1} \in \text{Hom}_{A_L}(V, W)$ .

Using the same arguments as in [Ge99, Sec. 5], we can deduce from Theorem 5.5 the following combinatorial description of the Auslander-Reiten translate in  $k\underline{Q}$ -mod:

**Corollary 5.8.** *Let  $\underline{Q}$  be a skewed-gentle polarized quiver and  $k$  a field with  $\text{char}(k) \neq 2$ . Suppose  $\mathbf{x} \in \text{Adm}(\underline{Q})$  is not a projective string, and  $X \in A_{\mathbf{x}}\text{-mod}$  indecomposable, then the Auslander-Reiten translation of  $M^o(X)$  is  $\tau_{k\underline{Q}}M_{\mathbf{x}}^o(X) \cong M_{\tau_{\underline{Q}}(\mathbf{x})}^o(X^{\mathbf{x}})$ .*

**5.5. E-invariant.** For a finite dimensional  $k$ -algebra  $A$  and  $M, N \in A\text{-mod}$  the *E-invariant* is by definition

$$E_A(M, N) := \dim_k \text{Hom}_A(M, \tau_A(N)) + \dim_k \text{Hom}_A(N, \tau_A(M))$$

Let  $\underline{Q}$  be skewed-gentle polarized quiver with fringing  $\underline{Q}^f$ ,  $k$  a field with  $\text{char}(k) \neq 2$  and  $(\mathbf{x}, X), (\mathbf{y}, Y) \in \text{Adm}^{(k)}(\underline{Q})$ . Our aim is to find a formula for  $E_{k\underline{Q}}(M_{\mathbf{x}}^o(X), M_{\mathbf{y}}^o(Y))$  in terms of the  $k$ -triples  $\mathcal{K}_{\underline{Q}^f}(\tau_f \mathbf{x}, \tau_f \mathbf{y})$  and  $\mathcal{K}_{\underline{Q}^f}(\tau_f \mathbf{y}, \tau_f \mathbf{x})$ .

**Definition 5.9.** Let  $\underline{Q}$  be a skewed-gentle polarized quiver with fringing  $\underline{Q}^f$ , and  $\mathbf{x}, \mathbf{y} \in \text{Adm}(\underline{Q})$ . We abbreviate  $\tilde{\mathbf{x}} := \tau_{\underline{Q}^f}(\mathbf{x})$  and  $\tilde{\mathbf{y}} := \tau_{\underline{Q}^f}(\mathbf{y})$ .

For  $\mathbb{T} \in \{\mathbb{A}, \mathbb{D}', \tilde{\mathbb{A}}, \tilde{\mathbb{D}}'\}$  we define the set of *K-triples of type  $\mathbb{T}$*  as follows:

$$\begin{aligned} \mathcal{K}_{\underline{Q}^f}(\tilde{\mathbf{x}}, \tilde{\mathbf{y}})_{\mathbb{T}} &:= \{[(G, \phi_q, \phi_s)] \in \mathcal{K}_{\underline{Q}^f}(\tilde{\mathbf{x}}, \tilde{\mathbf{y}}) \mid \underline{H}(G) \text{ is of type } \mathbb{T}_n \text{ for some } n\}, \\ \mathbb{T}_{\underline{Q}^f}(\mathbf{x}, \mathbf{y}) &:= \mathcal{K}_{\underline{Q}^f}(\tilde{\mathbf{x}}, \tilde{\mathbf{y}})_{\mathbb{T}} \coprod \mathcal{K}_{\underline{Q}^f}(\tilde{\mathbf{y}}, \tilde{\mathbf{x}})_{\mathbb{T}}. \end{aligned}$$

The pairs of punctured letters of type  $\mathbb{D}'$  are given by

$$\begin{aligned} \mathbb{P}_{\underline{Q}}(\mathbf{x}, \mathbf{y}) &:= \{(j, i) \in \{0, 1\} \times \{0, 1\} \mid (\eta_j, \eta_i) \in H_1^{\text{sp}}(\mathbf{y}) \times H_1^{\text{sp}}(\mathbf{x}) \text{ and} \\ &\quad G_{\mathbf{y}}(\eta_j) = G_{\mathbf{x}}(\eta_i)\} \setminus \mathbb{P}'_{\underline{Q}}(\mathbf{x}, \mathbf{y}), \text{ with} \\ \mathbb{P}'_{\underline{Q}}(\mathbf{x}, \mathbf{y}) &:= \begin{cases} \{(0, 0), (1, 1)\} & \text{if } \mathbf{x} = \mathbf{y} \in \text{AdmSt}(\underline{Q}) \\ \{(1, 0), (0, 1)\} & \text{if } \mathbf{x} = \mathbf{y}^{-1} \in \text{AdmSt}(\underline{Q}) \\ \emptyset & \text{else.} \end{cases} \end{aligned}$$

The band orientation is

$$\text{Diag}_b(\mathbf{x}, \mathbf{y}) := \begin{cases} 1 & \text{if } [\mathbf{x}] = [\mathbf{y}] \in \text{Adm}_b(\underline{Q}), \\ -1 & \text{if } [\mathbf{x}] = [\mathbf{y}^{-1}] \in \text{Adm}_b(\underline{Q}), \\ 0 & \text{else.} \end{cases}$$

**Remark 5.10.** (1) The sets  $\mathbb{T}_{\underline{Q}^f}(\mathbf{x}, \mathbf{y})$  for  $\mathbb{T} \in \{\mathbb{A}, \mathbb{D}, \tilde{\mathbb{A}}, \tilde{\mathbb{D}}'\}$  depend a priori on the choice of the fringing  $\underline{Q}^f$ . However, By Proposition 4.14 this dependence is only up to a natural bijection.

(2) If the type  $[(G, \phi_q, \phi_s)] \in \mathcal{K}_{\underline{Q}^f}(\tilde{\mathbf{x}}, \tilde{\mathbf{y}})$  belongs to  $\{\tilde{\mathbb{A}}, \tilde{\mathbb{D}}'\}$ , both  $\phi_q$  and  $\phi_s$  are isomorphisms. In particular,  $\tilde{\mathbf{x}} = \mathbf{x}$  and  $\tilde{\mathbf{y}} = \mathbf{y}$  as well as  $[\mathbf{x}] \simeq [\mathbf{y}]$ . We conclude that

$$\begin{aligned} |\tilde{\mathbb{A}}_{\underline{Q}^f}(\mathbf{x}, \mathbf{y})| \cdot |\tilde{\mathbb{D}}'_{\underline{Q}^f}(\mathbf{x}, \mathbf{y})| &= 0 \quad \text{and} \\ |\tilde{\mathbb{A}}_{\underline{Q}^f}(\mathbf{x}, \mathbf{y})| + |\tilde{\mathbb{D}}'_{\underline{Q}^f}(\mathbf{x}, \mathbf{y})| &= 2|\text{Diag}_b(\mathbf{x}, \mathbf{y})| \in \{0, 2\}. \end{aligned}$$

(3) We will see in the next Lemma that  $|\mathbb{D}_{\underline{Q}^f}(\mathbf{x}, \mathbf{y})| = |\mathbb{P}_{\underline{Q}}(\mathbf{x}, \mathbf{y})|$ , and thus

$$|\mathbb{A}_{\underline{Q}^f}(\mathbf{x}, \mathbf{y})| + |\mathbb{P}_{\underline{Q}}(\mathbf{x}, \mathbf{y})| + 2|\text{Diag}_b(\mathbf{x}, \mathbf{y})| = |\mathcal{K}_{\underline{Q}^f}(\tilde{\mathbf{x}}, \tilde{\mathbf{y}}) \cup \mathcal{K}_{\underline{Q}^f}(\tilde{\mathbf{y}}, \tilde{\mathbf{x}})|.$$

Note for now that for each admissible triple  $(G, \phi_q, \phi_s)$  with  $[(G, \phi_q, \phi_s)] \in \mathbb{D}'_{\underline{Q}^f}(\mathbf{x}, \mathbf{y})$  we have  $\underline{H}(G)_1^{\text{sp}} = \{\eta_G\}$  for the unique loop  $\eta_G$  of  $\underline{H}(G)$ .

**Lemma 5.11.** *We have a natural bijection*

$$P: \underline{D}'_{\underline{Q}^f}(\mathbf{x}, \mathbf{y}) \rightarrow \underline{P}_{\underline{Q}}(\mathbf{x}, \mathbf{y}),$$

$$[(G, \phi_q, \phi_s)] \mapsto \begin{cases} (j, i) & \text{if } (\phi_q(\eta_G), \phi_s(\eta_G)) = (\eta_i, \eta_j) \text{ and } \text{Im}(\phi_q) = \underline{H}(\mathbf{x}) \\ (i, j) & \text{if } (\phi_q(\eta_G), \phi_s(\eta_G)) = (\eta_i, \eta_j) \text{ and } \text{Im}(\phi_q) = \underline{H}(\mathbf{y}), \end{cases}$$

where  $\eta_G$  is the unique loop of  $\underline{H}(G)$  for each  $[(G, \phi_q, \phi_s)] \in \underline{D}'_{\underline{Q}^f}(\mathbf{x}, \mathbf{y})$ .

*Proof.* By construction, the elements of  $\underline{P}_{\underline{Q}}(\mathbf{x}, \mathbf{u})$  can be identified with the loops of  $H_{\underline{Q}}(\mathbf{x}, \mathbf{y})$ , which do not lie on a diagonal or a anti-diagonal of type  $D'$ . Next, we have clearly a natural bijection between the loops of  $H_{\underline{Q}}(\mathbf{x}, \mathbf{y})$  and the loops of  $H_f(\mathbf{x}, \mathbf{y})$ , see Remark 3.3. Moreover, each loop  $(\eta_j, \eta_i)$  of  $H_f(\mathbf{x}, \mathbf{y})$  with  $(i, j) \in \underline{P}_{\underline{Q}}(\mathbf{x}, \mathbf{y})$  lies on a kiss of type D. In fact, each loop  $(\eta_j, \eta_i)$  in  $H_f(\mathbf{x}, \mathbf{y})$  lies on a (possibly dual) real h-line of by Remark 4.7 (2). This real (possibly dual) h-line is in deed a (possibly dual) kiss of type  $D'$  if  $(j, i) \in E_3(\mathbf{x}, \mathbf{y})$ , by the discussion in Remark 4.7 (2). Our claim follows now from the bijection between kisses and K-triples from Proposition 4.9.  $\square$

With the notation from Definition 5.9 we have the following formula:

**Proposition 5.12.** *Let  $\underline{Q}$  be a skewed-gentle polarized quiver with fringing  $\underline{Q}^f$  and  $k$  a field with  $\text{char}(k) \neq 2$ . For  $\mathbf{x}, \mathbf{y} \in \text{Adm}(\underline{Q})$ , and  $X \in A_{\mathbf{x}}\text{-mod}$ ,  $Y \in A_{\mathbf{y}}\text{-mod}$  we have*

$$(5.9) \quad E_{k\underline{Q}}(M_{\mathbf{x}}^o(X), M_{\mathbf{y}}^o(Y)) = |\underline{A}_{\underline{Q}^f}(\mathbf{x}, \mathbf{y})| \times (\dim_k X) \cdot (\dim_k Y) + \sum_{(j,i) \in \underline{P}_{\underline{Q}}(\mathbf{x}, \mathbf{y})} \dim_k \text{Hom}_{A(j,i)}(X, Y^X) \\ + |\text{Diag}_b(\mathbf{x}, \mathbf{y})| \times (\dim_k \text{Hom}_{A_{\mathbf{x}}}(X', Y^X) + \dim_k \text{Hom}_{A_{\mathbf{x}}}(Y', X^X)),$$

where  $Z' := Z$  if  $\text{Diag}_b(\mathbf{x}, \mathbf{y}) = 1$  and  $Z' := Z^t$  if  $\text{Diag}_b(\mathbf{x}, \mathbf{y}) = -1$  for any  $Z \in A_{\mathbf{x}}\text{-mod}$ . Moreover,  $A(j, i) = k[T]/(T^2 - 1)$  comes with injective  $k$ -algebra homomorphisms  $A(j, i) \rightarrow A_{\mathbf{x}}, T \mapsto U_{\mathbf{x}}(i)$  and  $A(j, i) \rightarrow A_{\mathbf{y}}, T \mapsto U_{\mathbf{y}}(j)$ , which give  $X$  and  $Y^X$  an  $A(j, i)$ -module structure via restriction of scalars.

*Proof.* For typographical reasons we will use the following abbreviations:  $\tau := \tau_{\underline{Q}}$  and  $\tilde{\mathbf{x}} := \tau_{\underline{Q}^f}(\mathbf{x}), \tilde{\mathbf{y}} := \tau_{\underline{Q}^f}(\mathbf{y})$  as well as  $\mathcal{K}_f := \mathcal{K}_{\underline{Q}^f}$ .

By combining Corollary 5.8, Theorem 5.5 and Proposition 4.14 we calculate

$$\begin{aligned}
& \dim_k \operatorname{Hom}_{k\mathcal{Q}}(M_{\mathbf{x}}^o(X), \tau_{k\mathcal{Q}}(M_{\mathbf{y}}^o(Y))) \\
&= \dim_k \operatorname{Hom}_{k\mathcal{Q}}(M_{\mathbf{x}}^o(X), (M_{\tau(\mathbf{y})}^o(Y^\chi))) = \sum_{L' \in \mathcal{R}_{\mathcal{Q}}(\mathbf{x}, \tau(\mathbf{y}))} \dim_k \operatorname{Hom}_{A_{L'}}(X, Y^\chi) \\
&= \sum_{[(G, \phi_q, \phi_s)] \in \mathcal{K}_f(\tilde{\mathbf{x}}, \tilde{\mathbf{y}})} \dim_k \operatorname{Hom}_{A(G, \phi_q, \phi_s)}(X, Y^\chi) \\
&= |\mathcal{K}_f(\tilde{\mathbf{x}}, \tilde{\mathbf{y}})_A| \times \dim_k \operatorname{Hom}_k(X, Y^\chi) \\
&\quad + \sum_{[(G, \phi_q, \phi_s)] \in \mathcal{K}_f(\tilde{\mathbf{x}}, \tilde{\mathbf{y}})_{D'}} \dim \operatorname{Hom}_{A(G, \phi_q, \phi_s)}(X, Y^\chi) + |\operatorname{Diag}_b(\mathbf{x}, \mathbf{y})| \cdot (\dim_k \operatorname{Hom}_{A_{\mathbf{x}}}(X', Y^\chi)) \\
&= |\mathcal{K}_f(\tilde{\mathbf{x}}, \tilde{\mathbf{y}})_A| \times (\dim_k X) \cdot (\dim_k Y) \\
&\quad + \sum_{(j, i) \in \mathbb{P}_{\mathcal{Q}}^+(\mathbf{x}, \mathbf{y})} \dim_k \operatorname{Hom}_{A(j, i)}(X, Y^\chi) + |\operatorname{Diag}_b(\mathbf{x}, \mathbf{y})| \cdot (\dim_k \operatorname{Hom}_{A_{\mathbf{x}}}(X', Y^\chi)),
\end{aligned}$$

where we used in the last step Lemma 5.11 together with the notation  $\mathbb{P}_{\mathcal{Q}}^+(\mathbf{x}, \mathbf{y}) := P(\mathcal{K}_f(\tilde{\mathbf{x}}, \tilde{\mathbf{y}}))$ . Similarly, we obtain

$$\begin{aligned}
& \dim_k \operatorname{Hom}_{k\mathcal{Q}}(M_{\mathbf{y}}^o(Y), \tau_{k\mathcal{Q}}(M_{\mathbf{x}}^o(X))) \\
&= |\mathcal{K}_f(\tilde{\mathbf{y}}, \tilde{\mathbf{x}})_A| \times (\dim_k Y) \cdot (\dim_k X) \\
&\quad + \sum_{(j, i) \in \mathbb{P}_{\mathcal{Q}}^+(\mathbf{y}, \mathbf{x})} \dim_k \operatorname{Hom}_{A(j, i)}(Y, X^\chi) + |\operatorname{Diag}_b(\mathbf{y}, \mathbf{x})| \cdot (\dim_k \operatorname{Hom}_{A_{\mathbf{y}}}(Y', X^\chi)), \\
&= |\mathcal{K}_f(\tilde{\mathbf{y}}, \tilde{\mathbf{x}})_A| \times (\dim_k X) \cdot (\dim_k Y) \\
&\quad + \sum_{(j, i) \in \mathbb{P}_{\mathcal{Q}}^-(\mathbf{x}, \mathbf{y})} \dim_k \operatorname{Hom}_{A(j, i)}(X, Y^\chi) + |\operatorname{Diag}_b(\mathbf{x}, \mathbf{y})| \cdot (\dim_k \operatorname{Hom}_{A_{\mathbf{x}}}(Y', X^\chi)),
\end{aligned}$$

where we used for the second equation that  $A(j, i) \cong k[T]/(T^2 - 1)$  is a commutative semisimple algebra, and thus  $\operatorname{Hom}_{A(j, i)}(Y, X^\chi) \cong \operatorname{Hom}_{A(i, j)}(X^\chi, Y)$ , together with the fact that  $\chi$  is an automorphism of order 2. Moreover, we abbreviated  $\mathbb{P}_{\mathcal{Q}}^-(\mathbf{x}, \mathbf{y}) := P(\mathcal{K}_f(\mathbf{y}, \mathbf{x}))$ .

Summing up the two equations we obtain, in view of the definitions, the desired formula.  $\square$

**5.6. g-vectors.** Let  $A$  be a finite dimensional  $k$ -algebra over a field  $k$ , and  $S_1, S_2, \dots, S_n$  pairwise non-isomorphic representatives of the simple  $A$ -modules. In view of the formula in [AdIR14, Prp. 5.3], (see also [CeLFS15, Sec. 3.2]), we may define the  $g$ -vector of a finite-dimensional  $A$ -module  $M$  as

$$(5.10) \quad \mathbf{g}_A(M) := (\dim \operatorname{Hom}_A(S_i, \tau_A(M)) - \dim \operatorname{Hom}_A(M, S_i))_{i=1,2,\dots,n}.$$

The  $g$ -vector contains relevant information about the minimal projective presentation of  $M$ , see [AdIR14, Sec. 5.1] for more details and background. Note however, that we use the opposite sign convention for our  $g$ -vectors.

In our context,  $A = k\mathcal{Q}$  for a skewed-gentle polarized quiver, and  $k$  is a field with  $\operatorname{char}(k) \neq 2$ . In particular,  $A$  is a skewed-gentle algebra. We recall the definition of the Gabriel quiver  $\tilde{\mathcal{Q}}$  of  $k\mathcal{Q}$  from Section 5.1 and set  $\mathbf{s}_i = \mathbb{1}_{i,+}^{-1} \mathbb{1}_{i,-}$  for all  $i \in \mathcal{Q}_0$ . The modules

$$S_{(i, \rho)} := M^o(\mathbf{s}_i, V_\rho) \quad \text{with} \quad (i, \rho) \in \tilde{\mathcal{Q}}_0$$

represent the isoclasses of the simple  $k\bar{Q}$ -modules, and they are pairwise non-isomorphic. Here, we write for the sake of a uniform notation  $V_o := k$ , and  $V_\pm$  denotes the 1-dimensional  $k[T]/(T^2 - 1)$ -module on which  $T$  acts by  $\pm 1$ .

Let now  $\underline{Q} \subset \underline{Q}^f$  be a fringing of  $\underline{Q}$ , as in Section 4.8, and write for  $\mathbf{x} \in \text{Adm}(\underline{Q})$   $\tau_f \mathbf{x} := \tau_{\underline{Q}^f}(\mathbf{x})$ , see Section 3.4.

**Definition 5.13.** With the above notation, and  $i \in Q_0$ , we set

$$\begin{aligned} A_i^+(\mathbf{x}) &:= \{j \in H_0(\tau_f \mathbf{x}) \mid G_{\tau_f \mathbf{x}}(j) = i \text{ and two ordinary arrows start at } j\}, \\ A_i^-(\mathbf{x}) &:= \{j \in H_0(\tau_f \mathbf{x}) \mid G_{\tau_f \mathbf{x}}(j) = i \text{ and two ordinary arrows end at } j\}, \\ D_i^+(\mathbf{x}) &:= \{\eta_j \in H_1^{\text{sp}}(\tau_f \mathbf{x}) \mid G_{\tau_f \mathbf{x}}(\eta_j) = \varepsilon_i \text{ and } \{\alpha \in H_1^{\text{ord}}(\tau_f \mathbf{x}) \mid t(\alpha) = t(\eta_j)\} = \emptyset\}, \\ D_i^-(\mathbf{x}) &:= \{\eta_j \in H_1^{\text{sp}}(\tau_f \mathbf{x}) \mid G_{\tau_f \mathbf{x}}(\eta_j) = \varepsilon_i \text{ and } \{\beta \in H_1^{\text{ord}}(\tau_f \mathbf{x}) \mid s(\beta) = s(\eta_j)\} = \emptyset\}. \end{aligned}$$

We call the elements of  $A_i^\pm(\mathbf{x})$  the *proper sources resp. sinks of type  $i$*  of  $H(\tau_f \mathbf{x})$ . Whilst the elements of  $D_i^\pm(\mathbf{x}) \subset H_1^{\text{sp}}(\tau_f \mathbf{x}) \subset \{\eta_0, \eta_1\}$  are the *special sources resp. sinks* of  $H(\tau_f \mathbf{x})$ .

Note, that  $A_i^\pm(\mathbf{x})$  may be non-empty for any  $i \in Q_0$ . On the other hand,  $D_i^\pm(\mathbf{x})$  can be only non-empty if  $i \in Q_0^{\text{sp}}$ . Moreover,  $\sum_{\delta \in \{+, -\}} \sum_{i \in Q_0} |D_i^\delta(\mathbf{x})|$  gives the number of punctured letters of  $\mathbf{x}$ . In particular, this number is at most 2. Even if at  $i \in Q_0^{\text{sp}}$  no ordinary arrow starts, the unique special vertex of  $H(\tau_f \mathbf{s}_i)$  is a special source of type  $i$ , but *not* a special sink, due to the construction of  $\tau_f \mathbf{s}_i$ .

**Lemma 5.14.** *With the above notations we have the following:*

- (a)  $|A_i^+(\mathbf{x})|$  is the number of real h-lines of type A in  $H_{\underline{Q}}(\mathbf{x}, \mathbf{s}_i)$ .
- (b)  $|A_i^-(\mathbf{x})|$  is the number of real h-lines of type A in  $H_{\underline{Q}}(\mathbf{s}_i, \tau_{\underline{Q}} \mathbf{x})$  if  $\mathbf{x}$  is not projective, else  $A_i^-(\mathbf{x}) = \emptyset$
- (c)  $|D_i^+(\mathbf{x})|$  is the number of real h-lines of type D' in  $H_{\underline{Q}}(\mathbf{x}, \mathbf{s}_i)$ .
- (d)  $|D_i^-(\mathbf{x})|$  is the number of real h-lines of type D' in  $H_{\underline{Q}}(\mathbf{s}_i, \tau_{\underline{Q}} \mathbf{x})$  if  $\mathbf{x}$  is not projective, else  $D_i^-(\mathbf{x}) = \emptyset$ .

*Proof.* (a) By the construction of  $\tau_f$  and of  $H(\tau_f \mathbf{x})$ , the sources of  $H(\mathbf{x})$  correspond precisely to  $A_i^+$ . So our claim follows from the discussion in Example 4.10.

(b) By Proposition 4.14 the real h-lines of type A<sub>1</sub> in  $H_{\underline{Q}}(\mathbf{s}_i, \tau_{\underline{Q}} \mathbf{x})$  are in bijection with the kisses of type A<sub>1</sub> in  $H_{\underline{Q}^f}(\tau_f \mathbf{s}_i, \tau_f \mathbf{x})$ . For  $i \in Q_0^{\text{ord}}$  the quiver  $H(\tau_f \mathbf{s}_i)$  has a unique proper source, this source is of type  $i$  (possibly there are two other sources, which are of fringe type). Thus there is a unique morphism of windings from  $H(\mathbf{s}_i)$  to  $H(\tau_f \mathbf{s}_i)$ , which has properties (q) and (k) from Section 4.7. On the other hand,  $A_i^-(\mathbf{x})$  can be identified with the morphisms of winding from  $H(\mathbf{s}_i)$  to  $H(\tau_f \mathbf{x})$  which have properties (s) and (k). Now, our claim follows from Proposition 4.9.

(c) It is easy to see that the real h-lines of type D' in  $H(\tau_f \mathbf{x}, \mathbf{s}_i)$  can be identified with the real h-lines of type D' in  $H(\mathbf{x}, \mathbf{s}_i)$ . Thus our claim follows from the discussion at the end of Example 4.10.

(d) By Proposition 4.14 the real h-lines of type A<sub>1</sub> in  $H_{\underline{Q}}(\mathbf{s}_i, \tau_{\underline{Q}} \mathbf{x})$  are in bijection with the kisses of type A<sub>1</sub> in  $H_{\underline{Q}^f}(\tau_f \mathbf{s}_i, \tau_f \mathbf{x})$ . For  $i \in Q_0^{\text{sp}}$  the quiver  $H(\tau_f \mathbf{s}_i)$  has a unique (special) loop, say at 1 and a unique ordinary arrow starts at 1. In view of the discussion at the end of Example 4.10, we can now conclude as in (b).  $\square$

**Proposition 5.15.** *Let  $\underline{Q}$  be a skewed-gentle, polarized quiver with fringing  $\underline{Q}^f$  and  $k\bar{Q}$  the corresponding skewed-gentle algebra over a field  $k$  with  $\text{char}(k) \neq 2$ . For  $\mathbf{x} \in \text{Adm}(\underline{Q})$*

and  $X \in A_{\mathbf{x}}\text{-mod}$  we have

$$(5.11) \quad \mathbf{g}_{kQ}(M^o(\mathbf{x}, X))_{(i,\rho)} = (|A_i^-(\mathbf{x})| - |A_i^+(\mathbf{x})|) \times \dim X$$

$$(5.12) \quad \sum_{\eta_j \in D_i^-} \dim \text{Hom}_{A(\eta_j)}(V_\rho, X^\chi) - \sum_{\eta_j \in D_i^+} \dim \text{Hom}_{A(\eta_j)}(X, V_\rho),$$

where  $A(\eta_j) = k[T]/(T^2 - 1)$ , and we have an algebra homomorphism  $A(\eta_j) \rightarrow A_{\tau_f \mathbf{x}}, T \mapsto U_{\tau_f \mathbf{x}}(\eta_j)$ . This gives  $X \in A_{\tau_f \mathbf{x}}\text{-mod}$ , via restriction, an  $A(\eta)$ -module structure.

*Proof.* In view of Formula (5.10) and Theorem 5.5, this follows indeed from our Lemma.  $\square$

**Example 5.16.** Consider the skewed-gentle polarized quiver  $\underline{Q}$  from Example 2.7 with the first fringing  $\underline{Q}^f$  from Section 4.8. We calculate the  $\mathbf{g}$ -vectors

$$\mathbf{g}(M) = (\mathbf{g}_{1,o}, \mathbf{g}_{2,-}, \mathbf{g}_{2,+}, \mathbf{g}_{3,o}) \in \mathbb{Z}^4$$

of some indecomposable finite dimensional  $kQ$ -modules  $M$  with  $\mathbf{x} \in \text{Adm}(\underline{Q})$ .

- $\mathbf{v} = \mathbb{1}_{1,-}^{-1} \gamma \beta \varepsilon^* \beta^{-1} \mathbb{1}_{3,+} \in \text{St}(\underline{Q})$  In this case  $\mathbf{x} := A(\mathbf{w}) = \mathbb{1}_{1,-}^{-1} \gamma \beta \varepsilon \beta^{-1} \mathbb{1}_{3,+} \in \text{Adm}(\underline{Q})$  and  $\tau_f \mathbf{x} = \mathbb{1}_{6,-}^{-1} \phi_{6,1} \gamma \beta \varepsilon \beta^{-1} \gamma^{-1} \phi_{1,5} \mathbb{1}_{5,-}$ .

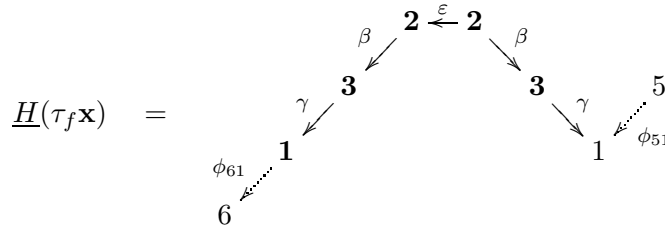

In the above display we label vertices and arrows by their image under  $G_{\tau_f \mathbf{x}}$ . The **bold** vertices support the subquiver  $\underline{H}(\mathbf{x})$ . Since  $\mathbf{x}$  is of type  $(u, u)$  (and correspondingly  $\mathbf{w}$  an asymmetric string)  $A_{\mathbf{x}} = k$  and thus  $X = k$  is the only choice. We see that we have one proper source of type 2 and one proper sink of type 1. Thus  $\mathbf{g}(M^o(\mathbf{x}, k)) = (-1, 1, 1, 0)$ , according to our Corollary.

- $\mathbf{w} = \mathbb{1}_{1,-}^{-1} \alpha^{-1} \varepsilon^* \alpha \mathbb{1}_{1,-} \in \text{St}(\underline{Q})$  is a symmetric string and correspondingly  $\mathbf{y} := A(\mathbf{w}) = \mathbb{1}_{2,-}^{-1} \alpha \mathbb{1}_{1,-} \in \text{Adm}(\underline{Q})$  is of type  $(p, u)$ . Consequently  $\tau_f \mathbf{y} = \alpha \phi_{6,1}^{-1} \mathbb{1}_{6,-}$

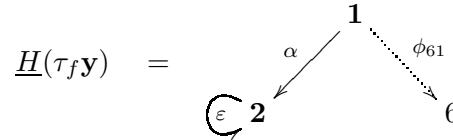

In this case we have a proper source of type 1 and a special sink of type 2. Thus, we get from our Corollary

$$\mathbf{g}(M^o(\mathbf{y}, X^+)) = (1, -1, 0, 0) \quad \text{and} \quad \mathbf{g}(M^o(\mathbf{y}, X^-)) = (1, 0, -1, 0),$$

since  $A_{\mathbf{y}} = k[T]/(T^2 - 1)$  and  $X^\pm \cong V^\pm$  are the two isomorphism classes of indecomposable (simple)  $A_{\mathbf{y}}$ -modules.

## 6. INDECOMPOSABLE GENERICALLY $\tau$ -REDUCED IRREDUCIBLE COMPONENTS

**6.1. Generically  $\tau$ -reduced irreducible components for tame algebras.** Let  $k$  be an algebraically closed field,  $Q$  a finite quiver and  $I < kQ$  an admissible ideal. Then  $A := kQ$  is a finite dimensional basic  $k$ -algebra with Grothendieck group  $K_0(A) \cong \mathbb{Z}^{Q_0}$ . In this context we consider for each dimension vector  $\mathbf{d} \in \mathbb{N}^{Q_0}$  the affine  $k$ -scheme  $\text{rep}_A^{\mathbf{d}}$

of representations with dimension vector  $\mathbf{d}$ . The algebraic group  $G_{\mathbf{d}} := \times_{i \in Q_0} \mathrm{GL}_{\mathbf{d}(i)}(k)$  acts on the  $k$ -rational points  $\mathrm{rep}_A^{\mathbf{d}}(k)$  by conjugation, and the orbits are in one to one correspondence with the isoclasses of representations of  $A$  with dimension vector  $\mathbf{d}$ . For  $M \in \mathrm{rep}_A^{\mathbf{d}}(k)$  we write  $\mathcal{O}_M \subset \mathrm{rep}_A^{\mathbf{d}}$  for the  $G_{\mathbf{d}}$ -orbit  $G_{\mathbf{d}}M$ .

We denote by  $\mathrm{Irr}(A, \mathbf{d})$  the set of irreducible components of  $\mathrm{rep}_A^{\mathbf{d}}$  and

$$\mathrm{Irr}(A) := \cup_{\mathbf{d} \in \mathbb{N}^{Q_0}} \mathrm{Irr}(A, \mathbf{d}).$$

A component  $Z \in \mathrm{Irr}(A)$  is called *indecomposable* if it contains a dense subset of indecomposable representations of  $A$ . It is well known, that on each  $Z \in \mathrm{Irr}(A)$  the function  $Z \rightarrow \mathbb{N}, M \mapsto \mathrm{codim}_Z(\mathcal{O}_M)$  is upper semicontinuous. Thus,

$$c(Z) := \min\{\mathrm{codim}_Z(\mathcal{O}_M) \mid M \in Z\}$$

is the generic value of the codimension of orbits in  $Z$ .

For  $X, Y \in \mathrm{Irr}(A)$  the function

$$E_A: X \times Y \rightarrow \mathbb{N}, (M, N) \mapsto \dim \mathrm{Hom}_A(M, \tau N) + \dim \mathrm{Hom}_A(N, \tau M)$$

is upper semicontinuous by [GLFS23, Cor. 1.4], and thus

$$e_A(X, Y) := \min\{E_A(M, N) \mid (M, N) \in X \times Y\}$$

is the generic value of  $E_A$  on  $X \times Y$ . It will be convenient to consider also the generic value

$$e_A(Z) := \min\{1/2E_A(M, M) \mid M \in Z\} \in \mathbb{N}$$

We write

$$\mathrm{Irr}^{\tau}(A) := \{Z \in \mathrm{Irr}(A) \mid c(Z) = e_A(Z)\}$$

for the set of *generically  $\tau$ -reduced* irreducible components. and  $\mathrm{Irr}_{\mathrm{ind}}^{\tau}(A)$  is the subset of generically  $\tau$ -reduced irreducible components which are indecomposable. With the help of the generic E-invariant  $e_A$  it is possible to write each  $Z \in \mathrm{Irr}^{\tau}(A)$  in an essentially unique way as an direct sum of *indecomposable*, generically  $\tau$ -reduced irreducible components. See [CeLFS15, Sec. 5.2] for more details. The indecomposable, generically  $\tau$ -reduced irreducible components of a *tame* algebra have a convenient characterization by [GLFS22, Sec. 3] and [GLFS23, Thm. 1.5]:

**Proposition 6.1.** *Suppose that  $A = kQ/I$  as above is tame. Then the following holds:*

- (a) *For each  $Z \in \mathrm{Irr}^{\tau}(A)$  we have  $e_A(Z, Z) = 0$ .*
- (b) *If  $M \in A\text{-mod}$  is indecomposable with  $E_A(M, M) = 0$ , then the (Zariski) orbit closure  $Z := \overline{\mathcal{O}_M}$  belongs to  $\mathrm{Irr}_{\mathrm{ind}}^{\tau}(A)$ , and  $c(Z) = 0$ .*
- (c) *If  $C \subset \mathrm{rep}_A^{\mathbf{d}}(k)$  is an irreducible curve which intersects infinitely many  $G_{\mathbf{d}}$ -orbits of bricks, then*

$$Z := \overline{\cup_{X \in C} \mathcal{O}_X} \in \mathrm{Irr}_{\mathrm{ind}}^{\tau}(A)$$

*and  $c(Z) = 1$ .*

- (d) *Let  $Z \in \mathrm{Irr}_{\mathrm{ind}}^{\tau}(A)$ , then we have  $e(Z) \in \{0, 1\}$ . If  $e(Z) = 0$  then  $Z$  is of the form described in (b), else  $Z$  is of the form described in (c).*

**6.2. Combinatorial description.** In this section we fix a skewed-gentle polarized quiver  $\underline{Q}$  with fringing  $\underline{Q}^f$  and  $k$ , an algebraically closed field with  $\mathrm{char} k \neq 2$ . We identify the skewed-gentle algebra  $k\underline{Q}$  along the isomorphism  $\phi_Q$  with  $k\tilde{Q}/\tilde{\mathcal{R}}$  as in Section 5.1. In particular we identify the dimension vectors of representations of  $k\underline{Q}$  with vectors in  $\mathbb{N}^{\tilde{Q}_0}$ .

For each  $\mathbf{x} \in \text{Adm}(\underline{Q})$  we define a subset of  $S := (\{-1, 1\} \times \{-1, 1\}) \cup \{*, (*, *)\}$ :

$$S(\mathbf{x}) := \begin{cases} \{(1, 1)\} & \text{if } \text{type}(\mathbf{x}) = (u, u), \\ \{(1, -1), (1, 1)\} & \text{if } \text{type}(\mathbf{x}) = (u, p), \\ \{(-1, 1), (1, 1)\} & \text{if } \text{type}(\mathbf{x}) = (p, u), \\ \{1, -1\}^2 \cup \{(*, *)\} & \text{if } \text{type}(\mathbf{x}) = (p, p), \\ \{*\} & \text{if } \text{type}(\mathbf{x}) = (b). \end{cases}$$

For later use we introduce several operations on the elements of  $S$ , namely

$$\begin{aligned} \text{wt}(s) &:= \begin{cases} 2 & \text{if } s = (*, *), \\ 1 & \text{else,} \end{cases} & (s_1, s_2) &:= s \text{ for } s \in S \setminus \{*\}, \\ s^t &:= \begin{cases} (s_2, s_1) & \text{if } s \in \{-1, 1\}^2, \\ s & \text{else} \end{cases}, & s^x &:= \begin{cases} (-s_1, -s_2) & \text{if } s \in \{-1, 1\}^2, \\ s & \text{else.} \end{cases} \end{aligned}$$

With this at hand we introduce with the notation from Definition 3.2 the (equivalence classes of) *tagged admissible words*

$$\begin{aligned} \text{Adm}^*(\underline{Q}) &:= \{(\mathbf{x}, s) \mid \mathbf{x} \in \text{Adm}(\underline{Q}) \text{ and } s \in S(\mathbf{x})\}, \text{ and} \\ [\text{Adm}^*(\underline{Q})] &:= \{(\mathbf{x}, s) \in \text{Adm}(\underline{Q}) \mid \mathbf{x} \in \text{AdmSt}(\underline{Q})\} \cup [\text{AdmBa}(\underline{Q})] \times \{*\}. \end{aligned}$$

We introduce on  $[\text{Adm}^*(\underline{Q})]$  an equivalence relation  $\simeq$  by declaring  $(\mathbf{x}^{-1}, s^t) \simeq (\mathbf{x}, s)$ . Next we introduce for each  $(\mathbf{x}, s) \in \text{Adm}^*(\underline{Q})$  a set of simple  $A_{\mathbf{x}}$ -modules as follows:

$$C(\mathbf{x}, s) := \begin{cases} \{V_o\} & \text{if } \text{type}(\mathbf{x}) = (u, u), \\ \{V_\delta\} & \text{if } \text{type}(\mathbf{x}) = (u, p) \text{ and } s = (1, \delta 1), \\ \{V_\delta\} & \text{if } \text{type}(\mathbf{x}) = (p, u) \text{ and } s = (\delta 1, 1), \\ \{W_{(1;i,j)}^{\chi^{(1-i)/2}}\} & \text{if } \text{type}(\mathbf{x}) = (p, p) \text{ and } s = (i, j) \in \{1, -1\}^2, \\ \{\tilde{V}_{(1,t)} \mid t \in k^* \setminus \{-1, 1\}\} & \text{if } \text{type}(\mathbf{x}) = (p, p) \text{ and } s = (*, *), \\ \{V_{(1,t)} \mid t \in k^*\} & \text{if } \text{type}(\mathbf{x}) = (b), \end{cases}$$

where we used the notations from the beginning of Section 5.6, and from Appendix A. In particular, for  $R := k\langle S, T \rangle / (S^2 - 1, T^2 - 1)$  and the 1-dimensional  $R$ -module  $W_{(1;i,j)}^{\chi^{(1-i)/2}}$  we have  $W_{(1;i,j)}^{\chi^{(1-i)/2}}(S) = i$  and  $W_{(1;i,j)}^{\chi^{(1-i)/2}}(T) = j$ .

Note that for all  $\mathbf{x} \in \text{Adm}(\underline{Q})$  the set  $\cup_{s \in S(\mathbf{x})} C(\mathbf{x}, s)$  covers all isomorphism classes of simple  $A_{\mathbf{x}}$ -modules. Note moreover that we may see  $C(\mathbf{x}, s)$  as an affine curve when  $s \in \{*, (*, *)\}$ .

We observe that for  $(\mathbf{x}, s) \in \text{Adm}_*(\underline{Q})$  there exists  $\mathbf{d}(\mathbf{x}, s) \in \mathbb{Z}_{\geq 0}^{\tilde{Q}_0}$  such that

$$\mathbf{d}(\mathbf{x}, s) = \underline{\dim} M_{\mathbf{x}}^o(X) \text{ for all } X \in C(\mathbf{x}, s).$$

**Definition 6.2.** With the notations from Section 5.5 and from Section 5.6 we define for  $(\mathbf{x}, s), (\mathbf{y}, t) \in \text{Adm}^*(\underline{Q})$  and  $(i, \rho) \in \tilde{Q}_0$  the *combinatorial E-invariant* and *combinatorial*



$g$ -vector:

$$(6.1) \quad \begin{aligned} e_{\underline{Q}}((\mathbf{x}, s), (\mathbf{y}, t)) &= |A_{\underline{Q}^f}(\mathbf{x}, \mathbf{y})| \times \text{wt}(s) \cdot \text{wt}(t) \\ &+ \sum_{(j,i) \in P_{\underline{Q}}(\mathbf{x}, \mathbf{y})} d_2(s_i, (t^X)_j) + 2|\text{Diag}_b(\mathbf{x}, \mathbf{y})| \cdot d_3(s', t^X) \in \mathbb{N}, \end{aligned}$$

$$(6.2) \quad \begin{aligned} \mathbf{g}_{\underline{Q}}(\mathbf{x}, s)_{(i,\rho)} &= (|A_i^-(\mathbf{x})| - |A_i^+(\mathbf{x})|) \times \text{wt}(s) \\ &+ \sum_{\eta_j \in D_i^-(\mathbf{x})} d_2(\rho \cdot 1, -s_{j+1}) - \sum_{\eta_j \in D_i^+(\mathbf{x})} d_2(s_{j+1}, \rho \cdot 1) \in \mathbb{Z}, \end{aligned}$$

where we use additionally the functions  $d_2: \{-1, 1, *\}^2 \rightarrow \{0, 1, 2\}$ ,  $d_3: S^2 \rightarrow \{0, 1\}$ , which are defined as follows:

$d_2$	$-1$	$1$	$*$
$-1$	$1$	$0$	$1$
$1$	$0$	$1$	$1$
$*$	$1$	$1$	$2$

$$d_3(s, t) := \begin{cases} 1 & \text{if } s = t \in \{-1, 1\}^2, \\ 0 & \text{else.} \end{cases}$$

Moreover, we agree that  $s' = (s_2, s_1)$  if  $\text{Diag}_b(\mathbf{x}, \mathbf{y}) = -1$  and  $s' = s$  else.

We will need also the crucial subset

$$(6.3) \quad \text{Adm}_\tau^*(\underline{Q}) := \{(\mathbf{x}, s) \in \text{Adm}^*(\underline{Q}) \mid e_{\underline{Q}}((\mathbf{x}, s), (\mathbf{x}, s)) = 0\}$$

of  $\tau$ -generic pairs in  $\text{Adm}^*(\underline{Q})$ .

We also consider the Zariski closure

$$(6.4) \quad \overline{M}_{(\mathbf{x}, s)}^o := \overline{\cup_{X \in C(\mathbf{x}, s)} \mathcal{O}_{M_{\underline{Q}}^2(X)}} \subset \text{rep}_{k\underline{Q}}^{\mathbf{d}(\mathbf{x}, s)}(k).$$

**Remark 6.3.** (1) For each  $(\mathbf{x}, s) \in \text{Adm}^*(\underline{Q})$  the closed set  $\overline{M}_{(\mathbf{x}, s)}^o \subset \text{rep}_{k\underline{Q}}^{\mathbf{d}(\mathbf{x}, s)}(k)$  contains, by Crawley-Boevey's Theorem 5.3 the union of orbits

$$\cup_{V \in S(\mathbf{x}, s)} \mathcal{O}_{M_{\underline{Q}}^2(V)}$$

as an irreducible, dense subset of *indecomposable* representations. It consists of infinitely many orbits if and only if  $s \in \{*, (*, *)\}$ . In particular, each  $\overline{M}_{(\mathbf{x}, s)}^o$  is irreducible. Moreover, we have by the same theorem

$$\overline{M}_{(\mathbf{x}, s)}^o = \overline{M}_{(\mathbf{y}, t)}^o \iff [(\mathbf{x}, s)] = [(\mathbf{y}, t)].$$

(2) The functions  $e_{\underline{Q}}$  resp.  $\mathbf{g}_{\underline{Q}}$  descend obviously to  $([\text{Adm}^*(\underline{Q})]/\simeq) \times ([\text{Adm}^*(\underline{Q})]/\simeq)$  resp. to  $[\text{Adm}^*(\underline{Q})]/\simeq$ . In particular, the subset  $[\text{Adm}_\tau^*(\underline{Q})]/\simeq$  of  $[\text{Adm}^*(\underline{Q})]/\simeq$  is well defined.

**Theorem 6.4.** *Let  $\underline{Q}$  be a skewed-gentle polarized quiver and  $k$  an algebraically closed field with  $\text{char}(k) \neq 2$ .*

(a) *We have the following equalities:*

$$\begin{aligned} e_{k\underline{Q}}(\overline{M}_{(\mathbf{x}, s)}^o, \overline{M}_{(\mathbf{y}, t)}^o) &= e_{\underline{Q}}((\mathbf{x}, s), (\mathbf{y}, t)) \text{ for all } (\mathbf{x}, s), (\mathbf{y}, t) \in \text{Adm}^*(\underline{Q}), \\ e_{k\underline{Q}}(\overline{M}_{(\mathbf{x}, s)}^o) &= \begin{cases} 1/2e_{\underline{Q}}((\mathbf{x}, s), (\mathbf{x}, s)) & \text{if } s \in \{-1, 1\}^2 \\ 1/2e_{\underline{Q}}((\mathbf{x}, s), (\mathbf{x}, s)) + 1 & \text{if } s \in \{*, (*, *)\} \end{cases} \text{ and} \\ \mathbf{g}_{k\underline{Q}}(\overline{M}_{(\mathbf{x}, s)}^o) &= \mathbf{g}_{\underline{Q}}(\mathbf{x}, s) \text{ for each } (\mathbf{x}, s) \in \text{Adm}^*(\underline{Q}). \end{aligned}$$

*In other words, the combinatorial  $E$ -invariant and combinatorial  $g$ -vector calculate the generic values of the (algebraic)  $E$ -invariant and  $g$ -vector on the closed subsets of the form  $\overline{M}_{(\cdot)}^o$ .*

(b) The set  $\text{Adm}_\tau^*(\underline{Q})$  has the following simplified description:

$$\begin{aligned} \text{Adm}_\tau^*(\underline{Q}) &= \{(\mathbf{x}, s) \in \text{Adm}^*(\underline{Q}) \mid \mathbf{x} \in \text{Adm}_\tau(\underline{Q}) \text{ and } s \in S'(\mathbf{x})\}, \quad \text{where} \\ \text{Adm}_\tau(\underline{Q}) &:= \{\mathbf{x} \in \text{Adm}(\underline{Q}) \mid \mathbf{A}_{\underline{Q}^f}(\mathbf{x}, \mathbf{x}) = \emptyset\}, \\ S'(\mathbf{x}) &:= \begin{cases} \{(-1, -1), (1, 1)\} & \text{if } \mathbf{x} = \mathbb{1}_{p,-}^{-1} \mathbf{x}' \mathbb{1}_{p,-} \text{ for some } p \in Q_0^{\text{sp}}, \\ S(\mathbf{x}) & \text{else.} \end{cases} \end{aligned}$$

(c) The construction  $\overline{M}_\tau^o$  induces a bijection

$$([\text{Adm}_\tau^*(\underline{Q})]/\simeq) \rightarrow \text{Irr}_{\text{ind}}^\tau(k\underline{Q}), \quad [(\mathbf{x}, s)] \mapsto \overline{M}_{(\mathbf{x}, s)}^o.$$

*Proof.* (a) Tracking back the definitions, and by comparing with the the formulae for the E-invariant (5.9) and the g-vector (5.11) these equalities follow easily.

(b) When we calculate  $e_{\underline{Q}}((\mathbf{x}, s), (\mathbf{x}, s))$  with the formula (5.9), we see that for  $(\mathbf{x}, s) \in \text{Adm}_\tau^*(\underline{Q})$  necessarily  $\mathbf{A}_{\underline{Q}^f}(\mathbf{x}, \mathbf{x}) = 0$ , or in other words  $\mathbf{x} \in \text{Adm}_\tau(\underline{Q})$ . On the other hand, there is no contribution from the  $\text{Diag}_b$ -summand. In fact, we have  $\text{Diag}_b(\mathbf{x}, \mathbf{x}) = 0$  or  $d_3(s, s^X) = 0$ .

From Definition 5.9 we see that  $\mathbf{P}_{\underline{Q}}(\mathbf{x}, \mathbf{x}) = \{(0, 1), (1, 0)\}$  if  $\mathbf{x} = \mathbb{1}_{p,-}^{-1} \mathbf{x}' \mathbb{1}_{p,-}^{-1}$  for some  $p \in Q_0^{\text{sp}}$ . Else  $\mathbf{P}_{\underline{Q}}(\mathbf{x}, \mathbf{x}) = \emptyset$ . Thus we see from the definition of  $d_2$  that in the first case it is necessary and sufficient to have  $s \in \{(1, 1), (-1, -1)\}$  whilst otherwise there is no restriction on  $s$  in order to have  $e((\mathbf{x}, s), (\mathbf{x}, s)) = 0$ .

(c) (i) We claim that for  $(\mathbf{x}, s) \in \text{Adm}^*(\underline{Q})$  we have  $\overline{M}_{(\mathbf{x}, s)}^o \in \text{Irr}_{\text{ind}}^\tau(\underline{Q})$  if and only of  $(\mathbf{x}, s) \in \text{Adm}_\tau^*(\underline{Q})$ .

In fact, suppose first  $\overline{M}_{(\mathbf{x}, s)}^o \in \text{Irr}_{\text{ind}}^\tau(k\underline{Q})$ . Since  $k\underline{Q}$  is tame, we must have by Proposition 6.1 (a) and Part (a) of our theorem

$$0 = e_{k\underline{Q}}(\overline{M}_{(\mathbf{x}, s)}^o, \overline{M}_{(\mathbf{x}, s)}^o) = e_{\underline{Q}}((\mathbf{x}, s), (\mathbf{x}, s)),$$

and thus by definition  $(\mathbf{x}, s) \in \text{Adm}_\tau^*(\underline{Q})$ .

Suppose next that  $(\mathbf{x}, s) \in \text{Adm}_\tau^*(\underline{Q})$ . If  $s \notin \{*, (*, *)\}$ , we have  $C(\mathbf{x}, s) = \{X\}$  for a one-dimensional  $A_{\mathbf{x}}$ -module  $X$ , and thus by definition  $\overline{M}_*^o(\mathbf{x}, s) = \overline{\mathcal{O}_{M_{\mathbf{x}}^o(X)}}$ . In this case we have  $0 = e((\mathbf{x}, s), (\mathbf{x}, s)) = e(\mathbf{x}, s) = E_{k\underline{Q}}(M_{\mathbf{x}}^o(X))$  for the indecomposable  $k\underline{Q}$ -module  $M_{\mathbf{x}}^o(X)$ . Thus  $\overline{M}_*^o(\mathbf{x}, s)$  is a generically  $\tau$ -reduced indecomposable irreducible component with a dense orbit by Proposition 6.1 (b). On the other hand, for  $s \in \{*, (*, *)\}$  we have  $\mathbf{x} \in \text{Adm}_b(\underline{Q})$  and the set  $C(\mathbf{x}, s)$  consists of infinitely many isomorphism classes of simple  $A_{\mathbf{x}}$ -modules  $X$  with  $X^X \cong X$ . Moreover we have  $\mathbf{P}_{\underline{Q}}(\mathbf{x}, \mathbf{x}) = \emptyset$  by the discussion in the proof of (b). On the other hand, it follows then from Corollary 5.8 that  $\tau_{k\underline{Q}} M_{\mathbf{x}}^o(X) \cong M_{\mathbf{x}}^o(X)$  is an indecomposable  $k\underline{Q}$ -module for all  $X \in C(\mathbf{x}, s)$ . Thus we have

$$\dim \text{End}_{k\underline{Q}}(M_{\mathbf{x}}^o(X)) = \dim \text{Hom}_{k\underline{Q}}(M_{\mathbf{x}}^o(X), \tau_{k\underline{Q}} M_{\mathbf{x}}^o(X)) = \dim \text{Hom}_{A_{\mathbf{x}}}(X, X) = 1$$

by the formula for the E-invariant in Proposition 5.12. Thus, for  $(\mathbf{x}, s) \in \text{Adm}_\tau^*(\underline{Q})$  with  $s \in \{*, (*, *)\}$  the curve  $M_{\mathbf{x}}^o(X)_{X \in C(\mathbf{x}, s)}$  intersects infinitely many orbits of bricks and  $\overline{M}_{(\mathbf{x}, s)}^o \in \text{Irr}_{\text{ind}}^\tau(\underline{Q})$  by Proposition 6.1 (c).

(ii) In view of Remark 6.3, we conclude that the restriction  $\overline{M}_\tau^o: ([\text{Adm}_\tau^*(\underline{Q})]/\simeq) \rightarrow \text{Irr}_{\text{ind}}^\tau(k\underline{Q})$  is well-defined and injective.

(iii) For the surjectivity we observe first, that for each  $\mathbf{x} \in \text{Adm}(\underline{Q})$  the set  $\cup_{s \in S(\mathbf{x})} C(\mathbf{x}, s)$  covers precisely all isomorphism classes of *simple*  $A_{\mathbf{x}}$ -module. If  $X \in A_{\mathbf{x}}$ -ind is not simple,

we must have  $\mathbf{x} \in \text{Adm}_b(Q)$ . It is not difficult to deduce, with the help of Appendix A, that for such  $X$  one of the following two possibilities occurs:

- (i)  $X \not\cong X^\chi$  and  $\dim \text{Hom}_{A_{\mathbf{x}}}(X, X^\chi) \geq 1$ .
- (ii)  $X \cong X^\chi$  and  $\dim \text{Hom}_{A_{\mathbf{x}}}(X, X) \geq 2$ .

Thus, by Proposition 5.12 we have in both cases  $E_{kQ}(M_{\mathbf{x}}^0(X), M_{\mathbf{x}}^o(X)) \neq 0$ . This means that  $\overline{O_{M_{\mathbf{x}}^o(X)}}$  can't be of the form  $Z \in \text{Irr}_{\text{ind}}^\tau(kQ)$  with  $c(Z) = 0$ . On the other hand we have in case (i)  $\tau_{kQ} M_{\mathbf{x}}^0(X) \not\cong M_{\mathbf{x}}^0(X)$  by Corollary 5.8, and  $E(M_{\mathbf{x}}^o(X), M_{\mathbf{x}}^o(X)) = \dim \text{End}_{kQ}(M_{\mathbf{x}}^o(X)) \geq 2$  in case (ii). Thus,  $M_{\mathbf{x}}^o(X)$  does not belong to any of the curves which appear in the characterization of the  $Z \in \text{Irr}_{\text{ind}}^\tau(kQ)$  with  $c(Z) = 1$  in Proposition 6.1. We conclude, by the same proposition and the classification result Theorem 5.3, that each  $Z \in \text{Irr}_{\text{ind}}^\tau(kQ)$  is of the form  $\overline{M_{\mathbf{x}}^o(\mathbf{x}, s)}$  for some  $(\mathbf{x}, s) \in \text{Adm}^*(Q)$ .  $\square$

#### APPENDIX A. THE ALGEBRA $A_{\mathbf{w}}$ FOR SYMMETRIC BANDS

For a symmetric band  $\mathbf{w}$  let us denote the algebra  $A_{\mathbf{w}}$  by  $R := k\langle S, T \rangle / \langle S^2 - 1, T^2 - 1 \rangle$ . It is isomorphic to the group algebra of the infinite dihedral group.  $R$  is a tame hereditary order, which is closely related to the classification of the regular modules over hereditary algebras of type  $\tilde{D}$ . Recall, that we denote by  $\chi$  the automorphism of  $R$ , which is defined by  $\chi(S) = -S$  and  $\chi(T) = -T$ , and  $\iota$  is the automorphism which swaps  $S$  and  $T$ . Clearly,  $\iota \circ \chi = \chi \circ \iota$ .

The indecomposable representations of  $R$  have been classified independently by several authors, see for example [BB81] and [Do86]. We present this classification with a notation which is compatible with our setup.

The somehow more complicated situation for  $\text{char}(k) = 2$  has been studied previously by Bondarenko [Bo75] and Ringel [Ri75].

Since the infinite dihedral group is the semidirect product of the infinite cyclic group and a cyclic group of order two,  $R$  is isomorphic to the skew group algebra of  $k[X, X^{-1}]\langle \sigma \rangle$ , where the automorphism  $\sigma$  swaps  $X$  and  $X^{-1}$ . This isomorphism sends  $X \otimes 1$  to  $ST$  and  $1 \otimes \sigma$  to  $T$  (and  $X \otimes \sigma$  to  $S$ ).

We denote by  $V_{m,s}$  the  $m$ -dimensional representation of  $k[X, X^{-1}]$  on which  $X$  acts by the  $m \times m$  Jordan block  $J_m(s)$  for some  $s \in k \setminus \{0\}$ . Then we have  $V_{m,s}^\sigma \cong V_{m,s^{-1}}$  and thus  $V_{m,s}^\sigma \cong V_{m,s}$  if and only if  $s \in \{-1, 1\}$ . Similarly we denote by  $\tilde{V}_{m,s}$  the  $2m$ -dimensional representation of  $R$  with

$$\tilde{V}_{m,s}(S) = \begin{pmatrix} 0 & J_m(s) \\ J_m(s)^{-1} & 0 \end{pmatrix} \quad \text{and} \quad \tilde{V}_{m,s}(T) = \begin{pmatrix} 0 & E_m \\ E_m & 0 \end{pmatrix}.$$

On the other hand, with

$$(\tilde{S}_{m,\pm 1})_{i,j} := \begin{cases} (-1)^{i+1} (\pm 1)^{i+j} \binom{i}{j} & \text{if } 1 \leq j \leq i \leq m \\ 0 & \text{if } 1 \leq i < j \leq m, \end{cases}$$

we observe that

$$\tilde{S}_{m,\pm 1}^2 = E_m \quad \text{and} \quad \tilde{S}_{m,\pm 1} \cdot J_m(\pm 1) = J_m(\pm 1)^{-1} \cdot \tilde{S}_{m,\pm 1}.$$

We conclude that with

$$W_{m,\pm 1}(S) := \tilde{S}_{m,\pm 1} \cdot J_m(\pm 1) \quad \text{and} \quad W_{m,\pm 1}(T) := \tilde{S}_{m,\pm 1}$$

we get for each  $m \in \mathbb{N}_0$  two indecomposable,  $m$ -dimensional representations of  $R$ , which are not isomorphic. In particular we have  $W_{1,\pm 1}(S) = \pm 1$  and  $W_{1,\pm 1}(T) = 1$  whilst  $W_{1,\pm 1}^\chi(S) = \mp 1$  and  $W_{1,\pm 1}^\chi(T) = -1$ .

From the above considerations we obtain the following classification result, which seems to be folklore.

**Proposition A.1.** *Let  $k$  be an algebraically closed field with  $\text{char}(k) \neq 2$ . With the above notations, for each  $s \in k \setminus \{0\}$  and  $m \in \mathbb{Z}_{>0}$  holds*

$$R \otimes_{k[X, X^{-1}]} V_{m,s} \cong \begin{cases} \tilde{V}_{m,s} & \text{if } s \notin \{-1, 1\}, \\ W_{m,s} \oplus W_{m,s}^\chi & \text{if } s \in \{1, -1\}. \end{cases}$$

The modules  $\tilde{V}_{m,s}$  with  $s \in k \setminus \{-1, 0, 1\}$  and  $W_{m,\pm 1}, W_{m,\pm 1}^\chi$  present a complete list of the indecomposable representations of  $R$ , with  $\tilde{V}_{m,s} \cong \tilde{V}_{m,s-1}$  the only isomorphism between them. Moreover, we have  $\tilde{V}_{m,s}^\chi \cong \tilde{V}_{m,s} \cong \tilde{V}_{m,s}^\iota$  for all  $s \in k \setminus \{-1, 0, 1\}$ , and  $W_{m,1}^\iota \cong W_{m,1}$ ,  $W_{m,-1}^\iota \cong W_{m,-1}^\chi$  for all  $m$ .

#### APPENDIX B. PROOF OF PROPOSITION 3.1

Let  $\mathbf{w} = w_0 w_1 \cdots w_l \in \text{St}(\underline{Q}) \cup \text{pBa}'(\underline{Q})$ . We have to distinguish several cases, with each one requiring slightly different arguments.

(1)  $\mathbf{w}$  is an asymmetric string. Following Section 3.2, the word  $A(\mathbf{w}) = \tilde{w}_0 \tilde{w}_1 \cdots \tilde{w}_l$  is a string of type  $(u, u)$  for  $\hat{Q}$ , and  $\overline{A(\mathbf{w})} = \mathbf{w}$ .

First, suppose that  $\overline{A(\mathbf{w})}$  is not admissible. Then we may assume without restriction that for some  $j$  we have  $F(\tilde{w}_j) = \varepsilon^*$  is special and  $A(\mathbf{w})_{[j-1]}^{-1} \prec A(\mathbf{w})_{[j+1]}$  whilst  $\tilde{w}_j = \varepsilon$  is a direct letter. By the definition of  $A(\mathbf{w})$  this means that  $\mathbf{w}_{[j-1]}^{-1} > \mathbf{w}_{[j+1]}$ . These two inequalities can hold only at the same time if

$$(B.1) \quad A(\mathbf{w}) = \tilde{\mathbf{y}} \eta^{-1} \tilde{\mathbf{x}}^{-1} \varepsilon \tilde{\mathbf{x}} \eta^{-1} \tilde{\mathbf{z}}$$

with certain words  $\tilde{\mathbf{x}}, \tilde{\mathbf{y}}, \tilde{\mathbf{z}}$  for  $\hat{Q}$ . Moreover, with  $i = j - l(\tilde{\mathbf{x}}) - 1$  and  $k = j + l(\tilde{\mathbf{x}})$  the letters  $F(\tilde{w}_i) = \eta^* = F(\tilde{w}_k)$  are necessarily special.

In fact, we have then

$$\begin{aligned} A(\mathbf{w})_{[j-1]}^{-1} &= \tilde{\mathbf{x}} \eta \tilde{\mathbf{y}}^{-1} \prec A(\mathbf{w})_{[j+1]} = \tilde{\mathbf{x}} \eta \tilde{\mathbf{z}} \text{ and} \\ \mathbf{w}_{[j-1]}^{-1} &> \mathbf{w}^{[j+1]} \text{ implies} \\ \mathbf{y}^{-1} &= F(\tilde{\mathbf{y}}^{-1}) > F(\tilde{\mathbf{z}}) = \mathbf{z}. \end{aligned}$$

On the other hand, in the following chain of inequalities

$$\mathbf{y}^{-1} < \mathbf{x}^{-1} \varepsilon^* \mathbf{x} \eta^* \mathbf{z} < \mathbf{x}^{-1} \varepsilon^* \mathbf{x} \eta^* \mathbf{y}^{-1} < \mathbf{x}$$

the first and the third one hold because of the construction of  $A(\mathbf{w})$ , which is codified in the orientation of the letters  $\tilde{w}_i = \eta^{-1}$  and  $\tilde{w}_k = \eta^{-1}$ . The second inequality follows trivially from  $\mathbf{y}^{-1} > \mathbf{z}$ . A contradiction.

Next, suppose  $\tilde{\mathbf{w}}' = \tilde{w}'_0 \tilde{w}'_1 \cdots \tilde{w}'_l \neq A(\mathbf{w})$  is an admissible string with  $\overline{\tilde{\mathbf{w}}'} = \mathbf{w}$ . Then there exists  $j \in \{1, 2, \dots, l-1\}$  with  $\tilde{w}'_j \neq \tilde{w}_j$ . In particular,  $F(\tilde{w}'_j) = F(\tilde{w}_j)$  is a special letter  $\varepsilon^*$ , and we may assume that  $\Delta_{\mathbf{w}}(j) \leq \Delta_{\mathbf{w}}(j')$  for all  $j'$  with  $\tilde{w}'_{j'} \neq \tilde{w}_{j'}$ . See Section 3.1 for the definition of  $\Delta_{\mathbf{w}}(j)$ . We may assume further, without loss of generality, that

$$(\tilde{\mathbf{w}}'_{[j-1]})^{-1} \prec (\tilde{\mathbf{w}}')^{[j+1]} \text{ and } \mathbf{w}_{[j-1]}^{-1} > \mathbf{w}^{[j+1]}.$$

Thus, we have a factorization as in (B.1), which implies  $\Delta_{\mathbf{w}}(j) > \Delta_{\tilde{\mathbf{w}}'}(j)$ . With  $d' := l(\mathbf{x}) = \Delta_{\tilde{\mathbf{w}}'}(j)$  and  $i := j - d' - 1$  and  $k := j + d' + 1$  we have here  $\tilde{w}'_i = \eta^{-1} = \tilde{w}'_k$ . We have also the corresponding factorization

$$\mathbf{w} = \mathbf{y}' \mathbf{a} \mathbf{u}^{-1} \eta^* \mathbf{x}^{-1} \varepsilon^* \mathbf{x} \eta^* \mathbf{u} \mathbf{b} \mathbf{z}',$$

where, with  $d := l(\mathbf{x}) + 1 + l(\mathbf{u}) = \Delta_{\mathbf{w}}(j)$ , the letters  $w_{j-d-1} = a$  and  $w_{j+d+1} = b$  are ordinary direct ones.

If  $\Delta_{\mathbf{w}}(i) < l(\mathbf{u})$  and  $\Delta_{\mathbf{w}}(k) < l(\mathbf{u}) < d$ , then by our hypothesis  $\tilde{w}'_i = \tilde{w}_i$  and  $\tilde{w}'_k = \tilde{w}_k$ . However, by the above factorization of  $\mathbf{w}$ , this means that  $\tilde{w}'_i = \tilde{w}_k$ , in contradiction to  $\tilde{w}'_i = \tilde{w}'_k = \eta^{-1}$ .

Thus, due to the position of the direct letters  $w_{j-d-1} = a$  and  $w_{j+d+1} = b$  we see that either  $\Delta_{\mathbf{w}}(i) = l(u)$  or  $\Delta_{\mathbf{w}}(k) = l(u) < d$ . This forces in the first case  $\tilde{w}'_i = \eta$  and in the second case  $\tilde{w}'_k = \eta$ . A contradiction.

(2)  $\mathbf{w} = \varepsilon_p^* \mathbf{v} \varepsilon_q^* \mathbf{v}^{-1}$  is a symmetric band with  $\mathbf{v} = w_1 w_2 \cdots w_{n-1}$  and  $2n = l + 1$ . In this case  $A(\mathbf{w}) = \tilde{w}_0 \tilde{w}_1 \cdots \tilde{w}_n \in \text{St}(\widehat{Q})$  is of type  $(p, p)$  with  $\tilde{w}_0 = \mathbb{1}_{p,-1}^{-1}$  and  $\tilde{w}_n = \mathbb{1}_{q,-1}$ . By construction,  $F(A(\mathbf{w}))F(\tilde{w}_{n-1}^{-1} \cdots \tilde{w}_2^{-1} \tilde{w}_1^{-1}) = \hat{F}(A(\mathbf{w})) = \mathbf{w} \in \text{pBa}$ , so that the second condition for  $A(\mathbf{w})$  to be an admissible string is fulfilled.

Let us now suppose that  $A(\mathbf{w})$  is not admissible. Without loss of generality we have then for some  $j \in \{1, 2, \dots, n-1\}$  the following:

- $\tilde{w}_j = \varepsilon$  with  $F(\varepsilon) = \varepsilon^*$  a special letter and thus  $\mathbf{w}_{[j-1]}^{-1}(\mathbf{w}^{[j+1]}) > \mathbf{w}_{[j+1]}\mathbf{w}^{[j-1]}$ ,
- $A(\mathbf{w})_{[j-1]}^{-1} < A(\mathbf{w})^{[j+1]}$ .

Similarly in the case (1), this means that we have a factorization as in (B.1). In particular we have again  $F(\tilde{w}_i) = F(\tilde{w}_j) = \eta^*$  special letters.

Note however, that  $\mathbf{y}^{-1} = F(\tilde{\mathbf{y}})^{-1}$  and  $\mathbf{z} = F(\tilde{\mathbf{y}})$  are in this situation *not* right inextensible, and thus the two words might be incomparable. However, we have the following inequalities and factorizations from the construction of  $\underline{H}(\mathbf{w})$  for a symmetric band, if we take into account the orientation of the letters  $\tilde{\mathbf{w}}_i, \tilde{\mathbf{w}}_j$  and  $\tilde{\mathbf{w}}_k$ :

$$(B.2) \quad \mathbf{y}^{-1}(\mathbf{w}^{[i+1]})^{-1} = \mathbf{w}_{[i-1]}^{-1}(\mathbf{w}^{[i+1]})^{-1} < \mathbf{w}^{[i+1]}\mathbf{w}_{[i-1]} = \mathbf{x}^{-1}\varepsilon^*\mathbf{x}\eta^*\mathbf{z}\mathbf{v}^{-1}\mathbf{w}_{[i-1]}$$

$$(B.3) \quad \mathbf{x}\eta^*\mathbf{z}\mathbf{v}^{-1}\mathbf{w}_{[j-1]} = \mathbf{w}^{[j+1]}\mathbf{w}_{[j-1]} < \mathbf{w}_{[j-1]}^{-1}(\mathbf{w}^{[j+1]})^{-1} = \mathbf{x}\eta\mathbf{y}^{-1}(\mathbf{w}^{[j+1]})^{-1}$$

$$(B.4) \quad \mathbf{x}^{-1}\varepsilon^*\mathbf{x}\eta^*\mathbf{y}^{-1}(\mathbf{w}^{[k+1]})^{-1} = \mathbf{w}_{[k-1]}^{-1}(\mathbf{w}^{[k+1]})^{-1} < \mathbf{w}^{[k+1]}\mathbf{w}_{[k-1]} = \mathbf{z}\mathbf{v}^{-1}\mathbf{w}_{[k-1]}.$$

Since  $i < j < k$  we conclude from (B.3) that

$$(B.5) \quad \mathbf{z}\mathbf{v}^{-1}\mathbf{w}_{[k-1]} < \mathbf{y}^{-1}(\mathbf{w}^{[i+1]})^{-1},$$

see end of Section 2.4. From this we obtain with (B.2) and B.4 the following chain of inequalities

$$\mathbf{x}^{-1}\varepsilon^*\mathbf{x}\eta^*\mathbf{y}^{-1}(\mathbf{w}^{[k+1]})^{-1} < \mathbf{z}\mathbf{v}^{-1}\mathbf{w}_{[k-1]} < \mathbf{y}^{-1}(\mathbf{w}^{[i+1]})^{-1} < \mathbf{x}^{-1}\varepsilon^*\mathbf{x}\eta^*\mathbf{z}\mathbf{v}^{-1}\mathbf{w}_{[i-1]}.$$

Again, since  $i < j < k$ , this implies  $\mathbf{y}^{-1}(\mathbf{w}^{[i+1]})^{-1} < \mathbf{z}\mathbf{v}^{-1}\mathbf{w}_{[k-1]}$ , contradicting (B.5).

Next, suppose  $\tilde{\mathbf{w}}' = \tilde{w}'_0 \tilde{w}'_1 \cdots \tilde{w}'_n \neq A(\mathbf{w})$  is an admissible string of type  $(p, p)$  with  $\hat{F}_A(\tilde{\mathbf{w}}') = \mathbf{w}$ . Then there exists  $j \in \{1, 2, \dots, n-1\}$  with  $\tilde{w}'_j \neq \tilde{w}_j$ . In particular  $F(\tilde{w}'_j) = F(\tilde{w}_j)$  is a special letter  $\varepsilon^*$ , and we may assume that  $\Delta_{\mathbf{w}}(j) \leq \Delta_{\mathbf{w}}(j')$  for all  $j'$  with  $\tilde{w}'_{j'} \neq \tilde{w}_{j'}$ . See Section 3.1 for the definition of  $\Delta_{\mathbf{w}}(j)$ . We may assume further without loss of generality that

$$(\tilde{\mathbf{w}}'_{[j-1]})^{-1} \prec (\tilde{\mathbf{w}}')^{[j+1]} \text{ and } \mathbf{w}_{[j-1]}^{-1}(\mathbf{w}^{[j-1]})^{-1} > \mathbf{w}^{[j+1]}\mathbf{w}_{[j-1]}.$$

Thus we have a factorization as in (B.1), which implies  $\Delta_{\mathbf{w}}(j) > \Delta_{\tilde{\mathbf{w}}'}(j)$ . With  $d' := l(\tilde{\mathbf{w}}) = \Delta_{\tilde{\mathbf{w}}'}(j)$  and  $i := j - d' - 1$  and  $k := j + d' + 1$  we have here  $\tilde{w}'_i = \eta^{-1} = \tilde{w}'_k$  again. We have also the corresponding factorization

$$w_{-l+j-1} \cdots w_{-1} w_0 \cdots w_l w_{l+1} \cdots w_{l+j-1} = \mathbf{w}^{[j+1]}\mathbf{w}\mathbf{w}_{[j-1]} = \mathbf{y}' a \mathbf{u}^{-1} \eta^* \mathbf{x}^{-1} \varepsilon^* \mathbf{x} \eta^* \mathbf{u} b \mathbf{z}',$$

where, with  $d := l(\mathbf{u}) + 1 + l(\mathbf{x}) = \Delta_{\mathbf{w}}(j)$ , the letters  $w_{j-d-1} = a$  and  $w_{j+d+1} = b$  ordinary direct ones.

If  $\Delta_{\mathbf{w}}(i) < l(\mathbf{u})$  and  $\Delta_{\mathbf{w}}(k) < l(\mathbf{u}) < d$ , then by our hypothesis  $\tilde{w}'_i = \tilde{w}_i$  and  $\tilde{w}'_k = \tilde{w}_k$ . However, by the above factorization of  $\mathbf{w}^{[j+1]}\mathbf{w}\mathbf{w}^{[j-1]}$  this means that  $\tilde{w}_i^{-1} = \tilde{w}_k$ , in contradiction to  $\tilde{\mathbf{w}}'_i = \tilde{\mathbf{w}}'_k = \eta^{-1}$ .

Thus, due to the position of the direct letters  $w_{j-d-1} = a$  and  $w_{j+d+1} = b$  we see that either  $\Delta_{\mathbf{w}}(i) = l(u)$  or  $\Delta_{\mathbf{w}}(k) = l(u) < d$ . This forces in the first case  $\tilde{w}'_i = \eta$  and in the second case  $\tilde{w}'_k = \eta$ . A contradiction.

(3) It should now be obvious how to modify the argument for the remaining two cases when  $\mathbf{w}$  is either a symmetric string or an asymmetric band.

**Acknowledgment.** The author acknowledges partial support from UNAM PAPIIT grant IN116723 (2023-2025).

## REFERENCES

- [AdIR14] T. Adachi, O. Iyama, I. Reiten:  $\tau$ -tilting theory *Compos. Math.* **150** (2014), no. 3, 415–452.
- [AmP22] C. Amiot, P.-G. Plamondon: *The cluster category of a surface with punctures via group actions.* *Adv. Math.* **389** (2021), Paper No. 107884, 63 pp.
- [AS87] I. Assem, A. Skowronski: *Iterated tilted algebras of type  $\tilde{A}_n$ .* *Math. Z.* **195** (1987), 269–290.
- [BB81] S.D. Berman, K. Buzási: *Representations of the infinite dihedral group.* (Russian) *Publ. Math. Debrecen* **28** (1981), no. 1-2, 173–187.
- [Bo75] V.M. Bondarenko: *Representations of dihedral groups over a field of characteristic 2.* (Russian) *Mat. Sb. (N.S.)* **96(138)** (1975), 63–74, 167.
- [Bo91] V.M. Bondarenko: *Representations of bundles of semichained sets and their applications.* (Russian. Russian summary) *Algebra i Analiz* **3** (1991), no. 5, 38–61; translation in *St. Petersburg Math. J.* **3** (1992), no. 5, 973–996
- [BrY20] Th. Brüstle, G. Douville, K. Mousavand, H. Thomas, E. Yildirim: *On the combinatorics of gentle algebras.* *Can. J. Math.* **72** (2020) 1551–1580.
- [BuR87] M. Butler, C.R. Ringel: *Auslander-Reiten sequences with few middle terms and applications to string algebras.* *Comm. Algebra* **15** (1987), no. 1-2, 145–179.
- [CeLFS15] G. Cerulli Irelli, D. Labardini-Fragoso, J. Schröer: *Caldero-Chapoton algebras.* *Trans. Amer. Math. Soc.* **367** (2015), no. 4, 2787–2822
- [CrB88] W.W. Crawley-Boevey: *Functorial filtrations and the problem of an idempotent and a square-zero matrix.* *J. London Math. Soc. (2)* **38** (1988), no. 3, 385–402.
- [CrB89a] W.W. Crawley-Boevey: *Maps between representations of zero-relation algebras.* *J. Algebra* **126** (1989), no. 2, 259–263.
- [CrB89b] W.W. Crawley-Boevey: *Functorial filtrations. II. Clans and the Gel'fand problem.* *J. London Math. Soc. (2)* **40** (1989), no. 1, 9–30.
- [De00] Deng, Bangming: *On a problem of Nazarova and Roiter.* *Comment. Math. Helv.* **75** (2000), no. 3, 368–409.
- [Do86] D. Đoković: *Pairs of involutions in the general linear group.* *J. Algebra* **100** (1986), no. 1, 214–223.
- [FST08] S. Fomin, M. Shapiro, D. Thurston: *Cluster algebras and triangulated surfaces. Part I: Cluster complexes.* *Acta Math.* **201** (2008), no. 1, 83–146.
- [Ge99] Ch. Geiß: *Homomorphisms between representations of clans.* *J. Algebra* **218** (1999), 131–164.
- [GLFS22] Ch. Geiß, D. Labardini-Fragoso, J. Schröer: *Schemes of modules over gentle algebras and laminations of surfaces.* *Selecta Math. (N.S.)* **28** (2022), paper 8, 78 pp.
- [GLFS23] Ch. Geiß, D. Labardini-Fragoso, J. Schröer: *Semicontinuous maps on module varieties.* Preprint, arXiv:2302.02085 [math.RT], (2023), 17 pp.
- [GP99] Ch. Geiß, J.A. de la Peña: *Auslander-Reiten components for clans.* *Bol. Soc. Mat. Mexicana (3)* **5** (1999), no. 2, 307–326.
- [Ha22] U. Hansper: *Classification of the indecomposable finite dimensional modules of clannish algebras,* PhD Thesis, Bielefeld (2022), 288 pp.
- [Kr91] H. Krause: *Maps between tree and band modules.* *J. Algebra* **137** (1991), no. 1, 186–194.
- [LF09] D. Labardini-Fragoso: *Quivers with potentials associated to triangulated surfaces.* *Proc. London Math. Soc.* **98** no. 3, 797–839 (2009)
- [MSW13] G. Musiker, R. Schiffler, L. Williams: *Bases for cluster algebras from surfaces.* *Compositio Math.* **149** (2013), 217–263.

- [PPP21] Y. Palu, V. Pilaud, P.-G. Plamondon: *Non-kissing complexes and tau-tilting for gentle algebras*. Mem. Amer. Math. Soc. 274 (2021), no. 1343, vii+110 pp.
- [QZ17] Yu Qiu, Yu Zhou: *Cluster categories for marked surfaces: punctured case*. Compos. Math. **153** (2017), no. 9, 1779–1819.
- [RR85] I. Reiten, Ch. Riedtmann: *Skew group algebras in the representation theory of Artin algebras*. J. Algebra **92** (1985), no. 1, 224–282.
- [Ri75] C.M. Ringel: *The indecomposable representations of the dihedral 2-groups*. Math. Ann. **214** (1975), 19–34.
- [WW85] B. Wald, J. Waschbüsch: *Tame biserial algebras*. J. Algebra **95** (1985), no. 2, 480–500.

INSTITUTO DE MATEMÁTICAS, UNAM, CIUDAD DE MÉXICO, C.P. 04510, MEXICO  
Email address: `christof.geiss@im.unam.mx`