

Diagrammatic category theory

Kenji Nakahira

Abstract

In category theory, the use of string diagrams is well known to aid in the intuitive understanding of certain concepts, particularly when dealing with adjunctions and monoidal categories. We show that string diagrams are also useful in exploring fundamental properties of basic concepts in category theory, such as universal properties, (co)limits, Kan extensions, and (co)ends. For instance, string diagrams are utilized to represent visually intuitive proofs of the Yoneda lemma, necessary and sufficient conditions for being adjunctions, the fact that right adjoints preserve limits (RAPL), and necessary and sufficient conditions for having pointwise Kan extensions. We also introduce a method for intuitively calculating (co)ends using diagrammatic representations and employ it to prove several properties of (co)ends and weighted (co)limits. This paper proposes that using string diagrams is an effective approach for beginners in category theory to learn the fundamentals of the subject in an intuitive and understandable way.

Contents

1	Introduction	2
1.1	Features of string diagrams	2
1.2	Key aspects of this paper	5
2	Basics of string diagrams	5
2.1	Categories, functors, and natural transformations	5
2.2	Vertical and horizontal composition	9
2.3	Product of categories and bifunctors	15
3	The Yoneda lemma and universal properties	19
3.1	The Yoneda lemma	19
3.2	Universal properties	34
3.3	Basic properties of universal morphisms	41
4	Adjunctions	44
4.1	Definition of adjunctions	44
4.2	Necessary and sufficient conditions for adjunctions	44
4.3	Basic properties of adjunctions	47
5	Limits and colimits	53
5.1	Definition of limits and colimits	53
5.2	Basic properties of limits and colimits	57
6	Kan extensions	64
6.1	Definition of Kan extensions	64
6.2	Pointwise Kan extensions	67
6.3	Basic properties of Kan extensions	77

7 (Co)ends and weighted (co)limits	84
7.1 Diagrams for direct products	84
7.2 Definition of (co)ends	86
7.3 Basic properties of (co)ends	88
7.4 (Co)tensor products	90
7.5 Weighted (co)limits	96

1 Introduction

String diagrams are commonly used as graphical representations in category theory (e.g., [1, 5, 8, 15, 16]). They serve as a tool for visually depicting concepts such as adjunctions and monoidal categories in an easily understandable way. In recent years, string diagrams have found widespread use in various fields beyond mathematics that apply category theory, including computer science, physics, control theory, and linguistics.

The aim of this paper is to demonstrate the usefulness of string diagrams in learning basic concepts of category theory. Currently, commutative diagrams are predominantly used in standard category theory textbooks, while string diagrams are seldom employed. This paper proposes that using string diagrams is an effective approach for beginners to intuitively grasp the fundamentals of category theory. String diagrams can not only represent concepts intuitively but also aid in proving various statements. For instance, we use string diagrams to prove the Yoneda lemma (see Theorem 3.28), necessary and sufficient conditions for being adjunctions (see Theorems 4.9 and 4.13), the fact that right adjoints preserve limits (RAPL) (see Theorem 5.18), and necessary and sufficient conditions for having pointwise Kan extensions (see Theorem 6.20). We also introduce diagrams for intuitively calculating (co)ends and employ them to demonstrate some relationships between (co)limits, (co)ends, weighted (co)limits, and pointwise Kan extensions. It is well known that, with string diagrams, calculations involving functors and natural transformations can be performed without explicitly considering functoriality or naturality. Additionally, we show that string diagrams are useful for verifying whether given data satisfies functoriality, naturality, universal property, etc.

We explain basic concepts in category theory (specifically, universal property, adjunctions, (co)limits, Kan extensions, (co)ends, etc.) using string diagrams. For more information on these concepts, please refer to sources such as Refs. [7, 12]. Reference [6] is also helpful for (co)end calculations. This paper is largely self-contained; however, we assume that the reader has a basic understanding of the fundamental properties of category theory. The primary objective of this paper is to demonstrate the usefulness of string diagrams; we do not discuss various interesting examples or some basic concepts (e.g., epi- or monomorphisms and examples of (co)limits such as equalizers) where string diagrams may not be particularly helpful. We do not address monoidal categories because the method of representing them with string diagrams has already been extensively studied (e.g., [15] and its references). Our focus is on categories or 2-categories consisting of categories, excluding enriched categories or general bicategories.

1.1 Features of string diagrams

Diagrams commonly employed in standard textbooks can be classified into two types from a certain perspective: (a) those that represent morphisms with arrows and (b) those that consider 2-categories consisting of categories and represent functors with arrows. In what follows, we refer to them as (a) arrow diagrams and (b) pasting diagrams [2, 11]. We here provide several examples of them and briefly describe their relationship with the corresponding string diagrams used in this paper.

(1) Relationship with arrow diagrams

As the first example comparing arrow diagrams with string diagrams, we give the following expression representing naturality of a natural transformation $\alpha: F \Rightarrow G$ with $F, G: C \rightarrow \mathcal{D}$:

(A) arrow diagram:

$$\begin{array}{ccc} Fa & \xrightarrow{\alpha_a} & Ga \\ Ff \downarrow & & \downarrow Gf \\ Fb & \xrightarrow{\alpha_b} & Gb \end{array},$$

(B) string diagram:

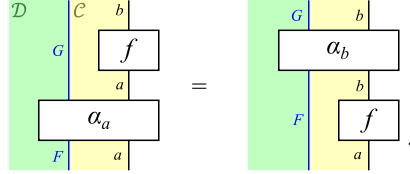

This arrow diagram is commutative, which means that the two paths from Fa to Gb , i.e., $Gf \circ \alpha_a$ and $\alpha_b \circ Ff$, are equal (where \circ is the composition of morphisms). Information such as that F and G are functors from C to \mathcal{D} is usually not included in arrow diagrams, but it is present in string diagrams. Note that it can also be represented by a string diagram as follows (see in detail in Eq. (2.6)):

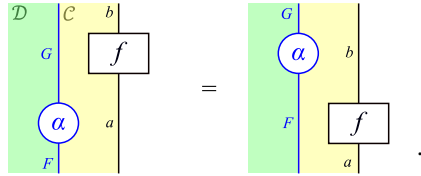

As the second example, a universal morphism $\langle u, \eta \rangle$ from $c \in C$ to $G: \mathcal{D} \rightarrow C$ is represented by

(A) arrow diagram:

$$\begin{array}{ccc} c & \xrightarrow{\eta} & Gu \\ & \searrow a & \downarrow G\bar{a} \\ & & Gx \end{array}, \quad \begin{array}{ccc} u & & \\ \downarrow \exists! \bar{a} & & \\ x & & \end{array},$$

(B) string diagram:

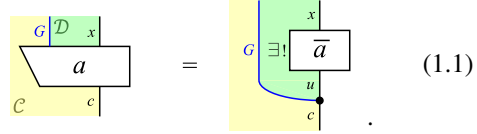

In the string diagram, the black circle (dot) represents η . In the arrow diagrams, two diagrams are drawn: one on the left representing morphisms in the category C and one on the right representing morphisms in the category \mathcal{D} . The diagram on the left is commutative (i.e., $a = G\bar{a} \circ \eta$). Thus, when representing morphisms from multiple categories in arrow diagrams, multiple diagrams are generally required. As can be seen from this example, the correspondence between arrow diagrams and string diagrams is not very direct.

The main advantages of string diagrams over arrow diagrams are as follows^{‡1}:

- A diagram can convey a large amount of information in an easy-to-understand form. While, in arrow diagrams, typically, only objects and morphisms within a single category can be represented in a single diagram, it is often necessary to represent objects and morphisms in multiple categories, as well as functors and natural transformations. String diagrams can represent all of them in a single diagram.
- Expressions involving both vertical and horizontal composition can be straightforwardly represented. Related to Advantage 1, horizontal composition is generally represented using equational forms in arrow diagrams. In contrast, both vertical and horizontal composition can be clearly represented in a string diagram. String diagrams are well-suited for representing the composition of morphisms, categories, functors, and natural transformations, revealing their structural relationships.

For a comparison of arrow diagrams and string diagrams from the perspective of a calculational approach, see the Introduction of Ref. [8].

^{‡1}There are also situations where arrow diagrams are preferable to string diagrams. The main disadvantages of string diagrams are as follows: (a) It is difficult to effectively represent commutative expressions when they appear frequently. (b) The style of drawing string diagrams can differ significantly among individuals.

(2) Relationship with pasting diagrams

The following is an example comparing pasting diagrams with the string diagrams:

(A) pasting diagram:

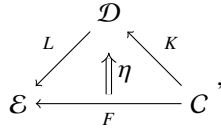

(B) string diagram:

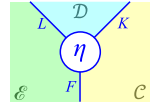

Note that this diagram is drawn with Eq. (6.2) in mind, which represents a left Kan extension of $F: C \rightarrow \mathcal{E}$ along $K: C \rightarrow \mathcal{D}$. There is a close relationship between these diagrams. We can overlay the two diagrams as follows, omitting the overlapping information:

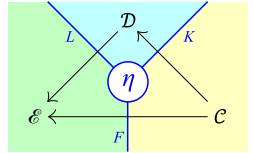

(1.2)

In the pasting diagram, two types of arrows appear: arrows “ \rightarrow ” representing functors and arrows “ \Rightarrow ” representing natural transformations. Also, categories C , \mathcal{D} , and \mathcal{E} are represented by points; functors $K: C \rightarrow \mathcal{D}$, $F: C \rightarrow \mathcal{E}$, and $L: \mathcal{D} \rightarrow \mathcal{E}$ by arrows; and a natural transformation $\eta: F \Rightarrow L \bullet K$ (where \bullet denotes horizontal composition) by a triangle with vertices C , \mathcal{D} , and \mathcal{E} having an arrow “ \Rightarrow ”. When overlaid as in Eq. (1.2), it can be seen that each arrow (in the pasting diagram) and the corresponding wire (in the string diagram) can be drawn in such a way that they are orthogonal to each other. The differences between pasting and string diagrams can be summarized as shown in Table 1.1.

Table 1.1: Differences between pasting and string diagrams.

	pasting diagrams	string diagrams
categories	points (0-dimensional)	surfaces (2-dimensional)
functors	arrows “ \rightarrow ” (1-dimensional)	wires (1-dimensional)
natural transformations	surfaces with arrows “ \Rightarrow ” (2-dimensional)	blocks (0-dimensional)

Another example is

(A) pasting diagram:

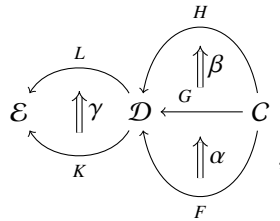

(B) string diagram:

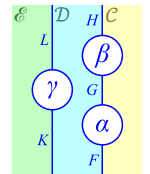

(1.3)

where we represent the horizontal composition of a natural transformation γ with the vertical composition of two natural transformations α and β , i.e., $\gamma \bullet \beta \alpha$. Both diagrams represent vertical composition by stacking elements vertically and horizontal composition by placing them side by side. As with the previous example, it is immediately clear that the two diagrams can be overlaid.

Pasting and string diagrams are dual to each other and can be converted interchangeably. However, when it comes to discussions regarding the foundations of category theory, there are often instances where calculations involving natural transformations need to be carried out. Therefore, it is crucial to visually represent natural transformations in a clear form when performing calculations. Keeping this in mind, the main advantage of string diagrams over pasting diagrams is as follows:

- The same type of natural transformation can be represented in the same way. In pasting diagrams, it can often be difficult to represent identical or the same type of natural transformations in the same shape. For example, consider the scenario where $\alpha = \beta = \gamma$ holds in Eq. (1.3). In contrast, in string diagrams, these natural transformations can always (and easily) be represented in the same shape. Therefore, when calculating natural transformations, string diagrams should be visually easier to understand. Also, thanks to this advantage, it is easy to assign a special shape to a special type of natural transformation (such as the black circle in Eq. (1.1)) and distinguish it from others.

1.2 Key aspects of this paper

The article most closely related to this paper is Refs. [5, 8], in which it has been argued that string diagrams have utility in calculational approaches to category theory. This paper aims to demonstrate the usefulness of string diagrams for various concepts mentioned in standard textbooks on category theory, which were not extensively explored in Refs. [5, 8]. Several key aspects of this paper include:

- Set-valued functors: We introduce several diagrams for set-valued functors. Using these diagrams, we prove the Yoneda lemma in an intuitively understandable form (see Theorem 3.28).
- Universal properties: We represent universal properties with simple diagrams (see Subsubsection 3.2.4). Note that this representation is similar to that of Ref. [4]. Diagrams for adjoints, (co)limits, Kan extensions, etc. are depicted as specific instances of this representation.
- (Co)limits: We show some basic properties (e.g., any right adjoint and functor of the form $C(c, -)$ preserve limits).
- Kan extensions: We mainly show some basic properties of pointwise Kan extensions.
- (Co)ends: We introduce a new diagram that visually represents (co)end-related expressions such as $\mathcal{D}^C(F, G) \cong \int_{c \in C} \mathcal{D}(Fc, Gc)$ in an easy-to-understand form and perform several (co)end calculations graphically.

2 Basics of string diagrams

In this section, we provide an overview of how to represent very basic concepts in category theory, such as categories, functors, and natural transformations, using string diagrams.

2.1 Categories, functors, and natural transformations

2.1.1 Categories

For morphisms $f: a \rightarrow b$ and $g: b \rightarrow c$ in a category C , the composite of f and g , denoted by $g \circ f: a \rightarrow c$ (or simply written as gf), is represented by the following diagram:

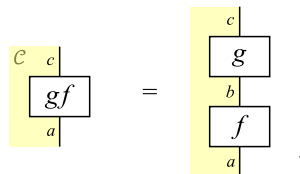

In our string diagrams, morphisms are represented by blocks (which are often depicted with rectangular or trapezoidal blocks but can also take on other shapes), while objects are represented by wires. The wires extending from the bottom and top of a morphism represent its domain

and codomain, respectively. The yellow region labeled with “ C ” indicates that the morphism gf belongs to the category C . Regions of the same color within each diagram represent the same category unless otherwise stated, and their duplicated labels are often omitted. The composition operation is associative, i.e.,

$$h(gf) = (hg)f \xrightarrow{\text{diagram}} \begin{array}{c} \mathcal{C} \quad d \\ \boxed{h} \\ c \\ \boxed{g} \\ b \\ \boxed{f} \\ a \end{array} = \begin{array}{c} d \\ \boxed{h} \\ c \\ \boxed{g} \\ b \\ \boxed{f} \\ a \end{array},$$

and unital, i.e.,

$$f \circ 1_a = f = 1_b \circ f \xrightarrow{\text{diagram}} \begin{array}{c} \mathcal{C} \quad b \\ \boxed{f} \\ a \\ \boxed{1_a} \\ a \end{array} = \begin{array}{c} b \\ \boxed{f} \\ a \end{array} = \begin{array}{c} b \\ \boxed{1_b} \\ b \\ \boxed{f} \\ a \end{array}, \quad (2.1)$$

where dashed lines (used as auxiliary lines) are only intended to guide the eye. The symbol “ $\xrightarrow{\text{diagram}}$ ” is used to show a corresponding diagram. As shown in Eq. (2.1), identity morphisms are simply represented by wires. Note that it is not possible to distinguish between the identity morphism 1_a and the object a in diagrams, but this is not a substantial problem. In this paper, we assume that all categories are locally small unless otherwise stated. Let $C(a, b)$ be the hom-set from $a \in C$ to $b \in C$, i.e., the collection of all morphisms with domain a and codomain b .

The composite of two morphisms $f \in C^{\text{op}}(b, a)$ and $g \in C^{\text{op}}(c, b)$, fg , in the opposite category C^{op} of C , is represented by

$$\begin{array}{c} \mathcal{C}^{\text{op}} \quad a \\ \boxed{fg} \\ c \end{array} = \begin{array}{c} a \\ \boxed{f} \\ b \\ \boxed{g} \\ c \end{array} \xrightarrow{\text{equivalent}} \begin{array}{c} \mathcal{C} \quad c \\ \boxed{gf} \\ a \end{array} = \begin{array}{c} c \\ \boxed{g} \\ b \\ \boxed{f} \\ a \end{array}, \quad (2.2)$$

where the right-hand side of the symbol “ $\xrightarrow{\text{equivalent}}$ ” represents f and g as morphisms in C . As shown in this diagram, it is common for the background colors of C and C^{op} to be the same. Note that $fg \in C^{\text{op}}(c, a)$ on the left-hand side of Eq. (2.2) is the composite of $g \in C^{\text{op}}(c, b)$ and $f \in C^{\text{op}}(b, a)$, while $gf \in C(a, c)$ on the right-hand side is the composite of $f \in C(a, b)$ and $g \in C(b, c)$. For each category C , a morphism in its opposite category C^{op} is often represented as the corresponding morphism in C , in which case the diagram is flipped vertically. For each morphism $f \in C(a, b)$, the corresponding $f \in C^{\text{op}}(b, a)$ may be written as f^{op} if there is a risk of confusion.

2.1.2 Functors

(1) Diagrammatic notation

Let us represent a functor $F: C \rightarrow D$ as a wire with the label “ F ” like this:

$$\begin{array}{c} \mathcal{D} \\ \boxed{F} \\ \mathcal{C} \end{array}.$$

The regions on the left and right sides represent the categories \mathcal{D} and \mathcal{C} , respectively. As shown in this example, regions with different colors generally indicate different categories. In a diagram, placing the wire representing the functor F to the left of an object or morphism indicates that F is applied to it. For example, for a morphism $f \in C(a, b)$, $Ff \in \mathcal{D}(Fa, Fb)$ is diagrammatically represented by

Each functor preserves the structure of associativity of composition. That is, any functor $F: C \rightarrow \mathcal{D}$ and any two composable morphisms $f \in C(a, b)$ and $g \in C(b, c)$ satisfy $F(gf) = (Fg)(Ff)$ ^{‡2}. This can be depicted by

where we show two equivalent representations. Note that if we remove the auxiliary lines from the left-hand side of the symbol “ $\overset{\text{equivalent}}{\iff}$ ”, then it becomes impossible to distinguish between its left- and right-hand sides, which poses no issue at all since both sides are equal. Also, F maps identity morphisms to identity morphisms.

(2) Several fundamental functors

The identity functor on C , denoted by 1_C , is represented as

As shown on the right-hand side, the wire representing the identity functor is often omitted.

A functor from a category C to a discrete category, denoted as $\mathbf{1}$, with only one object, is uniquely determined by mapping all morphisms in C to the identity morphism 1_* of the unique object $*$ in $\mathbf{1}$. This functor is often denoted by $!$. We represent $!$ with a gray dotted wire; for a morphism f in C , $!f = 1_*$ is represented by

(2.3)

Intuitively, the functor $!$ acts to erase all information about the input. Note that the background of the region representing category $\mathbf{1}$ is white, and the label “ $\mathbf{1}$ ” is often omitted.

The dual of a functor $F: C \rightarrow \mathcal{D}$ is denoted by the same symbol as $F: C^{op} \rightarrow \mathcal{D}^{op}$; however, it may be written as F^{op} when confusion is likely to arise.

(3) Fully faithful functors

^{‡2}When we say “for any $f \in C(a, b)$ ”, unless otherwise stated, we assume that both a and b are also arbitrary.

Let us consider a functor $F: C \rightarrow D$. If the map $C(a, b) \ni f \mapsto Ff \in D(Fa, Fb)$ is bijective for each $a, b \in C$, then F is called **fully faithful**. F is fully faithful if and only if when we fix arbitrary $a, b \in C$, for any $g \in D(Fa, Fb)$, there exists a unique $\bar{g} \in C(a, b)$ such that

$$\begin{array}{c} \mathcal{D} \\ \hline F \quad C \\ \hline \boxed{g} \\ \hline F \\ \hline a \end{array} = \begin{array}{c} \boxed{F \exists! \bar{g}} \\ \hline F \\ \hline a \end{array} . \tag{2.4}$$

In diagrams, the symbol “ $\exists!$ ” means that the block immediately to its right is uniquely determined to satisfy the equation.

2.1.3 Natural transformations

For two functors $F, G: C \rightarrow D$, a natural transformation $\alpha: F \Rightarrow G$ is defined as a collection of indexed morphisms $\alpha := \{\alpha_a \in D(Fa, Ga)\}_{a \in C}$ satisfying

$$Gf \circ \alpha_a = \alpha_b \circ Ff \quad \xrightarrow{\text{diagram}} \quad \begin{array}{c} \mathcal{D} \\ \hline G \quad C \\ \hline \boxed{f} \\ \hline F \\ \hline a \end{array} = \begin{array}{c} \mathcal{D} \\ \hline G \quad C \\ \hline \boxed{\alpha_b} \\ \hline F \\ \hline a \end{array} \tag{nat}$$

for any morphism $f: a \rightarrow b$ in C . In diagrams, we often represent natural transformations with circular blocks (but they can also take on other shapes) like this one:

$$\begin{array}{c} \mathcal{D} \\ \hline G \quad C \\ \hline \alpha \\ \hline F \\ \hline a \end{array} := \left\{ \begin{array}{c} \mathcal{D} \\ \hline G \quad C \\ \hline \alpha \\ \hline F \\ \hline a \end{array} := \begin{array}{c} \mathcal{D} \\ \hline G \quad C \\ \hline \boxed{\alpha_a} \\ \hline F \\ \hline a \end{array} \right\}_{a \in C} . \tag{2.5}$$

We often represent the component α_a of the natural transformation α by placing α immediately to the left of the object a . When the components of a natural transformation are represented as in Eq. (2.5), Eq. (nat) can be rewritten as follows:

$$\begin{array}{c} \mathcal{D} \\ \hline C \\ \hline \boxed{f} \\ \hline \alpha \\ \hline F \\ \hline a \end{array} = \begin{array}{c} \mathcal{D} \\ \hline G \quad C \\ \hline \alpha \\ \hline F \\ \hline a \end{array} = \begin{array}{c} \mathcal{D} \\ \hline G \quad C \\ \hline \alpha \quad \boxed{f} \\ \hline F \\ \hline a \end{array} . \tag{2.6}$$

Intuitively, this equation indicates that the morphism f and the natural transformation α can be moved freely along the wires. This equation is often called the **sliding rule**. The right-hand side of Eq. (2.6) is sometimes denoted by $\alpha \bullet f$, where the operator \bullet represents the horizontal composition, which will be mentioned later.

Objects and morphisms in a category C can be regarded as functors and natural transformations from $\mathbf{1}$ to C , respectively. For example, a functor $F: \mathbf{1} \rightarrow C$ can be identified with an object $F(*)$ in C , and a natural transformation $\alpha: F \Rightarrow G$ with $F, G: \mathbf{1} \rightarrow C$ can be identified with its unique component $\alpha_* \in C(F(*), G(*))$. In this paper, we identify them.

2.2 Vertical and horizontal composition

2.2.1 Vertical composition

For two natural transformations $\alpha: F \Rightarrow G$ and $\beta: G \Rightarrow H$ with $F, G, H: C \rightarrow D$, we write the natural transformation defined by

$$\begin{array}{c} \mathcal{D} \\ H \\ C \\ \beta \\ G \\ \alpha \\ F \end{array} := \left\{ \begin{array}{c} H \\ \beta \\ G \\ \alpha \\ F \\ a \end{array} \right\}_{a \in C} := \left\{ \begin{array}{c} H \\ \beta \\ G \\ \alpha \\ F \\ a \end{array} \right\}_{a \in C} = \left\{ \begin{array}{c} H \\ \beta_a \\ G \\ \alpha_a \\ F \\ a \end{array} \right\}_{a \in C} \quad (2.7)$$

as $\beta \circ \alpha$ or simply as $\beta\alpha$, and call it the **vertical composite** of α and β . It is clear that $\beta\alpha$ is a natural transformation because the sliding rule of Eq. (2.6) gives

$$\begin{array}{c} \mathcal{D} \\ C \\ b \\ H \\ f \\ \beta \\ G \\ \alpha \\ F \\ a \end{array} = \begin{array}{c} H \\ \beta \\ G \\ \alpha \\ F \\ a \\ f \end{array} = \begin{array}{c} H \\ \beta \\ G \\ \alpha \\ F \\ a \\ f \end{array}$$

2.2.2 Horizontal composition

Since functors can be regarded as maps (for objects and morphisms), they can be composed using ordinary map composition. Specifically, for two functors $F: C \rightarrow D$ and $G: D \rightarrow E$, we can consider a map that maps each object a in C to the object $G(Fa)$ and each morphism f in C to the morphism $G(Ff)$. This map, denoted by $G \bullet F$, is a functor known as the **horizontal composite** of F and G . We write $G \bullet F$ as

$$\begin{array}{c} \mathcal{E} \\ G \bullet F \\ C \end{array} = \begin{array}{c} \mathcal{D} \\ G \\ F \end{array}$$

For a functor $F: C \rightarrow D$, if there exists $H: D \rightarrow C$ such that $H \bullet F = 1_C$ and $F \bullet H = 1_D$, then H is called the **inverse** of F and is denoted as F^{-1} . In this case, C and D is called **isomorphic**.

The horizontal composite of two natural transformations can also be defined. We write the horizontal composite of $\alpha: F \Rightarrow F'$ and $\beta: G \Rightarrow G'$ (where $F, F': C \rightarrow D$ and $G, G': D \rightarrow E$) as $\beta \bullet \alpha$, which is depicted by

$$\begin{array}{c} \mathcal{E} \\ G' \bullet F' \\ C \\ \beta \bullet \alpha \\ G \bullet F \end{array} = \begin{array}{c} \mathcal{D} \\ G' \\ F' \\ G \\ F \end{array} := \left\{ \begin{array}{c} G' \\ F' \\ \beta \\ \alpha \\ G \\ F \\ a \end{array} \right\}_{a \in C}$$

Specifically, it is defined as $\beta \bullet \alpha := \{G' \alpha_a \circ \beta_{Fa}\}_{a \in C} = \{\beta_{F'a} \circ G \alpha_a\}_{a \in C}$. Its each component is written as

$$(\beta \bullet \alpha)_a := G' \alpha_a \circ \beta_{Fa} = \beta_{F'a} \circ G \alpha_a$$

$$\begin{array}{c} \mathcal{E} \\ G' \\ \mathcal{D} \\ F' \\ C \\ \beta \\ \alpha \\ G \\ F \\ a \end{array} \xrightarrow{\text{diagram}} \begin{array}{c} G' \\ \alpha \\ G \\ \beta \\ F \\ a \end{array} = \begin{array}{c} G' \\ \alpha \\ G \\ \beta \\ F \\ a \end{array} = \begin{array}{c} G' \\ \beta \\ F' \\ \alpha \\ G \\ F \\ a \end{array}, \quad (2.8)$$

where the equality follows from naturality of β . Thus, the following equation holds:

$$\beta \bullet \alpha = (G' \bullet \alpha) \circ (\beta \bullet F) = (\beta \bullet F') \circ (G \bullet \alpha)$$

where $G' \bullet \alpha$ means $1_{G'} \bullet \alpha$ and $\beta \bullet F$ means $\beta \bullet 1_F$. Note that the horizontal composite with the identity natural transformation is often denoted like this. This equation is also called the **sliding rule**. Equation (sld) intuitively means that α and β can be moved freely along the wires. Since any morphism can be regarded as a natural transformation, Eq. (2.6) can be regarded as a special case of Eq. (sld).

In what follows, when we write something like $\beta \bullet \alpha$ or $\beta \circ \alpha$ for natural transformations α and β , we implicitly assume that they are horizontally or vertically composable. The same applies to functors and morphisms.

Proposition 2.9: For any categories \mathcal{C} , \mathcal{D} , and \mathcal{E} , functors $F, F', F'' : \mathcal{C} \rightarrow \mathcal{D}$ and $G, G', G'' : \mathcal{D} \rightarrow \mathcal{E}$, and natural transformations $\alpha : F \Rightarrow F'$, $\alpha' : F' \Rightarrow F''$, $\beta : G \Rightarrow G'$, and $\beta' : G' \Rightarrow G''$, we have

$$(\beta' \circ \beta) \bullet (\alpha' \circ \alpha) = (\beta' \bullet \alpha') \circ (\beta \bullet \alpha)$$

Proof. From the sliding rule of Eq. (sld), we have

$$\begin{aligned}
 & \text{Diagram 1} \stackrel{(2.8)}{=} \text{Diagram 2} \stackrel{(2.7)}{=} \text{Diagram 3} \stackrel{(2.8)}{=} \text{Diagram 4} \\
 & \text{Diagram 5} \stackrel{(2.8)}{=} \text{Diagram 6} \stackrel{(2.7)}{=} \text{Diagram 7}
 \end{aligned}$$

□

Lemma 2.10: For two functors $F, G: C \rightarrow C$ and two natural transformations $\alpha: F \Rightarrow 1_C$, $\beta: 1_C \Rightarrow G$, we have $\beta\alpha = \beta \bullet \alpha = \alpha \bullet \beta$.

Proof. $\beta\alpha = \beta \bullet \alpha$ can be shown by

$$(2.11)$$

whose corresponding mathematical formula is

$$\beta\alpha = (\beta \bullet 1_C) \circ (1_C \bullet \alpha) = (\beta \circ 1_C) \bullet (1_C \circ \alpha) = \beta \bullet \alpha.$$

Similarly, $\beta\alpha = \alpha \bullet \beta$ can be shown by

$$(2.12)$$

whose corresponding mathematical formula is

$$\beta\alpha = (1_C \bullet \beta) \circ (\alpha \bullet 1_C) = (1_C \circ \alpha) \bullet (\beta \circ 1_C) = \alpha \bullet \beta.$$

□

Proposition 2.13: If a functor $F: C \rightarrow D$ induces a category equivalence $C \simeq D$, then F is fully faithful.

Proof. By the definition of category equivalence, there exist a functor $G: D \rightarrow C$ and natural isomorphisms $\phi: G \bullet F \cong 1_C$ and $\psi: F \bullet G \cong 1_D$. ϕ satisfies $\phi\phi^{-1} = 1_C$ and $\phi^{-1}\phi = 1_{G \bullet F}$, i.e.,

$$(2.14)$$

where the white and blue diamond blocks represent ϕ and ϕ^{-1} , respectively. Similarly, ψ satisfies $\psi\psi^{-1} = 1_D$, i.e.,

$$(2.15)$$

where the white and blue rectangular blocks represent ψ and ψ^{-1} , respectively.

Arbitrarily choose $g \in \mathcal{D}(Fa, Fb)$ (where $a, b \in C$ are also arbitrary); it suffices to show that there exists a unique $\bar{g} \in C(a, b)$ that satisfies Eq. (2.4). If such \bar{g} exists, then

$$(2.4)$$

uniquely determines \bar{g} . Such \bar{g} satisfies $F\bar{g} = g$ since

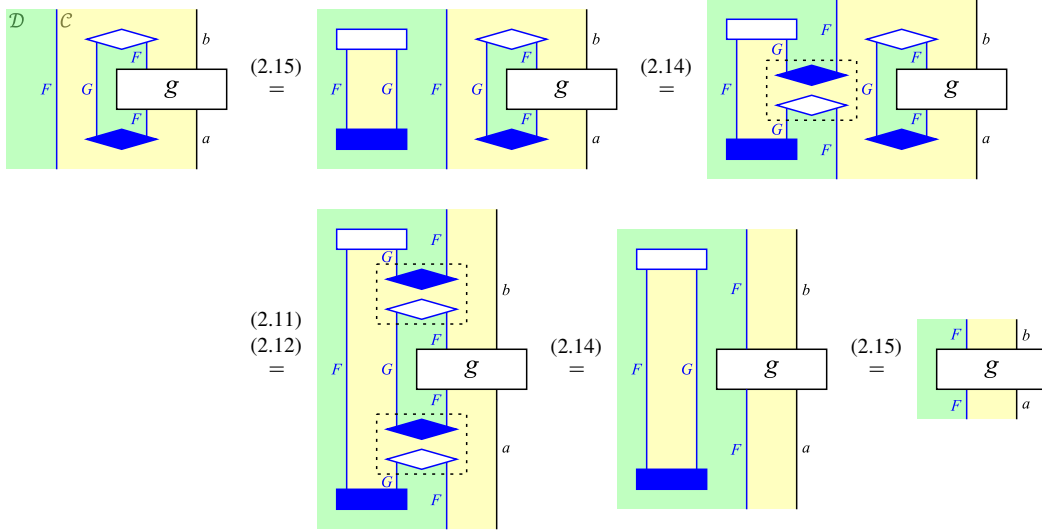

where we use the fact that the areas enclosed by auxiliary lines represent $\phi^{-1}\phi = 1_{G \bullet F}$. □

2.2.3 Functor categories

For two categories C and D , there is a functor category, denoted by \mathcal{D}^C , whose objects are functors from C to D and whose morphisms are natural transformations. A natural transformation $\alpha: F \Rightarrow G$ with $F, G: C \rightarrow D$ can be represented as a morphism in \mathcal{D}^C as follows:

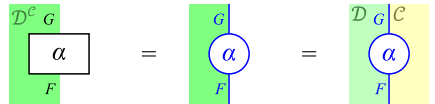

In this paper, when considering the functor category \mathcal{D}^C , it is often assumed without notice that C is small (to ensure that \mathcal{D}^C is locally small).

Example 2.16 (pre-composition with a functor): Pre-composition with a functor $F: C \rightarrow D$ is denoted by $-\bullet F$. For any category \mathcal{E} , this becomes a functor from \mathcal{E}^D to \mathcal{E}^C . In diagrams, $-\bullet F$ corresponds to the action of placing F on the right side. The action on morphisms of F can be expressed as follows (intuitively, it works like “drawing the wire F on the right side”).

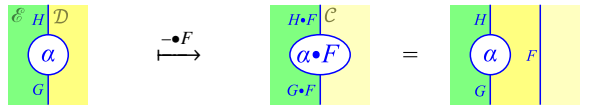

Also, for a natural transformation $\gamma: F \Rightarrow G$ with $F, G: C \rightarrow D$, pre-composition with γ can be denoted as $-\bullet \gamma$, which becomes a natural transformation from $-\bullet F$ to $-\bullet G$.

Example 2.17 (post-composition with a functor): Similarly to Example 2.16, post-composition with a functor $F: D \rightarrow E$ is denoted by $F \bullet -$. For any category C , $F \bullet -$ becomes a functor from \mathcal{D}^C to \mathcal{E}^C . In diagrams, $F \bullet -$ corresponds to the action of placing F on the left side. Similarly, for a natural transformation $\gamma: F \Rightarrow G$ with $F, G: D \rightarrow E$, post-composition with γ is denoted by $\gamma \bullet -$, which becomes a natural transformation from $F \bullet -$ to $G \bullet -$. In this paper, when representing $F \bullet -$ and/or $\gamma \bullet -$ in diagrams, we often simply

use labels such as “ F ” and/or “ γ ” to represent them like this:

When confusion is likely to occur, we use labels such as “ $F \bullet -$ ” and/or “ $\gamma \bullet -$ ”.

For two functors $F: C \rightarrow D$ and $G: D \rightarrow E$, we can introduce a diagram that represents the identity natural transformation $1_{G \bullet F}$ as shown in the following left- and right-hand sides.

where on each side, $1_{G \bullet F}$ is represented as a diagram where two wires cross. While these expressions may feel like they just complicate the central expression, this kind of notation can be convenient when you want to replace the wire $- \bullet F$ with the wire F in the diagram.

Example 2.19 (evaluation functors): For any object d in a category \mathcal{D} , we can define a functor $- \bullet d$ by considering the case of $C = \mathbf{1}$ in Example 2.16. $- \bullet d$ is called an **evaluation functor** and is written as ev_d . The functor $ev_d: \mathcal{E}^{\mathcal{D}} \rightarrow \mathcal{E}$ maps each functor $F: \mathcal{D} \rightarrow \mathcal{E}$ to the object $Fd \in \mathcal{E}$ and each natural transformation $\alpha: F \Rightarrow G$ with $F, G: \mathcal{D} \rightarrow \mathcal{E}$ to the morphism $\alpha_d \in \text{mor } \mathcal{E}$. $ev_d \alpha = \alpha \bullet d$ can be represented by

Example 2.21 (diagonal functors): When considering the case of $\mathcal{D} = \mathbf{1}$ in Example 2.16, F is a functor from C to $\mathbf{1}$, and thus is the unique functor $!$, which maps all morphisms in C to 1_* (see Subsubsection 2.1.2). The functor $- \bullet !: \mathcal{E} \rightarrow \mathcal{E}^C$ is called a **diagonal functor** and is denoted by Δ_C . $\Delta_C f = f \bullet !$ is represented by

where the gray dotted wire is $!$ (recall Eq. (2.3)).

Lemma 2.23: For categories C , \mathcal{D} , and \mathcal{E} , if a functor $H: \mathcal{D} \rightarrow \mathcal{E}$ is fully faithful, then $H \bullet -: \mathcal{D}^C \rightarrow \mathcal{E}^C$ is also fully faithful. That is, for any natural transformation $\tau: H \bullet F \Rightarrow H \bullet G$ with any $F, G: C \rightarrow \mathcal{D}$, there exists a natural transformation $\bar{\tau}: F \Rightarrow G$ such that

Proof. We show Eq. (2.24). Since H is fully faithful, for each $c \in \mathcal{C}$ there exists a unique $\bar{\tau}_c \in \mathcal{D}(Fc, Gc)$ satisfying

$$\begin{array}{c} \mathcal{E} \\ \hline \mathcal{D} \quad G \quad \mathcal{C} \\ \hline H \quad F \\ \hline \tau \end{array} \quad c \quad (2.4) \quad = \quad \begin{array}{c} G \quad c \\ \hline \bar{\tau}_c \\ \hline F \quad c \end{array} \quad (2.25)$$

Therefore, it suffices to show that $\bar{\tau} := \{\bar{\tau}_c\}_{c \in \mathcal{C}}$ is a natural transformation. We have for any $f \in \mathcal{C}(c, c')$,

$$\begin{array}{c} \mathcal{E} \quad \mathcal{D} \quad \mathcal{C} \quad c' \\ \hline G \quad f \\ \hline H \quad \bar{\tau}_c \\ \hline F \quad c \end{array} \quad (2.25) \quad = \quad \begin{array}{c} \mathcal{H} \quad G \quad c' \\ \hline f \\ \hline H \quad F \\ \hline \tau \end{array} \quad c \quad (slid) \quad = \quad \begin{array}{c} H \quad G \quad c' \\ \hline \tau \\ \hline H \quad F \\ \hline f \\ \hline c \end{array} \quad (2.25) \quad = \quad \begin{array}{c} G \quad c' \\ \hline \bar{\tau}_{c'} \\ \hline F \quad f \\ \hline c \end{array}$$

Thus, since H is fully faithful, we have

$$\begin{array}{c} \mathcal{D} \quad \mathcal{C} \quad c' \\ \hline G \quad f \\ \hline \bar{\tau}_c \\ \hline F \quad c \end{array} \quad = \quad \begin{array}{c} G \quad c' \\ \hline \bar{\tau}_{c'} \\ \hline F \quad f \\ \hline c \end{array}$$

Therefore, $\bar{\tau}$ is a natural transformation. □

Let us apply the diagram introduced in Eq. (2.18) to the evaluation functor ev_d from Example 2.19. The identity natural transformation 1_{ev_d} can be depicted as

$$1_{ev_d} \quad \xrightarrow{\text{diagram}} \quad \begin{array}{c} \mathcal{E}^{\mathcal{D}} \\ \hline \mathcal{E} \\ \hline - \\ \hline \mathcal{D} \quad d \end{array} \quad = \quad \begin{array}{c} | \\ | \\ | \end{array} \quad = \quad \begin{array}{c} - \\ \hline \mathcal{E}^{\mathcal{D}} \\ \hline ev_d \\ \hline - \\ \hline d \end{array} \quad , \quad (2.26)$$

where the left-hand side represents

$$1_{ev_d} = \{1_{ev_d G}\}_{G \in \mathcal{E}^{\mathcal{D}}} \quad \xrightarrow{\text{diagram}} \quad \begin{array}{c} \mathcal{E}^{\mathcal{D}} \\ \hline \mathcal{E} \\ \hline - \\ \hline \mathcal{D} \quad d \end{array} \quad := \quad \left\{ \begin{array}{c} ev_d \quad G \\ \hline \mathcal{E}^{\mathcal{D}} \\ \hline G \\ \hline \mathcal{D} \quad d \end{array} \right\}_{G \in \mathcal{E}^{\mathcal{D}}}$$

and likewise for the right-hand side. Equation (2.26) may be useful when you want to swap the wire ev_d and the wire d .

$$ev_d \alpha = \alpha_d \quad \xrightarrow{\text{diagram}} \quad \begin{array}{c} \mathcal{E} \quad \mathcal{E}^{\mathcal{D}} \quad G \\ \hline ev_d \quad \alpha \\ \hline F \quad \mathcal{D} \quad d \end{array} \quad = \quad \begin{array}{c} ev_d \quad G \\ \hline \alpha \\ \hline G \quad F \\ \hline \mathcal{D} \quad d \end{array} \quad (2.27)$$

obviously holds. Also, the first equality of Eq. (2.20) can be shown by

$$\begin{array}{c} \mathcal{E} \quad \mathcal{E}^{\mathcal{D}} \quad G \\ \hline ev_d \quad \alpha \\ \hline F \end{array} \quad (2.26) \quad = \quad \begin{array}{c} \mathcal{E}^{\mathcal{D}} \quad G \\ \hline \alpha \\ \hline F \quad \mathcal{D} \quad d \end{array} \quad (2.27) \quad = \quad \begin{array}{c} ev_d \quad G \\ \hline \alpha \\ \hline G \quad F \end{array} \quad (2.26) \quad = \quad \begin{array}{c} G \\ \hline \alpha \\ \hline F \end{array} \quad d$$

These diagrams for the evaluation functors $\text{ev}_d = - \bullet d$ can be generalized to the functor $- \bullet F$ with any $F: C \rightarrow D$. For example, as a generalization of Eq. (2.27), for any $F, F': C \rightarrow D$, $G, G': D \rightarrow E$, $\alpha: F \Rightarrow F'$, and $\beta: G \Rightarrow G', \beta \bullet \alpha: G \bullet F \Rightarrow G' \bullet F'$ can be depicted by

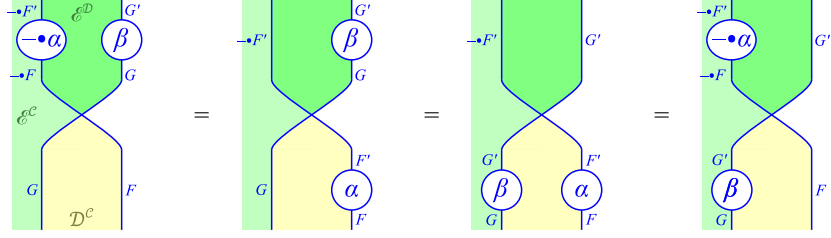

2.2.4 Objects, morphisms, categories, and functors are all instances of natural transformations

We already mentioned that morphisms can be regarded as special cases of natural transformations. Here, we mention that functors, categories, and objects can also be regarded as special cases of natural transformations. This fact indicates that they can be treated uniformly as natural transformations. Specifically, we can make the following identifications:

- Functors: Any functor F can be identified with its identity natural transformation 1_F .
- Categories: Any category C can be identified with its identity functor 1_C , and thus can be identified with the identity natural transformation 1_{1_C} .
- Objects: Any object a in a category C can be regarded as a functor from $\mathbf{1}$ to C , and thus can be identified with the identity natural transformation 1_a .

As a result, the diagrams presented in this paper can be seen as representing natural transformations that are formed through vertical and/or horizontal composition of natural transformations.

2.3 Product of categories and bifunctors

2.3.1 Product of categories

In this subsection and Section 7, we employ certain diagrams that exhibit slight variations from those previously introduced.

An object $\langle c, d \rangle$ (where $c \in C$ and $d \in D$) in a product category $C \times D$ is represented by the following two expressions:

$$C \times D \Big|_{\langle c, d \rangle} = \begin{array}{c} C \\ \uparrow \\ c \end{array} \Big| \begin{array}{c} D \\ \uparrow \\ d \end{array} .$$

The left-hand side employs the same expression as before, while the right-hand side introduces a new expression. For convenience, we will call the latter expression “the expression for direct products”. As shown on the right-hand side, we represent $\langle c, d \rangle$ by arranging the two arrows representing $c \in C$ and $d \in D$ side by side. Also, to indicate that it is a direct product, a gray dashed line is drawn between the two arrows. Note that in this expression, we represent objects with arrows instead of wires; such arrows will become useful in Section 7.

A morphism with domain $\langle c, d \rangle$ and codomain $\langle c', d' \rangle$ in $C \times D$ is represented as a pair $\langle f, g \rangle$, where $f \in C(c, c')$ and $g \in D(d, d')$. This morphism is represented by

$$C \times D \Big|_{\langle c, d \rangle} \langle f, g \rangle = \begin{array}{c} C \\ \uparrow \\ c \end{array} \Big| \begin{array}{c} D \\ \uparrow \\ d \end{array} \begin{array}{c} \boxed{f} \\ \boxed{g} \end{array} ,$$

where the right-hand side is the expression for direct products. In this way, we represent $\langle f, g \rangle$ by arranging the two morphisms f and g side by side. The composite of two morphisms $\langle f, g \rangle : \langle c, d \rangle \rightarrow \langle c', d' \rangle$ and $\langle f', g' \rangle : \langle c', d' \rangle \rightarrow \langle c'', d'' \rangle$ is

$$\langle f', g' \rangle \circ \langle f, g \rangle := \langle f'f, g'g \rangle \quad \xrightarrow{\text{diagram}} \quad \begin{array}{c} \begin{array}{|c|c|} \hline \mathcal{C} & \mathcal{D} \\ \hline \begin{array}{c} c'' \uparrow \\ \boxed{f'} \\ c' \uparrow \end{array} & \begin{array}{c} d'' \uparrow \\ \boxed{g'} \\ d' \uparrow \end{array} \\ \hline \end{array} \\ \begin{array}{|c|c|} \hline \begin{array}{c} \boxed{f} \\ c \uparrow \end{array} & \begin{array}{c} \boxed{g} \\ d \uparrow \end{array} \\ \hline \end{array} \end{array}, \quad (2.28)$$

where a composite of morphisms is represented by connecting them. This diagram can be interpreted as arranging the two morphisms $f'f$ and $g'g$ side by side. Using Eq. (2.28) and the properties of identity morphisms, we obtain

$$\langle 1_{c'}, g \rangle \circ \langle f, 1_d \rangle = \langle f, g \rangle = \langle f, 1_{d'} \rangle \circ \langle 1_c, g \rangle$$

$$\xrightarrow{\text{diagram}} \begin{array}{c} \begin{array}{|c|c|} \hline \mathcal{C} & \mathcal{D} \\ \hline \begin{array}{c} c' \uparrow \\ \boxed{g} \\ d' \uparrow \end{array} & \begin{array}{c} \boxed{f} \\ c \uparrow \end{array} \\ \hline \end{array} \\ \begin{array}{|c|c|} \hline \begin{array}{c} \boxed{f} \\ c \uparrow \end{array} & \begin{array}{c} \boxed{g} \\ d \uparrow \end{array} \\ \hline \end{array} \\ \end{array} = \begin{array}{c} \begin{array}{|c|c|} \hline \begin{array}{c} c' \uparrow \\ \boxed{f} \\ c \uparrow \end{array} & \begin{array}{c} d' \uparrow \\ \boxed{g} \\ d \uparrow \end{array} \\ \hline \end{array} \\ \begin{array}{|c|c|} \hline \begin{array}{c} \boxed{f} \\ c \uparrow \end{array} & \begin{array}{c} \boxed{g} \\ d \uparrow \end{array} \\ \hline \end{array} \\ \end{array} = \begin{array}{c} \begin{array}{|c|c|} \hline \mathcal{C} & \mathcal{D} \\ \hline \begin{array}{c} c' \uparrow \\ \boxed{f} \\ c \uparrow \end{array} & \begin{array}{c} d' \uparrow \\ \boxed{g} \\ d \uparrow \end{array} \\ \hline \end{array} \\ \begin{array}{|c|c|} \hline \begin{array}{c} \boxed{f} \\ c \uparrow \end{array} & \begin{array}{c} \boxed{g} \\ d \uparrow \end{array} \\ \hline \end{array} \\ \end{array}. \quad (2.29)$$

2.3.2 Bifunctors

The mapping of a morphism $\langle f, g \rangle : \langle c, d \rangle \rightarrow \langle c', d' \rangle$ in $\mathcal{C} \times \mathcal{D}$ with a bifunctor $F : \mathcal{C} \times \mathcal{D} \rightarrow \mathcal{E}$ is often written by $F(\langle f, g \rangle)$. $F(\langle f, g \rangle)$ is represented by the following two expressions:

$$\begin{array}{c} \mathcal{E} \\ \uparrow \\ \mathcal{C} \times \mathcal{D} \\ \langle c', d' \rangle \\ \boxed{\langle f, g \rangle} \\ \langle c, d \rangle \end{array} = \begin{array}{c} \mathcal{E} \\ \uparrow \\ \mathcal{C} \times \mathcal{D} \\ \langle c', d' \rangle \\ \begin{array}{|c|c|} \hline \begin{array}{c} c' \uparrow \\ \boxed{f} \\ c \uparrow \end{array} & \begin{array}{c} d' \uparrow \\ \boxed{g} \\ d \uparrow \end{array} \\ \hline \end{array} \\ \langle c, d \rangle \end{array}, \quad (2.30)$$

where the right-hand side is the expression for direct products. In this expression, we represent the functor F by two blue arrows (with the arrowhead omitted on the right one). Note that such an expression can be found in, for example, Refs. [9, 10]. The area enclosed by these two arrows represents the input to F ; in the case of Eq. (2.30), $\langle f, g \rangle$ is the input to F .

For two bifunctors $F, G : \mathcal{C} \times \mathcal{D} \rightarrow \mathcal{E}$, naturality of a natural transformation $\alpha : F \Rightarrow G$ can be expressed by

$$\begin{array}{c} \mathcal{E} \\ \uparrow \\ \mathcal{C} \times \mathcal{D} \\ \langle c', d' \rangle \\ \begin{array}{|c|c|} \hline \begin{array}{c} c' \uparrow \\ \boxed{f} \\ c \uparrow \end{array} & \begin{array}{c} d' \uparrow \\ \boxed{g} \\ d \uparrow \end{array} \\ \hline \end{array} \\ \langle c, d \rangle \end{array} \xrightarrow{\alpha} \begin{array}{c} \mathcal{E} \\ \uparrow \\ \mathcal{C} \times \mathcal{D} \\ \langle c', d' \rangle \\ \boxed{\alpha_{c', d'}} \\ \langle c, d \rangle \end{array} = \begin{array}{c} \mathcal{E} \\ \uparrow \\ \mathcal{C} \times \mathcal{D} \\ \langle c', d' \rangle \\ \begin{array}{|c|c|} \hline \begin{array}{c} c' \uparrow \\ \boxed{\alpha_{c', d'}} \\ c \uparrow \end{array} & \begin{array}{c} d' \uparrow \\ \boxed{\alpha_{c', d'}} \\ d \uparrow \end{array} \\ \hline \end{array} \\ \langle c, d \rangle \end{array} \xrightarrow{\alpha} \begin{array}{c} \mathcal{E} \\ \uparrow \\ \mathcal{C} \times \mathcal{D} \\ \langle c', d' \rangle \\ \begin{array}{|c|c|} \hline \begin{array}{c} c' \uparrow \\ \boxed{f} \\ c \uparrow \end{array} & \begin{array}{c} d' \uparrow \\ \boxed{g} \\ d \uparrow \end{array} \\ \hline \end{array} \\ \langle c, d \rangle \end{array} \quad (2.31)$$

for any $f \in \mathcal{C}(c, c')$ and $g \in \mathcal{D}(d, d')$. The label on the left or right arrow of each functor is often omitted.

Example 2.32: For any bifunctor $F : \mathcal{C} \times \mathcal{D} \rightarrow \mathcal{E}$ and object $c \in \mathcal{C}$, there exists a functor, denoted by $F(c, -) : \mathcal{D} \rightarrow \mathcal{E}$, that

- maps each object $d \in \mathcal{D}$ to $F(c, d)$.
- maps each morphism $g \in \text{mor } \mathcal{D}$ to $F(1_c, g)$, which we often write as $F(c, g)$.

Such a functor can be intuitively understood as fixing one variable of a two-variable map.

$F(c, -)$ can be represented as

$$F(c, -) \xrightarrow{\text{diagram}} \begin{array}{|c|c|c|} \hline \mathcal{E} & \mathcal{C} & \mathcal{D} \\ \hline F \uparrow & c \uparrow & \uparrow \\ \hline & & - \\ \hline F \downarrow & & \downarrow \\ \hline \end{array} .$$

In this diagram, objects and morphisms in \mathcal{D} are placed in regions representing \mathcal{D} . For example, the morphism, $F(c, g)$, obtained by mapping a morphism $g \in \mathcal{D}(d, d')$ with this functor is represented by

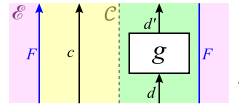

It is easy to see that $F(c, -)$ is a functor. Indeed,

$$F(c, g'g) = F(c, g') \circ F(c, g) \xrightarrow{\text{diagram}} \begin{array}{|c|c|c|} \hline \mathcal{E} & \mathcal{C} & \mathcal{D} \\ \hline F \uparrow & c \uparrow & \uparrow \\ \hline & & g'g \\ \hline F \downarrow & & \downarrow \\ \hline \end{array} = \begin{array}{|c|c|c|} \hline \mathcal{E} & \mathcal{C} & \mathcal{D} \\ \hline F \uparrow & c \uparrow & \uparrow \\ \hline & & g' \\ \hline & & g \\ \hline F \downarrow & & \downarrow \\ \hline \end{array}$$

holds. It is also clear that an identity morphism is mapped to an identity morphism. Similarly, for each $d \in \mathcal{D}$, the functor $F(-, d): \mathcal{C} \rightarrow \mathcal{E}$ is obtained.

Example 2.33: For any bifunctor $F: \mathcal{C} \times \mathcal{D} \rightarrow \mathcal{E}$ and morphism $f \in \mathcal{C}(c, c')$, let us define $F(f, -) := \{F(f, d)\}_{d \in \mathcal{D}}$. Then, $F(f, -)$ is a natural transformation from $F(c, -)$ to $F(c', -)$; indeed, we have for each $g \in \mathcal{D}(d, d')$,

$$\begin{array}{|c|c|} \hline \mathcal{E} & \mathcal{D} \\ \hline F(c', -) & \begin{array}{|c|} \hline d' \\ \hline g \\ \hline d \\ \hline \end{array} \\ \hline F(c, -) & \begin{array}{|c|} \hline d \\ \hline F(f, -)_d \\ \hline d \\ \hline \end{array} \\ \hline \end{array} = \begin{array}{|c|c|} \hline \mathcal{C} & \mathcal{D} \\ \hline F \uparrow & c' \uparrow \\ \hline & f \\ \hline F \downarrow & c \downarrow \\ \hline \end{array} \begin{array}{|c|} \hline d' \\ \hline g \\ \hline d \\ \hline \end{array} = \begin{array}{|c|c|} \hline \mathcal{C} & \mathcal{D} \\ \hline F \uparrow & c \uparrow \\ \hline & f \\ \hline F \downarrow & c \downarrow \\ \hline \end{array} \begin{array}{|c|} \hline d' \\ \hline g \\ \hline d \\ \hline \end{array} = \begin{array}{|c|c|} \hline \mathcal{E} & \mathcal{D} \\ \hline F(c', -) & \begin{array}{|c|} \hline d' \\ \hline F(f, -)_{d'} \\ \hline d' \\ \hline \end{array} \\ \hline F(c, -) & \begin{array}{|c|} \hline d' \\ \hline g \\ \hline d \\ \hline \end{array} \\ \hline \end{array} ,$$

(2.29)

where the second and third expressions are for direct products.

Example 2.34: The evaluation functor discussed in Example 2.19 can be extended to the bifunctor, denoted by $\text{ev}: \mathcal{E}^{\mathcal{D}} \times \mathcal{D} \rightarrow \mathcal{E}$, that

- maps each object $\langle K, d \rangle$ to the object $K \bullet d = Kd$.
- maps each morphism $\langle \alpha, f \rangle$ to the morphism $\alpha \bullet f$.

This bifunctor is often referred to as the **evaluation functor**.

Lemma 2.35: Let us consider two bifunctors $F, G: C \times \mathcal{D} \rightarrow \mathcal{E}$. For a collection of morphisms $\alpha := \{\alpha_{c,d}: F(c, d) \rightarrow G(c, d)\}_{c \in C, d \in \mathcal{D}}$ in \mathcal{E} , the following are equivalent:

- (1) α is a natural transformation from F to G .
- (2) The following two conditions hold:
 - (2.a) For each $c \in C$, $\{\alpha_{c,d}\}_{d \in \mathcal{D}}$ is a natural transformation from $F(c, -)$ to $G(c, -)$.
 - (2.b) For each $d \in \mathcal{D}$, $\{\alpha_{c,d}\}_{c \in C}$ is a natural transformation from $F(-, d)$ to $G(-, d)$.

Proof. (1) \Rightarrow (2): Condition (2.a) is equivalent to satisfying

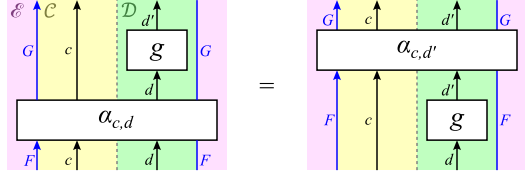

$$(2.36)$$

for any $g \in \mathcal{D}(d, d')$ and $c \in C$, and Condition (2.b) is equivalent to satisfying

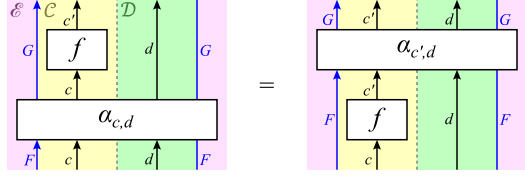

$$(2.37)$$

for any $f \in C(c, c')$ and $d \in \mathcal{D}$. Substituting $f = 1_c$ into Eq. (2.31) yields Eq. (2.36). Also, substituting $g = 1_d$ into Eq. (2.31) yields Eq. (2.37).

(2) \Rightarrow (1): For any $f \in C(c, c')$ and $g \in \mathcal{D}(d, d')$, we have^{‡3}

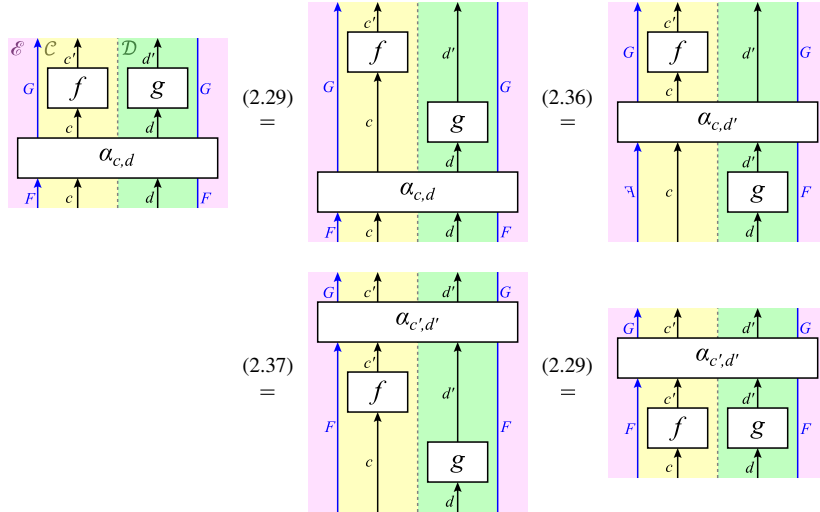

$$(2.29) \quad (2.36) \quad (2.29)$$

$$(2.37) \quad (2.29)$$

Therefore, Eq. (2.31) holds, which means that α is a natural transformation. \square

^{‡3}In mathematical notation,

$$\begin{aligned} G(f, g) \circ \alpha_{c,d} &= G(f, d') \circ G(c, g) \circ \alpha_{c,d} = G(f, d') \circ \alpha_{c,d'} \circ F(c, g) \\ &= \alpha_{c',d'} \circ F(f, d') \circ F(c, g) = \alpha_{c',d'} \circ F(f, g). \end{aligned}$$

Intuitively, Condition (1) can be interpreted as allowing morphisms in \mathcal{C} and morphisms in \mathcal{D} to pass through α as shown in Eq. (2.31), while Condition (2) can be interpreted as allowing morphisms in \mathcal{C} to pass through α as shown in Eq. (2.36), and also allowing morphisms in \mathcal{D} to pass through α as shown in Eq. (2.37). It should be easy to conceive that these conditions are equivalent.

Note that it might be easier to visually understand if we represent the natural transformation α as a pair of blocks, and each component $\alpha_{c,d}$ as

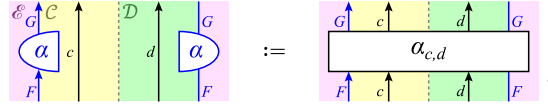

Due to the fact that we represents a functor with a pair of arrows, here we represents a natural transformation with a pair of blocks. Naturality of Eq. (2.31) is represented as

$$G(f, g) \circ \alpha_{c,d} = \alpha_{c',d'} \circ F(f, g)$$

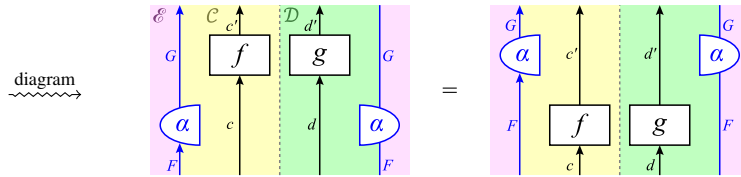

3 The Yoneda lemma and universal properties

Adjunctions, (co)limits, and Kan extensions, which will be explained in the following sections, can be understood as certain types of universal morphisms. In this sense, a universal property, which universal morphisms possess, is a vital concept in category theory. A universal property is closely related to representability, which can be proven through the Yoneda lemma. The Yoneda lemma is “arguably the most important result in category theory” [12]. After proving the Yoneda lemma using string diagrams, we state some basic properties of universal morphisms.

3.1 The Yoneda lemma

3.1.1 Preliminaries: diagrams for set-valued functors and natural transformations between them

(1) Functor \square^c and natural transformation \square^p

Let **Set** denote the category whose objects are sets and whose morphisms from a set X to a set Y are maps from X to Y . For each $c \in \mathcal{C}$, we can define a set-valued functor $\mathcal{C}(c, -): \mathcal{C} \rightarrow \mathbf{Set}$ that

- maps each object a in \mathcal{C} to the hom-set $\mathcal{C}(c, a)$.
- maps each morphism $f: a \rightarrow b$ in \mathcal{C} to the map $f \circ -: \mathcal{C}(c, a) \ni g \mapsto fg \in \mathcal{C}(c, b)$.

We often write $\mathcal{C}(c, -)$ as \square^c . In what follows, we represent $\mathcal{C}(c, a)$ with

$$\begin{array}{c} \mathcal{C} \quad a \\ \hline \square \\ \hline c \end{array} := \mathcal{C}(c, a) = \left\{ \begin{array}{c} a \\ \hline g \\ \hline c \end{array} \right\}_{g \in \mathcal{C}(c, a)} \quad (3.1)$$

Intuitively, the dotted box acts like a hole, which takes any morphism with domain c and codomain a . It is convenient to represent the functor \square^c with

$$\begin{array}{c} \mathbf{Set} \quad \mathcal{C} \\ \hline \square^c \end{array} =: \begin{array}{c} \mathcal{C} \quad - \\ \hline \square \\ \hline c \end{array} \quad (3.2)$$

The right-hand side of this equation will contain objects or morphisms in C . Specifically, $\square^c \bullet a = C(c, a)$ with $a \in C$ and $\square^c \bullet f = f \circ -$ with $f \in C(a, b)$ are represented by^{‡4}

$$\begin{array}{c} \text{Set} \\ \square^c \\ \hline C \\ \hline b \\ \hline f \\ \hline a \\ \hline \end{array} = \begin{array}{c} C(c, b) \\ \hline f \circ - \\ \hline C(c, a) \end{array} = \left\{ \begin{array}{c} b \\ \hline f \\ \hline a \\ \hline g \\ \hline c \end{array} \right\}_{g \in C(c, a)} =: \begin{array}{c} C \\ \hline b \\ \hline f \\ \hline a \\ \hline \square^c \\ \hline c \end{array} . \quad (3.3)$$

The last expression can be easily understood as the following map:

$$\begin{array}{c} a \\ \hline g \\ \hline c \end{array} \xrightarrow{f \circ -} \begin{array}{c} b \\ \hline f \\ \hline a \\ \hline g \\ \hline c \end{array} .$$

We can interpret $f \circ -$ as the map applying f from the top side in a diagram.

For each morphism $p \in C(c, d)$, a natural transformation $\square^p: \square^d \Rightarrow \square^c$ is defined as

$$\square^p := \{\square^p_a := - \circ p \in \mathbf{Set}(C(d, a), C(c, a))\}_{a \in C}, \quad (3.4)$$

where $- \circ p$ is the map $C(d, a) \ni g \mapsto gp \in C(c, a)$. We represent \square^p as

$$\begin{array}{c} \text{Set} \\ \square^c \\ \hline C \\ \hline \square^p \\ \hline \square^d \\ \hline \end{array} = \left\{ \begin{array}{c} C(c, a) \\ \hline - \circ p \\ \hline C(d, a) \end{array} \right\}_{a \in C} = \left\{ \begin{array}{c} a \\ \hline \square^c \\ \hline d \\ \hline p \\ \hline c \end{array} \right\}_{a \in C} =: \begin{array}{c} C \\ \hline - \\ \hline d \\ \hline p \\ \hline c \end{array} . \quad (3.5)$$

In the central expression, we represent $- \circ p$ in the same way as $f \circ -$ in Eq. (3.3). The right-hand side is a visually easier representation of the central expression. The dotted box on the right-hand side represents the functor \square^d (recall Eq. (3.2)). Intuitively, it can be interpreted as the transformation of a functor \square^d into a functor \square^c by the pre-composition of p . It would become clear if we consider placing each object in C within the region indicated by $-$ on the right-hand side. We have for each $f \in C(a, b)$,

$$\begin{array}{c} \text{Set} \\ \square^c \\ \hline C \\ \hline b \\ \hline f \\ \hline a \\ \hline - \circ p \\ \hline a \\ \hline \square^d \\ \hline \end{array} \stackrel{(\text{nat})}{=} \begin{array}{c} \square^c \\ \hline b \\ \hline - \circ p \\ \hline \square^d \\ \hline b \\ \hline f \\ \hline a \\ \hline \end{array} \stackrel{\text{equivalent}}{\iff} \begin{array}{c} C \\ \hline b \\ \hline f \\ \hline a \\ \hline \square^d \\ \hline d \\ \hline p \\ \hline c \end{array} = \begin{array}{c} C \\ \hline b \\ \hline f \\ \hline a \\ \hline \square^c \\ \hline d \\ \hline p \\ \hline c \end{array} , \quad (3.6)$$

and thus naturality of \square^p holds. In each of the left- and right-hand sides of the symbol “ $\stackrel{\text{equivalent}}{\iff}$ ”, the left-hand side is the map that first applies the map $- \circ p$ and then applies the map $\square^c(f) = f \circ -$, while the right-hand side is the map that first applies the map $\square^d(f) = f \circ -$ and then applies the map $- \circ p$. Both maps are equal to the map $f \circ - \circ p: C(d, a) \ni h \mapsto fh p \in C(c, b)$.

A set-valued functor from an opposite category C^{op} is called a **presheaf**. By replacing category C with its opposite category C^{op} , we can define the presheaf $c^\square := C(-, c): C^{\text{op}} \rightarrow \mathbf{Set}$. It

^{‡4}We identify a map $h: X \rightarrow Y$ with the indexed collection $\{h(x)\}_{x \in X}$. Then, $f \circ -$ is identified with $\{fg\}_{g \in C(c, a)}$.

would be easy to understand if we represent functor c^\square with

$$\text{Set} \left| \begin{array}{c} \mathcal{C}^{\text{op}} \\ c^\square \end{array} \right. =: \left. \begin{array}{c} \mathcal{C} \\ c \\ \square \\ - \end{array} \right.$$

which can be seen as the “upside-down” version of Eq. (3.2). Note that, to avoid confusion, we have changed the background color of categories \mathcal{C} and \mathcal{C}^{op} . $c^\square \bullet a = C(a, c)$ with $a \in \mathcal{C}^{\text{op}}$ and $c^\square \bullet f = - \circ f$ with $f \in C^{\text{op}}(a, b) = C(b, a)$ are represented by

$$\text{Set} \left| \begin{array}{c} \mathcal{C}^{\text{op}} \\ b \\ f \\ a \end{array} \right. = \left. \begin{array}{c} \mathcal{C}(b, c) \\ - \circ f \\ \mathcal{C}(a, c) \end{array} \right. = \left\{ \left. \begin{array}{c} \mathcal{C} \\ c \\ g \\ a \\ f \\ b \end{array} \right\}_{g \in \mathcal{C}(a, c)} =: \left. \begin{array}{c} \mathcal{C} \\ c \\ \square \\ a \\ f \\ b \end{array} \right.$$

We can interpret $- \circ f$ as the map applying $f \in C(b, a)$ from the bottom side in a diagram. The domain $\mathcal{C}(a, c)$ of $- \circ f$ corresponds to the codomain a of f , resulting in an upside-down diagram. Using a similar approach to \square^p , we can define the natural transformation q^\square for each $q \in C(c, d)$ as

$$q^\square := \{q^\square_a := q \circ - \in \text{Set}(c^\square(a), d^\square(a))\}_{a \in \mathcal{C}}. \quad (3.7)$$

Similar to Eq. (3.2), it would be natural to represent the hom functor $C(-, =)$ as

$$\text{Set} \left| \begin{array}{c} \mathcal{C}^{\text{op}} \times \mathcal{C} \\ \mathcal{C}(-, =) \end{array} \right. =: \left. \begin{array}{c} \mathcal{C} \\ = \\ \square \\ - \end{array} \right. \quad (3.8)$$

The hom functor $C(-, =)$ maps an object $\langle a, b \rangle \in \mathcal{C}^{\text{op}} \times \mathcal{C}$ to the hom-set $C(a, b)$ and a morphism $\langle f, g \rangle \in \text{mor}(\mathcal{C}^{\text{op}} \times \mathcal{C})$ (with $f \in C(a', a)$ and $g \in C(b, b')$) to the map $g \circ - \circ f: C(a, b) \ni h \mapsto ghf \in C(a', b')$, which can be represented by

$$\text{Set} \left| \begin{array}{c} \mathcal{C}^{\text{op}} \times \mathcal{C} \\ \langle a, b \rangle \\ \mathcal{C}(-, =) \end{array} \right. = \left. \begin{array}{c} \mathcal{C} \\ b \\ \square \\ a \end{array} \right. , \quad \left. \begin{array}{c} \mathcal{C}^{\text{op}} \times \mathcal{C} \\ \langle f, g \rangle \\ \mathcal{C}(-, =) \end{array} \right. = \left. \begin{array}{c} \mathcal{C}(a', b') \\ g \circ - \circ f \\ \mathcal{C}(a, b) \end{array} \right. =: \left. \begin{array}{c} \mathcal{C} \\ b' \\ g \\ b \\ \square \\ a \\ f \\ a' \end{array} \right. \quad (3.9)$$

(2) Rules for dotted box notation

Using the following examples, we clarify the rules for notation using a dotted box (referred to as dotted box notation).

- (A) hom-set: $C(c, a)$ [Eq. (3.1)] (B) map: $f \circ -$ [Eq. (3.3)] (C) set-valued functor: \square^c [Eq. (3.2)] (D) natural transformation: \square^p [Eq. (3.5)]

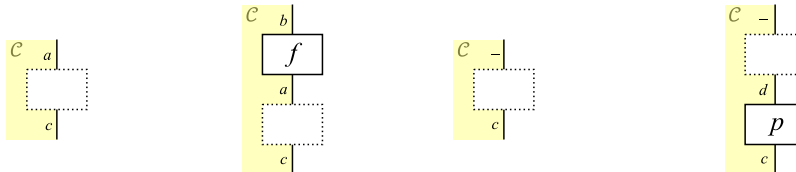

As discussed below, depending on whether the wire “–” is included and whether blocks other than the dotted box are included, it can be classified into $2 \times 2 = 4$ types of diagrams, such as the above four examples (A), (B), (C), and (D).

- Rule 1: A diagram that does not include the wire “–” represents a hom-set (which is an object of **Set**) when it does not include any blocks other than a dotted box, as in Example (A). When it includes such blocks, as in Example (B), it represents a map (which is a morphism of **Set**).
- Rule 2: A diagram that includes the wire “–” represents a set-valued functor when it does not include any blocks other than a dotted box, as in Example (C). When it includes such blocks, as in Example (D), it represents a natural transformation between set-valued functors (more precisely, it also represents a natural transformation when a wire representing a functor is included next to the dotted box)^{‡5}.
- Rule 3: In a diagram representing a map, such as Example (B), when a morphism g (with appropriate domain and codomain) is input into the dotted box, and the morphism represented by the entire diagram is denoted as $s(g)$, the original diagram represents the map $g \mapsto s(g)$. For example, in Example (B), when a morphism $g \in C(c, a)$ is input into the dotted box, the entire diagram represents the morphism $fg \in C(c, b)$, so the diagram of Example (B) represents the map $C(c, a) \ni g \mapsto fg \in C(c, b)$ (i.e., the map $f \circ -$).
- Rule 4: In a diagram such as Example (C) or (D), when the wire “–” is replaced with a block representing a morphism g , and the map represented by the entire diagram is denoted as $s(g)$, the original diagram represents a set-valued functor or natural transformation whose action on morphisms is the map $g \mapsto s(g)$. Note that functors and natural transformations are uniquely determined by their actions on morphisms. For example, in the diagram of Example (C), when the wire “–” is replaced with the block f , it becomes the diagram of Example (B) (i.e., the map $f \circ -$). Therefore, the diagram of Example (C) represents the set-valued functor (i.e., \square^c) whose action on morphisms is $\text{mor } C \ni f \mapsto f \circ - \in \text{mor } \mathbf{Set}$. Also, in the diagram of Example (D), when the wire “–” is replaced with the block f , it becomes the diagram of the right-hand side of Eq. (3.6) (i.e., the map $f \circ - \circ p$). Thus, the diagram of Example (D) represents a natural transformation (i.e., \square^p) whose action on morphisms is $\text{mor } C \ni f \mapsto f \circ - \circ p \in \text{mor } \mathbf{Set}$ ^{‡6}.
- Rule 5: In a diagram that includes the wire “–”, one end of the wire is connected to the dotted box, and the other end is not connected anywhere. For example, in the diagrams of Examples (C) and (D), the lower end of the wire “–” is connected to the dotted box, and the upper end is not connected.

Note that diagrams that include the wire “=” in addition to the wire “–”, as in the right-hand side of Eq. (3.8), can be considered, in which case the same rules as above apply.

Dotted box notation follows the same composition rules as standard string diagrams since it can be regarded as a mere morphism by substituting a morphism into the dotted box (and replacing the wire “–” with an object or morphism if it exists). Intuitively, dotted box notation can be said to be a notation that is obtained by substituting a part of a standard string diagram with a dotted box or the wire “–”. When representing a set-valued functor or natural transformation as a diagram including the wire “–”, we can easily check that it satisfies the conditions as a functor or natural transformation.

^{‡5}The diagram of the identity map $1_a \circ -$, which is obtained by substituting $f = 1_a$ into the diagram of Example (B), cannot be distinguished from the diagram of Example (A). This corresponds to the fact that in **Set**, the identity morphism $1_a \circ - = 1_{C(c,a)}$ can be essentially identified with the object $C(c, a)$. Similarly, the diagram of the identity natural transformation \square^{1_c} , which is obtained by substituting $p = 1_c$ into the diagram of Example (D), cannot be distinguished from the diagram of Example (C). Thus, identity maps and identity natural transformations are exceptionally represented by the same diagrams as the corresponding objects and functors.

^{‡6}As with the action on morphisms, the action on objects can be obtained by replacing the wire “–” with a wire representing an object. For example, when the wire “–” of the diagram of Example (C) is replaced with the wire a , the diagram of Example (A) is obtained. This is consistent with the fact that the action on objects of the functor \square^c is $\text{ob } C \ni a \mapsto C(c, a) \in \text{ob } \mathbf{Set}$. Also, when the wire “–” of the diagram of Example (D) is replaced with the wire a , the map $- \circ p$ is obtained (see Eq. (3.5)). This is consistent with the fact that the action on objects of the natural transformation \square^p is $\text{ob } C \ni a \mapsto - \circ p \in \text{mor } \mathbf{Set}$.

(3) Typical set-valued functors and natural transformations between them

We show some examples of set-valued functors and natural transformations between them.

Example 3.10: For any object $c \in C$ and functor $G: \mathcal{D} \rightarrow C$, we can consider the horizontal composite, $\square^c \bullet G: \mathcal{D} \rightarrow \mathbf{Set}$, of G and $\square^c = C(c, -): C \rightarrow \mathbf{Set}$. We often write $\square^c \bullet G$ as $C(c, G-)$. For clarity, let us explicitly state this functor:

- It maps each object d in \mathcal{D} to the hom-set $C(c, Gd)$.
- It maps each morphism $f: a \rightarrow b$ in \mathcal{D} to the map $Gf \circ -$, which is depicted by

$$(3.11)$$

It would be natural to represent $C(c, G-)$ in the following diagram (see Eq. (3.2)):

$$(3.12)$$

Indeed, replacing the wire “-” of the right-hand side of Eq. (3.12) with the block $f \in \mathcal{D}(a, b)$ yields the right-hand side of Eq. (3.11).

Example 3.13: Similar to Example 3.10, we often write $c^\square \bullet G: \mathcal{D}^{\text{op}} \rightarrow \mathbf{Set}$ (where $G: \mathcal{D}^{\text{op}} \rightarrow C^{\text{op}}$ is the dual of $G: \mathcal{D} \rightarrow C$ as $C(G-, c)$). For each $f \in C^{\text{op}}(a, b)$, the map $Gf \circ -: C^{\text{op}}(c, Ga) \rightarrow C^{\text{op}}(c, Gb)$ is represented by

This map can also be represented as the map $- \circ Gf: C(Ga, c) \rightarrow C(Gb, c)$ with $Gf \in C(Gb, Ga)$. The functor $C(G-, c)$ is depicted by

Example 3.14: For two functors $F: \mathcal{E} \rightarrow C$ and $G: \mathcal{D} \rightarrow C$, let $\langle F, G \rangle$ be the functor from $\mathcal{E}^{\text{op}} \times \mathcal{D}$ to $C^{\text{op}} \times C$ that maps each object $\langle e, d \rangle$ and each morphism $\langle f, g \rangle$ in $\mathcal{E}^{\text{op}} \times \mathcal{D}$ to the object $\langle Fe, Gd \rangle$ and the morphism $\langle Ff, Gg \rangle$ in $C^{\text{op}} \times C$, respectively. Then, we can consider the functor

$$C(F-, G-) := C(-, =) \bullet \langle F, G \rangle : \mathcal{E}^{\text{op}} \times \mathcal{D} \rightarrow \mathbf{Set},$$

which is represented by

$$\begin{array}{c} \text{Set} \\ \mathcal{E}^{\text{op}} \times \mathcal{D} \\ C(F-, G=) \end{array} = \begin{array}{c} C^{\text{op}} \times C \\ \langle F, G \rangle \\ C(-, =) \end{array} = \begin{array}{c} C \quad G \quad \mathcal{D} \quad = \\ \boxed{} \\ F \quad \mathcal{E} \quad - \end{array} \quad (3.15)$$

The action on morphisms of the functor $C(F-, G=)$ is

$$\text{mor}(\mathcal{E}^{\text{op}} \times \mathcal{D}) \ni \langle f, g \rangle \xrightarrow{\langle F, G \rangle} \langle Ff, Gg \rangle \xrightarrow{C(-, =)} Gg \circ - \circ Ff \in \text{mor Set},$$

where the map $Gg \circ - \circ Ff$ is represented by

$$\begin{array}{c} C \quad G \quad \mathcal{D} \quad b' \\ \boxed{Gg} \\ G \quad b \\ \boxed{} \\ F \quad a \\ \boxed{Ff} \\ F \quad \mathcal{E} \quad a' \end{array} = \begin{array}{c} G \quad b' \\ \boxed{g} \\ b \\ \boxed{} \\ F \quad a \\ \boxed{f} \\ F \quad \mathcal{E} \quad a' \end{array}$$

Note that replacing the block f on the right-hand side with the wire “-” and the block g with the wire “=” yields the right-hand side of Eq. (3.15). In particular, we write $C(F-, 1_C=)$ as $C(F-, =)$, and $C(1_C-, G=)$ as $C(-, G=)$.

Example 3.16: Consider a natural transformation from the set-valued functor $C(c, G-)$ to the set-valued functor $C(e, F-)$, where $c \in C$, $e \in \mathcal{E}$, $G: \mathcal{D} \rightarrow C$, and $F: \mathcal{D} \rightarrow \mathcal{E}$. As a slightly complex example, when we arbitrarily choose a morphism $f \in \mathcal{E}(e, Hc)$ and a natural transformation $\alpha: H \bullet G \Rightarrow F$ (where $H: C \rightarrow \mathcal{E}$ is also arbitrary), we consider the map (i.e., a morphism in **Set**) given by

$$\tau_x: C(c, Gx) \ni h \mapsto \alpha_x(H \bullet h)f \in \mathcal{E}(e, Fx)$$

$$\begin{array}{c} \text{diagram} \\ \rightsquigarrow \end{array} \begin{array}{c} \mathcal{E}(e, F-) \quad \mathcal{D} \quad x \\ \text{Set} \quad \boxed{\tau_x} \\ C(c, G-) \quad x \end{array} := \begin{array}{c} \mathcal{E} \\ F \quad x \\ \alpha \\ G \quad c \\ H \quad c \\ C \\ f \\ e \end{array} \quad (3.17)$$

for each $x \in \mathcal{D}$. According to the rule mentioned earlier, the right-hand side of Eq. (3.17) represents a map. Specifically, when we insert a morphism $h \in C(c, Gx)$ into the dotted box, the entire diagram becomes a morphism $\alpha_x(H \bullet h)f \in \mathcal{E}(e, Fx)$, so by Rule 3, it represents the map $C(c, Gx) \ni h \mapsto \alpha_x(H \bullet h)f \in \mathcal{E}(e, Fx)$. It follows that $\tau := \{\tau_x\}_{x \in \mathcal{D}}$ is a natural

transformation from $C(c, G-)$ to $\mathcal{E}(e, F-)$ since we have for each $g \in \mathcal{D}(x, y)$,

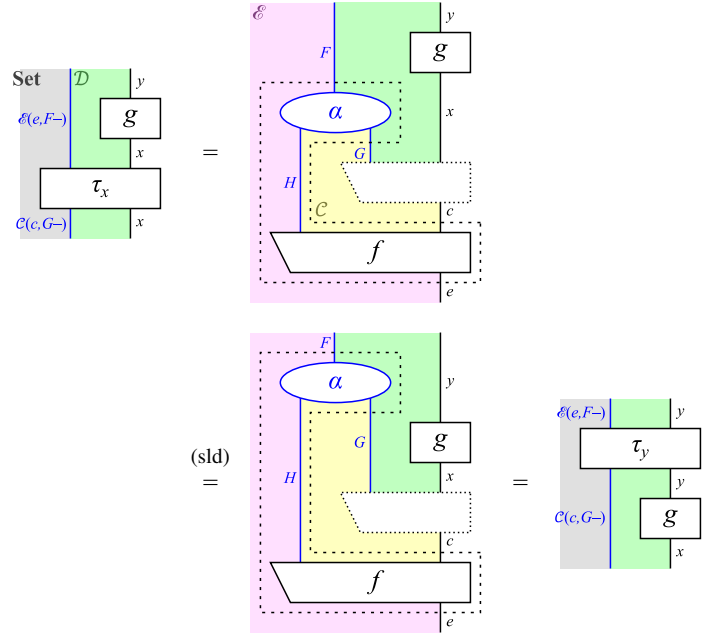

The natural transformation τ can be represented by

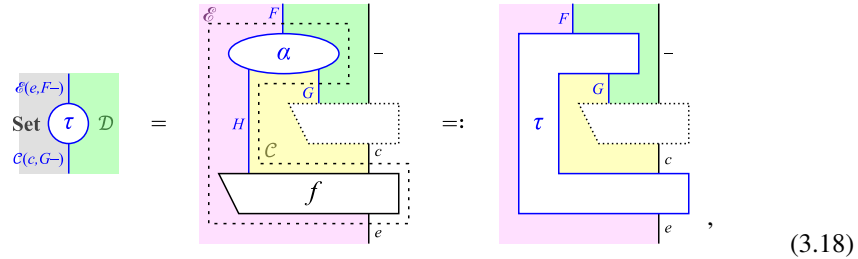

where the area enclosed by the auxiliary line is grouped and represented as a block τ in the shape of “ \square ”. Note that if you replace the wire “ $-$ ” in the central expression of Eq. (3.18) with the wire x , it becomes equal to the right-hand side of Eq. (3.17). Therefore, by Rule 4, it is understood that the central expression of Eq. (3.18) represents a natural transformation, namely τ , whose action on objects is $\text{ob } \mathcal{D} \ni x \mapsto \tau_x \in \text{mor } \mathbf{Set}$ (recall that a natural transformation is uniquely determined by its action on objects). Several natural transformations of this form appear throughout this paper. Note that this diagram can be considered to have the diagram on the right-hand side of Eq. (3.12) embedded in it.

3.1.2 Preliminaries: diagrams for morphisms

In this paper, we identify any element $x \in X$ of any class X with the map $\{*\} \ni * \mapsto x \in X$, where $\{*\}$ is a singleton set. Then, when X is a set, we have $\mathbf{Set}(\{*\}, X) = X$, or equivalently,

$$X = \{\{*\} \ni * \mapsto x \in X\}_{x \in X} \xrightarrow{\text{diagram}} \begin{array}{|c|} \hline \text{Set } X \\ \hline x \\ \hline \end{array} .$$

We represent $\{*\}$ with a gray dotted wire, as shown in this diagram.

It is worth mentioning that the identity morphism 1_x can be expressed as

$$1_x \xrightarrow{\text{diagram}} \begin{array}{c} \mathcal{C} \\ | \\ \bullet \\ | \\ x \end{array} = \begin{array}{c} \square^x \\ | \\ \bullet \\ | \\ x \end{array} \text{ in } \mathbf{Set}, \quad (3.19)$$

where the black circles (dots) represent 1_x . In the right-hand side of this diagram, 1_x is represented as a map (i.e., a morphism in \mathbf{Set}), $\{*\} \ni * \mapsto 1_x \in \square^x(x) = C(x, x)$. Here, as mentioned earlier, we identify 1_x with the map $* \mapsto 1_x$. A good intuitive interpretation of the diagram in Eq. (3.19) might be to think of the right-hand side as “the wire x on the left-hand side, bent at the position of the black circle to change into the wire \square^x ”.

In the following, we explain that for any chosen morphism $a \in C(x, c)$ (with any $x, c \in C$), the following equation holds, and that the equation and diagram correspond.

$$a = \square^x(a) \circ 1_x = a = \square^a_c \circ 1_c$$

$$\xrightarrow{\text{diagram}} \begin{array}{c} \mathcal{C} \\ | \\ \bullet \\ | \\ x \end{array} \begin{array}{c} c \\ | \\ a \\ | \\ x \end{array} = \begin{array}{c} \square^x \\ | \\ \bullet \\ | \\ x \end{array} \begin{array}{c} c \\ | \\ a \\ | \\ x \end{array} = \begin{array}{c} \square^x \\ | \\ \bullet \\ | \\ x \end{array} \begin{array}{c} c \\ | \\ a \\ | \\ x \end{array} = \begin{array}{c} \square^x \\ | \\ \bullet \\ | \\ x \end{array} \begin{array}{c} c \\ | \\ a \\ | \\ x \end{array}, \quad (3.20)$$

where, in this diagram, the morphism a is represented as a round block for visual clarity. (note that there is no semantic difference between a square block and a round block). The left and right black circles represent 1_x and 1_c , respectively. In this section, we will often represent identity morphisms as black circles.

First, we derive the first equality of Eq. (3.20) using the following equation.

$$a = a \circ 1_x = \square^x(a) \circ 1_x \xrightarrow{\text{diagram}} \begin{array}{c} \mathcal{C} \\ | \\ \bullet \\ | \\ x \end{array} \begin{array}{c} c \\ | \\ a \\ | \\ x \end{array} = \begin{array}{c} \mathcal{C} \\ | \\ \bullet \\ | \\ x \end{array} \begin{array}{c} c \\ | \\ a \\ | \\ x \end{array} = \begin{array}{c} \square^x \\ | \\ \bullet \\ | \\ x \end{array} \begin{array}{c} c \\ | \\ a \\ | \\ x \end{array} \quad (3.21)$$

The first equality is obvious since 1_x is an identity morphism. Also, the second equality follows from $\square^x(a) = a \circ -$, which gives $\square^x(a) \circ 1_x = a \circ 1_x = a$. Note that the right-hand side of the diagram in Eq. (3.21), which represents $\square^x(a) \circ 1_x$, may intuitively understand if you think of it as the map (i.e., the morphism in \mathbf{Set})

$$\{*\} \ni * \xrightarrow{* \mapsto 1_x} 1_x \xrightarrow{\square^x(a)} a \in \square^x(c) = C(x, c),$$

which is equal to the map $* \mapsto a$, and is identified with a .

Next, we explain the second equality of Eq. (3.20). The equation $\square^x(a) \circ 1_x = a$ has already been derived. In the third expression in Eq. (3.20), similar to 1_x in Eq. (3.19), a is represented as the map $\{*\} \ni * \mapsto a \in \square^x(c) = C(x, c)$.

Finally, we derive the last equality of Eq. (3.20). From Eq. (3.4), the map \square^a_c is equal to $- \circ a$, we have $\square^a_c \circ 1_c = 1_c \circ a = a$. The right-hand side of the diagram can be considered as representing the map

$$\{*\} \ni * \xrightarrow{* \mapsto 1_c} 1_c \xrightarrow{\square^a_c} a \in \square^x(c) = C(x, c).$$

We give an intuitive interpretation of the diagram in Eq. (3.20). Let us think of the wire \square^c and the wire c (as well as the wire \square^x and the wire x), and the block \square^a and the block a , as being similar things. Then, it can be interpreted that the only main difference among the three diagrams other than the left-hand side is the position of block a . Intuitively, the functor \square^c and the natural transformation \square^a can be considered as different ways of representing the object c and the morphism a in C , respectively. Also, as already mentioned, the first equality can be thought of as “bending the wire x at the position of the black circle to change it into the wire \square^x ”.

We also have for each $c, d \in \mathcal{C}$,

$$\square^c(1_d) = \square^c(-) \circ 1_c \quad \xrightarrow{\text{diagram}} \quad \text{Set} \left| \begin{array}{c} \mathcal{C} \\ \square^c \end{array} \right| d = \text{diagram}, \quad (3.22)$$

where $\square^c(-)$ is the map that maps each $a \in C(c, d)$ to $\square^c(a) = a \circ -$. The functor \square^c maps each identity morphism to the identity morphism in **Set**, so $\square^c(1_d)$ is equal to $1_{C(c,d)}$. Also, from the definition of $\square^c(-)$, the map $\square^c(-) \circ 1_c$ maps each $a \in C(c, d)$ to $\square^c(a) \circ 1_c = a \circ 1_c = a$, so it is equal to $1_{C(c,d)}$. Note that this can be understood by considering Eq. (3.21) with x, c replaced by c, d . Therefore, Eq. (3.22) holds.

Let us consider any set-valued functor $X: \mathcal{C} \rightarrow \mathbf{Set}$ and natural transformation $\tau: \square^c \Rightarrow X$. Each component τ_d of τ is a map from the hom-set $C(c, d)$ to the set Xd and can be represented by

$$\text{Set} \left| \begin{array}{c} \mathcal{C} \\ \tau \\ \square^c \end{array} \right| d = \text{diagram} \quad (3.22) \quad = \text{diagram} \quad (\text{sld}) \quad = \text{diagram} \quad (3.23)$$

τ is represented as

$$\text{Set} \left| \begin{array}{c} \mathcal{C} \\ \tau \\ \square^c \end{array} \right| = \left\{ \text{diagram} \right\}_{d \in \mathcal{C}} = \text{diagram} \quad (3.24)$$

Recalling the rules of dotted box notation, one can see that τ can be represented as this right-hand side.

3.1.3 The Yoneda lemma

(1) Yoneda map

Let us define a map $\alpha_{X,c}$, which is called the **Yoneda map**, as

$$\alpha_{X,c}: \mathbf{Set}^C(\square^c, X) \ni \tau \mapsto \tau_c(1_c) \in Xc \quad \xrightarrow{\text{diagram}} \quad \text{Set} \left| \begin{array}{c} Xc \\ \alpha_{X,c} \\ \mathbf{Set}^C(\square^c, X) \end{array} \right| := \text{diagram}, \quad (3.25)$$

where the dotted circle represents the hom-set $\mathbf{Set}^C(\square^c, X)$. From this definition and Eq. (3.24), we have

$$\text{Set} \left| \begin{array}{c} \mathcal{C} \\ \tau \\ \square^c \end{array} \right| \stackrel{(3.24)}{=} \text{diagram} \xrightarrow{\alpha_{X,c}} \text{diagram} := \text{diagram} \quad (3.26)$$

Both sides of the formula to the right-hand side of ‘the symbol $\xrightarrow{\alpha_{X,c}}$ ’ represent $\alpha_{X,c}(\tau)$. Note that in the dotted box notation of τ (i.e., the right-hand side of the formula to the left-hand side of the symbol $\xrightarrow{\alpha_{X,c}}$ in Eq. (3.26)), replacing the wire ‘-’ with the wire c represents τ_c , and inserting 1_c into the dotted box (which yields the rightmost diagram in Eq. (3.26)) represents $\tau_c(1_c)$, i.e., $\alpha_{X,c}(\tau)$. We also define the map $\beta_{X,c}: Xc \rightarrow \mathbf{Set}^C(\square^c, X)$ as

$$\begin{array}{c} \text{Set} \\ \hline \begin{array}{c} x \\ \hline c \end{array} \\ \hline x \\ \hline \end{array} \xrightarrow{\beta_{X,c}} \begin{array}{c} \square^c \\ \hline \begin{array}{c} x \\ \hline c \end{array} \\ \hline \beta_{X,c}(x) \\ \hline \end{array} := \begin{array}{c} \hline \\ \hline \begin{array}{c} x \\ \hline c \end{array} \\ \hline \end{array}, \quad (3.27)$$

whose mathematical notation is

$$\beta_{X,c}(x) := \{C(c, d) \ni f \mapsto (Xf)(x) \in Xd\}_{d \in C}.$$

For each $x \in Xc$, $\beta_{X,c}(x)$ is a natural transformation from \square^c to X (i.e., an element of $\mathbf{Set}^C(\square^c, X)$) since we have for each $f \in C(a, b)$ ^{‡7},

$$\begin{array}{c} \text{Set} \\ \hline \begin{array}{c} c \\ \hline b \end{array} \\ \hline \begin{array}{c} x \\ \hline a \end{array} \\ \hline \begin{array}{c} f \\ \hline a \end{array} \\ \hline \begin{array}{c} (\beta_{X,c}(x))_a \\ \hline a \end{array} \\ \hline \square^c \\ \hline \end{array} = \begin{array}{c} \hline \\ \hline \begin{array}{c} b \\ \hline a \end{array} \\ \hline \begin{array}{c} f \\ \hline a \end{array} \\ \hline \begin{array}{c} x \\ \hline c \end{array} \\ \hline \end{array} = \begin{array}{c} \hline \\ \hline \begin{array}{c} b \\ \hline a \end{array} \\ \hline \begin{array}{c} f \\ \hline a \end{array} \\ \hline \begin{array}{c} x \\ \hline c \end{array} \\ \hline \end{array} = \begin{array}{c} \hline \\ \hline \begin{array}{c} b \\ \hline a \end{array} \\ \hline \begin{array}{c} (\beta_{X,c}(x))_b \\ \hline b \end{array} \\ \hline \begin{array}{c} f \\ \hline a \end{array} \\ \hline \square^c \\ \hline \end{array}.$$

Comparing Eqs. (3.26) and (3.27), it appears that the maps $\alpha_{X,c}$ and $\beta_{X,c}$ are inverses of each other. In fact, comparing the two blocks τ and $\alpha_{X,c}(\tau)$ in Eq. (3.26), intuitively, the Yoneda map $\alpha_{X,c}$ simply converts the wire \square^c attached to the bottom of τ to the wire c . In contrast, $\beta_{X,c}$ converts the wire c attached to the top of x to the wire \square^c . From another perspective, $\alpha_{X,c}$ removes the dotted box representing $C(c, -)$, and conversely, $\beta_{X,c}$ adds this dotted box. As can be inferred from this, $\beta_{X,c}$ is the inverse map of $\alpha_{X,c}$, which will be proven in Theorem 3.28. With these maps, intuitively, the lower wire \square^c and the upper wire c can be freely exchanged by $\alpha_{X,c}$ and $\beta_{X,c}$. Note that if we regard the wire c and the wire \square^c as the same kind of thing, intuitively, then $\alpha_{X,c}(\tau)$ is something like τ and $\beta_{X,c}(x)$ is something like x .

(2) The Yoneda lemma

Theorem 3.28 (the Yoneda lemma): The following two properties hold:

- (1) For each $X: C \rightarrow \mathbf{Set}$ and $c \in C$, the Yoneda map $\alpha_{X,c}$ is invertible.
- (2) For each $\sigma \in \mathbf{Set}^C(X, Y)$ and $p \in C(c, d)$ (where $X, Y: C \rightarrow \mathbf{Set}$ and $c, d \in C$ are

^{‡7}One can also see that $\beta_{X,c}(x)$ is a special case of the natural transformation τ , represented in Eq. (3.18), specifically when $\mathcal{D} = C$, $\mathcal{E} = \mathbf{Set}$, $F = H = X$, $G = 1_C$, $e = \{*\}$, $\alpha = 1_X$, and $f = x$, and thus is a natural transformation from $C(c, -) = \square^c$ to $\mathbf{Set}(\{*\}, X-) = X$. The reason why $\mathbf{Set}(\{*\}, X-) = X$ holds is that the action on morphisms of the functor $\mathbf{Set}(\{*\}, X-)$ maps each $f \in \text{mor } \mathcal{D}$ to the map $* \mapsto Xf$, and since $* \mapsto Xf$ is identified with Xf , this is equivalent to the action on morphisms of X .

arbitrary),

$$(\sigma \bullet p) \circ \alpha_{X,c} = \alpha_{Y,d} \circ (\sigma \circ - \circ \square^p) \xrightarrow{\text{diagram}} \text{Diagram} = \text{Diagram} \quad (3.29)$$

holds.

The areas enclosed by the left and right auxiliary lines in Eq. (3.29) are $\sigma \bullet p$ and $\sigma \circ - \circ \square^p$, respectively. In this diagram, the Yoneda map is represented as in the right-hand side of Eq. (3.25). Note that the right-hand side of Eq. (3.29) represents $\alpha_{Y,d} \circ (\sigma \circ - \circ \square^p)$ by inserting the diagram representing $\sigma \circ - \circ \square^p$ (i.e., the area enclosed by the auxiliary line) into the dotted circle of the diagram representing $\alpha_{Y,d}$ (i.e., the right-hand side of Eq. (3.25)).

Proof. (1): It is sufficient to show that the map $\beta_{X,c}$ defined in Eq. (3.27) is the inverse of $\alpha_{X,c}$. We have for each $\tau \in \mathbf{Set}^C(\square^c, X)$,

$$\text{Diagram} \xrightarrow{(3.26) \alpha_{X,c}} \text{Diagram} \xrightarrow{(3.27) \beta_{X,c}} \text{Diagram} \stackrel{(3.24)}{=} \text{Diagram}$$

and for each $x \in Xc$,

$$\text{Diagram} \xrightarrow{(3.27) \beta_{X,c}} \text{Diagram} \xrightarrow{(3.26) \alpha_{X,c}} \text{Diagram}, \quad (3.30)$$

where we use the fact that the map “ $\xrightarrow{\alpha_{X,c}}$ ” in Eq. (3.30) is equivalent to the operation of replacing the wire “-” with the wire c and substituting 1_c into the dotted box. Therefore, $\beta_{X,c}$ is the inverse of $\alpha_{X,c}$.

(2): We have

$$\text{Diagram} \stackrel{(\text{sld})}{=} \text{Diagram} \stackrel{(3.20)}{=} \text{Diagram}$$

□

In what follows, we denote $\beta_{X,c}$ as $\alpha_{X,c}^{-1}$. For any $x \in Xc$ (where c is also arbitrary),

$$x = \alpha_{X,c}(\alpha_{X,c}^{-1}(x)) \quad \xrightarrow{\text{diagram}} \quad \begin{array}{c} X|c \\ \text{---} \\ \text{Set} \end{array} \quad = \quad \begin{array}{c} X| \\ \text{---} \\ \text{Set} \end{array} \quad (3.31)$$

obviously holds. Note that $a = \alpha_{\square^c,c}(\square^a)$ holds from the last equality in Eq. (3.20), which yields

$$\square^a = \alpha_{\square^c,c}^{-1}(a). \quad (3.32)$$

Equation (3.31) can be seen as a generalization of the last equality in Eq. (3.20). The Yoneda map $\alpha_{X,c}$ and its inverse $\alpha_{X,c}^{-1}$ can be expressed as

$$\begin{array}{c} X| \\ \text{---} \\ \text{Set} \end{array} \quad \xrightarrow{\alpha_{X,c}} \quad \begin{array}{c} X| \\ \text{---} \\ \text{Set} \end{array} \quad , \quad \begin{array}{c} X|c \\ \text{---} \\ \text{Set} \end{array} \quad \xrightarrow{\alpha_{X,c}^{-1}} \quad \begin{array}{c} X| \\ \text{---} \\ \text{Set} \end{array} \quad , \quad (3.33)$$

where the blue block in the shape of “J” represents $\{\alpha_{X,c}^{-1}\}_{X \in \text{Set}^c}$ ^{‡8}. The diagram to the right-hand side of the symbol “ $\xrightarrow{\alpha_{X,c}^{-1}}$ ” represents the natural transformation $\alpha_{X,c}^{-1}(x): \square^c \Rightarrow X$. Intuitively, the Yoneda map $\alpha_{X,c}$ simply converts the wire \square^c into the wire c , and $\alpha_{X,c}^{-1}$ converts the wire c into the wire \square^c .

(3) Naturality of the Yoneda lemma

If we can express Eq. (3.29) as

$$G(\sigma, p) \circ \alpha_{X,c} = \alpha_{Y,d} \circ F(\sigma, p) \quad (3.34)$$

using two appropriate bifunctors $F, G: \mathbf{Set}^C \times C \rightarrow \mathbf{Set}$, then this equation can be considered to represent naturality of $\alpha := \{\alpha_{X,c}\}_{X \in \text{Set}^c, c \in C}$, and thus α is a natural transformation from F to G . In order to express it in such a way, it is sufficient to satisfy

$$G(\sigma, p) = \sigma \bullet p, \quad F(\sigma, p) = \sigma \circ - \circ \square^p \quad (\forall \langle \sigma, p \rangle \in \text{mor}(\mathbf{Set}^C \times C)) \quad (3.35)$$

and this condition determines the action on morphisms of G and F . Since the action on morphisms of G is $\langle \sigma, p \rangle \mapsto \sigma \bullet p$, G is the evaluation functor $\text{ev}: \mathbf{Set}^C \times C \rightarrow \mathbf{Set}$. From Example 2.34, we have

$$\text{ev}(\sigma, p) = \sigma \bullet p \quad \xrightarrow{\text{diagram}} \quad \begin{array}{c} \text{Set} \\ \uparrow \text{ev} \end{array} \quad \begin{array}{c} Y| \\ \text{---} \\ \text{Set}^C \end{array} \quad \begin{array}{c} C \\ \uparrow \text{ev} \end{array} \quad \begin{array}{c} d \\ \text{---} \\ \text{Set} \end{array} \quad = \quad \begin{array}{c} Y|d \\ \text{---} \\ \text{Set} \end{array} \quad . \quad (3.36)$$

For F , let us consider the following bifunctor:

$$\mathbf{Set}^C(\square^-, -) := \mathbf{Set}^C(=, -) \bullet \langle 1_{\text{Set}^c}, \square^- \rangle$$

$$\xrightarrow{\text{diagram}} \quad \begin{array}{c} \text{Set} \\ \text{---} \\ \text{Set}^C(\square^-, -) \end{array} \quad \text{Set}^C \times C \quad := \quad \begin{array}{c} \text{Set}^C \times (\text{Set}^C)^{\text{op}} \\ \text{---} \\ \text{Set}^C(=, -) \end{array} \quad \langle 1_{\text{Set}^c}, \square^- \rangle \quad ,$$

where $\mathbf{Set}^C(=, -)$ represents the hom-functor $(\mathbf{Set}^C)^{\text{op}}(-, =)$. Also, $\langle 1_{\text{Set}^c}, \square^- \rangle$ is a pair of the identity functor 1_{Set^c} and the functor $\square^-: C \rightarrow (\mathbf{Set}^C)^{\text{op}}$ (refer to the beginning of Example 3.14), and

^{‡8}This blue block is the natural transformation obtained by substituting $c = \{*\}$, $G = \text{ev}_c$, $e = \square^c$, and $F = 1_{\text{Set}^c}$ into the right-hand side of Eq. (3.18). As can be seen from Corollary 3.38, this is a natural isomorphism from the functor $\mathbf{Set}(\{*\}, -c) = \text{ev}_c$ to the functor $\mathbf{Set}^C(\square^c, -)$.

the functor \square^- maps each object c and each morphism p in C to \square^c and \square^p , respectively. Since the action on morphisms of $\mathbf{Set}^C(\square^-, -)$ is

$$\text{mor}(\mathbf{Set}^C \times C) \ni \langle \sigma, p \rangle \xrightarrow{\langle 1_{\mathbf{Set}^C}, \square^- \rangle} \langle \sigma, \square^p \rangle \xrightarrow{\mathbf{Set}^C(\square^-, -)} \sigma \circ - \circ \square^p \in \text{mor } \mathbf{Set},$$

$F = \mathbf{Set}^C(\square^-, -)$ holds from Eq. (3.35). We have

$$(\mathbf{Set}^C(\square^-, -))(\sigma, p) = \sigma \circ - \circ \square^p$$

$$\text{diagram} \rightsquigarrow \begin{array}{c} \text{Set} \\ \uparrow \\ \text{Set}^c(\square^-, -) \end{array} \begin{array}{c} \uparrow \text{Set}^c C \\ \sigma \\ \uparrow X \\ \square^c \end{array} \begin{array}{c} \uparrow \text{Set}^c C \\ p \\ \uparrow c \\ \square^c \end{array} \begin{array}{c} \text{Set} \\ \uparrow \\ \text{Set}^c(\square^-, -) \end{array} = \begin{array}{c} Y \\ \uparrow \\ \sigma \\ \uparrow X \\ \square^c \\ \uparrow \\ \square^c \\ \uparrow \\ p \\ \uparrow c \\ \square^c \\ \uparrow \\ \text{Set} \end{array} \quad (3.37)$$

From the above discussion, we obtain the following corollary:

Corollary 3.38: Property (2) of Theorem 3.28 is equivalent to $\alpha := \{\alpha_{X,c}\}_{X \in \mathbf{Set}^C, c \in C}$ being a natural transformation from the bifunctor $\mathbf{Set}^C(\square^-, -): \mathbf{Set}^C \times C \rightarrow \mathbf{Set}$ to the evaluation functor $\text{ev}: \mathbf{Set}^C \times C \rightarrow \mathbf{Set}$. Or equivalently, for each $\sigma \in \mathbf{Set}^C(X, Y)$ and $p \in C(c, d)$ (where $X, Y \in \mathbf{Set}^C$ and $c, d \in C$ are arbitrary),

$$\text{ev}(\sigma, p) \circ \alpha_{X,c} = \alpha_{Y,d} \circ (\mathbf{Set}^C(\square^-, -))(\sigma, p)$$

$$\text{diagram} \rightsquigarrow \begin{array}{c} \text{Set} \\ \uparrow \\ \text{ev} \end{array} \begin{array}{c} \uparrow \text{Set}^c C \\ \sigma \\ \uparrow X \\ \square^c \end{array} \begin{array}{c} \uparrow \text{Set}^c C \\ p \\ \uparrow c \\ \square^c \end{array} \begin{array}{c} \text{Set} \\ \uparrow \\ \text{ev} \end{array} \begin{array}{c} \alpha_{X,c} \\ \uparrow \\ \text{Set}^c(\square^-, -) \end{array} \begin{array}{c} \uparrow \text{Set}^c C \\ \sigma \\ \uparrow X \\ \square^c \end{array} \begin{array}{c} \uparrow \text{Set}^c C \\ p \\ \uparrow c \\ \square^c \end{array} \begin{array}{c} \text{Set} \\ \uparrow \\ \text{Set}^c(\square^-, -) \end{array} = \begin{array}{c} \text{ev} \\ \uparrow \\ \alpha_{Y,d} \\ \uparrow \\ \text{Set}^c(\square^-, -) \end{array} \begin{array}{c} \uparrow \text{Set}^c C \\ \sigma \\ \uparrow X \\ \square^c \end{array} \begin{array}{c} \uparrow \text{Set}^c C \\ p \\ \uparrow c \\ \square^c \end{array} \begin{array}{c} \text{Set} \\ \uparrow \\ \text{Set}^c(\square^-, -) \end{array} \quad (3.39)$$

holds.

Proof. The left- and right-hand side of Eq. (3.39) can be expressed as

$$\begin{array}{c} \text{Set} \\ \uparrow \\ \text{ev} \end{array} \begin{array}{c} \uparrow \text{Set}^c C \\ \sigma \\ \uparrow X \\ \square^c \end{array} \begin{array}{c} \uparrow \text{Set}^c C \\ p \\ \uparrow c \\ \square^c \end{array} \begin{array}{c} \text{Set} \\ \uparrow \\ \text{ev} \end{array} \begin{array}{c} \alpha_{X,c} \\ \uparrow \\ \text{Set}^c(\square^-, -) \end{array} \begin{array}{c} \uparrow \text{Set}^c C \\ \sigma \\ \uparrow X \\ \square^c \end{array} \begin{array}{c} \uparrow \text{Set}^c C \\ p \\ \uparrow c \\ \square^c \end{array} \begin{array}{c} \text{Set} \\ \uparrow \\ \text{Set}^c(\square^-, -) \end{array} \quad (3.36) \\ = \begin{array}{c} Y \\ \uparrow \\ \sigma \\ \uparrow X \\ \square^c \\ \uparrow \\ \square^c \\ \uparrow \\ p \\ \uparrow c \\ \square^c \\ \uparrow \\ \text{Set} \end{array} \quad (3.25)$$

and

$$\begin{array}{c} \text{Set} \\ \uparrow \\ \text{ev} \end{array} \begin{array}{c} \uparrow \text{Set}^c C \\ \sigma \\ \uparrow X \\ \square^c \end{array} \begin{array}{c} \uparrow \text{Set}^c C \\ p \\ \uparrow c \\ \square^c \end{array} \begin{array}{c} \text{Set} \\ \uparrow \\ \text{ev} \end{array} \begin{array}{c} \alpha_{Y,d} \\ \uparrow \\ \text{Set}^c(\square^-, -) \end{array} \begin{array}{c} \uparrow \text{Set}^c C \\ \sigma \\ \uparrow X \\ \square^c \end{array} \begin{array}{c} \uparrow \text{Set}^c C \\ p \\ \uparrow c \\ \square^c \end{array} \begin{array}{c} \text{Set} \\ \uparrow \\ \text{Set}^c(\square^-, -) \end{array} \quad (3.25) \\ = \begin{array}{c} Y \\ \uparrow \\ \sigma \\ \uparrow X \\ \square^c \\ \uparrow \\ \square^c \\ \uparrow \\ p \\ \uparrow c \\ \square^c \\ \uparrow \\ \text{Set} \end{array} \quad (3.37)$$

respectively. Therefore, Eq. (3.39) and Eq. (3.29) are equivalent. \square

Recall that the Yoneda map $\alpha_{X,c}$ can be interpreted as a “transformation from the wire \square^c to the wire c ”. Therefore, Eq. (3.29) can be interpreted as “applying σ and p after transforming the wire \square^c to the wire c ” and “transforming the wire \square^c to the wire c after applying σ and \square^p ” are equivalent. In Eq. (3.34), the map that applies σ and p can be considered to be represented by $G(\sigma, p)$, and the map that applies σ and \square^p can be considered to be represented by $F(\sigma, p)$.

Each component $\alpha_{X,c}$ of the natural transformation α is a morphism from $\mathbf{Set}^C(\square^c, X)$ to Xc , which follows from $(\mathbf{Set}^C(\square^c, -))(X, c) = \mathbf{Set}^C(\square^c, X)$ and $\text{ev}(X, c) = Xc$. Also, we can see that Theorem 3.28 is equivalent to α being a natural isomorphism from $\mathbf{Set}^C(\square^c, -)$ to ev , or equivalently, the isomorphism $\alpha_{X,c}: \mathbf{Set}^C(\square^c, X) \cong Xc$ being natural in X and c . This natural isomorphism can be depicted by

$$\mathbf{Set}^C(\square^c, -) \cong \text{ev} \quad \xrightarrow{\text{diagram}} \quad \text{Set} \begin{array}{c} | \\ \square^c \\ | \\ c \end{array} \cong \text{Set} \begin{array}{c} | \\ \square^c \\ | \\ c \end{array} \quad . \quad (3.40)$$

Also, from Eq. (3.25), one can depict α by^{‡9}

$$\alpha \quad \xrightarrow{\text{diagram}} \quad \text{Set} \begin{array}{c} | \\ \text{Set}^c \times C \\ | \\ \text{ev} \\ | \\ \text{Set}^c(\square^c, -) \end{array} \alpha = \text{Set} \begin{array}{c} | \\ c \\ | \\ \square^c \\ | \\ c \end{array} \quad .$$

(4) Dual to the Yoneda lemma

We briefly state the diagram of x^\square . Considering the “upside-down” version of Eq. (3.20), we can see that an element a of $x^\square(c) = C^{\text{op}}(x, c) = C(c, x)$ is represented by

$$a = x^\square(a) \circ 1_x = a = a^\square_c \circ 1_c \quad \xrightarrow{\text{diagram}} \quad \begin{array}{c} C^{\text{op}} \\ | \\ c \\ | \\ a \\ | \\ x \end{array} = \text{Set} \begin{array}{c} | \\ x^\square \\ | \\ c \\ | \\ x \end{array} = \text{Set} \begin{array}{c} | \\ x^\square \\ | \\ c \end{array} = \text{Set} \begin{array}{c} | \\ x^\square \\ | \\ c^\square \\ | \\ c \end{array} \quad , \quad (3.41)$$

where the left and right black circles in the diagram represent 1_x and 1_c , respectively. Recall that we represent the objects and morphisms in C^{op} as the “upside-down” of the objects and morphisms in C (see Eq. (2.2)). For the natural transformation $a^\square: c^\square \Rightarrow x^\square$, the reader refers to Eq. (3.7). A natural transformation from c^\square to a presheaf $X': C^{\text{op}} \rightarrow \mathbf{Set}$ can also be represented in the same way as Eq. (3.24).

For any category C , denote the functor category $\mathbf{Set}^{C^{\text{op}}}$ as the **category of presheaves** and write it as \hat{C} . Considering the duals of Theorem 3.28 and Corollary 3.38 yields the following corollary.

Corollary 3.42 (the Yoneda lemma): For any object $c \in C^{\text{op}}$ and presheaf $X \in \hat{C}$, define a map $\alpha_{X,c}: \hat{C}(c^\square, X) \rightarrow Xc$, which is also called the **Yoneda map**, as

$$\alpha_{X,c}(\tau) := \tau_c(1_c) \quad \xrightarrow{\text{diagram}} \quad \text{Set} \begin{array}{c} | \\ X \\ | \\ C^{\text{op}} \\ | \\ c \end{array} \alpha_{X,c}(\tau) := \text{Set} \begin{array}{c} | \\ X \\ | \\ c^\square \\ | \\ c \end{array} \quad . \quad (3.43)$$

Then, the following two properties hold:

^{‡9}One might feel that this right-hand side appears to violate Rule 5 of the dotted box notation. If this is a concern, then a slight modification to this rule could be considered.

- (1) For each $X \in \hat{C}$ and $c \in C^{\text{op}}$, $\alpha_{X,c}$ is invertible.
- (2) For each $\sigma \in \hat{C}(X, Y)$ and $p \in C^{\text{op}}(c, d)$ (where $X, Y \in \hat{C}$ and $c, d \in C^{\text{op}}$ are arbitrary),

$$(\sigma \bullet p) \circ \alpha_{X,c} = \alpha_{Y,d} \circ (\sigma \circ - \circ p^{\square})$$

holds. In other words, $\{\alpha_{X,c}\}_{X \in \hat{C}, c \in C^{\text{op}}}$ is a natural transformation from the bifunctor $\hat{C}(=^{\square}, -): \hat{C} \times C^{\text{op}} \rightarrow \mathbf{Set}$ to the evaluation functor $\text{ev}: \hat{C} \times C^{\text{op}} \rightarrow \mathbf{Set}$.

Similar to Eq. (3.40), this natural isomorphism can be depicted by

$$\hat{C}(=^{\square}, -) \cong \text{ev} \quad \xrightarrow{\text{diagram}} \quad \mathbf{Set} \begin{array}{|c} \hline - \\ \hline \bullet \\ \hline =^{\square} \\ \hline \end{array} C^{\text{op}} \cong \mathbf{Set} \begin{array}{|c} \hline - \\ \hline \bullet \\ \hline = \\ \hline \end{array} .$$

3.1.4 Yoneda embeddings

Let us define a functor C^{\square} from a category C to the category of presheaves \hat{C} as follows:

- It maps each object c in C to the functor $c^{\square} = C(-, c)$.
- It maps each morphism $f: c \rightarrow d$ in C to the natural transformation $f^{\square}: c^{\square} \Rightarrow d^{\square}$.

This functor is called the **Yoneda embedding**. We have for each morphism $f \in C(c, d)$,

$$\begin{array}{|c} \hline \hat{C} \\ \hline \begin{array}{|c} \hline C \\ \hline \end{array} \begin{array}{|c} \hline d \\ \hline \end{array} \\ \hline \end{array} \begin{array}{|c} \hline e^{\square} \\ \hline \end{array} \begin{array}{|c} \hline f \\ \hline \end{array} \begin{array}{|c} \hline c \\ \hline \end{array} = \mathbf{Set} \begin{array}{|c} \hline d^{\square} \\ \hline \end{array} C^{\text{op}} \begin{array}{|c} \hline f^{\square} \\ \hline \end{array} \begin{array}{|c} \hline c^{\square} \\ \hline \end{array} \stackrel{(3.32)}{=} \mathbf{Set} \begin{array}{|c} \hline d^{\square} \\ \hline \end{array} \begin{array}{|c} \hline \alpha_{f,c}^{-1}(f) \\ \hline \end{array} \begin{array}{|c} \hline c^{\square} \\ \hline \end{array} .$$

Corollary 3.44: For any category C , the Yoneda embedding C^{\square} is fully faithful.

Proof. For each $c, d \in C$, the Yoneda embedding provides the map

$$C^{\square}: C(c, d) \ni f \mapsto f^{\square} = \alpha_{d^{\square}, c}^{-1}(f) \in \hat{C}(c^{\square}, d^{\square}).$$

This map is invertible and its inverse is $\alpha_{d^{\square}, c}$. Therefore, the Yoneda embedding is fully faithful. \square

From Corollary 3.44, we can derive the following lemma.

Lemma 3.45: For two functors $F, G: C \rightarrow \mathcal{D}$, we have

$$\begin{aligned} F \cong G &\Leftrightarrow \text{there exists an isomorphism } \mathcal{D}(d, Fc) \cong \mathcal{D}(d, Gc) \text{ that is natural in } c \text{ and } d \\ &\Leftrightarrow \text{there exists an isomorphism } \mathcal{D}(Fc, d) \cong \mathcal{D}(Gc, d) \text{ that is natural in } c \text{ and } d. \end{aligned} \tag{3.46}$$

Proof. It is sufficient to show the first “ \Leftrightarrow ” in Eq. (3.46) since its dual proves the second “ \Leftrightarrow ”. Let R denote the standard functor from $\hat{\mathcal{D}}^C = (\mathbf{Set}^{\mathcal{D}^{\text{op}}})^C$ to $\mathbf{Set}^{\mathcal{D}^{\text{op}} \times C}$. From Corollary 3.44, the Yoneda embedding \mathcal{D}^{\square} is fully faithful, and thus, from Lemma 2.23, $\mathcal{D}^{\square} \bullet -: \mathcal{D}^C \rightarrow \hat{\mathcal{D}}^C$ is also fully faithful. For two functors $F, G: C \rightarrow \mathcal{D}$, we have

$$\begin{aligned} F \cong G &\Leftrightarrow \mathcal{D}^{\square} \bullet F \cong \mathcal{D}^{\square} \bullet G \Leftrightarrow R(\mathcal{D}^{\square} \bullet F) \cong R(\mathcal{D}^{\square} \bullet G) \\ &\Leftrightarrow \mathcal{D}(-, F=) \cong \mathcal{D}(-, G=). \end{aligned}$$

The first and second “ \Leftrightarrow ” follow from the fact that $\mathcal{D}^\square \bullet -$ and R are fully faithful and the fact that for any functor $H: \mathcal{E} \rightarrow \mathcal{F}$ and $e, e' \in \mathcal{E}$ (where \mathcal{E} and \mathcal{F} are arbitrary), $e \cong e'$ is equivalent to $He \cong He'$. The last “ \Leftrightarrow ” follows from $R(\mathcal{D}^\square \bullet F) = \mathcal{D}(-, F=)$ and $R(\mathcal{D}^\square \bullet G) = \mathcal{D}(-, G=)$ ^{‡10}. Therefore, the first “ \Leftrightarrow ” in Eq. (3.46) holds. \square

Since the Yoneda embedding $\mathcal{D}^\square \bullet -: \mathcal{D}^C \rightarrow \hat{\mathcal{D}}^C$ is fully faithful, for any natural transformation $\theta: \mathcal{D}(-, F=) \Rightarrow \mathcal{D}(-, G=)$, we can find a unique $\sigma: F \Rightarrow G$ satisfying

$$\begin{array}{c} \mathcal{D}^\square \bullet \mathcal{D} \bullet G \\ \mathcal{D}^\square \bullet F \\ \hat{\mathcal{D}} \bullet R^{-1} \theta \bullet \mathcal{C} \end{array} \stackrel{(2.4)}{=} \begin{array}{c} \mathcal{D}^\square \bullet G \\ \mathcal{D}^\square \bullet F \\ \exists! \bullet \sigma \end{array} .$$

This may be easier to understand if expressed as

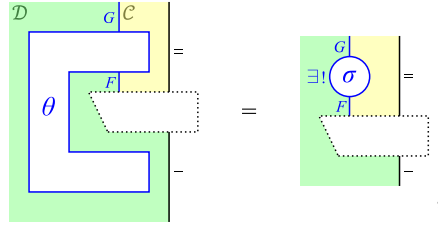

where we represent θ as the block in the shape of “ \sqsubset ”. The left-hand side can be interpreted as the map that sends a morphism $g \in \mathcal{D}(d, Fc)$ (where $d \in \mathcal{D}$ and $c \in \mathcal{C}$ are arbitrary) to the morphism $\theta_{d,c}(g) \in \mathcal{D}(d, Gc)$ (by substituting d and c for $-$ and $=$ respectively). The right-hand side can be interpreted as the map that sends a morphism g to $\sigma_c g \in \mathcal{D}(d, Gc)$.

3.2 Universal properties

3.2.1 Comma category $c \downarrow G$

Let us arbitrarily choose an object $c \in \mathcal{C}$ and a functor $G: \mathcal{D} \rightarrow \mathcal{C}$. The category defined as follows is called a **comma category** and is denoted by $c \downarrow G$:

- Its each object is a pair, $\langle x, a \rangle$, of an object $x \in \mathcal{D}$ and a morphism $a \in \mathcal{C}(c, Gx)$.
- Its each morphism from an object $\langle x, a \rangle$ to an object $\langle y, a' \rangle$ is a morphism $f \in \mathcal{D}(x, y)$ in \mathcal{D} satisfying^{‡11}

$$a' = Gf \circ a \quad \xrightarrow{\text{diagram}} \quad \begin{array}{c} G \bullet \mathcal{D} \bullet y \\ a' \\ c \end{array} = \begin{array}{c} y \\ G \bullet f \\ x \\ a \\ c \end{array} . \quad (3.47)$$

- The composite of its morphisms is the composite of morphisms in \mathcal{D} , and its identity morphism is the identity morphism in \mathcal{D} .

As mentioned earlier, we identify elements x of a set X with maps $\{*\} \ni * \mapsto x \in X$. This identification leads to the following lemma.

^{‡10}Proof: The functor $R(\mathcal{D}^\square \bullet F) \in \mathbf{Set}^{\mathcal{D}^{\text{op}} \times \mathcal{C}}$ maps each morphism $\langle f, g \rangle \in \text{mor}(\mathcal{D}^{\text{op}} \times \mathcal{C})$ to $((\mathcal{D}^\square \bullet F)g) \bullet f \in \text{mor} \mathbf{Set}$. Also, $((\mathcal{D}^\square \bullet F)g) \bullet f = (Fg)^\square \bullet f = Fg \circ - \circ f$ holds. Therefore, the action on morphisms of $R(\mathcal{D}^\square \bullet F)$ is $\text{mor}(\mathcal{D}^{\text{op}} \times \mathcal{C}) \ni \langle f, g \rangle \mapsto Fg \circ - \circ f \in \text{mor} \mathbf{Set}$, which is equal to the action on morphisms of the functor $\mathcal{D}(-, F=)$. Thus, we have $R(\mathcal{D}^\square \bullet F) = \mathcal{D}(-, F=)$. Similarly, we have $R(\mathcal{D}^\square \bullet G) = \mathcal{D}(-, G=)$.

^{‡11}Since the domain and the codomain of each morphism in $c \downarrow G$ must be objects in $c \downarrow G$, strictly speaking morphisms in $c \downarrow G$ should be distinguished from morphisms in \mathcal{D} . However, since it will always be clear from context which meaning is intended, we often represent morphisms in $c \downarrow G$ as morphisms in \mathcal{D} . The same applies to comma categories $G \downarrow c$ and categories of elements mentioned later.

Lemma 3.48: For any categories C and \mathcal{D} , object $c \in C$, and functor $G: \mathcal{D} \rightarrow C$, the comma category $c \downarrow G$ is equal to the comma category $\{*\} \downarrow C(c, G-)$.

Proof. An object in $\{*\} \downarrow C(c, G-)$ is a pair, $\langle x, * \mapsto a \rangle$, of an object $x \in \mathcal{D}$ and a map $\{*\} \ni * \mapsto a \in C(c, Gx)$. Since we identify $* \mapsto a$ with a , this is equal to the object $\langle x, a \rangle$ in $c \downarrow G$. This can also be seen from the following equation (note that $C(c, G-) = \square^c \bullet G$):

$$(* \mapsto a) = a \quad \xrightarrow{\text{diagram}} \quad \begin{array}{c} \square^c \quad C \quad G \quad \mathcal{D} \quad x \\ \diagdown \quad \diagup \\ a \\ \text{Set} \end{array} \quad (3.20) \quad = \quad \begin{array}{c} G \quad x \\ \diagdown \quad \diagup \\ a \\ c \end{array} .$$

Also, a morphism $f: \langle x, a \rangle \rightarrow \langle y, a' \rangle$ in $\{*\} \downarrow C(c, G-)$ is a morphism $f \in \mathcal{D}(x, y)$ satisfying $a' = Gf \circ a$, and thus is a morphism in $c \downarrow G$. Conversely, objects and morphisms in $c \downarrow G$ are contained in $\{*\} \downarrow C(c, G-)$. Composites of morphisms and identity morphisms are also the same. Therefore, $c \downarrow G = \{*\} \downarrow C(c, G-)$ holds. \square

3.2.2 Universal morphisms

Definition 3.49 (universal morphisms): An initial object ${}^*a \langle u, \eta \rangle$ in a comma category $c \downarrow G$ is called a **universal morphism** from c to G . In other words, $\langle u, \eta \rangle$ with $u \in \mathcal{D}$ and $\eta \in C(c, Gu)$ is called a universal morphism from c to G if, for any morphism $a \in C(c, Gx)$ with any $x \in \mathcal{D}$, there exists a unique morphism $\bar{a} \in \mathcal{D}(u, x)$ satisfying

$$a = G\bar{a} \circ \eta \quad \xrightarrow{\text{diagram}} \quad \begin{array}{c} G \quad \mathcal{D} \quad x \\ \diagdown \quad \diagup \\ a \\ c \end{array} \quad = \quad \begin{array}{c} x \\ \square^c \quad \exists! \\ \bar{a} \\ u \\ \bullet \\ c \end{array} , \quad (\text{univ})$$

where the black circle represents η .

^{*a}An **initial object** in C is an object a in C such that for any $x \in C$, there exists a unique morphism with domain a and codomain x .

Sometimes η is simply called a universal morphism. In this paper, when we mention the universal property of $\langle u, \eta \rangle$, we are often referring to Eq. (univ). It follows from Eq. (univ) that a and \bar{a} correspond one-to-one. In particular, a is η if and only if the corresponding morphism \bar{a} is 1_u .

Example 3.50: Let us restate the second equality of Eq. (3.20):

$$\begin{array}{c} \square^c \quad C \quad x \\ \diagdown \quad \diagup \\ a \\ \text{Set} \end{array} \quad = \quad \begin{array}{c} x \\ \square^c \\ a \\ \bullet \\ c \end{array} .$$

Comparing it with Eq. (univ), it can be seen that $\langle x, a \rangle$ is an object in the comma category $\{*\} \downarrow \square^c$. In this example, \bar{a} in Eq. (univ) is a itself. The black circle represents the object $\langle c, 1_c \rangle$ in $\{*\} \downarrow \square^c$, which can be understood as an initial object, i.e., a universal morphism from $\{*\}$ to \square^c .

Example 3.51 (the Yoneda lemma): For any object $c \in C$ and set-valued functor $X: C \rightarrow \mathbf{Set}$, there is a one-to-one correspondence between $x \in Xc$ and $\bar{x} := \alpha_{X,c}^{-1}(x) \in \mathbf{Set}^C(\square^c, X)$

(recall Eq. (3.40) or Eq. (3.33)). This correspondence is expressed by

$$\begin{array}{c} \text{Set} \\ \text{ev}_c \\ \text{Set}^c \\ X \\ x \end{array} = \begin{array}{c} X \\ \text{ev}_c \\ \bar{x} \\ \square^c \end{array} \quad \text{equivalent} \quad \begin{array}{c} X \\ \text{Set} \\ X \\ C \\ c \\ x \end{array} = \begin{array}{c} X \\ \bar{x} \\ \square^c \\ c \end{array}, \quad (3.52)$$

where the black circle represents the identity morphism 1_c . Equation (3.52) expresses the same equation in two ways using $\text{ev}_c = - \bullet c$ (recall Example 2.19). The right-hand side of the symbol “ \Leftrightarrow ” corresponds to Eq. (3.26). It follows from Eq. (3.52) that the black circle represents the object $\langle \square^c, 1_c \rangle$ in the comma category $\{*\} \downarrow \text{ev}_c$, which is an initial object, i.e., a universal morphism from $\{*\}$ to ev_c .

Example 3.53: Equation (2.4) means that for each $a \in C$, $\langle a, 1_{Fa} \rangle$ is a universal morphism from Fa to F (please substitute $\langle u, \eta \rangle$ in Eq. (univ) with $\langle a, 1_{Fa} \rangle$). Thus, it follows that a functor $F: C \rightarrow \mathcal{D}$ is fully faithful if and only if $\langle a, 1_{Fa} \rangle$ is a universal morphism from Fa to F for each $a \in C$.

A universal morphism from c to G is an initial object in a comma category $c \downarrow G$, and thus is essentially unique if it exists^{‡12}. More specifically, when $\langle u, \eta \rangle$ is a universal morphism from c to G , for any universal morphism $\langle u', \eta' \rangle$ from c to G , there exists a unique isomorphism $\psi \in \mathcal{D}(u, u')$ such that

$$\eta' = G\psi \circ \eta \quad \xrightarrow{\text{diagram}} \quad \begin{array}{c} G \\ \mathcal{D} \\ u' \\ \eta' \\ c \end{array} = \begin{array}{c} u' \\ \psi \\ u \\ \eta \\ c \end{array}, \quad (3.54)$$

where the black circle represents η , and the diamond block represents ψ (note that in this paper, an isomorphism is often represented by a diamond block). Therefore, objects u and u' in \mathcal{D} are isomorphic. In particular, if η is an isomorphism, then so is η' . Conversely, for a universal morphism $\langle u, \eta \rangle$, $\langle u', \eta' \rangle$ represented in the form of Eq. (3.54) is also a universal morphism from c to G .

For a set-valued functor $X: C \rightarrow \mathbf{Set}$, the **category of elements** $\text{el}(X)$ can be defined as the comma category $\{*\} \downarrow X$. From Lemma 3.48, we have $\text{el}(C(c, G-)) = c \downarrow G$.

3.2.3 Representable functors

For a set-valued functor $X: C \rightarrow \mathbf{Set}$, if there exists an object $u \in C$ and a natural isomorphism $\sigma: \square^u \cong X$, then we call X **representable** and the pair $\langle u, \sigma \rangle$ a **representation** of X . \square^u itself is obviously representable. Each component σ_c of σ (where $c \in C$) is an invertible map from $\square^u(c) = C(u, c)$ to Xc .

Theorem 3.55: For any categories C and \mathcal{D} , object $c \in C$, and functor $G: \mathcal{D} \rightarrow C$, we have

$$\text{a universal morphism from } c \text{ to } G \text{ exists} \quad \Leftrightarrow \quad C(c, G-) \text{ is representable}, \quad (3.56)$$

or more specifically, we have that for any $u \in \mathcal{D}$ and $\sigma: \square^u \Rightarrow C(c, G-)$,

$$\begin{aligned} \langle u, \alpha_{X,u}(\sigma) \rangle &\text{ is a universal morphism from } c \text{ to } G \\ \Leftrightarrow \quad \langle u, \sigma \rangle &\text{ is a representation for } C(c, G-), \end{aligned} \quad (3.57)$$

^{‡12}“Essentially” means “up to isomorphism”. We here used the fact that an initial object in any category is essentially unique.

where $X := C(c, G-)$.

Proof. From Lemma 3.48, we have $c \downarrow G = \{*\} \downarrow X$, and being a universal morphism from c to G is equivalent to being an initial object in $c \downarrow G = \{*\} \downarrow X$. Thus, Eq. (3.57) can be rewritten as

$$\langle u, \alpha_{X,u}(\sigma) \rangle \text{ is an initial object in } \{*\} \downarrow X \iff \langle u, \sigma \rangle \text{ is a representation for } X. \quad (3.58)$$

Also, if Eq. (3.58) holds, then the “ \Leftarrow ” direction in Eq. (3.56) obviously holds. The “ \Rightarrow ” direction in Eq. (3.56) holds since the Yoneda map $\alpha_{X,u}$ is invertible by the Yoneda lemma (see Theorem 3.28)^{‡13}. In what follows, we show Eq. (3.58).

Arbitrarily choose an object $u \in \mathcal{D}$ and a natural transformation $\sigma: \square^u \Rightarrow X$. Then, since $\alpha_{X,u}(\sigma)$ is in Xu , $\langle u, \alpha_{X,u}(\sigma) \rangle$ is an object in $\{*\} \downarrow X$. $\langle u, \alpha_{X,u}(\sigma) \rangle$ is an initial object of $\{*\} \downarrow X$ if and only if for any $\langle x, a \rangle \in \{*\} \downarrow X$ (i.e., for any $x \in \mathcal{D}$ and $a \in Xx$), there exists a unique $\bar{a} \in \mathcal{D}(u, x)$ satisfying

$$a = X\bar{a} \circ \alpha_{X,u}(\sigma) \quad \xrightarrow{\text{diagram}} \quad \begin{array}{c} X \mathcal{D} x \\ \text{---} \\ a \\ \text{---} \\ \text{Set} \end{array} \quad (\text{univ}) = \quad \begin{array}{c} X \exists! \bar{a} \\ \text{---} \\ \sigma \\ \text{---} \\ u \end{array}. \quad (3.59)$$

Note that the area enclosed by the auxiliary line represents the initial object $\langle u, \alpha_{X,u}(\sigma) \rangle$. The right-hand side of Eq. (3.59) can be rewritten as

$$\begin{array}{c} \mathcal{D} x \\ \text{---} \\ \bar{a} \\ \text{---} \\ \sigma \\ \text{---} \\ u \end{array} = \begin{array}{c} X \\ \text{---} \\ \sigma \\ \text{---} \\ \square^u \\ \text{---} \\ u \end{array} \quad (3.20) = \quad \begin{array}{c} X \\ \text{---} \\ \sigma \\ \text{---} \\ \bar{a} \\ \text{---} \\ \text{Set} \end{array}. \quad (3.60)$$

Therefore, $\langle u, \alpha_{X,u}(\sigma) \rangle$ is an initial object of $\{*\} \downarrow X$ if and only if for any $\langle x, a \rangle \in \{*\} \downarrow X$, there exists a unique $\bar{a} \in \mathcal{D}(u, x)$ satisfying

$$a = \sigma_x(\bar{a}) \quad \xrightarrow{\text{diagram}} \quad \begin{array}{c} X \mathcal{D} x \\ \text{---} \\ a \\ \text{---} \\ \text{Set} \end{array} \quad \begin{array}{l} (3.59) \\ (3.60) \end{array} = \quad \begin{array}{c} X \\ \text{---} \\ \sigma \\ \text{---} \\ \bar{a} \\ \text{---} \\ \exists! \end{array}. \quad (3.61)$$

Furthermore, this is equivalent to each map $\sigma_x: \mathcal{D}(u, x) \rightarrow Xx$ being invertible (i.e., an isomorphism in **Set**)^{‡14}, and thus equivalent to σ being a natural isomorphism. Since σ being a natural isomorphism is equivalent to $\langle u, \sigma \rangle$ being a representation for X , Eq. (3.58) holds. \square

^{‡13}Indeed, if $\{*\} \downarrow X$ has an initial object $\langle u, \eta \rangle$ (where $u \in \mathcal{D}$ and $\eta \in Xu$), then since $\langle u, \eta \rangle$ is equal to $\langle u, \alpha_{X,u}(\sigma) \rangle$ with $\sigma := \alpha_{X,u}^{-1}(\eta)$, $\langle u, \sigma \rangle$ is a representation for X by Eq. (3.58).

^{‡14}Proof: Arbitrarily choose $x \in \mathcal{D}$. If for each $a \in Xx$, there exists a unique \bar{a} satisfying Eq. (3.61), then the map $\rho_x: Xx \ni a \mapsto \bar{a} \in \mathcal{D}(u, x)$ is the inverse of σ_x since

$$\sigma_x(\rho_x(a)) = a \quad (\forall a \in Xx), \quad \rho_x(\sigma_x(b)) = b \quad (\forall b \in \mathcal{D}(u, x))$$

holds. Therefore, σ_x is invertible. Conversely, if σ_x is invertible, then \bar{a} satisfying Eq. (3.61) (i.e., $a = \sigma_x(\bar{a})$) is uniquely determined by $\bar{a} = \sigma_x^{-1}(a)$.

Substituting $\eta := \alpha_{X,u}(\sigma)$ into Eq. (3.57) yields

$$\begin{aligned} \langle u, \alpha_{X,u}^{-1}(\eta) \rangle & \text{ is a representation for } C(c, G-) \\ \Leftrightarrow \quad \langle u, \eta \rangle & \text{ is a universal morphism from } c \text{ to } G. \end{aligned} \quad (3.62)$$

These equations indicate that two seemingly different concepts, the representation $\langle u, \sigma \rangle$ of $C(c, G-)$ and the universal morphism $\langle u, \eta \rangle$ from c to G , can be interconverted via the Yoneda map $\alpha_{X,u}$ and its inverse. The relationship between σ and η is represented by

$$\begin{aligned} \eta = \alpha_{X,u}(\sigma) & \xrightarrow{\text{diagram}} \begin{array}{c} G \quad \mathcal{D} \quad u \\ \swarrow \quad \searrow \\ \mathcal{C} \quad c \end{array} = \begin{array}{c} \square^c \quad G \\ \swarrow \quad \searrow \\ \text{Set} \quad u \end{array}, \\ \sigma = \alpha_{X,u}^{-1}(\eta) & \xrightarrow{\text{diagram}} \begin{array}{c} \square^c \quad \mathcal{C} \quad G \quad \mathcal{D} \\ \swarrow \quad \searrow \\ \text{Set} \quad \square^u \end{array} = \begin{array}{c} - \\ \swarrow \quad \searrow \\ G \quad u \\ \quad \quad c \end{array}. \end{aligned} \quad (3.63)$$

It can be seen that the black circle representing η is connected to three wires: G, c, u , while the block representing σ is connected to three wires: G, \square^c, \square^u . Intuitively, it can be said that σ corresponds to replacing the two wires c and u in η with \square^c and \square^u , respectively.

As a special case of this theorem, considering the case where c is $\{*\} \in \mathbf{Set}$ and G is $X: \mathcal{C} \rightarrow \mathbf{Set}$ yields

$$\text{a universal morphism from } \{*\} \text{ to } X \text{ exists} \quad \Leftrightarrow \quad X \text{ is representable}, \quad (3.64)$$

where we used the equality $\mathbf{Set}(\{*\}, X-) = X$. We can consider the case of a presheaf $X: \mathcal{C}^{\text{op}} \rightarrow \mathbf{Set}$ by simply replacing \mathcal{C} with \mathcal{C}^{op} ; in this case, Eq. (3.64) still holds.

3.2.4 Basic diagrams for universal morphisms

Assuming that there exists a universal morphism from $c \in \mathcal{C}$ to $G: \mathcal{D} \rightarrow \mathcal{C}$, we show basic diagrams for this morphism. From Theorem 3.55, there exists such a universal morphism if and only if the set-valued functor $C(c, G-)$ is representable. Let $\langle u, \sigma \rangle$ be a representation for $C(c, G-)$; then, $\sigma: \square^u \cong C(c, G-)$ holds. Using a diagram like Eq. (3.12), this isomorphism is expressed by

$$\mathcal{D}(u, -) \cong C(c, G-) \quad \xrightarrow{\text{diagram}} \begin{array}{c} \mathcal{D} \quad - \\ \square^u \end{array} \cong \begin{array}{c} G \quad - \\ \mathcal{C} \quad c \end{array}. \quad (3.65)$$

Let $\eta := \alpha_{X,u}(\sigma)$; then, from Eq. (3.57), $\langle u, \eta \rangle$ is a universal morphism from c to G . For each $x \in \mathcal{D}$, σ_x maps a morphism $\bar{a} \in \mathcal{D}(u, x)$ to $a \in C(c, Gx)$ represented by

$$\begin{array}{c} \mathcal{D} \quad x \\ \square^u \quad \bar{a} \end{array} \xrightarrow{\sigma_x} \begin{array}{c} G \quad x \\ \mathcal{C} \quad c \quad a \end{array} := \begin{array}{c} x \\ \swarrow \quad \searrow \\ G \quad \bar{a} \\ \quad \quad u \\ \quad \quad c \end{array}, \quad (3.66)$$

where the black circle represents the universal morphism η . The right-hand side of the symbol " $\xrightarrow{\sigma_x}$ " corresponds to Eq. (univ). Conversely, each $a \in C(c, Gx)$ is mapped to $\bar{a} \in \mathcal{D}(u, x)$ by σ_x^{-1} , which is represented by

$$\begin{array}{c} G \quad \mathcal{D} \quad x \\ \swarrow \quad \searrow \\ \mathcal{C} \quad c \quad a \end{array} \xrightarrow{\sigma_x^{-1}} \begin{array}{c} x \\ \square^u \quad \bar{a} \end{array} = \begin{array}{c} x \\ \swarrow \quad \searrow \\ G \quad \bar{a} \\ \quad \quad u \\ \quad \quad c \end{array}, \quad (3.67)$$

where we represent the natural transformation σ^{-1} with the blue block in the shape of “ \sqsubset ”. The morphism a inside this block is an input to σ^{-1} .

For any $a \in C(c, Gx)$ and $b \in \mathcal{D}(u, x)$, we have $\sigma_x(\sigma_x^{-1}(a)) = a$ and $\sigma_x^{-1}(\sigma_x(b)) = b$, i.e.,

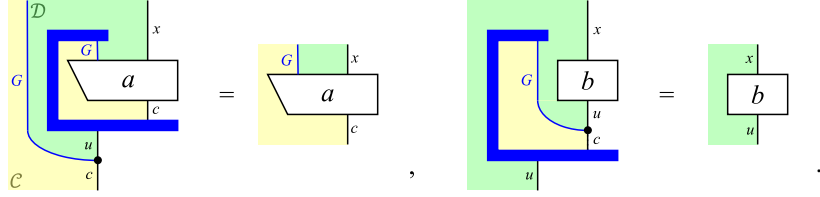

Thus, we have for any $b, b' \in \mathcal{D}(u, x)$,

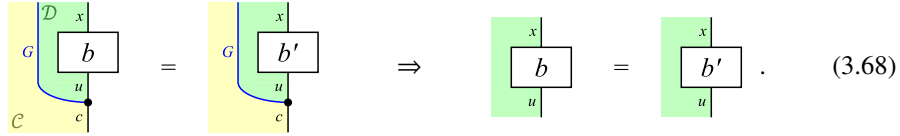

Also, for each $f \in \mathcal{D}(x, y)$, from

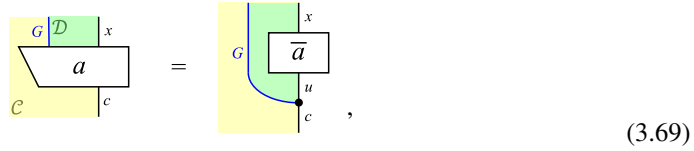

we have

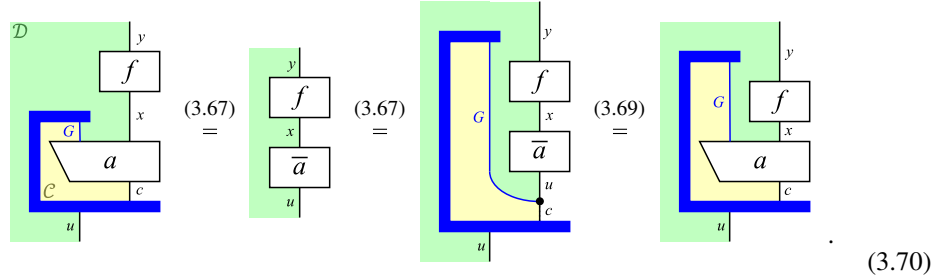

Equation (3.70) is nothing but naturality of σ^{-1} , i.e., $(f \circ -) \circ \sigma_x^{-1} = \sigma_y^{-1} \circ (Gf \circ -)$.

Example 3.71 (the Yoneda lemma): In Eq. (3.33), we introduced a blue block in the shape of “ \sqsubset ”. It can be considered as a special case of the blue block introduced in Eq. (3.67). Indeed, from Example 3.51, $\langle \square^c, 1_c \rangle$ is a universal morphism from $\{*\}$ to ev_c . Considering Eq. (3.67) for this universal morphism (by substituting $\{*\}$ for c and ev_c for G) yields the right-hand side of the comma in Eq. (3.33).





Adjoints, (co)limits, and Kan extensions, which will be discussed in Sections 4, 5, and 6, can be seen as special cases of universal morphisms. The relationships between these concepts and universal morphisms are summarized in Table 3.1. This table also shows the diagrams mainly used in this paper. As will be shown in Subsubsection 6.3.4, adjoints and limits are also special cases of Kan extensions.

3.2.5 Comma category $G \downarrow c$

We can consider an upside-down version of the comma category $c \downarrow G$:

- Its each object is a pair, $\langle x, a \rangle$, of an object $x \in \mathcal{D}$ and a morphism $a \in C(Gx, c)$.

Table 3.1: Relationships among universal morphisms, adjoints, (co)limits, and Kan extensions (the equations within the brackets correspond to each other).

universal morphisms		a universal morphism $\langle u, \eta \rangle$ from $c \in C$ to $G: \mathcal{D} \rightarrow C$ [Eq. (univ), Eq. (3.65)]
left adjoints (Theorem 4.13)		a universal morphism $\langle u_c, \eta_c \rangle$ from $c \in C$ to $G: \mathcal{D} \rightarrow C$ (for each c) ($F: C \rightarrow \mathcal{D}$ with $Fc = u_c$ is a left adjoint to G) [Eq. (4.5), Eq. (4.3)]
colimits (Subsubsection 5.1.3)		a universal morphism $\langle d, \eta \rangle$ from $D \in \mathcal{C}^{\mathcal{J}}$ to $\Delta_{\mathcal{J}} = - \bullet -: C \rightarrow C^{\mathcal{J}}$ (i.e., a colimit of D) [Eq. (5.6), Eq. (5.10)]
left Kan extensions (Definition 6.1)		a universal morphism $\langle L, \eta \rangle$ from $F \in \mathcal{E}^C$ to $- \bullet K: \mathcal{E}^{\mathcal{D}} \rightarrow \mathcal{E}^C$ (i.e., a left Kan extension of F along K) [Eq. (6.2), Eq. (6.8)]

- Its each morphism from an object $\langle x, a \rangle$ to an object $\langle y, a' \rangle$ is a morphism $f \in \mathcal{D}(x, y)$ in \mathcal{D} satisfying

$$a' \circ Gf = a \quad \text{diagram} \quad \begin{array}{c} \text{C} \\ \hline a' \\ \hline y \\ \hline G \\ \hline \mathcal{D} \\ \hline x \end{array} = \begin{array}{c} \text{C} \\ \hline a \\ \hline G \\ \hline x \end{array} . \quad (3.72)$$

- The composite of its morphisms is the composite of morphisms in \mathcal{D} , and its identity morphism is the identity morphism in \mathcal{D} .

This category is denoted by $G \downarrow c$ and is also called a comma category. Note that $G \downarrow c$ is not exactly the opposite of $c \downarrow G$ (please compare Eq. (3.47) and Eq. (3.72)).

Definition 3.73 (universal morphisms): A terminal object ${}^{*a}\langle u, \varepsilon \rangle$ (or simply ε) in a comma category $G \downarrow c$ is called a universal morphism from G to c . In other words, $\langle u, \varepsilon \rangle$ with $u \in \mathcal{D}$ and $\varepsilon \in C(Gu, c)$ is called a universal morphism from G to c if, for any morphism $a \in C(Gx, c)$ with any $x \in \mathcal{D}$, there exists a unique morphism $\bar{a} \in \mathcal{D}(x, u)$ satisfying

$$a = \varepsilon \circ G\bar{a} \quad \text{diagram} \quad \begin{array}{c} \text{C} \\ \hline a \\ \hline G \\ \hline \mathcal{D} \\ \hline x \end{array} = \begin{array}{c} \text{C} \\ \hline u \\ \hline \bullet \\ \hline \bar{a} \\ \hline x \end{array} , \quad (3.74)$$

where the black circle represents ε .

^{*a}A **terminal object** in C is an object a in C such that for any $x \in C$, there exists a unique morphism with domain x and codomain a .

Since terminal objects are essentially unique, universal morphisms from G to c are also essentially unique. It follows from the dual of Lemma 3.48 that $G \downarrow c$ is equal to the comma category $(C(G-, c))^{\text{op}} \downarrow \{*\}$ (where $(C(G-, c))^{\text{op}}: \mathcal{D} \rightarrow \mathbf{Set}^{\text{op}}$ and $\{*\} \in \mathbf{Set}^{\text{op}}$). Also, as the dual of Theorem 3.55, we have

$$\text{a universal morphism from } G \text{ to } c \text{ exists} \quad \Leftrightarrow \quad C(G-, c) \text{ is representable.} \quad (3.75)$$

By vertically flipping diagrams for a universal morphism from c to G , we obtain corresponding diagrams for a universal morphism from G to c . For example, if $\langle u, \sigma \rangle$ is a representation for the functor $C(G-, c)$, then any object $\langle x, a \rangle$ in $G \downarrow c$ is mapped to the following morphism $\bar{a} \in \mathcal{D}(x, u)$ by σ_x^{-1} :

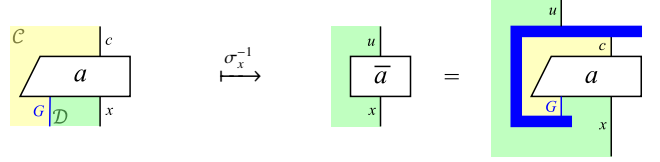

which corresponds to the upside-down version of Eq. (3.67).

The category of elements of a set-valued functor $Y: C^{\text{op}} \rightarrow \mathbf{Set}$, $\text{el}(Y)$, is defined as the comma category $Y^{\text{op}} \downarrow \{*\}$ with $\{*\} \in \mathbf{Set}^{\text{op}}$. Then, we have $\text{el}(C(G-, c)) = G \downarrow c$. Some basic properties of comma categories will be discussed in Subsubsection 6.2.1.

3.3 Basic properties of universal morphisms

We show some basic properties of universal morphisms as the following three lemmas, which will be used in the following sections.

Lemma 3.76: Consider any object $c \in C$ and functors $G: \mathcal{D} \rightarrow C$ and $G': \mathcal{D}' \rightarrow C$. Assume that there exists a universal morphism $\langle u, \eta \rangle$ from c to G ; then, the following properties hold:

- (1) If there exists a universal morphism $\langle u', \eta' \rangle$ from u to G' , then $\langle u', v \rangle$ with $v := (G \bullet \eta') \circ \eta$ is a universal morphism from c to $G \bullet G'$.
- (2) If there exists a universal morphism $\langle u', v \rangle$ from c to $G \bullet G'$, then there exists a universal morphism $\langle u', \eta' \rangle$ from u to G' satisfying $v = (G \bullet \eta') \circ \eta$.

Note that the relationships between the universal morphisms $\langle u, \eta \rangle$, $\langle u', \eta' \rangle$, and $\langle u', v \rangle$ can be represented by

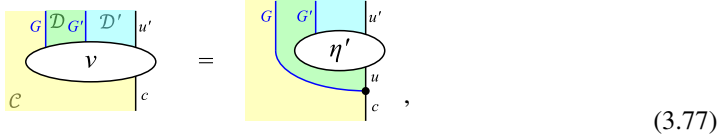

where the black circle represents η . Property (1) asserts that $v := (G \bullet \eta') \circ \eta$, which is something corresponding to the “vertical composite of universal morphisms η and η' ”, is a universal morphism. Conversely, Property (2) asserts that if such a universal morphism v exists, then v can be decomposed into two universal morphisms η and η' .

Proof. (1): For any object $\langle x, a \rangle$ in $c \downarrow (G \bullet G')$, there exist unique morphisms $\bar{a} \in \mathcal{D}(u, G'x)$ and $\bar{a}' \in \mathcal{D}'(u', x)$ satisfying

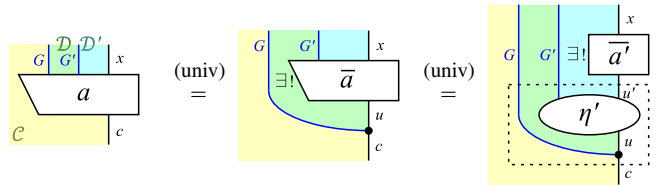

where the black circles represent η , and the morphism enclosed by the auxiliary line is v . Therefore, $\langle u', v \rangle$ is a universal morphism from c to $G \bullet G'$.

(2): By the universal property of η , there exists a unique $\eta' \in \mathcal{D}(u, G'u')$ satisfying Eq. (3.77) (i.e., $v = (G \bullet \eta') \circ \eta$). For any object $\langle x, a \rangle$ in $u \downarrow G'$, there exists a unique morphism $\bar{a} \in \mathcal{D}'(u', x)$ satisfying

where the first equality follows from the universal property of v for the morphism enclosed by the auxiliary line. Therefore, by the universal property of η (recall Eq. (3.68)), $\langle u', \eta' \rangle$ is a universal morphism from u to G' . \square

Lemma 3.78: Consider any object $c \in C$ and functor $G: \mathcal{D} \rightarrow C$. Arbitrarily choose any category C' isomorphic to C and invertible functor $P: C \rightarrow C'$. Then, $\langle u, \eta \rangle$ is a universal morphism from c to G if and only if $\langle u, P \bullet \eta \rangle$ is a universal morphism from Pc to $P \bullet G$. Dually, $\langle u', \varepsilon \rangle$ is a universal morphism from G to c if and only if $\langle u', P \bullet \varepsilon \rangle$ is a universal morphism from $P \bullet G$ to Pc .

Proof. We show that $\langle u, \eta \rangle$ is a universal morphism from c to G if and only if $\langle u, P \bullet \eta \rangle$ is a universal morphism from Pc to $P \bullet G$; the remainder of the proof is obvious from its dual^{‡15}. It suffices to show the “only if” part since the “if” part is obvious by considering P^{-1} instead of P . Let $\langle u, \eta \rangle$ be a universal morphism from c to G . Also, arbitrarily choose any $x \in \mathcal{D}$ and $a' \in C'(Pc, (P \bullet G)x)$ and let $a := P^{-1} \bullet a'$; then, there exists a unique \bar{a} satisfying

where the black circle represents η . The natural transformation enclosed by the auxiliary line is $P \bullet \eta$. Therefore, $\langle u, P \bullet \eta \rangle$ is a universal morphism from Pc to $P \bullet G$. \square

Lemma 3.79: Consider any functors $H: \mathcal{J} \rightarrow C$ and $G: \mathcal{D} \rightarrow C$. Assume that for each $j \in \mathcal{J}$, there exists a universal morphism $\langle u_j, \eta_j \rangle$ from Hj to G . Then, the following two properties hold:

- (1) There exists a unique functor $F: \mathcal{J} \rightarrow \mathcal{D}$ that maps each object $j \in \mathcal{J}$ to $Fj = u_j$ and such that $\eta := \{\eta_j\}_{j \in \mathcal{J}}$ is a natural transformation from H to $G \bullet F$. Note that η can be represented by

where the blue circle represents η and the black ellipse represents η_j .

- (2) $\langle F, \eta \rangle$ is a universal morphism from the object $H \in C^{\mathcal{J}}$ to the functor $G \bullet -: \mathcal{D}^{\mathcal{J}} \rightarrow C^{\mathcal{J}}$ (i.e., an initial object in $H \downarrow (G \bullet -)$).

^{‡15}Properties related to duality can be shown simply by considering their duals, so we usually omit their proofs.

Proof. (1): First, assuming that there exists a functor F satisfying the conditions, we show that F is uniquely determined. By assumption, we have for any $f \in \mathcal{J}(j, j')$,

$$\begin{array}{c} \mathcal{C} \mathcal{D} \mathcal{J} j' \\ \downarrow G \quad \downarrow F \quad \downarrow f \\ \downarrow H \quad \downarrow j \end{array} = \text{(nat)} \quad \begin{array}{c} G \quad F \quad j' \\ \downarrow \quad \downarrow \quad \downarrow \\ H \quad \downarrow \quad j \\ \downarrow f \end{array} = \text{(univ)} \quad \begin{array}{c} G \quad F \quad j' \\ \downarrow \quad \downarrow \quad \downarrow \\ \downarrow \quad \downarrow \quad \downarrow \\ H \quad \downarrow \quad j \end{array} \bar{f},$$

where the black ellipses represent η_j and $\eta_{j'}$ and \bar{f} is the morphism uniquely determined by the universal property of η_j . Thus, we obtain $Ff = \bar{f}$ from Eq. (3.68). Therefore, if a functor F exists, then it is uniquely determined as one that maps each morphism f in \mathcal{J} to \bar{f} .

Next, we show that F defined as above is a functor. We have for any $f \in \mathcal{J}(j, j')$ and $g \in \mathcal{J}(j', j'')$,

$$\begin{array}{c} \mathcal{C} \mathcal{D} \mathcal{J} j'' \\ \downarrow G \quad \downarrow Fj'' \\ \downarrow H \quad \downarrow j \end{array} F(gf) = \text{(nat)} \quad \begin{array}{c} G \quad Fj'' \\ \downarrow \quad \downarrow \\ H \quad \downarrow \\ \downarrow g \\ \downarrow f \end{array} = \text{(univ)} \quad \begin{array}{c} G \quad Fj'' \\ \downarrow \quad \downarrow \\ \downarrow \quad \downarrow \\ H \quad \downarrow \\ \downarrow f \end{array} Fg = \text{(univ)} \quad \begin{array}{c} G \quad Fj'' \\ \downarrow \quad \downarrow \\ \downarrow \quad \downarrow \\ H \quad \downarrow \\ \downarrow Ff \end{array}.$$

Therefore, it follows from Eq. (3.68) that $F(gf) = Fg \circ Ff$ holds. Also, $F1_j = 1_{Fj}$ obviously holds, and thus F is a functor. It can be easily seen that F satisfies the conditions.

(2): It suffices to show that for any natural transformation $\alpha: H \Rightarrow G \bullet X$ with any $X: \mathcal{J} \rightarrow \mathcal{D}$, there exists a unique natural transformation $\bar{\alpha}: F \Rightarrow X$ satisfying

$$\begin{array}{c} \mathcal{C} \mathcal{D} \mathcal{X} \mathcal{J} \\ \downarrow G \quad \downarrow X \quad \downarrow \\ \downarrow H \quad \downarrow j \end{array} \alpha = \left\{ \begin{array}{c} G \quad X \\ \downarrow \quad \downarrow \\ H \quad \downarrow \\ \downarrow \alpha \end{array} \right\}_j = \text{(univ)} \quad \left\{ \begin{array}{c} G \quad X \quad j \\ \downarrow \quad \downarrow \quad \downarrow \\ \downarrow \quad \downarrow \quad \downarrow \\ H \quad \downarrow \quad j \end{array} \bar{\alpha}_j \right\} = \begin{array}{c} G \quad X \quad j \\ \downarrow \quad \downarrow \quad \downarrow \\ \downarrow \quad \downarrow \quad \downarrow \\ H \quad \downarrow \quad j \end{array} \bar{\alpha}, \quad (3.81)$$

where the blue circle represents η . Since the first and second equalities hold, it suffices to show the last equation, which is equivalent to $\bar{\alpha} := \{\bar{\alpha}_j\}_{j \in \mathcal{J}}$ being a natural transformation. We have

$$\begin{array}{c} \mathcal{C} \mathcal{D} \mathcal{J} j' \\ \downarrow G \quad \downarrow X \quad \downarrow f \\ \downarrow H \quad \downarrow j \end{array} \bar{\alpha}_j = \text{(3.81)} \quad \begin{array}{c} G \quad X \quad j' \\ \downarrow \quad \downarrow \quad \downarrow \\ H \quad \downarrow \quad j \end{array} \alpha = \text{(sld)} \quad \begin{array}{c} G \quad X \quad j' \\ \downarrow \quad \downarrow \quad \downarrow \\ H \quad \downarrow \quad j \end{array} \alpha = \text{(3.81)} \quad \begin{array}{c} X \quad j' \\ \downarrow \quad \downarrow \\ F \quad \downarrow \\ \downarrow f \end{array} \bar{\alpha}_j.$$

Therefore,

$$\begin{array}{c} \mathcal{D} \mathcal{J} j' \\ \downarrow X \quad \downarrow f \\ \downarrow F \quad \downarrow j \end{array} \bar{\alpha}_j = \begin{array}{c} X \quad j' \\ \downarrow \quad \downarrow \\ F \quad \downarrow \\ \downarrow f \end{array} \bar{\alpha}_j$$

holds from Eq. (3.68), and thus $\bar{\alpha}$ is a natural transformation. \square

4 Adjunctions

Roughly speaking, an adjunction is a concept that describes the relationship between two functors that are weakly inverse to each other. It is well known that adjunctions can be intuitively understood through the use of string diagrams. Adjunctions are also closely related to monads. String diagrams for adjunctions and monads are discussed in detail in Ref. [8]. In this paper, we briefly describe some basic properties of adjunctions in a self-contained manner. Monads are not discussed in this paper, except for a brief coverage in Subsubsection 6.3.5.

4.1 Definition of adjunctions

Definition 4.1 (adjunctions): Let us consider a pair of two functors $F: C \rightarrow D$ and $G: D \rightarrow C$. When there is a natural isomorphism $\varphi: \mathcal{D}(F-, =) \cong C(-, G=)$, we call $\langle F, G, \varphi \rangle$ an **adjunction**. Also, F is called a **left adjoint** to G , and G is called a **right adjoint** to F . The symbol “ \dashv ” is used to denote adjunctions: $F \dashv G$ means that F is a left adjoint to G .

$\varphi = \{\varphi_{c,d}\}_{(c,d) \in C \times D}$ is a collection of morphisms (i.e., maps) in **Set**, whose each component $\varphi_{c,d}$ is a bijective map from $\mathcal{D}(Fc, d)$ to $C(c, Gd)$. Naturality of φ is equivalent to satisfying

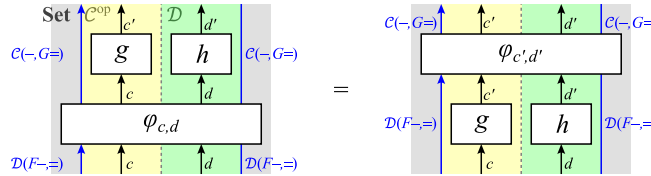

for any $g \in C^{op}(c, c') = C(c', c)$ and $h \in \mathcal{D}(d, d')$, where we used the expression for direct products (recall Subsection 2.3). This equation is equivalent to satisfying

for each $f \in \mathcal{D}(Fc, d)$ (see Eq. (3.9)). Using the expression of Eq. (3.12), the isomorphism $\mathcal{D}(F-, =) \cong C(-, G=)$ can be represented by

4.2 Necessary and sufficient conditions for adjunctions

Necessary and sufficient conditions for $F \dashv G$ are shown by two theorems (Theorems 4.9 and 4.13).

4.2.1 Preliminaries

Lemma 4.4: Consider an adjunction $\langle F, G, \varphi \rangle$ with $F: \mathcal{C} \rightarrow \mathcal{D}$. Also, let $\eta_c := \varphi_{c, Fc}(1_{Fc})$ and $\varepsilon_d := \varphi_{Gd, d}^{-1}(1_{Gd})$. Then, the following properties hold:

- (1) For each $c \in \mathcal{C}$, $\langle Fc, \eta_c \rangle$ is a universal morphism from c to G .
- (2) For each $d \in \mathcal{D}$, $\langle Gd, \varepsilon_d \rangle$ is a universal morphism from F to d .

Proof. (1): For each $c \in \mathcal{C}$, $\{\varphi_{c, d}\}_{d \in \mathcal{D}}$ is a natural isomorphism from $\mathcal{D}(Fc, -)$ to $\mathcal{C}(c, G-)$. Thus, $\langle Fc, \{\varphi_{c, d}\}_{d \in \mathcal{D}} \rangle$ is a representation for $\mathcal{C}(c, G-)$. Therefore, from Eq. (3.57), $\langle Fc, \eta_c \rangle$ is a universal morphism from c to G .

(2): The dual of (1) proves (2). □

For each $c \in \mathcal{C}$ and $d \in \mathcal{D}$, $f \in \mathcal{D}(Fc, d)$ and $\bar{f} := \varphi_{c, d}(f) \in \mathcal{C}(c, Gd)$ correspond one-to-one. Using the diagram in Eq. (3.66) to represent the universal morphism $\langle Fc, \eta_c \rangle$, we obtain

$$\begin{array}{c} \mathcal{D} \\ d \\ \hline \text{---} f \text{---} \\ \hline F \\ c \end{array} \xrightarrow{\varphi_{c,d}} \begin{array}{c} G \mathcal{D} \\ d \\ \hline \text{---} \bar{f} \text{---} \\ \hline c \end{array} = \begin{array}{c} \mathcal{D} \\ d \\ \hline \text{---} f \text{---} \\ \hline F \\ c \end{array}, \quad (4.5)$$

where the area enclosed by the gray dotted line represents the morphism η_c . The right-hand side of the symbol “ $\xrightarrow{\varphi_{c,d}}$ ” corresponds to Eq. (univ). Similarly, using the universal property of $\langle Gd, \varepsilon_d \rangle$, we obtain

$$\begin{array}{c} G \mathcal{D} \\ d \\ \hline \text{---} \bar{f} \text{---} \\ \hline c \end{array} \xrightarrow{\varphi_{c,d}^{-1}} \begin{array}{c} \mathcal{D} \\ d \\ \hline \text{---} f \text{---} \\ \hline F \\ c \end{array} = \begin{array}{c} \mathcal{D} \\ d \\ \hline \text{---} f \text{---} \\ \hline F \\ c \end{array}, \quad (4.6)$$

where the area enclosed by the gray dotted line represents the morphism ε_d . The right-hand side of the symbol “ $\xrightarrow{\varphi_{c,d}^{-1}}$ ” corresponds to Eq. (3.74). Here, the morphisms η_c and ε_d are represented by special-shaped blocks; it will soon become clear that these representations help with intuitive understanding and that the gray dotted lines can be considered simply as auxiliary lines. From Eq. (4.5), Eq. (4.2) can be expressed by

$$\begin{array}{c} \mathcal{D} \\ d' \\ \hline h \\ \hline d \\ \hline \text{---} f \text{---} \\ \hline F \\ c \\ \hline g \\ c' \end{array} = \begin{array}{c} \mathcal{D} \\ d' \\ \hline h \\ \hline d \\ \hline \text{---} f \text{---} \\ \hline F \\ c \\ \hline g \\ c' \end{array} \quad (\forall f \in \mathcal{D}(Fc, d)). \quad (4.7)$$

Similarly, using the notation of Eq. (4.6), naturality of $\varphi^{-1} = \{\varphi_{c,d}^{-1}\}_{c \in \mathcal{C}, d \in \mathcal{D}}$ is represented by the fulfillment of

$$\begin{array}{c} \mathcal{D} \\ d' \\ \hline h \\ \hline d \\ \hline \text{---} \bar{f} \text{---} \\ \hline G \\ c \\ \hline g \\ c' \end{array} = \begin{array}{c} \mathcal{D} \\ d' \\ \hline h \\ \hline d \\ \hline \text{---} \bar{f} \text{---} \\ \hline F \\ c \\ \hline g \\ c' \end{array} \quad (\forall \bar{f} \in \mathcal{C}(c, Gd)) \quad (4.8)$$

for any $g \in C^{\text{op}}(c, c') = C(c', c)$ and $h \in \mathcal{D}(d, d')$.

4.2.2 Necessary and sufficient conditions using unit and counit

The first necessary and sufficient condition uses two natural transformations η and ε .

Theorem 4.9: Consider a pair of two functors $F: C \rightarrow \mathcal{D}$ and $G: \mathcal{D} \rightarrow C$. The following are equivalent:

- (1) $F \dashv G$ holds.
- (2) There exist two natural transformations $\eta: 1_C \Rightarrow G \bullet F$ and $\varepsilon: F \bullet G \Rightarrow 1_{\mathcal{D}}$ satisfying

$$(G \bullet \varepsilon) \circ (\eta \bullet G) = 1_G, (\varepsilon \bullet F) \circ (F \bullet \eta) = 1_F$$

diagram \rightsquigarrow



(zigzag)

where η and ε are represented by the following semicircular blocks:



(4.10)

η is called the **unit** of the adjunction $F \dashv G$, and ε is called its **counit**. Intuitively, ε can be interpreted as the “natural transformation obtained by rotating η by 180 degrees”. Equation (zigzag) is often called the **zigzag** (or triangle) **identities**.

Proof. (1) \Rightarrow (2): For each $d \in \mathcal{D}$, by setting $c = Gd$ and $\bar{f} = 1_{Gd}$ in Eqs. (4.5) and (4.6), we obtain

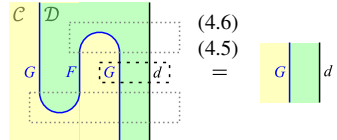

(4.11)

Similarly, for each $c \in C$, by setting $d = Fc$ and $f = 1_{Fc}$, we obtain

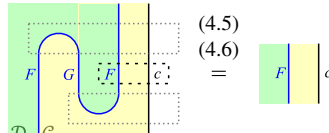

(4.12)

It remains to show that $\eta := \{\eta_c\}_{c \in C}$ and $\varepsilon := \{\varepsilon_d\}_{d \in \mathcal{D}}$ are natural transformations, as Eq. (zigzag) obviously holds from Eqs. (4.11) and (4.12) if they are. Substituting $d = d' = Fc$ and $f = h = 1_{Fc}$ into Eq. (4.7) yields the naturality condition for η (i.e., $\eta_c \circ g = (G \bullet F)g \circ \eta_{c'}$), thus η is a natural transformation. Similarly, substituting $c = c' = Gd$ and $\bar{f} = g = 1_{Gd}$ into Eq. (4.8) yields the naturality condition for ε (i.e., $h \circ \varepsilon_d = \varepsilon_{d'} \circ (F \bullet G)h$), thus ε is also a natural transformation.

(2) \Rightarrow (1): Defining a map $\varphi_{c,d}$ by Eq. (4.5), it follows from Eq. (zigzag) that its inverse $\varphi_{c,d}^{-1}$ is given by Eq. (4.6). Also, Eq. (4.7) holds from naturality of η . Therefore, φ is a natural isomorphism, and thus $F \dashv G$ holds. \square

It can be seen that η_c in Eq. (4.5) and ε_d in Eq. (4.6) are nothing more than representations using Eq. (4.10). Since η and ε are natural transformations, there is no problem with removing the gray dotted lines from the above diagrams. In what follows, these gray dotted lines are omitted.

Instead of calling $\langle F, G, \varphi \rangle$ an adjunction, it is also possible to call $\langle F, G, \eta, \varepsilon \rangle$ an adjunction. It follows from Eqs. (4.5) and (4.6) that φ and η , as well as φ and ε , can be interconverted.

4.2.3 Necessary and sufficient conditions using universal morphisms

The second necessary and sufficient condition uses universal morphisms.

Theorem 4.13: For any functor $G: \mathcal{D} \rightarrow \mathcal{C}$, the following are equivalent:

- (1) G has a left adjoint.
- (2) There exists a universal morphism from each $c \in \mathcal{C}$ to G .

Also, if Condition (1) holds, then for a left adjoint F to G and its unit η , $\langle Fc, \eta_c \rangle$ is a universal morphism from c to G . On the other hand, if Condition (2) holds, then for a universal morphism $\langle d_c, \eta_c \rangle$ from c to G , there exists a unique left adjoint F to G such that $Fc = d_c$ holds and $\{\eta_c\}_{c \in \mathcal{C}}$ is its unit.

By considering the dual of this theorem, it can be immediately shown that a functor $F: \mathcal{C} \rightarrow \mathcal{D}$ has a right adjoint if and only if there exists a universal morphism from F to each $d \in \mathcal{D}$.

Proof. (1) \Rightarrow (2): This is obvious from Lemma 4.4.

(2) \Rightarrow (1): For each $c \in \mathcal{C}$, let $\langle d_c, \eta_c \rangle$ be a universal morphism from c to G . Considering the case where H is the identity functor in Lemma 3.79, there exists a unique functor F that maps each $c \in \mathcal{C}$ to $Fc = d_c$ and such that $\eta := \{\eta_c\}_{c \in \mathcal{C}}$ is a natural transformation from $1_{\mathcal{C}}$ to $G \bullet F$. Choose the functor F in this way.

For each $c \in \mathcal{C}$ and $d \in \mathcal{D}$, consider the map $\varphi_{c,d}$ given by Eq. (4.5). Since $\langle Fc, \eta_c \rangle$ is a universal morphism from c to G , it follows that $\varphi_{c,d}$ is invertible (see Eq. (3.62) or Eq. (3.63)). Also, it follows from Eq. (4.7) that $\varphi := \{\varphi_{c,d}\}_{c \in \mathcal{C}, d \in \mathcal{D}}$ is a natural isomorphism. Therefore, $\langle F, G, \varphi \rangle$ is an adjunction. Furthermore, since $\eta_c = \varphi_{c, Fc}(1_{Fc})$, η is its unit. \square

4.3 Basic properties of adjunctions

4.3.1 Uniqueness of adjunctions

Consider an adjunction $F \dashv G$. We show that any left adjoint to G is isomorphic to F , which means that a left adjoint is essentially unique (see Proposition 4.14). Conversely, any functor isomorphic to F is a left adjoint to G (see Proposition 4.19). Dually, the same applies to right adjoints.

Proposition 4.14: Let $\langle F, G, \eta, \varepsilon \rangle$ and $\langle F', G, \eta', \varepsilon' \rangle$ be adjunctions, where $F, F': \mathcal{C} \rightarrow \mathcal{D}$ and $G: \mathcal{D} \rightarrow \mathcal{C}$. Then, there exists a unique natural isomorphism $\alpha: F \cong F'$ satisfying

$$\begin{array}{c} \mathcal{D} \\ \downarrow G \quad \downarrow F' \\ \mathcal{C} \end{array} \begin{array}{c} \eta' \\ \circlearrowleft \end{array} = \begin{array}{c} \mathcal{D} \\ \downarrow G \quad \downarrow F' \\ \mathcal{C} \end{array} \begin{array}{c} \alpha \\ \circlearrowleft \end{array} , \quad (4.15)$$

where the area enclosed by the auxiliary line is η . Note that the isomorphism $F \cong F'$ implies that a left adjoint to G is essentially unique if it exists. Also,

$$(4.16)$$

holds, where the area enclosed by the auxiliary line is ε .

Proof. If a natural isomorphism α satisfying Eq. (4.15) exists, then from

Eq. (4.16) holds. Thus, it suffices to show that there exists a unique natural isomorphism α satisfying Eq. (4.15). If there exists a natural transformation α satisfying Eq. (4.15), then we have

$$(4.17)$$

Conversely, when α is defined by Eq. (4.17), Eq. (4.15) obviously holds. Thus, there exists a unique natural transformation α satisfying Eq. (4.15). Also, let

$$(4.18)$$

then, from

and

(4.17)
(4.18)

(zigzag)

we have $\beta = \alpha^{-1}$. Therefore, α is an isomorphism. \square

Proposition 4.19: Consider an adjunction $F \dashv G$. Any functor isomorphic to F is a left adjoint to G .

Proof. Let α be a natural isomorphism from F to a functor F' . Also, let

where the natural transformations enclosed by the auxiliary lines on the left and right are respectively the unit and counit of the adjunction $F \dashv G$. Then, from

and

η' and ε' satisfy Eq. (zigzag). Thus, from Theorem 4.9, $F' \dashv G$ holds. \square

4.3.2 Properties of equivalences of categories

An equivalence of categories, $C \simeq D$, is the existence of functors $F: C \rightarrow D$ and $G: D \rightarrow C$ such that $1_C \cong G \bullet F$ and $F \bullet G \cong 1_D$. We show that each equivalence of categories yields an adjunction.

Proposition 4.20: Let us consider two functors $F: \mathcal{C} \rightarrow \mathcal{D}$ and $G: \mathcal{D} \rightarrow \mathcal{C}$. If there exist natural isomorphisms $\eta: 1_{\mathcal{C}} \cong G \bullet F$ and $\tau: F \bullet G \cong 1_{\mathcal{D}}$, which indicates $\mathcal{C} \simeq \mathcal{D}$, then there exists an adjunction $F \dashv G$ whose unit is η .

Proof. Let

(4.21)

then, we have

(4.22)

where the natural transformation enclosed by the auxiliary line on the left is η . Also, let

then, α is a natural isomorphism since it is composed of only natural isomorphisms. From

(4.22)

we have $\alpha\alpha = \alpha$. Applying α^{-1} to both sides yields $\alpha = 1_G$. Therefore, Eq. (zigzag) holds, and thus, from Theorem 4.9, there exists an adjunction $F \dashv G$ whose unit is η . \square

Proposition 4.23: Consider an adjunction $F \dashv G$. The following are equivalent:

- (1) $G \bullet F \cong 1_{\mathcal{C}}$ holds.
- (2) F is fully faithful.
- (3) The unit η is an isomorphism.

Dually, the following are equivalent:

- (1) $F \bullet G \cong 1_{\mathcal{D}}$ holds.

- (2) G is fully faithful.
- (3) The counit ε is an isomorphism.

Proof. (1) \Rightarrow (2): Arbitrarily choose a natural isomorphism $\phi: G \bullet F \cong 1_C$ and two objects $a, b \in C$. It suffices to show that for each $f \in \mathcal{D}(Fa, Fb)$, there exists a unique $\bar{f} \in C(a, b)$ satisfying (see Eq. (2.4))

$$\begin{array}{|c|} \hline \mathcal{D} \quad F \quad C \\ \hline f \\ \hline F \\ \hline a \end{array} \quad = \quad \begin{array}{|c|} \hline F \quad \exists! \\ \hline \bar{f} \\ \hline a \end{array} \quad . \quad (4.24)$$

If such \bar{f} exists, then

$$\begin{array}{|c|} \hline C \\ \hline \bar{f} \\ \hline a \end{array} \quad = \quad \begin{array}{|c|} \hline G \quad D \quad F \\ \hline \bar{f} \\ \hline a \end{array} \quad = \quad \begin{array}{|c|} \hline G \quad F \\ \hline f \\ \hline a \end{array} \quad (4.25)$$

uniquely determines \bar{f} , where the white and blue diamond blocks represent ϕ and ϕ^{-1} , respectively. The first equality follows from $\phi\phi^{-1} = 1_{1_C}$. Also, such \bar{f} satisfies

$$\begin{array}{|c|} \hline \mathcal{D} \quad C \\ \hline f \\ \hline F \\ \hline a \end{array} \quad \stackrel{(4.25)}{=} \quad \begin{array}{|c|} \hline F \quad G \\ \hline f \\ \hline a \end{array} \quad \stackrel{(\text{zigzag})}{=} \quad \begin{array}{|c|} \hline G \quad F \\ \hline f \\ \hline a \end{array} \quad \stackrel{(\text{zigzag})}{=} \quad \begin{array}{|c|} \hline F \quad G \\ \hline f \\ \hline a \end{array} \quad \stackrel{(\text{zigzag})}{=} \quad \begin{array}{|c|} \hline F \quad C \\ \hline f \\ \hline F \\ \hline a \end{array} \quad ,$$

and thus Eq. (4.24) holds. We use the fact that the areas enclosed by auxiliary lines represent $\phi^{-1}\phi = 1_{G \bullet F}$. Therefore, there exists a unique \bar{f} satisfying Eq. (4.24).

(2) \Rightarrow (3): It suffices to show that for any $c \in C$, η_c is an isomorphism. Let $\langle F, G, \varphi \rangle$ be an adjunction. For each $a \in C$, consider the map

$$\rho := \varphi_{a,c} \circ \hat{F}: C(a, c) \rightarrow C(a, G \bullet Fc),$$

where \hat{F} is the map $C(a, c) \ni f \mapsto Ff \in \mathcal{D}(Fa, Fc)$. ρ maps each $f \in C(a, c)$ to $\eta_c f \in C(a, G \bullet Fc)$ since

$$\begin{array}{|c|} \hline C \\ \hline f \\ \hline a \end{array} \quad \xrightarrow{\hat{F}} \quad \begin{array}{|c|} \hline \mathcal{D} \quad F \\ \hline f \\ \hline a \end{array} \quad \xrightarrow{\varphi_{a,c}} \quad \begin{array}{|c|} \hline G \quad F \\ \hline f \\ \hline a \end{array}$$

holds. \hat{F} is invertible since F is fully faithful, and $\varphi_{a,c}$ is invertible since $\langle F, G, \varphi \rangle$ is an adjunction; thus, ρ is also invertible. Consider the case of $a = G \bullet Fc$ and consider a morphism $h \in C(G \bullet Fc, c)$ that satisfies

$$\rho(h) = 1_{G \bullet Fc} \xrightarrow{\text{diagram}} \begin{array}{|c|} \hline \text{\textcircled{G}} \text{\textcircled{F}} \\ \hline \text{\textcircled{h}} \\ \hline \text{\textcircled{G}} \text{\textcircled{D}} \text{\textcircled{F}} \\ \hline c \\ \hline \end{array} = \begin{array}{|c|} \hline \text{\textcircled{G}} \text{\textcircled{F}} \\ \hline c \\ \hline \end{array}. \quad (4.26)$$

Note that since ρ is invertible, such h is uniquely determined by $h = \rho^{-1}(1_{G \bullet Fc})$. We show that h is the inverse of η_c . Since the left-hand side, $\rho(h)$, of Eq. (4.26) is equal to $\eta_c h$, $\eta_c h = 1_{G \bullet Fc}$ holds. Therefore, it suffices to show that $h \eta_c = 1_c$. We have

$$\begin{array}{|c|} \hline \text{\textcircled{D}} \text{\textcircled{C}} \\ \hline \text{\textcircled{h}} \\ \hline \text{\textcircled{F}} \\ \hline c \\ \hline \end{array} \xrightarrow{\text{zigzag}} \begin{array}{|c|} \hline \text{\textcircled{G}} \text{\textcircled{F}} \\ \hline \text{\textcircled{h}} \\ \hline \text{\textcircled{G}} \text{\textcircled{D}} \text{\textcircled{F}} \\ \hline c \\ \hline \end{array} \xrightarrow{(4.26)} \begin{array}{|c|} \hline \text{\textcircled{G}} \text{\textcircled{F}} \\ \hline c \\ \hline \end{array} \xrightarrow{\text{zigzag}} \begin{array}{|c|} \hline \text{\textcircled{F}} \\ \hline c \\ \hline \end{array},$$

i.e., $F \bullet h \eta_c = F \bullet 1_c$. Therefore, since F is fully faithful, $h \eta_c = 1_c$ holds (see Eq. (2.4)).

(3) \Rightarrow (1): It is clear from $\eta: G \bullet F \cong 1_C$. □

4.3.3 Properties of bifunctors

Proposition 4.27: Let us consider a bifunctor $F: C \times \mathcal{E} \rightarrow \mathcal{D}$. For each $e \in \mathcal{E}$, if the functor $F(-, e)$ has a right adjoint G_e , then there exists a unique bifunctor $G: \mathcal{E}^{\text{op}} \times \mathcal{D} \rightarrow C$ satisfying the following conditions:

- (1) $G(e, -) = G_e$ holds for each $e \in \mathcal{E}$.
- (2) The isomorphism

$$\varphi_{c,e,d}: \mathcal{D}(F(c, e), d) \cong C(c, G(e, d)),$$

which is natural in c, d and given by the adjunction $F(-, e) \dashv G(e, -)$, is also natural in e .

Proof. Assuming the existence of such a bifunctor G , let us consider properties that G must satisfy. By Condition (2), the isomorphism $\varphi_{c,e,d}: \mathcal{D}(F(c, e), d) \cong C(c, G(e, d))$ is natural in c, e , and d . For each e , since $G(e, -) = G_e$ is a right adjoint to $F(-, e)$, this adjunction has a unit $\eta^e := \{\varphi_{c,e,F(c,e)}(1_{F(c,e)})\}_{c \in C}$ and a counit $\varepsilon^e := \{\varphi_{G(e,d),e,d}^{-1}(1_{G(e,d)})\}_{d \in \mathcal{D}}$. Since $\varphi_{c,e,d}$ is natural in e and d , this naturality is expressed as

$$\begin{array}{|c|} \hline \text{Set} \\ \hline \mathcal{E}^{\text{op}} \times \mathcal{D} \\ \hline \langle e, d' \rangle \\ \hline C(c, G(-,=)) \\ \hline \langle f, g \rangle \\ \hline \langle e', d' \rangle \\ \hline \varphi_{c,e',d} \\ \hline \langle e', d \rangle \\ \hline \mathcal{D}(F(c,-),=) \\ \hline \end{array} = \begin{array}{|c|} \hline C(c, G(-,=)) \\ \hline \langle e, d' \rangle \\ \hline \varphi_{c,e,d'} \\ \hline \langle e, d' \rangle \\ \hline \mathcal{D}(F(c,-),=) \\ \hline \langle f, g \rangle \\ \hline \langle e', d \rangle \\ \hline \end{array}$$

for any $f \in \mathcal{E}^{\text{op}}(e', e) = \mathcal{E}(e, e')$ and $g \in \mathcal{D}(d, d')$. This is equivalent to

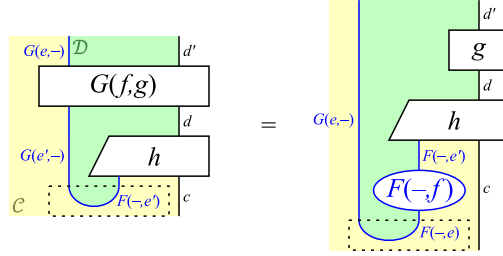

for each $h \in \mathcal{D}(F(c, e'), d)$, where the areas enclosed by the auxiliary lines are $\eta^{e'}$ and η^e (see Eq. (4.5)). Substituting $c = G(e', d)$ and

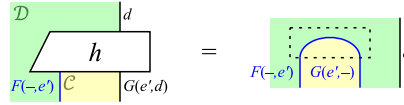

(where the area enclosed by the auxiliary line is $\varepsilon^{e'}$) into this equation and using Eq. (zigzag) yields

The diagram shows an equality between two configurations. On the left, a box labeled $G(f, g)$ is positioned between two horizontal lines representing objects d' (top) and d (bottom). The box is labeled $G(e, -)$ on the left and $G(e', -)$ on the right. On the right side, a box labeled g is shown between lines d' and d . On the left side, a box labeled $F(-, f)$ is shown between lines d' and d . On the right side, a box labeled $F(-, e)$ is shown between lines d' and d . On the left side, a box labeled $G(e', -)$ is shown between lines d' and d . On the right side, a box labeled $G(e, -)$ is shown between lines d' and d .

(4.28)

This equation uniquely determines $G(f, g)$, so the bifunctor G is unique. Conversely, if we define $G(f, g)$ as in Eq. (4.28), then $G(-, =)$ is a bifunctor satisfying the conditions. Indeed, it follows that $G(-, =)$ is a bifunctor since

The diagram shows an equality between two configurations. On the left, two boxes are stacked vertically. The top box is labeled $G(f, g')$ and the bottom box is labeled $G(f', g)$. The top box is labeled $G(e, -)$ on the left and $G(e', -)$ on the right. The bottom box is labeled $G(e', -)$ on the left and $G(e'', -)$ on the right. On the right side, a box labeled g' is shown between lines d'' and d' , and a box labeled g is shown between lines d' and d . On the left side, a box labeled $F(-, f)$ is shown between lines d'' and d' , and a box labeled $F(-, f')$ is shown between lines d' and d . On the right side, a box labeled $F(-, e)$ is shown between lines d'' and d' , and a box labeled $F(-, e')$ is shown between lines d' and d . On the left side, a box labeled $G(e', -)$ is shown between lines d'' and d' , and a box labeled $G(e'', -)$ is shown between lines d' and d . On the right side, a box labeled $G(e, -)$ is shown between lines d'' and d' , and a box labeled $G(e', -)$ is shown between lines d' and d . On the right side, a box labeled $G(e'', -)$ is shown between lines d'' and d . On the left side, a box labeled $G(e, -)$ is shown between lines d'' and d . On the right side, a box labeled $G(e', -)$ is shown between lines d'' and d . On the right side, a box labeled $G(e'', -)$ is shown between lines d'' and d . On the left side, a box labeled $G(e, -)$ is shown between lines d'' and d . On the right side, a box labeled $G(e', -)$ is shown between lines d'' and d . On the right side, a box labeled $G(e'', -)$ is shown between lines d'' and d .

(4.28)

holds for each $f \in \mathcal{E}(e, e')$, $f' \in \mathcal{E}(e', e'')$, $g \in \mathcal{D}(d, d')$, and $g' \in \mathcal{D}(d', d'')$, and also $G(1_e, 1_d) = 1_{G(e, d)}$ holds. \square

5 Limits and colimits

A (co)limit is a concept that can be used to handle various specific concepts such as products, equalizers, and pullbacks in a unified manner. Instead of dealing with these specific (co)limits, this section shows how to represent (co)limits and explains their basic properties using string diagrams.

5.1 Definition of limits and colimits

5.1.1 Cones

Definition 5.1 (cones): For an object $c \in C$ and a functor $D: \mathcal{J} \rightarrow C$, a natural transformation from $\Delta_{\mathcal{J}}c: \mathcal{J} \rightarrow C$ to D is called a **cone** from c to D , or simply a cone to D .

As shown in Example 2.21, the functor $\Delta_{\mathcal{J}}c$ is the same as $c \bullet !$, where $\Delta_{\mathcal{J}} = - \bullet !: C \rightarrow C^{\mathcal{J}}$ is a diagonal functor and $!$ is the only functor from \mathcal{J} to $\mathbf{1}$. $\Delta_{\mathcal{J}}c$ maps all objects in \mathcal{J} to c and all morphisms in \mathcal{J} to 1_c . The collection of all cones from c to D (i.e., $C^{\mathcal{J}}(\Delta_{\mathcal{J}}c, D)$) is denoted by $\text{Cone}(c, D)$. In this paper, when considering cones, it is often assumed that its domain \mathcal{J} is small (and sometimes this assumption is made implicitly).

A cone $\alpha := \{\alpha_j\}_{j \in \mathcal{J}} \in \text{Cone}(c, D)$ is represented by

$$\begin{array}{c} C^{\mathcal{J}} \\ \hline D \\ \hline \alpha \\ \hline \Delta_{\mathcal{J}}c \\ \hline c \end{array} \quad (2.22) \quad = \quad \begin{array}{c} D \\ \hline \mathcal{J} \\ \hline \alpha \\ \hline c \end{array} = \left\{ \begin{array}{c} D \\ \hline \alpha \\ \hline c \end{array} \right\}_{j \in \mathcal{J}} \quad (2.3) \quad = \quad \left\{ \begin{array}{c} D \\ \hline \alpha_j \\ \hline c \end{array} \right\}_{j \in \mathcal{J}} \quad (5.2)$$

where the functor $!$ is represented by a gray dotted wire. Note that we often represent a cone, which is a natural transformation, using a trapezoidal block. Naturality of α says that for any morphism $h \in \mathcal{J}(i, j)$ in \mathcal{J} ,

$$\begin{array}{c} D \\ \hline \mathcal{J} \\ \hline \alpha_j \\ \hline c \end{array} = \begin{array}{c} j \\ \hline h \\ \hline i \\ \hline \alpha_i \\ \hline c \end{array}$$

holds.

The comma category $\text{Cone}_D := \Delta_{\mathcal{J}} \downarrow D$ is often called the **category of cones to D** . Let us specify Cone_D (recall Subsubsection 3.2.5):

- Its each object is a pair, $\langle c, \alpha \rangle$, of $c \in C$ and $\alpha \in \text{Cone}(c, D)$.
- Its each morphism with domain $\langle c, \alpha \rangle$ and codomain $\langle c', \alpha' \rangle$ is a morphism $f \in C(c, c')$ in C such that

$$\begin{array}{c} C^{\mathcal{J}} \\ \hline D \\ \hline \alpha' \\ \hline c' \\ \hline f \\ \hline c \end{array} = \begin{array}{c} D \\ \hline \alpha \\ \hline c \end{array} \quad \text{equivalent} \quad \Leftrightarrow \quad \begin{array}{c} D \\ \hline \mathcal{J} \\ \hline \alpha' \\ \hline c' \\ \hline f \\ \hline c \end{array} = \begin{array}{c} D \\ \hline \alpha \\ \hline c \end{array} .$$

- The composite of its morphisms is the composite of morphisms in C , and its identity morphism is the identity morphism in C .

Roughly speaking, Cone_D is a category whose objects are cones to D . Since

$$\text{Cone}_D = \Delta_{\mathcal{J}} \downarrow D = \text{el}(C^{\mathcal{J}}(\Delta_{\mathcal{J}}-, D)) = \text{el}(\text{Cone}(-, D)),$$

Cone_D is equal to the category of elements of $\text{Cone}(-, D)$.

5.1.2 Limits

Definition 5.3 (limits): A universal morphism from the diagonal functor $\Delta_{\mathcal{J}}: \mathcal{C} \rightarrow \mathcal{C}^{\mathcal{J}}$ to a functor $D \in \mathcal{C}^{\mathcal{J}}$ is called a **limit** of D . Rewriting it using Eq. (3.74), $\langle d, \kappa \rangle$ is called a limit of D if, for any cone $\alpha \in \text{Cone}(c, D)$ (where c is arbitrary), there exists a unique morphism $\bar{\alpha} \in C(c, d)$ satisfying

$$\begin{array}{c} \mathcal{C}^{\mathcal{J}} \\ \hline \alpha \\ \hline \Delta_{\mathcal{J}} \mathcal{C} \quad c \end{array} = \begin{array}{c} D \\ \hline \exists! \bar{\alpha} \\ \hline c \end{array} \quad \text{equivalent} \quad \Leftrightarrow \quad \begin{array}{c} \mathcal{C} \quad D \quad \mathcal{J} \\ \hline \alpha \\ \hline c \end{array} = \begin{array}{c} D \\ \hline \exists! \bar{\alpha} \\ \hline c \end{array}, \quad (5.4)$$

where the blue circles denote κ .

In another expression, a limit of D is a terminal object in Cone_D .

Applying the evaluation functor ev_j to Eq. (5.4) yields each component α_j of a cone α , so Eq. (5.4) is equivalent to the existence of a unique $\bar{\alpha} \in C(c, d)$ satisfying

$$\begin{array}{c} D \quad \mathcal{J} \quad j \\ \hline \alpha_j \\ \hline c \end{array} = \begin{array}{c} D \\ \hline \exists! \bar{\alpha} \\ \hline c \end{array} \quad (\forall j \in \mathcal{J}),$$

where the black circle is the component κ_j of κ . Note that one can differentiate between the cone κ and its component κ_j in a string diagram by examining the wires connected to it. Equation (5.4) can be regarded as an equation for obtaining the corresponding α from $\bar{\alpha}$. Conversely, to obtain the corresponding $\bar{\alpha}$ from α , we can use a diagram introduced in Subsubsection 3.2.4 and express it as follows (where we show two expressions as in Eq. (5.4)):

$$\begin{array}{c} \mathcal{C} \quad d \\ \hline \bar{\alpha} \\ \hline c \end{array} = \begin{array}{c} D \\ \hline \alpha \\ \hline \Delta_{\mathcal{J}} \mathcal{C} \quad c \end{array} = \begin{array}{c} D \quad \mathcal{J} \\ \hline \alpha \\ \hline c \end{array}. \quad (5.5)$$

When $\langle d, \kappa \rangle$ is a limit of D , we call d its **limit object** and κ its **limit cone**. We often write d as $\lim D$. It should be understood that $\lim D$ represents one of the limit objects of D . In what follows, we sometimes represent κ as the right-hand side of

$$\begin{array}{c} \mathcal{C} \quad D \quad \mathcal{J} \\ \hline \lim D \end{array} = \begin{array}{c} D \\ \hline \lim \mathcal{C}^{\mathcal{J}} \quad D \end{array},$$

where the dotted wire labeled “lim” represents something like a map that maps a functor $D \in \mathcal{C}^{\mathcal{J}}$ to its limit object $\lim D \in \mathcal{C}$. However, it should be noted that if D does not have a limit, then $\lim D$ should be considered undefined; in this sense, this dotted wire is not strictly regarded as a map.

5.1.3 Cocones and colimits

The duals of cones and limits are called cocones and colimits, respectively. Specifically, for an object $c \in \mathcal{C}$ and a functor $D: \mathcal{J} \rightarrow \mathcal{C}$, a natural transformation from D to $\Delta_{\mathcal{J}}c$ is called a **cocone** from D to c or simply a cocone from D . We write $\text{Cocone}(D, c)$ for the collection of all cocones from D to c (i.e., $\mathcal{C}^{\mathcal{J}}(D, \Delta_{\mathcal{J}}c)$). The comma category $\text{Cocone}_D := D \downarrow \Delta_{\mathcal{J}}$ is called the **category of cocones** from D . Also, a universal morphism from D to $\Delta_{\mathcal{J}}$ (i.e., an initial object in Cocone_D) is called a **colimit** of D .

A cocone $\alpha := \{\alpha_j\}_{j \in \mathcal{J}} \in \text{Cocone}(D, c)$ is represented by the following diagram as the dual of Eq. (5.2):

$$\begin{array}{c} \Delta_{\mathcal{J}} \mathcal{C} \\ \alpha \\ \mathcal{C}^{\mathcal{J}} \quad D \end{array} \stackrel{(2.22)}{=} \begin{array}{c} c \\ \alpha \\ D \quad \mathcal{J} \end{array} = \left\{ \begin{array}{c} c \\ \alpha \\ D \quad j \end{array} \right\}_{j \in \mathcal{J}} \stackrel{(2.3)}{=} \left\{ \begin{array}{c} c \\ \alpha_j \\ D \quad j \end{array} \right\}_{j \in \mathcal{J}}.$$

When D has a colimit $\langle d, \kappa \rangle$, for any cocone $\alpha \in \text{Cocone}(D, c)$, there exists a unique morphism $\bar{\alpha} \in C(d, c)$ satisfying

$$\begin{array}{c} \Delta_{\mathcal{J}} \mathcal{C} \\ \alpha \\ \mathcal{C}^{\mathcal{J}} \quad D \end{array} = \begin{array}{c} \Delta_{\mathcal{J}} \\ \exists! \\ \bar{\alpha} \\ d \\ D \end{array} \stackrel{\text{equivalent}}{\iff} \begin{array}{c} c \\ \alpha \\ D \quad \mathcal{J} \end{array} = \begin{array}{c} \exists! \\ \bar{\alpha} \\ d \\ D \end{array}, \quad (5.6)$$

where the blue circles are κ . Since each component α_j is obtained by applying the evaluation functor ev_j to α , Eq. (5.6) is equivalent to the existence of a unique $\bar{\alpha} \in C(d, c)$ satisfying

$$\begin{array}{c} \mathcal{C} \quad c \\ \alpha_j \\ D \quad \mathcal{J} \quad j \end{array} = \begin{array}{c} c \\ \bar{\alpha} \\ d \\ D \quad j \end{array} \quad (\forall j \in \mathcal{J}),$$

where the black circle denotes κ_j . We also have a similar equation to Eq. (5.5). When $\langle d, \kappa \rangle$ is a colimit of D , we call d its **colimit object** and κ its **colimit cocone**. d is often written as $\text{colim } D$.

5.1.4 Properties immediately derived from definitions

Since initial and terminal objects are essentially unique, (co)limits are essentially unique if they exist. Let us specifically state this fact for limits. When $\langle d, \kappa \rangle$ is a limit of D , for any limit $\langle d', \kappa' \rangle$ of D , there exists a unique isomorphism $\psi \in C(d', d)$ such that $\kappa' = \kappa \circ \Delta_{\mathcal{J}} \psi$, i.e.,

$$\begin{array}{c} \mathcal{C}^{\mathcal{J}} \quad D \\ \kappa' \\ \Delta_{\mathcal{J}} \quad \mathcal{C} \quad d' \end{array} = \begin{array}{c} \Delta_{\mathcal{J}} \\ \psi \\ d \\ D \quad d' \end{array} \stackrel{\text{equivalent}}{\iff} \begin{array}{c} \mathcal{C} \quad D \quad \mathcal{J} \\ \kappa' \\ d' \end{array} = \begin{array}{c} D \\ \psi \\ d \\ D \quad d' \end{array}, \quad (5.7)$$

where the blue circles represent κ and the diamond block represents ψ (see Eq. (3.54)). Conversely, any $\langle d', \kappa' \rangle$ represented in the form of Eq. (5.7) is a limit of D . The same applies to colimits.

From the discussion on representability in Subsubsection 3.2.3, we obtain the following lemma.

Lemma 5.8: For any small category \mathcal{J} , a functor $D: \mathcal{J} \rightarrow \mathcal{C}$ has a limit if and only if the presheaf $\text{Cone}(-, D) = \mathcal{C}^{\mathcal{J}}(\Delta_{\mathcal{J}}-, D): \mathcal{C}^{\text{op}} \rightarrow \mathbf{Set}$ is representable, i.e., there exists $d \in \mathcal{C}$ such that

$$\mathcal{C}(-, d) \cong \text{Cone}(-, D) \stackrel{\text{diagram}}{\cong} \begin{array}{c} \mathcal{C} \quad d \\ \text{---} \\ \text{---} \end{array} \cong \begin{array}{c} D \quad \mathcal{J} \\ \text{---} \\ \text{---} \end{array}. \quad (5.9)$$

In this case, $d \cong \lim D$ holds.

Dually, D has a colimit if and only if the set-valued functor $\text{Cocone}(D, -) :=$

$C^{\mathcal{J}}(D, \Delta_{\mathcal{J}}-) : C \rightarrow \mathbf{Set}$ is representable, i.e., there exists $d \in C$ such that

$$C(d, -) \cong \text{Cocone}(D, -) \xrightarrow{\text{diagram}} \begin{array}{|c|} \hline - \\ \hline c \quad d \\ \hline \end{array} \cong \begin{array}{|c|} \hline - \\ \hline D \quad J \\ \hline \end{array}. \quad (5.10)$$

In this case, $d \cong \text{colim } D$ holds.

Proof. D has a limit if and only if the category of cones $\text{Cone}_D = \Delta_{\mathcal{J}} \downarrow D$ has a terminal object. From Eq. (3.75), this is equivalent to $\text{Cone}(-, D)$ being representable. In particular, d is a limit object of D if and only if Cone_D has a terminal object of the form $\langle d, \kappa \rangle$, which is equivalent to $\text{Cone}(-, D) \cong d^{\square} = C(-, d)$. \square

Lemma 5.11: For any functor $D : \mathcal{J} \rightarrow C$, the following equation holds^{*a}:

$$\text{Cone}(c, D) = \text{Cone}(\{*\}, C(c, D-)), \quad \text{Cocone}(D, c) = \text{Cocone}(C(D-, c), \{*\}) \quad (5.12)$$

^{*a} $\text{Cocone}(C(D-, c), \{*\})$ is the collection of all cocones from $C(D-, c) : \mathcal{J} \rightarrow \mathbf{Set}^{\text{op}}$ to $\{*\} \in \mathbf{Set}^{\text{op}}$.

Proof. We show $\text{Cone}(c, D) = \text{Cone}(\{*\}, C(c, D-))$; the other formula is dual. We have for any $\alpha \in \text{Cone}(c, D)$,

$$\begin{aligned} \begin{array}{|c|} \hline c \quad D \quad J \\ \hline \alpha \\ \hline c \quad \end{array} &= \left\{ \begin{array}{|c|} \hline D \quad j \\ \hline c \quad \end{array} \alpha_j \right\}_{j \in \mathcal{J}} \\ &\stackrel{(3.20)}{=} \left\{ \begin{array}{|c|} \hline \square^c \quad D \quad j \\ \hline \text{Set} \quad \alpha_j \end{array} \right\}_{j \in \mathcal{J}} = \begin{array}{|c|} \hline \square^c \quad D \\ \hline \alpha \quad \end{array}. \end{aligned}$$

Note that it follows from Eq. (3.20) that the last equality holds, i.e., α is a cone from $\{*\}$ to $\square^c \bullet D = C(c, D-)$. Therefore, we have $\text{Cone}(c, D) \subseteq \text{Cone}(\{*\}, C(c, D-))$. Also, by tracing this equation backwards we obtain $\text{Cone}(c, D) \supseteq \text{Cone}(\{*\}, C(c, D-))$. \square

Note that, as a corresponding equation to Eq. (3.20), any $\alpha \in \text{Cone}(c, D)$ can be represented as

$$\begin{array}{|c|} \hline c \quad D \quad J \\ \hline \alpha \\ \hline c \quad \end{array} = \begin{array}{|c|} \hline D \\ \hline \square^c \quad \alpha \\ \hline \text{Set} \quad c \quad \end{array} = \begin{array}{|c|} \hline \square^c \quad D \\ \hline \alpha \quad \end{array}. \quad (5.13)$$

5.2 Basic properties of limits and colimits

5.2.1 Limits as right adjoints to diagonal functors

From the properties of limits and adjoints, the following proposition holds.

Proposition 5.14: For a small category \mathcal{J} and a category C , the following are equivalent:

- (1) Any functor from \mathcal{J} to C has a limit.
- (2) The diagonal functor $\Delta_{\mathcal{J}} : C \rightarrow C^{\mathcal{J}}$ has a right adjoint.

Furthermore, if they hold, then there exists a functor $\lim : \mathcal{C}^{\mathcal{J}} \rightarrow \mathcal{C}$ that maps each functor $D : \mathcal{J} \rightarrow \mathcal{C}$ to one of its limit objects, and \lim is a right adjoint to the diagonal functor $\Delta_{\mathcal{J}}$. Moreover, for the counit ε of the adjunction $\Delta_{\mathcal{J}} \dashv \lim$, ε_D is a limit cone of D .

Proof. (1) \Rightarrow (2): Since each $D : \mathcal{J} \rightarrow \mathcal{C}$ has a limit, i.e., a universal morphism from $\Delta_{\mathcal{J}}$ to each D exists, from the dual of Theorem 4.13, $\Delta_{\mathcal{J}}$ has a right adjoint.

(2) \Rightarrow (1): Let \lim be a right adjoint to $\Delta_{\mathcal{J}}$. Also, arbitrarily choose $D : \mathcal{J} \rightarrow \mathcal{C}$. Then, from Lemma 4.4, $\langle \lim D, \varepsilon_D \rangle$ is a universal morphism from $\Delta_{\mathcal{J}}$ to D , i.e., a limit of D . \square

Dually, any functor from \mathcal{J} to \mathcal{C} has a colimit if and only if $\Delta_{\mathcal{J}} : \mathcal{C} \rightarrow \mathcal{C}^{\mathcal{J}}$ has a left adjoint.

Let us specify such a functor \lim . For each $D : \mathcal{J} \rightarrow \mathcal{C}$, choose one of its limits and denote it by $\langle \lim D, \varepsilon_D \rangle$. Also, for each natural transformation $\tau \in \mathcal{C}^{\mathcal{J}}(D, D')$, let $\lim \tau \in \mathcal{C}(\lim D, \lim D')$ satisfying

$$(5.15)$$

where the blue circles are ε_D and $\varepsilon_{D'}$. Then, for each $\tau \in \mathcal{C}^{\mathcal{J}}(D, D')$ and $\tau' \in \mathcal{C}^{\mathcal{J}}(D', D'')$, $\lim \tau' \tau = (\lim \tau')(\lim \tau)$ holds from

and the dual of Eq. (3.68). Also, \lim maps the identity morphism 1_D to the identity morphism $1_{\lim D}$, and thus \lim is a functor. When a functor \lim exists, using the expression of counits introduced in Eq. (4.10), the limit cone ε_D can be represented by

$$(5.16)$$

The counit ε of this adjunction is the collection $\{\varepsilon_D\}_{D \in \mathcal{C}^{\mathcal{J}}}$. Equations (5.4) and (5.5) can be rewritten as follows:

A category \mathcal{C} is called **complete** if any functor $D : \mathcal{J} \rightarrow \mathcal{C}$ with any small category \mathcal{J} has a limit and **cocomplete** if any functor $D : \mathcal{J} \rightarrow \mathcal{C}$ with any small category \mathcal{J} has a colimit.

5.2.2 Preservation of limits and colimits

Let us consider two functors $G : \mathcal{D} \rightarrow \mathcal{C}$ and $D : \mathcal{J} \rightarrow \mathcal{D}$ with a small category \mathcal{J} . We say that G **preserves** the limits of D if when D has a limit $\langle d, \kappa \rangle$, $\langle Gd, G \bullet \kappa \rangle$ is a limit of $G \bullet D$, i.e.,

holds. Also, we call G preserving any limit (or continuous) if it preserves the limits of any functor $D: \mathcal{J} \rightarrow \mathcal{D}$ with any small category \mathcal{J} . The preservation of colimits is defined as their dual.

G preserves the limits of D if and only if

$$\begin{aligned}
 & \begin{array}{c} \mathcal{C} \quad D \quad \mathcal{J} \\ \alpha \\ c \end{array} = \exists! \begin{array}{c} D \\ d \\ \bar{\alpha} \\ c \end{array} \quad (\forall c \in \mathcal{C}, \alpha \in \text{Cone}(c, D)) \\
 \Rightarrow & \begin{array}{c} \mathcal{C} \quad G \quad D \quad \mathcal{J} \\ \beta \\ c \end{array} = \exists! \begin{array}{c} G \quad D \\ d \\ \bar{\beta} \\ c \end{array} \quad (\forall c \in \mathcal{C}, \beta \in \text{Cone}(c, G \bullet D))
 \end{aligned}$$

holds, where the blue circle is a cone, denoted by κ , to D . In this case, $\langle d, \kappa \rangle$ is a limit of D . Intuitively, it can be said that the equation will still preserve its structure even if we insert the wire G on the left side of the wire D . Also, the relationship between limit cones of D and $G \bullet D$ is represented by

$$\begin{array}{c} \mathcal{C} \quad D \quad \mathcal{J} \\ \lim: G \quad D \\ c \quad D \end{array} = \begin{array}{c} G \quad D \\ \lim: G \quad D \\ \lim: G \quad D \end{array} = \begin{array}{c} G \quad D \\ \lim: G \quad D \\ \lim: G \end{array}, \quad (5.17)$$

where the blue circle represents κ and the blue ellipse represents any limit cone of $G \bullet D$. The diamond-shaped block represents an isomorphism, which means $G \bullet \lim D \cong \lim(G \bullet D)$. Equation (5.17) intuitively means that connecting the wire G to the blue circle can be identified with the blue ellipse.

Theorem 5.18 (Right adjoints preserve limits (RAPL)): Any right adjoint preserves any limit. Dually, any left adjoint preserves any colimit.

Proof. Assume that there exists a limit, denoted by $\langle d, \kappa \rangle$, of a functor $D: \mathcal{J} \rightarrow \mathcal{D}$, where \mathcal{J} is a small category. Also, arbitrarily choose $F \dashv G: \mathcal{C} \rightarrow \mathcal{D}$. We have for any cone $\alpha \in \text{Cone}(c, G \bullet D)$ (where c is arbitrary),

$$\begin{array}{c} \mathcal{C} \quad G \quad D \quad \mathcal{J} \\ \alpha \\ c \end{array} \stackrel{(4.6)}{=} \begin{array}{c} G \quad D \\ F \\ \bar{\alpha} \\ c \end{array} \stackrel{(5.4)}{=} \exists! \begin{array}{c} G \quad D \\ d \\ \bar{\beta} \\ c \end{array} \stackrel{(4.6)}{=} \begin{array}{c} G \quad D \\ d \\ \beta \\ c \end{array},$$

where the blue circle is κ . In the first equality, we set the transpose of α to $\bar{\alpha}$ (note that $F \bullet - \dashv G \bullet -$ holds). The second equality follows from applying Eq. (5.4) to the cone $\bar{\alpha}$ (we set $\bar{\alpha}$ on the right-hand side of Eq. (5.4) to $\bar{\beta}$). In the last equality, we set the transpose of $\bar{\beta}$ to β . Since β is uniquely determined from α , $\langle Gd, G \bullet \kappa \rangle$ is a limit of $G \bullet D$. Therefore, G preserves any limit. \square

Theorem 5.19: For each object $c \in \mathcal{C}$, $\square^c: \mathcal{C} \rightarrow \mathbf{Set}$ preserves any limit.

Proof. Assume that there exists a limit, denoted by $\langle d, \kappa \rangle$, of a functor $D: \mathcal{J} \rightarrow \mathcal{D}$, where \mathcal{J} is a small category. Then, it suffices to show that $\langle \square^c \bullet d, \square^c \bullet \kappa \rangle$ is a limit of $\square^c \bullet D = C(c, D-)$. Arbitrarily choose a set X and a cone $\alpha \in \text{Cone}(X, \square^c \bullet D)$, and let $\alpha(x) := \{\alpha_j(x)\}_{j \in \mathcal{J}}$ for each

$x \in X$. Also, let Γ be the map that sends a collection of the form $\{\{f_{x,y}\}_{x \in X}\}_{y \in Y}$ to the collection $\{\{f_{x,y}\}_{y \in Y}\}_{x \in X}$ (by swapping the order of $\{-\}_{x \in X}$ and $\{-\}_{y \in Y}$). Γ is obviously invertible and satisfies

$$\alpha = \{\{\alpha_j(x)\}_{x \in X}\}_{j \in \mathcal{J}} \xrightarrow{\Gamma} \{\alpha(x)\}_{x \in X} = \{\{\alpha_j(x)\}_{j \in \mathcal{J}}\}_{x \in X}$$

Note that since, for $F := \square^c \bullet D: \mathcal{J} \rightarrow \mathbf{Set}$,

$$\begin{aligned} \alpha \in \text{Cone}(X, F) &\Leftrightarrow \alpha_{\text{cod } h} = Fh \circ \alpha_{\text{dom } h} \quad (\forall h \in \text{mor } \mathcal{J}) \\ &\Leftrightarrow \alpha_{\text{cod } h}(x) = Fh \circ \alpha_{\text{dom } h}(x) \quad (\forall h \in \text{mor } \mathcal{J}, x \in X) \end{aligned}$$

holds, each $\alpha(x)$ is a cone from $\{*\}$ to F . It follows that $\bar{\alpha} := \{\overline{\alpha(x)}\}_{x \in X}$ satisfying

$$\begin{aligned} &\begin{array}{c} \square^c \quad C \quad D \\ \text{Set} \quad | \quad X \end{array} \xrightarrow{\Gamma} \left\{ \begin{array}{c} \square^c \quad D \\ \alpha(x) \end{array} \right\}_{x \in X} \stackrel{(5.13)}{=} \left\{ \begin{array}{c} D \\ \alpha(x) \\ c \end{array} \right\}_{x \in X} \\ &\stackrel{(5.4)}{=} \left\{ \begin{array}{c} D \\ \exists! \alpha(x) \\ c \end{array} \right\}_{x \in X} \stackrel{(5.13)}{=} \left\{ \begin{array}{c} D \\ \alpha(x) \\ c \end{array} \right\}_{x \in X} \xrightarrow{\Gamma^{-1}} \begin{array}{c} D \\ \bar{\alpha} \\ X \end{array} \end{aligned}$$

(where the blue circles are κ) is uniquely determined. Therefore, $\langle \square^c \bullet d, \square^c \bullet \kappa \rangle$ is a limit of $\square^c \bullet D$. □

Corollary 5.20: $c^\square: C^{\text{op}} \rightarrow \mathbf{Set}$ preserves any limit. Alternatively, $c^\square: C \rightarrow \mathbf{Set}^{\text{op}}$ preserves any colimit.

Proof. Since $c^\square = C(-, c) = C^{\text{op}}(c, -)$, it is clear by substituting C^{op} for C in Theorem 5.19. □

Proposition 5.21: Consider a small category \mathcal{J} , categories C and D , and a functor $G: D \rightarrow C$. If any functor from \mathcal{J} to C and any functor from \mathcal{J} to D have limits, and G preserves any limit, then the isomorphism $G \bullet \lim D \cong \lim(G \bullet D)$ is natural in $D: \mathcal{J} \rightarrow D$.

Proof. By Proposition 5.14, a right adjoint, \lim , to $\Delta_{\mathcal{J}}: C \rightarrow C^{\mathcal{J}}$ and a right adjoint, \lim , to $\Delta_{\mathcal{J}}: D \rightarrow D^{\mathcal{J}}$ exist. Also, since G preserves any limit, we have for each $D: \mathcal{J} \rightarrow D$ (see Eqs. (5.16) and (5.17)),

$$\begin{array}{c} C^{\mathcal{J}} \quad D^{\mathcal{J}} \\ G \quad \Delta_{\mathcal{J}} \quad \lim \end{array} D \quad = \quad \begin{array}{c} G \quad D \\ \lim \quad G \quad \lim \end{array} D, \quad (5.22)$$

where the diamond block represents the isomorphism from $G \bullet \lim D$ to $\lim(G \bullet D)$, which we denote as φ_D . Note that the functor $G \bullet \Delta_{\mathcal{J}}: D \rightarrow C^{\mathcal{J}}$ and the functor $\Delta_{\mathcal{J}} \bullet G: D \rightarrow C^{\mathcal{J}}$ are equal since both have the action on morphisms $\text{mor } D \ni f \mapsto \{Gf\}_{j \in \mathcal{J}} \in \text{mor } C^{\mathcal{J}}$. If $\varphi := \{\varphi_D\}_{D \in D^{\mathcal{J}}}$ is a natural transformation, then φ is a natural isomorphism from $G \bullet \lim$ to $\lim \bullet (G \bullet -)$. Thus,

it remains to show naturality of φ . We have for any $\tau: D \Rightarrow D'$ (where $D, D': \mathcal{J} \rightarrow \mathcal{D}$ are also arbitrary),

Therefore, due to the universality of $\lim(G \bullet D')$, we have

and thus φ is a natural transformation. □

Proposition 5.23: If a functor $D: \mathcal{J} \rightarrow \mathcal{C}$ with a small category \mathcal{J} has a limit, then there exists an isomorphism

$$\text{Cone}(c, D) \cong C(c, \lim D) \cong \lim C(c, D-) \quad (5.24)$$

that is natural in $c \in \mathcal{C}$. Dually, if D has a colimit, then there exists an isomorphism

$$\text{Cocone}(D, c) \cong C(\text{colim } D, c) \cong \lim C(D-, c)$$

that is natural in $c \in \mathcal{C}$.

Proof. Since $\text{Cone}(-, D) \cong C(-, \lim D)$ holds from Eq. (5.9), the left isomorphism in Eq. (5.24) holds and is natural in $c \in \mathcal{C}$. Also, since from Theorem 5.19 $C(c, \lim D)$ is a limit object of $\square^c \bullet D = C(c, D-)$, the right isomorphism in Eq. (5.24) holds. We show that the right isomorphism is natural in $c \in \mathcal{C}$.

The isomorphism $\lim C(c, D-) \cong C(c, \lim D)$ is depicted by

where the blue ellipse and the blue circle represent limit cones of $\square^c \bullet D$ and D , respectively. The area enclosed by the auxiliary line represents the isomorphism, which we denote as ψ_c , from $\lim C(c, D-)$ to $C(c, \lim D)$. Also, the solid wire \lim represents the functor $\lim: \mathbf{Set}^{\mathcal{J}} \rightarrow \mathbf{Set}$, which exists since \mathbf{Set} is complete. With no loss of generality we can assume that this functor \lim

is defined for each $f \in C(a, b)$ to satisfy

$$(5.26)$$

(see Eq. (5.15)). The isomorphism $\psi_c : \lim C(c, D-) \cong C(c, \lim D)$ is natural in $c \in C^{\ddagger 16}$ if and only if

$$\square^f_{\lim D} \circ \psi_b = \psi_a \circ \lim(\square^f \bullet D) \quad \text{diagram} \quad (5.27)$$

holds for each $f \in C(a, b)$ (where $a, b \in C$ are arbitrary). Therefore, it suffices to show Eq. (5.27). From Eqs. (5.25) and (5.26), we have

$$(5.26) \quad (5.25)$$

Let the blue circle be denoted as κ ; then, since $\square^a \bullet \kappa$ is a limit cone of $\square^a \bullet D$, the two natural transformations enclosed by the auxiliary lines are equal due to the universality of $\square^a \bullet \kappa$. Therefore, Eq. (5.27) holds. \square

5.2.3 Limits and colimits of functors to functor categories

The following proposition asserts that a limit of a functor from a small category \mathcal{J} to a functor category $C^{\mathcal{I}}$ can be obtained from limits of the functors $\text{ev}_i \bullet D$ ($i \in \mathcal{I}$).

Proposition 5.28: Consider a functor $D : \mathcal{J} \rightarrow C^{\mathcal{I}}$ with a small category \mathcal{J} . Assume that, for each $i \in \mathcal{I}$, $D_i := \text{ev}_i \bullet D = D(-)(i)$ has a limit $\langle l_i, \kappa_i \rangle$. Let us express κ_i as $\{\kappa_{i,j}\}_{j \in \mathcal{J}}$ and let $\kappa := \{\{\kappa_{i,j}\}_{i \in \mathcal{I}}\}_{j \in \mathcal{J}}$. Then, there exists a unique functor $L \in C^{\mathcal{I}}$ such that $L(i) = l_i$ holds and that κ is a cone from L to D . Also, $\langle L, \kappa \rangle$ is a limit of D . Dually, the same holds for colimits.

Proof. Let P be the canonical functor from $(C^{\mathcal{I}})^{\mathcal{J}}$ to $(C^{\mathcal{J}})^{\mathcal{I} \ddagger 17}$, and let $D^* := P \bullet D$; then, we have $D^*(i) = D_i$. Note that the two functors $D : \mathcal{J} \rightarrow C^{\mathcal{I}}$ and $D^* : \mathcal{I} \rightarrow C^{\mathcal{J}}$ are related as if the order

$\ddagger 16$ This means that $\{\psi_c\}_{c \in C}$ is a natural isomorphism from the presheaf $\lim_{j \in \mathcal{J}} C(-, D_j) \in \hat{C}$ to the presheaf $C(-, \lim D) \in \hat{C}$.

$\ddagger 17$ P can be defined as the map of each morphism $\{\{\alpha_{i,j}\}_{j \in \mathcal{J}}\}$ in $(C^{\mathcal{I}})^{\mathcal{J}}$ to $\{\{\alpha_{i,j}\}_{j \in \mathcal{J}}\}_{i \in \mathcal{I}}$. The canonical functor from $C^{\mathcal{I} \times \mathcal{J}}$ to $(C^{\mathcal{I}})^{\mathcal{J}}$ can be defined in a similar manner.

of \mathcal{I} and \mathcal{J} were swapped. We prove this proposition by replacing the discussion about D with the discussion about D^* .

Let $\kappa^* := \{\kappa_i\}_{i \in \mathcal{I}}$; then, $\kappa = \{\{\kappa_{i,j}\}_{j \in \mathcal{J}}\}_{i \in \mathcal{I}}$ is a natural transformation from $\Delta_{\mathcal{J}}L: \mathcal{J} \rightarrow \mathcal{C}^{\mathcal{I}}$ to D (i.e., a cone from L to D) if and only if $\kappa^* = \{\{\kappa_{i,j}\}_{j \in \mathcal{J}}\}_{i \in \mathcal{I}}$ is a natural transformation from $\Delta_{\mathcal{J}} \bullet L: \mathcal{I} \rightarrow \mathcal{C}^{\mathcal{J}}$ to D^* . Indeed, if κ^* is a natural transformation, then

$$P \bullet \kappa = \kappa^* \quad \xrightarrow{\text{diagram}} \quad \begin{array}{c} (\mathcal{C}^{\mathcal{J}})^{\mathcal{I}} \quad (\mathcal{C}^{\mathcal{I}})^{\mathcal{J}} \quad D \\ \downarrow P \quad \downarrow \Delta_{\mathcal{J}} \quad \downarrow \kappa \\ \mathcal{C}^{\mathcal{I}} \quad L \end{array} = \begin{array}{c} D^* \\ \downarrow \Delta_{\mathcal{J}} \quad \downarrow \kappa^* \\ \mathcal{C}^{\mathcal{J}} \quad L \end{array}$$

holds, and thus κ is a natural transformation. The converse also holds since $P^{-1} \bullet \kappa^* = \kappa$.

It follows from Lemma 3.78 that $\langle L, \kappa \rangle$ is a universal morphism from $\Delta_{\mathcal{J}}$ to D if and only if $\langle L, \kappa^* \rangle$ is a universal morphism from $\Delta_{\mathcal{J}} \bullet -$ to D^* . Thus, it is sufficient to show that a functor L satisfying the conditions is uniquely determined and that $\langle L, \kappa^* \rangle$ is a universal morphism from $\Delta_{\mathcal{J}} \bullet -$ to D^* . This can be shown by substituting $D^*: \mathcal{I} \rightarrow \mathcal{C}^{\mathcal{J}}$ and $\Delta_{\mathcal{J}}: \mathcal{C} \rightarrow \mathcal{C}^{\mathcal{J}}$ for H and G , respectively, in the dual of Lemma 3.79. Indeed, if we let L be F of this lemma, then it follows that there exists a unique functor $L \in \mathcal{C}^{\mathcal{I}}$ such that $L(i) = l_i$ holds and that κ^* is a natural transformation from $\Delta_{\mathcal{J}} \bullet L$ to D^* , i.e.,

$$\begin{array}{c} (\mathcal{C}^{\mathcal{J}})^{\mathcal{I}} \quad D^* \\ \downarrow \Delta_{\mathcal{J}} \quad \downarrow \kappa^* \\ \mathcal{C}^{\mathcal{I}} \quad L \end{array} = \left\{ \begin{array}{c} \mathcal{C}^{\mathcal{J}} \quad \text{ev}_i \bullet D \\ \downarrow \Delta_{\mathcal{J}} \quad \downarrow \kappa_i \\ \mathcal{C} \quad L_i \end{array} \right\}_{i \in \mathcal{I}}$$

Also, this lemma says that $\langle L, \kappa^* \rangle$ is a universal morphism from $\Delta_{\mathcal{J}} \bullet -$ to D^* . □

Corollary 5.29: If any functor from a small category \mathcal{J} to a category \mathcal{C} has a limit, then any functor from \mathcal{J} to $\mathcal{C}^{\mathcal{I}}$ also has a limit. The same holds for colimits.

Proof. From Proposition 5.28, for any functor $D: \mathcal{J} \rightarrow \mathcal{C}^{\mathcal{I}}$, since $D_i := \text{ev}_i \bullet D$ has a limit, so does D . □

5.2.4 Interactions between limits

Let us consider a bifunctor $D: \mathcal{I} \times \mathcal{J} \rightarrow \mathcal{C}$, where \mathcal{I} and \mathcal{J} are small categories. Let P be the canonical functor from $\mathcal{C}^{\mathcal{I} \times \mathcal{J}}$ to $(\mathcal{C}^{\mathcal{I}})^{\mathcal{J}}$. Also, let one of the limit objects of $P \bullet D: \mathcal{J} \rightarrow \mathcal{C}^{\mathcal{I}}$ be written as $\lim_{j \in \mathcal{J}} D(-, j) \in \mathcal{C}^{\mathcal{I}}$. Note that this limit object is a functor from \mathcal{I} to \mathcal{C} and does not depend on j ; it may be helpful to think of j as representing something like an internal variable. Similarly, by swapping the roles of \mathcal{I} and \mathcal{J} , we can define $\lim_{i \in \mathcal{I}} D(i, -) \in \mathcal{C}^{\mathcal{J}}$. Using the same notation, let $\lim_{j \in \mathcal{J}} E_j$ denote a limit object of a functor $E: \mathcal{J} \rightarrow \mathcal{C}$ (i.e., $\lim_{j \in \mathcal{J}} E_j \cong \lim E$ holds). Then, a limit object of $D(i, -)$ can be expressed as $\lim_{j \in \mathcal{J}} D(i, j) \in \mathcal{C}$ and a limit object of D can be expressed as $\lim_{(i,j) \in \mathcal{I} \times \mathcal{J}} D(i, j)$. Applying Proposition 5.28 to the functor $P \bullet D$, if there exists a limit object $\lim_{j \in \mathcal{J}} D(i, j)$ for each $i \in \mathcal{I}$, then there exists a functor L satisfying $L(i) = \lim_{j \in \mathcal{J}} D(i, j)$ and $L \cong \lim_{j \in \mathcal{J}} D(-, j)$. Furthermore, when $\lim_{j \in \mathcal{J}} D(-, j)$ has a limit, we can write its limit object as $\lim_{i \in \mathcal{I}} \lim_{j \in \mathcal{J}} D(i, j)$.

The following proposition holds.

Proposition 5.30: Let us consider a bifunctor $D: \mathcal{I} \times \mathcal{J} \rightarrow \mathcal{C}$, where \mathcal{I} and \mathcal{J} are small categories. Assume that for each $i \in \mathcal{I}$, $D(i, -)$ has a limit, in which case we can define a functor $\lim_{j \in \mathcal{J}} D(-, j)$. If either $\lim_{j \in \mathcal{J}} D(-, j)$ or D has a limit, then the other also has a limit and we have

$$\lim_{i \in \mathcal{I}} \lim_{j \in \mathcal{J}} D(i, j) \cong \lim_{(i,j) \in \mathcal{I} \times \mathcal{J}} D(i, j). \quad (5.31)$$

Proof. Let P be the canonical functor from $\mathcal{C}^{\mathcal{I} \times \mathcal{J}}$ to $(\mathcal{C}^{\mathcal{I}})^{\mathcal{J}}$. From Proposition 5.28, $P \bullet D$ has a limit, which we denote as $\langle \lim_{j \in \mathcal{J}} D(-, j), \kappa \rangle$. From Lemma 3.78, we have

$$\begin{aligned}
& \langle \lim_{(i,j) \in \mathcal{I} \times \mathcal{J}} D(i, j), v' \rangle \text{ is a limit of } D \text{ (i.e., a universal morphism from } \Delta_{\mathcal{I} \times \mathcal{J}} \text{ to } D) \\
& \Leftrightarrow \langle \lim_{(i,j) \in \mathcal{I} \times \mathcal{J}} D(i, j), P \bullet v' \rangle \text{ is a universal morphism from } P \bullet \Delta_{\mathcal{I} \times \mathcal{J}} \text{ to } P \bullet D \\
& \Leftrightarrow \langle \lim_{(i,j) \in \mathcal{I} \times \mathcal{J}} D(i, j), P \bullet v' \rangle \text{ is a universal morphism from } \Delta_{\mathcal{J}} \bullet \Delta_{\mathcal{I}} \text{ to } P \bullet D,
\end{aligned} \tag{5.32}$$

where the last line follows from $P \bullet \Delta_{\mathcal{I} \times \mathcal{J}} = \Delta_{\mathcal{J}} \bullet \Delta_{\mathcal{I}}$. Note that $P \bullet v'$ is depicted by

The proof can be easily obtained by applying the dual of Lemma 3.76.

First, consider the case where $\lim_{j \in \mathcal{J}} D(-, j)$ has the limit $\langle \lim_{i \in \mathcal{I}} \lim_{j \in \mathcal{J}} D(i, j), \kappa' \rangle$. Let

where the blue circle represents κ ; then, from the dual of Lemma 3.76, $\langle \lim_{i \in \mathcal{I}} \lim_{j \in \mathcal{J}} D(i, j), v \rangle$ is a universal morphism from $\Delta_{\mathcal{J}} \bullet \Delta_{\mathcal{I}}$ to $P \bullet D$. Therefore, from Eq. (5.32), $\langle \lim_{i \in \mathcal{I}} \lim_{j \in \mathcal{J}} D(i, j), P^{-1} \bullet v \rangle$ is a limit of D , so Eq. (5.31) holds.

Next, consider the case where D has a limit. From Eq. (5.32), there exists a universal morphism $\langle \lim_{(i,j) \in \mathcal{I} \times \mathcal{J}} D(i, j), v \rangle$ from $\Delta_{\mathcal{J}} \bullet \Delta_{\mathcal{I}}$ to $P \bullet D$. Thus, from the dual of Lemma 3.76 (refer to Eq. (5.33)), $\lim_{j \in \mathcal{J}} D(-, j)$ has a limit of the form $\langle \lim_{(i,j) \in \mathcal{I} \times \mathcal{J}} D(i, j), \kappa' \rangle$. Therefore, Eq. (5.31) holds. \square

This proposition leads directly to the following corollary.

Corollary 5.34: Consider any category \mathcal{C} and small categories \mathcal{I} and \mathcal{J} . Assume that any functor from \mathcal{I} to \mathcal{C} and functor from \mathcal{J} to \mathcal{C} have limits. Then, a functor $D: \mathcal{I} \times \mathcal{J} \rightarrow \mathcal{C}$ has a limit and satisfies

$$\lim_{i \in \mathcal{I}} \lim_{j \in \mathcal{J}} D(i, j) \cong \lim_{(i,j) \in \mathcal{I} \times \mathcal{J}} D(i, j) \cong \lim_{j \in \mathcal{J}} \lim_{i \in \mathcal{I}} D(i, j).$$

Proof. The first isomorphism is obvious from Proposition 5.30. Swapping \mathcal{I} and \mathcal{J} yields the second isomorphism. \square

6 Kan extensions

Kan extensions are concepts that can unify the treatment of adjoints and limits from different perspectives. It has been pointed out that ‘‘The notion of Kan extensions subsumes all the other fundamental concepts of category theory’’ [7]. String diagrams are also useful when investigating the properties of Kan extensions. After discussing general Kan extensions, we explain the properties of pointwise Kan extensions, which are often recognized as important Kan extensions.

6.1 Definition of Kan extensions

Definition 6.1 (Kan extensions): Consider two functors $K: \mathcal{C} \rightarrow \mathcal{D}$ and $F: \mathcal{C} \rightarrow \mathcal{E}$. A universal morphism $\langle L, \eta \rangle$ from F to $- \bullet K: \mathcal{E}^{\mathcal{D}} \rightarrow \mathcal{E}^{\mathcal{C}}$ is called a **left Kan extension** of F along K . η is also called its **unit**. In other words, $\langle L, \eta \rangle$ is called a left Kan extension of F along K if for any $H: \mathcal{D} \rightarrow \mathcal{E}$ and $\sigma: F \Rightarrow H \bullet K$, there exists a unique $\bar{\sigma}: L \Rightarrow H$ satisfying

$$(6.2)$$

where the blue circle is the unit η .

As the dual to a left Kan extension, a universal morphism $\langle R, \varepsilon \rangle$ from $- \bullet K$ to F is called a **right Kan extension** of F along K . ε is also called its **counit**. In other words, $\langle R, \varepsilon \rangle$ is called a right Kan extension of F along K if for any $H: \mathcal{D} \rightarrow \mathcal{E}$ and $\sigma: H \bullet K \Rightarrow F$, there exists a unique $\bar{\sigma}: H \Rightarrow R$ satisfying

$$(6.3)$$

where the blue circle is the counit ε .

We sometimes simply refer to L as a left Kan extension and R as a right Kan extension. We often write L as $\text{Lan}_K F$ and R as $\text{Ran}_K F$. Diagrams for right Kan extensions correspond to the “upside-down” version of diagrams for left Kan extensions. In what follows, we often only consider the properties of left Kan extensions, but by flipping diagrams upside-down, we can immediately obtain the properties of right Kan extensions.

Using a diagram introduced in Subsubsection 3.2.4, the inverse map $\sigma \mapsto \bar{\sigma}$ of the map $\bar{\sigma} \mapsto \sigma$ of Eq. (6.2) is represented by

$$(6.4)$$

The same applies to right Kan extensions.

Left Kan extensions are essentially unique if they exist, and so are right Kan extensions. Here, we specifically discuss the case of left Kan extensions. Let $\langle L, \eta \rangle$ be a left Kan extension of F along K ; then, for any left Kan extension $\langle L', \eta' \rangle$ of F along K , there exists a natural isomorphism $\psi: L \cong L'$ satisfying

$$(6.5)$$

where the blue circle is η , and the diamond block is ψ (see Eq. (3.54)). Conversely, any $\langle L', \eta' \rangle$ represented in the form of Eq. (6.5) is a left Kan extension of F along K . Thus, any functor isomorphic to L is a left Kan extension.

Example 6.6 ((co)limits are Kan extensions): Consider the case of $\mathcal{D} = \mathbf{1}$, in which K is only one functor $!$ from C to $\mathbf{1}$. A left Kan extension of F along $!$ is equal to a universal morphism from F to $- \bullet ! = \Delta_C$ (recall Example 2.21), i.e., a colimit of F . This Kan extension is represented by

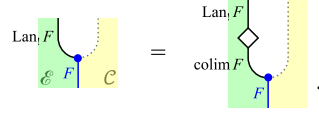

The left blue circle represents the unit of this Kan extension and the right blue circle represents a colimit cocone; they can be identified. Therefore, a colimit is a special case of a left Kan extension. Dually, a limit is a special case of a right Kan extension.

Example 6.7 (the Yoneda lemma): From Example 3.51, since $\langle \square^c, 1_c \rangle$ is a universal morphism from $\{*\} \in \mathbf{Set}$ to $ev_c = - \bullet c: \mathbf{Set}^C \rightarrow \mathbf{Set}$, it is a left Kan extension of $\{*\}$ along c . The right-hand side of the symbol “ \Leftrightarrow ” in Eq. (3.52) corresponds to Eq. (6.2).

Assume that \mathcal{E}^C and \mathcal{E}^D are locally small. By the properties of universal morphisms, there exists a left Kan extension of $F: C \rightarrow \mathcal{E}$ along $K: C \rightarrow \mathcal{D}$ if and only if the set-valued functor $\mathcal{E}^C(F, - \bullet K)$ is representable, i.e., there exists an $L: \mathcal{D} \rightarrow \mathcal{E}$ satisfying

$$\mathcal{E}^D(L, -) \cong \mathcal{E}^C(F, - \bullet K) \quad \xrightarrow{\text{diagram}} \quad \begin{array}{c} \mathcal{E} \\ \hline \mathcal{D} \\ \hline L \end{array} \cong \begin{array}{c} \mathcal{E} \\ \hline \mathcal{D} \\ \hline F \\ \hline C \end{array}, \quad (6.8)$$

in which case $L \cong \text{Lan}_K F$ holds. Furthermore, by the properties of adjunctions, there exists a left Kan extension of each $F: C \rightarrow \mathcal{E}$ along K if and only if there exists a left adjoint to the functor $- \bullet K: \mathcal{E}^D \rightarrow \mathcal{E}^C$. If $- \bullet K$ has a left adjoint, denoted by Lan_K , then for its unit η , η_F is the unit of the left Kan extension $\text{Lan}_K F$. In this case, from Eq. (6.2), for any natural transformation $\sigma: F \Rightarrow H \bullet K$ (where $H: \mathcal{D} \rightarrow \mathcal{E}$ is arbitrary), there exists a unique $\bar{\sigma}: \text{Lan}_K F \Rightarrow H$ satisfying

$$\begin{array}{c} \mathcal{E}^D \\ \hline \mathcal{D} \\ \hline H \\ \hline \sigma \\ \hline \mathcal{E}^C \\ \hline F \end{array} \quad (6.2) \quad = \quad \begin{array}{c} \mathcal{E}^D \\ \hline \mathcal{D} \\ \hline H \\ \hline \exists! \bar{\sigma} \\ \hline \mathcal{E}^C \\ \hline F \\ \hline \text{Lan}_K F \end{array} \quad = \quad \begin{array}{c} \mathcal{E}^D \\ \hline \mathcal{D} \\ \hline H \\ \hline \bar{\sigma} \\ \hline \mathcal{E}^C \\ \hline F \\ \hline \text{Lan}_K F \end{array} .$$

Dually, there exists a right Kan extension of F along K if and only if the presheaf $\mathcal{E}^C(- \bullet K, F)$ is representable, i.e., there exists an $R: \mathcal{D} \rightarrow \mathcal{E}$ satisfying

$$\mathcal{E}^D(-, R) \cong \mathcal{E}^C(- \bullet K, F) \quad \xrightarrow{\text{diagram}} \quad \begin{array}{c} \mathcal{E} \\ \hline \mathcal{D} \\ \hline R \end{array} \cong \begin{array}{c} \mathcal{E} \\ \hline \mathcal{D} \\ \hline F \\ \hline C \end{array},$$

in which case $R \cong \text{Ran}_K F$ holds. Furthermore, there exists a right Kan extension of each $F: C \rightarrow \mathcal{E}$ along K if and only if there exists a right adjoint to the functor $- \bullet K: \mathcal{E}^D \rightarrow \mathcal{E}^C$. If $- \bullet K$ has a right adjoint, denoted by Ran_K , then for its counit ε , ε_F is the counit of the right Kan extension $\text{Ran}_K F$. In this case, from Eq. (6.3), for any natural transformation $\sigma: H \bullet K \Rightarrow F$ (where $H: \mathcal{D} \rightarrow \mathcal{E}$ is arbitrary), there exists a unique $\bar{\sigma}: H \Rightarrow \text{Ran}_K F$ satisfying

$$\begin{array}{c} \mathcal{E}^C \\ \hline F \\ \hline \sigma \\ \hline \mathcal{E}^D \\ \hline H \end{array} \quad (6.3) \quad = \quad \begin{array}{c} \mathcal{E}^C \\ \hline F \\ \hline \exists! \bar{\sigma} \\ \hline \mathcal{E}^D \\ \hline H \\ \hline \text{Ran}_K F \end{array} \quad = \quad \begin{array}{c} \mathcal{E}^C \\ \hline F \\ \hline \bar{\sigma} \\ \hline \mathcal{E}^D \\ \hline H \\ \hline \text{Ran}_K F \end{array} .$$

6.2 Pointwise Kan extensions

6.2.1 Preliminaries: Basic properties of comma categories

In this subsection, we provide an overview of the fundamental properties of comma categories, which are often used when investigating pointwise left Kan extensions. Specifically, we consider the comma category $K \downarrow d$ with $K: C \rightarrow \mathcal{D}$ and $d \in \mathcal{D}$. Note that $K \downarrow d = \text{el}(\mathcal{D}(K-, d))$ holds.

Let us call the following functor, denoted by $P_d: K \downarrow d \rightarrow C$, the **forgetful functor** from $K \downarrow d$ to C :

- It maps each object $\langle c, p \rangle$ in $K \downarrow d$ to c .
- It maps each morphism $h: \langle c, p \rangle \rightarrow \langle c', p' \rangle$ in $K \downarrow d$ to the morphism $h: c \rightarrow c'$ in C .

It is readily confirmed that P_d is a functor. The behavior of this functor can be represented by

$$\begin{array}{c} \mathcal{C} \\ \downarrow P_d \\ K \downarrow d \end{array} \begin{array}{c} \langle c', p' \rangle \\ \boxed{h} \\ \langle c, p \rangle \end{array} = \begin{array}{c} c' \\ \boxed{h} \\ c \end{array} . \quad (6.9)$$

The collection of morphisms

$$\theta^d = \{\theta_{\langle c, p \rangle}^d := p\}_{\langle c, p \rangle \in K \downarrow d}$$

diagram \rightsquigarrow $\begin{array}{c} d \\ \mathcal{D} \\ \downarrow K \\ \mathcal{C} \end{array} \begin{array}{c} K \downarrow d \\ \downarrow P_d \\ \langle c, p \rangle \end{array} = \left\{ \begin{array}{c} d \\ \mathcal{D} \\ \downarrow K \\ \mathcal{C} \end{array} \begin{array}{c} K \downarrow d \\ \downarrow P_d \\ \langle c, p \rangle \end{array} \right\} := \left\{ \begin{array}{c} d \\ \boxed{p} \\ K \downarrow c \end{array} \right\}_{\langle c, p \rangle \in K \downarrow d} \quad (6.10)$

(where the blue circles represent θ^d , and the dotted lines represent the functor $!: K \downarrow d \rightarrow \mathbf{1}$) is a natural transformation from $K \bullet P_d$ to $d \bullet !$ (i.e., a cocone from $K \bullet P_d$ to d). Indeed, since we have for any morphism $h: \langle c, p \rangle \rightarrow \langle c', p' \rangle$ in $K \downarrow d$,

$$\begin{array}{c} \mathcal{D} \\ \downarrow d \\ K \downarrow d \end{array} \begin{array}{c} \langle c', p' \rangle \\ \boxed{h} \\ \langle c, p \rangle \end{array} \stackrel{(6.10)}{=} \begin{array}{c} d \\ \boxed{p} \\ K \downarrow c \end{array} \stackrel{(3.72)}{=} \begin{array}{c} d \\ \boxed{p'} \\ K \downarrow c' \end{array} \begin{array}{c} \langle c', p' \rangle \\ \boxed{h} \\ \langle c, p \rangle \end{array} \stackrel{(6.10)}{=} \begin{array}{c} \mathcal{D} \\ \downarrow d \\ K \downarrow d \end{array} \begin{array}{c} \langle c', p' \rangle \\ \boxed{h} \\ \langle c, p \rangle \end{array} ,$$

θ^d satisfies naturality. We call θ^d the **canonical cocone** for $K \downarrow d$. From Eq. (6.10),

$$\theta_{\langle c, 1_{Kc} \rangle}^{Kc} = 1_{Kc} \quad \text{diagram } \rightsquigarrow \begin{array}{c} Kc \\ \mathcal{D} \\ \downarrow K \\ \mathcal{C} \end{array} \begin{array}{c} K \downarrow Kc \\ \downarrow P_{Kc} \\ \langle c, 1_{Kc} \rangle \end{array} = \begin{array}{c} K \\ \boxed{1} \\ c \end{array} \quad (6.11)$$

holds.

The map, denoted by Φ , that maps $\{\{p\}_{p \in \mathcal{D}(Kc, d)}\}_{c \in C}$ to $\{p\}_{c \in C, p \in \mathcal{D}(Kc, d)} = \theta^d$ (by removing nesting) can be represented by

$$\left\{ \begin{array}{c} d \\ \mathcal{D} \\ \downarrow K \\ \mathcal{C} \end{array} \begin{array}{c} \boxed{p} \\ \langle c, p \rangle \end{array} \right\}_{c \in C} \xrightarrow{\Phi} \begin{array}{c} \mathcal{D} \\ \downarrow d \\ K \downarrow d \end{array} \begin{array}{c} \langle c, p \rangle \\ \boxed{p} \\ \langle c, p \rangle \end{array} . \quad (6.12)$$

Note that $c \in C$ and $p \in \mathcal{D}(Kc, d)$ is equivalent to $\langle c, p \rangle \in K \downarrow d$. Φ is obviously invertible.

For any morphism $f: d \rightarrow d'$ in \mathcal{D} , there exists a functor, denoted by $f \circ -$, from $K \downarrow d$ to $K \downarrow d'$ that

- maps each object $\langle c, p \rangle$ in $K \downarrow d$ to $\langle c, fp \rangle \in K \downarrow d'$.

- maps each morphism $h: \langle c, p \rangle \rightarrow \langle c', p' \rangle$ in $K \downarrow d$ to $h: \langle c, fp \rangle \rightarrow \langle c', fp' \rangle$ in $K \downarrow d'$. Note that both morphisms correspond to $h \in C(c, c')$ satisfying $p = p' \circ Kh$.

One can easily verify that $f \circ -$ is a functor. $\langle c, p \rangle \in K \downarrow d$ can be represented by

$$\begin{array}{|c|} \hline K \downarrow d \\ \hline \langle c, p \rangle \\ \hline \end{array} = \begin{array}{|c|} \hline K \downarrow Kc \\ \hline p \circ - \\ \hline \langle c, 1_{Kc} \rangle \\ \hline \end{array} \quad (6.13)$$

since $p = p \circ 1_{Kc}$ holds. Also, we have for any $f \in \mathcal{D}(d, d')$ and $\langle c, p \rangle \in K \downarrow d$,

$$\begin{array}{|c|} \hline \mathcal{D} \ d' \\ \hline \begin{array}{|c|} \hline C \\ \hline K \ P_d \end{array} \\ \hline \end{array} \begin{array}{|c|} \hline K \downarrow d' \\ \hline \end{array} \begin{array}{|c|} \hline K \downarrow d \\ \hline \end{array} \langle c, p \rangle = \begin{array}{|c|} \hline d' \\ \hline \begin{array}{|c|} \hline K \ P_d \end{array} \\ \hline \end{array} \langle c, fp \rangle \quad (6.10) = \begin{array}{|c|} \hline d' \\ \hline \begin{array}{|c|} \hline f \\ \hline d \\ \hline \begin{array}{|c|} \hline p \\ \hline K \end{array} \\ \hline c \end{array} \\ \hline \end{array} \quad (6.10) = \begin{array}{|c|} \hline d' \\ \hline \begin{array}{|c|} \hline f \\ \hline d \\ \hline \begin{array}{|c|} \hline K \ P_d \end{array} \\ \hline \end{array} \\ \hline \end{array} \langle c, p \rangle ,$$

which gives

$$\begin{array}{|c|} \hline \mathcal{D} \ d' \\ \hline \begin{array}{|c|} \hline C \\ \hline K \ P_d \end{array} \\ \hline \end{array} \begin{array}{|c|} \hline K \downarrow d' \\ \hline \end{array} \begin{array}{|c|} \hline K \downarrow d \\ \hline \end{array} \langle c, p \rangle = \begin{array}{|c|} \hline d' \\ \hline \begin{array}{|c|} \hline f \\ \hline d \\ \hline \begin{array}{|c|} \hline K \ P_d \end{array} \\ \hline \end{array} \\ \hline \end{array} . \quad (6.14)$$

The comma category $d \downarrow K$, which is equal to $\text{el}(\mathcal{D}(d, K-))$, can be considered similarly. The **forgetful functor**, denoted by $P_d: d \downarrow K \rightarrow C$, from $d \downarrow K$ to C is defined as follows:

- It maps each object $\langle c, p \rangle$ in $d \downarrow K$ to c .
- It maps each morphism h in $d \downarrow K$ to the morphism h in C .

In this case, the collection of morphisms

$$\theta^d := \{\theta_{\langle c, p \rangle}^d := p\}_{\langle c, p \rangle \in d \downarrow K}$$

is a natural transformation from $d \bullet !$ to $K \bullet P_d$ (i.e., a cone from d to $K \bullet P_d$). We call θ^d the **canonical cone** for $d \downarrow K$.

6.2.2 Pointwise Kan extensions

Assume that there exists a left Kan extension $\langle L, \eta \rangle$ of a functor $F: C \rightarrow \mathcal{E}$ along a functor $K: C \rightarrow \mathcal{D}$. To explicitly determine L and η , let us consider the composite of η and the canonical cocone θ^d for $K \downarrow d$ for each $d \in \mathcal{D}$. Specifically, we define μ^d as

$$\mu^d := (L \bullet \theta^d)(\eta \bullet P_d) \quad \xrightarrow{\text{diagram}} \quad \begin{array}{|c|} \hline Ld \\ \hline \begin{array}{|c|} \hline \mu^d \\ \hline F \ P_d \end{array} \\ \hline \end{array} \quad := \quad \begin{array}{|c|} \hline \mathcal{D} \ d \\ \hline \begin{array}{|c|} \hline L \\ \hline K \ P_d \\ \hline F \end{array} \\ \hline \end{array} , \quad (6.15)$$

where the left and right blue circles represent η and θ^d , respectively. Since μ^d is simply a composite of the unit, η , of the left Kan extension and θ^d , it can be considered somewhat “canonical”. On the other hand, μ^d is a cocone from $F \bullet P_d$ to Ld . If each μ^d is a universal morphism, i.e., a colimit of $F \bullet P_d$, then Ld will be essentially uniquely determined as a colimit object of $F \bullet P_d$. Moreover, each component of the unit η can be obtained by

$$\begin{array}{|c|} \hline \mathcal{D} \\ \hline \begin{array}{|c|} \hline L \\ \hline K \\ \hline F \end{array} \\ \hline \end{array} \begin{array}{|c|} \hline C \\ \hline \end{array} \langle c \rangle = \begin{array}{|c|} \hline Kc \\ \hline \begin{array}{|c|} \hline L \\ \hline K \\ \hline F \end{array} \\ \hline \end{array} \begin{array}{|c|} \hline K \downarrow Kc \\ \hline \end{array} \langle c, 1_{Kc} \rangle \quad (6.11) = \begin{array}{|c|} \hline L(Kc) \\ \hline \begin{array}{|c|} \hline \mu^{Kc} \\ \hline F \ P_{Kc} \end{array} \\ \hline \end{array} \langle c, 1_{Kc} \rangle , \quad (6.15) \quad (6.16)$$

and thus we obtain $\eta = \{\mu_{(c, 1_{Kc})}^{Kc}\}_{c \in \mathcal{C}}$.

Unfortunately, the existence of a left Kan extension $\langle L, \eta \rangle$ does not guarantee that $F \bullet P_d$ has a colimit for each $d \in \mathcal{D}$. However, conversely, if these colimits exist, then it can be shown that

- There exists a left Kan extension $\langle L, \eta \rangle$ satisfying Eq. (6.15) (see Theorem 6.20).
- For any left Kan extension $\langle L, \eta \rangle$, each μ^d defined by Eq. (6.15) is a colimit cocone of $F \bullet P_d$ (see Corollary 6.26).

Therefore, let us call a left Kan extension pointwise if $F \bullet P_d$ has a colimit for each $d \in \mathcal{D}$. Explicitly, it is defined as follows:

Definition 6.17 (pointwise Kan extensions): Consider two functors $K: \mathcal{C} \rightarrow \mathcal{D}$ and $F: \mathcal{C} \rightarrow \mathcal{E}$. A left Kan extension of F along K is called **pointwise** if $F \bullet P_d$ has a colimit for each $d \in \mathcal{D}$. Dually, a right Kan extension of F along K is called **pointwise** if $F \bullet P_d$ has a limit for each $d \in \mathcal{D}$.

If a pointwise left Kan extension L exists, then any left Kan extension of F along K is pointwise (the same applies to right Kan extensions). This is because whether or not $F \bullet P_d$ has a colimit does not depend on the choice of the left Kan extension. As will gradually become clear, several useful properties hold if a Kan extension is pointwise.

If a left Kan extension $\langle L, \eta \rangle$ is pointwise, then we have



(6.18)

where the left and right blue circles are η and θ^d , respectively, and the diamond block represents the isomorphism $Ld \cong \text{colim}(F \bullet P_d)$. The natural transformation enclosed by the auxiliary line is the colimit cocone μ^d of Eq. (6.15). Due to the universal property of μ^d (see Eq. (5.6)), for any cocone $\alpha \in \text{Cocone}(F \bullet P_d, e)$, there exists a unique morphism $\bar{\alpha} \in \mathcal{E}(Ld, e)$ satisfying

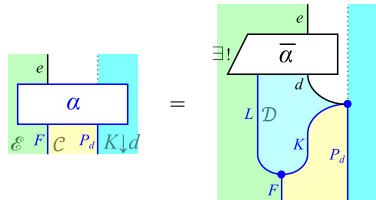

(6.19)

It follows from the dual of Eq. (6.18) that a pointwise right Kan extension $\langle R, \varepsilon \rangle$ satisfies

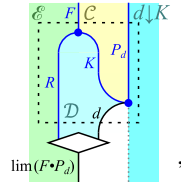

where the left and right blue circles are ε and the canonical cone θ^d for $d \downarrow K$, respectively. The diamond block represents the isomorphism $Rd \cong \text{lim}(F \bullet P_d)$ and the natural transformation enclosed by the auxiliary line is a limit cone of $F \bullet P_d$.

Theorem 6.20: Consider two functors $K: \mathcal{C} \rightarrow \mathcal{D}$ and $F: \mathcal{C} \rightarrow \mathcal{E}$. Assume that for each $d \in \mathcal{D}$, $F \bullet P_d$ has a colimit $\langle e_d, \mu^d \rangle$, where P_d is the forgetful functor from $K \downarrow d$ to \mathcal{C} . Then, the following two properties hold:

- (1) There exists a unique functor $L: \mathcal{D} \rightarrow \mathcal{E}$ that maps each object d in \mathcal{D} to $Ld = e_d$, and satisfies

$$\mu^{d'} \bullet (f \circ -) = (Lf \bullet !) \circ \mu^d$$

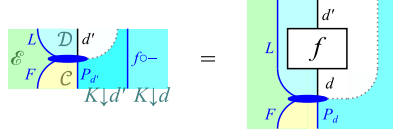
diagram \rightsquigarrow  (6.21)

for each morphism $f: d \rightarrow d'$ in \mathcal{D} , where the left and right blue ellipses represent $\mu^{d'}$ and μ^d , respectively.

- (2) Let

$$\eta := \{\eta_c := \mu_{\langle c, 1_{Kc} \rangle}^{Kc}\}_{c \in \mathcal{C}}$$

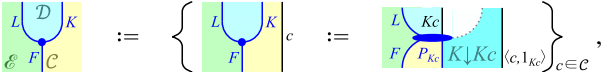
diagram \rightsquigarrow  (6.22)

where the blue circle is η (see Eq. (6.16)); then, $\langle L, \eta \rangle$ is a pointwise left Kan extension of F along K .

Proof. (1): Since the left-hand side of Eq. (6.21) is a cocone from $F \bullet P_d$ and μ^d is a colimit cocone, Lf satisfying Eq. (6.21) is uniquely determined. It remains to show that L is a functor. We have for any $f \in \mathcal{D}(d, d')$ and $g \in \mathcal{D}(d', d'')$,

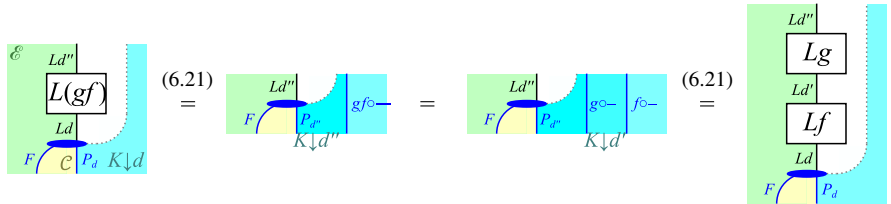

Therefore, due to the universal property of μ^d (see Eq. (3.68)), we have $L(gf) = Lg \circ Lf$. Also, $L1_d = 1_{Ld}$ obviously holds, and thus L is a functor.

(2): First, let us verify that η is a natural transformation from F to $L \bullet K$. This can be seen from

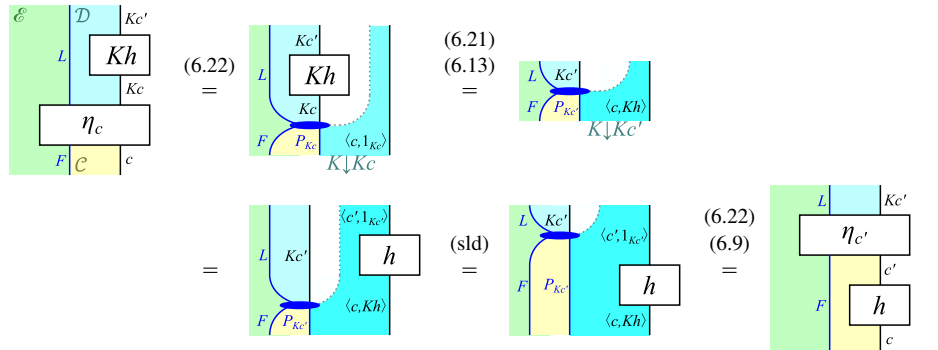

where the first equality on the second line follows from the fact that $! \bullet h$ is the unique morphism 1_* in $\mathbf{1}$ regardless of h . Next, we show that $\langle L, \eta \rangle$ is a left Kan extension of F along K . Note that if $\langle L, \eta \rangle$ is a left Kan extension, then it is pointwise by the definition of pointwise Kan extensions. We have for each $\langle c, p \rangle \in K \downarrow d$,

$$\begin{array}{c}
 \begin{array}{c} \mathcal{E} \\ \mathcal{D} \\ \mathcal{C} \\ F \end{array} \begin{array}{c} L \\ \mathcal{D} \\ \mathcal{C} \\ F \end{array} \begin{array}{c} d \\ P_d \\ K \downarrow d \end{array} \begin{array}{c} \langle c, p \rangle \end{array} \\
 \begin{array}{c} (6.13) \\ (6.21) \end{array} = \begin{array}{c} \mathcal{E} \\ \mathcal{D} \\ \mathcal{C} \\ F \end{array} \begin{array}{c} L \\ \mathcal{D} \\ \mathcal{C} \\ F \end{array} \begin{array}{c} d \\ P_d \\ K \downarrow Kc \end{array} \begin{array}{c} \langle c, 1_{Kc} \rangle \end{array} \\
 \begin{array}{c} (6.22) \end{array} = \begin{array}{c} \mathcal{E} \\ \mathcal{D} \\ \mathcal{C} \\ F \end{array} \begin{array}{c} L \\ \mathcal{D} \\ \mathcal{C} \\ F \end{array} \begin{array}{c} d \\ P_d \\ K \downarrow c \end{array} \\
 \begin{array}{c} (6.10) \end{array} = \begin{array}{c} \mathcal{E} \\ \mathcal{D} \\ \mathcal{C} \\ F \end{array} \begin{array}{c} L \\ \mathcal{D} \\ \mathcal{C} \\ F \end{array} \begin{array}{c} d \\ P_d \\ K \downarrow c \end{array} \begin{array}{c} \langle c, p \rangle \end{array}
 \end{array} \tag{6.23}$$

where the rightmost blue circle represents the canonical cocone θ^d for $K \downarrow d$, and thus $\mu^d = (L \bullet \theta^d)(\eta \bullet P_d)$ (i.e., Eq. (6.15)) holds. It suffices to show that for any natural transformation $\alpha: F \Rightarrow H \bullet K$ (where $H: \mathcal{D} \rightarrow \mathcal{E}$ is arbitrary), there exists a unique natural transformation β such that $\alpha = (\beta \bullet K) \circ \eta$ (see Eq. (6.2)). Assuming such β exists, we have for each $d \in \mathcal{D}$,

$$\begin{array}{c}
 \begin{array}{c} \mathcal{E} \\ \mathcal{D} \\ \mathcal{C} \\ F \end{array} \begin{array}{c} H \\ \mathcal{D} \\ \mathcal{C} \\ F \end{array} \begin{array}{c} d \\ P_d \\ K \downarrow d \end{array} \\
 = \begin{array}{c} \mathcal{E} \\ \mathcal{D} \\ \mathcal{C} \\ F \end{array} \begin{array}{c} H \\ \mathcal{D} \\ \mathcal{C} \\ F \end{array} \begin{array}{c} d \\ P_d \\ K \downarrow d \end{array} \begin{array}{c} \beta \end{array} \\
 \begin{array}{c} (\text{slid}) \end{array} = \begin{array}{c} \mathcal{E} \\ \mathcal{D} \\ \mathcal{C} \\ F \end{array} \begin{array}{c} H \\ \mathcal{D} \\ \mathcal{C} \\ F \end{array} \begin{array}{c} d \\ P_d \\ K \downarrow d \end{array} \begin{array}{c} \beta \end{array} \\
 \begin{array}{c} (6.23) \end{array} = \begin{array}{c} \mathcal{E} \\ \mathcal{D} \\ \mathcal{C} \\ F \end{array} \begin{array}{c} H \\ \mathcal{D} \\ \mathcal{C} \\ F \end{array} \begin{array}{c} d \\ P_d \\ K \downarrow d \end{array} \begin{array}{c} \beta \end{array}
 \end{array} \tag{6.24}$$

In contrast, since μ^d is a colimit cocone, there exists a unique morphism $\bar{\alpha}_d$ satisfying

$$\begin{array}{c}
 \begin{array}{c} \mathcal{E} \\ \mathcal{D} \\ \mathcal{C} \\ F \end{array} \begin{array}{c} H \\ \mathcal{D} \\ \mathcal{C} \\ F \end{array} \begin{array}{c} d \\ P_d \\ K \downarrow d \end{array} \\
 \begin{array}{c} (5.6) \end{array} \exists! \begin{array}{c} \mathcal{E} \\ \mathcal{D} \\ \mathcal{C} \\ F \end{array} \begin{array}{c} H \\ \mathcal{D} \\ \mathcal{C} \\ F \end{array} \begin{array}{c} d \\ P_d \\ K \downarrow d \end{array} \begin{array}{c} \bar{\alpha}_d \end{array}
 \end{array} \tag{6.25}$$

where we use the fact that the left-hand side is a cocone from $F \bullet P_d$ to Hd . From Eqs. (6.24) and (6.25), we have $\beta_d = \bar{\alpha}_d$. Thus, β is uniquely determined as $\beta = \{\bar{\alpha}_d\}_{d \in \mathcal{D}} =: \bar{\alpha}$. Also, if $\bar{\alpha}$ is a natural transformation, then

$$\begin{array}{c}
 \begin{array}{c} \mathcal{E} \\ \mathcal{D} \\ \mathcal{C} \\ F \end{array} \begin{array}{c} H \\ \mathcal{D} \\ \mathcal{C} \\ F \end{array} \begin{array}{c} c \\ P_c \\ K \downarrow c \end{array} \\
 \begin{array}{c} (6.11) \end{array} = \begin{array}{c} \mathcal{E} \\ \mathcal{D} \\ \mathcal{C} \\ F \end{array} \begin{array}{c} H \\ \mathcal{D} \\ \mathcal{C} \\ F \end{array} \begin{array}{c} c \\ P_c \\ K \downarrow Kc \end{array} \begin{array}{c} \langle c, 1_{Kc} \rangle \end{array} \\
 \begin{array}{c} (6.25) \end{array} = \begin{array}{c} \mathcal{E} \\ \mathcal{D} \\ \mathcal{C} \\ F \end{array} \begin{array}{c} H \\ \mathcal{D} \\ \mathcal{C} \\ F \end{array} \begin{array}{c} c \\ P_c \\ K \downarrow Kc \end{array} \begin{array}{c} \langle c, 1_{Kc} \rangle \end{array} \\
 \begin{array}{c} (6.22) \end{array} = \begin{array}{c} \mathcal{E} \\ \mathcal{D} \\ \mathcal{C} \\ F \end{array} \begin{array}{c} H \\ \mathcal{D} \\ \mathcal{C} \\ F \end{array} \begin{array}{c} c \\ P_c \\ K \downarrow c \end{array}
 \end{array}$$

holds for each $c \in \mathcal{C}$, and thus $\alpha = (\bar{\alpha} \bullet K) \circ \eta$ holds. Therefore, it remains to show that $\bar{\alpha}$ is a

natural transformation. Since we have for any morphism $f: d \rightarrow d'$ in \mathcal{D} ,

by the universality of the colimit cocone μ^d (see Eq. (3.68)), the two morphisms enclosed by the auxiliary lines, $Hf \circ \bar{\alpha}_d$ and $\bar{\alpha}_{d'} \circ Lf$, are equal. Therefore, $\bar{\alpha}$ is a natural transformation. \square

Supplement: Let us point out that this theorem is similar to Lemma 3.79. This lemma asserts that a functor F is uniquely determined and that $\langle F, \eta \rangle$ is a universal morphism. In contrast, this theorem asserts that a functor L is uniquely determined and that $\langle L, \eta \rangle$ is a universal morphism (i.e., a left Kan extension of F along K). Note that Eq. (6.22) corresponds to Eq. (3.80). The proof methods used also exhibit many similarities.

This theorem shows that if $F \bullet P_d$ has a colimit $\langle e_d, \mu^d \rangle$ for each $d \in \mathcal{D}$, then there exists a pointwise left Kan extension $\langle L, \eta \rangle$ of F along K such that $Ld = e_d$ and Eq. (6.21) hold. Conversely, the following corollary shows that for any pointwise left Kan extension $\langle L, \eta \rangle$ of F along K , there exists such a colimit $\langle e_d, \mu^d \rangle$.

Corollary 6.26: Let us consider two functors $K: \mathcal{C} \rightarrow \mathcal{D}$ and $F: \mathcal{C} \rightarrow \mathcal{E}$. Assume that there exists a pointwise left Kan extension $\langle L, \eta \rangle$ of F along K . Let P_d be the forgetful functor from $K \downarrow d$ to \mathcal{C} and $\mu^d := (L \bullet \theta^d)(\eta \bullet P_d)$ (see Eq. (6.15)) for each $d \in \mathcal{D}$. Then, Eq. (6.21) holds and for each $d \in \mathcal{D}$, $\langle Ld, \mu^d \rangle$ is a colimit of $F \bullet P_d$.

Proof. By assumption, $F \bullet P_d$ has a colimit for each $d \in \mathcal{D}$. Let μ'^d be its colimit cocone and $\langle L', \eta' \rangle$ be $\langle L, \eta \rangle$ obtained by Theorem 6.20 with $\mu^d = \mu'^d$. Then, μ^d satisfies

where the leftmost blue circle represents η , the other blue circles represent the canonical cocone θ^d for $K \downarrow d$, and the blue ellipse represents μ'^d . The second equality follows from the fact that since both $\langle L, \eta \rangle$ and $\langle L', \eta' \rangle$ are left Kan extensions of F along K , there exists a natural isomorphism $\gamma: L' \cong L$ such that $\eta = (\gamma \bullet K) \circ \eta'$ (see Eq. (6.5)). Thus, $\langle Ld, \mu^d \rangle$, as well as $\langle L'd, \mu'^d \rangle$, is a

colimit of $F \bullet P_d$ (see Eq. (5.7)). Also, Eq. (6.21) holds from

$$\begin{array}{c} \mathcal{E} \\ \hline L \downarrow \mathcal{D} d' \\ \hline \mu^{d'} \\ \hline F \downarrow \mathcal{C} P_d \downarrow K \downarrow d' \downarrow K \downarrow d \end{array} \stackrel{(6.27)}{=} \begin{array}{c} L \\ \downarrow \\ L' \\ \downarrow \\ F \end{array} \begin{array}{c} \mathcal{D} d' \\ \downarrow \\ d' \\ \downarrow \\ P_d \end{array} \begin{array}{c} \mathcal{E} \\ \hline f \circ - \\ \hline \end{array} \stackrel{(6.21)}{=} \begin{array}{c} L \\ \downarrow \\ L' \\ \downarrow \\ F \end{array} \begin{array}{c} \mathcal{D} d' \\ \downarrow \\ d' \\ \downarrow \\ P_d \end{array} \begin{array}{c} \mathcal{E} \\ \hline f \\ \hline \end{array} \stackrel{(6.27)}{=} \begin{array}{c} \mathcal{E} \\ \hline L \downarrow \mathcal{D} d' \\ \hline \mu^d \\ \hline F \downarrow \mathcal{C} P_d \downarrow K \downarrow d \end{array} .
 \end{array}$$

□

6.2.3 Cocones from $F \bullet P_d$

For a pointwise left Kan extension L , Ld is a colimit object of $F \bullet P_d$ for each $d \in \mathcal{D}$. Therefore, when considering pointwise left Kan extensions, it is useful to deepen our understanding of cocones from $F \bullet P_d$ for future discussions.

Let us arbitrarily choose $e \in \mathcal{E}$ and a cocone $\alpha \in \text{Cocone}(F \bullet P_d, e)$. α can be represented by

$$\begin{array}{c} \mathcal{E} \\ \hline e \\ \hline \alpha \\ \hline \mathcal{E} \downarrow F \downarrow \mathcal{C} \downarrow P_d \downarrow K \downarrow d \end{array} = \left\{ \begin{array}{c} \mathcal{E} \\ \hline e \\ \hline \alpha_{\langle c,p \rangle} \\ \hline F \downarrow P_d \downarrow \langle c,p \rangle \end{array} = \begin{array}{c} \mathcal{E} \\ \hline e \\ \hline \alpha_{\langle c,p \rangle} \\ \hline F \downarrow c \end{array} \right\}_{\langle c,p \rangle \in K \downarrow d} ,$$

where we used $P_d \langle c, p \rangle = c$. The cocone $\alpha = \{\alpha_{\langle c,p \rangle}\}_{\langle c,p \rangle \in K \downarrow d}$ can be easily seen to correspond one-to-one with $\tilde{\alpha} := \{\{\alpha_{\langle c,p \rangle}\}_{p \in \mathcal{D}(Kc,d)}\}_{c \in \mathcal{C}}$, where we used the fact that $\langle c, p \rangle \in K \downarrow d$ is equal to $c \in \mathcal{C}$ and $p \in \mathcal{D}(Kc, d)$. While α maps each pair $\langle c, p \rangle$ of $c \in \mathcal{C}$ and $p \in \mathcal{D}(Kc, d)$ to the morphism $\alpha_{\langle c,p \rangle} \in \mathcal{E}(Fc, e)$, $\tilde{\alpha}$ maps each $c \in \mathcal{C}$ to the map (i.e., the morphism in **Set**) $\tilde{\alpha}_c : \mathcal{D}(Kc, d) \ni p \mapsto \alpha_{\langle c,p \rangle} \in \mathcal{D}(Fc, e)$.

As will be shown in Lemma 6.29, this correspondence ensures that the $\tilde{\alpha}$ corresponding to the cocone $\alpha \in \text{Cocone}(F \bullet P_d, e)$ is an element of $\hat{\mathcal{C}}(\mathcal{D}(K-, d), \mathcal{E}(F-, e))$ (i.e., a natural transformation) and the map

$$\Psi_e : \text{Cocone}(F \bullet P_d, e) \ni \alpha \mapsto \tilde{\alpha} \in \hat{\mathcal{C}}(\mathcal{D}(K-, d), \mathcal{E}(F-, e)) \tag{6.28}$$

is invertible. It is also understood that $\{\Psi_e\}_{e \in \mathcal{E}}$ is a natural isomorphism.

Lemma 6.29: Consider an object $d \in \mathcal{D}$ and two functors $K : \mathcal{C} \rightarrow \mathcal{D}$ and $F : \mathcal{C} \rightarrow \mathcal{E}$. Let P_d be the forgetful functor from $K \downarrow d$ to \mathcal{C} ; then, there exists an isomorphism

$$\text{Cocone}(F \bullet P_d, e) \cong \hat{\mathcal{C}}(\mathcal{D}(K-, d), \mathcal{E}(F-, e)) \tag{6.30}$$

that is natural in $e \in \mathcal{E}$.

The isomorphism of Eq. (6.30) can be represented by

$$\begin{array}{c} \mathcal{E} \\ \hline - \\ \hline K \downarrow d \\ \hline F \downarrow \mathcal{C} \downarrow P_d \end{array} \cong \begin{array}{c} \mathcal{E}^{\text{op}} \\ \hline - \\ \hline \text{Set } d \downarrow \mathcal{D}^{\text{op}} \downarrow K \downarrow \mathcal{C}^{\text{op}} \\ \hline F \end{array} , \tag{6.31}$$

where we used $\mathcal{D}(K-, d) = d^\square \bullet K$ and $\mathcal{E}(F-, e) = e^\square \bullet F$, and replaced e with $-$. Intuitively, the wire P_d on the left-hand side corresponds to the two wires K and d^\square on the right-hand side.

Proof. Let $T_d := F \bullet P_d$. For any $e \in \mathcal{E}$, consider the following map for $\tau \in \hat{\mathcal{C}}(\mathcal{D}(K-, d), \mathcal{E}(F-, e))$:

$$\Phi_e : \tau = \{\{\tau_{\langle c,p \rangle}\}_{p \in \mathcal{D}(Kc,d)}\}_{c \in \mathcal{C}} \mapsto \{\tau_{\langle c,p \rangle}\}_{c \in \mathcal{C}, p \in \mathcal{D}(Kc,d)} . \tag{6.32}$$

It suffices to show that for each e , Φ_e is a bijection from $\hat{\mathcal{C}}(\mathcal{D}(K-, d), \mathcal{E}(F-, e))$ to $\text{Cocone}(T_d, e)$, and that these isomorphisms are natural in e . Note that Φ_e is the inverse of Ψ_e .

We have for any $\tau \in \hat{\mathcal{C}}(\mathcal{D}(K-, d), \mathcal{E}(F-, e))$,

$$\begin{array}{c} \text{Set}^{\text{op}} \\ \begin{array}{|c|} \hline \mathcal{D} \\ \hline \tau \\ \hline \mathcal{C} \\ \hline \mathcal{E} \\ \hline F \\ \hline \end{array} \end{array} = \left\{ \begin{array}{|c|} \hline d \\ \hline \tau \\ \hline c \\ \hline \end{array} \right\}_{c \in \mathcal{C}} \xrightarrow{\Phi_e} \left\{ \begin{array}{|c|} \hline d \\ \hline p \\ \hline \tau \\ \hline c \\ \hline \end{array} \right\}_{c \in \mathcal{C}, p \in \mathcal{D}(Kc, d)} = \begin{array}{|c|} \hline d \\ \hline \tau \\ \hline K \downarrow d \\ \hline \end{array} , \quad (6.33)$$

the black and blue circles represent 1_d and the canonical cocone θ^d for $K \downarrow d$, respectively. The first equality follows from the fact that each component τ_c of τ is a map from $\mathcal{D}(Kc, d)$ to $\mathcal{E}(Fc, e)$, and $\mathcal{E}(Fc, e)$ is represented in the form corresponding to the dual (i.e., “upside-down”) of the third expression of Eq. (3.41). See Eq. (6.12) for the map Φ_e . Therefore, $\Phi_e(\tau) \in \text{Cocone}(\mathcal{E}(T_d-, e), \{*\}) = \text{Cocone}(T_d, e)$ holds, where the equality is due to Lemma 5.11. Also, it is easy to see that this is natural in e ; indeed, the structure of the equation will not change even if we apply f^\square (where $f \in \mathcal{E}(e, e')$ is arbitrary) from below at the position of the wire e^\square . It remains to show that $\Phi_e: \hat{\mathcal{C}}(\mathcal{D}(K-, d), \mathcal{E}(F-, e)) \rightarrow \text{Cocone}(T_d, e)$ is a bijection. Φ_e is obviously injective; indeed, for any distinct $\tau, \tau' \in \text{Cocone}(T_d, e)$, there exists $\langle c, p \rangle \in K \downarrow d$ satisfying $\tau_{\langle c, p \rangle} \neq \tau'_{\langle c, p \rangle}$. In what follows, we show that Φ_e is surjective. For each $\sigma \in \text{Cocone}(T_d, e)$, let

$$\bar{\sigma} := \{ \{ \sigma_{\langle c, p \rangle} \}_{p \in \mathcal{D}(Kc, d)} \}_{c \in \mathcal{C}} . \quad (6.34)$$

Let us verify that $\bar{\sigma} \in \hat{\mathcal{C}}(\mathcal{D}(K-, d), \mathcal{E}(F-, e))$ holds, i.e., $\bar{\sigma}$ satisfies naturality. For any $p' \in \mathcal{D}(Kc', d)$ and $h \in C(c, c')$, let $p := p' \circ Kh$; then, we have

$$\begin{array}{c} \text{Set}^{\text{op}} \\ \begin{array}{|c|} \hline p' \\ \hline \mathcal{D} \\ \hline h \\ \hline \mathcal{C} \\ \hline \bar{\sigma}_c \\ \hline \mathcal{E} \\ \hline F \\ \hline \end{array} \end{array} = \begin{array}{|c|} \hline e \\ \hline \sigma_{\langle c, p \rangle} \\ \hline c \\ \hline \end{array} = \begin{array}{|c|} \hline K \downarrow d \\ \hline h \\ \hline \sigma \\ \hline \langle c, p \rangle \\ \hline \end{array} \\ \\ = \begin{array}{|c|} \hline e \\ \hline \sigma \\ \hline \langle c, p \rangle \\ \hline F \\ \hline p_d \\ \hline h \\ \hline \langle c, p \rangle \\ \hline \end{array} \stackrel{(6.9)}{=} \begin{array}{|c|} \hline e \\ \hline \sigma_{\langle c', p' \rangle} \\ \hline c' \\ \hline F \\ \hline h \\ \hline c \\ \hline \end{array} = \begin{array}{|c|} \hline p' \\ \hline \mathcal{D} \\ \hline \bar{\sigma}_{c'} \\ \hline \mathcal{E} \\ \hline F \\ \hline h \\ \hline c \\ \hline \end{array} .$$

Therefore,

holds, and thus $\bar{\sigma}$ satisfies naturality. It follows from Eqs. (6.32) and (6.34) that $\Phi_e(\bar{\sigma}) = \sigma$ holds, so Φ_e is surjective. \square

The map Ψ_e of Eq. (6.28) can be expressed by

where the natural transformation $\tilde{\alpha}$ is represented by a block in the shape of “ \sqsubset ”. The equality in Eq. (6.35) follows from

for each $\langle c, p \rangle \in K \downarrow d$, where the second equality follows from $\alpha_{\langle c, p \rangle} = \tilde{\alpha}_c(p)$. Intuitively, the map Ψ_e of Eq. (6.35) replaces θ^d with the dotted box representing $\mathcal{D}(K-, d)$.

We note that the equation on the left-hand side of the symbol “ $\xrightarrow{\Psi_e}$ ” in Eq. (6.35) can be rewritten as

where the functor $\{*\} \bullet !: (K \downarrow d)^{\text{op}} \rightarrow \mathbf{Set}$, which is the horizontal composition of the functors $\{*\}: \mathbf{1} \rightarrow \mathbf{Set}$ and $!: (K \downarrow d)^{\text{op}} \rightarrow \mathbf{1}$, is represented by a gray dotted line. In fact, $\alpha \in \text{Cocone}(F \bullet P_d, e)$ in Eq. (6.35) can be depicted by

where the first equality follows from the “upside-down” version of Eq. (5.13) with $c = e$ and $D = F \bullet P_d$. The second equality follows from $e' \bullet F = \mathcal{E}(F-, e)$. Note that we use both

rectangles and ellipses as block shapes to represent α , but there is no semantic difference between them. Let θ^d be the canonical cocone for $K \downarrow d$; then, substituting $\alpha = \theta^d$ (and $F = K$, $e = d$) into Eq. (6.37) yields

$$\begin{array}{c} \mathcal{D} \downarrow d \\ \swarrow \quad \searrow \\ K \downarrow c \quad P_d \end{array} = \begin{array}{c} \mathbf{Set}^{\text{op}} \\ \swarrow \quad \searrow \\ \mathcal{D}(K-, d) \quad P_d \end{array}, \quad (6.38)$$

where the blue circles represent θ^d . We can see that Eqs. (6.37) and (6.38) give Eq. (6.36).

Equation (6.36) can also be considered as a generalization of the Yoneda lemma (see Corollary 3.42). Choose an arbitrary presheaf $X: \mathcal{C}^{\text{op}} \rightarrow \mathbf{Set}$, and substitute $\mathcal{E} = \mathbf{Set}^{\text{op}}$, $e = \{*\}$, and $F = X^{\text{op}}$ into Eq. (6.36); then, since $\mathcal{E}(F-, e) = \mathbf{Set}^{\text{op}}(X^{\text{op}-}, \{*\}) = \mathbf{Set}(\{*\}, X-) = X$ holds, for any cone α from $\{*\}$ to $X \bullet P_d: (K \downarrow d)^{\text{op}} \rightarrow \mathbf{Set}$, there exists a unique natural transformation $\tilde{\alpha}: \mathcal{D}(K-, d) \Rightarrow X$ satisfying

$$\begin{array}{c} X | \mathcal{C}^{\text{op}} P_d | (K \downarrow d)^{\text{op}} \\ \swarrow \quad \searrow \\ \mathbf{Set} \quad \alpha \end{array} \stackrel{(6.36)}{=} \begin{array}{c} X | \\ \swarrow \quad \searrow \\ \mathcal{D}(K-, d) \quad P_d \\ \tilde{\alpha} \end{array}. \quad (6.39)$$

Furthermore, consider the case of $\mathcal{D} = \mathcal{C}$ and $K = 1_{\mathcal{C}}$, and rewrite the object d in \mathcal{C} as c . $\langle X, 1_X \rangle$ is a right Kan extension of X along $1_{\mathcal{C}^{\text{op}}}$ and is pointwise since \mathbf{Set} is complete (see Corollary 6.45). Thus, from the dual of Eq. (6.19), there exists a unique $\bar{\alpha} \in \mathbf{Set}(\{*\}, Xc) = Xc$ satisfying

$$\begin{array}{c} X | \mathcal{C}^{\text{op}} P_c | (1_{\mathcal{C}} \downarrow c)^{\text{op}} \\ \swarrow \quad \searrow \\ \mathbf{Set} \quad \alpha \end{array} = \begin{array}{c} X | \\ \swarrow \quad \searrow \\ P_c \\ \bar{\alpha} \end{array}, \quad (6.40)$$

where the blue circle represents θ^c . Therefore, $\bar{\alpha} \in Xc$ and $\tilde{\alpha}: c^{\square} \Rightarrow X$ that satisfy

$$\begin{array}{c} X | \mathcal{C}^{\text{op}} P_c | (1_{\mathcal{C}} \downarrow c)^{\text{op}} \\ \swarrow \quad \searrow \\ \mathbf{Set} \quad \bar{\alpha} \end{array} \stackrel{(6.40)}{=} \begin{array}{c} X | P_c \\ \alpha \end{array} \stackrel{(6.39)}{=} \begin{array}{c} X | \\ \swarrow \quad \searrow \\ P_c \\ \tilde{\alpha} \end{array} \quad (6.41)$$

correspond one-to-one. Applying $\langle c, 1_c \rangle \in (1_{\mathcal{C}} \downarrow c)^{\text{op}}$ from the left- and right-hand sides of Eq. (6.41) and using $\theta_{\langle c, 1_c \rangle}^c = 1_c$ (see Eq. (6.11)) yields

$$\begin{array}{c} X | \mathcal{C}^{\text{op}} c \\ \swarrow \quad \searrow \\ \mathbf{Set} \quad \bar{\alpha} \end{array} = \begin{array}{c} X | \\ \swarrow \quad \searrow \\ c \\ \tilde{\alpha} \end{array}, \quad (6.42)$$

where the black circle represents 1_c . The invertible map $\hat{C}(c^{\square}, X) \ni \tilde{\alpha} \mapsto \bar{\alpha} \in Xc$ obtained by this equation is clearly equal to the Yoneda map $\alpha_{X,c}$ defined by Eq. (3.43).

Supplement: Comparing Eqs. (6.36) and (6.42), it can be seen that P_d corresponds to c and θ^d corresponds to 1_c . Also, it can be seen that the map $\Phi_e: \tilde{\alpha} \mapsto \alpha$ (which is the map Φ_e mentioned in the proof of Lemma 6.29) corresponds to the Yoneda map $\alpha_{X,c}$. In mathematical notation, these maps are expressed as

$$\begin{array}{ccc} \hat{C}(\mathcal{D}(K-, d), \mathcal{E}(F-, e)) \ni \tilde{\alpha} & \xrightarrow{\Phi_e} & (\tilde{\alpha} \bullet P_d)\theta^d \in \text{Cocone}(F \bullet P_d, e), \\ \hat{C}(c^{\square}, X) \ni \tilde{\alpha} & \xrightarrow{\alpha_{X,c}} & (\tilde{\alpha} \bullet c)1_c \in Xc, \end{array}$$

where note that $(\tilde{\alpha} \bullet c)1_c = \tilde{\alpha}_c(1_c)$ holds. Also, Eq. (6.39) asserts that $\langle \mathcal{D}(K-, d), \theta^d \rangle$ is a left Kan extension of $\{*\} \bullet !: (K \downarrow d)^{\text{op}} \rightarrow \mathbf{Set}$ along $P_d: (K \downarrow d)^{\text{op}} \rightarrow \mathcal{C}^{\text{op}}$. This Kan extension is also pointwise since \mathbf{Set} is cocomplete. Applying $\langle c, p \rangle \in K \downarrow d$ from the right to both sides of Eq. (6.39) gives $\alpha_{\langle c, p \rangle} = \tilde{\alpha}_c(p)$, and thus $\tilde{\alpha} = \{\mathcal{D}(Kc, d) \ni p \mapsto \alpha_{\langle c, p \rangle} \in Xc\}_{c \in \mathcal{C}}$ holds. Note that the right-hand side of Eq. (6.33) can be depicted by

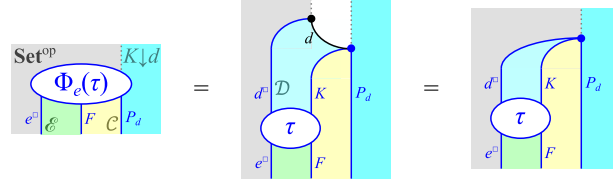

(where the black and blue circles represent 1_d and θ^d , respectively), which corresponds to the “upside-down” version of the equation on the right-hand side of the symbol “ $\stackrel{\text{equivalent}}{\iff}$ ” in Eq. (6.36).

6.3 Basic properties of Kan extensions

6.3.1 Functors preserving Kan extensions

As with the preservation of limits, we can consider the preservation of Kan extensions as follows. Consider a functor $S: \mathcal{E} \rightarrow \mathcal{F}$. When there exists a left Kan extension of $F: \mathcal{C} \rightarrow \mathcal{E}$ along $K: \mathcal{C} \rightarrow \mathcal{D}$, denoted by $\langle \text{Lan}_K F, \eta \rangle$, we say that S **preserves** the left Kan extension $\langle \text{Lan}_K F, \eta \rangle$ if $\langle S \bullet \text{Lan}_K F, S \bullet \eta \rangle$ is a left Kan extension of $S \bullet F$ along K . Also, we call S preserving any left Kan extension if it preserves the left Kan extensions of any functor $F: \mathcal{C} \rightarrow \mathcal{E}$ along any functor $K: \mathcal{C} \rightarrow \mathcal{D}$, where \mathcal{C} and \mathcal{D} are arbitrary. The preservation of right Kan extensions is defined as its dual.

Assume that there exists a left Kan extension $\langle \text{Lan}_K F, \eta \rangle$ of F along K and that S preserves this Kan extension; then, for any natural transformation $\sigma: S \bullet F \Rightarrow H \bullet K$ (where $H: \mathcal{D} \rightarrow \mathcal{F}$ is arbitrary), there exists a unique $\bar{\sigma}: S \bullet \text{Lan}_K F \Rightarrow H$ satisfying

where the blue circle represents η . This equation corresponds to Eqs. (6.2) and (6.4). The preservation of the left Kan extension $\langle \text{Lan}_K F, \eta \rangle$ by S can be represented by

where for any arbitrarily chosen left Kan extension $\langle \text{Lan}_K(S \bullet F), \eta' \rangle$ of $S \bullet F$ along K , η' is represented by the blue ellipse on the right-hand side. The diamond block represents the isomorphism $S \bullet \text{Lan}_K F \cong \text{Lan}_K(S \bullet F)$.

The following proposition holds:

Proposition 6.44: Any left adjoint preserves any left Kan extension. Dually, any right adjoint preserves any right Kan extension.

Since colimits are left Kan extensions and limits are right Kan extensions as mentioned in Example 6.6, this proposition can be regarded as a generalization of Theorem 5.18.

Proof. We show that for any adjunction $S \dashv T : \mathcal{E} \rightarrow \mathcal{F}$, S preserves any left Kan extension, denoted by $\langle \text{Lan}_K F, \eta \rangle$, of a functor $F : C \rightarrow \mathcal{E}$ along a functor $K : C \rightarrow \mathcal{D}$. We have for any natural transformation $\sigma : S \bullet F \Rightarrow H \bullet K$ (where $H : \mathcal{D} \rightarrow \mathcal{F}$ is arbitrary),

$$\begin{array}{c}
 \begin{array}{|c|c|c|} \hline H & \mathcal{D} & K \\ \hline \mathcal{F} & \sigma & C \\ \hline S & \mathcal{E} & F \\ \hline \end{array} & \stackrel{(4.6)}{=} & \begin{array}{|c|c|c|} \hline T & H & K \\ \hline S & \bar{\sigma} & C \\ \hline S & \mathcal{E} & F \\ \hline \end{array} & \stackrel{(6.2)}{=} & \begin{array}{|c|c|c|} \hline T & H & K \\ \hline S & \bar{\tau} & C \\ \hline S & \text{Lan}_K F & F \\ \hline \end{array} & \stackrel{(4.6)}{=} & \begin{array}{|c|c|c|} \hline H & & K \\ \hline S & \tau & C \\ \hline S & \text{Lan}_K F & F \\ \hline \end{array}
 \end{array}$$

where, in the first equality, we set the transpose of σ to $\bar{\sigma}$ (note that $S \bullet - \dashv T \bullet -$ holds). The second equality follows from applying Eq. (6.2) to $\bar{\sigma}$ (where we let $\bar{\tau}$ be $\bar{\sigma}$ on the right-hand side of Eq. (6.2)). The blue circle represents η . In the last equality, we set the transpose of $\bar{\tau}$ to τ . Since τ is uniquely determined from σ , $\langle S \bullet \text{Lan}_K F, S \bullet \eta \rangle$ is a left Kan extension of $S \bullet F$ along K . \square

6.3.2 Conditions for having a pointwise Kan extension

Corollary 6.45: Consider two functors $K : C \rightarrow \mathcal{D}$ and $F : C \rightarrow \mathcal{E}$, where C is a small category. If \mathcal{E} is cocomplete, then a pointwise left Kan extension of F along K exists. Dually, if \mathcal{E} is complete, then a pointwise right Kan extension of F along K exists.

Proof. Since C is small, for any $d \in \mathcal{D}$, the comma category $K \downarrow d$ is small. Thus, if \mathcal{E} is cocomplete, then for each $d \in \mathcal{D}$, a colimit of $F \bullet P_d$ exists. Therefore, a pointwise left Kan extension of F along K obviously exists from Theorem 6.20. \square

Lemma 6.46: If a functor $S : \mathcal{E} \rightarrow \mathcal{F}$ preserves any colimit, then S preserves any pointwise left Kan extension of any $F : C \rightarrow \mathcal{E}$ along any $K : C \rightarrow \mathcal{D}$.

Proof. Let $\langle L, \eta \rangle$ be any pointwise left Kan extension of F along K . For each $d \in \mathcal{D}$, let P_d be the forgetful functor from $K \downarrow d$ to C , and let $\mu^d := (L \bullet \theta^d)(\eta \bullet P_d)$ (see Eq. (6.15)); then, by Corollary 6.26, $\langle Ld, \mu^d \rangle$ is a colimit of $F \bullet P_d$. Since S preserves any colimit, $\langle S \bullet Ld, S \bullet \mu^d \rangle$ is a colimit of $S \bullet F \bullet P_d$. This colimit cocone $S \bullet \mu^d$ is depicted by

$$S \bullet \mu^d \xrightarrow{\text{diagram}} \begin{array}{|c|c|c|c|} \hline Ld & & & \\ \hline S & \mu^d & & \\ \hline \mathcal{F} & \mathcal{E} & F & P_d \\ \hline & & C & K \downarrow d \\ \hline \end{array} = \begin{array}{|c|c|c|} \hline \mathcal{D} & d & \\ \hline S & L & K \\ \hline & & P_d \\ \hline & & F \\ \hline \end{array}$$

and satisfies

$$\{S \bullet \mu_{\langle c, 1_{Kc} \rangle}^{Kc}\}_{c \in C} = S \bullet \eta$$

$$\xrightarrow{\text{diagram}} \left\{ \begin{array}{|c|c|c|c|} \hline Kc & & & \\ \hline S & L & K & P_{Kc} \\ \hline \mathcal{F} & \mathcal{E} & F & C \\ \hline & & & K \downarrow Kc \\ \hline \end{array} \right\}_{c \in C} = \left\{ \begin{array}{|c|c|c|} \hline L & & K \\ \hline S & & F \\ \hline & & c \\ \hline \end{array} \right\}_{c \in C} = \begin{array}{|c|c|c|} \hline L & & K \\ \hline S & & F \\ \hline & & c \\ \hline \end{array}$$

Thus, by Theorem 6.20, $\langle S \bullet L, S \bullet \eta \rangle$ is a pointwise left Kan extension of $S \bullet F$ along K . Therefore, S preserves $\langle L, \eta \rangle$. \square

Proposition 6.47: Consider three functors $K: \mathcal{C} \rightarrow \mathcal{D}$, $F: \mathcal{C} \rightarrow \mathcal{E}$, and $L: \mathcal{D} \rightarrow \mathcal{E}$. The following conditions are equivalent:

- (1) L is a pointwise left Kan extension of F along K .
- (2) L is a left Kan extension of F along K , and for any $e \in \mathcal{E}$, $e^\square: \mathcal{E} \rightarrow \mathbf{Set}^{\text{op}}$ preserves the left Kan extension L .
- (3) There exists an isomorphism

$$\mathcal{E}(Ld, e) \cong \hat{\mathcal{C}}(\mathcal{D}(K-, d), \mathcal{E}(F-, e)) \quad (6.48)$$

that is natural in $d \in \mathcal{D}$ and $e \in \mathcal{E}$.

Dually, the following conditions are equivalent:

- (1) R is a pointwise right Kan extension of F along K .
- (2) R is a right Kan extension of F along K , and for any $e \in \mathcal{E}$, $e^\square: \mathcal{E} \rightarrow \mathbf{Set}$ preserves the right Kan extension R .
- (3) There exists an isomorphism

$$\mathcal{E}(e, Rd) \cong \mathbf{Set}^{\mathcal{C}}(\mathcal{D}(d, K-), \mathcal{E}(e, F-))$$

that is natural in $d \in \mathcal{D}$ and $e \in \mathcal{E}$.

Proof. (1) \Rightarrow (2): From Corollary 5.20, e^\square preserves any colimit. Therefore, the case where S is e^\square in Lemma 6.46 makes it appear.

(2) \Rightarrow (3): We have for any $\sigma \in \hat{\mathcal{C}}(\mathcal{D}(K-, d), \mathcal{E}(F-, e))$,

Note that instead of $e^\square: \mathcal{E} \rightarrow \mathbf{Set}^{\text{op}}$, its dual $e^\square: \mathcal{E}^{\text{op}} \rightarrow \mathbf{Set}$ is used (the same applies to d^\square), and thus some parts of the diagram are “upside-down”. The right “ \mapsto ” is the Yoneda map mentioned in Corollary 3.42. The last expression (i.e., $\bar{\sigma}_d(1_d)$) is an element of $e^\square \bullet Ld = \mathcal{E}(Ld, e)$. Thus, the isomorphism in Eq. (6.48) is obtained. Naturality in d and e can be easily seen from Eq. (6.49); indeed, the structure of the equation will not change even if f^\square (where $f \in \mathcal{D}(d', d)$ is arbitrary) is applied from below to the position of the wire d^\square , and even if g^\square (where $g \in \mathcal{E}(e, e')$ is arbitrary) is applied from above to the position of the wire e^\square .

(3) \Rightarrow (1): For each $d \in \mathcal{D}$, $\mathcal{E}(Ld, -) \cong \text{Cocone}(F \bullet P_d, -)$ holds from Lemma 6.29, and thus, from Lemma 5.8, $F \bullet P_d$ has a colimit. Therefore, from Theorem 6.20, there exists a pointwise left Kan extension $\text{Lan}_K F$. This yields an isomorphism

$$\mathcal{E}(Ld, e) \cong \hat{\mathcal{C}}(\mathcal{D}(K-, d), \mathcal{E}(F-, e)) \cong \mathcal{E}((\text{Lan}_K F)d, e)$$

that is natural in $d \in \mathcal{D}$ and $e \in \mathcal{E}$. The right isomorphism follows from the fact that Eq. (6.48) with L replaced by $\text{Lan}_K F$ holds, which is obtained by “(1) \Rightarrow (3)”. Therefore, since $L \cong \text{Lan}_K F$ from Lemma 3.45, L is a pointwise left Kan extension of F along K . \square

We give another proof of “(1) \Rightarrow (3)” in Proposition 6.47. Let L be a pointwise left Kan extension of F along K ; then, by mapping both sides of Eq. (6.19) with the map Ψ_e of Eq. (6.35), it can be seen that for any natural transformation $\bar{\alpha} \in \hat{\mathcal{C}}(\mathcal{D}(K-, d), \mathcal{E}(F-, e))$ (where $d \in \mathcal{D}$ and

$e \in \mathcal{E}$ are arbitrary), there exists a unique morphism $\bar{\alpha} \in \mathcal{E}(Ld, e)$ satisfying

$$(6.50)$$

where the blue circle represents η . The area enclosed by the auxiliary line corresponds to a colimit cocone of $F \bullet P_d$. Equation (6.50) is essentially the same as Eq. (6.19). Note that it follows from Eq. (6.50) that it satisfies naturality in e since applying a morphism in \mathcal{E} from above to the wire e will not change the structure of the equation. Naturality in d is also easily shown by Eq. (6.50).

Equation (6.48) can be intuitively understood by representing it as (see also Eq. (6.31))

$$(6.51)$$

where the central expression should be thought of as a functor that maps $\langle d, e \rangle \in \mathcal{D}^{\text{op}} \times \mathcal{E}$ to $\hat{\mathcal{C}}(\mathcal{D}(K-, d), \mathcal{E}(F-, e))$. Note that in the case of $\mathcal{D} = \mathbf{1}$ and $K = !$, L is a colimit of F as mentioned in Example 6.6, in which case the first isomorphism of Eq. (6.51) corresponds to Eq. (5.10).

Example 6.52: Any colimit is a pointwise left Kan extension. Indeed, as stated in Example 6.6, a colimit of $F: C \rightarrow \mathcal{E}$ is a left Kan extension of F along $!$, and from Corollary 5.20, any $e^\square: \mathcal{E} \rightarrow \mathbf{Set}^{\text{op}}$ preserves any colimit, satisfying Condition (2) of Proposition 6.47.

A left (or right) Kan extension L of $F: C \rightarrow \mathcal{E}$ along $K: C \rightarrow \mathcal{D}$ is called **absolute** if any functor $H: \mathcal{E} \rightarrow \mathcal{F}$ (where \mathcal{F} is arbitrary) preserves L . Any absolute Kan extension is pointwise since this condition is stronger than Condition (2) of Proposition 6.47.

6.3.3 Dense functors

Let us consider a functor $K: C \rightarrow \mathcal{D}$. When the identity functor $1_{\mathcal{D}}$ is a pointwise left Kan extension of K along K (or equivalently, when a pointwise left Kan extension $\text{Lan}_K K$ exists and is naturally isomorphic to $1_{\mathcal{D}}$), K is called **dense**. As a dual concept, when $1_{\mathcal{D}}$ is a pointwise right Kan extension of K along K , K is called **codense**.

Proposition 6.53: For a functor $K: C \rightarrow \mathcal{D}$, the following are equivalent:

- (1) K is dense.
- (2) $\langle 1_{\mathcal{D}}, 1_K \rangle$ is a pointwise left Kan extension of K along K .
- (3) For each $d \in \mathcal{D}$, $\langle d, \theta^d \rangle$ is a colimit of $K \bullet P_d$ (where θ^d is the canonical cocone for $K \downarrow d$).

Proof. (1) \Rightarrow (2): Since K is dense, there exists some $\eta: K \Rightarrow K$ such that $\langle 1_{\mathcal{D}}, \eta \rangle$ is a pointwise left Kan extension of K along K . It suffices to show that η is a natural isomorphism, i.e., each component η_c ($c \in C$) is invertible. In fact, in this case, the natural transformation obtained by applying η^{-1} to η , i.e., 1_K , is also a universal morphism, so $\langle 1_{\mathcal{D}}, 1_K \rangle$ is a pointwise left Kan extension of K along K .

Let us arbitrarily choose $c \in \mathcal{C}$. Since $\langle 1_{\mathcal{D}}, \eta \rangle$ is a pointwise left Kan extension, there exists a unique $\phi \in \mathcal{D}(Kc, Kc)$ satisfying

(6.54)

where the blue circle represents the canonical cocone θ^{Kc} for $K \downarrow Kc$. The area enclosed by the auxiliary lines is denoted by μ , and the first equality follows from the universality of μ (note that μ is a colimit cocone of $K \bullet P_{Kc}$ by Corollary 6.26). Applying $\langle c, 1_{Kc} \rangle \in K \downarrow Kc$ from the right to the left and central expressions gives

(6.55)

Also, we have

Applying the universality of μ to the first and last expressions gives $\eta_c \phi = 1_{Kc}$. Therefore, from this equation and Eq. (6.55), η_c is invertible, and ϕ is its inverse.

(2) \Rightarrow (3): From Corollary 6.26 and $(1_{\mathcal{D}} \bullet \theta^d)(1_K \bullet P_d) = \theta^d$, $\langle d, \theta^d \rangle$ is a colimit of $K \bullet P_d$.

(3) \Rightarrow (1): From Theorem 6.20, there exists a unique functor $L: \mathcal{D} \rightarrow \mathcal{D}$ satisfying

(6.56)

where the left and right blue circles represent the canonical cocones $\theta^{d'}$ and θ^d for $K \downarrow d'$ and $K \downarrow d$, respectively, and L is a pointwise left Kan extension of K along K . Also, from Eq. (6.14), the equation obtained by substituting $L = 1_{\mathcal{D}}$ into Eq. (6.56) holds, so the uniquely determined L is $1_{\mathcal{D}}$. Therefore, $1_{\mathcal{D}}$ is a pointwise left Kan extension of K along K , and thus K is dense. \square

From this proposition, for a dense functor K , θ^d with each $d \in \mathcal{D}$ is a colimit cocone of $K \bullet P_d$. Thus, from the dual of Eq. (5.7), any colimit cocone of $K \bullet P_d$ can be expressed in the following

form

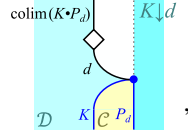

where the blue circle is θ^d . The diamond block represents the isomorphism $d \cong \text{colim}(K \bullet P_d)$.
 If K is dense, then from Eq. (6.48) with $F = K$ and $L = 1_{\mathcal{D}}$, there exists an isomorphism

$$\hat{C}(\mathcal{D}(K-, d), \mathcal{D}(K-, d')) \cong \mathcal{D}(d, d') \quad (6.57)$$

that is natural in $d \in \mathcal{D}$ and $d' \in \mathcal{D}$. Also, since, from Proposition 6.53, $\langle 1_{\mathcal{D}}, 1_K \rangle$ is a pointwise left Kan extension of K along K , the equation obtained by substituting $L = 1_{\mathcal{D}}$ and $\eta = 1_K$ into Eq. (6.50) yields that for any $\tau \in \hat{C}(\mathcal{D}(K-, d), \mathcal{D}(K-, d'))$, there exists a unique morphism $\bar{\tau} \in \mathcal{D}(d, d')$ satisfying

$$(6.58)$$

The one-to-one correspondence between τ and $\bar{\tau}$ obtained from Eq. (6.58) gives the isomorphism in Eq. (6.57).

6.3.4 Relationship with adjoints

We have already mentioned in Example 6.52 that limits and colimits are special cases of pointwise Kan extensions. Here, we show that left and right adjoints are also special cases of pointwise Kan extensions. In particular, they are absolute Kan extensions. We schematically represent these relationships in the following diagram:

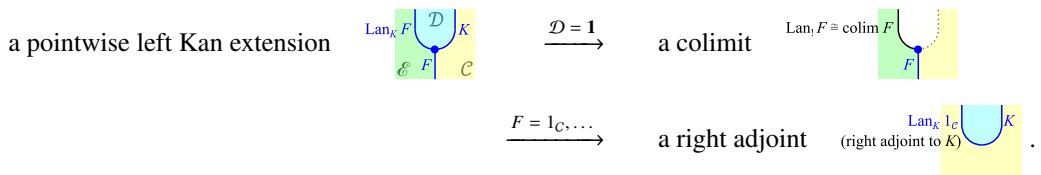

Proposition 6.59: For any adjunction $F \dashv G: C \rightarrow \mathcal{D}$ and its unit η , $\langle G, \eta \rangle$ is an absolute left Kan extension of 1_C along F .

Proof. For any $H: \mathcal{D} \rightarrow \mathcal{E}$, $L: C \rightarrow \mathcal{E}$ (where \mathcal{E} is arbitrary), and $\tau: L \Rightarrow H \bullet F$, there exists a unique $\bar{\tau}: L \bullet G \Rightarrow H$ satisfying

$$(6.60)$$

indeed, $\bar{\tau}$ is uniquely determined by

Therefore, by the definition of a left Kan extension, $\langle L \bullet G, L \bullet \eta \rangle$ is a left Kan extension of L along F . Note that the unit $L \bullet \eta$ of this Kan extension is enclosed by the auxiliary line in Eq. (6.60). In particular, by substituting $L = 1_C$, $\langle G, \eta \rangle$ is a left Kan extension of 1_C along F . This Kan extension is absolute since any L preserves it. \square

From this proposition, the right adjoint G to F , its unit η , and the left Kan extension $\langle \text{Lan}_F 1_C, \eta' \rangle$ are related as follows:

where the blue circle represents η' , and the diamond block represents $G \cong \text{Lan}_F 1_C$. Thus, $\langle G, \eta \rangle$ and $\langle \text{Lan}_F 1_C, \eta' \rangle$ can be identified.

The following proposition shows that the converse of Proposition 6.59 also holds (note that we have relaxed the conditions).

Proposition 6.61: If $\langle G, \eta \rangle$ is a left Kan extension of 1_C along a functor $F: C \rightarrow \mathcal{D}$, and if F preserves this left Kan extension, then G is a right adjoint to F , and η is the unit of this adjunction.

Proof. From Theorem 4.9, it suffices to show that there exists a natural transformation $\varepsilon: F \bullet G \Rightarrow 1_{\mathcal{D}}$ such that η and ε satisfy Eq. (zigzag). Since F preserves the left Kan extension $\langle G, \eta \rangle$, $\langle F \bullet G, F \bullet \eta \rangle$ is a left Kan extension of F along F . By the universal property of this Kan extension, there exists ε satisfying

(6.62)

where the unit $F \bullet \eta$ of this Kan extension is enclosed by the auxiliary line. Also, we obtain

By the universal property of the left Kan extension $\langle G, \eta \rangle$, the two natural transformations enclosed by the auxiliary lines must be equal. From this fact and Eq. (6.62), Eq. (zigzag) holds. \square

6.3.5 Monads derived from Kan extensions

Assume that for a functor $K: C \rightarrow \mathcal{D}$, there exists a right Kan extension $\langle T, \varepsilon \rangle$ of K along K . Let us define $\mu: T \bullet T \Rightarrow T$ and $\eta: 1_{\mathcal{D}} \Rightarrow T$ to satisfy

where the blue circles represent ε , and the hollow circles on the left- and right-hand sides of the comma represent μ and η , respectively. Note that for simplicity, we omit the label of the wire representing the functor $T: \mathcal{D} \rightarrow \mathcal{D}$ in diagrams. By the universal property of $\langle T, \varepsilon \rangle$ (see Eq. (6.3)), μ and η are uniquely determined. $\langle T, \mu, \eta \rangle$ is called a **codensity monad** of K .

Proposition 6.63: Any codensity monad is a monad^{*a}.

^{*a} $\langle T, \mu, \eta \rangle$ is called a **monad** if it satisfies the associativity law, i.e., $\mu(1_T \bullet \mu) = \mu(\mu \bullet 1_T)$, and the unit law, i.e., $\mu(1_T \bullet \eta) = 1_T = \mu(\eta \bullet 1_T)$.

Proof. Let $\langle T, \mu, \eta \rangle$ be a codensity monad of K . From

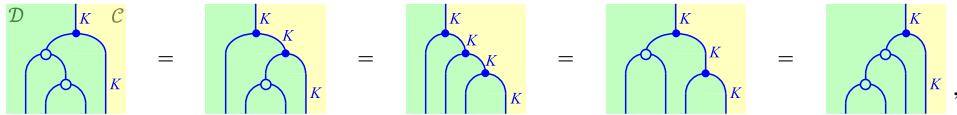

the universal property of $\langle T, \varepsilon \rangle$ gives the following associativity law:

$$\mu(1_T \bullet \mu) = \mu(\mu \bullet 1_T) \quad \text{diagram} \quad \begin{array}{c} \mathcal{D} \\ \text{---} \\ \text{---} \\ \text{---} \\ \text{---} \\ \text{---} \end{array} = \begin{array}{c} \text{---} \\ \text{---} \\ \text{---} \\ \text{---} \end{array} .$$

Also,

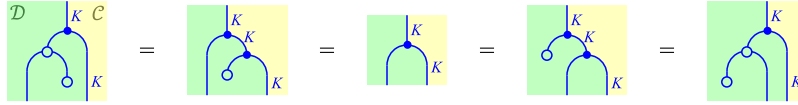

gives the following unit law:

$$\mu(1_T \bullet \eta) = 1_T = \mu(\eta \bullet 1_T) \quad \text{diagram} \quad \begin{array}{c} \mathcal{D} \\ \text{---} \\ \text{---} \\ \text{---} \\ \text{---} \end{array} = \begin{array}{c} \text{---} \\ \text{---} \\ \text{---} \end{array} = \begin{array}{c} \text{---} \\ \text{---} \\ \text{---} \\ \text{---} \end{array} .$$

Therefore, $\langle T, \mu, \eta \rangle$ is a monad. □

7 (Co)ends and weighted (co)limits

In this section, we mainly discuss (co)ends and weighted (co)limits, which can be viewed as generalizations of (co)limits in a certain sense. These concepts are also closely related to pointwise Kan extensions. We use string diagrams to illustrate some of the relationships between (co)limits, pointwise Kan extensions, (co)ends, and weighted (co)limits. String diagrams for (co)ends are also described in Refs. [3, 13, 14] and references cited therein. We propose a new representation method that allows us to perform (co)end calculations intuitively.

7.1 Diagrams for direct products

In this section, we mainly use the ‘‘expression for direct products’’ (recall Subsubsection 2.3.1). In this expression, for a morphism $f \in C(a, b)$ and a functor $F: C \rightarrow \mathcal{D}$, Ff is represented by the right-hand side of the following diagram:

$$\begin{array}{c} \mathcal{D} \quad \mathcal{C} \\ \text{---} \quad \text{---} \\ \text{---} \quad \text{---} \\ \text{---} \quad \text{---} \\ \text{---} \quad \text{---} \\ \text{---} \quad \text{---} \end{array} = \begin{array}{c} \text{---} \quad \text{---} \\ \text{---} \quad \text{---} \\ \text{---} \quad \text{---} \\ \text{---} \quad \text{---} \\ \text{---} \quad \text{---} \end{array} .$$

For a morphism $g \in C^{\text{op}}(b, a) = C(a, b)$ and a contravariant functor $G: C^{\text{op}} \rightarrow \mathcal{D}$, in the expression for direct products, we represent Gg by the right-hand side of the following diagram:

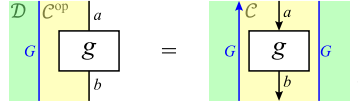

In the expression for direct products, we represent objects and morphisms in the opposite category C^{op} as “upside-down” versions of the corresponding objects and morphisms in C . For convenience, we label the category C^{op} with “ C ” in such expressions, but instead represent objects with downward-pointing arrows; we can distinguish whether it represents C or C^{op} from the direction of the arrows. For two blue arrows representing a functor $F: C \rightarrow \mathcal{D}$, its dual $F: C^{\text{op}} \rightarrow \mathcal{D}^{\text{op}}$ can be represented by vertically flipping the direction of the arrows.

Also, products are represented by placing elements side by side. For example, the product $\langle f, g \rangle \in \text{mor}(C^{\text{op}} \times C)$ of $f \in C^{\text{op}}(a, b)$ and $g \in C(c, d)$ is represented by



The gray dashed line representing the product “ \times ” can be omitted.

In summary, compared to the main expression, the expression for direct products has the following main differences:

- (1) It represents products (and tensor products, as will be shown in Subsection 7.4) by placing elements side by side.
- (2) It represents applying a functor by drawing two parallel arrows to the left and right.
- (3) It represents objects and functors with upward or downward arrows instead of wires. A category C and its opposite category C^{op} are distinguished by the direction of arrows.

We represent $C(a, b)$ as

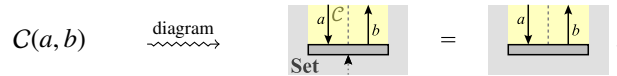

where the dotted arrow is a singleton set $\{*\} \in \mathbf{Set}$. Note that in this diagram, $C(a, b)$ is represented as a morphism from $\{*\}$ to $C(a, b)$. As shown on the right-hand side, dotted arrows representing $\{*\}$ are often omitted. The dark gray rectangle represents the hom-functor $C(-, -): C^{\text{op}} \times C \rightarrow \mathbf{Set}$, with $a^{\text{op}} \in C^{\text{op}}$ represented as an upside-down version of $a \in C$ with a downward arrow. For a contravariant functor $F: C^{\text{op}} \rightarrow \mathcal{D}$, $\mathcal{D}(Fc, d)$ can be represented by

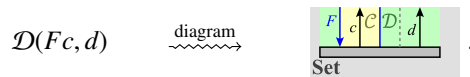

This diagram may be easier to understand if viewed as the mapping of $(Fc)^{\text{op}} \in \mathcal{D}^{\text{op}}$ through $\mathcal{D}(-, d): \mathcal{D}^{\text{op}} \rightarrow \mathbf{Set}$; the Fc part is vertically flipped.

Supplement: This representation enables us to easily depict properties, such as “returning to its original state after undergoing two upside-down flips”. Therefore, this representation will frequently prove valuable in subsequent discussions.

We represent $C(a, -)$ as the following two expressions:

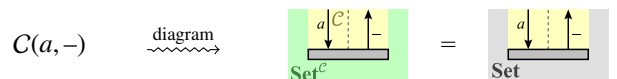

It could be more comprehensible if you think of it this way: $C(a, -)$ can be viewed as an element of \mathbf{Set}^C , as shown on the left-hand side of the diagram, and when viewed as a functor from C to \mathbf{Set} , it is represented as shown on the right-hand side.

7.2 Definition of (co)ends

7.2.1 Wedges and ends

Definition 7.2 (wedges): For an object $c \in C$ and a bifunctor $D: \mathcal{J}^{\text{op}} \times \mathcal{J} \rightarrow C$, a collection of morphisms $\alpha := \{\alpha_j: c \rightarrow D(j, j)\}_{j \in \mathcal{J}}$ in C is called a **wedge** from c to D , or simply a wedge to D , if it satisfies

$$D(i, h) \circ \alpha_i = D(h, j) \circ \alpha_j$$

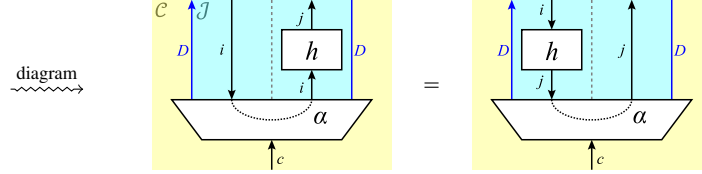

for any morphism $h \in \mathcal{J}(i, j)$. In diagrams, we represent the component α_j of the wedge α as

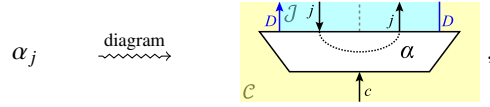

where a dotted semicircle is drawn inside the block.

We write $\text{Wedge}(c, D)$ for the collection of all wedges from c to D . For a bifunctor $D: \mathcal{J}^{\text{op}} \times \mathcal{J} \rightarrow C$, let us consider the following category:

- Its each object is a pair, $\langle c, \alpha \rangle$, of $c \in C$ and $\alpha \in \text{Wedge}(c, D)$.
- Its each morphism from an object $\langle c, \alpha \rangle$ to an object $\langle c', \alpha' \rangle$ is a morphism $f \in C(c, c')$ in C that satisfies $\alpha_j = \alpha'_j f$ for all $j \in \mathcal{J}$.
- The composite of its morphisms is the composite of morphisms in C , and its identity morphism is the identity morphism in C .

This category is called the **category of wedges** to D , and we write Wedge_D . Roughly speaking, Wedge_D is a category whose objects are wedges to D .

Definition 7.3 (ends): Consider a bifunctor $D: \mathcal{J}^{\text{op}} \times \mathcal{J} \rightarrow C$. A terminal object $\langle d, \kappa \rangle$ in Wedge_D is called an **end** of D . In other words, a pair, $\langle d, \kappa \rangle$, of an object $d \in C$ and a wedge $\kappa \in \text{Wedge}(d, D)$ is called an end of D if for any wedge $\alpha \in \text{Wedge}(c, D)$ (where $c \in C$ is also arbitrary), there exists a unique morphism $\bar{\alpha} \in C(c, d)$ satisfying

$$\alpha_j = \kappa_j \bar{\alpha}$$

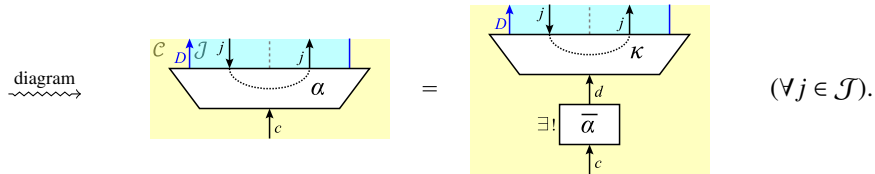

Sometimes d is simply called an end.

The end d is often written as $\int_{j \in \mathcal{J}} D(j, j)$. From the above universal property, $d \in \mathcal{D}$ is an end of D if and only if

$$C(-, d) \cong \text{Wedge}(-, D)$$

holds, where $\text{Wedge}(-, D): C^{\text{op}} \rightarrow \mathbf{Set}$ is a presheaf (in the case where $\text{Wedge}(c, D)$ is a set for each $c \in C$) defined as follows:

- It maps each object c in C^{op} to $\text{Wedge}(c, D)$.
- It maps each morphism $f \in C^{\text{op}}(b, a) = C(a, b)$ to the map (i.e., the morphism in \mathbf{Set}) $\text{Wedge}(b, D) \ni \{\alpha_j\}_{j \in \mathcal{J}} \mapsto \{\alpha_j f\}_{j \in \mathcal{J}} \in \text{Wedge}(a, D)$.

Example 7.4 (limits are ends): For a functor $D': \mathcal{J} \rightarrow C$, let $D: \mathcal{J}^{\text{op}} \times \mathcal{J} \rightarrow C$ be the bifunctor defined by $D(f, g) := D'(g)$ ($f \in \text{mor } \mathcal{J}^{\text{op}}, g \in \text{mor } \mathcal{J}$). Then, for any $c \in C$, a cone from c to D' is equivalent to a wedge from c to D , i.e., $\text{Cone}(c, D') = \text{Wedge}(c, D)$ holds. We can also readily obtain $\text{Cone}_{D'} = \text{Wedge}_D$. Furthermore, a limit of D' is equivalent to an end of D since the former is a terminal object in $\text{Cone}_{D'}$ while the latter is a terminal object in Wedge_D .

7.2.2 Cowedges and coends

Cowedges and coends can be defined as the duals of wedges and ends.

Definition 7.5 (cowedges): For an object $c \in C$ and a bifunctor $D: \mathcal{J}^{\text{op}} \times \mathcal{J} \rightarrow C$, a collection of morphisms $\alpha := \{\alpha_j: D(j, j) \rightarrow c\}_{j \in \mathcal{J}}$ in C is called a **cowedge** from D to c , or simply a cowedge from D , if it satisfies

$$\alpha_i \circ D(i, h) = \alpha_j \circ D(h, j)$$

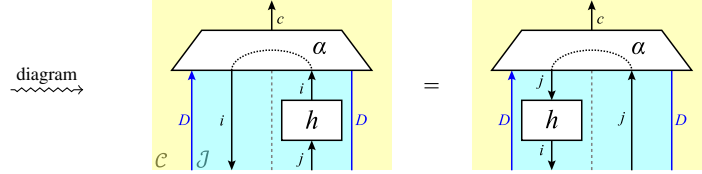

for any morphism $h \in \mathcal{J}(j, i)$. In diagrams, we represent the component α_j of the cowedge α as

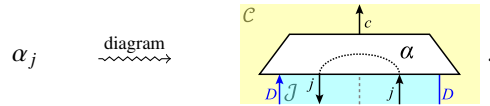

We write $\text{Cowedge}(D, c)$ for the collection of all cowedges from D to c . Also, the category defined as follows is called the **category of cowedges** from D , and we write Cowedge_D :

- Its each object is a pair, $\langle c, \alpha \rangle$, of $c \in C$ and $\alpha \in \text{Cowedge}(D, c)$.
- Its each morphism from an object $\langle c, \alpha \rangle$ to an object $\langle c', \alpha' \rangle$ is a morphism $f \in C(c, c')$ in C that satisfies $\alpha'_j = f \alpha_j$ for all $j \in \mathcal{J}$.
- The composite of its morphisms is the composite of morphisms in C , and its identity morphism is the identity morphism in C .

Definition 7.6 (coends): Consider a bifunctor $D: \mathcal{J}^{\text{op}} \times \mathcal{J} \rightarrow C$. An initial object $\langle d, \kappa \rangle$ in Cowedge_D is called a **coend** of D . In other words, a pair, $\langle d, \kappa \rangle$, of an object $d \in C$ and a cowedge $\kappa \in \text{Cowedge}(D, d)$ is called a coend of D if for any cowedge $\alpha \in \text{Cowedge}(D, c)$

(where $c \in C$ is also arbitrary), there exists a unique morphism $\bar{\alpha} \in C(d, c)$ satisfying

$$\alpha_j = \bar{\alpha}\kappa_j$$

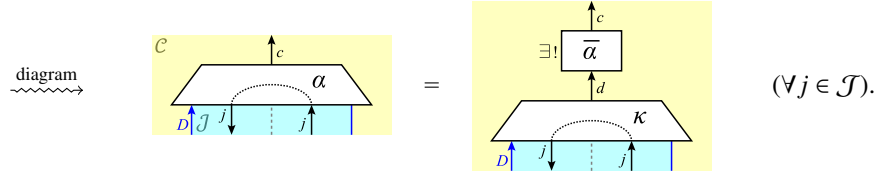

Sometimes d is simply called a coend.

The coend d is often written as $\int^{j \in \mathcal{J}} D(j, j)$. From the above universal property, $d \in \mathcal{D}$ is a coend of D if and only if

$$C(d, -) \cong \text{Cowedge}(D, -)$$

holds, where $\text{Cowedge}(D, -): C \rightarrow \mathbf{Set}$ is a functor (in the case where $\text{Cowedge}(D, c)$ is a set for each $c \in C$) defined similarly to $\text{Wedge}(-, D)$.

Example 7.7 (colimits are coends): Considering the dual of Example 7.4, we can see that any cocone is a cowedge and any colimit is a coend.

7.2.3 Diagrams for ends

For a bifunctor $D: \mathcal{J}^{\text{op}} \times \mathcal{J} \rightarrow C$, we represent its end and coend as

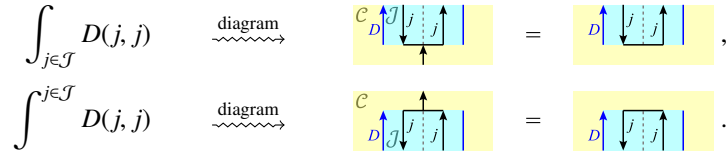

Note that they are objects in C that are independent of j . The black horizontal lines in the diagrams represent “ $\int_{j \in \mathcal{J}}$ ” and “ $\int^{j \in \mathcal{J}}$ ”. As shown on their right-hand sides, the arrows below the horizontal line representing “ $\int_{j \in \mathcal{J}}$ ” and above the horizontal line representing “ $\int^{j \in \mathcal{J}}$ ” are often omitted. Also, the label “ j ” in these diagrams is often omitted.

Consider a functor $D: \mathcal{J}^{\text{op}} \times \mathcal{J} \times \mathcal{D} \rightarrow C$. For any $d \in \mathcal{D}$, we can define a functor $D(-, -, d): \mathcal{J}^{\text{op}} \times \mathcal{J} \rightarrow C$ (recall Example 2.32). We represent an end of this functor as



Other (co)ends, such as $\int^{j \in \mathcal{J}} D(j, j, d)$ or $\int_{j \in \mathcal{J}} E(j, d, j, d')$, can also be considered similarly.

7.3 Basic properties of (co)ends

7.3.1 Properties of (co)ends as (co)limits

It is known that ends are special cases of limits, and coends are special cases of colimits (e.g., [7]). Therefore, properties that hold for (co)limits hold for (co)ends. Also, concepts related to (co)limits, such as their preservation, can be applied directly to (co)ends. Here, we provide several examples.

For each $c \in C$, $\square^c = C(c, -)$ preserves any limit (recall Theorem 5.19), so it preserves any end. That is, for any $c \in C$ and bifunctor $D: \mathcal{J}^{\text{op}} \times \mathcal{J} \rightarrow C$,

$$C\left(c, \int_{j \in \mathcal{J}} D(j, j)\right) \cong \int_{j \in \mathcal{J}} C(c, D(j, j))$$

(7.8)

holds. Note that the area enclosed by the auxiliary line represents the bifunctor $C(c, D(-, =))$. Since an end is a limit, this isomorphism is natural in c and D . In Eq. (7.8), there are short horizontal lines attached to arrows representing c and D , which indicate that the isomorphism is natural in c and D . In what follows, we use such expressions to represent naturality. Intuitively, this diagram can be interpreted as allowing the horizontal solid line representing “ $\int_{j \in \mathcal{J}}$ ” to freely pass through the dark gray rectangle representing the hom-functor $C(-, =)$.

As the dual of Eq. (7.8), $c^\square = C(-, c)$ preserves any colimit (recall Corollary 5.20), so it preserves any coend. That is,

$$C\left(\int^{j \in \mathcal{J}} D(j, j), c\right) \cong \int_{j \in \mathcal{J}} C(D(j, j), c)$$

(7.9)

holds^{‡18}. Note that by representing the coend $\int^{j \in \mathcal{J}} D(j, j)$ as an “upside-down” version, we intuitively show how a coend is transformed into an end.

Also, if a category C is complete, then for any small categories \mathcal{I} and \mathcal{J} and any functor $D: \mathcal{I}^{\text{op}} \times \mathcal{I} \times \mathcal{J}^{\text{op}} \times \mathcal{J} \rightarrow C$,

$$\int_{i \in \mathcal{I}} \int_{j \in \mathcal{J}} D(i, i, j, j) \cong \int_{j \in \mathcal{J}} \int_{i \in \mathcal{I}} D(i, i, j, j)$$

(7.10)

holds, where $D_{\mathcal{I}} := \int_{j \in \mathcal{J}} D(-, -, j, j)$ and $D_{\mathcal{J}} := \int_{i \in \mathcal{I}} D(i, i, -, -)$. Note that the gray dashed lines in the horizontal direction are natural isomorphisms. This isomorphism justifies that both the left- and right-hand sides of Eq. (7.10) are represented by

$$\int_{i \in \mathcal{I}} \int_{j \in \mathcal{J}} D(i, i, j, j)$$

7.3.2 Collections of natural transformations are ends

The following lemma is known to hold (the proof is omitted; see, e.g., [7]).

^{‡18}Although the formula does not demonstrate that this isomorphism is natural in D and c , this information is illustrated in the diagram.

Lemma 7.11: Assume that \mathcal{D}^C is locally small. We have for any two functors $F, G: C \rightarrow \mathcal{D}$,

$$\mathcal{D}^C(F, G) \cong \int_{c \in C} \mathcal{D}(Fc, Gc) \quad \text{diagram} \quad \begin{array}{c} \mathcal{D}^C \\ \downarrow F \quad \uparrow G \\ \text{Set} \end{array} \cong \begin{array}{c} F \quad C \quad \mathcal{D} \quad G \\ \downarrow \quad \downarrow \quad \downarrow \quad \downarrow \\ \text{Set} \end{array} . \quad (7.12)$$

Using this lemma, for objects c, d in C and a functor $F: C \rightarrow \mathbf{Set}$, the Yoneda lemma can be represented as

$$\int_{c \in C} \mathbf{Set}(C(d, c), Fc) \cong Fd \quad \text{diagram} \quad \begin{array}{c} \text{Set} \\ \downarrow d \quad \uparrow F \\ \text{Set} \end{array} \cong \begin{array}{c} F \quad d \end{array} . \quad (7.13)$$

Equation (7.13) may be more visually intuitive when interpreted as the following picture (which is not a strict diagram):

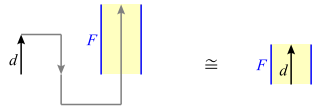

Also, considering the dual, we have for a presheaf $G: C^{\text{op}} \rightarrow \mathbf{Set}$,

$$\int_{c \in C} \mathbf{Set}(C(c, d), Gc) \cong Gd \quad \text{diagram} \quad \begin{array}{c} \text{Set} \\ \downarrow c \quad \uparrow G \\ \text{Set} \end{array} \cong \begin{array}{c} G \quad d \end{array} ,$$

which can also be expressed as

$$\hat{C}(C^{\square}, G) \cong G \quad \text{diagram} \quad \begin{array}{c} c \quad -c \quad \hat{c} \quad G \\ \downarrow \quad \downarrow \quad \downarrow \quad \downarrow \\ \text{Set} \end{array} \cong \begin{array}{c} G \end{array} . \quad (7.14)$$

7.4 (Co)tensor products

7.4.1 Definition of (co)tensor products

As a preliminary, we introduce (co)tensor products. For a set X and an object $c \in C$, if there exists an object, denoted by $X \otimes c$, in C such that

$$C(X \otimes c, c') \cong \mathbf{Set}(X, C(c, c')) \quad (7.15)$$

is natural in c' , then $X \otimes c$ is called a **tensor product** (or copower) of X and c . Also, if there exists a functor $\otimes: \mathbf{Set} \times C \rightarrow C$ that maps $\langle X, c \rangle \in \mathbf{Set} \times C$ to $X \otimes c \in C$ such that Eq. (7.15) is natural in X, c, c' , then \otimes is called the tensor product. We have for any $X \in \mathbf{Set}$ and $c \in C$, $X \otimes c \cong \coprod_{x \in X} c$ (where \coprod is the coproduct). Therefore, if C is cocomplete, then C has any tensor product. In particular, for $C = \mathbf{Set}$, $X \otimes c \cong X \times c$ holds. If C has any tensor product, then for each $c \in C$, $C(c, -)$ has a left adjoint $- \otimes c$.

The dual of a tensor product can also be considered. Specifically, for a set X and an object $c' \in C$, if there exists an object, denoted by $X \pitchfork c'$, in C such that

$$C(c, X \pitchfork c') \cong \mathbf{Set}(X, C(c, c')) \quad (7.16)$$

is natural in c , then $X \pitchfork c'$ is called a **cotensor product** (or power) of X and c' . Also, if there exists a functor $\pitchfork: \mathbf{Set}^{\text{op}} \times C \rightarrow C$ that maps $\langle X, c' \rangle \in \mathbf{Set}^{\text{op}} \times C$ to $X \pitchfork c' \in C$ such that Eq. (7.16) is natural in X, c, c' , then \pitchfork is called the cotensor product. We have for any $X \in \mathbf{Set}$ and $a \in C$, $X \pitchfork a \cong \prod_{x \in X} a$ (where \prod is the direct product). Therefore, if C is complete, then C has any cotensor product. In particular, for $C = \mathbf{Set}$, $X \pitchfork a \cong a^X := \mathbf{Set}(X, a)$ holds.

Consider the tensor product $\otimes: \mathbf{Set} \times C \rightarrow C$ and the cotensor product $\pitchfork: \mathbf{Set}^{\text{op}} \times C \rightarrow C$. Like direct products (see Eq. (7.1)), we represent (co)tensor products by placing elements side by side. However, unlike direct products, we do not insert dashed lines. Specifically, for $X \in \mathbf{Set}$ and $c \in C$, we represent $X \otimes c$ and $X \pitchfork c$ by

$$X \otimes c \quad \xrightarrow{\text{diagram}} \quad \begin{array}{|c|} \hline X \\ \hline \end{array} \begin{array}{|c|} \hline C \\ \hline \end{array} \begin{array}{|c|} \hline c \\ \hline \end{array} \begin{array}{|c|} \hline c \\ \hline \end{array}, \quad X \pitchfork c \quad \xrightarrow{\text{diagram}} \quad \begin{array}{|c|} \hline X \\ \hline \end{array} \begin{array}{|c|} \hline C \\ \hline \end{array} \begin{array}{|c|} \hline c \\ \hline \end{array}.$$

Note that X is an object in \mathbf{Set} , not in C . If C has any tensor product and cotensor product, then from Eqs. (7.15) and (7.16), there exists an isomorphism

$$C(X \otimes c, c') \cong \mathbf{Set}(X, C(c, c')) \cong C(c, X \pitchfork c')$$
(7.17)

that is natural in $X \in \mathbf{Set}$ and $c, c' \in C$. In particular, when $C = \mathbf{Set}$, the first isomorphism of Eq. (7.17) is equivalent to

$$\mathbf{Set}(X \times Y, Z) \cong \mathbf{Set}(X, Z^Y)$$
(7.18)

7.4.2 Topics related to (co)tensor products

(1) Expressions of pointwise Kan extensions by (co)tensor products

Proposition 7.19: Consider two functors $K: C \rightarrow D$ and $F: C \rightarrow E$, where C is small. If E is cocomplete, then a pointwise left Kan extension $\text{Lan}_K F$ exists and satisfies

$$\text{Lan}_K F \cong \int^{c \in C} \mathcal{D}(Kc, -) \otimes Fc$$
(7.20)

Dually, if E is complete, then a pointwise right Kan extension $\text{Ran}_K F$ exists and satisfies

$$\text{Ran}_K F \cong \int_{c \in C} \mathcal{D}(-, Kc) \pitchfork Fc$$

Proof. From Corollary 6.45, a pointwise left Kan extension $\text{Lan}_K F$ exists. Also, we have

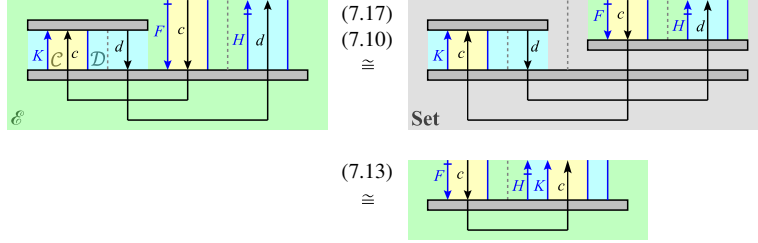

whose mathematical notation is

$$\begin{aligned}
 \int_{d \in \mathcal{D}} \mathcal{E} \left(\int^{c \in \mathcal{C}} \mathcal{D}(Kc, d) \otimes Fc, Hd \right) &\stackrel{(7.9)}{\cong} \int_{d \in \mathcal{D}} \int_{c \in \mathcal{C}} \mathcal{E}(\mathcal{D}(Kc, d) \otimes Fc, Hd) \\
 &\stackrel{(7.17)}{\cong} \int_{d \in \mathcal{D}} \int_{c \in \mathcal{C}} \mathbf{Set}(\mathcal{D}(Kc, d), \mathcal{E}(Fc, Hd)) \\
 &\stackrel{(7.10)}{\cong} \int_{c \in \mathcal{C}} \int_{d \in \mathcal{D}} \mathbf{Set}(\mathcal{D}(Kc, d), \mathcal{E}(Fc, Hd)) \\
 &\stackrel{(7.13)}{\cong} \int_{c \in \mathcal{C}} \mathcal{E}(Fc, H(Kc)).
 \end{aligned}$$

Therefore, from Eq. (7.12), there exists an isomorphism

$$\mathcal{E}^{\mathcal{D}} \left(\int^{c \in \mathcal{C}} \mathcal{D}(Kc, -) \otimes Fc, H \right) \cong \mathcal{E}^{\mathcal{C}}(F, H \bullet K)$$

that is natural in F and H . Thus, from Eq. (6.8), Eq. (7.20) holds. \square

Note that Proposition 6.47 asserts that if a functor $L: \mathcal{D} \rightarrow \mathcal{E}$ is a pointwise left Kan extension of F along K , then the isomorphism

$$\mathcal{E}(Ld, e) \cong \hat{\mathcal{C}}(\mathcal{D}(K-, d), \mathcal{E}(F-, e))$$

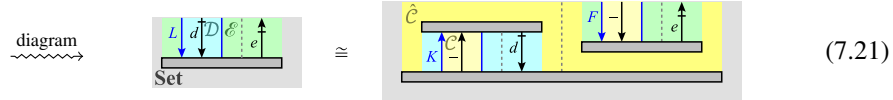

is natural in d and e . It can be seen that Eq. (7.21) is obtained by applying $\mathcal{E}(-, e)$ to Eq. (7.20).

(2) The co-Yoneda lemma

Corollary 7.22 (the co-Yoneda lemma): We have for objects c, d in a small category \mathcal{C} and a functor $F: \mathcal{C} \rightarrow \mathbf{Set}$,

$$\int^{c \in \mathcal{C}} \mathcal{C}(c, d) \times Fc \cong Fd \cong \int^{c \in \mathcal{C}} Fc \times \mathcal{C}(c, d)$$

diagram \rightsquigarrow \cong \cong (7.23)

Proof. It is sufficient to show the first isomorphism since the right-hand side is simply a rearrangement of the direct product on the left-hand side. This can be easily seen by considering the case of $\mathcal{D} = \mathcal{C}$, $\mathcal{E} = \mathbf{Set}$, and $K = 1_{\mathcal{C}}$ in Proposition 7.19. Indeed, since \mathbf{Set} is cocomplete, $\text{Lan}_{1_{\mathcal{C}}} F$ exists and satisfies Eq. (7.20). Thus, from $\text{Lan}_{1_{\mathcal{C}}} \cong 1_{\mathbf{Set}^{\mathcal{C}}}$, we obtain Eq. (7.23). \square

Equation (7.23) can be rewritten as

$$\int^{c \in C} \square^c \times Fc \cong F \cong \int^{c \in C} Fc \times \square^c.$$

Dually, the following corollary holds.

Corollary 7.24 (the co-Yoneda lemma): We have that for objects c, d in a small category C and a presheaf $G: C^{\text{op}} \rightarrow \mathbf{Set}$,

$$\int^{c \in C} C(d, c) \times Gc \cong Gd \cong \int^{c \in C} Gc \times C(d, c)$$

(7.25)

Equation (7.25) can be rewritten as

$$\int^{c \in C} c^\square \times Gc \cong G \cong \int^{c \in C} Gc \times c^\square. \quad (7.26)$$

Proposition 7.27: Consider any functor $K: C \rightarrow \mathcal{D}$, where C is small; then, we have

$$(\text{Lan}_K C^\square)d \cong \mathcal{D}(K-, d)$$

(7.28)

Since \hat{C} is cocomplete^{‡19}, a pointwise left Kan extension $\text{Lan}_K C^\square$ always exists (recall Corollary 6.45).

Proof. The proof is immediate from

$$\hat{C} \uparrow \mathcal{D} \uparrow d \uparrow \text{Lan}_K C^\square \cong \int^{c \in C} Cc \uparrow Kc \uparrow d \uparrow c^\square = \int^{c \in C} Kc \uparrow c \uparrow d \uparrow c^\square \cong \int^{c \in C} Kc \uparrow c \uparrow d \uparrow c^\square,$$

(7.25)

whose mathematical notation is

$$(\text{Lan}_K C^\square)d \stackrel{(7.20)}{\cong} \int^{c \in C} \mathcal{D}(Kc, d) \otimes C^\square(c) = \int^{c \in C} \mathcal{D}(Kc, d) \times c^\square \stackrel{(7.26)}{\cong} \mathcal{D}(K-, d).$$

□

Corollary 7.29: For a small category C , the Yoneda embedding C^\square is dense.

^{‡19}This can be easily seen by substituting C^{op} and \mathbf{Set} for \mathcal{I} and C , respectively, in Corollary 5.29 and using the fact that \mathbf{Set} is cocomplete.

Proof. We have $\text{Lan}_{C^\square} C^\square \cong 1_C$ since we have for any $X \in \hat{C}$,

$$\text{Lan}_{C^\square} C^\square \cong \hat{C}(C^\square, X) \cong X, \quad (7.28) \quad (7.14)$$

whose mathematical notation is

$$(\text{Lan}_{C^\square} C^\square)X \cong \hat{C}(C^\square, X) \cong X.$$

□

(3) The category of presheaves is cartesian closed

Proposition 7.30: For a small category C , the category of presheaves \hat{C} is cartesian closed^{‡a}.

^{‡a}A category \mathcal{D} is called **cartesian closed** if it has any finite product and there exists an exponential object b^a for each $a, b \in \mathcal{D}$. An exponential object b^a is an object satisfying $\mathcal{D}(-, b^a) \cong \mathcal{D}(- \times a, b)$.

Proof. Since \hat{C} is complete^{‡20}, it has any finite product. Therefore, it suffices to show that for each two presheaves $F, G \in \hat{C}$, there exists an exponential object G^F , i.e., an object G^F satisfying

$$\hat{C}(-, G^F) \cong \hat{C}(- \times F, G) \quad \text{diagram} \quad \cong \quad \text{diagram} \quad (7.31)$$

We define G^F as a presheaf satisfying^{‡21}

$$G^F(-) = \hat{C}(-^\square \times F, G). \quad (7.32)$$

Then, Eq. (7.31) is obtained from

$$\begin{aligned} \text{diagram} &\stackrel{(7.32)}{\cong} \text{diagram} \stackrel{(7.9)}{\cong} \text{diagram} \\ &\stackrel{(7.17)}{\cong} \text{diagram} \stackrel{(7.12)}{\cong} \text{diagram} \\ &\stackrel{(7.25)}{\cong} \text{diagram} \end{aligned}$$

^{‡20}This can be shown in the same way as footnote ‡19 using the fact that **Set** is complete.
^{‡21}If an exponential object G^F exists, then there must exist an isomorphism $G^F(c) \cong \hat{C}(c^\square, G^F) \cong \hat{C}(c^\square \times F, G)$ that is natural in c , where the first isomorphism is due to the Yoneda lemma (see Corollary 3.42). Therefore, G^F must be defined to satisfy Eq. (7.32).

whose mathematical notation is

$$\begin{aligned}
\int_{c \in \mathcal{C}} \mathbf{Set}(Hc, G^F c) &\stackrel{(7.32)}{\cong} \int_{c \in \mathcal{C}} \mathbf{Set}(Hc, \hat{\mathcal{C}}(c^\square \times F, G)) \\
&\stackrel{(7.17)}{\cong} \int_{c \in \mathcal{C}} \hat{\mathcal{C}}(Hc \otimes (c^\square \times F), G) \\
&\stackrel{(7.9)}{\cong} \hat{\mathcal{C}}\left(\int^{c \in \mathcal{C}} Hc \otimes (c^\square \times F), G\right) \\
&\stackrel{(7.12)}{\cong} \int_{d \in \mathcal{C}^{\text{op}}} \mathbf{Set}\left(\int^{c \in \mathcal{C}} Hc \times C(d, c) \times Fd, Gd\right) \\
&\stackrel{(7.25)}{\cong} \int_{d \in \mathcal{C}^{\text{op}}} \mathbf{Set}(Hd \times Fd, Gd).
\end{aligned}$$

Note that in this diagram, the dashed line representing the product $c^\square \times F$ is omitted. \square

(4) Adjunctions between the category of presheaves

It can be shown that for a small category \mathcal{C} , any adjunction $F \dashv G: \hat{\mathcal{C}} \rightarrow \mathcal{D}$ can be expressed using a certain Kan extension (see Proposition 7.34), and the converse also holds (see Proposition 7.33).

Proposition 7.33: Consider a functor $K: \mathcal{C} \rightarrow \mathcal{D}$, where \mathcal{C} is small. If a pointwise left Kan extension $F := \text{Lan}_{\mathcal{C}^\square} K: \hat{\mathcal{C}} \rightarrow \mathcal{D}$ exists, then $F \dashv \text{Lan}_K \mathcal{C}^\square$ holds.

Proof. Since $\hat{\mathcal{C}}$ is cocomplete, a pointwise left Kan extension $G := \text{Lan}_K \mathcal{C}^\square$ exists (recall Corollary 6.45). $F \dashv G$ holds since we have

$$\begin{array}{ccc}
\begin{array}{c} \text{Set} \\ \hline \begin{array}{c} F \\ \downarrow \\ X \\ \downarrow \\ \hat{\mathcal{C}} \\ \downarrow \\ \mathcal{D} \\ \downarrow \\ d \end{array} \end{array} & \stackrel{(7.21)}{\cong} & \begin{array}{c} \begin{array}{c} \text{---} \\ \downarrow \\ c^\square \\ \downarrow \\ \mathcal{C} \\ \downarrow \\ X \end{array} \\ \hline \begin{array}{c} K \\ \downarrow \\ \mathcal{D} \\ \downarrow \\ d \end{array} \end{array} & \stackrel{(7.14)}{\cong} & \begin{array}{c} \begin{array}{c} \text{---} \\ \downarrow \\ X \\ \downarrow \\ G \\ \downarrow \\ d \end{array} \end{array}, \\
& & \stackrel{(7.28)}{\cong} & &
\end{array}$$

whose mathematical notation is

$$\mathcal{D}(FX, d) \stackrel{(7.21)}{\cong} \hat{\mathcal{C}}(\hat{\mathcal{C}}(\mathcal{C}^\square -, X), \mathcal{D}(K-, d)) \stackrel{(7.14)}{\cong} \hat{\mathcal{C}}(X, \mathcal{D}(K-, d)) \stackrel{(7.28)}{\cong} \hat{\mathcal{C}}(X, Gd).$$

\square

Proposition 7.34: Consider an adjunction $F \dashv G: \hat{\mathcal{C}} \rightarrow \mathcal{D}$, where \mathcal{C} is small. There exists a functor $K: \mathcal{C} \rightarrow \mathcal{D}$ satisfying $F \cong \text{Lan}_{\mathcal{C}^\square} K$ and $G \cong \text{Lan}_K \mathcal{C}^\square$.

Intuitively, the functor K can be said to have information about both F and G .

Proof. Let $K := F \bullet \mathcal{C}^\square$. From $\text{Lan}_{\mathcal{C}^\square} \mathcal{C}^\square \cong 1_{\hat{\mathcal{C}}}$ (recall Corollary 7.29) and the fact that the left adjoint F preserves any left Kan extension (recall Proposition 6.44), we obtain

$$F \cong F \bullet \text{Lan}_{\mathcal{C}^\square} \mathcal{C}^\square \cong \text{Lan}_{\mathcal{C}^\square}(F \bullet \mathcal{C}^\square) \cong \text{Lan}_{\mathcal{C}^\square} K.$$

For each $X \in \hat{\mathcal{C}}$, let P_X be the forgetful functor from $\mathcal{C}^\square \downarrow X$ to \mathcal{C} ; then, $\mathcal{C}^\square \bullet P_X: \mathcal{C}^\square \downarrow X \rightarrow \hat{\mathcal{C}}$ has a colimit since $\hat{\mathcal{C}}$ is cocomplete. Thus, $F \bullet \mathcal{C}^\square \bullet P_X = K \bullet P_X$ also has a colimit since the left adjoint F preserves any colimit (recall Theorem 5.18). Therefore, the Kan extension $F \cong \text{Lan}_{\mathcal{C}^\square} K$ is pointwise, and thus from Proposition 7.33, $\text{Lan}_K \mathcal{C}^\square$ is a right adjoint to F . Since right adjoints are essentially unique, we have $G \cong \text{Lan}_K \mathcal{C}^\square$. \square

7.5 Weighted (co)limits

Weighted (co)limits can be considered as generalizations of (co)limits and (co)ends.

7.5.1 Definition of weighted (co)limits

Definition 7.35 (weighted (co)limits): Arbitrarily choose two functors $W: C \rightarrow \mathbf{Set}$ and $F: C \rightarrow \mathcal{E}$. An object, denoted by $\lim^W F$, in \mathcal{E} is called a **limit of F weighted by W** if the isomorphism

$$\mathcal{E}(e, \lim^W F) \cong \mathbf{Set}^C(W, \mathcal{E}(e, F-))$$

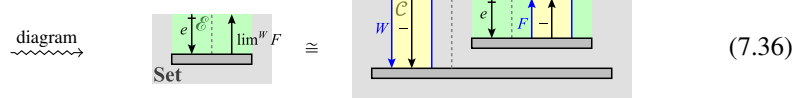
diagram  (7.36)

is natural in $e \in \mathcal{E}$. Dually, arbitrarily choose a presheaf $W': C^{\text{op}} \rightarrow \mathbf{Set}$. An object, denoted by $\text{colim}^{W'} F$, in \mathcal{E} is called a **colimit of F weighted by W'** if the isomorphism

$$\mathcal{E}(\text{colim}^{W'} F, e) \cong \hat{C}(W', \mathcal{E}(F-, e))$$

diagram 

is natural in $e \in \mathcal{E}$.

Example 7.37: A limit of F is a limit of F weighted by $\Delta_C\{*\}$, where $\{*\}$ is a singleton set. Indeed, we have

$$\mathcal{E}(e, \lim F) \cong \text{Cone}(e, F) \cong \text{Cone}(\{*\}, \mathcal{E}(e, F-)) \cong \mathbf{Set}^C(\Delta_C\{*\}, \mathcal{E}(e, F-)),$$

where the first and second isomorphisms follow from Eqs. (5.9) and (5.12), respectively. Dually, a colimit of F is a colimit of F weighted by $\Delta_{C^{\text{op}}}\{*\}$.

In particular, when $\mathcal{E} = \mathbf{Set}$, we have

$$\lim^W F \cong \mathbf{Set}^C(W, F). \quad (7.38)$$

Indeed, we have for any $X \in \mathbf{Set}$

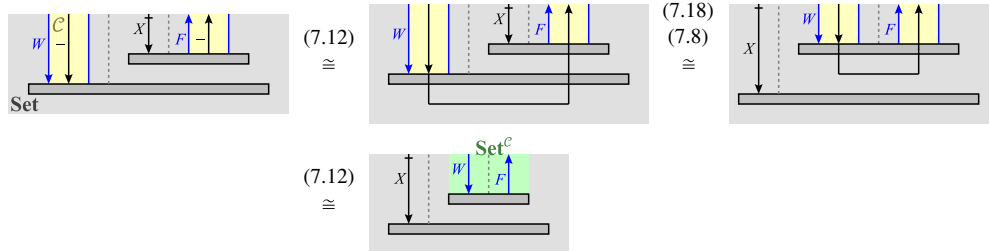
$$\begin{aligned} \text{Set}^C(W-, \text{Set}(X, F-)) &\stackrel{(7.12)}{\cong} \int_{c \in C} \text{Set}(Wc, \text{Set}(X, Fc)) &\stackrel{(7.18)}{\cong} \int_{c \in C} \text{Set}(X, \text{Set}(Wc, Fc)) \\ &\stackrel{(7.8)}{\cong} \text{Set}\left(X, \int_{c \in C} \text{Set}(Wc, Fc)\right) &\stackrel{(7.12)}{\cong} \text{Set}(X, \text{Set}^C(W, F)), \end{aligned}$$

whose mathematical notation is

$$\begin{aligned} \text{Set}^C(W-, \text{Set}(X, F-)) &\stackrel{(7.12)}{\cong} \int_{c \in C} \text{Set}(Wc, \text{Set}(X, Fc)) &\stackrel{(7.18)}{\cong} \int_{c \in C} \text{Set}(X, \text{Set}(Wc, Fc)) \\ &\stackrel{(7.8)}{\cong} \text{Set}\left(X, \int_{c \in C} \text{Set}(Wc, Fc)\right) &\stackrel{(7.12)}{\cong} \text{Set}(X, \text{Set}^C(W, F)), \end{aligned}$$

and thus we obtain Eq. (7.38) from Eq. (7.36).

7.5.2 Basic properties of weighted (co)limits

(1) Weighted (co)limits are (co)ends

Proposition 7.39: Consider two functors $W: C \rightarrow \mathbf{Set}$ and $F: C \rightarrow \mathcal{E}$, where C is small. We have

$$\lim^W F \cong \int_{c \in C} Wc \pitchfork Fc \quad \xrightarrow{\text{diagram}} \quad \lim^W F \uparrow^{\mathcal{E}} \cong \int_{c \in C} Wc \downarrow Fc \quad (7.40)$$

whenever the cotensor products $Wc \pitchfork Fc$ exist. Dually, consider two functors $W': C^{\text{op}} \rightarrow \mathbf{Set}$ and $F: C \rightarrow \mathcal{E}$, where C is small. We have

$$\text{colim}^{W'} F \cong \int^{c \in C} W'c \otimes Fc \quad \xrightarrow{\text{diagram}} \quad \text{colim}^{W'} F \uparrow^{\mathcal{E}} \cong \int^{c \in C} W'c \downarrow Fc \quad (7.41)$$

whenever the tensor products $W'c \otimes Fc$ exist.

Proof. We have

$$\int_{c \in C} Wc \pitchfork Fc \quad (7.12) \quad \cong \quad \int_{c \in C} Wc \downarrow Fc \quad (7.17) \quad \cong \quad \int_{c \in C} Wc \pitchfork Fc$$

whose mathematical notation is

$$\begin{aligned} \mathbf{Set}^C(W-, \mathcal{E}(e, F-)) &\stackrel{(7.12)}{\cong} \int_{c \in C} \mathbf{Set}(Wc, \mathcal{E}(e, Fc)) \stackrel{(7.17)}{\cong} \int_{c \in C} \mathcal{E}(e, Wc \pitchfork Fc) \\ &\stackrel{(7.8)}{\cong} \mathcal{E}\left(e, \int_{c \in C} Wc \pitchfork Fc\right). \end{aligned}$$

Thus, from the definition of weighted limits, we have Eq. (7.40). \square

(2) Ends are weighted limits

Proposition 7.42: We have that for any bifunctor $F: C^{\text{op}} \times C \rightarrow \mathcal{D}$,

$$\int_{c \in C} F(c, c) \cong \lim^{C(=,=)} F \quad (7.43)$$

whenever the weighted limit $\lim^{C(=,=)} F$ exists. Dually, we have

$$\int^{c \in C} F(c, c) \cong \text{colim}^{C(=,=)} F$$

(where $C(=, -): C \times C^{\text{op}} \rightarrow \mathbf{Set}$) whenever the weighted colimit $\text{colim}^{C(=,=)} F$ exists.

Proof. We have

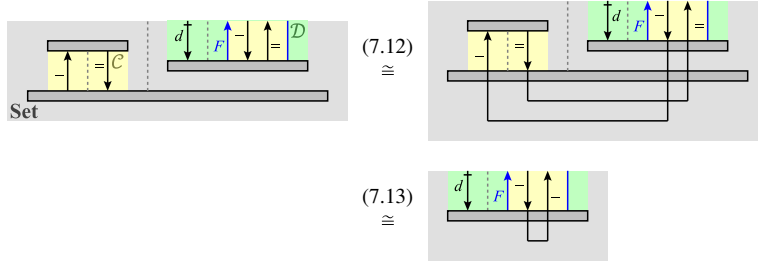

whose mathematical notation is

$$\begin{aligned} \mathbf{Set}^{C^{\text{op}} \times C}(C(-, =), \mathcal{D}(d, F(-, =))) &\stackrel{(7.12)}{\cong} \int_{c \in C} \int_{c' \in C} \mathbf{Set}(C(c, c'), \mathcal{D}(d, F(c, c'))) \\ &\stackrel{(7.13)}{\cong} \int_{c \in C} \mathcal{D}(d, F(c, c)) \stackrel{(7.8)}{\cong} \mathcal{D}\left(d, \int_{c \in C} F(c, c)\right). \end{aligned}$$

Thus, we obtain Eq. (7.43) from Eq. (7.36). \square

(3) Weighted (co)limits can be expressed using pointwise Kan extensions

Proposition 7.44: For any small category C , cocomplete category \mathcal{E} , presheaf $W' : C^{\text{op}} \rightarrow \mathbf{Set}$, and functor $F : C \rightarrow \mathcal{E}$, we have

$$\text{colim}^{W'} F \cong (\text{Lan}_{C^{\square}} F)W'.$$

Proof. The proof is immediate from

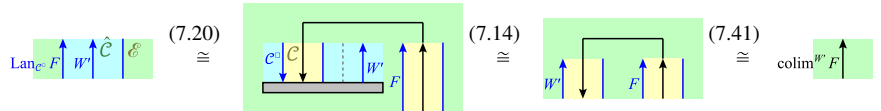

whose mathematical notation is

$$(\text{Lan}_{C^{\square}} F)W' \stackrel{(7.20)}{\cong} \int^{c \in C} \hat{C}(C^{\square}(c), W') \otimes Fc \stackrel{(7.14)}{\cong} \int^{c \in C} W'c \otimes Fc \stackrel{(7.41)}{\cong} \text{colim}^{W'} F.$$

\square

Acknowledgements

I would like to thank Osamu Hirota, Masaki Sohma, and Kentaro Kato from Tamagawa University, as well as Tsuyoshi Sasaki Usuda from Aichi Prefectural University and Tomohiro Sogabe from Nagoya University, for their invaluable support and insightful discussions. Furthermore, I had the opportunity to discuss the contents of this paper with Keima Akasaka, Tamotsu Basseda, Koreto Endo, Yusuke Furuta, Yo Ikeda, Yuto Ikeda, Tomohiro Karube, Ryosuke Koganezawa, Takayuki Kuriyama, Hayato Nasu, Tomoya Nishikata, Ray D. Sameshima, Kosei Sawada, Yoshitsugu Sekine, Kazuhiro Shigekuni, Kayo Tei, Keisuke Tomita, Haruki Toyota, and Aiki Ueno.

References

- [1] S. Abramsky and B. Coecke. Categorical quantum mechanics. *Handbook of Quantum Logic and Quantum Structures Quantum Logic*, page 261, 2009.
- [2] J. Bénabou. Introduction to bicategories. In *Reports of the Midwest Category Seminar*, pages 1–77. Springer, 1967.
- [3] D. Braithwaite and M. Román. Collages of string diagrams. *arXiv preprint arXiv:2305.02675*, 2023.
- [4] R. Hinze. Kan extensions for program optimisation or: Art and dan explain an old trick. In *Mathematics of Program Construction: 11th International Conference, MPC 2012, Madrid, Spain*, pages 324–362. Springer, 2012.
- [5] R. Hinze and D. Marsden. *Introducing string diagrams: the art of category theory*. Cambridge University Press, 2023.
- [6] F. Loregian. This is the (co) end, my only (co) friend. *arXiv preprint arXiv:1501.02503*, 643, 2015.
- [7] S. Mac Lane. *Categories for the working mathematician*, volume 5. Springer Science & Business Media, 2013.
- [8] D. Marsden. Category theory using string diagrams. *arXiv preprint arXiv:1401.7220*, 2014.
- [9] M. B. McCurdy. Tannaka reconstruction of weak hopf algebras in arbitrary monoidal categories. *arXiv preprint arXiv:0903.0208*, 2009.
- [10] P.-A. Mellies. Functorial boxes in string diagrams. In *Computer Science Logic*, volume 4207, pages 1–30. Springer, 2006.
- [11] A. J. Power. A 2-categorical pasting theorem. *Journal of Algebra*, 129(2):439–445, 1990.
- [12] E. Riehl. *Category theory in context*. Courier Dover Publications, 2017.
- [13] M. Riley. Categories of optics. *arXiv preprint arXiv:1809.00738*, 2018.
- [14] M. Román. Open diagrams via coend calculus. In D. I. Spivak and J. Vicary, editors, *Proceedings of the 3rd Annual International Applied Category Theory Conference 2020*, Cambridge, USA, 6-10th July 2020, volume 333 of *Electronic Proceedings in Theoretical Computer Science*, pages 65–78. Open Publishing Association, 2020.
- [15] P. Selinger. A survey of graphical languages for monoidal categories. *New structures for physics*, pages 289–355, 2011.
- [16] R. Street and D. Verity. Low-dimensional topology and higher-order categories. *Proceedings of CT95, Halifax*, 1995.