

Regularity Theory for Elliptic PDE

Xavier Fernández-Real

Xavier Ros-Oton

EPFL SB MATH, INSTITUTE OF MATHEMATICS, STATION 8, CH-1015 LAUSANNE, SWITZERLAND

E-mail address: `xavier.fernandez-real@epfl.ch`

UNIVERSITÄT ZÜRICH, INSTITUT FÜR MATHEMATIK, WINTERTHUR-ERSTRASSE 190, 8057 ZÜRICH, SWITZERLAND, &

ICREA, PG. LLUÍS COMPANYS 23, 08010 BARCELONA, SPAIN, &

UNIVERSITAT DE BARCELONA, DEPARTAMENT DE MATEMÀTIQUES I INFORMÀTICA, GRAN VIA DE LES CORTS CATALANES 585, 08007 BARCELONA, SPAIN, &

CENTRE DE RECERCA MATEMÀTICA, EDIFICI C, CAMPUS BELLATERRA, 08193 BELLATERRA, SPAIN

E-mail address: `xros@icrea.cat`

2020 *Mathematics Subject Classification.* 35J15, 35B65, 35J05, 35J20,
35J60, 35R35.

Key words and phrases. Elliptic PDE, Schauder estimates, Hilbert XIXth
problem, nonlinear elliptic equations, obstacle problem.

—
DRAFT
—

Contents

Preface	vii
Chapter 1. Overview and Preliminaries	1
§1.1. Preliminaries: Sobolev and Hölder spaces	3
§1.2. A review on the Laplace equation	9
§1.3. Probabilistic interpretation of harmonic functions	21
Chapter 2. Linear elliptic PDE	25
§2.1. Harnack's inequality	26
§2.2. Schauder estimates for the Laplacian	33
§2.3. Schauder estimates for operators in non-divergence form	46
§2.4. Schauder estimates for operators in divergence form	59
§2.5. The case of continuous coefficients	64
§2.6. Boundary regularity	68
Chapter 3. Nonlinear variational PDE & Hilbert's XIXth problem	71
§3.1. Overview	72
§3.2. Existence and basic estimates	75
§3.3. De Giorgi's proof	81
§3.4. Solution to Hilbert's XIXth problem	94
§3.5. Further results and open problems	95
Chapter 4. Fully nonlinear elliptic PDE	97
§4.1. What is ellipticity?	98
§4.2. Equations in two variables	102

§4.3. Existence of solutions	105
§4.4. Regularity of solutions: an overview	115
§4.5. Further results and open problems	121
Chapter 5. The obstacle problem	125
§5.1. Some motivations and applications	128
§5.2. Basic properties of solutions I	130
§5.3. Basic properties of solutions II	141
§5.4. Regularity of free boundaries: an overview	147
§5.5. Classification of blow-ups	150
§5.6. Regularity of the free boundary	161
§5.7. Singular points	171
§5.8. On the size of the singular set	175
Appendix A. Some properties of Hölder spaces	179
Appendix B. Proof of the boundary Harnack inequality	191
Appendix C. Probabilistic interpretation of fully nonlinear equations	201
Appendix D. Motivations and applications for the obstacle problem	211
Notation	219
Bibliography	223
Index	229

Preface

One of the most basic and important questions in PDE is that of regularity. It is also a unifying problem in the field, since it affects all kinds of PDEs. A classical example is Hilbert's XIXth problem (1900), which roughly speaking asked to determine whether all solutions to uniformly elliptic variational PDEs are smooth. The question was answered positively by De Giorgi and Nash in 1956 and 1957, and it is now one of the most famous and important theorems in the whole field of PDE.

The question of regularity has been a central line of research in elliptic PDE since the mid-20th century, with extremely important contributions by Nirenberg, Caffarelli, Krylov, Evans, Figalli, and many others. Their works have enormously influenced many areas of Mathematics linked one way or another with PDE, including: Harmonic Analysis, Calculus of Variations, Differential Geometry, Geometric Measure Theory, Continuum and Fluid Mechanics, Probability Theory, Mathematical Physics, and Computational and Applied Mathematics.

This text emerged from two PhD courses on elliptic PDE given by the second author at the University of Zürich in 2017 and 2019. It aims to provide a self-contained introduction to the regularity theory for elliptic PDE, focusing on the main ideas rather than proving all results in their greatest generality. The book can be seen as a bridge between an elementary PDE course and more advanced textbooks such as [GT77] or [CC95]. Moreover, we believe that the present selection of results and techniques complements nicely other books on elliptic PDE such as [Eva98], [HL97], and [Kry96], as well as the recent book [ACM18]. For example, we give a different proof of the Schauder estimates (due to L. Simon) which is not contained in other textbooks; we prove some basic results for fully nonlinear equations that

— DRAFT —

are not covered in [CC95]; and we also include a detailed study of the obstacle problem, often left to more specialized textbooks such as [Fri88] or [PSU12]. Furthermore, at the end of Chapters 3, 4, and 5 we provide a review of some recent results and open problems.

We would like to thank Alessio Figalli, Thomas Kappeler, Alexis Michelat, Joaquim Serra, and Wei Wang, for several comments and suggestions on this book.

Finally, we acknowledge the support received from the following funding agencies: X.F. was supported by the European Research Council under the Grant Agreement No. 721675 “Regularity and Stability in Partial Differential Equations (RSPDE)”, by the Swiss National Science Foundation (SNF grants 200021_182565 and PZ00P2_208930), and by the Swiss State Secretariat for Education, Research and Innovation (SERI) under contract number M822.00034; X.R. was supported by the European Research Council under the Grant Agreement No. 801867 “Regularity and singularities in elliptic PDE (EllipticPDE)”, by the Swiss National Science Foundation (SNF grant 200021_178795), by AEI project PID2021-125021NA-I00 (Spain), by the grant RED2018-102650-T funded by MCIN/AEI/10.13039/501100011033, and by the Spanish State Research Agency through the María de Maeztu Program for Centers and Units of Excellence in R&D (CEX2020-001084-M).

Zürich, 2020

—
DRAFT
—

Overview and Preliminaries

A beautiful result in Complex Analysis states that because the real part $u(x, y)$ of any holomorphic function satisfies

$$u_{xx} + u_{yy} = 0,$$

it must be real analytic. Moreover, the oscillation of u in any given domain controls *all* the derivatives in any (compactly contained) subdomain.

In higher dimensions, the same phenomenon occurs for solutions to

$$(1.1) \quad \Delta u = 0 \quad \text{in} \quad \Omega \subset \mathbb{R}^n.$$

These are *harmonic functions*, and (1.1) is the simplest elliptic partial differential equation (PDE). Any solution to this equation is smooth (real analytic), and satisfies

$$\|u\|_{C^k(Q)} \leq C_{k,Q} \|u\|_{L^\infty(\Omega)} \quad \text{for all } k = 1, 2, 3, \dots$$

for any compact subdomain $Q \subset\subset \Omega$. That is, all derivatives are controlled by the supremum of u .

Here, and throughout the book, Ω is any bounded domain of \mathbb{R}^n .

- *Regularity for Laplace's equation:*

$$\Delta u = 0 \quad \text{in} \quad \Omega \subset \mathbb{R}^n \quad \implies \quad u \text{ is } C^\infty \text{ inside } \Omega.$$

This kind of regularization property is common in elliptic PDEs and is the topic of the present book.

One can give three different kinds of explanations for this phenomenon:

- (a) Integral representation of solutions: Poisson kernels, fundamental solutions, etc.
- (b) Energy considerations: Harmonic functions are local minimizers of the Dirichlet energy

$$\mathcal{E}(u) := \int_{\Omega} |\nabla u|^2 dx$$

(i.e., if we change u to w in $\tilde{\Omega} \subset \Omega$, then $\mathcal{E}(w) \geq \mathcal{E}(u)$).

- (c) Comparison principle: A harmonic function cannot have any interior maximum point (maximum principle).

These three approaches are extremely useful in different contexts, as well as in the development of the regularity theory for *nonlinear* elliptic PDEs.

The structure of the book is as follows:

★ First, in **Chapter 2** we will study *linear* elliptic PDEs

$$\sum_{i,j=1}^n a_{ij}(x) \partial_{ij} u = f(x) \quad \text{in } \Omega \subset \mathbb{R}^n$$

and

$$\sum_{i,j=1}^n \partial_i (a_{ij}(x) \partial_j u) = f(x) \quad \text{in } \Omega \subset \mathbb{R}^n,$$

where the coefficients $a_{ij}(x)$ and the right-hand side $f(x)$ satisfy appropriate regularity assumptions. In the simplest case, $(a_{ij})_{i,j} \equiv \text{Id}$, we have

$$\Delta u = f(x) \quad \text{in } \Omega \subset \mathbb{R}^n.$$

The type of result we want to prove is: “ u is two derivatives more regular than f ”.

★ Then, in **Chapter 3** we will turn our attention to *nonlinear variational PDEs*:

$$\text{minimizers of } \mathcal{E}(u) := \int_{\Omega} L(\nabla u) dx, \quad L \text{ smooth and uniformly convex.}$$

The regularity for such kind of nonlinear PDEs was Hilbert’s XIXth problem (1900).

★ In **Chapter 4** we will study nonlinear elliptic PDEs in their most general form

$$F(D^2 u, \nabla u, u, x) = 0 \quad \text{in } \Omega \subset \mathbb{R}^n,$$

or simply

$$F(D^2u) = 0 \quad \text{in } \Omega \subset \mathbb{R}^n.$$

These are called *fully nonlinear elliptic equations*, and in general they do *not* have a variational formulation in terms of an energy functional.

★ In **Chapter 5** we will study the *obstacle problem*, a constrained minimization problem:

$$\text{minimize} \quad \int_{\Omega} |\nabla u|^2 dx, \quad \text{among functions } u \geq \varphi \text{ in } \Omega,$$

where φ is a given smooth “obstacle”. This is the simplest and most important elliptic *free boundary problem*. Moreover, it can be seen as a nonlinear PDE of the type $\min\{-\Delta u, u - \varphi\} = 0$ in Ω .

As we will see, in each of these contexts we will use mainly: (b) energy considerations, or (c) maximum principle.

At the end of the book, we have also included four appendices to complement the theory from the main chapters.

1.1. Preliminaries: Sobolev and Hölder spaces

We next give a quick review on L^p , Sobolev, and Hölder spaces, stating the results that will be used later in the book.

L^p spaces. Given $\Omega \subset \mathbb{R}^n$ and $1 \leq p < \infty$, the space $L^p(\Omega)$ is the set

$$L^p(\Omega) := \left\{ u \text{ measurable in } \Omega : \int_{\Omega} |u|^p dx < \infty \right\}.$$

It is a Banach space, with the norm $\|u\|_{L^p(\Omega)} := (\int_{\Omega} |u|^p)^{1/p}$.

When $p = \infty$, the space $L^\infty(\Omega)$ is the set of bounded functions (up to sets of measure zero), with the norm $\|u\|_{L^\infty(\Omega)} := \text{esssup}_{\Omega} |u|$.

A well-known result in this setting is the Lebesgue differentiation theorem (see, for example, [EG92]).

Theorem 1.1. *If $u \in L^1(\Omega)$, then for almost every $x \in \Omega$ we have*

$$\lim_{r \rightarrow 0} \int_{B_r(x)} |u(x) - u(y)| dy = 0.$$

When this holds at a point $x \in \Omega$, we say that x is a Lebesgue point of u .

Here, and throughout the book, f_A denotes the average $\frac{1}{|A|} \int_A$, where $A \subset \mathbb{R}^n$ is any set of finite and positive measure.

A useful consequence of this result is the following.

— DRAFT —

Corollary 1.2. Assume $u \in L^1(\Omega)$, and

$$\int_{\Omega} uv \, dx = 0 \quad \text{for all } v \in C_c^\infty(\Omega).$$

Then, $u = 0$ a.e. in Ω .

Integration by parts. A fundamental identity in the study of PDEs is the following.

Theorem 1.3 (Integration by parts). Assume $\Omega \subset \mathbb{R}^n$ is any bounded C^1 domain¹. Then, for any $u, v \in C^1(\bar{\Omega})$ we have

$$(1.2) \quad \int_{\Omega} \partial_i u v \, dx = - \int_{\Omega} u \partial_i v \, dx + \int_{\partial\Omega} uv \nu_i \, dS,$$

where ν is the unit (outward) normal vector to $\partial\Omega$, and $i = 1, 2, \dots, n$.

Notice that, as an immediate consequence, we find the divergence theorem, as well as Green's first identity

$$\int_{\Omega} \nabla u \cdot \nabla v \, dx = - \int_{\Omega} u \Delta v \, dx + \int_{\partial\Omega} u \frac{\partial v}{\partial \nu} \, dS.$$

The regularity requirements of Theorem 1.3 can be relaxed. For instance, the domain Ω need only be Lipschitz, while only $u, v \in H^1(\Omega)$ is necessary in (1.2) — where H^1 is a Sobolev space, defined below.

Sobolev spaces. Given any domain $\Omega \subset \mathbb{R}^n$ and $1 \leq p \leq \infty$, the Sobolev spaces $W^{1,p}(\Omega)$ consist of all functions whose (weak) derivatives are in $L^p(\Omega)$, namely

$$W^{1,p}(\Omega) := \{u \in L^p(\Omega) : \partial_i u \in L^p(\Omega) \text{ for } i = 1, \dots, n\}.$$

We refer to the excellent books [Eva98, Bre11] for the definition of weak derivatives and a detailed exposition on Sobolev spaces.

A few useful properties of Sobolev spaces are the following (see [Eva98]):

- (S1) The spaces $W^{1,p}(\Omega)$ are complete.
- (S2) The inclusion $W^{1,p}(\Omega) \subset L^p(\Omega)$ is compact.
- (S3) The space $H^1(\Omega) := W^{1,2}(\Omega)$ is a Hilbert space with the scalar product

$$(u, v)_{H^1(\Omega)} = \int_{\Omega} uv + \int_{\Omega} \nabla u \cdot \nabla v.$$

- (S4) Any bounded sequence $\{u_k\}$ in the Hilbert space $H^1(\Omega)$ contains a weakly convergent subsequence $\{u_{k_j}\}$, that is, there exists $u \in H^1(\Omega)$ such that

$$(1.3) \quad (u_{k_j}, v)_{H^1(\Omega)} \rightarrow (u, v)_{H^1(\Omega)} \quad \text{for all } v \in H^1(\Omega).$$

¹We refer to the Notation section (page 221) for the definition of C^1 domains.

In addition, such u will satisfy

$$(1.4) \quad \|u\|_{H^1(\Omega)} \leq \liminf_{j \rightarrow \infty} \|u_{k_j}\|_{H^1(\Omega)},$$

and since $H^1(\Omega)$ is compactly embedded in $L^2(\Omega)$ one has

$$(1.5) \quad \|u\|_{L^2(\Omega)} = \lim_{j \rightarrow \infty} \|u_{k_j}\|_{L^2(\Omega)}.$$

(S5) Let Ω be any bounded Lipschitz domain, and $1 \leq p \leq \infty$. Then, there is a continuous (and compact for $p > 1$) trace operator from $W^{1,p}(\Omega)$ to $L^p(\partial\Omega)$. For C^0 functions, such trace operator is simply $u \mapsto u|_{\partial\Omega}$.

Because of this, for any function $u \in H^1(\Omega)$ we will still denote by $u|_{\partial\Omega}$ its trace on $\partial\Omega$.

(S6) For $1 \leq p < \infty$, $C^\infty(\Omega)$ functions are dense in $W^{1,p}(\Omega)$. Moreover, if Ω is bounded and Lipschitz, $C^\infty(\bar{\Omega})$ functions are dense in $W^{1,p}(\Omega)$.

(S7) For $1 \leq p < \infty$, we define the space $W_0^{1,p}(\Omega)$ as the closure of $C_c^\infty(\Omega)$ in $W^{1,p}(\Omega)$. Similarly, we denote $H_0^1(\Omega) := W_0^{1,2}(\Omega)$. When Ω is bounded and Lipschitz, it is the space of functions $u \in W^{1,p}(\Omega)$ such that $u|_{\partial\Omega} = 0$.

(S8) If $u \in W^{1,p}(\Omega)$, $1 \leq p \leq \infty$, then for any subdomain $K \subset\subset \Omega$ we have

$$\left\| \frac{u(x+h) - u(x)}{|h|} \right\|_{L^p(K)} \leq C \|\nabla u\|_{L^p(\Omega)}$$

for all $h \in B_\delta$, with $\delta > 0$ small enough.

Conversely, if $u \in L^p(\Omega)$, $1 < p \leq \infty$, and

$$\left\| \frac{u(x+h) - u(x)}{|h|} \right\|_{L^p(K)} \leq C$$

for every $h \in B_\delta$, then $u \in W^{1,p}(K)$ and $\|\nabla u\|_{L^p(\Omega)} \leq C$. (However, this property fails when $p = 1$.)

(S9) Given any function u , define $u^+ = \max\{u, 0\}$ and $u^- = \max\{-u, 0\}$, so that $u = u^+ - u^-$. Then, for any $u \in W^{1,p}(\Omega)$ we have $u^+, u^- \in W^{1,p}(\Omega)$, and $\nabla u = \nabla u^+ - \nabla u^-$ a.e. in Ω .

In particular, the gradient of Sobolev functions vanishes almost everywhere on level sets, $\nabla u(x) = 0$ for a.e. $x \in \{u = 0\}$.

An important inequality in this context is the following.

Theorem 1.4 (Sobolev inequality). *If $p < n$, then*

$$\left(\int_{\mathbb{R}^n} |u|^{p^*} dx \right)^{1/p^*} \leq C \left(\int_{\mathbb{R}^n} |\nabla u|^p dx \right)^{1/p}, \quad \frac{1}{p^*} = \frac{1}{p} - \frac{1}{n},$$

for some constant C depending only on n and p . In particular, we have a continuous inclusion $W^{1,p}(\mathbb{R}^n) \subset L^{p^*}(\mathbb{R}^n)$.

Notice that, as $p \uparrow n$ we have $p_* \rightarrow \infty$. In the limiting case $p = n$, however, it is *not* true that $W^{1,n}$ functions are bounded. This can be seen by taking, for example, $u(x) = \log \log \left(1 + \frac{1}{|x|}\right) \in W^{1,n}(B_1)$. Still, in case $p > n$, the following occurs.

Theorem 1.5 (Morrey inequality). *If $p > n$, then*

$$\sup_{x \neq y} \frac{|u(x) - u(y)|}{|x - y|^\alpha} \leq C \left(\int_{\mathbb{R}^n} |\nabla u|^p dx \right)^{1/p}, \quad \alpha = 1 - \frac{n}{p},$$

for some constant C depending only on n and p .

In particular, when $p > n$ any function in $W^{1,p}$ is continuous (after possibly being redefined on a set of measure 0).

Finally, we will also use the following inequalities in bounded domains.

Theorem 1.6 (Poincaré inequality). *Let $\Omega \subset \mathbb{R}^n$ be any bounded Lipschitz domain, and let $p \in [1, \infty)$. Then, for any $u \in W^{1,p}(\Omega)$ we have*

$$\int_{\Omega} |u - u_{\Omega}|^p dx \leq C_{\Omega,p} \int_{\Omega} |\nabla u|^p dx,$$

where $u_{\Omega} := \int_{\Omega} u$, and

$$\int_{\Omega} |u|^p dx \leq C'_{\Omega,p} \left(\int_{\Omega} |\nabla u|^p dx + \int_{\partial\Omega} |u|_{\partial\Omega}|^p d\sigma \right).$$

The constants $C_{\Omega,p}$ and $C'_{\Omega,p}$ depend only on n , p , and Ω .

Hölder spaces. Given $\alpha \in (0, 1)$, the Hölder space $C^{0,\alpha}(\overline{\Omega})$ is the set of continuous functions $u \in C(\overline{\Omega})$ such that the Hölder semi-norm is finite,

$$[u]_{C^{0,\alpha}(\overline{\Omega})} := \sup_{\substack{x,y \in \overline{\Omega} \\ x \neq y}} \frac{|u(x) - u(y)|}{|x - y|^\alpha} < \infty.$$

The Hölder norm is

$$\|u\|_{C^{0,\alpha}(\overline{\Omega})} := \|u\|_{L^\infty(\Omega)} + [u]_{C^{0,\alpha}(\overline{\Omega})}.$$

When $\alpha = 1$, this is the usual space of Lipschitz continuous functions.

More generally, given $k \in \mathbb{N}$ and $\alpha \in (0, 1)$, the space $C^{k,\alpha}(\overline{\Omega})$ is the set of functions $u \in C^k(\overline{\Omega})$ such that the following norm is finite

$$\|u\|_{C^{k,\alpha}(\overline{\Omega})} = \|u\|_{C^k(\overline{\Omega})} + [D^k u]_{C^{0,\alpha}(\overline{\Omega})},$$

where

$$\|u\|_{C^k(\overline{\Omega})} := \sum_{j=1}^k \|D^j u\|_{L^\infty(\Omega)}.$$

Notice that this yields the inclusions

$$C^0 \supset C^{0,\alpha} \supset \text{Lip} \supset C^1 \supset C^{1,\alpha} \supset \dots \supset C^\infty.$$

We will often write $\|u\|_{C^{k,\alpha}(\Omega)}$ instead of $\|u\|_{C^{k,\alpha}(\overline{\Omega})}$.

Finally, it is sometimes convenient to use the following notation. When $\beta > 0$ is *not* an integer, we define $C^\beta(\overline{\Omega}) := C^{k,\alpha}(\overline{\Omega})$, where $\beta = k + \alpha$, $k \in \mathbb{N}$, $\alpha \in (0, 1)$.

There are many properties or alternative definitions of Hölder spaces that will be used throughout the book. They are valid for all $\alpha \in (0, 1)$, and are proved in Appendix A.

(H1) Assume

$$\text{osc}_{B_r(x)} u \leq C_\circ r^\alpha \quad \text{for all } B_r(x) \subset \overline{B_1},$$

where $\text{osc}_A u := \sup_A u - \inf_A u$.

Then, $u \in C^{0,\alpha}(\overline{B_1})$ and $[u]_{C^{0,\alpha}(\overline{B_1})} \leq CC_\circ$, with C depending only on n, α .

(H2) Let $u_{x,r} := \fint_{B_r(x)} u$. Assume

$$\|u - u_{x,r}\|_{L^\infty(B_r(x))} \leq C_\circ r^\alpha \quad \text{for all } B_r(x) \subset \overline{B_1}.$$

Then, $u \in C^{0,\alpha}(\overline{B_1})$ and $[u]_{C^{0,\alpha}(\overline{B_1})} \leq CC_\circ$, with C depending only on n, α .

(H3) Let $u_{x,r} := \fint_{B_r(x)} u$. Assume

$$\left(\fint_{B_r(x)} |u - u_{x,r}|^2 \right)^{1/2} \leq C_\circ r^\alpha \quad \text{for all } B_r(x) \subset \overline{B_1}.$$

Then, $u \in C^{0,\alpha}(\overline{B_1})$ and $[u]_{C^{0,\alpha}(\overline{B_1})} \leq CC_\circ$, with C depending only on n, α .

(H4) Assume that for every x there is a constant C_x such that

$$\|u - C_x\|_{L^\infty(B_r(x))} \leq C_\circ r^\alpha \quad \text{for all } B_r(x) \subset \overline{B_1}.$$

Then, $u \in C^{0,\alpha}(\overline{B_1})$ and $[u]_{C^{0,\alpha}(\overline{B_1})} \leq CC_\circ$, with C depending only on n, α .

Assume that for every x there is a linear function $\ell_x(y) = a_x + b_x \cdot (y - x)$ such that

$$\|u - \ell_x\|_{L^\infty(B_r(x))} \leq C_\circ r^{1+\alpha} \quad \text{for all } B_r(x) \subset \overline{B_1}.$$

Then, $u \in C^{1,\alpha}(\overline{B_1})$ and $[Du]_{C^{0,\alpha}(\overline{B_1})} \leq CC_\circ$, with C depending only on n, α .

Assume that for every x there is a quadratic polynomial $P_x(y)$ such that

$$\|u - P_x\|_{L^\infty(B_r(x))} \leq C_\circ r^{2+\alpha} \quad \text{for all } B_r(x) \subset \overline{B_1}.$$

Then, $u \in C^{2,\alpha}(\overline{B_1})$ and $[D^2u]_{C^{0,\alpha}(\overline{B_1})} \leq CC_\circ$, with C depending only on n, α .

(H5) Let $\rho_\circ \in (0, 1)$. Assume that, for every $x \in B_{1/2}$, there exists a sequence of quadratic polynomials, $(P_k)_{k \in \mathbb{N}}$, such that

$$(1.6) \quad \|u - P_k\|_{L^\infty(B_{\rho_\circ^k}(x))} \leq C_\circ \rho_\circ^{k(2+\alpha)} \quad \text{for all } k \in \mathbb{N}.$$

Then, $u \in C^{2,\alpha}(B_{1/2})$ and $[D^2u]_{C^{0,\alpha}(B_{1/2})} \leq CC_\circ$, with C depending only on n, α , and ρ_\circ .

(H6) Assume that $\alpha \in (0, 1)$, $\|u\|_{L^\infty(B_1)} \leq C_\circ$, and

$$\sup_{\substack{x \in B_1 \\ x \pm h \in \overline{B_1}}} \frac{|u(x+h) + u(x-h) - 2u(x)|}{|h|^\alpha} \leq C_\circ.$$

Then, $u \in C^{0,\alpha}(\overline{B_1})$ and $\|u\|_{C^{0,\alpha}(\overline{B_1})} \leq CC_\circ$, with C depending only on n, α .

Assume that $\alpha \in (0, 1)$, $\|u\|_{L^\infty(B_1)} \leq C_\circ$, and

$$\sup_{\substack{x \in B_1 \\ x \pm h \in \overline{B_1}}} \frac{|u(x+h) + u(x-h) - 2u(x)|}{|h|^{1+\alpha}} \leq C_\circ.$$

Then, $u \in C^{1,\alpha}(\overline{B_1})$ and $\|u\|_{C^{1,\alpha}(\overline{B_1})} \leq CC_\circ$, with C depending only on n, α .

However, such property fails when $\alpha = 0$.

(H7) Assume that $\alpha \in (0, 1]$, $\|u\|_{L^\infty(B_1)} \leq C_\circ$, and that for every $h \in B_1$ we have

$$(1.7) \quad \left\| \frac{u(x+h) - u(x)}{|h|^\alpha} \right\|_{C^\beta(B_{1-|h|})} \leq C_\circ,$$

with C_\circ independent of h . Assume in addition that $\alpha + \beta$ is not an integer. Then, $u \in C^{\alpha+\beta}(\overline{B_1})$ and $\|u\|_{C^{\alpha+\beta}(\overline{B_1})} \leq CC_\circ$, with C depending only on n, α, β .

However, such property fails when $\alpha + \beta$ is an integer.

(H8) Assume that $u_i \rightarrow u_0$ uniformly in $\overline{\Omega} \subset \mathbb{R}^n$, and that $\|u_i\|_{C^{k,\alpha}(\overline{\Omega})} \leq C_\circ$, with $\alpha \in (0, 1]$ and for some C_\circ independent of i . Then, we have that $u_0 \in C^{k,\alpha}(\overline{\Omega})$, and

$$\|u_0\|_{C^{k,\alpha}(\overline{\Omega})} \leq C_\circ.$$

Finally, an important result in this context is the following particular case of the Arzelà–Ascoli theorem.

Theorem 1.7 (Arzelà–Ascoli). *Let $\Omega \subset \mathbb{R}^n$, $\alpha \in (0, 1)$, and let $\{f_i\}_{i \in \mathbb{N}}$ be any sequence of functions f_i satisfying*

$$\|f_i\|_{C^{0,\alpha}(\overline{\Omega})} \leq C_0.$$

Then, there exists a subsequence f_{i_j} which converges uniformly to a function $f \in C^{0,\alpha}(\overline{\Omega})$.

More generally, this result — combined with **(H8)** — implies that if

$$\|u_i\|_{C^{k,\alpha}(\overline{\Omega})} \leq C_0,$$

with $\alpha \in (0, 1)$, then a subsequence u_{i_j} will converge in the $C^k(\overline{\Omega})$ norm to a function $u \in C^{k,\alpha}(\overline{\Omega})$.

Interpolation inequalities in Hölder spaces. A useful tool that will be used throughout the book is the following. For each $0 \leq \gamma < \alpha < \beta \leq 1$ and every $\varepsilon > 0$, we have

$$(1.8) \quad \|u\|_{C^{0,\alpha}(\overline{\Omega})} \leq C_\varepsilon \|u\|_{C^{0,\gamma}(\overline{\Omega})} + \varepsilon \|u\|_{C^{0,\beta}(\overline{\Omega})},$$

where C is a constant depending only on n and ε . (When $\gamma = 0$, $C^{0,\gamma}$ should be replaced by L^∞ .) This follows from the interpolation inequality

$$\|u\|_{C^{0,\alpha}(\overline{\Omega})} \leq \|u\|_{C^{0,\gamma}(\overline{\Omega})}^t \|u\|_{C^{0,\beta}(\overline{\Omega})}^{1-t} \quad t = \frac{\beta - \alpha}{\beta - \gamma}.$$

More generally, (1.8) holds for higher-order Hölder norms too. In particular, we will use that for any $\varepsilon > 0$ and $\alpha \in (0, 1)$

$$\|\nabla u\|_{L^\infty(\overline{\Omega})} \leq C_\varepsilon \|u\|_{L^\infty(\overline{\Omega})} + \varepsilon [\nabla u]_{C^{0,\alpha}(\overline{\Omega})},$$

and

$$(1.9) \quad \|u\|_{C^2(\overline{\Omega})} = \|u\|_{C^{1,1}(\overline{\Omega})} \leq C_\varepsilon \|u\|_{L^\infty(\overline{\Omega})} + \varepsilon [D^2 u]_{C^{0,\alpha}(\overline{\Omega})}.$$

We refer to [GT77, Lemma 6.35] for a proof of such inequalities.

1.2. A review on the Laplace equation

Elliptic equations are those that share some common properties with the Laplace equation. (We will be more rigorous about this in the subsequent chapters.) Thus, we start with a quick review about the Laplace equation and harmonic functions.

The *Dirichlet problem* for this equation is the following:

$$(1.10) \quad \begin{cases} \Delta u = 0 & \text{in } \Omega \\ u = g & \text{on } \partial\Omega, \end{cases}$$

where the boundary condition g is given. The domain $\Omega \subset \mathbb{R}^n$ is bounded and smooth (or at least Lipschitz). The Dirichlet problem is solvable, and it has a unique solution.

A useful way to think of the Laplacian Δ is to notice that, up to a multiplicative constant, it is the only linear operator of second order which is translation invariant *and* rotation invariant. Indeed, it can be seen as an operator which measures (infinitesimally) the difference between u at x and the average of u around x , in the following sense: for any C^2 function w we have

$$(1.11) \quad \begin{aligned} \Delta w(x) &= \lim_{r \rightarrow 0} \frac{c_n}{r^2} \left\{ \int_{B_r(x)} w(y) dy - w(x) \right\} \\ &= \lim_{r \rightarrow 0} \frac{c_n}{r^2} \int_{B_r(x)} (w(y) - w(x)) dy, \end{aligned}$$

for some positive constant c_n . This can be shown, for example, by using the Taylor expansion of $w(y)$ around x . Moreover, a similar formula holds with integrals in $\partial B_r(x)$ instead of $B_r(x)$. See, for example, [DV21].

Actually, one can show by using the divergence theorem that

$$(1.12) \quad \frac{n}{r} \frac{d}{dr} \int_{\partial B_r(x)} w d\sigma = \int_{B_r(x)} \Delta w,$$

from which (1.11) also follows.

Existence of solutions: energy methods. The most classical way to construct solutions of (1.10) is by “energy methods”. Namely, we consider the convex functional

$$\mathcal{E}(u) := \frac{1}{2} \int_{\Omega} |\nabla u|^2 dx \quad \text{among functions satisfying } u|_{\partial\Omega} = g,$$

and then look for the function u that minimizes the functional — see Theorem 1.10 below for more details about the existence of a minimizer. Notice that such minimizer u will clearly satisfy the boundary condition $u = g$ on $\partial\Omega$, so we only have to check that it will satisfy in addition $\Delta u = 0$ in Ω .

If u is the minimizer, then $\mathcal{E}(u) \leq \mathcal{E}(u + \varepsilon v)$ for every $v \in C_c^\infty(\Omega)$. Since, for every fixed v , such function in ε has a minimum at $\varepsilon = 0$, we have

$$\left. \frac{d}{d\varepsilon} \right|_{\varepsilon=0} \mathcal{E}(u + \varepsilon v) = 0.$$

Thus,

$$\begin{aligned}
0 &= \left. \frac{d}{d\varepsilon} \right|_{\varepsilon=0} \mathcal{E}(u + \varepsilon v) = \left. \frac{d}{d\varepsilon} \right|_{\varepsilon=0} \frac{1}{2} \int_{\Omega} |\nabla u + \varepsilon v|^2 dx \\
&= \left. \frac{d}{d\varepsilon} \right|_{\varepsilon=0} \frac{1}{2} \int_{\Omega} (|\nabla u|^2 + 2\varepsilon \nabla u \cdot \nabla v + \varepsilon^2 |\nabla v|^2) dx \\
&= \int_{\Omega} \nabla u \cdot \nabla v dx.
\end{aligned}$$

Hence, if u is the minimizer of the functional, then

$$(1.13) \quad \int_{\Omega} \nabla u \cdot \nabla v dx = 0 \quad \text{for all } v \in C_c^\infty(\Omega).$$

If u is regular enough (say, $u \in C^2$), then we can integrate by parts (Theorem 1.3) to find that

$$\int_{\Omega} \Delta u v dx = 0 \quad \text{for all } v \in C_c^\infty(\Omega).$$

Thus, using Corollary 1.2 we deduce that $\Delta u = 0$ in Ω , as wanted.

Remark 1.8. As mentioned above, one should prove *regularity* of u before integrating by parts — a priori the minimizer u will only satisfy $u \in H^1(\Omega)$. We will prove this in Corollary 1.12 below.

If no extra regularity of u is available, then the above argument shows that any minimizer u of \mathcal{E} is a *weak solution*, in the following sense.

Definition 1.9. We say that u is a *weak solution* of the Dirichlet problem (1.10) whenever $u \in H^1(\Omega)$, $u|_{\partial\Omega} = g$, and

$$\int_{\Omega} \nabla u \cdot \nabla v dx = 0 \quad \text{for all } v \in H_0^1(\Omega).$$

Here, $u|_{\partial\Omega}$ is the trace of u on $\partial\Omega$; recall **(S5)** above.

More generally, given $f \in L^2(\Omega)$, we say that u satisfies $-\Delta u = f$ in Ω in the weak sense whenever $u \in H^1(\Omega)$ and

$$\int_{\Omega} \nabla u \cdot \nabla v dx = \int_{\Omega} f v \quad \text{for all } v \in H_0^1(\Omega).$$

Finally, we say that u is *weakly superharmonic* (resp. *weakly subharmonic*) in Ω , or satisfies $\Delta u \leq 0$ in Ω in the weak sense (resp. $\Delta u \geq 0$ in the weak sense) if

$$\int_{\Omega} \nabla u \cdot \nabla v dx \geq 0 \quad \left(\text{resp. } \int_{\Omega} \nabla u \cdot \nabla v dx \leq 0 \right) \quad \text{for all } v \in H_0^1(\Omega), v \geq 0.$$

— DRAFT —

Notice that, if $H^1(\Omega) \ni u_k \rightharpoonup u \in H^1(\Omega)$ weakly in H^1 , and $L^2(\Omega) \ni f_k \rightharpoonup f \in L^2(\Omega)$ weakly in L^2 are such that $\Delta u_k = f_k$ in Ω in the weak sense, then $\Delta u = f$ in the weak sense as well (by taking the limits in the previous definitions). Similarly, the weak limit of weakly (sub-)superharmonic functions is (sub-)superharmonic.

We next show the following:

Theorem 1.10 (Existence and uniqueness of weak solutions). *Assume that $\Omega \subset \mathbb{R}^n$ is any bounded Lipschitz domain, and that*

$$(1.14) \quad \{w \in H^1(\Omega) : w|_{\partial\Omega} = g\} \neq \emptyset.$$

Then, there exists a unique weak solution to the Dirichlet problem (1.10).

Proof. EXISTENCE. Let

$$\theta_\circ := \inf \left\{ \frac{1}{2} \int_{\Omega} |\nabla w|^2 dx : w \in H^1(\Omega), w|_{\partial\Omega} = g \right\},$$

that is, the infimum value of $\mathcal{E}(w)$ among all admissible functions w .

Let us take a sequence of functions $\{u_k\}$ such that

- $u_k \in H^1(\Omega)$
- $u_k|_{\partial\Omega} = g$
- $\mathcal{E}(u_k) \rightarrow \theta_\circ$ as $k \rightarrow \infty$.

By the Poincaré inequality (Theorem 1.6 with $p = 2$), the sequence $\{u_k\}$ is uniformly bounded in $H^1(\Omega)$, and therefore a subsequence $\{u_{k_j}\}$ will converge to a certain function u strongly in $L^2(\Omega)$ and weakly in $H^1(\Omega)$ (recall (1.3)-(1.5) in **(S4)**). Moreover, by compactness of the trace operator, we will have $u_{k_j}|_{\partial\Omega} \rightarrow u|_{\partial\Omega}$ in $L^2(\partial\Omega)$, so that $u|_{\partial\Omega} = g$. Furthermore, such function u will satisfy $\mathcal{E}(u) \leq \liminf_{j \rightarrow \infty} \mathcal{E}(u_{k_j})$ (by (1.4) and (1.5)), and therefore it will be a minimizer of the energy functional.

Thus, we have constructed a minimizer u of the energy functional $\mathcal{E}(u)$ satisfying the boundary condition $u|_{\partial\Omega} = g$. By the argument above, for any minimizer u we have that (1.13) holds. Since $C_c^\infty(\Omega)$ is dense in $H_0^1(\Omega)$, it follows that (1.13) holds for all $v \in H_0^1(\Omega)$, and thus it is a weak solution of (1.10).

UNIQUENESS. If u is any weak solution to (1.10), then for every $v \in H_0^1(\Omega)$ we have

$$\begin{aligned} \mathcal{E}(u+v) &= \frac{1}{2} \int_{\Omega} |\nabla u + \nabla v|^2 dx \\ &= \frac{1}{2} \int_{\Omega} |\nabla u|^2 dx + \int_{\Omega} \nabla u \cdot \nabla v dx + \frac{1}{2} \int_{\Omega} |\nabla v|^2 dx \\ &= \mathcal{E}(u) + 0 + \frac{1}{2} \int_{\Omega} |\nabla v|^2 dx \geq \mathcal{E}(u), \end{aligned}$$

with strict inequality if $v \neq 0$. Thus, if u solves (1.10), then it is unique. \square

In other words, we have shown that u is a weak solution of (1.10) if and only if it minimizes the functional $\mathcal{E}(u)$ and, moreover, the minimizer of such energy functional exists and it is unique.

Remark 1.11. An interesting question is to determine the set of possible boundary data $g : \partial\Omega \rightarrow \mathbb{R}$ such that (1.14) holds. Of course, when Ω is any bounded Lipschitz domain, and g is Lipschitz, then it is easy to show that g has a Lipschitz extension inside Ω , and in particular (1.14) holds. However, if g is very irregular then it might happen that it is *not* the trace of any $H^1(\Omega)$ function, so that (1.14) fails in this case. It turns out that the right condition on g is the following: Given any bounded Lipschitz domain Ω , (1.14) holds if and only if

$$\int_{\partial\Omega} \int_{\partial\Omega} \frac{|g(x) - g(y)|^2}{|x - y|^{n+1}} dx dy < \infty.$$

We refer to [Eva98] for more details.

Poisson kernel and fundamental solution. The unique weak solution to the Dirichlet problem in a ball is explicit:

$$\begin{cases} \Delta u = 0 & \text{in } B_1 \\ u = g & \text{on } \partial B_1, \end{cases} \implies u(x) = c_n \int_{\partial B_1} \frac{(1 - |x|^2)g(\sigma)}{|x - \sigma|^n} d\sigma,$$

where c_n is a positive dimensional constant. By an easy rescaling argument, a similar formula holds in any ball $B_r(x_0) \subset \mathbb{R}^n$.

Thus, we deduce that for any harmonic function $\Delta u = 0$ in Ω , with $B_r \subset \Omega$, we have

$$(1.15) \quad u(x) = \frac{c_n}{r} \int_{\partial B_r} \frac{(r^2 - |x|^2)u(y)}{|x - y|^n} dy.$$

By taking $x = 0$, this yields the *mean value property* $u(0) = \int_{\partial B_r} u$. Moreover, an immediate consequence of the Poisson kernel representation is the following.

Corollary 1.12. *Let $\Omega \subset \mathbb{R}^n$ be any open set, and $u \in H^1(\Omega)$ be any function satisfying $\Delta u = 0$ in Ω in the weak sense. Then, u is C^∞ inside Ω .*

Moreover, if u is bounded and $\Delta u = 0$ in B_1 in the weak sense, then we have the estimates

$$(1.16) \quad \|u\|_{C^k(B_{1/2})} \leq C_k \|u\|_{L^\infty(B_1)},$$

for all $k \in \mathbb{N}$, and for some constant C_k depending only on k and n .

Proof. For any ball $B_r(x_o) \subset \Omega$, we will have (1.15). Thanks to such representation, it is immediate to see then that $u \in C^\infty(B_{r/2}(x_o))$ and the estimates (1.16) hold. Since this can be done for any ball $B_r(x_o) \subset \Omega$, we deduce that u is C^∞ inside Ω . \square

On the other hand, we recall that the *fundamental solution* for the Laplacian is given by

$$(1.17) \quad \Phi(x) := \begin{cases} \frac{\kappa_n}{|x|^{n-2}} & \text{if } n \geq 3 \\ \kappa_2 \log \frac{1}{|x|} & \text{if } n = 2, \end{cases}$$

for some explicit positive dimensional constant κ_n . Such function satisfies $\Delta \Phi = 0$ in $\mathbb{R}^n \setminus \{0\}$, but it is singular at $x = 0$. In fact, it satisfies

$$-\Delta \Phi = \delta_0 \quad \text{in } \mathbb{R}^n,$$

where δ_0 is the Dirac delta function. In particular, we have that $w := \Phi * f$ solves $-\Delta w = f$ in \mathbb{R}^n , for any given f with appropriate decay at infinity.

Maximum principle. The maximum principle states the following: If $\Delta u \geq 0$ in Ω , and $u \in C(\overline{\Omega})$, then

$$\max_{\overline{\Omega}} u = \max_{\partial\Omega} u.$$

In particular, we also deduce the *comparison principle*: if $\Delta u \geq \Delta v$ in Ω , and $u \leq v$ on $\partial\Omega$, then $u \leq v$ in the whole domain Ω .

Recall that a function is said to be *subharmonic* if $-\Delta u \leq 0$, and *superharmonic* if $-\Delta u \geq 0$.

As shown next, the maximum principle actually holds for any weak solution u .

Proposition 1.13. *Let $\Omega \subset \mathbb{R}^n$ be any bounded open set. Assume that $u \in H^1(\Omega)$ satisfies, in the weak sense,*

$$\begin{cases} -\Delta u \geq 0 & \text{in } \Omega \\ u \geq 0 & \text{on } \partial\Omega. \end{cases}$$

Then, $u \geq 0$ in Ω .

Proof. Notice that $-\Delta u \geq 0$ in Ω if and only if

$$(1.18) \quad \int_{\Omega} \nabla u \cdot \nabla v \, dx \geq 0 \quad \text{for all } v \geq 0, v \in H_0^1(\Omega).$$

Let us consider $u^- := \max\{-u, 0\}$ and $u^+ := \max\{u, 0\}$, so that $u = u^+ - u^-$. By **(S9)** we have that $u^\pm \in H^1(\Omega)$ whenever $u \in H^1(\Omega)$, and thus we can choose $v = u^- \geq 0$ in (1.18). Namely, using that $u^+u^- = 0$ and $\nabla u = \nabla u^+ - \nabla u^-$, we get

$$0 \leq \int_{\Omega} \nabla u \cdot \nabla u^- \, dx = - \int_{\Omega} |\nabla u^-|^2 \, dx.$$

Since $u^-|_{\partial\Omega} \equiv 0$ this implies $u^- \equiv 0$ in Ω , that is, $u \geq 0$ in Ω . \square

A useful consequence of the maximum principle is the following.

Lemma 1.14. *Let u be any weak solution of*

$$\begin{cases} \Delta u = f & \text{in } \Omega \\ u = g & \text{on } \partial\Omega. \end{cases}$$

Then,

$$\|u\|_{L^\infty(\Omega)} \leq C(\|f\|_{L^\infty(\Omega)} + \|g\|_{L^\infty(\partial\Omega)}),$$

for a constant C depending only on the diameter of Ω .

Proof. Let us consider the function

$$\tilde{u}(x) := u(x) / (\|f\|_{L^\infty(\Omega)} + \|g\|_{L^\infty(\partial\Omega)}).$$

We want to prove that $|\tilde{u}| \leq C$ in Ω , for some constant C depending only on the diameter of Ω .

Notice that such function \tilde{u} solves

$$\begin{cases} \Delta \tilde{u} = \tilde{f} & \text{in } \Omega \\ \tilde{u} = \tilde{g} & \text{on } \partial\Omega, \end{cases}$$

with $|\tilde{g}| \leq 1$ and $|\tilde{f}| \leq 1$.

Let us choose R large enough so that $B_R \supset \Omega$; after a translation, we can take $R = \frac{1}{2}\text{diam}(\Omega)$. In B_R , let us consider the function

$$w(x) = \frac{R^2 - |x|^2}{2} + 1.$$

Such function w satisfies

$$\begin{cases} \Delta w = -1 & \text{in } \Omega \\ w \geq 1 & \text{on } \partial\Omega, \end{cases}$$

Therefore, by the comparison principle, we deduce that

$$\tilde{u} \leq w \quad \text{in } \Omega.$$

Since $w \leq C$ (with C depending only on R), we deduce that $\tilde{u} \leq C$ in Ω . Finally, repeating the same argument with $-\tilde{u}$ instead of \tilde{u} , we find that $|\tilde{u}| \leq C$ in Ω , and thus we are done. \square

Finally, another important result which follows from the maximum principle is the following. Here, we say that Ω satisfies the interior ball condition whenever there exists $\rho_o > 0$ such that every point on $\partial\Omega$ can be touched from inside with a ball of radius ρ_o contained in $\bar{\Omega}$. That is, for any $x_o \in \partial\Omega$ there exists $B_{\rho_o}(y_o) \subset \Omega$ with $x_o \in \partial B_{\rho_o}(y_o)$.

It is not difficult to see that any C^2 domain satisfies such condition, and also any domain which is the complement of a convex set.

Lemma 1.15 (Hopf Lemma). *Let $\Omega \subset \mathbb{R}^n$ be any domain satisfying the interior ball condition. Let $u \in C(\bar{\Omega})$ be any positive harmonic function in $\Omega \cap B_2$, with $u \geq 0$ on $\partial\Omega \cap B_2$.*

Then, $u \geq c_o d$ in $\Omega \cap B_1$ for some $c_o > 0$, where $d(x) := \text{dist}(x, \Omega^c)$.

Proof. Since u is positive and continuous in $\Omega \cap B_2$, we have that $u \geq c_1 > 0$ in $\{d \geq \rho_o/2\} \cap B_{3/2}$ for some $c_1 > 0$.

Let us consider the solution of $\Delta w = 0$ in $B_{\rho_o} \setminus B_{\rho_o/2}$, with $w = 0$ on ∂B_{ρ_o} and $w = 1$ on $\partial B_{\rho_o/2}$. Such function w is explicit — it is simply a truncated and rescaled version of the fundamental solution Φ in (1.17). In particular, it is immediate to check that $w \geq c_2(\rho_o - |x|)$ in B_{ρ_o} for some $c_2 > 0$.

By using the function $c_1 w(x_o + x)$ as a subsolution in any ball $B_{\rho_o}(x_o) \subset \Omega \cap B_{3/2}$, we deduce that $u(x) \geq c_1 w(x_o + x) \geq c_1 c_2(\rho_o - |x - x_o|) \geq c_1 c_2 d$ in $B_{\rho_o}(x_o)$. Setting $c_o = c_1 c_2$ and using the previous inequality for every ball $B_{\rho_o}(x_o) \subset \Omega \cap B_{3/2}$, the result follows. \square

Mean value property and Liouville theorem. If u is harmonic in Ω (i.e., $\Delta u = 0$ in Ω), then

$$(1.19) \quad u(x) = \int_{B_r(x)} u(y) dy \quad \text{for any ball } B_r(x) \subset \Omega.$$

This is called the mean value property.

Conversely, if $u \in C^2(\Omega)$ satisfies the mean value property, then $\Delta u = 0$ in Ω . This can be seen for example by using (1.11) above.

In fact, the mean value property (1.19) can be used to give yet another (weak) definition of harmonic functions that only requires u to be locally integrable. Similarly, it is not difficult to deduce the corresponding property arising from the definitions of weak super- and subharmonicity (see Definition 1.9):

From (1.12), if u is weakly superharmonic in Ω ($\Delta u \leq 0$ in Ω in the weak sense) then for all $x \in \Omega$

$$(1.20) \quad r \mapsto \int_{B_r(x)} u(y) dy \quad \text{is monotone non-increasing for } r \in (0, \text{dist}(x, \partial\Omega)).$$

(And it is monotone non-decreasing for weakly subharmonic functions.)

Thus, we can define (weak) super- and subharmonicity for L^1_{loc} functions: we say that $u \in L^1_{\text{loc}}(\Omega)$ is superharmonic in Ω if (1.20) holds for all $x \in \Omega$. Similarly, we say that $u \in L^1_{\text{loc}}(\Omega)$ is subharmonic in Ω if the map in (1.20) is monotone non-decreasing for all $x \in \Omega$ and $r \in (0, \text{dist}(x, \partial\Omega))$.

We now give two lemmas that will be used in Chapter 5. The first lemma says that the pointwise limit of a sequence of superharmonic uniformly bounded functions is superharmonic.

Lemma 1.16. *Let $\Omega \subset \mathbb{R}^n$, and let $\{w_n\}_{n \in \mathbb{N}}$ be a sequence of uniformly bounded functions $w_n : \Omega \rightarrow \mathbb{R}$ satisfying (1.20), converging pointwise to some $w : \Omega \rightarrow \mathbb{R}$. Then w satisfies (1.20).*

Proof. Let $w_\infty := w$ and let us define for $n \in \mathbb{N} \cup \{\infty\}$, $\varphi_{x,n}(r) := \int_{B_r(x)} w_n$. Notice that $\varphi_{x,n}(r)$ is non-increasing in r for all $n \in \mathbb{N}$. In particular, given $0 < r_1 < r_2 < R_x$, we have that $\varphi_{x,n}(r_1) \geq \varphi_{x,n}(r_2)$ for $n \in \mathbb{N}$. Now we let $n \rightarrow \infty$ and use that $w_n \rightarrow w$ pointwise to deduce, by the dominated convergence theorem (notice that w_n are uniformly bounded), that $\varphi_{x,\infty}(r_1) \geq \varphi_{x,\infty}(r_2)$. That is, $w_\infty = w$ satisfies (1.20). \square

The second lemma shows that superharmonic functions are lower semi-continuous.

Lemma 1.17. *Let us assume that w is bounded and satisfies (1.20) in $\Omega \subset \mathbb{R}^n$. Then, up to changing w in a set of measure 0, w is lower semi-continuous.*

Proof. The proof is standard. If we define $w_0(x) := \lim_{r \downarrow 0} \int_{B_r(x)} w$ (which is well defined, since the average is monotone non-increasing), then $w_0(x) = w(x)$ if x is a Lebesgue point, and thus $w_0 = w$ almost everywhere in Ω . Let us now consider $x_\circ \in \Omega$, and let $x_k \rightarrow x_\circ$ as $k \rightarrow \infty$. Then, by the dominated convergence theorem we have that

$$\int_{B_r(x_\circ)} w = \lim_{k \rightarrow \infty} \int_{B_r(x_k)} w \leq \liminf_{k \rightarrow \infty} w_0(x_k)$$

for $0 < r < \frac{1}{2} \text{dist}(x_\circ, \partial\Omega)$. Now, by letting $r \downarrow 0$ on the left-hand side, we reach that

$$w_0(x_\circ) \leq \liminf_{k \rightarrow \infty} w_0(x_k),$$

that is, w_0 is lower semi-continuous. \square

On the other hand, a well-known theorem that can be deduced from the mean value property is the classification of global bounded harmonic functions.

Theorem 1.18 (Liouville's theorem). *Any bounded solution of $\Delta u = 0$ in \mathbb{R}^n is constant.*

Proof. Let u be any global bounded solution of $\Delta u = 0$ in \mathbb{R}^n . Since u is smooth (by Corollary 1.12), each derivative $\partial_i u$ is well-defined and is harmonic too. Thus, thanks to the mean-value property and the divergence theorem, for any $x \in \mathbb{R}^n$ and $R \geq 1$ we have

$$|\partial_i u(x)| = \left| \frac{c_n}{R^n} \int_{B_R(x)} \partial_i u \right| = \left| \frac{c_n}{R^n} \int_{\partial B_R(x)} u(y) \frac{y_i}{|y|} dy \right| \leq \frac{C}{R^n} \int_{\partial B_R(x)} |u|.$$

Thus, using that $|u| \leq M$ in \mathbb{R}^n , we find

$$\begin{aligned} |\partial_i u(x)| &\leq \frac{c_n}{R^n} |\partial B_R(x)| M \\ &= \frac{c_n}{R^n} |\partial B_1| R^{n-1} M = \frac{c_n M}{R} \rightarrow 0, \quad \text{as } R \rightarrow \infty. \end{aligned}$$

Therefore, $\partial_i u(x) = 0$ for all $x \in \mathbb{R}^n$, and u is constant. \square

More generally, one can even prove a classification result for functions with polynomial growth. Here, for $\gamma \in \mathbb{R}$, $[\gamma]$ denotes the floor function, that is, the largest integer less or equal to γ .

Proposition 1.19 (Liouville's theorem with growth). *Assume that u is a solution of $\Delta u = 0$ in \mathbb{R}^n satisfying $|u(x)| \leq C(1 + |x|^\gamma)$ for all $x \in \mathbb{R}^n$, with $\gamma > 0$. Then, u is a polynomial of degree at most $[\gamma]$.*

Proof. Let us define $u_R(x) := u(Rx)$, and notice that $\Delta u_R = 0$ in \mathbb{R}^n . From Corollary 1.12 and the growth assumption

$$\begin{aligned} R^k \|D^k u\|_{L^\infty(B_{R/2})} &= \|D^k u_R\|_{L^\infty(B_{1/2})} \\ &\leq C_k \|u_R\|_{L^\infty(B_1)} = C_k \|u\|_{L^\infty(B_R)} \leq C_k R^\gamma. \end{aligned}$$

In particular, if $k = [\gamma] + 1$,

$$\|D^k u\|_{L^\infty(B_{R/2})} \leq C_k R^{\gamma-k} \rightarrow 0 \quad \text{as } R \rightarrow \infty.$$

That is, $D^k u \equiv 0$ in \mathbb{R}^n , and u is a polynomial of degree $k - 1 = [\gamma]$. \square

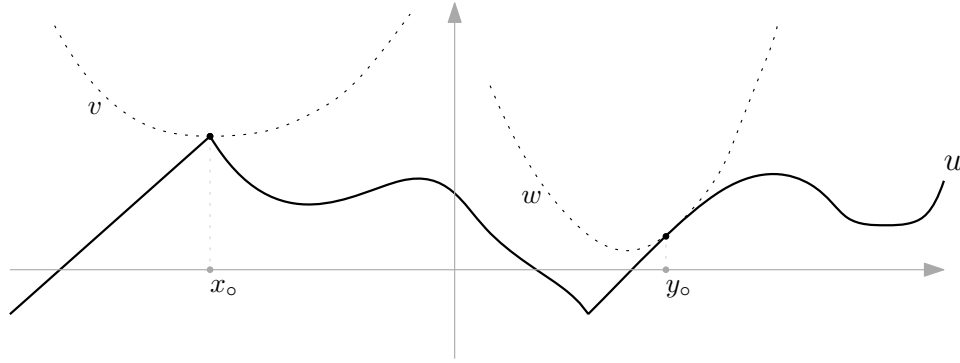

Figure 1.1. v touches u from above at x_0 , w touches u from above at y_0 .

Existence of solutions: comparison principle. We saw that one way to prove existence of solutions to the Dirichlet problem for the Laplacian is by using *energy methods*. With such approach, one proves in fact the existence of a *weak solution* $u \in H^1(\Omega)$.

Now, we will see an alternative way to construct solutions: via the *comparison principle*. With this method, one can show the existence of a *viscosity solution* $u \in C(\bar{\Omega})$.

For the Laplace equation, these solutions (weak or viscosity) can then be proved to be $C^\infty(\Omega)$, and thus they coincide.

We start by giving the definition of sub- and superharmonicity *in the viscosity sense*. It is important to remark that in such definition the function u is only required to be *continuous*.

Definition 1.20. A function $u \in C(\bar{\Omega})$ is *subharmonic* (in the viscosity sense) if for every function $v \in C^2$ such that v touches u from above at $x_0 \in \Omega$ (that is, $v \geq u$ in Ω and $v(x_0) = u(x_0)$), we have $\Delta v(x_0) \geq 0$. See Figure 1.1.

The definition of *superharmonicity* for $u \in C(\Omega)$ is analogous (touching from below and with $\Delta v(x_0) \leq 0$).

A function $u \in C(\Omega)$ is *harmonic* if it is both sub- and superharmonic in the above viscosity sense.

This definition obviously coincides with the one we know in case $u \in C^2$. However, it allows non- C^2 functions u , for example $u(x) = |x|$ is subharmonic and $-|x|$ is superharmonic.

A useful property of viscosity sub-/supersolutions is the following.

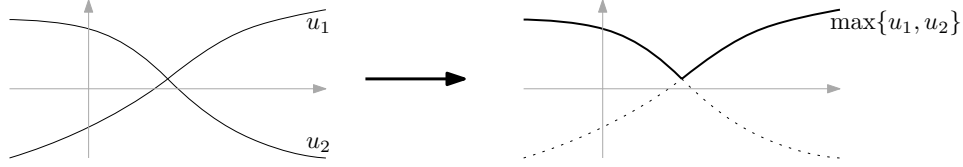

Figure 1.2. The maximum of two functions u_1 and u_2 .

Proposition 1.21. *The maximum of two subharmonic functions is also subharmonic. That is, if $u_1, u_2 \in C(\Omega)$ are subharmonic, then the function $v := \max\{u_1, u_2\}$ is subharmonic as well. See Figure 1.2.*

Similarly, the minimum of two superharmonic functions is superharmonic.

The proof follows easily from Definition 1.20 above, and it is left as an exercise to the reader.

Moreover, we also have the following:

Proposition 1.22. *Let $\Omega \subset \mathbb{R}^n$ be a bounded domain, and assume that $u \in C(\bar{\Omega})$ satisfies, in the viscosity sense,*

$$\begin{cases} -\Delta u \geq 0 & \text{in } \Omega \\ u \geq 0 & \text{on } \partial\Omega. \end{cases}$$

Then, $u \geq 0$ in Ω .

Proof. After a rescaling, we may assume $\Omega \subset B_1$.

Assume by contradiction that u has a negative minimum in Ω . Then, since $u \geq 0$ on $\partial\Omega$, we have $\min_{\bar{\Omega}} u = -\delta$, with $\delta > 0$, and the minimum is achieved in Ω .

Let us now consider $0 < \varepsilon < \delta$, and $v(x) := -\kappa + \varepsilon(|x|^2 - 1)$, with $\kappa > 0$ (that is, a sufficiently flat paraboloid).

Now, notice that $u - v > 0$ on $\partial\Omega$, and that we can choose $\kappa > 0$ so that $\min_{\bar{\Omega}}(u - v) = 0$. That is, we can slide the paraboloid from below the solution u until we touch it, by assumption, at an interior point. Thus, there exists $x_\circ \in \Omega$ such that $u(x_\circ) - v(x_\circ) = \min_{\bar{\Omega}}(u - v) = 0$. Therefore, with such choice of κ , the function v touches u from below at $x_\circ \in \Omega$, and hence, by definition of viscosity solution, we must have

$$\Delta v(x_\circ) \leq 0.$$

However, a direct computation gives $\Delta v \equiv 2n\varepsilon > 0$ in Ω , a contradiction. \square

Thanks to these two propositions, the existence of a (viscosity) solution to the Dirichlet problem can be shown as follows.

Let

$$S_g := \{v \in C(\overline{\Omega}) : v \text{ is subharmonic, and } v \leq g \text{ on } \partial\Omega\},$$

and define the pointwise supremum

$$u(x) := \sup_{v \in S_g} v(x).$$

Then, it can be shown that, if Ω is regular and g is continuous, then $u \in C(\overline{\Omega})$, and $\Delta u = 0$ in Ω , with $u = g$ on $\partial\Omega$. This is the so-called *Perron method*. We refer to [HL97] for a complete description of the method in case of the Laplace operator.

In Chapter 3 we will study the existence of viscosity solutions in the more general setting of fully nonlinear elliptic equations.

Short summary on existence of solutions. We have *two completely different ways* to construct solutions: by energy methods; or by the maximum (or comparison) principle.

In the first case, the constructed solution belongs to $H^1(\Omega)$, in the second case to $C(\overline{\Omega})$. In any case, one can then prove that $u \in C^\infty(\Omega) \cap C(\overline{\Omega})$ — as long as Ω and g are regular enough — and therefore u solves the Dirichlet problem in the usual sense.

1.3. Probabilistic interpretation of harmonic functions

To end this introductory chapter, we give a well-known probabilistic interpretation of harmonic functions. The discussion will be mostly heuristic, just to give an intuition on the Laplace equation in terms of stochastic processes. We refer to Appendix C for further probabilistic interpretations for fully nonlinear equations and for the obstacle problem.

Recall that the *Brownian motion* is a stochastic process X_t , $t \geq 0$, satisfying the following properties:

- (1) $X_0 = 0$ almost surely.
- (2) X_t has *no memory* (is independent of the past, or it has independent increments).
- (3) X_t has *stationary increments*: $X_{t+s} - X_s$ is equal in distribution to X_t .
- (4) X_t has *continuous paths* ($t \mapsto X_t$ is continuous) almost surely.
- (5) X_t is *isotropic*, i.e., it is rotationally symmetric in distribution.

The previous properties actually determine the stochastic process X_t up to a multiplicative constant. Another important property of Brownian motion is that it is scale invariant, i.e.,

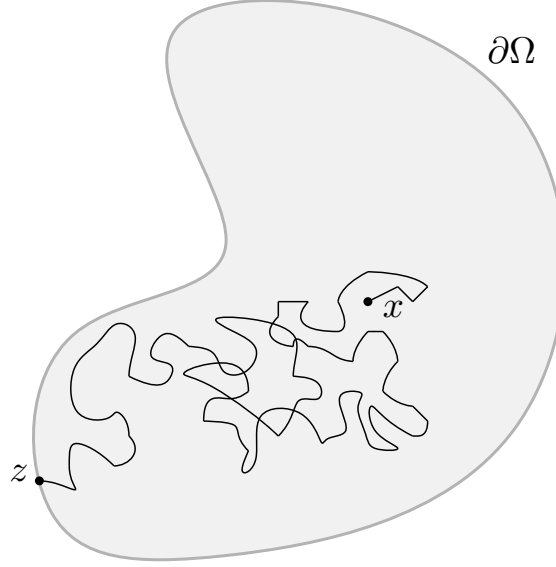

Figure 1.3. A stochastic process X_t^x defined in Ω starting at x until it hits the first point on the boundary $z \in \partial\Omega$.

(6) $r^{-1}X_{r^2t}$ equals X_t in distribution, for any $r > 0$.

As we will see next, there is a strong connection between the Brownian motion and the Laplace operator.

Expected payoff. Given a regular domain $\Omega \subset \mathbb{R}^n$, and a Brownian motion X_t^x starting at x (i.e., $X_t^x := x + X_t$), we play the following stochastic game: When the process X_t^x hits the boundary $\partial\Omega$ for the first time we get a *payoff* $g(z)$, depending on the hitting point $z \in \partial\Omega$. (See Figure 1.3.)

We then ask ourselves:

What is the expected payoff?

To answer this question, we define

$$\begin{aligned} \tau &:= \text{first hitting time of } X_t^x, \\ u(x) &:= \mathbb{E}[g(X_\tau^x)] \quad (\text{value function}). \end{aligned}$$

The value of $u(x)$ is, by definition, the answer to the question above. Namely, it is the expected value of g at the first point where X_t^x hits the boundary $\partial\Omega$.

To find $u(x)$, we try to relate it with values of $u(y)$ for $y \neq x$. Then, we will see that this yields a *PDE for u* , and by solving it we can find $u(x)$.

Indeed, let us consider a ball $B_r(x) \subset \Omega$, with $r > 0$. For any such ball, we know that the process X_t^x will hit (before reaching $\partial\Omega$, by property (4))

some point on $\partial B_r(x)$, and moreover any point on $\partial B_r(x)$ will be hit with the *same probability*. This is because the process is *rotationally symmetric in distribution*, (5).

Since the process has *no memory*, (2), and *stationary increments*, (3), this means that

$$(1.21) \quad u(x) = \int_{\partial B_r(x)} u(y) dy.$$

Heuristically, this is because when the process hits the boundary $\partial B_r(x)$ at a point y , it simply starts again the game from such point y . But because all points $y \in \partial B_r(x)$ are reached for the first time with the same probability, then (1.21) holds.

Now, since this can be done for every $x \in \Omega$ and $r > 0$, we deduce that $u(x)$ satisfies the mean value property, and therefore it is harmonic, $\Delta u = 0$ in Ω , (1.11).

Moreover, since we also know that $u = g$ on $\partial\Omega$ (since when we hit the boundary we get the payoff g surely), then u must be the unique solution of

$$\begin{cases} \Delta u = 0 & \text{in } \Omega \\ u = g & \text{on } \partial\Omega. \end{cases}$$

We refer to [Law10] for a nice introduction to this topic.

Expected hitting time. A similar stochastic problem is the following. Given a smooth domain $\Omega \subset \mathbb{R}^n$, and a Brownian motion X_t^x , we ask:

What is the expected first time at which X_t^x will hit $\partial\Omega$?

To answer this question, we argue as before, using that the process must first hit the boundary of balls $B_r(x) \subset \Omega$. Indeed, we first denote by $u(x)$ the expected hitting time that we are looking for. Then, for any such ball we have that the process X_t^x will hit (before reaching $\partial\Omega$) some point on $\partial B_r(x)$, and moreover any point $y \in \partial B_r(x)$ will be hit with the same probability. Thus, the total expected time $u(x)$ will be the expected time it takes to hit $\partial B_r(x)$ for the first time, *plus* the expected time when we start from the corresponding point $y \in \partial B_r(x)$, which is $u(y)$. In other words, we have

$$u(x) = T(r) + \int_{\partial B_r(x)} u(y) dy.$$

Here, $T(r)$ is the expected first time at which X_t^x hits $\partial B_r(x)$ — which clearly depends only on r and n .

Now, using the scale-invariance property of the Brownian motion, i.e. $r^{-1}X_{r^2t} \sim X_t$, we see that $T(r) = T(1)r^2 = c_1 r^2$ for some constant $c_1 > 0$.

Thus, we have

$$u(x) = c_1 r^2 + \int_{\partial B_r(x)} u(y) dy,$$

and by rearranging terms we find

$$-\frac{1}{r^2} \left\{ \int_{B_r(x)} u(y) dy - u(x) \right\} = c_1.$$

Finally, taking $r \rightarrow 0$ and using (1.11), we deduce that $-\Delta u = c_2$, for some constant $c_2 > 0$. Since we clearly have $u = 0$ on $\partial\Omega$, the expected hitting time $u(x)$ is the unique solution of the problem

$$\begin{cases} -\Delta u = c_2 & \text{in } \Omega \\ u = 0 & \text{on } \partial\Omega. \end{cases}$$

By considering a *non-homogeneous* medium (in which it takes more time to move in some regions than others), the same argument leads to the problem with a right-hand side

$$\begin{cases} -\Delta u = f(x) & \text{in } \Omega \\ u = 0 & \text{on } \partial\Omega, \end{cases}$$

with $f \geq 0$.

Linear elliptic PDE

In this chapter we will study linear elliptic PDEs of the type

$$(2.1) \quad \operatorname{tr}(A(x)D^2u(x)) = \sum_{i,j=1}^n a_{ij}(x)\partial_{ij}u = f(x) \quad \text{in } \Omega \subset \mathbb{R}^n,$$

as well as

$$(2.2) \quad \operatorname{div}(A(x)\nabla u(x)) = \sum_{i,j=1}^n \partial_i(a_{ij}(x)\partial_j u(x)) = f(x) \quad \text{in } \Omega \subset \mathbb{R}^n.$$

These are elliptic PDEs in non-divergence and divergence form, respectively.

The coefficients $(a_{ij}(x))_{ij}$ and the right-hand side $f(x)$ satisfy appropriate regularity assumptions. In addition, we will assume that the coefficient matrix $A(x) = (a_{ij}(x))_{ij}$ satisfies the *uniform ellipticity* condition

$$0 < \lambda \operatorname{Id} \leq (a_{ij}(x))_{ij} \leq \Lambda \operatorname{Id},$$

for some ellipticity constants $0 < \lambda \leq \Lambda < \infty$. (For two matrices $A, B \in \mathcal{M}_n$, we say $A \geq B$ if the matrix $A - B$ is positive semi-definite.)

We will show that, under appropriate regularity assumptions on $A(x)$, solutions u to (2.1) “gain two derivatives” with respect to f and the coefficients $A(x)$. On the other hand, for the divergence-form equation, (2.2), we expect solutions to “gain one derivative” with respect to the coefficients $A(x)$.

In order to do that, we will use perturbative methods, by “freezing” the coefficients around a certain point and studying the constant coefficient equation first. After a change of variables, one can transform the constant coefficient equation into the most ubiquitous and simple elliptic equation:

Laplace's equation, where $(a_{ij}(x))_{ij}$ is the identity. Thus, we will begin the chapter by studying properties of Laplace's equation such as Harnack's inequality and the Hölder regularity with bounded right-hand side. After that, we proceed by showing Schauder estimates for the Laplacian to continue with the main theorems of the current chapter: Schauder estimates for (2.1) and (2.2).

We finish the chapter by studying equations of the type (2.1) and (2.2) with continuous coefficients. In this case we do not gain two (resp. one) derivatives, and instead we lose an arbitrarily small Hölder exponent of regularity.

Equations in non-divergence and divergence form will become particularly useful in Chapters 3 and 4 in the context of nonlinear variational PDEs and fully nonlinear elliptic PDEs.

For both equations in non-divergence and divergence form, we establish *a priori* estimates. That is, rather than proving that the solution is regular, we show that if the solution is regular, then one can actually estimate the norm of respectively two and one derivative higher in terms of the Hölder norms of the coefficients $(a_{ij}(x))_{ij}$ and the right-hand side f . This is enough for the application to nonlinear equations in Chapters 3 and 4.

When the operator is the Laplacian, thanks to the *a priori* estimates, and by means of an approximation argument, we show that weak solutions are in fact smooth. For more general elliptic operators, *a priori* estimates together with the continuity method yield the existence of regular solutions. We refer the reader to [GT77] for such an approach.

2.1. Harnack's inequality

We start this chapter with one of the most basic estimates for harmonic functions. It essentially gives a kind of “maximum principle in quantitative form”.

We will usually write that $u \in H^1$ is harmonic, meaning in the weak sense. Recall from the introduction, however, that as soon as a function is harmonic, it is immediately C^∞ .

Theorem 2.1 (Harnack's inequality). *Assume $u \in H^1(B_1)$ is a non-negative, harmonic function in B_1 . Then the infimum and the supremum of u are comparable in $B_{1/2}$. That is,*

$$\begin{cases} \Delta u = 0 & \text{in } B_1 \\ u \geq 0 & \text{in } B_1 \end{cases} \quad \Rightarrow \quad \sup_{B_{1/2}} u \leq C \inf_{B_{1/2}} u,$$

for some constant C depending only on n .

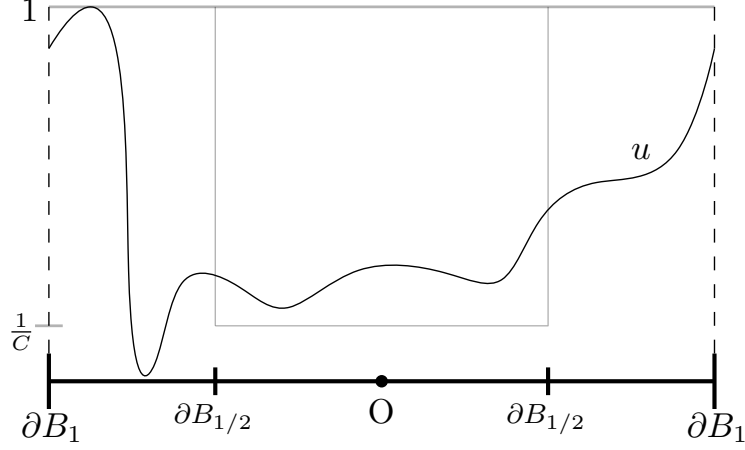

Figure 2.1. Graphic representation of Harnack's inequality for a harmonic function $u > 0$ such that $\sup_{B_1} u = 1$.

Proof. This can be proved by the mean value property. Alternatively, we can also use the Poisson kernel representation,

$$u(x) = c_n \int_{\partial B_1} \frac{(1 - |x|^2)u(z)}{|x - z|^n} dz.$$

Notice that, for any $x \in B_{1/2}$ and $z \in \partial B_1$, we have $2^{-n} \leq |x - z|^n \leq (3/2)^n$ and $3/4 \leq 1 - |x|^2 \leq 1$. Thus, since $u \geq 0$ in B_1 ,

$$C^{-1} \int_{\partial B_1} u(z) dz \leq u(x) \leq C \int_{\partial B_1} u(z) dz, \quad \text{for all } x \in B_{1/2},$$

for some dimensional constant C . In particular, for any $x_1, x_2 \in B_{1/2}$ we have that $u(x_1) \leq C^2 u(x_2)$. Taking the infimum for $x_2 \in B_{1/2}$ and the supremum for $x_1 \in B_{1/2}$, we reach that $\sup_{B_{1/2}} u \leq \tilde{C} \inf_{B_{1/2}} u$, for some dimensional constant \tilde{C} , as desired. \square

Remark 2.2. This inequality says that, if $u \geq 0$ in B_1 , then not only $u > 0$ in $B_{1/2}$ (strong maximum principle), but also we get quantitative information: $u \geq C^{-1} \sup_{B_{1/2}} u$ in $B_{1/2}$, for some constant C depending only on n . See Figure 2.1.

Notice that there is nothing special about $B_{1/2}$. We can obtain a similar inequality in B_ρ with $\rho < 1$, but the constant C would depend on ρ as well. Indeed, repeating the previous argument, one gets that if $\Delta u = 0$ and $u \geq 0$ in B_1 , then

$$(2.3) \quad \sup_{B_\rho} u \leq \frac{C}{(1 - \rho)^n} \inf_{B_\rho} u,$$

for some C depending only on n , and where $\rho \in (0, 1)$.

From Harnack's inequality, we deduce the oscillation decay for harmonic functions. That is, the oscillation of a harmonic function is reduced (quantitatively) in smaller domains. The oscillation in a domain Ω is defined as

$$\operatorname{osc}_{\Omega} u := \sup_{\Omega} u - \inf_{\Omega} u.$$

We remark that the following lemma is valid for all harmonic functions, not necessarily positive.

Corollary 2.3 (Oscillation decay). *Let $u \in H^1(B_1)$ be a harmonic function in B_1 , i.e. $\Delta u = 0$ in B_1 . Then*

$$\operatorname{osc}_{B_{1/2}} u \leq (1 - \theta) \operatorname{osc}_{B_1} u$$

for some small $\theta > 0$ depending only on n .

Proof. Let

$$w(x) := u(x) - \inf_{B_1} u,$$

which satisfies $w \geq 0$ in B_1 and $\operatorname{osc}_{B_{1/2}} w = \operatorname{osc}_{B_{1/2}} u$. Since $\Delta w = 0$ in B_1 , we get by Harnack's inequality

$$\sup_{B_{1/2}} w \leq C \inf_{B_{1/2}} w,$$

so that

$$\operatorname{osc}_{B_{1/2}} u = \operatorname{osc}_{B_{1/2}} w = \sup_{B_{1/2}} w - \inf_{B_{1/2}} w \leq \left(1 - \frac{1}{C}\right) \sup_{B_{1/2}} w \leq \left(1 - \frac{1}{C}\right) \sup_{B_1} w.$$

Now notice that $\sup_{B_1} w = \operatorname{osc}_{B_1} u$, and we are done. \square

Remark 2.4 (Alternative proof of Corollary 2.3). Alternatively, we can rewrite the previous proof of Corollary 2.3 by taking advantage of the invariance of the estimate.

Indeed, the function $u - \inf_{B_1} u$ is non-negative and harmonic. Since the estimate we want to prove is invariant under addition and multiplication by constants, we may assume that $\inf_{B_1} u = 0$ and $\sup_{B_1} u = 1$. Let $\theta := \frac{1}{C+1}$, where C is the constant in Harnack's inequality, Theorem 2.1. Now we have two options:

- If $\sup_{B_{1/2}} u \leq 1 - \theta$, we are done,
- If $\sup_{B_{1/2}} u \geq 1 - \theta$ we use Harnack's inequality to get

$$\inf_{B_{1/2}} u \geq \frac{1}{C}(1 - \theta) \geq \theta.$$

In any case, we get $\operatorname{osc}_{B_{1/2}} u \leq 1 - \theta$, so we are done.

Remark 2.5. We have proved that Harnack's inequality implies the oscillation decay. This is *always* true, we did not use the fact that we are dealing with harmonic functions. In general, we have

$$\left(\begin{array}{c} \text{Harnack's} \\ \text{inequality} \end{array} \right) \implies \left(\begin{array}{c} \text{Oscillation} \\ \text{decay} \end{array} \right) \implies \left(\begin{array}{c} \text{Hölder} \\ \text{regularity} \end{array} \right)$$

Harnack's inequality and the oscillation decay are scale invariant. That is, the following corollary holds:

Corollary 2.6 (Rescaled versions). *Let $u \in H^1(B_r)$ be such that $\Delta u = 0$ in B_r . Then*

- (Harnack's inequality) *If $u \geq 0$ in B_r , then*

$$\sup_{B_{r/2}} u \leq C \inf_{B_{r/2}} u,$$

for some C depending only on n .

- (Oscillation decay) *One has*

$$\text{osc}_{B_{r/2}} u \leq (1 - \theta) \text{osc}_{B_r} u,$$

for some small $\theta > 0$ depending only on n .

Proof. Define $\tilde{u}(x) := u(rx)$, which fulfills $\Delta \tilde{u} = 0$ in B_1 and therefore

$$\sup_{B_{r/2}} u = \sup_{B_{1/2}} \tilde{u} \leq C \inf_{B_{1/2}} \tilde{u} = C \inf_{B_{r/2}} u,$$

by Theorem 2.1. Similarly,

$$\text{osc}_{B_{r/2}} u = \text{osc}_{B_{1/2}} \tilde{u} \leq (1 - \theta) \text{osc}_{B_1} \tilde{u} = (1 - \theta) \text{osc}_{B_r} u$$

by Corollary 2.3. □

A standard consequence of the quantitative oscillation decay proved above is the Hölder regularity of solutions.

Corollary 2.7 (Hölder regularity). *Let $u \in H^1(B_1) \cap L^\infty(B_1)$ be such that $\Delta u = 0$ in B_1 . Then*

$$\|u\|_{C^{0,\alpha}(B_{1/2})} \leq C \|u\|_{L^\infty(B_1)}$$

for some constants $\alpha > 0$ and C depending only on n .

Proof. If we denote $\tilde{u} := (2\|u\|_{L^\infty(B_1)})^{-1}u$, then $\tilde{u} \in H^1 \cap L^\infty(B_1)$ fulfills $\Delta \tilde{u} = 0$ in B_1 and $\|\tilde{u}\|_{L^\infty(B_1)} \leq \frac{1}{2}$. If we show $\|\tilde{u}\|_{C^{0,\alpha}(B_{1/2})} \leq C$, then the result will follow.

— DRAFT —

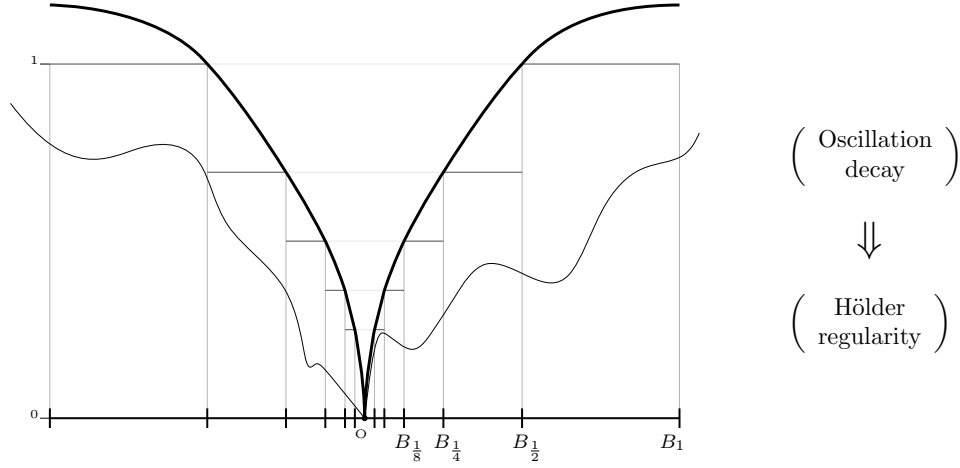

Figure 2.2. Graphical representation of the fact that oscillation decay-type lemmas imply Hölder regularity.

Thus, dividing u by a constant if necessary, we may assume that $\|u\|_{L^\infty(B_1)} \leq \frac{1}{2}$. We need to prove that

$$|u(x) - u(y)| \leq C|x - y|^\alpha \quad \text{for all } x, y \in B_{1/2},$$

for some small $\alpha > 0$. We do it at $y = 0$ for simplicity.

Let $x \in B_{1/2}$ and let $k \in \mathbb{N}$ be such that $x \in B_{2^{-k}} \setminus B_{2^{-(k+1)}}$. Then,

$$|u(x) - u(0)| \leq \operatorname{osc}_{B_{2^{-k}}} u \leq (1 - \theta)^k \operatorname{osc}_{B_1} u \leq (1 - \theta)^k = 2^{-\alpha k},$$

with $\alpha = -\log_2(1 - \theta)$. (Notice that we are using Corollary 2.6 k -times, where the constant θ is independent from the radius of the oscillation decay.)

Now, since $2^{-k} \leq 2|x|$, we find

$$|u(x) - u(0)| \leq (2|x|)^\alpha \leq C|x|^\alpha,$$

as desired. See Figure 2.2 for a graphical representation of this proof. \square

Finally, another important consequence of Harnack's inequality is the Liouville theorem for non-negative harmonic functions.

Corollary 2.8. *Let u be a non-negative harmonic function, that is, $u \geq 0$ and $\Delta u = 0$ in \mathbb{R}^n . Then, u is constant.*

Proof. Let

$$v = u - \inf_{\mathbb{R}^n} u,$$

where $\inf_{\mathbb{R}^n} u$ is well-defined and finite since $u \geq 0$. Then, thanks to Harnack's inequality in arbitrary balls from Corollary 2.6, we get that for any

$R > 0$,

$$\sup_{B_R} v \leq C \inf_{B_R} v = C \left(\inf_{B_R} u - \inf_{\mathbb{R}^n} u \right) \rightarrow 0,$$

as $R \rightarrow \infty$. That is, $\sup_{\mathbb{R}^n} u = \inf_{\mathbb{R}^n} u$ and therefore u is constant in \mathbb{R}^n . \square

Of course, the previous result also holds if $u \geq -M$ in \mathbb{R}^n , for some constant M , since then $u + M$ is non-negative and harmonic.

Harnack's inequality with a right-hand side. We can prove a Harnack inequality for equations with a right-hand side, that is, when the Laplacian is not necessarily zero, $\Delta u = f$. Again, we will be dealing with functions $u \in H^1$, so that we have to understand the equation $\Delta u = f$ in the weak sense.

Theorem 2.9. *Let $f \in L^\infty(B_1)$, and $u \in H^1(B_1)$. Then,*

$$\begin{cases} \Delta u = f & \text{in } B_1 \\ u \geq 0 & \text{in } B_1 \end{cases} \Rightarrow \sup_{B_{1/2}} u \leq C \left(\inf_{B_{1/2}} u + \|f\|_{L^\infty(B_1)} \right),$$

for some C depending only on n .

Proof. We express u as $u = v + w$ with

$$\begin{cases} \Delta v = 0 & \text{in } B_1 \\ v = u & \text{on } \partial B_1 \end{cases} \quad \begin{cases} \Delta w = f & \text{in } B_1 \\ w = 0 & \text{on } \partial B_1. \end{cases}$$

Then, we have

$$\sup_{B_{1/2}} v \leq C \inf_{B_{1/2}} v \quad \text{and} \quad \sup_{B_1} w \leq C \|f\|_{L^\infty(B_1)}$$

by Theorem 2.1 and Lemma 1.14. Thus,

$$\begin{aligned} \sup_{B_{1/2}} u &\leq \sup_{B_{1/2}} v + C \|f\|_{L^\infty(B_1)} \\ &\leq C \inf_{B_{1/2}} v + C \|f\|_{L^\infty(B_1)} \leq C \left(\inf_{B_{1/2}} u + \|f\|_{L^\infty(B_1)} \right), \end{aligned}$$

where we are taking a larger constant if necessary. Notice that we have also used here that $v \leq u + C \|f\|_{L^\infty(B_1)}$. \square

Thus, as before, we also get an oscillation decay, but now involving an error term of size $\|f\|_{L^\infty}$.

Corollary 2.10. *Let $f \in L^\infty(B_1)$ and $u \in H^1(B_1)$. If $\Delta u = f$ in B_1 and $f \in L^\infty(B_1)$, then*

$$\text{osc}_{B_{1/2}} u \leq (1 - \theta) \text{osc}_{B_1} u + 2 \|f\|_{L^\infty(B_1)},$$

for some $\theta > 0$ depending only on n .

Proof. The proof is the same as in the case $f \equiv 0$, see the proof of Corollary 2.3. \square

Remark 2.11. Now, with the right-hand side $f = f(x)$, the equation $\Delta u = f$ and Harnack's inequality are *not* invariant under rescalings in x . In fact, as we zoom-in, the right-hand side gets smaller!

Namely, if $\Delta u = f$ in B_r , then $\tilde{u}(x) := u(rx)$ satisfies $\Delta \tilde{u}(x) = r^2 f(rx)$ in B_1 so that

$$\sup_{B_{1/2}} \tilde{u} \leq C \left(\inf_{B_{1/2}} \tilde{u} + 2r^2 \|f\|_{L^\infty(B_r)} \right),$$

and therefore

$$\sup_{B_{r/2}} u \leq C \left(\inf_{B_{r/2}} u + 2r^2 \|f\|_{L^\infty(B_r)} \right)$$

for some constant C depending only on n .

Even if the previous oscillation decay contains an error depending on f , it is enough to show Hölder regularity of the solution.

Corollary 2.12 (Hölder regularity). *Let $f \in L^\infty(B_1)$ and $u \in H^1 \cap L^\infty(B_1)$. If $\Delta u = f$ in B_1 , then*

$$\|u\|_{C^{0,\alpha}(B_{1/2})} \leq C (\|u\|_{L^\infty(B_1)} + \|f\|_{L^\infty(B_1)}),$$

for some constants $\alpha > 0$ and C depending only on n .

Proof. If we denote $\tilde{u} := (2\|u\|_{L^\infty(B_1)} + 2\|f\|_{L^\infty(B_1)})^{-1}u$, then $\tilde{u} \in H^1(B_1) \cap L^\infty(B_1)$ fulfills $\Delta \tilde{u} = \tilde{f}$ in B_1 with $\|\tilde{u}\|_{L^\infty(B_1)} \leq \frac{1}{2}$ and $\|\tilde{f}\|_{L^\infty(B_1)} \leq \frac{1}{2}$. If we show that $\|\tilde{u}\|_{C^{0,\alpha}(B_{1/2})} \leq C$, then the result will follow.

Thus, after dividing u by a constant if necessary, we may assume that $\|u\|_{L^\infty(B_1)} \leq \frac{1}{2}$ and $\|f\|_{L^\infty(B_1)} \leq \frac{1}{2}$.

As in Corollary 2.7 we want to prove that $|u(x_\circ) - u(0)| \leq C|x_\circ|^\alpha$ for all $x_\circ \in B_{1/2}$ and for some constant C depending only on n .

Let us show that it is enough to prove that

$$(2.4) \quad \operatorname{osc}_{B_{2^{-k}}} u \leq C2^{-\alpha k} \quad \text{for all } k \in \mathbb{N}, k \geq k_\circ,$$

for some $\alpha > 0$, C , and for some fixed k_\circ , all three depending only on n . Indeed, let $k \in \mathbb{N}$ be such that $x \in B_{2^{-k}} \setminus B_{2^{-k-1}}$. If $k < k_\circ$, then $|x| \geq 2^{-k_\circ-1}$ and

$$|u(x) - u(0)| \leq \operatorname{osc}_{B_1} u \leq 1 \leq 2^{\alpha(k_\circ+1)}|x|^\alpha.$$

On the other hand, if $k \geq k_\circ$, by (2.4)

$$|u(x) - u(0)| \leq \operatorname{osc}_{B_{2^{-k}}} u \leq C2^{-\alpha k} \leq C(2|x|)^\alpha,$$

where in the last inequality we used that $|x| \geq 2^{-k-1}$. Thus, it will be enough to show (2.4).

Let $k \in \mathbb{N}$ and $k \geq k_o$ for some k_o to be chosen, and define

$$\tilde{u}(x) := u(rx), \quad r = 2^{-k+1}.$$

Then \tilde{u} satisfies $\Delta \tilde{u} = r^2 f(rx)$ in B_1 (in fact, in $B_{2^{k-1}}$), and thus, by Corollary 2.10

$$\operatorname{osc}_{B_{1/2}} \tilde{u} \leq (1 - \theta) \operatorname{osc}_{B_1} \tilde{u} + 2r^2 \|f\|_{L^\infty(B_r)}.$$

Since $\operatorname{osc}_{B_1} \tilde{u} = \operatorname{osc}_{B_{2^{-k+1}}} u$ and $\|f\|_{L^\infty(B_r)} \leq \frac{1}{2}$, we find

$$\operatorname{osc}_{B_{2^{-k}}} u \leq (1 - \theta) \operatorname{osc}_{B_{2^{-k+1}}} u + 4^{-k+2}.$$

Now, take $k_o \in \mathbb{N}$ large enough so that $4^{-k_o+1} \leq \frac{\theta}{2}$. Then,

$$\operatorname{osc}_{B_{2^{-k}}} u \leq (1 - \theta) \operatorname{osc}_{B_{2^{-k+1}}} u + \frac{\theta}{2} 4^{k_o-k}.$$

It is immediate to check by induction that this yields

$$\operatorname{osc}_{B_{2^{-k+1}}} u \leq 2^{\alpha(k_o-k)}, \quad \text{for all } k \in \mathbb{N}.$$

Indeed, the induction step follows as

$$\begin{aligned} \operatorname{osc}_{B_{2^{-k}}} u &\leq (1 - \theta) 2^{\alpha(k_o-k)} + \frac{\theta}{2} 4^{k_o-k} \leq (1 - \theta) 2^{\alpha(k_o-k)} + \frac{\theta}{2} 2^{\alpha(k_o-k)} \\ &= \left(1 - \frac{\theta}{2}\right) 2^{\alpha(k_o-k)} = 2^{\alpha(k_o-k-1)} \quad \text{if } 1 - \frac{\theta}{2} = 2^{-\alpha}. \end{aligned}$$

Thus, (2.4) holds with $C = 2^{\alpha k_o}$. \square

Summarizing, we have checked that Harnack's inequality for harmonic functions yields the Hölder regularity of solutions, even with a right-hand side $f \in L^\infty$.

This is a general fact, and holds for other types of elliptic equations, too.

2.2. Schauder estimates for the Laplacian

We now want to establish sharp results for the equation

$$\boxed{\Delta u = f(x) \quad \text{in } B_1} \quad (\text{or in } \Omega \subset \mathbb{R}^n).$$

This will serve as an introduction for the more general case of equations in non-divergence and divergence form.

The philosophy is that the sharp results should state that “ u is two derivatives more regular than $f(x)$ ”.

The main known results in that directions are the following:

DRAFT

- (a) Schauder estimates. If $f \in C^{0,\alpha}$ then $u \in C^{2,\alpha}$, for $\alpha \in (0, 1)$.
- (b) Calderón–Zygmund estimates. If $f \in L^p$ then $u \in W^{2,p}$, for $p \in (1, \infty)$.
- (c) When α is an integer, or when $p \in \{1, \infty\}$, the above results do *not* hold. For example, if $f \in C^0$, it is not true in general that $u \in C^2$, not even $C^{1,1}$. (In that case, $u \in C^{1,1-\varepsilon}$ for all $\varepsilon > 0$, and $u \in W^{2,p}$ for all $p < \infty$.)

Two counterexamples. Let us provide two counterexamples to show that Schauder and Calderón–Zygmund estimates in general do not hold for the limiting values, $\alpha = 0$ and $p = 1$ or $p = \infty$.

We start with an example of a function u whose Laplacian is bounded ($\Delta u \in L^\infty$), but whose second derivatives are *not* bounded ($u \notin W^{2,\infty}$). Thus, we give a counterexample to Calderón–Zygmund estimates for $p = \infty$.

Let

$$u(x, y) = (x^2 - y^2) \log(x^2 + y^2) \quad \text{in } \mathbb{R}^2.$$

Then,

$$\begin{aligned} \partial_{xx}u &= 2 \log(x^2 + y^2) + \frac{8x^2}{x^2 + y^2} - 2 \left(\frac{x^2 - y^2}{x^2 + y^2} \right)^2, \\ \partial_{yy}u &= -2 \log(x^2 + y^2) - \frac{8y^2}{x^2 + y^2} + 2 \left(\frac{x^2 - y^2}{x^2 + y^2} \right)^2, \end{aligned}$$

that is, both $\partial_{xx}u$ and $\partial_{yy}u$ are unbounded, and $u \notin W^{2,\infty}$. However,

$$\Delta u = \partial_{xx}u + \partial_{yy}u = 8 \frac{x^2 - y^2}{x^2 + y^2} \in L^\infty(\mathbb{R}^2).$$

One can modify such construction in order to make Δu continuous and $u \notin C^{1,1}$, thus giving a counterexample to Schauder estimates for $\alpha = 0$, by taking $u(x, y) = (x^2 - y^2) \log |\log(x^2 + y^2)|$. (However, recall that Schauder estimates tell us that this is *not* possible if Δu is Hölder continuous ($C^{0,\alpha}$).

Let us now provide a counterexample for Calderón–Zygmund estimates when $p = 1$. The fact that the estimate does not hold can be seen by taking smooth approximations of the Dirac delta (with constant integral) as right-hand side, so that the solution converges to the fundamental solution, which is not in $W^{2,1}$.

Let us, however, give a specific example of a function u whose Laplacian is integrable ($\Delta u \in L^1$) but whose second derivatives are not ($u \notin W^{2,1}$).

Let

$$u(x, y) = \log \log \frac{1}{x^2 + y^2} = \log \log r^{-2} \quad \text{in } \mathbb{R}^2,$$

where we are using polar coordinates and denote $r^2 := x^2 + y^2$. Since $u = u(r)$ and $u_r = \frac{1}{r \log r}$ we have that

$$\Delta u = u_{rr} + \frac{1}{r}u_r = -\frac{\log r + 1}{r^2(\log r)^2} + \frac{1}{r^2 \log r} = -\frac{1}{r^2(\log r)^2} \in L^1(B_{1/2}),$$

since $\int_{B_{1/2}} \Delta u = -2\pi \int_0^{1/2} \frac{dr}{r(\log r)^2} < \infty$. On the other hand, a direct computation gives that $\partial_{xx}u$ (and $\partial_{yy}u$) are not absolutely integrable around the origin, and thus $u \notin W^{2,1}$. (Alternatively, since one has the embedding $W^{2,1}(\mathbb{R}^2) \subset L^\infty(\mathbb{R}^2)$ [Bre11, Corollary 9.13] and $u \notin L^\infty$, we deduce $u \notin W^{2,1}$).

A similar counterexample can be built in any dimension $n \geq 2$, by taking as function u an appropriate primitive of $\frac{r^{1-n}}{\log r}$.

In this book we focus our attention on proving (a) Schauder estimates, but not (b) Calderón–Zygmund estimates. Later in the book we will see applications of Schauder-type estimates to nonlinear equations.

Remark 2.13 (Calderón–Zygmund estimates for $p = 2$). In the case $p = 2$, one can prove a priori Calderón–Zygmund estimates with a simple computation. That is, let $u, f \in C^\infty(B_1)$, be such that

$$\Delta u = f \quad \text{in } B_1.$$

Then,

$$(2.5) \quad \|u\|_{W^{2,2}(B_{1/2})} \leq C (\|u\|_{L^2(B_1)} + \|f\|_{L^2(B_1)})$$

for some constant C depending only on n . Indeed, let $w := \eta u$ for some fixed test function $\eta \in C_c^\infty(B_1)$ such that $\eta \equiv 1$ in $B_{1/2}$, $\eta \equiv 0$ in $B_1 \setminus B_{3/4}$ and $\eta \geq 0$. Then, integrating by parts gives

$$\begin{aligned} \|D^2 u\|_{L^2(B_{1/2})} &= \sum_{i,j=1}^n \int_{B_{1/2}} |D_{ij}^2 u|^2 \leq \sum_{i,j=1}^n \int_{B_1} |D_{ij}^2 w|^2 \\ &= - \sum_{i,j=1}^n \int_{B_1} (D_{iij} w)(D_j w) = \sum_{i,j=1}^n \int_{B_{1/2}} (D_{ii} w)(D_{jj} w) \\ &= \int_{B_1} (\Delta w)^2 \leq C \int_{B_1} (u^2 + (\Delta u)^2 + |\nabla \eta|^2 |\nabla u|^2), \end{aligned}$$

where in the last equality we can take $C = C' \sup_{B_1} (\eta^2 + |\Delta \eta|^2)$ for some dimensional constant C' . Then, again integrating by parts twice and using $2ab \leq a^2 + b^2$, we get

$$\int_{B_1} |\nabla \eta|^2 |\nabla u|^2 = - \int_{B_1} |\nabla \eta|^2 u \Delta u + \int_{B_1} \frac{1}{2} u^2 \Delta |\nabla \eta|^2 \leq \tilde{C} \int_{B_1} (u^2 + (\Delta u)^2),$$

where $\tilde{C} = \sup_{B_1} (|\nabla \eta|^2 + \Delta |\nabla \eta|^2)$.

This directly yields the result (2.5) for smooth functions u and f such that $\Delta u = f$. Arguing as in the proof of Corollary 2.16 below, the same result also holds as long as $u \in H^1(B_1)$ is a weak solution to $\Delta u = f$ in B_1 for $f \in L^2(B_1)$.

Proofs of Schauder estimates: some comments. There are various proofs of Schauder estimates, mainly using:

- (1) integral representation of solutions (fundamental solutions);
- (2) energy considerations;
- (3) comparison principle.

The most flexible approaches are (2) and (3). Here, we will see different proofs of type (3).

The *common traits* in proofs of type (2)-(3) are their “perturbative character”, that is, that by zooming in around any point the equation gets closer and closer to $\Delta u = \text{constant}$, and thus (after subtracting a paraboloid) close to $\Delta u = 0$. Thus, the result can be proved by using the information that we have on harmonic functions.

Let us start by stating the results we want to prove in this section: Schauder estimates for the Laplacian.

Theorem 2.14 (Schauder estimates for the Laplacian). *Let $\alpha \in (0, 1)$, and let $u \in C^{2,\alpha}(B_1)$ satisfy*

$$\Delta u = f \quad \text{in } B_1,$$

with $f \in C^{0,\alpha}(B_1)$. Then

$$(2.6) \quad \|u\|_{C^{2,\alpha}(B_{1/2})} \leq C (\|u\|_{L^\infty(B_1)} + \|f\|_{C^{0,\alpha}(B_1)}).$$

The constant C depends only on α and the dimension n .

We will, in general, state our estimates in balls $B_{1/2}$ and B_1 . By means of a covering argument explained below, this allows us to obtain interior regularity estimates in general domains.

Remark 2.15 (Covering argument). Let us assume that we have an estimate, like the one in (2.6), but in a ball B_{r_1} for some $r_1 \in (0, 1)$, which will be typically very close to zero. Namely, we know that if $\Delta u = f$ in B_1 , then

$$(2.7) \quad \|u\|_{C^{2,\alpha}(B_{r_1})} \leq C (\|u\|_{L^\infty(B_1)} + \|f\|_{C^{0,\alpha}(B_1)}).$$

Let us suppose that we are interested in finding an estimate for a bigger ball, B_{r_2} with $r_1 < r_2 \in (0, 1)$, where r_2 will be typically close to one. We do that via a “covering argument”. (See Figure 2.3.)

That is, let us cover the ball B_{r_2} with smaller balls $B_r(x_i)$ such that $x_i \in B_{r_2}$ and $r = (1 - r_2)r_1$. We can do so with a finite number of balls,

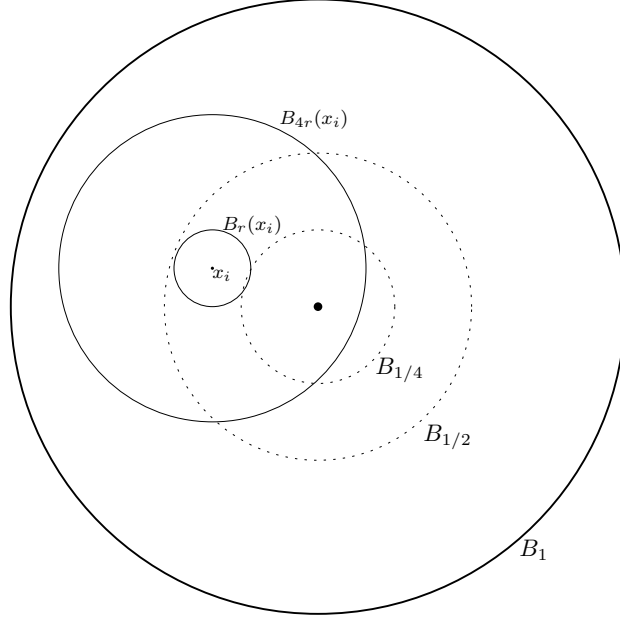

Figure 2.3. Graphical representation of the “covering argument” in the case $r_1 = \frac{1}{4}$, $r_2 = \frac{1}{2}$, and $r = \frac{1}{8}$.

so that $i \in \{1, \dots, N\}$, for some N depending on r_1 , r_2 , and n . Notice that $B_{r/r_1}(x_i) \subset B_1$.

We apply our estimate (2.7) (translated and rescaled) at each of these balls $B_{r/r_1}(x_i)$ (we can do so, because $\Delta u = f$ in $B_{r/r_1}(x_i) \subset B_1$). Thus, we obtain a bound for $\|u\|_{C^{2,\alpha}(B_r(x_i))}$

$$\begin{aligned} \|u\|_{C^{2,\alpha}(B_r(x_i))} &\leq C(r_1, r_2) \left(\|u\|_{L^\infty(B_{r/r_1}(x_i))} + \|f\|_{C^{0,\alpha}(B_{r/r_1}(x_i))} \right) \\ &\leq C(r_1, r_2) \left(\|u\|_{L^\infty(B_1)} + \|f\|_{C^{0,\alpha}(B_1)} \right). \end{aligned}$$

Now, since B_{r_2} can be covered by a finite number of these balls, we obtain

$$\|u\|_{C^{2,\alpha}(B_{r_2})} \leq \sum_{i=1}^n \|u\|_{C^{2,\alpha}(B_r(x_i))} \leq NC(r_1, r_2) \left(\|u\|_{L^\infty(B_1)} + \|f\|_{C^{0,\alpha}(B_1)} \right).$$

This is the type of bound we wanted, where the constant now also depends on r_1 and r_2 .

As a consequence of the “a priori” estimate for the Laplacian we will show:

Corollary 2.16. *Let u be any bounded weak solution to*

$$\Delta u = f \quad \text{in } B_1,$$

with $f \in C^{0,\alpha}(B_1)$ for some $\alpha \in (0, 1)$. Then, u is in $C^{2,\alpha}$ inside B_1 , and the estimate (2.6) holds.

Furthermore, iterating the previous estimate we will establish the following.

Corollary 2.17 (Higher order regularity estimates). *Let u be any bounded weak solution to*

$$\Delta u = f \quad \text{in } B_1,$$

with $f \in C^{k,\alpha}(B_1)$ for some $\alpha \in (0, 1)$, and $k \in \mathbb{N}$. Then, u is in $C^{k+2,\alpha}$ inside B_1 and

$$\|u\|_{C^{k+2,\alpha}(B_{1/2})} \leq C \left(\|u\|_{L^\infty(B_1)} + \|f\|_{C^{k,\alpha}(B_1)} \right),$$

for some constant C that depends only on k , α , and the dimension n .

In case $f \in L^\infty$, we will prove the following.

Proposition 2.18. *Let u be any solution to*

$$\Delta u = f \quad \text{in } B_1,$$

with $f \in L^\infty(B_1)$. Then, u is in $C^{1,1-\varepsilon}$ inside B_1 , for any $\varepsilon > 0$, with the estimate

$$\|u\|_{C^{1,1-\varepsilon}(B_{1/2})} \leq C_\varepsilon \left(\|u\|_{L^\infty(B_1)} + \|f\|_{L^\infty(B_1)} \right)$$

for some constant C_ε depending only on ε and n .

We will give two different proofs of Theorem 2.14. The first proof follows a method introduced by Wang in [Wan06] and shows the a priori estimate using a very much self-contained approach. For the second proof we use an approach à la Caffarelli from [Moo12, Caf89].

Before doing so, let us observe the following:

- If $\Delta u = f \in L^\infty$ then $\tilde{u}(x) := u(rx)$ solves $\Delta \tilde{u} = r^2 f(rx)$. In other words, if $|\Delta u| \leq C$, then $|\Delta \tilde{u}| \leq Cr^2$ (and if r is small, the right-hand side becomes smaller and smaller).
- If $\Delta u = f \in C^{0,\alpha}$, $\tilde{u}(x) = u(rx) - \frac{f(0)}{2n}|x|^2$ solves $\Delta \tilde{u} = r^2(f(rx) - f(0))$, so that $|\Delta \tilde{u}| \leq Cr^{2+\alpha}$ in B_1 . This, by the comparison principle, means that \tilde{u} is “very close” to a harmonic function.

Let us now show that Corollary 2.16 holds assuming Theorem 2.14. This follows by an approximation argument.

Proof of Corollary 2.16. We will deduce the result from Theorem 2.14. Let u be any solution to $\Delta u = f$ in B_1 , with $f \in C^{0,\alpha}(B_1)$, and let $\eta \in C_c^\infty(B_1)$ be any smooth function with $\eta \geq 0$ and $\int_{B_1} \eta = 1$. Let

$$\eta_\varepsilon(x) := \varepsilon^{-n} \eta\left(\frac{x}{\varepsilon}\right),$$

which satisfies $\int_{B_\varepsilon} \eta_\varepsilon = 1$, $\eta_\varepsilon \in C_c^\infty(B_\varepsilon)$. Consider the convolution

$$u_\varepsilon(x) := u * \eta_\varepsilon(x) = \int_{B_\varepsilon} u(x-y)\eta_\varepsilon(y) dy,$$

which is C^∞ and satisfies

$$\Delta u_\varepsilon = f * \eta_\varepsilon =: f_\varepsilon \quad \text{in } B_{1-\varepsilon}.$$

(Notice that for smooth functions, derivatives and convolutions commute; the same can be done for weak derivatives.) Since $u_\varepsilon \in C^\infty$, we can use Theorem 2.14 to get

$$\|u_\varepsilon\|_{C^{2,\alpha}(B_{1/2})} \leq C (\|u_\varepsilon\|_{L^\infty(B_{1-\varepsilon})} + \|f_\varepsilon\|_{C^{0,\alpha}(B_{1-\varepsilon})}),$$

where we are also using the covering argument in Remark 2.15 to write it in a ball $B_{1-\varepsilon}$ in the right-hand side. Observe now that for any $x, y \in B_{1-\varepsilon}$

$$|u_\varepsilon(x)| \leq \int_{B_\varepsilon} |u(x-z)|\eta_\varepsilon(z) dy \leq \|u\|_{L^\infty(B_1)} \int_{B_\varepsilon} \eta_\varepsilon(z) dz = \|u\|_{L^\infty(B_1)},$$

and

$$|f_\varepsilon(x) - f_\varepsilon(y)| \leq \int_{B_\varepsilon} |f(x-z) - f(y-z)|\eta_\varepsilon(z) dz = [f]_{C^{0,\alpha}(B_1)} |x-y|^\alpha.$$

From here, we deduce $\|u_\varepsilon\|_{L^\infty(B_{1-\varepsilon})} \leq \|u\|_{L^\infty(B_1)}$ and $\|f_\varepsilon\|_{C^{0,\alpha}(B_{1-\varepsilon})} \leq \|f\|_{C^{0,\alpha}(B_1)}$. Thus, the sequence u_ε is uniformly bounded in $C^{2,\alpha}(B_{1/2})$,

$$\|u_\varepsilon\|_{C^{2,\alpha}(B_{1/2})} \leq C (\|u\|_{L^\infty(B_1)} + \|f\|_{C^{0,\alpha}(B_1)}).$$

Moreover, since u is continuous (see Corollary 2.12), arguing as before we get $\|u_\varepsilon - u\|_{L^\infty(B_1)} \rightarrow 0$ as $\varepsilon \downarrow 0$, so that $u_\varepsilon \rightarrow u$ uniformly. We can use **(H8)** from Chapter 1 to deduce that $u \in C^{2,\alpha}$ and

$$\|u\|_{C^{2,\alpha}(B_{1/2})} \leq C (\|u\|_{L^\infty(B_1)} + \|f\|_{C^{0,\alpha}(B_1)}).$$

By a covering argument (see Remark 2.15) we can get a similar estimate in any ball B_ρ with $\rho < 1$,

$$\|u\|_{C^{2,\alpha}(B_\rho)} \leq C_\rho (\|u\|_{L^\infty(B_1)} + \|f\|_{C^{0,\alpha}(B_1)}),$$

where now the constant C_ρ depends also on ρ , and in fact, blows up when $\rho \uparrow 1$. In any case, we have that $u \in C^{2,\alpha}(B_\rho)$ for any $\rho < 1$, i.e., u is in $C^{2,\alpha}$ inside B_1 . \square

The previous proof is an example of a recurring phenomenon when proving regularity estimates for PDEs. If one can get estimates of the kind

$$\|u\|_{C^{2,\alpha}} \leq C (\|u\|_{L^\infty} + \|f\|_{C^{0,\alpha}}),$$

for all C^∞ functions u , and with a constant C that depends only on α and n (but independent of u and f), then, in general, the estimate holds as well for all solutions u . Thus, if one wants to prove the higher-order regularity

estimates from Corollary 2.17, it is enough to get a priori estimates in the spirit of Theorem 2.14. As a consequence, assuming that Theorem 2.14 holds, we can prove Corollary 2.17.

Proof of Corollary 2.17. As mentioned above, we just need to show that for any $u \in C^\infty$ such that $\Delta u = f$, one has

$$(2.8) \quad \|u\|_{C^{k+2,\alpha}(B_{1/2})} \leq C \left(\|u\|_{L^\infty(B_1)} + \|f\|_{C^{k,\alpha}(B_1)} \right).$$

for some constant C depending only on n , α , and k ; and then we are done by a covering argument (see Remark 2.15). We prove it by induction on k , and it follows applying the induction hypothesis to derivatives of u . Notice that (2.8) deals with balls $B_{1/2}$ and B_1 , but after a rescaling and covering argument (see Remark 2.15), it could also be stated in balls $B_{1/2}$ and $B_{3/4}$ (we will use it in this setting).

The base case, $k = 0$, already holds by Theorem 2.14. Let us now assume that (2.8) holds for $k = m - 1$, and we will show it for $k = m$.

In this case, let us differentiate $\Delta u = f$ to get $\Delta \partial_i u = \partial_i f$, for $i \in \{1, \dots, n\}$. Applying (2.8) for $k = m - 1$ to $\partial_i u$ in balls $B_{1/2}$ and $B_{3/4}$, we get

$$\begin{aligned} \|\partial_i u\|_{C^{m+1,\alpha}(B_{1/2})} &\leq C \left(\|\partial_i u\|_{L^\infty(B_{3/4})} + \|\partial_i f\|_{C^{m-1,\alpha}(B_{3/4})} \right) \\ &\leq C \left(\|u\|_{C^{2,\alpha}(B_{3/4})} + \|f\|_{C^{m,\alpha}(B_{3/4})} \right). \end{aligned}$$

Using now Theorem 2.14 in balls $B_{3/4}$ and B_1 ,

$$\|\partial_i u\|_{C^{m+1,\alpha}(B_{1/2})} \leq C \left(\|u\|_{L^\infty(B_1)} + \|f\|_{C^\alpha(B_1)} + \|f\|_{C^{m,\alpha}(B_{3/4})} \right)$$

This, together with the basic estimate from Theorem 2.14 for $\Delta u = f$, and used for each $i \in \{1, \dots, n\}$, directly yields that (2.8) holds for $k = m$. \square

Similarly, if one wants to prove regularity estimates in other contexts, it is often enough to obtain the corresponding a priori estimate. For instance, using an estimate that we prove later in the chapter (in the more general context of non-divergence-form equations) we can immediately obtain also the proof of Proposition 2.18.

Proof of Proposition 2.18. The proof is exactly the same as the proof of Corollary 2.16 but using Proposition 2.31 from below instead of Theorem 2.14. (Alternatively, see Remark 2.19.) \square

Let us now provide the first proof of Theorem 2.14. The method used here was introduced by Wang in [Wan06].

First proof of Theorem 2.14. We will prove that

$$|D^2u(z) - D^2u(y)| \leq C|z - y|^\alpha (\|u\|_{L^\infty(B_1)} + [f]_{C^{0,\alpha}(B_1)}),$$

for all $y, z \in B_{1/32}$. After a translation, we assume that $y = 0$, so that the proof can be centered around 0. This will prove our theorem with estimates in a ball $B_{1/32}$, and the desired result in a ball of radius $\frac{1}{2}$ follows by a covering argument. Moreover, after dividing the solution u by $\|u\|_{L^\infty(B_1)} + [f]_{C^{0,\alpha}(B_1)}$ if necessary, we may assume that $\|u\|_{L^\infty(B_1)} \leq 1$ and $[f]_{C^{0,\alpha}(B_1)} \leq 1$, and we just need to prove that for all $z \in B_{1/16}$,

$$|D^2u(z) - D^2u(0)| \leq C|z|^\alpha.$$

Throughout the proof, we will use the following basic estimates for harmonic functions:

$$(2.9) \quad \Delta w = 0 \quad \text{in } B_r \quad \Rightarrow \quad \|D^\kappa w\|_{L^\infty(B_{r/2})} \leq Cr^{-\kappa} \|w\|_{L^\infty(B_r)},$$

where C depends only on n and $\kappa \in \mathbb{N}$. (In fact, we will only use $\kappa \in \{1, 2, 3\}$.) Such estimate follows by rescaling the estimate (1.16) — which corresponds to the case $r = 1$.

We will also use the estimate

$$(2.10) \quad \Delta w = \lambda \quad \text{in } B_r \quad \Rightarrow \quad \|D^2 w\|_{L^\infty(B_{r/2})} \leq C(r^{-2} \|w\|_{L^\infty(B_r)} + |\lambda|),$$

for some constant C depending only on n . This estimate follows from (2.9) after subtracting $\frac{\lambda}{2n}|x|^2$.

For $k = 0, 1, 2, \dots$, let u_k be the solution to

$$\begin{cases} \Delta u_k = f(0) & \text{in } B_{2^{-k}} \\ u_k = u & \text{on } \partial B_{2^{-k}}. \end{cases}$$

Then, $\Delta(u_k - u) = f(0) - f$, and by the rescaled version of Lemma 1.14

$$(2.11) \quad \|u_k - u\|_{L^\infty(B_{2^{-k}})} \leq C(2^{-k})^2 \|f(0) - f\|_{L^\infty(B_{2^{-k}})} \leq C2^{-k(2+\alpha)},$$

where we are using that $[f]_{C^{0,\alpha}(B_1)} \leq 1$. Hence, the triangle inequality yields

$$\|u_{k+1} - u_k\|_{L^\infty(B_{2^{-k-1}})} \leq C2^{-k(2+\alpha)}.$$

Since $u_{k+1} - u_k$ is harmonic, we have

$$(2.12) \quad \|D^2(u_{k+1} - u_k)\|_{L^\infty(B_{2^{-k-2}})} \leq C2^{2(k+1)} \|u_{k+1} - u_k\|_{L^\infty(B_{2^{-k-1}})} \leq C2^{-k\alpha}.$$

Now, notice that

$$(2.13) \quad D^2u(0) = \lim_{k \rightarrow \infty} D^2u_k(0).$$

Indeed, let $\tilde{u}(x) := u(0) + x \cdot \nabla u(0) + \frac{1}{2}x \cdot D^2 u(0)x$ be the second order expansion of u at 0. Then, since $u \in C^{2,\alpha}$, we have $\|\tilde{u} - u\|_{L^\infty(B_r)} \leq Cr^{2+\alpha} = o(r^2)$. Using that $\tilde{u} - u_k$ is harmonic together with (2.9) we deduce

$$\begin{aligned} |D^2 u_k(0) - D^2 u(0)| &\leq \|D^2(u_k - \tilde{u})\|_{L^\infty(B_{2^{-k-1}})} \\ &\leq C2^{2k} \|u_k - \tilde{u}\|_{L^\infty(B_{2^{-k}})} \\ &= C2^{2k} \|u - \tilde{u}\|_{L^\infty(\partial B_{2^{-k}})} \rightarrow 0 \quad \text{as } k \rightarrow \infty. \end{aligned}$$

Now, for any point z near the origin, we have

$$\begin{aligned} |D^2 u(z) - D^2 u(0)| &\leq |D^2 u_k(0) - D^2 u(0)| \\ &\quad + |D^2 u_k(0) - D^2 u_k(z)| + |D^2 u_k(z) - D^2 u(z)|. \end{aligned}$$

For a given $z \in B_{1/16}$, we choose $k \in \mathbb{N}$ such that

$$2^{-k-4} \leq |z| \leq 2^{-k-3}.$$

Thanks to (2.12)-(2.13), and by the triangle inequality, we get

$$|D^2 u_k(0) - D^2 u(0)| \leq \sum_{j=k}^{\infty} |D^2 u_j(0) - D^2 u_{j+1}(0)| \leq C \sum_{j=k}^{\infty} 2^{-j\alpha} = C2^{-k\alpha},$$

where we use that $\alpha \in (0, 1)$.

In order to estimate $|D^2 u(z) - D^2 u_k(z)|$, the same argument can be repeated around z instead of 0. That is, take solutions of $\Delta v_j = f(z)$ in $B_{2^{-j}(z)}$ and $v_j = u$ on $\partial B_{2^{-j}(z)}$. Then,

$$|D^2 u_k(z) - D^2 u(z)| \leq |D^2 u_k(z) - D^2 v_k(z)| + |D^2 v_k(z) - D^2 u(z)|.$$

The second term above can be bounded by $C2^{-k\alpha}$ arguing as before. For the first term, we use (2.10) by noticing that $\Delta(u_k - v_k) = f(0) - f(z)$ in $B_{2^{-k}} \cap B_{2^{-k}(z)} \supset B_{2^{-k-1}(z)}$ (recall $|z| \leq 2^{-k-3}$), so that, in $B_{2^{-2-k}(z)}$ we have

$$\begin{aligned} |D^2 u_k(z) - D^2 v_k(z)| &\leq \|D^2(u_k - v_k)\|_{L^\infty(B_{2^{-2-k}(z)})} \\ &\leq C2^{2k} \|u_k - v_k\|_{L^\infty(B_{2^{-k-1}(z)})} + C|f(z) - f(0)| \\ &\leq C2^{2k} \|u_k - v_k\|_{L^\infty(B_{2^{-k-1}(z)})} + C2^{-k\alpha}, \end{aligned}$$

where we use, again, that $|z| \leq 2^{-k-3}$, and $[f]_{C^{0,\alpha}(B_1)} \leq 1$

Finally, from (2.11), we know that

$$\|u_k - u\|_{L^\infty(B_{2^{-k-1}(z)})} \leq \|u_k - u\|_{L^\infty(B_{2^{-k}})} \leq C2^{-k(2+\alpha)},$$

and

$$\|u - v_k\|_{L^\infty(B_{2^{-k-1}(z)})} \leq C2^{-k(2+\alpha)},$$

DRAFT

which gives

$$\|u_k - v_k\|_{L^\infty(B_{2^{-k-1}}(z))} \leq C2^{-k(2+\alpha)}.$$

Thus, we deduce that

$$|D^2u_k(z) - D^2u(z)| \leq C2^{-k\alpha}.$$

Finally, to estimate $|D^2u_k(z) - D^2u_k(0)|$, we denote $h_j := u_j - u_{j-1}$ for $j = 1, 2, \dots, k$. Since h_j are harmonic, by (2.9) with $\kappa = 3$ and using that $B_{2^{-k-3}} \subset B_{2^{-j-1}}$, we see that

$$\begin{aligned} \left| \frac{D^2h_j(z) - D^2h_j(0)}{|z|} \right| &\leq \|D^3h_j\|_{L^\infty(B_{2^{-k-3}})} \\ &\leq C2^{3j}\|h_j\|_{L^\infty(B_{2^{-j}})} \leq C2^{j(1-\alpha)}. \end{aligned}$$

Hence,

$$\begin{aligned} |D^2u_k(0) - D^2u_k(z)| &\leq |D^2u_0(z) - D^2u_0(0)| + \sum_{j=1}^k |D^2h_j(z) - D^2h_j(0)| \\ &\leq C|z|\|u_0\|_{L^\infty(B_1)} + C|z| \sum_{j=1}^k 2^{j(1-\alpha)}. \end{aligned}$$

We have also used here that, if we define $w := u_0 - \frac{f(0)}{2n}|x|^2 + \frac{f(0)}{2n}$ then w is harmonic, $D^3w = D^3u_0$, and $w = u_0$ on ∂B_1 , and

$$\begin{aligned} |z|^{-1}|D^2u_0(z) - D^2u_0(0)| &\leq \|D^3u_0\|_{L^\infty(B_{1/2})} = \|D^3w\|_{L^\infty(B_{1/2})} \\ &\leq C\|w\|_{L^\infty(B_1)} = C\|u_0\|_{L^\infty(\partial B_1)} \leq C\|u_0\|_{L^\infty(B_1)}, \end{aligned}$$

by higher order regularity estimates for harmonic functions (see (2.9)) and the maximum principle (Lemma 1.14). Note that here the constant C depends only on n .

Combined with the fact that, from (2.11),

$$\|u_0\|_{L^\infty(B_1)} \leq C,$$

(where we also use $\|u\|_{L^\infty(B_1)} \leq 1$) and $|z| \leq 2^{-k-3}$, we deduce that

$$|D^2u_k(0) - D^2u_k(z)| \leq C|z| + C|z|2^{k(1-\alpha)} \leq C2^{-k\alpha}.$$

We finish by noticing that $|z| \geq 2^{-k-4}$ and combining all the last inequalities we reach

$$|D^2u(z) - D^2u(0)| \leq C2^{-k\alpha} \leq C|z|^\alpha$$

for all $z \in B_{1/16}$. That is,

$$[D^2u]_{C^{0,\alpha}(B_{1/16})} \leq C.$$

Now, thanks to the interpolation inequalities (see (1.9) with $\varepsilon = 1$),

$$\begin{aligned} \|u\|_{C^{2,\alpha}(B_{1/16})} &= \|u\|_{C^2(B_{1/16})} + [D^2u]_{C^{0,\alpha}(B_{1/16})} \\ &\leq C\|u\|_{L^\infty(B_{1/16})} + 2[D^2u]_{C^{0,\alpha}(B_{1/16})} \leq C. \end{aligned}$$

We finish by recalling that we divided the solution u by $\|u\|_{L^\infty(B_1)} + [f]_{C^{0,\alpha}(B_1)}$, and we use a covering argument to get the desired result (see Remark 2.15). \square

For the second proof of Theorem 2.14, we use the methods from [Moo12], originally from [Caf89].

Second proof of Theorem 2.14. After subtracting $\frac{f(0)}{2n}|x|^2$ we may assume that $f(0) = 0$. After dividing u by $\|u\|_{L^\infty(B_1)} + \varepsilon^{-1}\|f\|_{C^{0,\alpha}(B_1)}$ if necessary, we may also assume that $\|u\|_{L^\infty(B_1)} \leq 1$ and $\|f\|_{C^{0,\alpha}(B_1)} \leq \varepsilon$, where $\varepsilon > 0$ is a constant to be chosen depending only on n and α . After these simplifications, it is enough to show that

$$(2.14) \quad \|u\|_{C^{2,\alpha}(B_{1/2})} \leq C$$

for some constant C depending only on n and α .

We will show that, for every $x \in B_{1/2}$, there exist a sequence of quadratic polynomials, $(P_k)_{k \in \mathbb{N}}$, and a $\rho_\circ < 1$ such that

$$(2.15) \quad \|u - P_k\|_{L^\infty(B_{\rho_\circ^k}(x))} \leq C_\circ \rho_\circ^{k(2+\alpha)} \quad \text{for all } k \in \mathbb{N},$$

for some constant C_\circ . By property **(H5)** from Chapter 1, this yields that $[D^2u]_{C^{0,\alpha}(B_{1/2})} \leq CC_\circ$. After using an interpolation inequality (1.9), we get (2.14).

We will prove (2.15) for $x = 0$ (after a translation, it follows for all $x \in B_{1/2}$). We are going to use that $\Delta u = f$, $\|u\|_{L^\infty(B_1)} \leq 1$, $f(0) = 0$ and $[f]_{C^{0,\alpha}(B_1)} \leq \varepsilon$.

Notice that $\|\Delta u\|_{C^{0,\alpha}(B_1)} = \|f\|_{C^{0,\alpha}(B_1)} \leq 2\varepsilon$, i.e., u is 2ε -close in Hölder norm to a harmonic function: let w be such that $\Delta w = 0$ and $w = u$ on ∂B_1 . Then, $\Delta(u - w) = f$ in B_1 , and $u - w = 0$ on ∂B_1 , so that by Lemma 1.14,

$$(2.16) \quad \|u - w\|_{L^\infty(B_1)} \leq C'\|f\|_{L^\infty(B_1)} \leq C\varepsilon,$$

for some C universal (we are only using $\|f\|_{L^\infty(B_1)} \leq 2\varepsilon$, and not using its C^α norm at this point). The function w is harmonic and $|w| \leq 1$ (since $|u| \leq 1$). Therefore, it has a quadratic Taylor polynomial P_1 at the origin, which satisfies $\Delta P_1 \equiv 0$ and $|P_1| \leq C$. Moreover, since w is harmonic (and in particular $w \in C^3$), we have

$$(2.17) \quad \|w - P_1\|_{L^\infty(B_r)} \leq Cr^3 \quad \text{for all } r \leq 1,$$

for some C depending only on n .

Combining (2.16) and (2.17) we obtain

$$\|u - P_1\|_{L^\infty(B_r)} \leq C(r^3 + \varepsilon) \quad \text{for all } r \leq 1.$$

Choose now r_\circ small enough such that $Cr_\circ^3 \leq \frac{1}{2}r_\circ^{2+\alpha}$ (notice $\alpha < 1$), and ε small enough such that $C\varepsilon < \frac{1}{2}r_\circ^{2+\alpha}$. (Notice that both r_\circ and ε can be chosen depending only on n and α .) Then,

$$\|u - P_1\|_{L^\infty(B_{r_\circ})} \leq r_\circ^{2+\alpha}.$$

Let us now define

$$u_2(x) := \frac{(u - P_1)(r_\circ x)}{r_\circ^{2+\alpha}}.$$

Notice that $\|u_2\|_{L^\infty(B_1)} \leq 1$ and $\Delta u_2(x) = r_\circ^{-\alpha} f(r_\circ x) =: f_2(x)$. Then, $f_2(0) = 0$ and $[f_2]_{C^{0,\alpha}(B_1)} \leq [f]_{C^{0,\alpha}(B_1)} \leq \varepsilon$. That is, the same hypotheses as before are fulfilled. Repeating the same procedure, there exists a polynomial P_2 such that

$$\|u_2 - P_2\|_{L^\infty(B_{r_\circ})} \leq r_\circ^{2+\alpha}.$$

That is, substituting back,

$$\|u - P_1 - r_\circ^{2+\alpha} P_2(x/r_\circ)\|_{L^\infty(B_{r_\circ^2})} \leq r_\circ^{2(2+\alpha)}.$$

Continuing iteratively, for every $k \in \mathbb{N}$ we can define

$$u_{k+1}(x) := \frac{(u_k - P_k)(r_\circ x)}{r_\circ^{2+\alpha}},$$

which satisfies

$$\|u_{k+1}\|_{L^\infty(B_1)} \leq 1, \quad \Delta u_{k+1}(x) = r_\circ^{-\alpha} f_k(r_\circ x) = r_\circ^{-k\alpha} f(r_\circ^k x) =: f_{k+1}(x),$$

and there exists some P_{k+1} such that

$$\|u_{k+1} - P_{k+1}\|_{L^\infty(B_{r_\circ})} \leq r_\circ^{2+\alpha}.$$

Substituting back,

$$\|u - P_1 - r_\circ^{2+\alpha} P_2(x/r_\circ) - \dots - r_\circ^{k(2+\alpha)} P_{k+1}(x/r_\circ^k)\|_{L^\infty(B_{r_\circ^{k+1}})} \leq r_\circ^{(k+1)(2+\alpha)}.$$

That is, we have constructed a sequence of quadratic polynomials approximating u in a decreasing sequence of balls around 0; which shows that (2.15) holds around 0. After a translation, the same argument can be repeated around any point $x \in B_{1/2}$, so that, by **(H5)** we are done. \square

Remark 2.19. When $\alpha = 0$, the previous proof implies that if $f \in L^\infty(B_1)$ then, by (2.15), ∇u is in the Zygmund space $\Lambda^1(B_1)$; see Remark A.1 in the Appendix A for more details. In particular, we also get a proof of Proposition 2.18.

Notice that in the previous proof we have not directly used that u is C^2 . In fact, the only properties of u (and the Laplacian) we have used are that the maximum principle holds and that $\Delta(u(rx)) = r^2(\Delta u)(rx)$.

In particular, the second proof of Theorem 2.14 is *not* an a priori estimate, and rather it says that any weak solution to the Laplace equation with C^α right-hand side is $C^{2,\alpha}$. That is, we have directly proved Corollary 2.16.

2.3. Schauder estimates for operators in non-divergence form

After proving the Schauder estimates for the Laplacian, we will study now more general second order linear elliptic operators. We start with operators in non-divergence form. The type of equation we are interested in is

$$\operatorname{tr}(A(x)D^2u(x)) = \sum_{i,j=1}^n a_{ij}(x)\partial_{ij}u(x) = f(x) \quad \text{in } B_1$$

where the matrix $A(x) = (a_{ij}(x))_{ij}$ is uniformly elliptic — in the sense that (2.18) below holds — and $a_{ij}(x) \in C^{0,\alpha}(B_1)$. We will prove the following a priori estimates.

Theorem 2.20 (Schauder estimates in non-divergence form). *Let $\alpha \in (0, 1)$, and let $u \in C^{2,\alpha}$ be any solution to*

$$\sum_{i,j=1}^n a_{ij}(x)\partial_{ij}u = f(x) \quad \text{in } B_1,$$

with $f \in C^{0,\alpha}(B_1)$ and $a_{ij}(x) \in C^{0,\alpha}(B_1)$, and $(a_{ij}(x))_{ij}$ fulfilling the ellipticity condition

$$(2.18) \quad 0 < \lambda \operatorname{Id} \leq (a_{ij}(x))_{ij} \leq \Lambda \operatorname{Id} \quad \text{in } B_1,$$

for some $0 < \lambda \leq \Lambda < \infty$. Then,

$$\|u\|_{C^{2,\alpha}(B_{1/2})} \leq C (\|u\|_{L^\infty(B_1)} + \|f\|_{C^{0,\alpha}(B_1)})$$

for some constant C depending only on $\alpha, n, \lambda, \Lambda$, and $\|a_{ij}\|_{C^{0,\alpha}(B_1)}$.

As for the Laplacian, we will provide two different proofs of the previous result. On the other hand, as a consequence of the previous result, we also obtain higher order Schauder estimates in non-divergence form.

Corollary 2.21 (Higher order Schauder estimates in non-divergence form). *Let $u \in C^{k+2,\alpha}$ be a solution to*

$$\sum_{i,j=1}^n a_{ij}(x)\partial_{ij}u = f(x) \quad \text{in } B_1,$$

with $f \in C^{k,\alpha}(B_1)$ and $a_{ij}(x) \in C^{k,\alpha}(B_1)$ for some $\alpha \in (0, 1)$, $k \in \mathbb{N}$, and $(a_{ij}(x))_{ij}$ fulfilling the ellipticity conditions (2.18) for some $0 < \lambda \leq \Lambda < \infty$. Then,

$$\|u\|_{C^{k+2,\alpha}(B_{1/2})} \leq C \left(\|u\|_{L^\infty(B_1)} + \|f\|_{C^{k,\alpha}(B_1)} \right)$$

for some constant C depending only on α , k , n , λ , Λ , and $\|a_{ij}\|_{C^{k,\alpha}(B_1)}$.

Remark 2.22 (Ellipticity condition). The uniform ellipticity condition in B_1 , (2.18), is a quantification of the fact that the matrix

$$A(x) := (a_{ij}(x))_{ij}$$

is uniformly positive definite and uniformly bounded as well. Notice that we can always assume that $A(x)$ is symmetric (from $\partial_{ij}u = \partial_{ji}u$). We recall that the inequality $A_1 \leq A_2$ for symmetric matrices $A_1, A_2 \in \mathcal{M}_n$ has to be understood in the sense that $A_2 - A_1$ is positive semi-definite. Alternatively, (2.18) will hold if

$$0 < \lambda|\xi|^2 \leq \sum_{i,j=1}^n \xi_i \xi_j a_{ij}(x) \leq \Lambda|\xi|^2 \quad \text{for all } x \in B_1$$

for all $\xi \in \mathbb{R}^n$.

Remark 2.23 (Constant coefficients). Let us start by understanding the case of constant coefficients,

$$\sum_{i,j=1}^n a_{ij} \partial_{ij} u(x) = 0 \quad \text{in } B_1,$$

where a_{ij} are constants and satisfy the uniform ellipticity assumption,

$$0 < \lambda \text{Id} \leq (a_{ij})_{ij} \leq \Lambda \text{Id},$$

for $0 < \lambda \leq \Lambda < \infty$.

Let us denote $A := (a_{ij})_{ij} \in \mathcal{M}_n$. Then, A is a symmetric positive definite matrix, and therefore has a unique positive definite square root $A^{1/2}$. After an affine change of variables

$$z = A^{1/2}x,$$

the equation

$$\sum_{i,j=1}^n a_{ij} \partial_{x_i x_j} u = 0 \quad \text{becomes} \quad \sum_{i=1}^n \partial_{z_i z_i} u = 0$$

or $\Delta_z u = 0$. Indeed,

$$\sum_{i,j=1}^n a_{ij} \partial_{x_i x_j} u = \text{tr}(A D_x^2 u) = \text{tr}(A^{1/2} D_x^2 u A^{1/2}) = \text{tr}(D_z^2 u) = \Delta_z u.$$

Therefore (and since $0 < \lambda \text{Id} \leq A \leq \Lambda \text{Id}$), the case of constant coefficients (uniformly elliptic) can be reduced to the case of *harmonic functions*.

Thanks to the uniform ellipticity, the change of variables is *not* degenerate, and thus the estimates on $\|u\|_{C^{2,\alpha}}$ that we get depend only on α , n , λ , and Λ (but not on A). Similarly, after changing variables, there could be a shrinking of the domain, say that the $C^{2,\alpha}$ norm of u is bounded in B_ρ instead of $B_{1/2}$, for some $\rho < 1/2$. Once again, since the change is non-degenerate, such ρ depends only on n , λ , and Λ , and one can complete the proof by a covering argument in $B_{1/2}$ (see Remark 2.15).

The maximum principle. We state the maximum principle for equations in non-divergence form, which will be used in this section.

Proposition 2.24 (Maximum Principle in non-divergence form). *Let $\Omega \subset \mathbb{R}^n$ be any bounded open set. Suppose that $u \in C^0(\overline{\Omega}) \cap C^2(\Omega)$ satisfies*

$$\sum_{i,j=1}^n a_{ij}(x) \partial_{ij} u \geq 0 \quad \text{in } \Omega,$$

where $(a_{ij}(x))_{ij}$ satisfy

$$0 < \lambda \text{Id} \leq (a_{ij}(x))_{ij} \quad \text{in } \Omega.$$

Then,

$$\sup_{\Omega} u = \sup_{\partial\Omega} u.$$

Proof. Let us begin by showing the maximum principle in the case

$$(2.19) \quad \sum_{i,j=1}^n a_{ij}(x) \partial_{ij} u > 0 \quad \text{in } B_1,$$

that is, when we have a strict inequality. We show it by contradiction: suppose that there exists some $x_o \in \Omega$ such that $\sup_{\Omega} u = u(x_o)$. Since it is an interior maximum, we must have $\nabla u(x_o) = 0$ and $D^2 u(x_o) \leq 0$, that is, $D^2 u(x_o)$ is a negative semi-definite symmetric matrix. In particular, all its eigenvalues are non-positive, and after a change of variables we have that

$$P^T D^2 u(x_o) P = \text{diag}(\lambda_1, \dots, \lambda_n) := D_{x_o}$$

for some orthogonal $n \times n$ matrix P , and with $\lambda_i \leq 0$ for all $1 \leq i \leq n$. Let $A(x) = (a_{ij}(x))_{ij}$, and let $A^P(x_o) := P^T A(x_o) P$. Then, since $A(x_o)$ is positive definite, so is $A^P(x_o) = (a_{ij}^P(x_o))_{ij}$. In particular, $a_{ii}^P(x_o) \geq 0$ for all $1 \leq i \leq n$. Then,

$$\text{tr}(A(x_o) D^2 u(x_o)) = \text{tr}(A(x_o) P D_{x_o} P^T) = \text{tr}(P^T A(x_o) P D_{x_o})$$

and, therefore

$$0 < \operatorname{tr}(A(x_o)D^2u(x_o)) = \operatorname{tr}(A^P(x_o)D_{x_o}) = \sum_{i=1}^n a_{ii}^P(x_o)\lambda_i \leq 0,$$

a contradiction. Here, we used that $a_{ii}^P(x_o) \geq 0$ and $\lambda_i \leq 0$ for all $1 \leq i \leq n$. This shows that the maximum principle holds when the strict inequality (2.19) is satisfied.

Let us now remove this hypothesis. Let R be large enough such that $B_R \supset \Omega$ — after a translation, we can take $R = \frac{1}{2}\operatorname{diam}(\Omega)$. Consider now the function

$$u_\varepsilon(x) := u(x) + \varepsilon e^{x_1} \quad \text{for } x \in \Omega,$$

for $\varepsilon > 0$. Notice that,

$$\sum_{i,j=1}^n a_{ij}(x)\partial_{ij}u_\varepsilon(x) \geq \lambda \varepsilon e^{x_1} > 0 \quad \text{in } \Omega.$$

In particular, we can apply the result for (2.19) to obtain that

$$\sup_{\Omega} u \leq \sup_{\Omega} u_\varepsilon = \sup_{\partial\Omega} u_\varepsilon \leq \sup_{\partial\Omega} u + \varepsilon e^R.$$

By letting $\varepsilon \downarrow 0$, we obtain the desired result. \square

As a consequence, we find:

Lemma 2.25. *Let $\Omega \subset \mathbb{R}^n$ be a bounded open set, and let $u \in C^0(\bar{\Omega}) \cap C^2(\Omega)$ be a function satisfying*

$$\begin{cases} \sum_{i,j=1}^n a_{ij}(x)\partial_{ij}u &= f & \text{in } \Omega \\ u &= g & \text{on } \partial\Omega, \end{cases}$$

where $(a_{ij})_{ij}$ fulfill the ellipticity conditions (2.18) for some $0 < \lambda \leq \Lambda < \infty$. Then,

$$\|u\|_{L^\infty(\Omega)} \leq C(\|f\|_{L^\infty(\Omega)} + \|g\|_{L^\infty(\partial\Omega)}),$$

for a constant C depending only on the diameter of Ω , λ , and Λ .

Proof. This follows exactly as in the proof of Lemma 1.14 using Proposition 2.24. \square

Proof of Schauder estimates. Let us now proceed with the proof of Schauder estimates for equations in non-divergence form, Theorem 2.20. We will first prove (in two ways) the following proposition, which is a weaker version of the estimate we want to show.

We will later prove that, in fact, such estimate is enough to prove Theorem 2.20.

Proposition 2.26. *Let $u \in C^{2,\alpha}$ be a solution to*

$$\sum_{i,j=1}^n a_{ij}(x) \partial_{ij} u = f(x) \quad \text{in } B_1,$$

with $f \in C^{0,\alpha}(B_1)$ and $a_{ij}(x) \in C^{0,\alpha}(B_1)$ for some $\alpha \in (0, 1)$, and $(a_{ij}(x))_{ij}$ fulfilling the ellipticity condition

$$0 < \lambda \text{Id} \leq (a_{ij}(x))_{ij} \leq \Lambda \text{Id} \quad \text{in } B_1,$$

for some $0 < \lambda \leq \Lambda < \infty$. Then, for any $\delta > 0$,

$$[D^2 u]_{C^{0,\alpha}(B_{1/2})} \leq \delta [D^2 u]_{C^{0,\alpha}(B_1)} + C_\delta (\|u\|_{L^\infty(B_1)} + \|f\|_{C^{0,\alpha}(B_1)}),$$

for some constant C_δ depending only on $\delta, \alpha, n, \lambda, \Lambda$, and $\|a_{ij}\|_{C^{0,\alpha}(B_1)}$.

Notice that, the previous statement is almost what we want: if we could let $\delta \downarrow 0$ and C_δ remained bounded, Theorem 2.20 would be proved (after using interpolation inequalities (1.9)). On the other hand, if the Hölder norm was in $B_{1/2}$ instead of B_1 , choosing $\delta = \frac{1}{2}$ would also complete the proof. As we will see, although it is not so straightforward, Proposition 2.26 is just one step away from the final result.

Let us provide two different proofs of Proposition 2.26. The first proof is a sketch that follows the same spirit as the first proof of Theorem 2.20. The second proof is through a blow-up argument (by contradiction).

First Proof of Proposition 2.26. The proof is very similar to the case of the Laplacian, the first proof of Theorem 2.14.

We define u_k as the solution to

$$\begin{cases} \sum_{i,j=1}^n a_{ij}(0) \partial_{ij} u_k = f(0) & \text{in } B_{2^{-k}} \\ u_k = u & \text{on } \partial B_{2^{-k}}. \end{cases}$$

(We freeze the coefficients at zero.) Then,

$$v_k := u - u_k$$

satisfies

$$\sum_{i,j=1}^n a_{ij}(0) \partial_{ij} v_k = f(x) - f(0) + \sum_{i,j=1}^n (a_{ij}(0) - a_{ij}(x)) \partial_{ij} u \quad \text{in } B_{2^{-k}}.$$

By the maximum principle (Lemma 2.25) we get

$$\begin{aligned} \|u - u_k\|_{L^\infty(B_{2^{-k}})} &\leq C 2^{-2k} \left(2^{-\alpha k} \|f\|_{C^{0,\alpha}(B_{2^{-k}})} \right. \\ &\quad \left. + 2^{-\alpha k} \|D^2 u\|_{L^\infty(B_{2^{-k}})} \sum_{i,j=1}^n \|a_{ij}\|_{C^{0,\alpha}(B_{2^{-k}})} \right). \end{aligned}$$

Thus,

$$\|u_k - u_{k+1}\|_{L^\infty(B_{2^{-k-1}})} \leq C 2^{-k(2+\alpha)} \left(\|f\|_{C^{0,\alpha}(B_{2^{-k}})} + \|D^2 u\|_{L^\infty(B_{2^{-k}})} \right),$$

where the constant C depends only on α , n , λ , Λ , and $\|a_{ij}\|_{C^{0,\alpha}(B_1)}$.

Following the exact same proof as in the case of the Laplacian, $\Delta u = f(x)$, we now get

$$[D^2 u]_{C^{0,\alpha}(B_{1/2})} \leq C \left(\|u\|_{L^\infty(B_1)} + \|f\|_{C^{0,\alpha}(B_1)} + \|D^2 u\|_{L^\infty(B_1)} \right).$$

This is *almost* exactly what we wanted to prove. However, we have an extra term $\|D^2 u\|_{L^\infty(B_1)}$ on the right-hand side. This can be dealt with by means of interpolation inequalities.

We use that, for any $\varepsilon > 0$, there is C_ε such that

$$(2.20) \quad \|D^2 u\|_{L^\infty(B_1)} \leq \varepsilon [D^2 u]_{C^{0,\alpha}(B_1)} + C_\varepsilon \|u\|_{L^\infty(B_1)}$$

see (1.9) in Chapter 1.

The idea is that, since the $\|D^2 u\|_{L^\infty}$ term is lower order, we can absorb it in the left-hand side by paying the price of adding more $\|u\|_{L^\infty}$ norm on the right-hand side.

Namely, we have

$$\begin{aligned} [D^2 u]_{C^{0,\alpha}(B_{1/2})} &\leq C \left(\|u\|_{L^\infty(B_1)} + \|f\|_{C^{0,\alpha}(B_1)} + \|D^2 u\|_{L^\infty(B_1)} \right) \\ &\stackrel{\text{(by interpolation)}}{\leq} C \left(C_\varepsilon \|u\|_{L^\infty(B_1)} + \|f\|_{C^{0,\alpha}(B_1)} + \varepsilon [D^2 u]_{C^{0,\alpha}(B_1)} \right) \\ &\leq C_\delta \left(\|u\|_{L^\infty(B_1)} + \|f\|_{C^{0,\alpha}(B_1)} \right) + \delta [D^2 u]_{C^{0,\alpha}(B_1)}, \end{aligned}$$

where we have used the interpolation inequality, and in the last step we have chosen $\varepsilon = \delta/C > 0$. The constant C_δ depends only on δ , α , n , λ , Λ , and $\|a_{ij}\|_{C^{0,\alpha}(B_1)}$. This concludes the proof. \square

For the second proof of Proposition 2.26 we use a robust blow-up method due to L. Simon, [Sim97]. For simplicity, we will first prove it for the Laplacian case. After proving it for the Laplacian, we explain in detail how to adapt the method for the more general non-divergence operators.

Second Proof of Proposition 2.26. Assume first that $(a_{ij}(x))_{ij} = \text{Id}$, that is, $\Delta u = f$ in B_1 . We then explain the modifications needed to show the result in the general case, $\sum_{i,j=1}^n a_{ij}(x) \partial_{ij} u(x) = f(x)$ in B_1 .

Thanks to interpolation inequalities we only need to prove the following estimate for any $\delta > 0$ sufficiently small,

$$(2.21) \quad [D^2 u]_{C^{0,\alpha}(B_{1/2})} \leq \delta [D^2 u]_{C^{0,\alpha}(B_1)} + C_\delta \left(\|D^2 u\|_{L^\infty(B_1)} + [f]_{C^{0,\alpha}(B_1)} \right)$$

for all $u \in C^{2,\alpha}(B_1)$ with $\Delta u = f$ in B_1 . Indeed, if (2.21) holds then, by interpolation (2.20), with $\varepsilon = \delta/C_\delta$,

$$[D^2u]_{C^{0,\alpha}(B_{1/2})} \leq 2\delta[D^2u]_{C^{0,\alpha}(B_1)} + C_\delta (\|u\|_{L^\infty(B_1)} + [f]_{C^{0,\alpha}(B_1)})$$

for some new C_δ depending only on δ , n and α , which is the desired result.

We will now show that (2.21) holds by contradiction, for some C_δ depending only on δ , n , and α . Indeed, suppose that it does not hold. Then, there exist sequences $u_k \in C^{2,\alpha}(B_1)$ and $f_k \in C^{0,\alpha}(B_1)$ for $k \in \mathbb{N}$ such that

$$\Delta u_k = f_k \quad \text{in } B_1,$$

and for a fixed small constant $\delta_o > 0$ we have

$$(2.22) \quad [D^2u_k]_{C^{0,\alpha}(B_{1/2})} > \delta_o [D^2u_k]_{C^{0,\alpha}(B_1)} + k (\|D^2u_k\|_{L^\infty(B_1)} + [f_k]_{C^{0,\alpha}(B_1)}).$$

We now have to reach a contradiction.

Select $x_k, y_k \in B_{1/2}$ such that

$$(2.23) \quad \frac{|D^2u_k(x_k) - D^2u_k(y_k)|}{|x_k - y_k|^\alpha} \geq \frac{1}{2} [D^2u_k]_{C^{0,\alpha}(B_{1/2})}$$

and let

$$\rho_k := |x_k - y_k|.$$

Observe that we must necessarily have $\rho_k \rightarrow 0$ as $k \rightarrow \infty$, since

$$\begin{aligned} \frac{1}{2} [D^2u_k]_{C^{0,\alpha}(B_{1/2})} &\leq \frac{|D^2u_k(x_k) - D^2u_k(y_k)|}{\rho_k^\alpha} \\ &\leq \frac{2\|D^2u_k\|_{L^\infty(B_1)}}{\rho_k^\alpha} \leq \frac{2[D^2u_k]_{C^{0,\alpha}(B_{1/2})}}{k\rho_k^\alpha}, \end{aligned}$$

where we have used (2.22) in the last inequality. Thus,

$$\rho_k \leq Ck^{-\frac{1}{\alpha}} \rightarrow 0 \quad \text{as } k \rightarrow \infty$$

Now, we rescale and blow up. Define

$$\tilde{u}_k(x) := \frac{u_k(x_k + \rho_k x) - p_k(x)}{\rho_k^{2+\alpha} [D^2u_k]_{C^{0,\alpha}(B_1)}}, \quad \tilde{f}_k(x) := \frac{f_k(x_k + \rho_k x) - f_k(x_k)}{\rho_k^\alpha [D^2u_k]_{C^{0,\alpha}(B_1)}},$$

where the quadratic polynomial p_k is chosen so that

$$(2.24) \quad \tilde{u}_k(0) = |\nabla \tilde{u}_k(0)| = |D^2 \tilde{u}_k(0)| = 0.$$

Namely,

$$p_k(z) := u_k(x_k) + \rho_k \sum_{i=1}^n \partial_i u_k(x_k) z_i + \frac{1}{2} \rho_k^2 \sum_{i,j=1}^n \partial_{ij} u_k(x_k) z_i z_j.$$

It is now a simple computation to check that

$$(2.25) \quad \Delta \tilde{u}_k = \tilde{f}_k \quad \text{in } B_{1/(2\rho_k)}.$$

Let us also denote

$$\xi_k := \frac{y_k - x_k}{\rho_k} \in \mathbb{S}^{n-1}.$$

Notice that

$$(2.26) \quad [D^2 \tilde{u}_k]_{C^{0,\alpha}(B_{1/(2\rho_k)})} \leq 1, \quad \text{and} \quad |D^2 \tilde{u}_k(\xi_k)| > \frac{\delta_\circ}{2},$$

where for the second inequality we use (2.22)-(2.23).

Since \tilde{u}_k are uniformly bounded in compact subsets, and bounded in the $C^{2,\alpha}$ norm (see (2.24)-(2.26)), we have by Arzelà–Ascoli that the sequence \tilde{u}_k converges (up to a subsequence and in the C^2 norm) to a $C^{2,\alpha}$ function \tilde{u} on compact subsets of \mathbb{R}^n . Moreover, again up to a subsequence, we have that $\xi_k \rightarrow \xi \in \mathbb{S}^{n-1}$.

By the properties of \tilde{u}_k , we deduce that \tilde{u} satisfies

$$(2.27) \quad \tilde{u}(0) = |\nabla \tilde{u}(0)| = |D^2 \tilde{u}(0)| = 0, \quad [D^2 \tilde{u}]_{C^{0,\alpha}(\mathbb{R}^n)} \leq 1, \quad |D^2 \tilde{u}(\xi)| > \frac{\delta_\circ}{2}.$$

On the other hand, for any $R \geq 1$ we have

$$\begin{aligned} \|\tilde{f}_k\|_{L^\infty(B_R)} &= \sup_{x \in B_R} \frac{|f_k(x_k + \rho_k x) - f_k(x_k)|}{\rho_k^\alpha [D^2 u_k]_{C^{0,\alpha}(B_1)}} \leq \frac{(\rho_k R)^\alpha [f_k]_{C^{0,\alpha}(B_1)}}{\rho_k^\alpha [D^2 u_k]_{C^{0,\alpha}(B_1)}} \\ &\leq \frac{R^\alpha [D^2 u_k]_{C^{0,\alpha}(B_{1/2})}}{k [D^2 u_k]_{C^{0,\alpha}(B_1)}} \leq \frac{R^\alpha}{k} \rightarrow 0, \quad \text{as } k \rightarrow \infty. \end{aligned}$$

Thus, $\tilde{f}_k \rightarrow 0$ uniformly on compact sets of \mathbb{R}^n . Together with the fact that $\tilde{u}_k \rightarrow \tilde{u}$ in the C^2 norm in compact sets, we deduce (recall (2.25))

$$\Delta \tilde{u} = 0 \quad \text{in } \mathbb{R}^n.$$

That is, \tilde{u} is harmonic and, in particular, so is $\partial_{ij} \tilde{u}$ for any $i, j = 1, \dots, n$.

Let us now use the three properties in (2.27) to get a contradiction. First notice that we have $[D^2 \tilde{u}]_{C^{0,\alpha}(\mathbb{R}^n)} \leq 1$. Thus, $D^2 \tilde{u}$ has sub-linear growth at infinity, and by Liouville's theorem (Proposition 1.19) we find that $D^2 \tilde{u}$ is constant. That is, \tilde{u} is a quadratic polynomial, which also fulfills $\tilde{u}(0) = |\nabla \tilde{u}(0)| = |D^2 \tilde{u}(0)| = 0$. The only possibility is that $\tilde{u} \equiv 0$ in \mathbb{R}^n , which is a contradiction with $|D^2 \tilde{u}(\xi)| > \frac{\delta_\circ}{2}$.

Thus, the proposition is proved in the case of the Laplacian.

We now treat the case of variable coefficients,

$$\sum_{i,j=1}^n a_{ij}(x) \partial_{ij} u(x) = f(x) \quad \text{in } B_1,$$

with $a_{ij}(x)$ uniformly elliptic in B_1 (i.e., $0 < \lambda \text{Id} \leq (a_{ij}(x))_{ij} \leq \Lambda \text{Id}$ for $x \in B_1$) and with $\|a_{ij}\|_{C^{0,\alpha}(B_1)} \leq M < \infty$ for some M . The proof is

essentially the same. As before, we proceed by contradiction, by assuming that there exist sequences u_k , f_k , and $a_{ij}^{(k)}$ such that

$$\sum_{i,j=1}^n a_{ij}^{(k)}(x) \partial_{ij} u_k(x) = f_k(x) \quad \text{in } B_1,$$

and (2.22) holds.

The only difference with respect to the Laplacian case is the equation satisfied by \tilde{u}_k . Let us define,

$$\tilde{a}_{ij}^{(k)}(x) := a_{ij}^{(k)}(x_k + \rho_k x).$$

Notice that

$$[\tilde{a}_{ij}^{(k)}]_{C^{0,\alpha}(B_{1/(2\rho_k)})} \leq \rho_k^\alpha [a_{ij}^{(k)}]_{C^{0,\alpha}(B_1)} \rightarrow 0, \quad \text{as } k \rightarrow \infty.$$

In particular, up to subsequences, $\tilde{a}_{ij}^{(k)}$ converges uniformly in compact sets to some \tilde{a}_{ij} with $[\tilde{a}_{ij}^{(k)}]_{C^{0,\alpha}(\mathbb{R}^n)} = 0$, i.e., \tilde{a}_{ij} is constant. Then \tilde{u}_k satisfies

$$\sum_{i,j=1}^n \tilde{a}_{ij}^{(k)} \partial_{ij} \tilde{u}_k = \tilde{f}_k(x) - \sum_{i,j=1}^n \frac{\left(a_{ij}^{(k)}(x_k + \rho_k x) - a_{ij}^{(k)}(x_k) \right) \partial_{ij} u_k(x_k)}{\rho_k^\alpha [D^2 u_k]_{C^{0,\alpha}(B_1)}}.$$

Thus,

$$\begin{aligned} \left| \sum_{i,j=1}^n \tilde{a}_{ij}^{(k)} \partial_{ij} \tilde{u}_k - \tilde{f}_k(x) \right| &\leq \sum_{i,j=1}^n \frac{|x|^\alpha \rho_k^\alpha [a_{ij}^{(k)}]_{C^{0,\alpha}(B_1)} \|\partial_{ij} u_k\|_{L^\infty(B_1)}}{\rho_k^\alpha [D^2 u_k]_{C^{0,\alpha}(B_1)}} \\ &\leq C |x|^\alpha \frac{\|D^2 u_k\|_{L^\infty(B_1)}}{[D^2 u_k]_{C^{0,\alpha}(B_1)}} \leq C |x|^\alpha \frac{\|D^2 u_k\|_{L^\infty(B_1)}}{[D^2 u_k]_{C^{0,\alpha}(B_{1/2})}}. \end{aligned}$$

Using (2.22) we deduce that, for any $x \in B_\sigma$ for some fixed $\sigma \in (0, \infty)$, and for k large enough,

$$\left| \sum_{i,j=1}^n \tilde{a}_{ij}^{(k)} \partial_{ij} \tilde{u}_k - \tilde{f}_k(x) \right| \leq C(\sigma) \frac{\|D^2 u_k\|_{L^\infty(B_1)}}{[D^2 u_k]_{C^{0,\alpha}(B_{1/2})}} \leq \frac{C(\sigma)}{k}.$$

Taking the limit $k \rightarrow \infty$ (and recalling that $\tilde{f}_k \rightarrow 0$ uniformly in compact sets) we get

$$\sum_{i,j=1}^n \tilde{a}_{ij} \partial_{ij} \tilde{u} = 0 \quad \text{in } \mathbb{R}^n,$$

an equation with constant coefficients, which is equivalent to $\Delta \tilde{u} = 0$ in \mathbb{R}^n (see Remark 2.23), and we reach a contradiction as well. \square

We can now proceed with the proof of the Schauder estimates in non-divergence form. Namely, we will show how to go from Proposition 2.26 to Theorem 2.20. As with the previous results, we will do it in two different ways. In this case, however, both ways reduce to the same idea.

First Proof of Theorem 2.20. Define the semi-norm

$$[D^2u]_{\alpha;B_1}^* := \sup_{B_\rho(x_o) \subset B_1} \rho^{2+\alpha} [D^2u]_{C^{0,\alpha}(B_{\rho/2}(x_o))}.$$

Notice that this norm measures in a precise way how the $C^{2,\alpha}$ norm of U blows up as we approach ∂B_1 .

From the fact that Hölder semi-norms are sub-additive with respect to unions of convex sets,

$$(2.28) \quad [D^2u]_{\alpha;B_1}^* \leq C \sup_{B_\rho(x_o) \subset B_1} \rho^{2+\alpha} [D^2u]_{C^{0,\alpha}(B_{\rho/4}(x_o))}$$

(and, in fact, they are comparable) for some constant C depending only on α and n . Indeed, for any fixed ball $B_\rho(x_o) \subset B_1$, we cover $B_{\rho/2}(x_o)$ with N smaller balls $(B_{\rho/8}(z_j))_{1 \leq j \leq N}$, which, since $B_{\rho/2}(z_j) \subset B_1$, gives

$$\left(\frac{\rho}{2}\right)^{2+\alpha} [D^2u]_{C^{0,\alpha}(B_{\rho/8}(z_j))} \leq \sup_{B_\rho(x_o) \subset B_1} \rho^{2+\alpha} [D^2u]_{C^{0,\alpha}(B_{\rho/4}(x_o))}.$$

Thus,

$$\begin{aligned} \rho^{2+\alpha} [D^2u]_{C^{0,\alpha}(B_{\rho/2}(x_o))} &\leq \rho^{2+\alpha} \sum_{j=1}^N [D^2u]_{C^{0,\alpha}(B_{\rho/8}(z_j))} \\ &\leq 2^{2+\alpha} N \sup_{B_\rho(x_o) \subset B_1} \rho^{2+\alpha} [D^2u]_{C^{0,\alpha}(B_{\rho/4}(x_o))}. \end{aligned}$$

Taking the supremum on the left-hand side gives (2.28).

Applying the inequality

$$[D^2u]_{C^{0,\alpha}(B_{1/2})} \leq \delta [D^2u]_{C^{0,\alpha}(B_1)} + C_\delta (\|u\|_{L^\infty(B_1)} + \|f\|_{C^{0,\alpha}(B_1)})$$

from Proposition 2.26 to any ball $B_{\rho/2}(x_o) \subset B_\rho(x_o) \subset B_1$ we get

$$\begin{aligned} \rho^{2+\alpha} [D^2u]_{C^{0,\alpha}(B_{\rho/4})} &\leq \delta \rho^{2+\alpha} [D^2u]_{C^{0,\alpha}(B_{\rho/2})} + C_\delta (\|u\|_{L^\infty(B_1)} + \|f\|_{C^{0,\alpha}(B_1)}) \\ &\leq \delta [D^2u]_{\alpha;B_1}^* + C_\delta (\|u\|_{L^\infty(B_1)} + \|f\|_{C^{0,\alpha}(B_1)}). \end{aligned}$$

Taking the supremum and using (2.28) we get

$$\begin{aligned} \frac{1}{C} [D^2u]_{\alpha;B_1}^* &\leq \sup_{B_\rho(x_o) \subset B_1} \rho^{2+\alpha} [D^2u]_{C^{0,\alpha}(B_{\rho/4}(x_o))} \\ &\leq \delta [D^2u]_{\alpha;B_1}^* + C (\|u\|_{L^\infty(B_1)} + \|f\|_{C^{0,\alpha}(B_1)}). \end{aligned}$$

Now, if we fix a small enough $\delta > 0$, we can absorb the $[D^2u]_{\alpha;B_1}^*$ term on the left-hand side to get

$$[D^2u]_{C^{0,\alpha}(B_{1/2})} \leq [D^2u]_{\alpha;B_1}^* \leq C_\delta (\|u\|_{L^\infty(B_1)} + \|f\|_{C^{0,\alpha}(B_1)}),$$

which, after interpolation (see (1.9)) gives the desired result. \square

We also give an alternative proof of Theorem 2.20 by directly using the following abstract lemma. Such lemma constitutes a generalization of the previous proof.

Lemma 2.27. *Let $k \in \mathbb{R}$ and $\gamma > 0$. Let S be a non-negative function on the class of open convex subsets of B_1 , and suppose that S is sub-additive. That is, if A, A_1, \dots, A_N are open convex subsets of B_1 with $A \subset \bigcup_{j=1}^N A_j$, then $S(A) \leq \sum_{j=1}^N S(A_j)$.*

Then, there is $\delta > 0$ small (depending only on n and k) such that, if

$$\rho^k S(B_{\rho/2}(x_o)) \leq \delta \rho^k S(B_\rho(x_o)) + \gamma \quad \text{for all } B_\rho(x_o) \subset B_1,$$

then

$$S(B_{1/2}) \leq C\gamma,$$

for some C depending only on n and k .

Proof. Let

$$Q := \sup_{B_\rho(x_o) \subset B_1} \rho^k S(B_{\rho/2}(x_o)).$$

Thanks to the assumption in the Lemma, we get

$$\left(\frac{\rho}{2}\right)^k S(B_{\rho/4}(x_o)) \leq \delta \left(\frac{\rho}{2}\right)^k S(B_{\rho/2}(x_o)) + \gamma \leq \delta Q + \gamma, \quad \text{for all } B_\rho(x_o) \subset B_1.$$

Taking now the supremum for all $B_\rho(x_o) \subset B_1$ we get

$$\tilde{Q} := \sup_{B_\rho(x_o) \subset B_1} \left(\frac{\rho}{2}\right)^k S(B_{\rho/4}(x_o)) \leq \delta Q + \gamma.$$

We now claim that

$$(2.29) \quad Q \leq C\tilde{Q},$$

for some C depending only on n and k . This will yield

$$\frac{1}{C}Q \leq \tilde{Q} \leq \delta Q + \gamma \Rightarrow Q \leq \tilde{C}\gamma$$

if $\delta > 0$ is small enough depending only on n and k . Thus, we have to show (2.29).

Take any $B_\rho(x_o) \subset B_1$, and cover $B_{\rho/2}(x_o)$ with a finite collection of smaller balls $B_{\rho/8}(z_j)$ ($j = 1, 2, \dots, N$), with $z_j \in B_{\rho/2}(x_o)$ and $N \leq C$

(universally bounded depending only on the dimension). Since $B_{\rho/2}(z_j) \subset B_1$ we then have

$$\left(\frac{\rho}{4}\right)^k S(B_{\rho/8}(z_j)) \leq \tilde{Q}.$$

Adding up over all indices j , and using the sub-additivity of S , we obtain

$$\rho^k S(B_{\rho/2}(x_o)) \leq \sum_{j=1}^N \rho^k S(B_{\rho/8}(z_j)) \leq N4^k \tilde{Q} = C\tilde{Q}.$$

Taking the supremum, we reach (2.29). \square

Second Proof of Theorem 2.20. We use Lemma 2.27, with $k = \alpha$ and

$$S(A) := [D^2u]_{C^{0,\alpha}(A)},$$

which is sub-additive on open convex subsets. From the estimate in Proposition 2.26, fixing $\delta > 0$ from Lemma 2.27 (which depends only on α and n) we know

$$[D^2u]_{C^{0,\alpha}(B_{1/2})} \leq C (\|u\|_{L^\infty(B_1)} + \|f\|_{C^{0,\alpha}(B_1)}) + \delta [D^2u]_{C^{0,\alpha}(B_1)}.$$

Rescaling¹ to $B_\rho(x_o)$ with $\rho \leq 1$ we obtain

$$\begin{aligned} \rho^{2+\alpha} [D^2u]_{C^{0,\alpha}(B_{\rho/2}(x_o))} &\leq \\ &\leq \delta \rho^{2+\alpha} [D^2u]_{C^{0,\alpha}(B_\rho(x_o))} \\ &\quad + C (\|u\|_{L^\infty(B_\rho(x_o))} + \rho^2 \|f\|_{L^\infty(B_\rho(x_o))} + \rho^{2+\alpha} [f]_{C^{0,\alpha}(B_\rho(x_o))}) \\ &\leq \delta \rho^{2+\alpha} [D^2u]_{C^{0,\alpha}(B_\rho)} + C (\|u\|_{L^\infty(B_1)} + \|f\|_{C^{0,\alpha}(B_1)}). \end{aligned}$$

This is exactly

$$\rho^k S(B_{\rho/2}(x_o)) \leq \delta \rho^k S(B_\rho(x_o)) + \gamma,$$

with

$$\gamma = C_\delta (\|u\|_{L^\infty(B_1)} + \|f\|_{C^{0,\alpha}(B_1)}).$$

Thus, thanks to Lemma 2.27, we immediately deduce

$$S(B_{1/2}) \leq C\gamma,$$

that is,

$$[D^2u]_{C^{0,\alpha}(B_{1/2})} \leq C (\|u\|_{L^\infty(B_1)} + \|f\|_{C^{0,\alpha}(B_1)}).$$

Therefore, after using interpolation inequalities (see (1.9)) we get

$$\|u\|_{C^{2,\alpha}(B_{1/2})} \leq C (\|u\|_{L^\infty(B_1)} + \|f\|_{C^{0,\alpha}(B_1)})$$

as desired. \square

¹The rescaling is done by considering the estimate on $u_\rho(x) = u(x_o + \rho x)$, which fulfills $\sum a_{ij}^{(\rho)}(x) \partial_{ij} u_\rho(x) = \rho^2 f(x_o + \rho x) =: f_\rho(x)$ in B_1 , with $a_{ij}^{(\rho)}(x) = a_{ij}(x_o + \rho x)$ (notice that $\|a_{ij}^{(\rho)}\|_{C^{0,\alpha}(B_1)} \leq \|a_{ij}\|_{C^{0,\alpha}(B_1)}$). Then, $[D^2u_\rho]_{C^{0,\alpha}(B_{1/2})} = \rho^{2+\alpha} [D^2u]_{C^{0,\alpha}(B_{\rho/2}(x_o))}$ and $[f_\rho]_{C^{0,\alpha}(B_1)} = \rho^{2+\alpha} [f]_{C^{0,\alpha}(B_\rho(x_o))}$.

We finish this section by proving Corollary 2.21.

Proof of Corollary 2.21. We follow the proof of Corollary 2.17. We will show by induction on k that

$$(2.30) \quad \|u\|_{C^{k+2,\alpha}(B_{1/2})} \leq C \left(\|u\|_{L^\infty(B_1)} + \|f\|_{C^{k,\alpha}(B_1)} \right)$$

for some constant C depending only on n , α , k , λ , Λ , and $\|a_{ij}\|_{C^{k,\alpha}(B_1)}$. We apply the induction hypothesis to derivatives of the equation in non-divergence form.

As in the proof of Corollary 2.17, (2.30) deals with balls $B_{1/2}$ and B_1 , but after a rescaling and covering argument (see Remark 2.15), it could also be stated in balls $B_{1/2}$ and $B_{3/4}$.

The base case, $k = 0$, already holds by Theorem 2.20. Let us now assume that (2.30) holds for $k = m - 1$, and we will show it for $k = m$.

We differentiate the non-divergence-form equation with respect to ∂_e to get

$$\sum_{i,j=1}^n a_{ij}(x) \partial_{ij} \partial_e u(x) = \partial_e f(x) - \sum_{i,j=1}^n \partial_e a_{ij}(x) \partial_{ij} u(x) \quad \text{in } B_1.$$

Now, we apply the estimate (2.30) with $k = m - 1$ to $\partial_e u$ in the previous expression, in balls $B_{1/2}$ and $B_{3/4}$, to get

$$\begin{aligned} \|\partial_e u\|_{C^{m+1,\alpha}(B_{1/2})} &\leq C \left(\|\partial_e u\|_{L^\infty(B_{3/4})} + \|\partial_e f\|_{C^{m-1,\alpha}(B_{3/4})} \right. \\ &\quad \left. + \sum_{i,j=1}^n \|\partial_e a_{ij} \partial_{ij} u\|_{C^{m-1,\alpha}(B_{3/4})} \right). \end{aligned}$$

Notice that

$$\begin{aligned} \|\partial_e a_{ij} \partial_{ij} u\|_{C^{m-1,\alpha}(B_{3/4})} &\leq \|\partial_e a_{ij}\|_{C^{m-1,\alpha}(B_{3/4})} \|\partial_{ij} u\|_{C^{m-1,\alpha}(B_{3/4})} \\ &= C \|\partial_{ij} u\|_{C^{m-1,\alpha}(B_{3/4})} \\ &\leq C \left(\|u\|_{L^\infty(B_1)} + \|f\|_{C^{m-1,\alpha}(B_1)} \right), \end{aligned}$$

where in the last inequality we have used the induction hypothesis in balls $B_{3/4}$ and B_1 (see Remark 2.15). Using that $\|\partial_e u\|_{L^\infty(B_{3/4})} \leq \|u\|_{C^{2,\alpha}(B_{3/4})}$ we can use the base case (with balls $B_{3/4}$ and B_1) of (2.30) to bound this term. In all, we obtain that

$$\|\partial_e u\|_{C^{m+1,\alpha}(B_{1/2})} \leq C \left(\|u\|_{L^\infty(B_1)} + \|f\|_{C^{m-1,\alpha}(B_1)} \right),$$

which, combined with the base case, and for every $e \in \mathbb{S}^{n-1}$, yields the desired estimate. \square

2.4. Schauder estimates for operators in divergence form

We will next prove Schauder estimates for operators in divergence form. In particular, we will study the equation

$$(2.31) \quad \boxed{\operatorname{div}(A(x)\nabla u(x)) = \sum_{i,j=1}^n \partial_i(a_{ij}(x)\partial_j u(x)) = f(x) \quad \text{in } B_1,}$$

where $A(x) := (a_{ij}(x))_{ij}$ is uniformly elliptic, and $a_{ij}(x) \in C^{0,\alpha}$. Notice that, a priori, the expression (2.31) does not make sense even for C^∞ functions u : we are taking derivatives of $a_{ij}(x)$, which is only $C^{0,\alpha}$. That is why we need to define a weak notion of solution to (2.31). Thus, we will say that $u \in H^1(B_1)$ solves (2.31) weakly if

$$\int_{B_1} \nabla \phi(y) \cdot A(y)\nabla u(y) dy = - \int_{B_1} \phi(y)f(y) dy \quad \text{for all } \phi \in C_c^\infty(B_1).$$

We will prove the following:

Theorem 2.28 (Schauder estimates in divergence form). *Let $u \in C^{1,\alpha}$ be a weak solution to*

$$\sum_{i,j=1}^n \partial_i(a_{ij}(x)\partial_j u(x)) = f(x) \quad \text{in } B_1,$$

with $f \in L^q(B_1)$ for $q \geq \frac{n}{1-\alpha}$, and $a_{ij}(x) \in C^{0,\alpha}(B_1)$ for some $\alpha \in (0, 1)$, such that $(a_{ij}(x))_{ij}$ fulfills the ellipticity condition

$$(2.32) \quad 0 < \lambda \operatorname{Id} \leq (a_{ij}(x))_{ij} \leq \Lambda \operatorname{Id} \quad \text{in } B_1,$$

for some $0 < \lambda \leq \Lambda < \infty$. Then,

$$\|u\|_{C^{1,\alpha}(B_{1/2})} \leq C (\|u\|_{L^\infty(B_1)} + \|f\|_{L^q(B_1)})$$

for some constant C depending only on $\alpha, n, \lambda, \Lambda$, and $\|a_{ij}\|_{C^{0,\alpha}(B_1)}$.

And as a consequence, we also get higher order Schauder estimates for operators in divergence form.

Corollary 2.29 (Higher order Schauder estimates in divergence form). *Let $u \in C^{k+1,\alpha}$ be a weak solution to*

$$\sum_{i,j=1}^n \partial_i(a_{ij}(x)\partial_j u(x)) = f(x) \quad \text{in } B_1,$$

with $f \in C^{k-1+\alpha}(B_1)$ and $a_{ij}(x) \in C^{k,\alpha}(B_1)$ for some $\alpha \in (0, 1)$, $k \in \mathbb{N}$, such that $(a_{ij}(x))_{ij}$ fulfills the ellipticity condition (2.32) for some $0 < \lambda \leq \Lambda < \infty$. Then,

$$\|u\|_{C^{k+1,\alpha}(B_{1/2})} \leq C \left(\|u\|_{L^\infty(B_1)} + \|f\|_{C^{k-1,\alpha}(B_1)} \right)$$

for some constant C depending only on $\alpha, k, n, \lambda, \Lambda$, and $\|a_{ij}\|_{C^{k,\alpha}(B_1)}$.

The maximum principle. As in the case of operators in non-divergence form, we also have a maximum principle for equations in divergence form.

Proposition 2.30 (Maximum Principle in divergence form). *Let $\Omega \subset \mathbb{R}^n$ be a bounded open set. Suppose that $u \in H^1(\Omega)$ satisfies, in the weak sense,*

$$\sum_{i,j=1}^n \partial_i (a_{ij}(x) \partial_j u(x)) \geq 0 \quad \text{in } \Omega,$$

where $(a_{ij}(x))_{ij} \in L^\infty(\Omega)$ fulfill the pointwise ellipticity condition,

$$0 < (a_{ij}(x))_{ij} \quad \text{in } \Omega.$$

Then,

$$\sup_{\Omega} u = \sup_{\partial\Omega} u.$$

Proof. We know that, denoting $A(x) = (a_{ij}(x))_{ij}$,

$$\int_{\Omega} \nabla \phi \cdot A(x) \nabla u \, dx \leq 0 \quad \text{for all } \phi \in C_c^\infty(\Omega), \phi \geq 0.$$

In particular, by approximation (see **(S6)** in Chapter 1), the previous expression holds for all $\phi \in H_0^1(\Omega)$ such that $\phi \geq 0$. We take, as test function, $\phi(x) := (u - \sup_{\partial\Omega} u)^+ \in H_0^1(\Omega)$, where $f^+ := \max\{f, 0\}$ denotes the positive part. Then,

$$\int_{\Omega} \nabla \phi \cdot A(x) \nabla \phi \, dx = \int_{\Omega} \nabla \phi \cdot A(x) \nabla u \, dx \leq 0.$$

Since $A(x) > 0$, this implies that $\nabla \phi \equiv 0$, and ϕ is constant. Since $\phi \in H_0^1(\Omega)$, this implies that $\phi \equiv 0$, that is, $u \leq \sup_{\partial\Omega} u$ in Ω , as wanted. \square

Proof of Schauder estimates. We proceed with the proof of Theorem 2.28. We will do so via a blow-up argument, in the spirit of the second proof of Proposition 2.26.

Proof of Theorem 2.28. As in the (second) proof of Proposition 2.26, we will show that, for any $\delta > 0$,

$$(2.33) \quad [\nabla u]_{C^{0,\alpha}(B_{1/2})} \leq \delta [\nabla u]_{C^{0,\alpha}(B_1)} + C_\delta (\|\nabla u\|_{L^\infty(B_1)} + \|f\|_{L^q(B_1)})$$

for all $u \in C^{1,\alpha}(B_1)$ such that

$$\operatorname{div}(A(x) \nabla u(x)) = \sum_{i,j=1}^n \partial_i (a_{ij}(x) \partial_j u(x)) = f(x), \quad \text{weakly in } B_1.$$

This yields

$$\|u\|_{C^{1,\alpha}(B_{1/2})} \leq \delta [\nabla u]_{C^{0,\alpha}(B_1)} + C_\delta (\|u\|_{L^\infty(B_1)} + \|f\|_{L^q(B_1)})$$

and so, proceeding as in the proof of Theorem 2.20 by using Lemma 2.27, (or, alternatively, adapting the first proof of Theorem 2.20), we get the desired result. Let us focus, therefore, on the proof of (2.33):

Suppose that it does not hold. Then, there exist sequences $u_k \in C^{1,\alpha}(B_1)$ and $f_k \in L^q(B_1)$ for $k \in \mathbb{N}$ such that

$$\operatorname{div}(A_k(x)u_k(x)) = f_k(x) \quad \text{weakly in } B_1,$$

and for a fixed small constant $\delta_o > 0$ we have

$$(2.34) \quad [\nabla u_k]_{C^{0,\alpha}(B_{1/2})} > \delta_o [\nabla u_k]_{C^{0,\alpha}(B_1)} + k (\|\nabla u_k\|_{L^\infty(B_1)} + \|f_k\|_{L^q(B_1)}).$$

We now have to reach a contradiction.

Select $x_k, y_k \in B_{1/2}$ such that

$$(2.35) \quad \frac{|\nabla u_k(x_k) - \nabla u_k(y_k)|}{|x_k - y_k|^\alpha} \geq \frac{1}{2} [\nabla u_k]_{C^{0,\alpha}(B_{1/2})}$$

and let

$$\rho_k := \frac{|x_k - y_k|}{2}, \quad \text{and} \quad z_k := \frac{x_k + y_k}{2}.$$

Then, as in Proposition 2.26, $\rho_k \leq Ck^{-\frac{1}{\alpha}} \rightarrow 0$ as $k \rightarrow \infty$. Define

$$\tilde{u}_k(x) := \frac{u_k(z_k + \rho_k x) + u_k(z_k - \rho_k x) - 2u_k(z_k)}{\rho_k^{1+\alpha} [\nabla u_k]_{C^{0,\alpha}(B_1)}}.$$

Then,

$$(2.36) \quad \tilde{u}_k(0) = |\nabla \tilde{u}_k(0)| = 0.$$

We remark that here, instead of defining \tilde{u}_k as in Proposition 2.26 (i.e., subtracting a quadratic polynomial), we have used second order incremental quotients.

Let us also denote

$$\xi_k := \frac{y_k - x_k}{2\rho_k} \in \mathbb{S}^{n-1}.$$

Notice that

$$(2.37) \quad [\nabla \tilde{u}_k]_{C^{0,\alpha}(B_{1/(2\rho_k)})} \leq 2, \quad \text{and} \quad |\nabla \tilde{u}_k(\xi_k)| > \frac{\delta_o}{2},$$

where for the second inequality we use (2.34) and (2.35).

Since \tilde{u}_k are uniformly bounded in compact subsets, and bounded in the $C^{1,\alpha}$ norm (due to (2.36) and (2.37)), it follows by Arzelà–Ascoli that the sequence \tilde{u}_k converges (in the C^1 norm) to a $C^{1,\alpha}$ function \tilde{u} on compact subsets of \mathbb{R}^n (up to a subsequence). Moreover, again up to a subsequence, we have that $\xi_k \rightarrow \xi \in \mathbb{S}^{n-1}$.

By the properties of \tilde{u}_k , we deduce that \tilde{u} satisfies

$$(2.38) \quad \tilde{u}(0) = |\nabla \tilde{u}(0)| = 0, \quad [\nabla \tilde{u}]_{C^{0,\alpha}(\mathbb{R}^n)} \leq 2, \quad |\nabla \tilde{u}(\xi)| > \frac{\delta_o}{2}.$$

Let us check which equation does \tilde{u}_k satisfy. Let

$$\tilde{a}_{ij}^{(k)}(x) := a_{ij}^{(k)}(z_k + \rho_k x),$$

so that, as in Proposition 2.26, $\tilde{a}_{ij}^{(k)}$ converges uniformly in compact sets to some \tilde{a}_{ij} constant. For any $\phi \in C_c^\infty(B_1)$, we know that

$$(2.39) \quad \int_{B_1} \nabla \phi \cdot A_k(x) \nabla u_k = - \int_{B_1} f_k \phi.$$

Let $\tilde{A}_k(x) := A_k(z_k + \rho_k x) = (\tilde{a}_{ij}^{(k)}(x))_{ij}$. Let $\phi \in C_c^\infty(\mathbb{R}^n)$, and let k be large enough so that $\text{supp } \phi \subset B_{1/(2\rho_k)}$. Let

$$\int \nabla \phi \cdot \tilde{A}_k(x) \nabla \tilde{u}_k = \text{I} - \text{II},$$

where

$$\begin{aligned} \text{I} &= \frac{1}{\rho_k^\alpha [\nabla u_k]_{C^{0,\alpha}(B_1)}} \int \nabla \phi(x) \cdot A_k(z_k + \rho_k x) \nabla u_k(z_k + \rho_k x) dx \\ &= \frac{1}{\rho_k^\alpha [\nabla u_k]_{C^{0,\alpha}(B_1)}} \int \nabla_y (\phi(\rho_k^{-1}(y - z_k))) \cdot A_k(y) \nabla u_k(y) \rho_k^{-n+1} dy \\ &= \frac{-\rho_k^{1-\alpha}}{[\nabla u_k]_{C^{0,\alpha}(B_1)}} \int \phi(x) f_k(z_k + \rho_k x) dx, \end{aligned}$$

thanks to (2.39), and

$$\text{II} = \frac{1}{\rho_k^\alpha [\nabla u_k]_{C^{0,\alpha}(B_1)}} \int \nabla \phi(x) \cdot A_k(z_k + \rho_k x) \nabla u_k(z_k - \rho_k x) dx = \text{II}_i + \text{II}_{ii}.$$

Here, we have denoted by II_i and II_{ii} the following quantities:

$$\text{II}_i = \frac{1}{\rho_k^\alpha [\nabla u_k]_{C^{0,\alpha}(B_1)}} \int \nabla \phi(x) \cdot (A_k(z_k + \rho_k x) - A_k(z_k - \rho_k x)) \nabla u_k(z_k - \rho_k x) dx$$

and

$$\begin{aligned} \text{II}_{ii} &= \frac{1}{\rho_k^\alpha [\nabla u_k]_{C^{0,\alpha}(B_1)}} \int \nabla \phi(x) \cdot A_k(z_k - \rho_k x) \nabla u_k(z_k - \rho_k x) dx \\ &= \frac{\rho_k^{1-\alpha}}{[\nabla u_k]_{C^{0,\alpha}(B_1)}} \int \phi(x) f_k(z_k - \rho_k x) dx. \end{aligned}$$

Let us now show that

$$\left| \int \nabla \phi \cdot \tilde{A}_k \nabla \tilde{u}_k \right| \rightarrow 0, \quad \text{as } k \rightarrow \infty$$

for all $\phi \in C_c^\infty(\mathbb{R}^n)$, by bounding each term separately.

Notice that, for $\frac{1}{q} + \frac{1}{q'} = 1$,

$$\begin{aligned} \left| \int \phi(x) f_k(z_k + \rho_k x) dx \right| &\leq \left(\int |\phi|^{q'} \right)^{\frac{1}{q'}} \left(\int |f_k(z_k + \rho_k x)|^q dx \right)^{\frac{1}{q}} \\ &\leq C(\phi) \|f_k\|_{L^q(B_1)} \rho_k^{-\frac{n}{q}}. \end{aligned}$$

Then,

$$|\mathbf{I}| \leq C(\phi) \rho_k^{1-\alpha-\frac{n}{q}} \frac{\|f_k\|_{L^q(B_1)}}{[\nabla u_k]_{C^{0,\alpha}(B_1)}} \leq C(\phi) \rho_k^{1-\alpha-\frac{n}{q}} k^{-1} \rightarrow 0, \quad \text{as } k \rightarrow \infty,$$

as long as $1 - \alpha - \frac{n}{q} \geq 0$, that is, $q \geq \frac{n}{1-\alpha}$. In the last step we have used (2.34). Similarly,

$$|\mathbf{II}_{ii}| \rightarrow 0, \quad \text{as } k \rightarrow \infty,$$

since $q \geq \frac{n}{1-\alpha}$. Finally,

$$\begin{aligned} |\mathbf{II}_i| &\leq \frac{[A_k]_{C^{0,\alpha}(B_1)}}{[\nabla u_k]_{C^{0,\alpha}(B_1)}} \int |\nabla \phi| |x|^\alpha \|\nabla u\|_{L^\infty(B_1)} dx \\ &\leq C(\phi) \frac{\|\nabla u\|_{L^\infty(B_1)}}{[\nabla u_k]_{C^{0,\alpha}(B_1)}} \leq \frac{C(\phi)}{k} \rightarrow 0, \quad \text{as } k \rightarrow \infty. \end{aligned}$$

Here, we used again (2.34). That is, $|\mathbf{II}_i| \rightarrow 0$ uniformly in compact sets of \mathbb{R}^n .

Then we conclude that, for any $\phi \in C_c^\infty(\mathbb{R}^n)$,

$$\left| \int \nabla \phi \cdot \tilde{A}_k(x) \nabla \tilde{u}_k \right| \rightarrow 0, \quad \text{as } k \rightarrow \infty.$$

By taking limits, up to a subsequence we will have that $\tilde{A}_k \rightarrow \tilde{A}$ uniformly in compact sets, where \tilde{A} is a constant coefficient matrix. Thus, we deduce that

$$\int \nabla \phi \cdot \tilde{A} \nabla \tilde{u} = 0 \quad \text{for all } \phi \in C_c^\infty(\mathbb{R}^n).$$

This means that, after a change of variables, \tilde{u} is harmonic (recall Remark 2.23). By Liouville's theorem (Proposition 1.19) we obtain that $\nabla \tilde{u}$ must be constant (since it is harmonic, and $[\nabla \tilde{u}]_{C^{0,\alpha}(\mathbb{R}^n)} \leq 2$). However, $\nabla \tilde{u}(0) = 0$ and $\nabla \tilde{u}(\xi) \neq 0$ (see (2.38)), a contradiction. \square

Proof of Corollary 2.29. We proceed by induction on k . The case $k = 0$ is due to Theorem 2.28. Then, let us assume that

$$(2.40) \quad \|u\|_{C^{k+1,\alpha}(B_{1/2})} \leq C \left(\|u\|_{L^\infty(B_1)} + \|f\|_{C^{k-1,\alpha}(B_1)} \right)$$

holds for all $k \leq m - 1$, and let us show it for $k = m$.

To do so, notice that, since $a_{ij}(x) \in C^{m,\alpha}$, and $m \geq 1$, we can compute the derivatives in the divergence-form equation, to get

$$\sum_{i,j=1}^n a_{ij}(x) \partial_{ij} u = f(x) - \sum_{i,j=1}^n \partial_i a_{ij}(x) \partial_j u \quad \text{in } B_1,$$

that is, a non-divergence-form equation, where the right-hand side is in $C^{m-1,\alpha}$. Applying the higher order Schauder estimates for equations in non-divergence form, Corollary 2.21 (in balls $B_{1/2}$ and $B_{3/4}$), we get that

$$\begin{aligned} \|u\|_{C^{m+1,\alpha}(B_{1/2})} \leq C & \left(\|u\|_{L^\infty(B_{3/4})} + \|f\|_{C^{m-1,\alpha}(B_{3/4})} + \right. \\ & \left. + \sum_{i,j=1}^n \|\partial_i(a_{ij})\|_{C^{m-1,\alpha}(B_{3/4})} \|\partial_j u\|_{C^{m-1,\alpha}(B_{3/4})} \right), \end{aligned}$$

that is,

$$\|u\|_{C^{m+1,\alpha}(B_{1/2})} \leq C \left(\|u\|_{L^\infty(B_{3/4})} + \|f\|_{C^{m-1,\alpha}(B_{3/4})} + \|u\|_{C^{m,\alpha}(B_{3/4})} \right),$$

where the constant C depends only on $n, \alpha, \lambda, \Lambda$, and $\|a_{ij}\|_{C^{m,\alpha}(B_1)}$. Using now the hypothesis induction, (2.40) for $k = m - 1$, in balls $B_{3/4}$ and B_1 , completes the proof. \square

2.5. The case of continuous coefficients

Let us finish this chapter by studying equations in divergence and non-divergence form with continuous coefficients.

In this section we establish a priori Schauder estimates for (2.1) and (2.2) whenever $a_{ij} \in C^0(B_1)$ (and the right-hand side is bounded or in L^n respectively). This kind of estimates will be useful in the next chapters.

In this limiting case (when $\alpha \downarrow 0$), one could extrapolate from the previous results that the solution has respectively bounded C^2 and C^1 norm. However, this is not true.

We will show, instead, that we gain *almost* two derivatives. Namely, for any $\varepsilon > 0$, the solution has bounded $C^{2-\varepsilon}$ and $C^{1-\varepsilon}$ norm. More precisely, we prove below the following results:

Proposition 2.31. *Let $u \in C^2$ be any solution to*

$$\sum_{i,j=1}^n a_{ij}(x) \partial_{ij} u = f(x) \quad \text{in } B_1,$$

with $f \in L^\infty(B_1)$ and $a_{ij} \in C^0(B_1)$ for some $(a_{ij}(x))_{ij}$ satisfying (2.18) for some $0 < \lambda \leq \Lambda$. Then, for any $\varepsilon > 0$,

$$\|u\|_{C^{1,1-\varepsilon}(B_{1/2})} \leq C_\varepsilon (\|u\|_{L^\infty(B_1)} + \|f\|_{L^\infty(B_1)})$$

for some constant C_ε depending only on ε , n , λ , Λ , and $(a_{ij})_{ij}$.

That is, we are not gaining two *full* derivatives, but instead we are losing an arbitrarily small factor. This loss is paired with the fact that the constant C_ε diverges when $\varepsilon \downarrow 0$; see [JMV09, EM17] for counterexamples in the case $\varepsilon = 0$. This is also consistent with what occurs with the Laplacian (see the counterexample at the beginning of Section 2.2).

We remark that the dependence of C on $(a_{ij})_{i,j}$ in the previous proposition is a dependence on the modulus of continuity of $(a_{ij})_{i,j}$. That is, if $\omega : [0, \infty) \rightarrow [0, \infty)$ is a continuous monotone function with $\omega(0) = 0$ and such that

$$|a_{ij}(x) - a_{ij}(y)| \leq \omega(|x - y|), \quad \text{for all } x, y \in B_1,$$

then the constant in the previous proposition depends on ω rather than on $(a_{ij})_{i,j}$.

For divergence-form equations we have the following:

Proposition 2.32. *Let $u \in C^1$ be a weak solution to*

$$\sum_{i,j=1}^n \partial_i(a_{ij}(x)\partial_j u) = f(x) \quad \text{in } B_1,$$

with $f \in L^n(B_1)$ and $a_{ij}(x) \in C^0(B_1)$ satisfying the ellipticity conditions (2.32) for some $0 < \lambda \leq \Lambda$. Then, for any $\varepsilon > 0$,

$$\|u\|_{C^{1-\varepsilon}(B_{1/2})} \leq C_\varepsilon (\|u\|_{L^\infty(B_1)} + \|f\|_{L^\infty(B_1)})$$

for some constant C_ε depending only on ε , n , λ , Λ , and $(a_{ij})_{ij}$.

The proofs of the previous two propositions are analogous to those of the Schauder estimates for operators in non-divergence and divergence form respectively.

We give short sketches of the proofs of Propositions 2.31 and 2.32 that contain all the essential information regarding the steps to take.

Sketch of the proof of Proposition 2.31. We give a short sketch of the proof in the case $(a_{ij}(x))_{ij} = \text{Id}$, and leave the details to the reader. The proof sketched follows the same steps and arguments as the second proof of Proposition 2.26.

Proceeding analogously, and after using Lemma 2.27, (cf. first or second proof of Theorem 2.20), we just need to show that for any $\delta > 0$

$$[\nabla u]_{C^{1-\varepsilon}(B_{1/2})} \leq \delta [\nabla u]_{C^{1-\varepsilon}(B_1)} + C_\delta (\|\nabla u\|_{L^\infty(B_1)} + \|f\|_{L^\infty(B_1)}),$$

for some C_δ .

By contradiction, suppose that we have a sequence $f_k \in L^\infty(B_1)$, $u_k \in C^2(B_1)$, and coefficients $(a_{ij}^{(k)})_{ij}$ with a common modulus of continuity, such that $\sum_{i,j=1}^n a_{ij}^{(k)} \partial_{ij} u_k = f_k$ and

$$(2.41) \quad [\nabla u_k]_{C^{1-\varepsilon}(B_{1/2})} > \delta_o [\nabla u_k]_{C^{1-\varepsilon}(B_1)} + k(\|\nabla u_k\|_{L^\infty(B_1)} + \|f_k\|_{L^\infty(B_1)}),$$

for some $\delta_o > 0$.

Select $x_k, y_k \in B_{1/2}$ such that

$$(2.42) \quad \frac{|\nabla u_k(x_k) - \nabla u_k(y_k)|}{|x_k - y_k|^{1-\varepsilon}} \geq \frac{1}{2} [\nabla u_k]_{C^{1-\varepsilon}(B_{1/2})}$$

and let $\rho_k := |x_k - y_k|$, so that as in the second proof of Proposition 2.26 $\rho_k \downarrow 0$. Define

$$\tilde{u}_k(x) := \frac{u_k(x_k + \rho_k x) - u_k(x_k) - \rho_k \nabla u_k(x_k) \cdot x}{\rho_k^{2-\varepsilon} [\nabla u_k]_{C^{1-\varepsilon}(B_1)}}$$

and

$$\tilde{f}_k(x) := \rho_k^\varepsilon \frac{f_k(x_k + \rho_k x) - f_k(x_k)}{[\nabla u_k]_{C^{1-\varepsilon}(B_1)}},$$

so that

$$(2.43) \quad \tilde{u}_k(0) = |\nabla \tilde{u}_k(0)| = 0, \quad \sum_{i,j=1}^n \tilde{a}_{ij}^{(k)} \partial_{ij} \tilde{u}_k = \tilde{f}_k \quad \text{in } B_{1/(2\rho_k)}.$$

where

$$\tilde{a}_{ij}^{(k)}(x) := a_{ij}^{(k)}(z_k + \rho_k x).$$

Denoting $\xi_k := \frac{y_k - x_k}{\rho_k} \in \mathbb{S}^{n-1}$, we have

$$[\nabla \tilde{u}_k]_{C^{1-\varepsilon}(B_{\frac{1}{2\rho_k}})} \leq 1, \quad \text{and} \quad |\nabla \tilde{u}_k(\xi_k)| > \frac{\delta_o}{2},$$

by means of (2.41) and (2.42).

As in Proposition 2.26, \tilde{u}_k converges (up to a subsequence and in the C^1 norm) to a $C^{1,1-\varepsilon}$ function \tilde{u} on compact subsets of \mathbb{R}^n , and $\xi_k \rightarrow \xi \in \mathbb{S}^{n-1}$. Furthermore,

$$\tilde{u}(0) = |\nabla \tilde{u}(0)| = 0, \quad [\nabla \tilde{u}]_{C^{1-\varepsilon}(\mathbb{R}^n)} \leq 1, \quad |\nabla \tilde{u}(\xi)| > \frac{\delta_o}{2}.$$

On the other hand, for any $R \geq 1$ we have

$$\|\tilde{f}_k\|_{L^\infty(B_R)} \leq \frac{\rho_k^\varepsilon}{k} \rightarrow 0, \quad \text{as } k \rightarrow \infty,$$

and that, from the uniform modulus of continuity of $a_{ij}^{(k)}$, $\tilde{a}_{ij}^{(k)}(x) \rightarrow \tilde{a}_{ij}$ locally uniformly in \mathbb{R}^n , where the limiting coefficients \tilde{a}_{ij} are constant. At this point, in the equation (2.43) the coefficients converge locally uniformly to constant coefficients, and the solutions \tilde{u}_k converge simply in C^1 . The

passage to the limit is now more involved than before: in order to do it, we need the notion of viscosity solutions (see Definition 1.20 and Section 4.3) and the fact that they are stable under uniform limits (see Proposition 4.20). In all, we can show that the limiting \tilde{u} satisfies

$$\sum_{i,j=1}^n \tilde{a}_{ij} \partial_{ij} \tilde{u} = 0 \quad \text{in } \mathbb{R}^n$$

(in the viscosity sense). Hence, the limiting solution \tilde{u} is harmonic (after changing variables) and we reach a contradiction as in the second proof of Proposition 2.26. \square

In order to prove the convergence of the sequence in the proof of Proposition 2.32 we will need the following lemma:

Lemma 2.33. *Let $u \in H^1(B_1)$ satisfy*

$$(2.44) \quad \operatorname{div}(A(x)\nabla u(x)) = f(x) \quad \text{in } B_1,$$

in the weak sense, for some $f \in L^2(B_1)$ and $A(x) = (a_{ij}(x))_{ij}$ uniformly elliptic with ellipticity constants λ and Λ (see (2.18)). Then

$$\|\nabla u\|_{L^2(B_{1/2})} \leq C(\|u\|_{L^2(B_1)} + \|f\|_{L^2(B_1)})$$

for some C depending only on λ , Λ , and n .

Proof. Let us prove the lemma in the case $A(x)$ is symmetric for all $x \in B_1$.

Let $\eta \in C_c^\infty(B_1)$ be arbitrary with $\eta \equiv 1$ in $B_{1/2}$, and observe that

$$\int_{B_{1/2}} |\nabla u|^2 \leq C \int_{B_1} \nabla(u\eta) \cdot A(x)\nabla(u\eta) dx$$

by ellipticity. In particular, since $A(x)$ is symmetric for all $x \in B_1$ we can use that $\nabla(u\eta) \cdot A\nabla(u\eta) = u^2 \nabla\eta \cdot A\nabla\eta + \nabla(u\eta^2) \cdot A\nabla u$ and the equation (2.44) to get

$$\int_{B_{1/2}} |\nabla u|^2 \leq C \int_{B_1} u^2 |\nabla\eta|^2 + C \int_{B_1} |f u| \eta^2.$$

By Hölder's inequality, we get the desired estimate. We refer to the proof of Lemma 3.8 for more details on the proof and on the non-symmetric case in a very similar situation. \square

Let us now give the proof of Proposition 2.32.

Proof of Proposition 2.32. The proof is by contradiction and proceeds as the proof of Theorem 2.28, with the analogous modifications introduced in the Sketch of the proof of Proposition 2.31 with respect to the proof of Proposition 2.26.

Observe that, in this case, we should define $\tilde{u}_k(x)$ as first order incremental quotients:

$$\tilde{u}_k(x) = \frac{u_k(x_k + \rho_k x) - u_k(x_k)}{\rho_k^{1-\varepsilon} [u_k]_{C^{1-\varepsilon}(B_1)}}$$

so that we directly have (differently from the proof of Theorem 2.28) that \tilde{u}_k satisfies:

$$(2.45) \quad \operatorname{div}(\tilde{A}_k(x) \nabla \tilde{u}_k(x)) = \tilde{f}_k(x) \quad \text{in } B_{1/(2\rho_k)}, \quad \tilde{f}_k(x) = \frac{\rho_k^{1+\varepsilon} f_k(x_k + \rho_k x)}{[u_k]_{C^{1-\varepsilon}(B_1)}},$$

in the weak sense, where $\tilde{A}_k(x) := A_k(x_k + \rho_k x)$ and $\|\tilde{f}_k\|_{L^n(B_{1/(2\rho_k)})} \downarrow 0$ as $k \rightarrow \infty$. In particular, $\tilde{A}_k(x)$ converges to some constant matrix \tilde{A}_∞ locally uniformly by uniform continuity of A_k .

On the other hand, observe that each \tilde{u}_k is in H^1 (since they are C^1 by assumption), and they are locally uniformly in L^2 (since they are uniformly locally bounded). Hence, we can apply Lemma 2.33 to get that \tilde{u}_k are locally uniformly bounded in H^1 . In particular, by **(S4)** from Chapter 1 (see (1.3)) $\nabla \tilde{u}_k$ converges weakly to $\nabla \tilde{u}_\infty$. Thus:

$$\int_{\mathbb{R}^n} \nabla \phi \cdot \tilde{A}_k \nabla \tilde{u}_k \rightarrow \int_{\mathbb{R}^n} \nabla \phi \cdot \tilde{A}_\infty \nabla \tilde{u}_\infty \quad \text{as } k \rightarrow \infty, \quad \text{for all } \phi \in C_c^\infty(\mathbb{R}^n),$$

and from (2.45) we have that u_∞ is harmonic (after changing variables) in \mathbb{R}^n . The contradiction is now reached, again, by the Liouville theorem, Proposition 1.19. \square

Remark 2.34. The blow-up technique is a common tool in analysis that has great versatility. In particular, the technique presented in this section is due to L. Simon, [Sim97], and can be applied in a similar fashion to many different situations. We have seen the technique applied in interior a priori estimates for linear second-order equations, both in divergence and non-divergence form, and blow-up arguments like the one presented above can be adapted also to boundary estimates, parabolic equations, nonlinear equations, and even integro-differential equations.

2.6. Boundary regularity

We finish the chapter by stating the corresponding results to Corollaries 2.16 and 2.17 for the global (up to the boundary) estimates, for a sufficiently smooth domain.

For the sake of readability we state the result for the Laplacian, but there exists an analogous result for uniformly elliptic equations in non-divergence form (with the corresponding regularity on the coefficients).

Theorem 2.35 (Boundary regularity). *Let $\alpha \in (0, 1)$ and $k \in \mathbb{N}$ with $k \geq 2$, and let Ω be a bounded $C^{k,\alpha}$ domain of \mathbb{R}^n . Let $u \in H^1(\Omega)$ be a weak solution to*

$$(2.46) \quad \begin{cases} \Delta u = f & \text{in } \Omega \\ u = g & \text{on } \partial\Omega, \end{cases}$$

for some $f \in C^{k-2,\alpha}(\overline{\Omega})$, $g \in C^{k,\alpha}(\partial\Omega)$.

Then, $u \in C^{k,\alpha}(\overline{\Omega})$ and

$$\|u\|_{C^{k,\alpha}(\overline{\Omega})} \leq C \left(\|f\|_{C^{k-2,\alpha}(\overline{\Omega})} + \|g\|_{C^{k,\alpha}(\partial\Omega)} \right),$$

for some constant C depending only on α , n , k , and Ω .

Remark 2.36. Notice that in this case we do not need a term $\|u\|_{L^\infty(\Omega)}$ on the right-hand side because, thanks to the maximum principle (Lemma 2.25),

$$\max_{\overline{\Omega}} u \leq C \left(\max_{\partial\Omega} g + \|f\|_{L^\infty(\Omega)} \right)$$

for some C depending only on Ω , λ , Λ , and M .

Theorem 2.35 can be proved using similar techniques (correspondingly adapted) to the ones in the previous sections: after a blow-up, points near the boundary behave like in a local problem in the half-space (that is, the blow-up flattens $\partial\Omega$), and we can reach a contradiction with Liouville's theorem in the half-space.

One might wonder what happens under lower regularity assumptions on the domain (we refer to [Ken94, Kry96] for further reading in this direction). In such case, similar regularity results hold in $C^{1,\alpha}$ (and even C^1) domains, but when Ω is merely Lipschitz, almost all regularity is lost. Namely, assume that u solves (2.46), with f and g smooth enough. Then,

- If Ω is a $C^{1,\alpha}$ domain, then solutions are $C^{1,\alpha}(\overline{\Omega})$.
- If Ω is a C^1 domain, then solutions are $C^{1-\varepsilon}(\overline{\Omega})$ for all $\varepsilon > 0$, but not $C^{0,1}(\overline{\Omega})$ in general.
- If Ω is a Lipschitz domain, then solutions are $C^\gamma(\overline{\Omega})$ for some small $\gamma > 0$ that depends on the Lipschitz norm of the domain, and this is optimal.

We see that, if Ω is a Lipschitz domain, then essentially all regularity is lost. If one thinks on the blow-up and compactness method, it is clear that Lipschitz domains are quite different from C^1 . Indeed, Lipschitz domains do *not* get flatter by doing a blow-up (they remain Lipschitz, with the same Lipschitz norm). Thus, one cannot improve regularity by blowing up. Solutions turn out to be C^γ for some small $\gamma > 0$ and, in general, not better.

— DRAFT —

Nonlinear variational PDE & Hilbert's XIXth problem

Eine der begrifflich merkwürdigsten Thatsachen in den Elementen der Theorie der analytischen Functionen erblicke ich darin, daß es partielle Differentialgleichungen giebt, deren Integrale sämtlich notwendig analytische Functionen der unabhängigen Variablen sind, die also, kurz gesagt, nur analytischer Lösungen fähig sind.

— David Hilbert (1900).

Up until this point, we have studied linear elliptic PDEs. In this chapter we start the study of *nonlinear* elliptic PDEs.

More precisely, we study *variational* nonlinear PDEs, that is, those that appear in the Calculus of Variations (minimizing an energy functional). In particular, our main goal is to introduce and solve Hilbert's XIXth problem¹.

• **Hilbert's XIXth problem (1900):** Consider any local minimizer of energy functionals of the form

$$\mathcal{E}(w) := \int_{\Omega} L(\nabla w) dx,$$

where $L : \mathbb{R}^n \rightarrow \mathbb{R}$ is smooth and uniformly convex, and $\Omega \subset \mathbb{R}^n$. Is it true that all local minimizers to this type of problems are smooth?

¹The original statement by Hilbert says that “*there exist partial differential equations whose integrals are all of necessity analytic functions of the independent variables, that is, in short, equations susceptible of none but analytic solutions*”, and refers to solutions to what he calls “regular variational problems”, involving convex (in ∇w) and analytic operators of the form $L(\nabla w, w, x)$. We deal here with $L(\nabla w)$ for simplicity.

Notice that, given a boundary condition

$$u = g \quad \text{on} \quad \partial\Omega,$$

one can show that there is a unique minimizer to this problem, $u \in H^1(\Omega)$, with $u|_{\partial\Omega} = g$. That is, there exists a unique $u \in H^1(\Omega)$ such that u minimizes the functional $\mathcal{E}(w) := \int_{\Omega} L(\nabla w) dx$, among all functions $w \in H^1(\Omega)$ such that $w|_{\partial\Omega} = g$. We will be more precise about this in the first two sections of this chapter.

The question in Hilbert's XIXth problem is that of *regularity*: Is such minimizer u smooth?

Remark 3.1 (On the convexity assumption). The uniform convexity of the function is what gives us existence and uniqueness of a minimizer (see Theorem 3.3 below). Moreover, from the point of view of regularity, if L is not convex and reaches its minimum at two different points, then even in dimension $n = 1$ there exist counterexamples to regularity.

If $n = 1$ and L has a minimum at two points $p_1 < p_2$, then we can construct Lipschitz only minimizers zigzagging with slopes p_1 and p_2 (e.g., if $p_1 = -1$ and $p_2 = 1$, then $u(x) = |x|$ would be a minimizer).

Thus, the convexity assumption is needed.

3.1. Overview

Hilbert's XIXth problem as posed above is a generalization of the minimization of the Dirichlet integral,

$$\int_{\Omega} |\nabla w|^2 dx.$$

Local minimizers of the Dirichlet integral verify the corresponding Euler-Lagrange equation, which in this case is the Laplace equation

$$\Delta w = 0 \quad \text{in} \quad \Omega.$$

Solutions to this PDE, as seen in Chapter 2, are known to be C^∞ in the interior of Ω .

Thus, the Dirichlet integral case $L(p) = |p|^2$ is extremely simple. Surprisingly, the general case is far more difficult, and its resolution took more than 50 years.

First, let us be more precise about the problem: by a *local minimizer* of $\mathcal{E}(w) = \int_{\Omega} L(\nabla w) dx$, we mean a function $u \in H^1(\Omega)$ such that

$$\mathcal{E}(u) \leq \mathcal{E}(u + \phi) \quad \text{for all} \quad \phi \in C_c^\infty(\Omega).$$

The *uniform convexity* of the functional is equivalent to

$$(3.1) \quad 0 < \lambda \text{Id} \leq D^2 L(p) \leq \Lambda \text{Id} \quad \text{for all} \quad p \in \mathbb{R}^n,$$

(i.e., uniform convexity of L). Notice the analogy with the uniform ellipticity from the previous chapter.

Now, what is the PDE satisfied by minimizers of $\mathcal{E}(u)$? (Namely, the Euler–Lagrange equation of the problem.) If $u \in H^1(\Omega)$ is a local minimizer, then

$$\mathcal{E}(u) \leq \mathcal{E}(u + \varepsilon\phi) \quad \text{for all } \phi \in C_c^\infty(\Omega), \quad \text{and all } \varepsilon \in \mathbb{R}.$$

Hence,

$$\int_{\Omega} L(\nabla u) \, dx \leq \int_{\Omega} L(\nabla u + \varepsilon \nabla \phi) \, dx \quad \text{for all } \phi \in C_c^\infty(\Omega), \quad \text{and all } \varepsilon \in \mathbb{R},$$

and thus, as a function of ε , it has a minimum at $\varepsilon = 0$. Taking derivatives in ε we reach

$$0 = \left. \frac{d}{d\varepsilon} \right|_{\varepsilon=0} \int_{\Omega} L(\nabla u + \varepsilon \nabla \phi) \, dx = \int_{\Omega} DL(\nabla u) \nabla \phi \, dx.$$

The *weak formulation* of the Euler–Lagrange equation is then

$$(3.2) \quad \int_{\Omega} DL(\nabla u) \nabla \phi \, dx = 0 \quad \text{for all } \phi \in C_c^\infty(\Omega).$$

That is, u solves in the weak sense the PDE

$$(3.3) \quad \boxed{\operatorname{div}(DL(\nabla u)) = 0 \quad \text{in } \Omega.}$$

(This derivation will be properly justified in Theorem 3.3 below.)

If u is C^2 , (3.3) is equivalent to

$$(3.4) \quad \sum_{i,j=1}^n (\partial_{ij} L)(\nabla u) \partial_{ij} u = 0 \quad \text{in } \Omega.$$

By uniform convexity of L , this is a (nonlinear) *uniformly elliptic* PDE. What can we say about the regularity of u ?

Regularity of local minimizers: First approach. Let us assume that u is smooth enough so that it solves (3.4). We can regard (3.4) as a linear equation with variable coefficients, by denoting

$$a_{ij}(x) := (\partial_{ij} L)(\nabla u(x)),$$

and we notice that, by uniform convexity of L , we have

$$0 < \lambda \operatorname{Id} \leq (a_{ij}(x))_{ij} \leq \Lambda \operatorname{Id}.$$

Moreover, if $\nabla u \in C^{0,\alpha}$, then $a_{ij} \in C^{0,\alpha}$. In particular, using Schauder estimates (see Theorem 2.20), we have

$$(3.5) \quad u \in C^{1,\alpha} \Rightarrow a_{ij} \in C^{0,\alpha} \Rightarrow u \in C^{2,\alpha}.$$

We can then bootstrap the regularity and get C^∞ :

$$u \in C^{2,\alpha} \Rightarrow \nabla u \in C^{1,\alpha} \Rightarrow a_{ij} \in C^{1,\alpha} \Rightarrow u \in C^{3,\alpha} \Rightarrow \dots \Rightarrow u \in C^\infty.$$

In fact, using the linear estimates for continuous coefficients, one can actually get $u \in C^1 \Rightarrow a_{ij} \in C^0 \Rightarrow u \in C^{1,\alpha}$. We remark that while the previous implications are true at a formal level, we did not properly argue the use of Schauder estimates. Indeed, our results for Schauder estimates in both non-divergence form (Theorem 2.20) and divergence form (Theorem 2.28) are *a priori*, i.e., they already assume regularity on u . We show how to use them in Theorem 3.5 below to prove the results we want and expect.

Equations with bounded measurable coefficients. We have argued that using perturbative results for linear equations (Schauder estimates), one expects to prove that

$$u \in C^1 \implies u \in C^\infty.$$

However, this approach does not allow us to prove any regularity if we do not know *a priori* that $u \in C^1$. The main open question in Hilbert's XIXth problem was then

$$\text{is it true that } u \in H^1 \Rightarrow u \in C^1 ?$$

This problem was open for many years, and it was finally solved (independently and almost at the same time) by De Giorgi [DeG57] and Nash [Nas57, Nas58].

Theorem 3.2 (De Giorgi–Nash). *Let u be a local minimizer of*

$$\mathcal{E}(w) = \int_{\Omega} L(\nabla w) dx,$$

with L uniformly convex and smooth. Then, $u \in C^{1,\alpha}$ for some $\alpha > 0$.

This theorem solved Hilbert's XIXth problem.

In order to show regularity of local minimizers u of $\mathcal{E}(w) = \int_{\Omega} L(\nabla w) dx$, with $w \in H^1(\Omega)$, we first notice that they solve (in the weak sense) the nonlinear elliptic equation

$$\operatorname{div}(DL(\nabla u)) = 0 \quad \text{in } \Omega.$$

The first idea in the proof is to consider derivatives of u , $v = \partial_e u$, and to show that they solve an elliptic PDE as well.

If we differentiate the equation $\operatorname{div}(DL(\nabla u)) = 0$ with respect to $e \in \mathbb{S}^{n-1}$, we get

$$\operatorname{div}(D^2L(\nabla u)\nabla\partial_e u) = 0 \quad \text{in } \Omega.$$

Denoting (as before) $v := \partial_e u$, $a_{ij}(x) := \partial_{ij} L(\nabla u(x))$ and $A(x) := (a_{ij}(x))_{ij}$, we can write this equation as

$$\operatorname{div}(A(x)\nabla v) = 0 \quad \text{in } \Omega.$$

This is a linear, uniformly elliptic equation in divergence form, but we do not have *any* regularity of $A(x)$ in the x -variable. We only know that the equation is uniformly elliptic.

This is called a (uniformly elliptic) equation in divergence form with *bounded measurable coefficients*. (Recall that the uniform convexity of L yields $0 < \lambda \operatorname{Id} \leq A(x) \leq \Lambda \operatorname{Id}$.)

De Giorgi and Nash established a new regularity result for such type of equations, see Theorem 3.7.

The aim of this Chapter is to provide a complete and detailed proof of the solution to Hilbert's XIXth problem. We will follow De Giorgi's approach.

3.2. Existence and basic estimates

We start by showing the existence and uniqueness of minimizers of \mathcal{E} among the class of $H^1(\Omega)$ functions with prescribed boundary data. That is, we want a statement analogous to Theorem 1.10, but with the functional involving L instead. We recall that we denote by $u|_{\partial\Omega}$ the trace of u on $\partial\Omega$; see **(S5)** in Chapter 1.

Theorem 3.3 (Existence and uniqueness of minimizers). *Assume that $\Omega \subset \mathbb{R}^n$ is any bounded Lipschitz domain, and that*

$$(3.6) \quad \{w \in H^1(\Omega) : w|_{\partial\Omega} = g\} \neq \emptyset.$$

Let $L : \mathbb{R}^n \rightarrow \mathbb{R}$ be smooth and uniformly convex, see (3.1). Let

$$\mathcal{E}(w) := \int_{\Omega} L(\nabla w) \, dx.$$

Then, there exists a unique minimizer $u \in H^1(\Omega)$ with $u|_{\partial\Omega} = g$. Moreover, u solves (3.3) in the weak sense.

In order to prove the existence and uniqueness theorem for minimizers, we need first to show the following result on the lower semi-continuity of the energy in this context. We provide two different proofs.

Lemma 3.4 (Lower semi-continuity of the functional). *Let $\Omega \subset \mathbb{R}^n$ be a bounded domain. Let $L : \mathbb{R}^n \rightarrow \mathbb{R}$ be smooth and uniformly convex, see (3.1); and let*

$$\mathcal{E}(w) := \int_{\Omega} L(\nabla w) \, dx.$$

Then, \mathcal{E} is weakly lower semi-continuous in $H^1(\Omega)$. That is, if $H^1(\Omega) \ni w_k \rightharpoonup w \in H^1(\Omega)$ weakly in $H^1(\Omega)$, then

$$\mathcal{E}(w) \leq \liminf_{k \rightarrow \infty} \mathcal{E}(w_k).$$

First proof. Let us define the set

$$\mathcal{A}(t) := \{v \in H^1(\Omega) : \mathcal{E}(v) \leq t\}.$$

Notice that, by convexity of \mathcal{E} , $\mathcal{A}(t)$ is convex as well. Let us show that it is closed, i.e., if $\mathcal{A}(t) \ni w_k \rightarrow w$ strongly in $H^1(\Omega)$, then $w \in \mathcal{A}(t)$. This simply follows by noticing that, up to a subsequence, $\nabla w_k \rightarrow \nabla w$ almost everywhere, so that, by Fatou's lemma,

$$\mathcal{E}(w) = \int_{\Omega} L(\nabla w) \leq \liminf_{k \rightarrow \infty} \int_{\Omega} L(\nabla w_k) \leq t,$$

that is, $w \in \mathcal{A}(t)$. Therefore, $\mathcal{A}(t)$ is closed (with respect to the $H^1(\Omega)$ convergence), and it is convex. By a standard result in functional analysis (closed and convex sets are weakly closed; see, for example, [Bre11, Theorem 3.7]), $\mathcal{A}(t)$ is also closed under weak convergence; namely, if $\mathcal{A}(t) \ni w_k \rightharpoonup w$ weakly in $H^1(\Omega)$ then $w \in \mathcal{A}(t)$.

Let us now consider a sequence weakly converging in $H^1(\Omega)$, $w_k \rightharpoonup w$, and let us denote $t^* := \liminf_{k \rightarrow \infty} \mathcal{E}(w_k)$. For any $\varepsilon > 0$, there exists some subsequence $k_{j,\varepsilon}$ such that $w_{k_{j,\varepsilon}} \rightharpoonup w$ weakly in $H^1(\Omega)$ and $\mathcal{E}(w_{k_{j,\varepsilon}}) \leq t^* + \varepsilon$. That is, $w_{k_{j,\varepsilon}} \in \mathcal{A}(t^* + \varepsilon)$, and therefore, since $\mathcal{A}(t)$ is weakly closed (in $H^1(\Omega)$) for all t , we have $w \in \mathcal{A}(t^* + \varepsilon)$ and $\mathcal{E}(w) \leq t^* + \varepsilon$. Since this can be done for any $\varepsilon > 0$, we reach that $\mathcal{E}(w) \leq t^*$, and therefore, we have shown the weak lower semi-continuity of \mathcal{E} in $H^1(\Omega)$. \square

Second proof. Let us prove the lower semi-continuity of the functional by means of a different proof, from [Mag11]. We will actually show that if $u_k, u \in W^{1,1}(\Omega)$ and $u_k \rightarrow u$ in $L^1_{\text{loc}}(\Omega)$, then

$$\int_{\Omega} L(\nabla u) \leq \liminf_{k \rightarrow \infty} \int_{\Omega} L(\nabla u_k).$$

In particular, since Ω is bounded, we can apply this result to the sequences in $H^1(\Omega)$ converging weakly in $H^1(\Omega)$ (by **(S2)** from Chapter 1). Let $\eta \in C_c^\infty(B_1)$ be a smooth function with $\eta \geq 0$ and $\int_{B_1} \eta = 1$, and let $\eta_\varepsilon(x) = \varepsilon^{-n} \eta(x/\varepsilon)$, so that we can consider the mollifications

$$(u_k)_\varepsilon(x) := (u_k * \eta_\varepsilon)(x) = \int_{B_\varepsilon} u(x-y) \eta_\varepsilon(y) dy, \quad u_\varepsilon(x) := (u * \eta_\varepsilon)(x).$$

Let $\Omega' \subset \Omega$ be such that for all $x \in \Omega'$, $B_\varepsilon(x) \subset \Omega$. In particular, since $u_k \rightarrow u$ in $L^1_{\text{loc}}(\Omega)$, we have $\nabla(u_k)_\varepsilon(x) \rightarrow \nabla u_\varepsilon(x)$ for every $x \in \Omega'$. From

the smoothness of L we also have that $L(\nabla(u_k)_\varepsilon(x)) \rightarrow L(\nabla u_\varepsilon(x))$ and by Fatou's lemma (recall that we may assume $L \geq 0$)

$$(3.7) \quad \int_{\Omega'} L(\nabla u_\varepsilon) \leq \liminf_{k \rightarrow \infty} \int_{\Omega'} L(\nabla(u_k)_\varepsilon).$$

Noticing now that $\nabla(u_k)_\varepsilon = (\nabla u_k)_\varepsilon$ and using Jensen's inequality (since L is convex and $\int \eta_\varepsilon = 1$) we have

$$L(\nabla(u_k)_\varepsilon) = L\left(\int_{B_\varepsilon(x)} \eta_\varepsilon(x-y) \nabla u_k(y) dy\right) \leq \int_{B_\varepsilon(x)} \eta_\varepsilon(x-y) L(\nabla u_k(y)) dy$$

which leads to

$$\begin{aligned} \int_{\Omega'} L(\nabla(u_k)_\varepsilon) &\leq \int_{\Omega'} \left\{ \int_{B_\varepsilon(x)} \eta_\varepsilon(x-y) L(\nabla u_k(y)) dy \right\} dx \\ &\leq \int_{I_\varepsilon(\Omega')} L(\nabla u_k(y)) \int_{B_\varepsilon(y) \cap \Omega'} \eta_\varepsilon(x-y) dx dy \leq \int_{\Omega} L(\nabla u_k), \end{aligned}$$

where $I_\varepsilon(\Omega') \subset \Omega$ denotes an ε -neighborhood of Ω' . Combined with (3.7), this yields

$$\int_{\Omega'} L(\nabla u_\varepsilon) \leq \liminf_{k \rightarrow \infty} \int_{\Omega} L(\nabla u_k).$$

Now, since $u \in W^{1,1}(\Omega)$, we have $\nabla u_\varepsilon \rightarrow \nabla u$ as $\varepsilon \downarrow 0$ almost everywhere in Ω' and so, again by Fatou's Lemma, we can let $\varepsilon \downarrow 0$ to deduce

$$\int_{\Omega'} L(\nabla u) \leq \liminf_{k \rightarrow \infty} \int_{\Omega} L(\nabla u_k).$$

By taking an increasing sequence of sets Ω' whose union is Ω we reach the desired result. \square

We can now prove Theorem 3.3.

Proof of Theorem 3.3. We divide the proof into three different parts.

Step 1. If u is a local minimizer, then it solves (3.3) in the weak sense. This follows from the fact that

$$\int_{\Omega} L(\nabla u) dx \leq \int_{\Omega} L(\nabla u + \varepsilon \nabla \phi) dx \quad \text{for all } \varepsilon, \quad \text{for all } \phi \in C_c^\infty(\Omega).$$

Indeed, notice that the integrals are bounded (L being uniformly convex, i.e., at most quadratic at infinity, and $\nabla u \in L^2$). Since L is smooth, we can take a Taylor expansion

$$L(\nabla u + \varepsilon \nabla \phi) \leq L(\nabla u) + \varepsilon DL(\nabla u) \nabla \phi + \frac{\varepsilon^2}{2} |\nabla \phi|^2 \sup_{p \in \mathbb{R}^n} |D^2 L(p)|.$$

Recalling from (3.1) that $|D^2L|$ is bounded by Λ , and plugging it back into the integral we obtain

$$-\Lambda \frac{\varepsilon}{2} |\nabla \phi|^2 \leq \int_{\Omega} DL(\nabla u) \nabla \phi \, dx \quad \text{for all } \varepsilon > 0, \quad \text{for all } \phi \in C_c^\infty(\Omega).$$

Letting ε go to zero, we reach that

$$\int_{\Omega} DL(\nabla u) \nabla \phi \, dx \geq 0 \quad \text{for all } \phi \in C_c^\infty(\Omega).$$

On the other hand, taking $-\phi$ instead of ϕ , we reach the equality (3.2), as we wanted to see.

Step 2. Let us now show the existence of a solution.

Since L is uniformly convex (see (3.1)) it has a unique minimum. That is, there exists $p_L \in \mathbb{R}^n$ such that $L(p) \geq L(p_L)$ for all $p \in \mathbb{R}^n$. In particular, since L is smooth, $\nabla L(p_L) = 0$ and thus, from the uniform convexity (3.1) we have that

$$0 < \lambda |p|^2 \leq L(p - p_L) - L(p_L) \leq \Lambda |p|^2, \quad \text{for all } p \in \mathbb{R}^n.$$

Without loss of generality, by taking $\tilde{L}(p) = L(p - p_L) - L(p_L)$ if necessary, we may assume that $L(0) = 0$ and $\nabla L(0) = 0$, so that we have

$$(3.8) \quad 0 < \lambda |p|^2 \leq L(p) \leq \Lambda |p|^2, \quad \text{for all } p \in \mathbb{R}^n.$$

(Notice that we may assume that because if u is a minimizer for L , then $u + \langle p_L, x \rangle$ is a minimizer for \tilde{L} , since the domain is bounded and therefore the integral of $L(p_L)$ is finite.)

Let

$$\mathcal{E}_\circ = \inf \left\{ \int_{\Omega} L(\nabla w) \, dx : w \in H^1(\Omega), w|_{\partial\Omega} = g \right\},$$

that is, the infimum value of $\mathcal{E}(w)$ among all admissible functions w . Notice that, by assumption (3.6), such infimum exists. Indeed, if $w \in H^1(\Omega)$, by (3.8) we have that

$$\mathcal{E}(w) = \int_{\Omega} L(\nabla w) \leq \Lambda \int_{\Omega} |\nabla w|^2 = \Lambda \|\nabla w\|_{L^2(\Omega)}^2 < \infty$$

that is, the energy functional is bounded for functions in $H^1(\Omega)$.

Let us take a minimizing sequence of functions. That is, we take $\{u_k\}$ such that $u_k \in H^1(\Omega)$, $u_k|_{\partial\Omega} = g$, and $\mathcal{E}(u_k) \rightarrow \mathcal{E}_\circ$ as $k \rightarrow \infty$. We begin by showing that $\mathcal{E}(u_k)$ are bounded, and that u_k is a sequence bounded in $H^1(\Omega)$. By (3.8),

$$\lambda \|\nabla u_k\|_{L^2(\Omega)}^2 \leq \lambda \int_{\Omega} |\nabla u_k|^2 \leq \int_{\Omega} L(\nabla u_k) \leq \mathcal{E}(u_k) < \infty,$$

That is, since $\mathcal{E}(u_k)$ is uniformly bounded (being a convergent sequence with non-infinite elements), we reach that $\|\nabla u_k\|_{L^2(\Omega)}^2$ is uniformly bounded. Thus, by the Poincaré inequality (see Theorem 1.6) the sequence u_k is uniformly bounded in $H^1(\Omega)$.

In particular, there exists a subsequence u_{k_j} converging strongly in $L^2(\Omega)$ and weakly in $H^1(\Omega)$ to some $u \in H^1(\Omega)$, $u_k \rightharpoonup u$ weakly in $H^1(\Omega)$. By the weak lower semi-continuity (Lemma 3.4) we reach that

$$\mathcal{E}(u) \leq \liminf_{k \rightarrow \infty} \mathcal{E}(u_k) = \mathcal{E}_\circ,$$

so that $\mathcal{E}(u) = \mathcal{E}_\circ$ (by minimality) and therefore u is a minimizer.

Step 3. We finish the proof by showing the uniqueness of such minimizer.

This follows from the uniform convexity. Indeed, since L is uniformly convex, if $p \neq q$, then

$$\frac{L(p) + L(q)}{2} > L\left(\frac{p+q}{2}\right).$$

Let $u, v \in H^1(\Omega)$ be two distinct minimizers with the same boundary data ($\mathcal{E}(u) = \mathcal{E}(v) = \mathcal{E}_\circ$). In particular, $\nabla u \neq \nabla v$ in Ω , so that $U := \{x \in \Omega : \nabla u \neq \nabla v\} \subset \Omega$ has positive measure. Thus,

$$\frac{L(\nabla u) + L(\nabla v)}{2} > L\left(\frac{\nabla u + \nabla v}{2}\right) \quad \text{in } U,$$

so that, since $|U| > 0$,

$$\frac{1}{2} \int_U \{L(\nabla u) + L(\nabla v)\} > \int_U L\left(\frac{\nabla u + \nabla v}{2}\right).$$

Since the integrals are equal in $\Omega \setminus U$, we reach

$$\mathcal{E}_\circ = \frac{1}{2} \int_\Omega \{L(\nabla u) + L(\nabla v)\} > \int_\Omega L\left(\frac{\nabla u + \nabla v}{2}\right) \geq \mathcal{E}_\circ,$$

where the last inequality comes from the minimality of \mathcal{E}_\circ . We have reached a contradiction, and thus, the minimizer is unique. \square

We next give a complete and rigorous proof of the formal argumentation from the previous section, where we explained that C^1 solutions are C^∞ .

Theorem 3.5. *Let $u \in H^1(\Omega)$ be a local minimizer of*

$$\mathcal{E}(w) = \int_\Omega L(\nabla w) dx,$$

with L uniformly convex and smooth. Assume that $u \in C^1$. Then $u \in C^\infty$.

Proof. We know that if $u \in C^1$ and u is a minimizer of $\mathcal{E}(w)$, then

$$\int_{\Omega} DL(\nabla u(x)) \nabla \phi(x) dx = 0 \quad \text{for all } \phi \in C_c^\infty(\Omega).$$

Let $h \in \mathbb{R}^n$, and assume that $|h|$ is small. We have, in particular, that

$$\int_{\Omega} \left(DL(\nabla u(x+h)) - DL(\nabla u(x)) \right) \nabla \phi(x) dx = 0 \quad \text{for all } \phi \in C_c^\infty(\Omega_h),$$

where $\Omega_h := \{x \in \Omega : \text{dist}(x, \partial\Omega) > |h|\}$. Notice that, by the fundamental theorem of calculus for line integrals, we can write

$$\begin{aligned} DL(\nabla u(x+h)) - DL(\nabla u(x)) &= \\ &= \int_0^1 D^2L \left(t\nabla u(x+h) + (1-t)\nabla u(x) \right) \left(\nabla u(x+h) - \nabla u(x) \right) dt. \end{aligned}$$

If we define

$$\tilde{A}(x) := \int_0^1 D^2L \left(t\nabla u(x+h) + (1-t)\nabla u(x) \right) dt,$$

then $\tilde{A}(x)$ is uniformly elliptic (since L is uniformly convex), and continuous (since L is smooth and ∇u is continuous). Then, by the previous argumentation,

$$\int_{\Omega} \nabla \left(\frac{u(x+h) - u(x)}{|h|} \right) \cdot \tilde{A}(x) \nabla \phi(x) dx = 0 \quad \text{for all } \phi \in C_c^\infty(\Omega_h),$$

that is, $\frac{u(\cdot+h)-u}{|h|}$ solves weakly

$$\text{div} \left(\tilde{A}(x) \nabla \left[\frac{u(x+h) - u(x)}{|h|} \right] \right) = 0 \quad \text{for } x \in \Omega_h.$$

Moreover, notice that $\frac{u(\cdot+h)-u}{|h|}$ is C^1 for all $h \neq 0$, since u is C^1 . Thus, by the Schauder-type estimates for operators in divergence form and continuous coefficients (Proposition 2.32),

$$\left\| \frac{u(\cdot+h) - u}{|h|} \right\|_{C^\beta(B_{\rho/2}(x_o))} \leq C(\rho) \left\| \frac{u(\cdot+h) - u}{|h|} \right\|_{L^\infty(B_\rho(x_o))} \leq C,$$

for all $B_\rho(x_o) \subset \Omega_h$ and $\beta \in (0, 1)$. In the last inequality we used that ∇u is continuous (and thus, bounded). Notice that the constant $C(\rho)$ is independent of h (but might depend on β). In particular, from **(H7)** in Chapter 1, namely (1.7) with $\alpha = 1$, we obtain that $u \in C^{1,\beta}(\overline{\Omega_h})$ for all $h \in \mathbb{R}^n$. Letting $|h| \downarrow 0$ we get that $u \in C^{1,\beta}$ inside Ω .

We want to repeat the previous reasoning, noticing now that $\tilde{A}(x)$ is $C^{0,\beta}$ (since $\nabla u \in C^{0,\beta}$ and L is smooth). That is, $\frac{u(\cdot+h)-u}{|h|} \in C^{1,\beta}(\Omega)$ and

fulfills

$$\operatorname{div} \left(\tilde{A}(x) \nabla \left[\frac{u(x+h) - u(x)}{|h|} \right] \right) = 0 \quad \text{for } x \in \Omega_h,$$

in the weak sense, with $\tilde{A} \in C^\beta$ and uniformly elliptic. By Theorem 2.28,

$$\left\| \frac{u(\cdot+h) - u}{|h|} \right\|_{C^{1,\beta}(B_{\rho/2})} \leq C(\rho) \left\| \frac{u(\cdot+h) - u}{|h|} \right\|_{L^\infty(B_\rho)} \leq C,$$

for all $B_\rho \subset \Omega_h$, and again, thanks to **(H7)**, (1.7), we obtain that $u \in C^{2,\beta}(\Omega)$. We can now proceed iteratively using the higher order interior Schauder estimates in divergence form (Corollary 2.29) to obtain that $u \in C^k(\Omega)$ for all $k \in \mathbb{N}$, i.e. $u \in C^\infty$ inside Ω . \square

Remark 3.6. Notice that in the formal proof (3.5) we were using Schauder estimates in non-divergence form, since we were already assuming that the solution u was C^2 . Here, in the proof of Theorem 3.5, we need to *differentiate* the equation (in incremental quotients) and then we obtain an equation in divergence form whose coefficients have the right regularity. Thus, in the actual proof we are using Schauder estimates for equations in divergence form instead.

3.3. De Giorgi's proof

The result of De Giorgi and Nash regarding the regularity of solutions to equations with bounded measurable coefficients is the following (see the discussion in Section 3.1).

Theorem 3.7 (De Giorgi–Nash). *Let $v \in H^1(\Omega)$ be any weak solution to*

$$(3.9) \quad \operatorname{div}(A(x)\nabla v) = 0 \quad \text{in } \Omega,$$

with $0 < \lambda \operatorname{Id} \leq A(x) \leq \Lambda \operatorname{Id}$. Then, there exists some $\alpha > 0$ such that $v \in C^{0,\alpha}(\tilde{\Omega})$ for any $\tilde{\Omega} \subset\subset \Omega$, with

$$\|v\|_{C^{0,\alpha}(\tilde{\Omega})} \leq C \|v\|_{L^2(\Omega)}.$$

The constant C depends only on n , λ , Λ , Ω , and $\tilde{\Omega}$. The constant $\alpha > 0$ depends only on n , λ , and Λ .

This theorem yields Theorem 3.2, and combined with previous discussions, solved Hilbert's XIXth problem. Indeed, if $u \in H^1(\Omega)$ is any local minimizer of $\mathcal{E}(w) = \int_\Omega L(\nabla w) dx$, then any derivative of u , $v = \partial_e u$, solves (3.9).

Thanks to Theorem 3.7 we will have

$$u \in H^1(\Omega) \Rightarrow v \in L^2(\Omega) \xrightarrow[\text{DeGiorgi-Nash}]{\text{}} v \in C^{0,\alpha}(\tilde{\Omega}) \Rightarrow u \in C^{1,\alpha} \xrightarrow[\text{Schauder}]{\text{}} u \in C^\infty.$$

This will be proved in detail in Section 3.4.

Theorem 3.7 is significantly different in spirit than all the results on elliptic regularity which existed before.

Most of the previous results can be seen as perturbation of the Laplace equation (they are perturbative results). In Schauder-type estimates, we always use that, when zooming in a solution at a point, the operator gets closer and closer to the Laplacian.

In De Giorgi's theorem, this is not true anymore. The uniform ellipticity is preserved by scaling, but the equation is not better, nor closer to the Laplace equation.

General ideas of the proof. We will follow the approach of De Giorgi.

From now on, we denote \mathcal{L} any operator of the form

$$(3.10) \quad \mathcal{L}v := -\operatorname{div}(A(x)\nabla v), \quad \begin{array}{l} \text{where } A(x) \text{ is uniformly elliptic} \\ \text{with ellipticity constants } 0 < \lambda \leq \Lambda. \end{array}$$

By a standard covering argument (cf. Remark 2.15), we only need to prove the estimate for $\Omega = B_1$ and $\tilde{\Omega} = B_{1/2}$.

Throughout the proof, we will use that, if v solves $\mathcal{L}v = 0$, then $\tilde{v}(x) := Cv(x_0 + rx)$ solves an equation of the same kind, $\tilde{\mathcal{L}}\tilde{v} = 0$, for some operator $\tilde{\mathcal{L}}$ with the same ellipticity constants as \mathcal{L} — given by $\tilde{\mathcal{L}}\tilde{v} = \operatorname{div}(A(x_0 + rx)\nabla\tilde{v})$.

De Giorgi's proof is split into two steps:

First step: Show that $\|v\|_{L^\infty} \leq C\|v\|_{L^2}$

Second step: Show that $\|v\|_{C^{0,\alpha}} \leq C\|v\|_{L^\infty}$.

In the first step, we work on the family of balls (see Figure 3.1)

$$\tilde{B}_k := \left\{ x : |x| \leq \frac{1}{2} + 2^{-k-1} \right\}.$$

Note that $\tilde{B}_0 = B_1$, and \tilde{B}_k converges to $B_{1/2}$ as $k \rightarrow \infty$.

We assume $\|v\|_{L^2(B_1)} \leq \delta \ll 1$ and then consider the truncated functions

$$v_k := (v - C_k)_+ \quad \text{with} \quad C_k := 1 - 2^{-k},$$

and the numbers

$$V_k \approx \int_{\tilde{B}_k} |v_k|^2 dx.$$

Then, the main point is to derive an estimate of the form

$$(3.11) \quad V_k \leq C^k V_{k-1}^\beta \quad \text{for some } \beta > 1,$$

for some constant C depending only on n , λ , and Λ . This previous inequality implies that $V_k \rightarrow 0$ as $k \rightarrow \infty$ if V_0 is small enough. In particular, $v_\infty = (v - 1)_+$ is equal to zero in $B_{1/2}$, and so $v \leq 1$ in $B_{1/2}$.

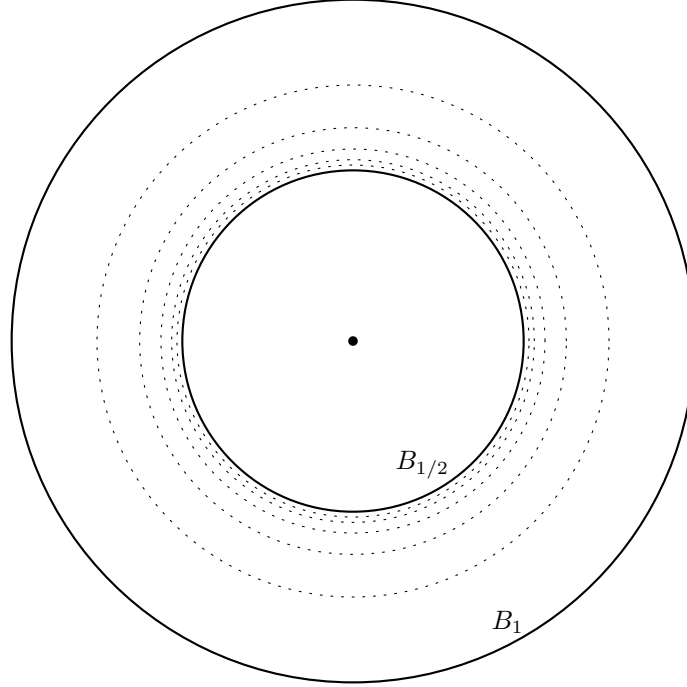

Figure 3.1. Representation of the family of balls \tilde{B}_k .

Notice that our equation $\mathcal{L}v = 0$ in B_1 is linear, while the bound (3.11) is nonlinear. The “game” consists in using the Sobolev inequality (which gives control of L^p norms of v_k in terms of L^2 norms of ∇v_k), combined with an energy inequality, which gives a “reversed” Poincaré inequality, i.e., a control of $\|\nabla v_k\|_{L^2}$ in terms of $\|v_k\|_{L^2}$.

Once we have the first step $v \in L^2 \Rightarrow v \in L^\infty$, the second step consists of showing an oscillation-decay lemma

$$\mathcal{L}v = 0 \quad \text{in } B_1 \quad \Longrightarrow \quad \text{osc}_{B_{1/2}} v \leq (1 - \theta) \text{osc}_{B_1} v.$$

This implies the $C^{0,\alpha}$ regularity of v (as we saw in Corollary 2.7).

In the next proofs we follow [CV10, Vas16].

De Giorgi's first step: from L^2 to L^∞ . The two main ingredients are the Sobolev inequality

$$\|v\|_{L^p(\mathbb{R}^n)} \leq C \|\nabla v\|_{L^2(\mathbb{R}^n)}, \quad p = \frac{2n}{n-2},$$

(see Theorem 1.4) and the following energy inequality (the Caccioppoli inequality):

Lemma 3.8 (Energy inequality). *Let $v \in H^1(B_1)$ with $v \geq 0$ such that $\mathcal{L}v \leq 0$ in B_1 , for some \mathcal{L} of the form (3.10). Then, for any $\varphi \in C_c^\infty(B_1)$ we have*

$$\int_{B_1} |\nabla(\varphi v)|^2 dx \leq C \|\nabla\varphi\|_{L^\infty(B_1)}^2 \int_{B_1 \cap \text{supp } \varphi} v^2 dx,$$

where C depends only on n , λ , and Λ .

Proof. Notice that the weak formulation of $-\text{div}(A(x)\nabla v) \leq 0$ in B_1 is

$$\int_{B_1} \nabla\eta \cdot A(x)\nabla v dx \leq 0 \quad \text{for all } \eta \in H_0^1(B_1), \eta \geq 0.$$

Take $\eta = \varphi^2 v$, to get

$$\int_{B_1} \nabla(\varphi^2 v) \cdot A(x)\nabla v dx \leq 0.$$

Now, we want to “bring one of the φ from the first gradient to the second gradient”. Indeed, using

$$\begin{aligned} \nabla(\varphi^2 v) &= \varphi \nabla(\varphi v) + (\varphi v) \nabla\varphi, \\ \nabla(\varphi v) &= \varphi \nabla v + v \nabla\varphi, \end{aligned}$$

we get

$$\begin{aligned} 0 &\geq \int_{B_1} \nabla(\varphi^2 v) \cdot A(x)\nabla v dx \\ &= \int_{B_1} \varphi \nabla(\varphi v) \cdot A(x)\nabla v dx + \int_{B_1} \varphi v \nabla\varphi \cdot A(x)\nabla v dx \\ &= \int_{B_1} \nabla(\varphi v) \cdot A(x)\nabla(\varphi v) dx - \int_{B_1} v \nabla(\varphi v) \cdot A(x)\nabla\varphi dx \\ &\quad + \int_{B_1} \varphi v \nabla\varphi \cdot A(x)\nabla v dx \\ &= \int_{B_1} \nabla(\varphi v) \cdot A(x)\nabla(\varphi v) dx - \int_{B_1} v \nabla(\varphi v) \cdot (A(x) - A^T(x))\nabla\varphi dx \\ &\quad - \int_{B_1} v^2 \nabla\varphi \cdot A(x)\nabla\varphi dx. \end{aligned}$$

Let us first bound the term involving $(A - A^T)$. By Hölder's inequality, using the uniform ellipticity of A and that $(A - A^T)^2 \leq 4\Lambda^2 \text{Id}$, we get

$$\begin{aligned} & \int_{B_1} v \nabla(\varphi v) \cdot (A(x) - A^T(x)) \nabla \varphi \, dx \\ & \leq \left(\int_{B_1} |v(A(x) - A^T(x)) \nabla \varphi|^2 \, dx \right)^{\frac{1}{2}} \left(\int_{B_1} |\nabla(\varphi v)|^2 \, dx \right)^{\frac{1}{2}} \\ & \leq 2 \frac{\Lambda}{\lambda^{\frac{1}{2}}} \left(\int_{B_1} |v \nabla \varphi|^2 \, dx \right)^{\frac{1}{2}} \left(\int_{B_1} \nabla(\varphi v) A(x) \nabla(\varphi v) \, dx \right)^{\frac{1}{2}} \\ & \leq \frac{1}{2} \int_{B_1} \nabla(\varphi v) A(x) \nabla(\varphi v) \, dx + 2 \frac{\Lambda^2}{\lambda} \int_{B_1} |v \nabla \varphi|^2 \, dx, \end{aligned}$$

where in the last inequality we are using that $2ab \leq a^2 + b^2$. Combining the previous inequalities, we obtain that

$$2 \frac{\Lambda^2}{\lambda} \int_{B_1} |v \nabla \varphi|^2 \, dx \geq \frac{1}{2} \int_{B_1} \nabla(\varphi v) \cdot A(x) \nabla(\varphi v) \, dx - \int_{B_1} v^2 \nabla \varphi \cdot A(x) \nabla \varphi \, dx.$$

Therefore, we deduce

$$\begin{aligned} \lambda \int_{B_1} |\nabla(\varphi v)|^2 \, dx & \leq \int_{B_1} \nabla(\varphi v) \cdot A(x) \nabla(\varphi v) \, dx \\ & \leq 2 \int_{B_1} v^2 \nabla \varphi \cdot A(x) \nabla \varphi \, dx + 4 \frac{\Lambda^2}{\lambda} \int_{B_1} |v \nabla \varphi|^2 \, dx \\ & \leq \left(2\Lambda + 4 \frac{\Lambda^2}{\lambda} \right) \|\nabla \varphi\|_{L^\infty(B_1)}^2 \int_{B_1 \cap \text{supp } \varphi} v^2 \, dx, \end{aligned}$$

and the lemma is proved. \square

We will use the energy inequality (from the previous lemma) applied to the function

$$v_+ := \max\{v, 0\}.$$

Before doing so, let us show that if $\mathcal{L}v \leq 0$ (i.e., v is a subsolution), then $\mathcal{L}v_+ \leq 0$ (i.e., v_+ is a subsolution as well). (More generally, the maximum of two subsolutions is always a subsolution.)

Lemma 3.9. *Let \mathcal{L} be of the form (3.10), let $v \in H^1(B_1)$ be such that $\mathcal{L}v \leq 0$ in B_1 . Then, $\mathcal{L}v_+ \leq 0$.*

Proof. We proceed by approximation. Let $F \in C^\infty(\mathbb{R})$ be a smooth, non-decreasing, convex function, with globally bounded first derivatives. We start by showing that $\mathcal{L}(F(v)) \leq 0$ in B_1 .

Notice that if $v \in W^{1,2}(B_1)$, then $F(v) \in W^{1,2}(B_1)$ as well.

We know that $\mathcal{L}(v) \leq 0$, i.e.,

$$\int_{B_1} \nabla \eta \cdot A \nabla v \, dx \leq 0 \quad \text{for all } \eta \in H_0^1(B_1), \eta \geq 0.$$

Let us now compute, for any fixed $\eta \in H_0^1(\Omega)$ satisfying $\eta \geq 0$, $\mathcal{L}(F(v))$. Notice that the weak formulation still makes sense.

$$\begin{aligned} \int_{B_1} \nabla \eta \cdot A \nabla F(v) \, dx &= \int_{B_1} F'(v) \nabla \eta \cdot A \nabla v \, dx \\ &= \int_{B_1} \nabla(F'(v)\eta) \cdot A \nabla v \, dx - \int_{B_1} \eta F''(v) \nabla v \cdot A \nabla v \, dx. \end{aligned}$$

The first term is non-positive, since $F'(v)\eta \in H_0^1(B_1)$ and $F'(v) \geq 0$ (F is non-decreasing), so that $F'(v)\eta$ is an admissible test function. The second term is also non-positive, since $\eta F''(v) \geq 0$ and $\nabla v \cdot A \nabla v \geq 0$ by ellipticity (and the integral is well defined, since $\eta F''(v)$ can be assumed to be bounded by approximation, and $\int_{B_1} \nabla v \cdot A \nabla v \leq \Lambda \|\nabla v\|_{L^2(B_1)}^2$). Therefore,

$$\int_{B_1} \nabla \eta \cdot A \nabla F(v) \, dx \leq 0,$$

and the proof is complete. We finish by taking smooth approximations of the positive part function, F_ε , converging uniformly in compact sets to $F(x) = \max\{x, 0\}$. Notice that this can be done in such a way that $\|F_\varepsilon(v)\|_{W^{1,2}(B_1)} \leq C$, for some C independent of $\varepsilon > 0$, which gives the desired result. \square

We want to prove the following.

Proposition 3.10 (from L^2 to L^∞). *Let \mathcal{L} be of the form (3.10), and let $v \in H^1(B_1)$ be a solution to*

$$\mathcal{L}v \leq 0 \quad \text{in } B_1.$$

Then

$$\|v_+\|_{L^\infty(B_{1/2})} \leq C \|v_+\|_{L^2(B_1)},$$

for some constant C depending only on n , λ , and Λ .

We will prove, in fact, the following (which is actually equivalent):

Proposition 3.11 (from L^2 to L^∞). *Let \mathcal{L} be of the form (3.10). There exists a constant $\delta > 0$ depending only on n , λ , and Λ , such that if $v \in H^1(B_1)$ solves*

$$\mathcal{L}v \leq 0 \quad \text{in } B_1 \quad \text{and} \quad \int_{B_1} v_+^2 \leq \delta,$$

then

$$v \leq 1 \quad \text{in } B_{1/2}.$$

Proof. Define, as introduced in the general ideas of the proof, for $k \geq 0$,

$$\tilde{B}_k := \left\{ |x| \leq \frac{1}{2} + 2^{-k-1} \right\},$$

$$v_k := (v - C_k)_+ \quad \text{with} \quad C_k = 1 - 2^{-k},$$

and let φ_k be a family of shrinking cut-off functions $0 \leq \varphi_k \leq 1$ that fulfill

$$\varphi_k \in C_c^\infty(B_1), \quad \varphi_k = \begin{cases} 1 & \text{in } \tilde{B}_k \\ 0 & \text{in } \tilde{B}_{k-1}^c \end{cases}, \quad \text{and} \quad |\nabla \varphi_k| \leq C2^k \text{ in } \tilde{B}_{k-1} \setminus \tilde{B}_k,$$

where C here depends only on n .

Let

$$V_k := \int_{B_1} \varphi_k^2 v_k^2 dx.$$

Now, the Sobolev inequality, and the energy inequality (Lemma 3.8) give

$$\begin{aligned} \left(\int_{B_1} |\varphi_{k+1} v_{k+1}|^p dx \right)^{\frac{2}{p}} &\leq C \left(\int_{B_1} |\nabla(\varphi_{k+1} v_{k+1})|^2 dx \right) \\ &\leq C2^{2k} \int_{\tilde{B}_k} |v_{k+1}|^2 dx \\ &\leq C2^{2k} \int_{B_1} (\varphi_k v_k)^2 dx = C2^{2k} V_k, \end{aligned}$$

for $p = \frac{2n}{n-2}$ if $n \geq 3$. If $n = 1$ or $n = 2$, we can take $p = 4$.

On the other hand, by Hölder's inequality,

$$V_{k+1} = \int_{B_1} \varphi_{k+1}^2 v_{k+1}^2 dx \leq \left(\int_{B_1} (\varphi_{k+1} v_{k+1})^p dx \right)^{\frac{2}{p}} |\{\varphi_{k+1} v_{k+1} > 0\}|^\gamma,$$

where $\gamma := \frac{2}{n}$ (if $n = 1$ or $n = 2$, $\gamma = \frac{1}{2}$). Here, we are using that $\int_A f \leq (\int_A |f|^{p/2})^{2/p} |A|^\gamma$.

Now, from Chebyshev's inequality and the definition of v_k and φ_k ,

$$\begin{aligned} |\{\varphi_{k+1} v_{k+1} > 0\}| &\leq |\{\varphi_k v_k > 2^{-k-1}\}| \\ &= |\{\varphi_k^2 v_k^2 > 2^{-2k-2}\}| \\ &\leq 2^{2(k+1)} \int_{B_1} \varphi_k^2 v_k^2 dx = 2^{2(k+1)} V_k. \end{aligned}$$

Apart from Chebyshev's inequality, we are using here that if $v_{k+1} > 0$ and $\varphi_{k+1} > 0$, then $v_k > 2^{-k-1}$ and $\varphi_k = 1$. Thus, combining the previous

inequalities, we get

$$\begin{aligned} V_{k+1} &\leq \left(\int_{B_1} (\varphi_{k+1} v_{k+1})^p dx \right)^{\frac{2}{p}} |\{\varphi_{k+1} v_{k+1} > 0\}|^\gamma \\ &\leq C 2^{2k} V_k (2^{2(k+1)} V_k)^\gamma \leq C^{k+1} V_k^{1+\gamma}, \end{aligned}$$

where we recall $\gamma = \frac{2}{n}$ if $n \geq 3$, and $\gamma = \frac{1}{2}$ otherwise; and C depends only on n , λ , and Λ .

Now, we claim that, if $\delta > 0$ is small enough, then

$$\begin{cases} 0 \leq V_{k+1} \leq C^{k+1} V_k^{1+\gamma} \\ 0 \leq V_0 \leq \delta \end{cases} \implies V_k \rightarrow 0 \text{ as } k \rightarrow \infty.$$

Indeed, in order to see this it is enough to check by induction that if $V_0 \leq C^{-1/\gamma-1/\gamma^2}$ then

$$V_k^\gamma \leq \frac{C^{-k-1}}{(2C)^{\frac{1}{\gamma}}},$$

which is a simple computation. Alternatively, one could check by induction that $V_k \leq C^{(1+\gamma)^k} \left(\sum_{i=1}^k \frac{i}{(1+\gamma)^i} \right) V_0^{(1+\gamma)^k}$.

Hence, we have proved that

$$V_k = \int_{B_1} (\varphi_k v_k)^2 dx \rightarrow 0 \text{ as } k \rightarrow \infty.$$

Passing to the limit, we get

$$\int_{B_{1/2}} (v-1)_+^2 dx = 0,$$

and thus, $v \leq 1$ in $B_{1/2}$, as wanted. \square

Proof of Proposition 3.10. To deduce the Proposition 3.10 from Proposition 3.11, just use $\tilde{v} := \sqrt{\delta} v / \|v_+\|_{L^2(B_1)}$ (which solves the same equation). \square

This proves the first part of the estimate

$$(3.12) \quad \mathcal{L}v \leq 0 \text{ in } B_1 \implies \|v_+\|_{L^\infty(B_{1/2})} \leq C \|v_+\|_{L^2(B_1)}.$$

Notice that, as a direct consequence, we have the L^2 to L^∞ estimate. Indeed, if $\mathcal{L}v = 0$ then $\mathcal{L}v_+ \leq 0$ (see Lemma 3.9) but also $\mathcal{L}v_- \leq 0$, where $v_- := \max\{0, -v\}$. Thus, $\|v_-\|_{L^\infty(B_{1/2})} \leq C \|v_-\|_{L^2(B_1)}$, and since $\|v\|_{L^2(B_1)} = \|v_+\|_{L^2(B_1)} + \|v_-\|_{L^2(B_1)}$, combining the estimate for v_+ and v_- we get

$$(3.13) \quad \mathcal{L}v = 0 \text{ in } B_1 \implies \|v\|_{L^\infty(B_{1/2})} \leq C \|v\|_{L^2(B_1)},$$

as we wanted to see.

Remark 3.12 (Moser's proof). The proof of (3.12) here presented is the original proof of De Giorgi. The first ingredient in the proof was to use $\varphi^2 v_+$ as a test function in the weak formulation of our PDE to get the energy inequality from Lemma 3.8,

$$\int_{B_1} |\nabla(\varphi v)|^2 dx \leq C \int_{B_1} v^2 |\nabla\varphi|^2 dx \quad \text{for all } \varphi \in C_c^\infty(B_1).$$

Roughly speaking, this inequality said that v cannot jump too quickly (the gradient is controlled by v itself).

Moser did something similar, but taking $\eta = \varphi^2 (v_+)^{\beta}$ instead, for some $\beta \geq 1$, to get the inequality

$$\int_{B_1} \left| \nabla \left(v^{\frac{\beta+1}{2}} \varphi \right) \right|^2 dx \leq C \int_{B_1} v^{\beta+1} |\nabla\varphi|^2 dx \quad \text{for all } \varphi \in C_c^\infty(B_1).$$

Combining this with Sobolev's inequality, one gets

$$\left(\int_{B_{r_1}} v^{q\gamma} dx \right)^{\frac{1}{q\gamma}} \leq \left(\frac{C}{|r_2 - r_1|^2} \int_{B_{r_2}} v^q dx \right)^{\frac{1}{q}},$$

where $\gamma = \frac{2^*}{2} > 1$ and $q = \beta + 1$. Taking a sequence of $r_k \downarrow \frac{1}{2}$ as in De Giorgi's proof, one obtains

$$\|v\|_{L^{2\gamma k}(B_{r_k})} \leq C \|v\|_{L^2(B_1)},$$

and taking $k \rightarrow \infty$ we obtain the L^∞ bound in $B_{1/2}$.

We refer the interested reader to [HL97, Chapter 4] for a full proof.

De Giorgi's second step: L^∞ to $C^{0,\alpha}$. We next prove the second step of De Giorgi's estimate. We want to prove:

Proposition 3.13 (Oscillation decay). *Let \mathcal{L} be of the form (3.10). Let $v \in H^1(B_2)$ be a solution to*

$$\mathcal{L}v = 0 \quad \text{in } B_2.$$

Then,

$$\text{osc}_{B_{1/2}} v \leq (1 - \theta) \text{osc}_{B_2} v$$

for some $\theta > 0$ small depending only on n , λ , and Λ .

As we saw in Chapter 2 (see Corollary 2.7), this proposition immediately implies $C^{0,\alpha}$ regularity of solutions.

As shown next, Proposition 3.13 follows from the following lemma.

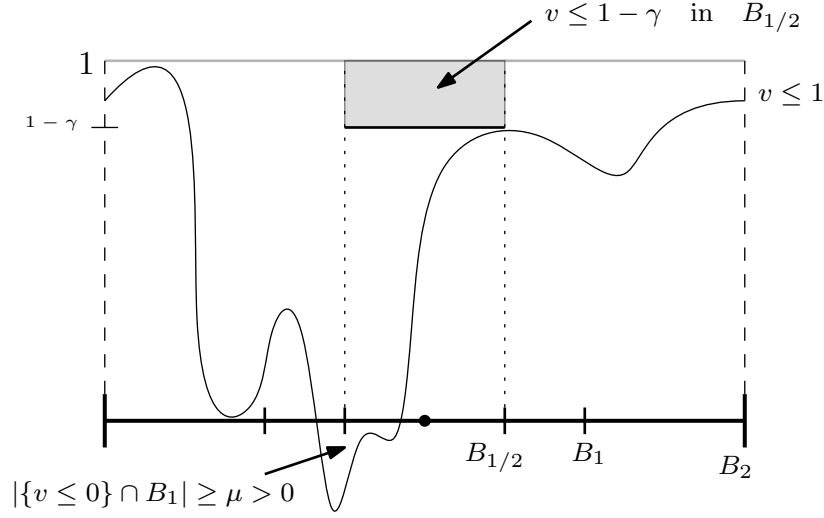

Figure 3.2. Graphical representation of v with $\mathcal{L}v \leq 0$ from Lemma 3.14.

Lemma 3.14. *Let \mathcal{L} be of the form (3.10), and let $v \in H^1(B_2)$ be such that*

$$v \leq 1 \text{ in } B_2, \quad \text{and} \quad \mathcal{L}v \leq 0 \text{ in } B_2.$$

Assume that

$$|\{v \leq 0\} \cap B_1| \geq \mu > 0.$$

Then,

$$\sup_{B_{1/2}} v \leq 1 - \gamma,$$

for some small $\gamma > 0$ depending only on $n, \lambda, \Lambda,$ and μ .

In other words, if $v \leq 1$, and it is “far from 1” in a set of non-zero measure, then v cannot be close to 1 in $B_{1/2}$. (See Figure 3.2.)

Let us show how this lemma yields the oscillation decay:

Proof of Proposition 3.13. Consider the function

$$w(x) := \frac{2}{\text{osc}_{B_2} v} \left(v(x) - \frac{\sup_{B_2} v + \inf_{B_2} v}{2} \right)$$

and notice that

$$-1 \leq w \leq 1 \text{ in } B_2,$$

(in fact, $\text{osc}_{B_2} w = 2$). Let us assume that $|\{w \leq 0\} \cap B_1| \geq \frac{1}{2}|B_1|$ (otherwise, we can take $-w$ instead). Then, by Lemma 3.14, we get

$$w \leq 1 - \gamma \text{ in } B_{1/2},$$

and thus

$$\operatorname{osc}_{B_{1/2}} w \leq 2 - \gamma.$$

This yields

$$\operatorname{osc}_{B_{1/2}} v \leq \left(1 - \frac{\gamma}{2}\right) \operatorname{osc}_{B_2} v,$$

and thus the proposition is proved. \square

To prove Lemma 3.14, we will need the following De Giorgi isoperimetric inequality. It is a kind of a quantitative version of the fact that an H^1 function cannot have a jump discontinuity.

Lemma 3.15. *Let $w \in H^1(B_1)$ be such that*

$$\int_{B_1} |\nabla w|^2 dx \leq C_\circ.$$

Let

$$A := \{w \leq 0\} \cap B_1, \quad D := \left\{w \geq \frac{1}{2}\right\} \cap B_1, \quad E := \left\{0 < w < \frac{1}{2}\right\} \cap B_1.$$

Then, we have

$$C_\circ |E| \geq c |A|^2 \cdot |D|^2$$

for some constant c depending only on n .

Proof. We define \bar{w} in B_1 as $\bar{w} = w$ in E , $\bar{w} \equiv 0$ in A and $\bar{w} = \frac{1}{2}$ in D . In this way, $\nabla \bar{w} \equiv 0$ in $B_1 \setminus E$ and $\int_{B_1} |\nabla \bar{w}|^2 \leq C_\circ$.

Let us denote the average of \bar{w} in B_1 by $\bar{w}_{B_1} := \int_{B_1} \bar{w}(x) dx$. Then,

$$\begin{aligned} |A| \cdot |D| &\leq 2 \int_A \int_D |\bar{w}(x) - \bar{w}(y)| dx dy \\ &\leq 2 \int_{B_1} \int_{B_1} (|\bar{w}(x) - \bar{w}_{B_1}| + |\bar{w}(y) - \bar{w}_{B_1}|) dx dy \\ &= 4|B_1| \int_{B_1} |\bar{w}(x) - \bar{w}_{B_1}| dx \leq C \int_E |\nabla \bar{w}(x)| dx, \end{aligned}$$

where in the last step we have used the Poincaré inequality (Theorem 1.6 with $p = 1$) and the fact that $\nabla \bar{w} \equiv 0$ in $B_1 \setminus E$. Thus, by Hölder's inequality we reach

$$|A| \cdot |D| \leq C \int_E |\nabla \bar{w}| \leq C \left(\int_E |\nabla \bar{w}|^2 \right)^{1/2} |E|^{1/2} \leq C C_\circ^{1/2} |E|^{1/2},$$

as we wanted to see. \square

Finally, we prove Lemma 3.14:

— DRAFT —

Proof of Lemma 3.14. Consider the sequence

$$w_k := 2^k \left[v - (1 - 2^{-k}) \right]_+.$$

Notice that $w_k \leq 1$ in B_2 since $v \leq 1$ in B_2 . Moreover, $\mathcal{L}w_k \leq 0$ in B_2 .

Using the energy inequality (Lemma 3.8), we easily get that

$$\int_{B_1} |\nabla w_k|^2 \leq C \int_{B_2} w_k^2 \leq C_0 \quad (\text{notice } 0 \leq w_k \leq 1 \text{ in } B_2).$$

We also have

$$|\{w_k \leq 0\} \cap B_1| \geq \mu > 0$$

(by the assumption on v). We now apply Lemma 3.15 recursively to w_k , as long as

$$\int_{B_1} w_{k+1}^2 \geq \delta^2.$$

We get

$$\left| \left\{ w_k \geq \frac{1}{2} \right\} \cap B_1 \right| \geq |\{w_{k+1} > 0\} \cap B_1| \geq \int_{B_1} w_{k+1}^2 \geq \delta^2.$$

Thus, from Lemma 3.15,

$$\left| \left\{ 0 < w_k < \frac{1}{2} \right\} \cap B_1 \right| \geq \frac{c}{C_0} \delta^4 \mu^2 = \beta > 0,$$

where $\beta > 0$ is independent of k , and depends only on n , δ , and μ .

But notice that the sets $\{0 < w_k < \frac{1}{2}\}$ are disjoint for all $k \in \mathbb{N}$, therefore we cannot have the previous inequality for every k . This means that, for some $k_\circ \in \mathbb{N}$ (depending only on n and β) we have

$$\int_{B_1} w_{k_\circ}^2 < \delta^2$$

and, hence, by the L^2 to L^∞ estimate from Proposition 3.10

$$\|w_+\|_{L^\infty(B_{1/2})} \leq C \|w_+\|_{L^2(B_1)}.$$

We get

$$\|w_{k_\circ}\|_{L^\infty(B_{1/2})} \leq C\delta \leq \frac{1}{2},$$

provided that $\delta > 0$ is small enough, depending only on n , λ , and Λ . This means that $w_{k_\circ} \leq \frac{1}{2}$ in $B_{1/2}$, and thus

$$v \leq \frac{1}{2} 2^{-k_\circ} + (1 - 2^{-k_\circ}) \leq 1 - 2^{-k_\circ - 1} = 1 - \gamma$$

as desired, where k_\circ (and therefore, γ) depends only on n , λ , Λ , and μ . \square

Summarizing, we have now proved Lemma 3.14 (by using the L^2 to L^∞ estimate and Lemma 3.15). Then, Lemma 3.14 implies the oscillation decay, and the oscillation decay implies the Hölder regularity.

Theorem 3.16. *Let \mathcal{L} be of the form (3.10), and let $v \in H^1(B_1)$ solve*

$$\mathcal{L}v = 0 \quad \text{in } B_1.$$

Then,

$$\|v\|_{C^{0,\alpha}(B_{1/2})} \leq C\|v\|_{L^\infty(B_1)}$$

for some $\alpha > 0$ and C depending only on n , λ , and Λ .

Proof. The theorem follows from the oscillation decay, in much the same way as Corollary 2.7). \square

Combining this last result with the L^2 to L^∞ estimate, Proposition 3.10, we finally obtain the theorem of De Giorgi–Nash.

Theorem 3.17. *Let $v \in H^1(B_1)$ be a weak solution to $\operatorname{div}(A(x)\nabla v) = 0$ in B_1 , with $0 < \lambda \operatorname{Id} \leq A(x) \leq \Lambda \operatorname{Id}$. Then, there exists some $\alpha > 0$ such that $v \in C^{0,\alpha}(B_{1/2})$ and*

$$\|v\|_{C^{0,\alpha}(B_{1/2})} \leq C\|v\|_{L^2(B_1)}.$$

The constants C and $\alpha > 0$ depend only on n , λ , and Λ .

Proof. The result follows from Theorem 3.16 combined with Proposition 3.10 (by (3.13)). \square

As a consequence of the previous result, we have:

Proof of Theorem 3.7. It follows by Theorem 3.17 by a covering argument. \square

In particular, as shown below, Theorem 3.17 solved Hilbert's XIXth problem.

This is one of the main results for which De Giorgi got the Wolf Prize in 1990, and Nash got the Abel Prize in 2015. It has been speculated that if only one of them had solved Hilbert's XIXth problem, he would also have received the Fields Medal for the proof.

Remark 3.18 (Harnack's inequality). Even though it is not needed to prove Theorem 3.17, it is interesting to notice that with some more work one can also prove Harnack's inequality for operators of the form $\operatorname{div}(A(x)\nabla v)$; see [LZ17, Mos61].

3.4. Solution to Hilbert's XIXth problem

In this chapter, we have proved the *interior regularity* result for $v \in H^1(B_1)$

$$\operatorname{div}(A(x)\nabla v) = 0 \quad \text{in } B_1 \quad \implies \quad \|v\|_{C^{0,\alpha}(B_{1/2})} \leq C\|v\|_{L^2(B_1)},$$

for some small $\alpha > 0$ depending only on n , λ , and Λ .

For a general domain $\Omega \subset \mathbb{R}^n$, this gives the estimate for $v \in H^1(\Omega)$

$$\operatorname{div}(A(x)\nabla v) = 0 \quad \text{in } \Omega \quad \implies \quad \|v\|_{C^{0,\alpha}(\tilde{\Omega})} \leq C\|v\|_{L^2(\Omega)},$$

for any $\tilde{\Omega} \subset\subset \Omega$ (with a constant C that depends only on n , λ , Λ , Ω , and $\tilde{\Omega}$).

Thanks to this, one can in fact solve Hilbert's XIXth problem:

Theorem. *Let $u \in H^1(\Omega)$ be any local minimizer of*

$$\mathcal{E}(w) := \int_{\Omega} L(\nabla w) \, dx,$$

where L is smooth and uniformly convex, and $\Omega \subset \mathbb{R}^n$ is bounded. Then, u is C^∞ in Ω .

Proof. Any local minimizer u satisfies

$$\int_{\Omega} DL(\nabla u)\nabla\phi \, dx = 0, \quad \text{for all } \phi \in C_c^\infty(\Omega).$$

(This is the weak formulation of $\operatorname{div}(DL(\nabla u)) = 0$ in Ω .)

As in the proof of Theorem 3.5, if we define for any $h \in \mathbb{R}^n$,

$$\tilde{A}(x) := \int_0^1 D^2L(t\nabla u(x+h) + (1-t)\nabla u(x)) \, dt,$$

then $\tilde{A}(x)$ is uniformly elliptic (since L is uniformly convex, $0 < \lambda \operatorname{Id} \leq D^2L(p) \leq \Lambda \operatorname{Id}$). We have that $\frac{u(\cdot+h)-u}{|h|} \in H^1(\Omega_h)$ fulfills (again, see Theorem 3.5)

$$\int_{\Omega} \nabla \left(\frac{u(x+h) - u(x)}{|h|} \right) \cdot \tilde{A}(x)\nabla\phi(x) \, dx = 0 \quad \text{for all } \phi \in C_c^\infty(\Omega_h),$$

that is, $\frac{u(\cdot+h)-u}{|h|}$ solves weakly

$$\operatorname{div} \left(\tilde{A} \nabla \left[\frac{u(\cdot+h) - u}{|h|} \right] \right) = 0, \quad \text{in } \Omega_h.$$

(We recall $\Omega_h := \{x \in \Omega : \operatorname{dist}(x, \partial\Omega) > |h|\}$.)

By the estimate of De Giorgi and Nash (Theorem 3.7), we find that

$$\left\| \frac{u(\cdot + h) - u}{|h|} \right\|_{C^{0,\alpha}(\tilde{\Omega})} \leq C \left\| \frac{u(\cdot + h) - u}{|h|} \right\|_{L^2(\Omega_h)} \leq C \|\nabla u\|_{L^2(\Omega)}$$

for any $\tilde{\Omega} \subset\subset \Omega_h$ (see **(S8)** in Chapter 1). By **(H7)**, since the constant C is independent of h , this yields

$$\|u\|_{C^{1,\alpha}(\tilde{\Omega})} \leq C \|u\|_{H^1(\Omega)}.$$

Now, once u is $C^{1,\alpha}$, we are done by Theorem 3.5. \square

3.5. Further results and open problems

Let us finish this chapter by mentioning some state-of-the art results and open problems regarding the minimization of convex energy functionals.

As we have explained, the minimization of a convex functional is a classical problem in the Calculus of Variations. Namely,

$$(3.14) \quad \min_{w \in \mathcal{W}} \int_{\Omega} L(\nabla w) \, dx,$$

with $L : \mathbb{R}^n \rightarrow \mathbb{R}$ convex, $\Omega \subset \mathbb{R}^n$, and some appropriate class of functions \mathcal{W} , say, with prescribed trace on $\partial\Omega$. Hilbert's XIXth problem deals with the case in which L is *uniformly* convex and smooth, to obtain nice regularity results. In Remark 3.1 we discuss that lack of convexity can yield non-uniqueness of minimizers, but it is not that clear what occurs if we simply remove the condition on the uniform convexity, but maintain the *strict* convexity. In fact, functionals involving functions L that only involve strict convexity (that is, D^2L could have 0 and ∞ as eigenvalues in some sets) appear naturally in some applications: anisotropic surface tensions, traffic flow, and statistical mechanics (see [Moo20] and the references therein).

Minimizers of (3.14) are known to be Lipschitz (under enough smoothness of the domain and boundary data) by the comparison principle. Thus, the following natural question is to whether first derivatives of minimizers are continuous:

If L is strictly convex, are minimizers to (3.14) C^1 ?

The answer to that question has been investigated in the last years. The problem was first addressed by De Silva and Savin in [DS10], where they studied the case of dimension 2:

Theorem 3.19 ([DS10]). *Let u be a Lipschitz minimizer to (3.14) in \mathbb{R}^2 , and suppose that L is strictly convex. Assume that the set of points where D^2L has some eigenvalue equal to 0 or ∞ is finite. Then, $u \in C^1$.*

Later, Mooney in [Moo20] studied the problem in higher dimensions and showed that the question has a negative answer, in general, in dimensions $n \geq 4$:

Theorem 3.20 ([Moo20]). *In \mathbb{R}^4 there exists a Lipschitz minimizer to (3.14), with L strictly convex, that is not C^1 .*

In the example by Mooney, the minimizer is analytic outside the origin (having a singularity there), and the corresponding functional has a Hessian with an eigenvalue going to ∞ in $\{x_1^2 + x_2^2 = x_3^2 + x_4^2\} \cap \sqrt{2}\mathbb{S}^3$, but otherwise, the eigenvalues are uniformly bounded from below away from zero.

It is currently an open question what happens in dimension $n = 3$, as well as what happens for general strictly convex functionals in \mathbb{R}^2 .

Fully nonlinear elliptic PDE

Second order nonlinear elliptic PDEs in their most general form can be written as

$$(4.1) \quad F(D^2u, \nabla u, u, x) = 0 \quad \text{in } \Omega \subset \mathbb{R}^n.$$

Understanding the regularity of solutions to these equations has been a major research direction since the mid-20th century.

These are called *fully nonlinear elliptic equations*. Besides their own interest in PDE theory, they arise in Probability Theory (stochastic control, differential games; see Appendix C for a probabilistic interpretation), and in Geometry.

Thanks to Schauder-type estimates, under natural assumptions on the dependence on ∇u , u , and x , the regularity for (4.1) can be reduced to understanding solutions to

$$(4.2) \quad \boxed{F(D^2u) = 0 \quad \text{in } \Omega \subset \mathbb{R}^n.}$$

Indeed, some of the “perturbative” methods that we used in Chapter 2 to prove Schauder estimates for linear equations $\sum a_{ij}(x)\partial_{ij}u = f(x)$ in $\Omega \subset \mathbb{R}^n$ work in such fully nonlinear setting, too. For simplicity, we will focus here on the study of (4.2).

In the next sections we will discuss the following:

- What is ellipticity for solutions to (4.2)?
- Existence and uniqueness of solutions.
- Regularity of solutions to (4.2).

We will *not* prove all the main known results of this Chapter, but only give an overview of what is known. We refer to the books [CC95] and [NTV14] for more details about this topic.

4.1. What is ellipticity?

There are (at least) two possible ways to define ellipticity:

- Linearizing the equation.
- “Imposing” that the comparison principle holds.

We will see that they are essentially the same.

Definition 4.1. Let $F : \mathbb{R}^{n \times n} \rightarrow \mathbb{R}$. We say that F is *elliptic* if for any two symmetric matrices $A, B \in \mathbb{R}^{n \times n}$ such that $A \geq B$ (i.e., $A - B$ is positive semi-definite) we have

$$F(A) \geq F(B),$$

with strict inequality if $A > B$ (i.e., $A - B$ positive definite).

The Laplace equation $\Delta u = 0$ corresponds to the case $F(M) = \text{tr } M$. For a linear equation (with constant coefficients)

$$\sum_{i,j=1}^n a_{ij} \partial_{ij} u = 0,$$

F is given by $F(M) = \text{tr}(AM)$, where $A = (a_{ij})_{i,j}$. This equation is elliptic if and only if the coefficient matrix A is positive definite. Therefore, it coincides with our notion of ellipticity for linear equations.

Remark 4.2 (Comparison Principle). If a C^2 function v touches $u \in C^2$ from below at a point x_o (i.e. $u \geq v$ everywhere, and $u(x_o) = v(x_o)$; see Figure 4.1), then it follows that

$$\nabla u(x_o) = \nabla v(x_o), \quad D^2 u(x_o) \geq D^2 v(x_o).$$

Therefore, for these functions we would have $F(D^2 u(x_o)) \geq F(D^2 v(x_o))$ if F is elliptic. This is essential when proving the comparison principle.

Proposition 4.3 (Comparison Principle). *Assume that F is elliptic, and $\Omega \subset \mathbb{R}^n$ is bounded. Let $u, v \in C^2(\Omega) \cap C^0(\bar{\Omega})$. Then,*

$$\begin{cases} u \geq v & \text{on } \partial\Omega \\ F(D^2 u) \leq F(D^2 v) & \text{in } \Omega. \end{cases} \implies u \geq v \text{ in } \bar{\Omega}.$$

Proof. We separate into two cases.

Case 1. Assume first that $F(D^2 u) < F(D^2 v)$ in Ω (with strict inequality). If the conclusion is false, then the function $u - v$ would have an interior minimum inside Ω , say at $x_o \in \Omega$. Then, we would have $D^2(u -$

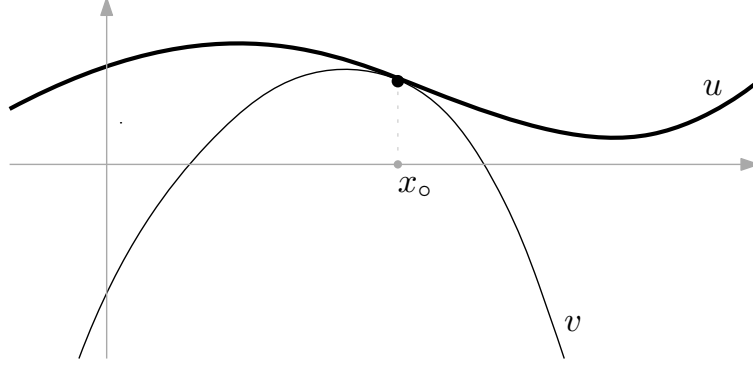

Figure 4.1. The function v touches u from below at x_0 .

$v)(x_0) \geq 0$. Therefore, $D^2u(x_0) \geq D^2v(x_0)$ and by ellipticity of F , this yields $F(D^2u(x_0)) \geq F(D^2v(x_0))$. This is a contradiction with $F(D^2u) < F(D^2v)$ in Ω , and hence $u \geq v$ in $\bar{\Omega}$.

Case 2. Assume now $F(D^2u) \leq F(D^2v)$ in Ω . Then, we can define

$$\bar{u}(x) := u(x) + \varepsilon(c_\Omega - |x|^2),$$

where $c_\Omega > 0$ is a constant such that $c_\Omega - |x|^2 > 0$ in $\bar{\Omega}$ (recall that Ω is bounded).

Then, we have $\bar{u} \geq u$ on $\partial\Omega$, and $D^2\bar{u} = D^2u - 2\varepsilon\text{Id}$. Thus, by ellipticity,

$$F(D^2\bar{u}) = F(D^2u - 2\varepsilon\text{Id}) < F(D^2u) \leq F(D^2v) \quad \text{in } \Omega.$$

By Case 1,

$$\begin{cases} \bar{u} \geq v & \text{on } \partial\Omega, \\ F(D^2\bar{u}) < F(D^2v) & \text{in } \Omega. \end{cases} \implies \bar{u} \geq v \quad \text{in } \Omega.$$

This gives

$$u(x) + \varepsilon(c_\Omega - |x|^2) \geq v(x) \quad \text{in } \Omega.$$

Letting $\varepsilon \downarrow 0$ we deduce that $u \geq v$ in Ω . \square

Thus, we see that ellipticity is exactly what we need in order to prove the comparison principle. We will see that *uniform ellipticity* (analogously to the case of linear equations) implies, in fact, the regularity of solutions.

Definition 4.4. Let $F : \mathbb{R}^{n \times n} \rightarrow \mathbb{R}$. Then F is *uniformly elliptic* if there are $0 < \lambda \leq \Lambda$ (the *ellipticity constants*), such that for every symmetric matrices M, N with $N \geq 0$ (that is, positive semi-definite), we have

$$\lambda\|N\| \leq F(M + N) - F(M) \leq \Lambda\|N\|,$$

where $\|N\| := \text{tr}((N^T N)^{1/2}) = \text{tr}(N)$ is the sum of the (absolute value of the) eigenvalues.

We remark that our choice of matrix norm in the previous definition is not standard. In \mathbb{R}^n , all norms are equivalent and thus we could have chosen any other norm. This definition of norm, however, avoids dealing with constants in future computations.

Of course, uniform ellipticity implies ellipticity, in a quantitative way.

For linear equations, i.e. $F(M) = \text{tr}(AM)$, uniform ellipticity is equivalent to

$$0 < \lambda \text{Id} \leq A \leq \Lambda \text{Id},$$

as usual.

The alternative way to see ellipticity is by linearizing the equation:

Assume $F \in C^1$ (which is not always the case!). We consider the functions

$$F_{ij}(M) := \frac{\partial F}{\partial M_{ij}}(M),$$

i.e., the first derivative of $F(M)$ with respect to the component M_{ij} of the matrix M .

Then, it is immediate to see that

$$\begin{aligned} F \text{ is uniformly elliptic} &\iff 0 < \lambda \text{Id} \leq (F_{ij}(M))_{i,j} \leq \Lambda \text{Id}, \quad \forall M \\ &\iff \text{the linearized equation is uniformly elliptic.} \end{aligned}$$

Therefore, at least when F is C^1 , uniform ellipticity can be seen as uniform ellipticity of the linearized equation.

In general, though, the uniform ellipticity condition implies that F is Lipschitz, but not always C^1 . There are, in fact, important examples of equations $F(D^2u) = 0$ in which the corresponding F is Lipschitz but not C^1 . In this case, the previous characterization of ellipticity through the derivatives of F still holds, understanding now that they are defined almost everywhere.

Remark 4.5 (Convex (or concave) equations). An important subclass of equations $F(D^2u) = 0$ are those for which F is convex (or concave). Namely, $F(M)$ as a function $F : \mathbb{R}^{n \times n} \rightarrow \mathbb{R}$ is convex (or concave). In this case, the equation can be written as a *Bellman equation* (see (C.3)), as

$$F(D^2u) = \max_{\alpha \in \mathcal{A}} \{L_\alpha u\} = 0,$$

where $\{L_\alpha\}_{\alpha \in \mathcal{A}}$ is a family of linear operators of the form

$$L_\alpha u := \sum_{i,j=1}^n a_{ij}^\alpha \partial_{ij} u + c_\alpha,$$

for a family of coefficients $\{a_{ij}^\alpha\}_{\alpha \in \mathcal{A}}$ uniformly elliptic, with ellipticity constants λ and Λ .

Notice that if u solves $F(D^2u) = 0$, with F convex, then $v = -u$ solves $G(D^2v) = 0$, with $G(M) = -F(-M)$, and therefore, G is concave.

Pucci operators. Within the class of fully nonlinear uniformly elliptic operators with ellipticity constants λ and Λ , the *extremal* or *Pucci* operators, denoted by \mathcal{M}^+ and \mathcal{M}^- , are those that attain the *extreme* values (from above and below, respectively). Alternatively, every other elliptic operator with the same ellipticity constants is ordered with respect to them in the sense of (4.6) below.

We define \mathcal{M}^\pm as follows.

Definition 4.6. Given $0 < \lambda \leq \Lambda$, the *extremal* or *Pucci* operators with ellipticity constants λ and Λ , $\mathcal{M}^\pm : \mathbb{R}^{n \times n} \rightarrow \mathbb{R}$, are defined as

$$(4.3) \quad \begin{aligned} \mathcal{M}^-(M) &:= \inf_{\lambda \text{Id} \leq (a_{ij})_{i,j} \leq \Lambda \text{Id}} \left\{ \sum_{i,j=1}^n a_{ij} M_{ij} \right\} = \inf_{\lambda \text{Id} \leq A \leq \Lambda \text{Id}} \{ \text{tr}(AM) \} \\ \mathcal{M}^+(M) &:= \sup_{\lambda \text{Id} \leq (a_{ij})_{i,j} \leq \Lambda \text{Id}} \left\{ \sum_{i,j=1}^n a_{ij} M_{ij} \right\} = \sup_{\lambda \text{Id} \leq A \leq \Lambda \text{Id}} \{ \text{tr}(AM) \}, \end{aligned}$$

for any symmetric matrix M . They are uniformly elliptic operators, with ellipticity constants λ and Λ .

In particular, from the definition we have

$$\mathcal{M}^\pm(\alpha M) = \alpha \mathcal{M}^\pm(M), \quad \text{for all } \alpha \geq 0.$$

Notice that $\mathcal{M}^\pm = \mathcal{M}_{n,\lambda,\Lambda}^\pm$. In general, however, the dependence on the ellipticity constants and the dimension will be clear in the corresponding context, and thus we will drop it in the notation.

Sometimes, it is easier to define the Pucci operators through the eigenvalues of the corresponding matrix, appropriately weighted with the ellipticity constants, in the following way.

Lemma 4.7. *The Pucci operators as defined in (4.3) can be equivalently defined as*

$$(4.4) \quad \begin{aligned} \mathcal{M}^-(M) &= \lambda \sum_{\mu_i > 0} \mu_i + \Lambda \sum_{\mu_i < 0} \mu_i = \lambda \|M_+\| - \Lambda \|M_-\|, \\ \mathcal{M}^+(M) &= \Lambda \sum_{\mu_i > 0} \mu_i + \lambda \sum_{\mu_i < 0} \mu_i = \Lambda \|M_+\| - \lambda \|M_-\|, \end{aligned}$$

where $\mu_i = \mu_i(M)$ denote the eigenvalues of the symmetric matrix M , the matrices M_+ and M_- are such that $M_\pm \geq 0$, $M = M_+ - M_-$, and $\|A\| = \text{tr}((A^T A)^{1/2})$.

Proof. The proof follows directly using the following rearrangement-type inequalities involving the eigenvalues and the product of two symmetric matrices A and B :

$$\sum_{i=1}^n \lambda_i(A) \lambda_{n-i}(B) \leq \operatorname{tr}(AB) \leq \sum_{i=1}^n \lambda_i(A) \lambda_i(B),$$

where $\lambda_1(A) \leq \dots \leq \lambda_n(A)$ denote the ordered eigenvalues of A , and $\lambda_1(B) \leq \dots \leq \lambda_n(B)$ denote the ordered eigenvalues of B . \square

From the definition of uniform ellipticity of F (Definition 4.4) it follows that, given two symmetric matrices M, N ,

$$\lambda \|N_+\| - \Lambda \|N_-\| \leq F(M+N) - F(M) \leq \Lambda \|N_+\| - \lambda \|N_-\|,$$

where $N = N_+ - N_-$, and $N_{\pm} \geq 0$. Thus, by Lemma 4.7,

$$(4.5) \quad \mathcal{M}^-(N) \leq F(M+N) - F(M) \leq \mathcal{M}^+(N).$$

If we take $M = 0$, we see that

$$(4.6) \quad \mathcal{M}^-(N) \leq F(N) - F(0) \leq \mathcal{M}^+(N),$$

so these operators are like the “worse case” from above and below — up to a constant, $F(0)$. (Recall that \mathcal{M}^{\pm} are fully nonlinear uniformly elliptic operators with ellipticity constants λ, Λ .)

If we further assume that $F(0) = 0$, we see that if u solves any equation of the form $F(D^2u) = 0$ then in particular

$$(4.7) \quad \mathcal{M}^-(D^2u) \leq 0 \leq \mathcal{M}^+(D^2u).$$

Remark 4.8. Equation (4.7) is called *equation in non-divergence form with bounded measurable coefficients*. Indeed, notice that given some uniformly elliptic coefficients $(a_{ij}(x))_{i,j}$ with no regularity assumption on x , if $u \in C^2$ fulfills $\sum_{i,j} a_{ij}(x) \partial_{ij} u$ then in particular (4.7) holds. On the other hand, if (4.7) holds for some $u \in C^2$, one can recover some uniformly elliptic coefficients $(a_{ij}(x))_{i,j}$ such that $\sum_{i,j} a_{ij}(x) \partial_{ij} u$.

4.2. Equations in two variables

Before going into the general theory of existence and regularity for fully nonlinear equations in \mathbb{R}^n , let us study a simpler case: fully nonlinear equations in two variables.

The main regularity estimate in this context is due to Nirenberg [Nir53], and reads as follows.

Theorem 4.9. *Let $F : \mathbb{R}^{2 \times 2} \rightarrow \mathbb{R}$ be uniformly elliptic with ellipticity constants λ and Λ . Let $u \in C^2(B_1)$ solve*

$$F(D^2u) = 0 \quad \text{in } B_1 \subset \mathbb{R}^2.$$

Then,

$$\|u\|_{C^{2,\alpha}(B_{1/2})} \leq C\|u\|_{L^\infty(B_1)},$$

for some constants $\alpha > 0$ and C depending only on λ and Λ .

The idea of the proof is the following: define $v := \partial_e u$, and differentiate the equation $F(D^2u) = 0$ in the e direction, to get

$$(4.8) \quad \sum_{i,j=1}^2 a_{ij}(x) \partial_{ij} v(x) = 0 \quad \text{in } B_1 \subset \mathbb{R}^2,$$

where $a_{ij}(x) := F_{ij}(D^2u(x))$ for $i, j \in \{1, 2\}$. Since F is uniformly elliptic, we have $a_{22}(x) \geq \lambda > 0$. Thus, we can divide (4.8) by $a_{22}(x)$ to obtain

$$(4.9) \quad a(x) \partial_{11} v(x) + b(x) \partial_{12} v(x) + \partial_{22} v(x) = 0,$$

for some coefficients

$$a(x) = \frac{a_{11}(x)}{a_{22}(x)} \quad \text{and} \quad b(x) = \frac{a_{12}(x) + a_{21}(x)}{a_{22}(x)} = \frac{2a_{12}(x)}{a_{22}(x)}.$$

If we write $w := \partial_1 v$ and differentiate (4.9) with respect to x_1 , we get

$$\partial_1 (a(x) \partial_1 w(x) + b(x) \partial_2 w(x)) + \partial_{22} w(x) = \operatorname{div}(A(x) \nabla w) = 0,$$

where

$$A(x) := \begin{pmatrix} a(x) & b(x) \\ 0 & 1 \end{pmatrix}.$$

That is, w solves an equation in divergence form, and A is uniformly elliptic, with ellipticity constants depending on λ and Λ . Thus, by the De Giorgi–Nash result (Theorem 3.7) one has $\partial_1 v = w \in C^{0,\alpha}(B_{1/2})$. Since the roles of x_1 and x_2 can be changed, and since $v = \partial_e u$ (with $e \in \mathbb{S}^{n-1}$ arbitrary), we deduce that $u \in C^{2,\alpha}(B_{1/2})$.

Let us now formally prove it. The idea is the one presented in the lines above, where we used that $u \in C^4$. In reality we can only use that $u \in C^2$, so we proceed by means of incremental quotients.

Proof of Theorem 4.9. Let us define

$$v(x) = \frac{u(x+h) - u(x)}{|h|} \in C^2(B_{1-|h|}),$$

with $|h| < \frac{1}{4}$, and proceed similarly to Theorem 3.5. Since F is translation invariant, we have

$$F(D^2u(x)) = 0, \quad F(D^2u(x+h)) = 0 \quad \text{in } B_{1-|h|}.$$

Then, by the fundamental theorem of calculus for line integrals,

$$0 = F(D^2u(x+h)) - F(D^2u(x)) = \sum_{i,j=1}^2 a_{ij}(x) \partial_{ij} (u(x+h) - u(x)),$$

where

$$a_{ij}(x) = \int_0^1 F_{ij}(tD^2u(x+h) + (1-t)D^2u(x)) dt.$$

Since F is uniformly elliptic, $(a_{ij})_{i,j}$ is uniformly elliptic (with the same ellipticity constants). That is, $v \in C^2(B_{1-|h|})$ solves an equation in non-divergence form

$$a_{11}(x)\partial_{11}v(x) + 2a_{12}(x)\partial_{12}v(x) + a_{22}(x)\partial_{22}v(x) = 0 \quad \text{in } B_{1-|h|},$$

where $a_{12} = a_{21}$ and $\partial_{12}v = \partial_{21}v$ because $v \in C^2$. From the ellipticity conditions, we have $\lambda \leq a_{22}(x) \leq \Lambda$, and we can divide by $a_{22}(x)$ to get

$$a(x)\partial_{11}v(x) + b(x)\partial_{12}v(x) + \partial_{22}v(x) = 0 \quad \text{in } B_{1-|h|}.$$

Let

$$A(x) := \begin{pmatrix} a(x) & b(x) \\ 0 & 1 \end{pmatrix}.$$

It is straightforward to check that A is uniformly elliptic, with ellipticity constants λ/Λ and Λ/λ . Let $\eta \in C_c^2(B_{1-|h|})$ and notice that, by integration by parts,

$$\int_{B_{1-|h|}} \partial_2 \eta \partial_{12} v = \int_{B_{1-|h|}} \partial_1 \eta \partial_{22} v.$$

Thus,

$$\begin{aligned} \int_{B_{1-|h|}} \nabla \eta \cdot A(x) \nabla \partial_1 v &= \int_{B_{1-|h|}} \nabla \eta(x) \cdot \begin{pmatrix} a(x)\partial_{11}v(x) + b(x)\partial_{12}v(x) \\ \partial_{12}v(x) \end{pmatrix} dx \\ &= \int_{B_{1-|h|}} \{ \partial_1 \eta (a(x)\partial_{11}v + b(x)\partial_{12}v) + \partial_2 \eta \partial_{12}v \} dx \\ &= \int_{B_{1-|h|}} \partial_1 \eta (a(x)\partial_{11}v + b(x)\partial_{12}v + \partial_{22}v) dx \\ &= 0. \end{aligned}$$

That is, $\partial_1 v$ solves an equation with bounded measurable coefficients $A(x)$ in divergence form. Thus, by the De Giorgi–Nash theorem (see Theorem 3.16), we know that $\partial_1 v \in C^\alpha$ and

$$\|\partial_1 v\|_{C^{0,\alpha}(B_{1/2})} \leq C \|\partial_1 v\|_{L^\infty(B_{1-|h|})} \leq C \|\partial_1 u\|_{C^{0,1}(B_1)},$$

(notice that we can go from B_1 to $B_{1-|h|}$ in Theorem 3.16 by a covering argument for $|h|$ small), for some constant C depending only on λ and Λ . By letting $|h| \rightarrow 0$, thanks to **(H7)**, we obtain that

$$\|\nabla \partial_1 u\|_{C^{0,\alpha}(B_{1/2})} \leq C \|\partial_1 v\|_{L^\infty(B_{1-|h|})} \leq C \|\partial_1 u\|_{C^{0,1}(B_1)},$$

for some constant C depending only on λ and Λ . By symmetry, the same inequality is true for $\partial_2 v$ (and $\partial_2 u$), so that

$$\|u\|_{C^{2,\alpha}(B_{1/2})} \leq C \|u\|_{C^{1,1}(B_1)}.$$

Notice that, by interpolation inequalities (see (1.9)), for each $\varepsilon > 0$, there exists some $C_\varepsilon > 0$ such that

$$\|u\|_{C^{1,1}(B_{1/2})} \leq \varepsilon \|u\|_{C^{2,\alpha}(B_1)} + C_\varepsilon \|u\|_{L^\infty(B_1)}.$$

Now, the proof can be concluded by means of Lemma 2.27 analogously to what has been done in the proof of Theorem 2.20. \square

Thus, as we can see, in the two-dimensional case it is rather easy to show a priori $C^{2,\alpha}$ estimates for solutions to the fully nonlinear equation. Thanks to these estimates, by means of the continuity method (see [GT77] or [HL97]) one can actually show the existence of $C^{2,\alpha}$ solutions for the Dirichlet problem.

Nonetheless, as we will see, it turns out that in higher dimensions such an a priori estimate is no longer available, and one needs to prove existence of solutions in a different way, by introducing a new notion of weak solution (viscosity solutions).

This is what we do in the next section.

4.3. Existence of solutions

We now turn our attention to fully nonlinear elliptic equations in \mathbb{R}^n .

The first question to understand is the existence of solutions: given a nice domain $\Omega \subset \mathbb{R}^n$, and a nice boundary data $g : \partial\Omega \rightarrow \mathbb{R}$, can we always solve the following Dirichlet problem?

$$\begin{cases} F(D^2u) = 0 & \text{in } \Omega \\ u = g & \text{on } \partial\Omega. \end{cases}$$

Notice that here we cannot construct the solution by minimizing a functional, since these fully nonlinear equations do not come, in general, from any energy functional.

To construct the solution, we only have two options:

- Prove “a priori estimates” and then use the continuity method.
- Use the comparison principle and Perron’s method.

The continuity method is reasonably easy to use, but we need $C^{2,\alpha}$ estimates for solutions up to the boundary. This is a very difficult problem, and in fact, in general we do *not* have $C^{2,\alpha}$ estimates for these equations in \mathbb{R}^n .

Therefore, we need to construct some kind of generalized notion of solution: *viscosity solutions*.

The right concept of solution must be so that we have

- Existence of solutions.

- Comparison principle (and in particular, uniqueness of solutions).
- Stability (so that limits of solutions are solutions).

Notice that if we consider only C^2 solutions, then we have the comparison principle (and it is easy to prove), but we may not be able to prove existence.

On the other hand, if we relax the notion of solution, then we may be able to easily prove the existence of a solution, but then it will be more difficult to prove the uniqueness/comparison principle.

The right notion of generalized solution is the one given in Definition 4.10 below, known as viscosity solutions. For subsolutions in the viscosity sense, this notion only requires that the function is upper semi-continuous (USC), while for supersolutions in the viscosity sense, this notion can be checked on lower semi-continuous (LSC) functions. This is important in the proof of existence of solutions.

We recall that a function f is said to be upper semi-continuous at x_o if

$$\limsup_{x \rightarrow x_o} f(x) \leq f(x_o).$$

Similarly, it is lower semi-continuous at x_o if

$$\liminf_{x \rightarrow x_o} f(x) \geq f(x_o).$$

We refer to [Sil15] for a nice introduction to viscosity solutions to elliptic equations.

Definition 4.10 (Viscosity solutions). Let $F : \mathbb{R}^{n \times n} \rightarrow \mathbb{R}$ be uniformly elliptic, and consider the PDE

$$F(D^2u) = 0 \quad \text{in } \Omega.$$

- We say that $u \in \text{USC}(\overline{\Omega})$ is a *subsolution* (in the viscosity sense), and we write $F(D^2u) \geq 0$, if for any $\phi \in C^2(\Omega)$ such that $\phi \geq u$ in Ω and $\phi(x_o) = u(x_o)$, $x_o \in \Omega$, we have $F(D^2\phi(x_o)) \geq 0$.
- We say that $u \in \text{LSC}(\overline{\Omega})$ is a *supersolution* (in the viscosity sense), and we write $F(D^2u) \leq 0$, if for any $\phi \in C^2(\Omega)$ such that $\phi \leq u$ in Ω and $\phi(x_o) = u(x_o)$, $x_o \in \Omega$, we have $F(D^2\phi(x_o)) \leq 0$.
- We say that $u \in C(\overline{\Omega})$ solves $F(D^2u) = 0$ in Ω in the viscosity sense if it is both a subsolution and a supersolution.

Notice that there may be points $x_o \in \Omega$ at which no function $\phi \in C^2$ touches u at x_o (from above and/or from below). This is allowed by the previous definition.

Remark 4.11 (Some history). The concept of viscosity solution was introduced in 1983 by Crandall and P.-L. Lions in the study of first-order

equations. During a few years, the work on viscosity solutions focused on first-order equations, because it was not known whether second-order uniformly elliptic PDEs would have a unique viscosity solution (or if the comparison principle would hold for these solutions). In 1988 the comparison principle for viscosity solutions was finally proved by Jensen [Jen88], and in subsequent years the concept has become prevalent in the analysis of elliptic PDEs.

In 1994, P.-L. Lions received the Fields Medal for his contributions to nonlinear PDEs, one of his major contributions being his work on viscosity solutions [ICM94].

A key result in the theory of viscosity solutions is the following (see [Jen88, CC95]).

Theorem 4.12 (Comparison principle for viscosity solutions). *Let $\Omega \subset \mathbb{R}^n$ be any bounded domain, and $F : \mathbb{R}^{n \times n} \rightarrow \mathbb{R}$ be uniformly elliptic. Assume that $u \in \text{LSC}(\bar{\Omega})$ and $v \in \text{USC}(\bar{\Omega})$ satisfy*

$$(4.10) \quad u \geq v \quad \text{on} \quad \partial\Omega,$$

and

$$(4.11) \quad F(D^2u) \leq 0 \leq F(D^2v) \quad \text{in} \quad \Omega \quad \text{in the viscosity sense.}$$

Then,

$$u \geq v \quad \text{in} \quad \bar{\Omega}.$$

We already proved this for C^2 functions u in Proposition 4.3, and the proof was very simple. For viscosity solutions the proof is more involved.

The main step in the proof of the comparison principle is the following.

Proposition 4.13. *Let $\Omega \subset \mathbb{R}^n$ be any bounded domain, and $F : \mathbb{R}^{n \times n} \rightarrow \mathbb{R}$ be uniformly elliptic. Assume that $u \in \text{LSC}(\bar{\Omega})$ and $v \in \text{USC}(\bar{\Omega})$ are bounded functions that satisfy (4.10) and (4.11). Then,*

$$\mathcal{M}^-(D^2(u - v)) \leq 0 \quad \text{in} \quad \Omega.$$

We refer the reader to [CC95, Theorem 5.3] for a proof of such result, where it is proved assuming that $u, v \in C(\bar{\Omega})$. The same proof works under the hypotheses here presented.

The comparison principle follows using Proposition 4.13 and the next lemma.

Lemma 4.14. *Let $\Omega \subset \mathbb{R}^n$ be any bounded domain, and assume that $w \in \text{LSC}(\bar{\Omega})$ satisfies*

$$w \geq 0 \quad \text{on} \quad \partial\Omega,$$

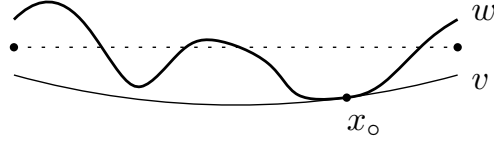

Figure 4.2. We slide v from below until it touches w at a point x_0 .

and

$$\mathcal{M}^-(D^2w) \leq 0 \quad \text{in } \Omega.$$

Then, $w \geq 0$ in Ω .

Proof. The proof is similar to that of Proposition 1.22. Indeed, first notice that after a rescaling we may assume $\Omega \subset B_1$, and assume by contradiction that w has a negative minimum in Ω . Then, since $w \geq 0$ on $\partial\Omega$, we have $\min_{\overline{\Omega}} w = -\delta$, with $\delta > 0$, and the minimum is achieved in Ω .

Let us now consider $0 < \varepsilon < \delta$, and $v(x) := -\kappa + \varepsilon(|x|^2 - 1)$, with $\kappa > 0$ (that is, a sufficiently flat paraboloid).

Now, notice that $v < 0$ on $\partial\Omega$, and we can choose $\kappa > 0$ so that v touches w from below at a point inside Ω . In other words, there is $\kappa > 0$ such that $w \geq v$ in Ω , and $w(x_0) = v(x_0)$ for some $x_0 \in \Omega$. (See Figure 4.2.) Then, by definition of viscosity supersolution, we have

$$\mathcal{M}^-(D^2v)(x_0) \leq 0.$$

However, a direct computation gives $\mathcal{M}^-(D^2v) = \mathcal{M}^-(2\varepsilon\text{Id}) \equiv 2\lambda n\varepsilon > 0$ in Ω , a contradiction. \square

Once we have the comparison principle for viscosity solutions, we can use *Perron's method* to prove existence of solutions. We next do this, following [Sil15].

First let us notice that, for any bounded function u in $\overline{\Omega} \subset \mathbb{R}^n$, we may define its *upper semi-continuous envelope* as

$$u^*(x) := \sup \left\{ \limsup_k u(x_k) : x_k \rightarrow x \right\},$$

where the supremum is taken among all sequences $\overline{\Omega} \ni x_k \rightarrow x$. Notice that u^* is the smallest function satisfying $u^* \in \text{USC}(\overline{\Omega})$ and $u^* \geq u$. Similarly, we define the lower semi-continuous envelope of u as

$$(4.12) \quad u_*(x) := \inf \left\{ \liminf_k u(x_k) : x_k \rightarrow x \right\}.$$

We will need the following lemma, which is a generalization of the fact that the maximum of subsolutions is also a subsolution.

Lemma 4.15. *Let $F : \mathbb{R}^{n \times n} \rightarrow \mathbb{R}$ be uniformly elliptic, and let $\Omega \subset \mathbb{R}^n$ be any bounded domain.*

Let $(u_a)_{a \in \mathcal{A}}$ be a family of subsolutions: $u_a \in \text{USC}(\overline{\Omega})$, and $F(D^2 u_a) \geq 0$ in Ω , for all $a \in \mathcal{A}$. Let

$$u(x) := \sup_{a \in \mathcal{A}} u_a,$$

and let

$$u^*(x) := \sup \left\{ \limsup_{k \rightarrow \infty} u(x_k) : x_k \rightarrow x \right\}.$$

Then, $u^ \in \text{USC}(\overline{\Omega})$ is a subsolution: $F(D^2 u^*) \geq 0$ in Ω .*

Proof. We divide the proof into two steps.

Step 1. In the first part, we show that if u^* has a strict local maximum at x_o , then one can extract sequences of indices $a_k \in \mathcal{A}$ for $k \in \mathbb{N}$, and of points $x_k \in \overline{\Omega}$, such that $x_k \rightarrow x_o$, u_{a_k} has a local maximum at x_k , and $u_{a_k}(x_k) \rightarrow u^*(x_o)$.

By definition of $u^*(x_o)$, we can extract a sequence of indices $(a_j)_{j \in \mathbb{N}}$, $a_j \in \mathcal{A}$, and of points $y_j \rightarrow x_o$, such that $u_{a_j}(y_j) \rightarrow u^*(x_o)$. Now let us prove that we can extract a further subsequence $a_k := a_{j_k}$ such that our desired conclusion holds.

Indeed, let $r > 0$ be such that $u^*(y) < u^*(x_o)$ for $y \in B_r(x_o) \setminus \{x_o\}$, and let $\rho > 0$ be so small that, if $K_\rho := B_r(x_o) \setminus B_\rho(x_o)$, then

$$\max_{K_\rho} u^* \leq u^*(x_o) - \delta,$$

for some $\delta > 0$.

Now notice that, for j large enough, $u_{a_j} \leq u^*(x_o) - \delta/2$ in K_ρ . Otherwise, there would be $j_m \rightarrow \infty$ and z_m such that $u_{a_{j_m}}(z_m) > u^*(x_o) - \delta/2 \geq \max_{K_\rho} u^* + \delta/2$. Since K_ρ is compact, up to a subsequence, $z_m \rightarrow z_\infty$ for some z_∞ in K_ρ such that

$$u^*(z_\infty) \geq \limsup_{m \rightarrow \infty} u_{a_{j_m}}(z_m) > \max_{K_\rho} u^* + \delta/2.$$

A contradiction. Thus, $u_{a_j} \leq u^*(x_o) - \delta/2$ in K_ρ for j large enough.

Let now $x_j \in \overline{B_r(x_o)}$ be the point where the maximum of u_{a_j} in $\overline{B_r(x_o)}$ is attained. In particular, $u_{a_j}(x_j) \geq u_{a_j}(y_j) \rightarrow u^*(x_o)$, that is, $u_{a_j}(x_j) \geq u^*(x_o) - \delta/4$ for j large enough. Since $u_{a_j} \leq u^*(x_o) - \delta/2$ in K_ρ (again, for j large enough), this implies that $x_j \in B_\rho(x_o)$. That is, u_{a_j} attains its maximum in $B_r(x_o)$, inside $B_\rho(x_o)$. By repeating this argument choosing smaller $\rho > 0$, we can extract a subsequence $a_k := a_{j_k}$ to get the desired result. Notice that $x_j \rightarrow x_o$, and that by construction, $u_{a_j}(x_j) \geq u_{a_j}(y_j) \rightarrow u^*(x_o)$, so that $u_{a_j}(x_j) \rightarrow u^*(x_o)$. This completes the first part of the proof.

Notice that so far we have not used that u_a are subsolutions.

Step 2. Let us now proceed with the second part of the proof, which proves the lemma. Let $\phi \in C^2$ be such that $\phi(x_o) = u^*(x_o)$ and $u \leq \phi$ around x_o (that is, $u - \phi$ attains its local maximum at x_o), with $x_o \in \Omega$. By considering $\bar{\phi}(x) = \phi(x) + |x - x_o|^4$, we have that $u - \bar{\phi}$ attains a strict local maximum at x_o . We apply now the first part of the proof with $v_a := u_a - \bar{\phi}$. That is, there exist sequences of indices $(a_k)_{k \in \mathbb{N}}$, and points $x_k \rightarrow x_o$ such that $u_{a_k} - \bar{\phi}$ attains its local maximum at x_k and $u_{a_k}(x_k) \rightarrow u^*(x_o)$ (since $\bar{\phi}$ is continuous). In particular, since u_{a_k} are subsolutions in the viscosity sense, we have

$$F(D^2\bar{\phi}(x_k)) \geq 0 \implies F(D^2\bar{\phi}(x_o)) = F(D^2\phi(x_o)) \geq 0,$$

by continuity of F and $D^2\phi$. Thus, u is a viscosity subsolution. \square

We can now prove the existence of viscosity solutions. To do so, we assume that we are given a bounded domain $\Omega \subset \mathbb{R}^n$ such that

$$(4.13) \quad \begin{aligned} &\text{for every } x_o \in \partial\Omega, \text{ there exists some } \psi_+ \in C^2(\bar{\Omega}) \text{ such that} \\ &\psi_+(x_o) = 0, \quad \psi_+|_{\partial\Omega \setminus \{x_o\}} > 0, \quad \text{and } \mathcal{M}^+(D^2\psi_+) \leq 0 \text{ in } \Omega, \end{aligned}$$

where we recall that \mathcal{M}^+ is the Pucci operator defined in (4.3) with ellipticity constants λ and Λ . Notice that, if (4.13) holds, then we also have that for every $x_o \in \partial\Omega$, there exists some $\psi_- \in C^2(\bar{\Omega})$ such that $\psi_-(x_o) = 0$, $\psi_-|_{\partial\Omega \setminus \{x_o\}} < 0$, and

$$\mathcal{M}^-(D^2\psi_-) \geq 0 \text{ in } \Omega,$$

where ψ_- is simply given by $\psi_- = -\psi_+$.

We will later show that any bounded C^2 domain satisfies (4.13), for any constants $0 < \lambda \leq \Lambda$.

Remark 4.16. In the following results, we will often assume that $F(0) = 0$. Otherwise, if $F(0) \neq 0$, we can consider the uniformly elliptic operator $\tilde{F}_t(D^2u) := F(D^2(u + t|x|^2/2)) = F(D^2u + t\text{Id})$ instead. Then, $\tilde{F}_t(0) = F(t\text{Id})$, and we can choose $t \in \mathbb{R}$ such that $F(t\text{Id}) = 0$. Indeed, if $F(0) > 0$, by (4.6) $\tilde{F}_t(0) = F(t\text{Id}) \leq \mathcal{M}^+(t\text{Id}) + F(0) = tn\lambda + F(0) < 0$ for $t < 0$ negative enough. Since $\tilde{F}_0(0) = F(0) > 0$, by continuity of \tilde{F}_t in t , we are done for some $t \in [-\frac{F(0)}{n\lambda}, 0)$. The case $F(0) < 0$ follows analogously.

Theorem 4.17 (Existence and uniqueness of viscosity solutions). *Let $F : \mathbb{R}^{n \times n} \rightarrow \mathbb{R}$ be uniformly elliptic with ellipticity constants λ and Λ , let $\Omega \subset \mathbb{R}^n$ be any bounded domain such that (4.13) holds, and let $g \in C(\partial\Omega)$.*

Then, there exists a (unique) viscosity solution to the Dirichlet problem

$$\begin{cases} F(D^2u) = 0 & \text{in } \Omega \\ u = g & \text{on } \partial\Omega. \end{cases}$$

Proof. The uniqueness follows directly from the comparison principle, Theorem 4.12. Thanks to Remark 4.16, we will assume $F(0) = 0$. The proof of existence follows by means of Perron's method, as shown next.

Let us define the set of all subsolutions as

$$\mathcal{A} := \{v \in \text{USC}(\bar{\Omega}) : F(D^2v) \geq 0 \text{ in } \Omega, v \leq g \text{ on } \partial\Omega\}.$$

Then, we can define the pointwise supremum of all subsolutions in \mathcal{A} ,

$$u(x) := \sup_{v \in \mathcal{A}} v(x).$$

Notice that since the constant function $-\|g\|_{L^\infty(\partial\Omega)}$ belongs to \mathcal{A} , such set is non-empty. Notice also that all elements of \mathcal{A} must be below the constant $\|g\|_{L^\infty(\partial\Omega)}$ by the comparison principle, and thus u is bounded.

We define the upper semi-continuous envelope

$$u^*(x) = \sup \left\{ \limsup_{k \rightarrow \infty} u(x_k) : x_k \rightarrow x \right\}.$$

Notice that, by Lemma 4.15, we have $F(D^2u^*) \geq 0$ in Ω .

The strategy of the proof is as follows. We first prove that $u^* = g$ on $\partial\Omega$. This implies that $u^* \in \mathcal{A}$, and therefore $u^* = u$. Then, once this is done, we will define u_* as the lower semi-continuous envelope of u , and show that u_* is a supersolution. By the comparison principle, this will imply that $u_* \geq u$, and thus $u_* = u$. This means that u is continuous, and that it is both a subsolution and a supersolution, as wanted.

Step 1. Let us start by showing that $u^* = g$ on $\partial\Omega$, and that u^* is continuous on $\partial\Omega$. Namely, we show that for every $x_o \in \partial\Omega$, and every $x_k \rightarrow x_o$ with $x_k \in \Omega$, then $\liminf_{k \rightarrow \infty} u^*(x_k) = \limsup_{k \rightarrow \infty} u^*(x_k) = g(x_o)$.

Let $\varepsilon > 0$, and let us define

$$w_\varepsilon^- := g(x_o) - \varepsilon + k_\varepsilon \psi_- = g(x_o) - \varepsilon - k_\varepsilon \psi_+,$$

where $k_\varepsilon > 0$ is chosen large enough (depending on ε but also on g and Ω) such that $w_\varepsilon^- \leq g$ on $\partial\Omega$, and $\psi_- = -\psi_+$ is the function given by property (4.13) at x_o . Let us also define

$$w_\varepsilon^+ := g(x_o) + \varepsilon + k_\varepsilon \psi_+,$$

where $k_\varepsilon > 0$ is such that $w_\varepsilon^+ \geq g$ on $\partial\Omega$ (without loss of generality, by taking it larger if necessary, we can assume it is the same as before).

By the properties of the extremal operators (4.3), we have $\mathcal{M}^-(D^2w_\varepsilon^-) = k_\varepsilon \mathcal{M}^-(D^2\psi_-) \geq 0$ and $\mathcal{M}^+(D^2w_\varepsilon^+) = k_\varepsilon \mathcal{M}^+(D^2\psi_+) \leq 0$ in Ω . In particular, by (4.6) (recall $F(0) = 0$),

$$F(D^2w_\varepsilon^-) \geq 0 \quad \text{and} \quad F(D^2w_\varepsilon^+) \leq 0 \quad \text{in } \Omega,$$

and $w_\varepsilon^- \in \mathcal{A}$. Notice that, by continuity of ψ_- , for each $\varepsilon > 0$ there exists some $\delta > 0$ such that $w_\varepsilon^- \geq g(x_o) - 2\varepsilon$ in $B_\delta(x_o) \cap \Omega$. This yields, $u^* \geq w_\varepsilon^- \geq g(x_o) - 2\varepsilon$ in $B_\delta(x_o) \cap \Omega$, so that if $x_k \rightarrow x_o$, then

$$\liminf_{k \rightarrow \infty} u(x_k) \geq g(x_o) - 2\varepsilon.$$

On the other hand, by the comparison principle, all elements in \mathcal{A} are below w_ε^+ for any $\varepsilon > 0$. Again, by continuity of ψ_+ , for each $\varepsilon > 0$ there exists some $\delta > 0$ such that $w_\varepsilon^+ \leq g(x_o) + 2\varepsilon$ in $B_\delta(x_o) \cap \Omega$. This yields, $u^* \leq w_\varepsilon^+ \leq g(x_o) + 2\varepsilon$ in $B_\delta(x_o) \cap \Omega$, so that if $x_k \rightarrow x_o$, then

$$\limsup_{k \rightarrow \infty} u(x_k) \leq g(x_o) + 2\varepsilon.$$

Since $\varepsilon > 0$ is arbitrary, we have that if $x_k \rightarrow x_o$, then

$$\lim_{k \rightarrow \infty} u^*(x_k) = g(x_o).$$

Therefore, $u^* = g$ on $\partial\Omega$ and u is continuous on $\partial\Omega$. In particular, we have $u^* \in \mathcal{A}$ and (since $u^* \geq u$) $u^* \equiv u$. This means that $u \in \text{USC}(\bar{\Omega})$ and $F(D^2u) \geq 0$ in Ω .

Step 2. Now, we show that u is a supersolution as well. To do so, we consider its lower semi-continuous envelope u_* , (4.12), and prove that $F(D^2u_*) \leq 0$ in Ω .

We start by noticing that, since u is continuous on the boundary (by Step 1), then $u_* = g$ on $\partial\Omega$. Assume by contradiction that u_* is not a supersolution, that is, there exists some $x_o \in \Omega$ such that for some $\phi \in C^2$ we have $\phi(x_o) = u_*(x_o)$, $\phi \leq u_*$, but $F(D^2\phi(x_o)) > 0$.

By taking $\bar{\phi} = \phi - |x - x_o|^4$ if necessary, we may assume that $\phi < u_*$ if $x \neq x_o$, and we still have $F(D^2\phi(x_o)) > 0$. Notice that, by continuity of F and $D^2\phi$, we have $F(D^2\phi) > 0$ in $B_\rho(x_o)$ for some small $\rho > 0$.

On the other hand, consider $\phi + \delta$ for $\delta > 0$, and define $u_\delta := \max\{u, \phi + \delta\}$. Since $\phi(x) < u_*(x) \leq u(x)$ for $x \neq x_o$, we have for $\delta > 0$ small enough that $\phi_\delta < u$ outside $B_\rho(x_o)$.

Now, notice that u_δ is a subsolution, since it coincides with u outside $B_\rho(x_o)$ and it is the maximum of two subsolutions in $B_\rho(x_o)$. This means that $u_\delta \in \mathcal{A}$, and thus $u_\delta \leq u$. However, this means that $\phi + \delta \leq u$ everywhere in Ω , and thus $\phi + \delta \leq u_*$, a contradiction. Thus, u_* had to be a supersolution.

But then, again by the comparison principle, since u is a subsolution and $u = u_* = g$ on $\partial\Omega$, we get that $u_* \geq u$ in Ω , which means that $u = u_*$.

Therefore, u is continuous, both a subsolution and a supersolution, and $u = g$ on $\partial\Omega$. This concludes the proof. \square

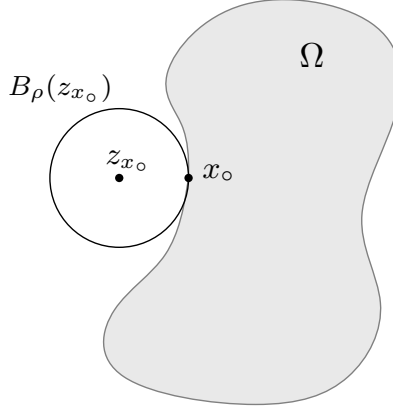

Figure 4.3. Representation of the construction from the proof of Corollary 4.18.

As a consequence, we find the following.

Corollary 4.18. *Let Ω be any bounded C^2 domain, and $F : \mathbb{R}^{n \times n} \rightarrow \mathbb{R}$ be uniformly elliptic. Then, for any continuous $g \in C(\partial\Omega)$, the Dirichlet problem*

$$\begin{cases} F(D^2u) = 0 & \text{in } \Omega \\ u = g & \text{on } \partial\Omega, \end{cases}$$

has a unique viscosity solution.

Proof. The result follows from the previous theorem, we just need to check that any C^2 domain fulfils (4.13). To do so, we need to construct an appropriate barrier at every boundary point $z \in \partial\Omega$.

Notice, that in the very simple case that Ω is strictly convex, such barrier ψ_+ can simply be a hyperplane with zero level set tangent to Ω at a given boundary point, such that it is positive in Ω .

In general, since Ω is a bounded C^2 domain, it satisfies the exterior ball condition for some uniform radius $\rho > 0$: that is, for each point $x_0 \in \partial\Omega$ there exist some point $z_{x_0} = z(x_0) \in \Omega^c$ and a ball $B_\rho(z_{x_0})$ such that $B_\rho(z_{x_0}) \subset \Omega^c$ and $B_\rho(z_{x_0}) \cap \partial\Omega = \{x_0\}$. See Figure 4.3.

Let us construct the barrier ψ_+ from (4.13) for C^2 domains. We consider the function ψ in $\mathbb{R}^n \setminus B_\rho$, for $\rho > 0$ given by the exterior ball condition,

$$\psi(x) = e^{-\alpha\rho^2} - e^{-\alpha|x|^2},$$

for some $\alpha > 0$ also to be chosen.

Notice that

$$\begin{aligned} e^{\alpha|x|^2} D^2\psi(x) &= -4\alpha^2 \begin{pmatrix} x_1^2 & x_1x_2 & \dots & x_1x_n \\ x_2x_1 & x_2^2 & \dots & x_2x_n \\ \vdots & \vdots & \ddots & \vdots \\ x_nx_1 & \dots & \dots & x_n^2 \end{pmatrix} + 2\alpha\text{Id} \\ &= 2\alpha\text{Id} - 4\alpha^2 xx^T. \end{aligned}$$

Then, for $|x| \geq \rho$ we have

$$\begin{aligned} e^{\alpha|x|^2} \mathcal{M}^+(D^2\psi) &\leq 2\alpha\mathcal{M}^+(\text{Id}) - 4\alpha^2\mathcal{M}^-(xx^T) = 2\alpha n\Lambda - 4\alpha^2\lambda|x|^2 \\ &\leq 2\alpha(n\Lambda - 2\alpha\lambda\rho^2). \end{aligned}$$

In particular, if we choose $\alpha \geq \frac{n\Lambda}{2\lambda\rho^2}$, we have

$$\mathcal{M}^+(D^2\psi) \leq 0 \quad \text{in } B_\rho^c.$$

Therefore, translations of ψ are good candidates for the function ψ_+ from (4.13).

Let now $x_o \in \partial\Omega$ be any point on the boundary, and take $\psi_+(x) := \psi(x - z_{x_o})$. It is clear that $\psi_+(x_o) = 0$, and that $\psi_+(x) > 0$ for any $x \in \bar{\Omega} \setminus \{x_o\}$. On the other hand, from the discussion above we know that $\mathcal{M}^+(D^2\psi_+) \leq 0$. Thus, Ω fulfills (4.13). \square

Remark 4.19 (Lipschitz domains). It is actually possible to show that (4.13) holds for any bounded Lipschitz domain, too. In particular, this yields the existence of viscosity solutions in such class of domains.

Finally, we also have the following:

Proposition 4.20 (Stability of viscosity solutions). *Let F_k be a sequence of uniformly elliptic operators (with ellipticity constants λ and Λ), and let $u_k \in C(\Omega)$ be such that $F_k(D^2u_k) = 0$ in Ω in the viscosity sense.*

Assume that F_k converges to F uniformly in compact sets, and $u_k \rightarrow u$ uniformly in compact sets of Ω . Then, $F(D^2u) = 0$ in Ω in the viscosity sense.

Proof. The proof uses the same ideas as the proof of Lemma 4.15.

Let $x_o \in \Omega$ and $\phi \in C^2$ be such that $\phi(x_o) = u(x_o)$ and $\phi \leq u$ in Ω . By taking $\bar{\phi}(x) = \phi(x) + |x - x_o|^4$ we have that $u - \bar{\phi}$ attains a strict local maximum at x_o .

Let now $v_k := u_k - \bar{\phi}$. Up to a subsequence, by Step 1 in the proof of Lemma 4.15, there exists a sequence $x_k \rightarrow x_o$ such that $u_k - \bar{\phi}$ attains a local maximum at x_k , and from the uniform convergence of u_k to u , we also have $u_k(x_k) \rightarrow u(x_o)$. Since u_k are, in particular, subsolutions in the

viscosity sense for the operator F_k , we have that $F_k(D^2\bar{\phi}(x_k)) \geq 0$. Now, since $x_k \rightarrow x_\circ$, and F_k converges uniformly to F , we get that, letting $k \rightarrow \infty$, $F(D^2\bar{\phi}(x_\circ)) = F(D^2\phi(x_\circ)) \geq 0$.

In particular, u is a viscosity subsolution for F . Doing the same for $-u$, we reach that u is a viscosity solution. \square

Remark 4.21. We have seen that for fully nonlinear equations $F(D^2u) = 0$ we have existence, uniqueness, and stability of viscosity solutions. The same can be done for more general equations like $F(D^2u, x) = f(x)$, with continuous coefficients in x , see [CC95]. However, when we want to study linear equations in non-divergence form

$$(4.14) \quad \sum a_{ij}(x) \partial_{ij} u(x) = 0$$

with bounded measurable coefficients, it turns out that viscosity solutions do not behave so well; see the counterexample in [Nad97] (see also [CCKS96]). This is the reason why, instead of defining viscosity solutions for a specific equation of the type (4.14), what we do is to say that u solves an equation with bounded measurable coefficients (in non-divergence form) whenever it satisfies

$$\mathcal{M}^-(D^2u) \leq 0 \leq \mathcal{M}^+(D^2u)$$

in viscosity sense, where \mathcal{M}^\pm are the Pucci extremal operators (recall Definition 4.6). As explained in Remark 4.8, for C^2 functions u these two inequalities are equivalent to saying that u solves (4.14) for *some* coefficients $a_{ij}(x)$.

Summarizing: For viscosity solutions we now have all we need in order to study regularity issues:

- Existence of solutions.
- Comparison principle.
- Stability under uniform limits.

4.4. Regularity of solutions: an overview

In the last section we saw that for any (smooth) domain $\Omega \subset \mathbb{R}^n$ and any (continuous) boundary data g , one can find a unique viscosity solution $u \in C(\bar{\Omega})$ to the Dirichlet problem

$$\begin{cases} F(D^2u) = 0 & \text{in } \Omega \\ u = g & \text{on } \partial\Omega. \end{cases}$$

Now, the main question is that of regularity:

If $u \in C(B_1)$ solves $F(D^2u) = 0$ in B_1 ,
what can we say about the regularity of u ?

Is the following implication true?

$$(4.15) \quad \begin{cases} F \in C^\infty \text{ and} \\ \text{uniformly elliptic} \\ \& \\ F(D^2u) = 0 \text{ in } B_1 \end{cases} \xrightarrow{?} u \in C^\infty(B_{1/2}).$$

This is in some sense a question analogous to Hilbert's XIXth problem.

Regularity for fully nonlinear equations: first results. Assume that u has some initial regularity, and that F is C^∞ and uniformly elliptic. Then,

$$F(D^2u) = 0 \xrightarrow{\partial_e} \sum_{i,j=1}^n F_{ij}(D^2u) \partial_{ij}(\partial_e u) = 0,$$

where

$$F_{ij} := \frac{\partial F}{\partial M_{ij}}$$

is the derivative of $F(M)$ with respect to M_{ij} . Therefore, if we denote

$$a_{ij}(x) := F_{ij}(D^2u(x)),$$

we will then have

$$a_{ij}(x) \text{ is uniformly elliptic, } 0 < \lambda \text{Id} \leq (a_{ij}(x))_{i,j} \leq \Lambda \text{Id},$$

thanks to the uniform ellipticity of F .

Denoting

$$v = \partial_e u,$$

we have

$$F(D^2u) = 0 \implies v = \partial_e u \text{ solves } \sum_{i,j=1}^n a_{ij}(x) \partial_{ij}(\partial_e u) = 0,$$

where $a_{ij}(x) = F_{ij}(D^2u(x))$.

Now, if $u \in C^2$ (or $C^{2,\alpha}$), then the coefficients $a_{ij}(x)$ are continuous (or $C^{0,\alpha}$), and therefore we get, by Schauder-type estimates,

$$u \in C^2 \implies a_{ij} \in C^0 \implies v \in C^{1,\alpha} \implies u \in C^{2,\alpha} \implies \dots \implies u \in C^\infty,$$

where we use the bootstrap argument

$$u \in C^{2,\alpha} \implies a_{ij} \in C^{0,\alpha} \implies u \in C^{3,\alpha} \implies a_{ij} \in C^{1,\alpha} \implies \dots \implies u \in C^\infty.$$

In other words, this suggests that the following result.

Proposition 4.22. *Let F be uniformly elliptic and C^∞ . Let u be any solution of $F(D^2u) = 0$ in B_1 , and assume that $u \in C^2$. Then, $u \in C^\infty$.*

Proof. The idea is the one presented in the lines above, but we can only use that $u \in C^2$ (in the previous argumentation, we used that u is C^3). To do so, we make use of incremental quotients, as in Theorem 3.5.

Let $u \in C^2(B_1)$, and let $h \in \mathbb{R}^n$ with $|h|$ small. Notice that F is translation invariant, so

$$F(D^2u(x)) = 0, \quad F(D^2u(x+h)) = 0 \quad \text{in } B_{1-|h|}.$$

Then,

$$0 = F(D^2u(x+h)) - F(D^2u(x)) = \sum_{i,j=1}^n a_{ij}(x) \partial_{ij}(u(x+h) - u(x)),$$

where

$$a_{ij}(x) = \int_0^1 F_{ij}(tD^2u(x+h) + (1-t)D^2u(x)) dt$$

(cf. the proof of Theorem 3.5 or Theorem 4.9). This is just the fundamental theorem of calculus. In particular, since F is uniformly elliptic, $(a_{ij})_{i,j}$ is uniformly elliptic (with the same ellipticity constants). Since $u \in C^2$ and F is smooth, a_{ij} are continuous. That is, $\frac{u(\cdot+h)-u}{|h|}$ solves the equation in non-divergence form

$$\sum_{i,j=1}^n a_{ij}(x) \partial_{ij} \left(\frac{u(x+h) - u(x)}{|h|} \right) = 0 \quad \text{in } B_{1-|h|},$$

for some continuous and uniformly elliptic coefficients a_{ij} . By the a priori estimates for equations with continuous coefficients (Proposition 2.31), we know that for any $\alpha \in (0, 1)$ we have

$$\left\| \frac{u(\cdot+h) - u}{|h|} \right\|_{C^{1,\alpha}(B_{1/2})} \leq C \left\| \frac{u(\cdot+h) - u}{|h|} \right\|_{L^\infty(B_{3/4})} \leq C \|u\|_{C^{0,1}(B_{3/4})},$$

for some constant C that is independent of h . By **(H7)**, (1.7), from Chapter 1, we reach that $u \in C^{2,\alpha}(B_{1/2})$, and by a covering argument $u \in C^{2,\alpha}$ inside B_1 .

Now, we proceed iteratively.

Since $u \in C^{2,\alpha}$ inside B_1 , we have that $\frac{u(\cdot+h)-u}{|h|} \in C^{2,\alpha}$ inside $B_{1-|h|}$ for all h . Together with F being smooth, this implies that $a_{ij} \in C^{0,\alpha}$ inside $B_{1-|h|}$. That is, now $\frac{u(\cdot+h)-u}{|h|}$ solves a non-divergence-form equation with Hölder continuous coefficients, and from Theorem 2.20 we get uniform bounds in the $C^{2,\alpha}$ norm for $\frac{u(\cdot+h)-u}{|h|}$, thus yielding that $u \in C^{3,\alpha}$ inside B_1 . We can repeat this argument iteratively, using the higher order estimates from Corollary 2.21, to reach the desired result. \square

This is similar to what happened in Hilbert's XIXth problem: in that case we proved $C^1 \Rightarrow C^\infty$.

Notice, however, that for fully nonlinear equations, the "gap to be filled" (from C^0 to C^2) is "bigger" than in Hilbert's XIXth problem (from H^1 to C^1).

Now, the central question to be answered is:

Is it true that solutions are always C^2 ?

In particular, we wonder whether viscosity solutions are always classical solutions or not, and thus, whether the Dirichlet problem always admits a classical solution.

Regularity for fully nonlinear equations. An important observation in the previous argument was the following:

$$\begin{cases} u \text{ solves} \\ F(D^2u) = 0 \end{cases} \implies \begin{cases} v = \partial_e u \text{ solves } \sum_{i,j=1}^n a_{ij}(x) \partial_{ij} v = 0, \\ \text{with } a_{ij}(x) = F_{ij}(D^2u(x)). \end{cases}$$

This means that, at least formally, the derivatives of any solution to any fully nonlinear equation solve an equation with bounded measurable coefficients.

This can be argued properly by looking at incremental quotients:

Recall from (4.5) the equivalence

F is uniformly elliptic

\Updownarrow

$$\mathcal{M}^-(D^2(u-v)) \leq F(D^2u) - F(D^2v) \leq \mathcal{M}^+(D^2(u-v)),$$

where \mathcal{M}^\pm are the Pucci operators. Thus,

$$\begin{aligned} \mathcal{M}^-(D^2(u(x+h) - u(x))) &\leq F(D^2u(x+h)) - F(D^2u(x)) \leq \\ &\leq \mathcal{M}^+(D^2(u(x+h) - u(x))). \end{aligned}$$

Using $F(D^2u) = 0$ and denoting

$$v_h(x) = \frac{u(x+h) - u(x)}{|h|},$$

we then reach

$$\begin{cases} \mathcal{M}^+(D^2v_h) \geq 0 \\ \mathcal{M}^-(D^2v_h) \leq 0 \end{cases} \quad \left(\begin{array}{l} \text{equation with bounded} \\ \text{measurable coefficients} \end{array} \right).$$

The question is now: in case of divergence-form equations we proved

$$\begin{cases} \text{equation with bounded} \\ \text{meas. coeff. } \operatorname{div}(A(x)\nabla v) = 0 \end{cases} \implies v \in C^{0,\alpha} \quad (\text{De Giorgi-Nash}).$$

Is there a similar result for equations in non-divergence form? The answer is YES.

Theorem 4.23 (Krylov–Safonov, 1979). *Let $0 < \lambda \leq \Lambda$ be the ellipticity constants, and $v \in C(B_1)$ be any solution to*

$$(4.16) \quad \begin{cases} \mathcal{M}^+(D^2v) \geq 0 & \text{in } B_1 \\ \mathcal{M}^-(D^2v) \leq 0 & \text{in } B_1, \end{cases}$$

in the viscosity sense. Then,

$$\|v\|_{C^{0,\alpha}(B_{1/2})} \leq C\|v\|_{L^\infty(B_1)}$$

for some small $\alpha > 0$ and C depending only on n , λ , and Λ .

This result was proved in [KS79] (for classical solutions); see also [Moo19] for a more recent and simplified proof, and [DS21] for an extension of the result.

Recall that (see the end of Section 4.1), for C^2 functions, (4.16) is actually equivalent to v solving an equation of the type $\sum_{i,j} a_{ij}(x)\partial_{ij}v$ for some uniformly elliptic coefficients. This is why (4.16) is called an *equation in non-divergence form with bounded measurable coefficients*.

As a consequence of this result, we find the following. We assume for simplicity $F(0) = 0$, otherwise see Remark 4.16.

Theorem 4.24 (Krylov–Safonov, 1979). *Let F be uniformly elliptic, $F(0) = 0$, and $u \in C(B_1)$ be any viscosity solution to*

$$F(D^2u) = 0 \quad \text{in } B_1.$$

Then,

$$\|u\|_{C^{1,\alpha}(B_{1/2})} \leq C\|u\|_{L^\infty(B_1)}$$

for some small $\alpha > 0$ and C depending only on n , λ , and Λ .

Proof. By Proposition 4.13 (with $v \equiv 0$), the function $u \in C(B_1)$ solves itself an equation with bounded measurable coefficients

$$\begin{cases} \mathcal{M}^+(D^2u) \geq 0 & \text{in } B_1 \\ \mathcal{M}^-(D^2u) \leq 0 & \text{in } B_1. \end{cases}$$

Therefore, by Theorem 4.23, $u \in C^{0,\alpha}$ inside B_1 . Now, for $\beta \in (0, 1]$ take

$$v_h(x) := \frac{u(x+h) - u(x)}{|h|^\beta},$$

which (again by Proposition 4.13) also solves an equation with bounded measurable coefficients,

$$\begin{cases} \mathcal{M}^+(D^2v_h) \geq 0 & \text{in } B_{1-|h|} \\ \mathcal{M}^-(D^2v_h) \leq 0 & \text{in } B_{1-|h|}. \end{cases}$$

Then, again by Theorem 4.23, we have

$$\|v_h\|_{C^{0,\alpha}(B_{1/2})} \leq C \|v_h\|_{L^\infty(B_{1-|h|})} \leq C \|u\|_{C^\beta(B_1)}.$$

By **(H7)**, we deduce that

$$\|u\|_{C^{\alpha+\beta}(B_{1/2})} \leq C \|u\|_{C^\beta(B_1)},$$

provided that $\alpha + \beta$ is not an integer and $\beta \leq 1$.

Using this estimate with $\beta = \alpha, 2\alpha, \dots, k\alpha$, one gets $C^{1,\alpha}$ regularity in a finite number of steps. \square

Remark 4.25. Observe that:

- The $C^{0,\alpha}$ estimate for bounded measurable coefficients, Theorem 4.23, is the best one can get in dimensions $n \geq 3$; see [Saf87].
- In a sense, Theorem 4.23 is the analogue of the result of De Giorgi–Nash for divergence-form equations. However, it is not enough to get C^2 regularity for solutions to fully nonlinear equations.

Summary: We have $F(D^2u) = 0 \Rightarrow u \in C^{1,\alpha}$ (for some small $\alpha > 0$). Moreover, $u \in C^2 \Rightarrow u \in C^\infty$. However, we have no idea (yet) if

$$u \in C^{1,\alpha} \stackrel{?}{\Rightarrow} u \in C^2.$$

In the two-dimensional case, as we have seen in Theorem 4.9 (as an a priori estimate), it turns out that one can do something better, and *all* solutions are $C^{2,\alpha}$. This is because, in \mathbb{R}^2 , solutions to equations with bounded measurable coefficients are not only $C^{0,\alpha}$, but $C^{1,\alpha}$.

As a consequence, we have the following.

Theorem 4.26. *Let $F : \mathbb{R}^{2 \times 2} \rightarrow \mathbb{R}$ be uniformly elliptic and smooth. Let $u \in C(B_1)$ be any viscosity solution to*

$$F(D^2u) = 0 \quad \text{in } B_1 \subset \mathbb{R}^2.$$

Then $u \in C^\infty$.

This completely answers question (4.15) in two dimensions.

In higher dimensions, a famous result established (independently) by Evans [Eva82] and Krylov [Kry82] gives the following.

Theorem 4.27 (Evans–Krylov, 1982). *Let F be any **convex** (or **concave**) uniformly elliptic operator, with $F(0) = 0$. Let $u \in C(B_1)$ be any viscosity solution to*

$$F(D^2u) = 0 \quad \text{in } B_1.$$

Then,

$$\|u\|_{C^{2,\alpha}(B_{1/2})} \leq C \|u\|_{L^\infty(B_1)},$$

for some $\alpha > 0$ and C depending only on n , λ , and Λ . In particular, if F is smooth then $u \in C^\infty$.

We refer to [CS10] for a shorter proof of such result.

Thus, for any solution to (4.2), with F uniformly elliptic and smooth, we have:

- If $u \in C^2$, then $u \in C^\infty$.
- $u \in C^{1,\alpha}$ always (Krylov–Safonov, 1979).
- In two dimensions, $u \in C^\infty$ (Nirenberg, 1952).
- If F is convex, then $u \in C^\infty$ (Evans–Krylov, 1982)

Question: What happens in general?

For decades it was an open problem to decide whether all solutions are C^2 or not. The question was finally answered by Nadirashvili and Vladuts in the 2000s [NV07, NV08, NV13]:

Theorem 4.28 (Nadirashvili–Vladuts, 2007-2013). *There are solutions to (4.2) that are not C^2 . These counterexamples exist in dimensions $n \geq 5$.*

Moreover, for every $\tau > 0$, there exists a dimension n and ellipticity constants λ and Λ , such that there are solutions u to $F(D^2u) = 0$ with $u \notin C^{1,\tau}$.

We refer to the monograph [NTV14] for more references and details.

It is *not* known what happens in \mathbb{R}^3 and \mathbb{R}^4 . This is one of the most remarkable open problems in elliptic PDEs.

4.5. Further results and open problems

As explained above, one of the main open questions regarding the problem

$$(4.17) \quad F(D^2u) = 0 \quad \text{in} \quad B_1 \subset \mathbb{R}^n$$

is the following:

Let u be any solution to (4.17) in \mathbb{R}^3 or \mathbb{R}^4 . Is it true that $u \in C^2$?

We have seen that it is in general not true that solutions to fully nonlinear equations (in dimension $n \geq 5$) are C^2 under the assumption that F is simply uniformly elliptic. Convexity, on the other hand, is a strong condition under which C^2 regularity is achieved, which, unfortunately, does not hold in some important applications. Even with this, it is still unclear what the optimal regularity of solutions is when F is convex and uniformly elliptic (not necessarily smooth). Theorem 4.27 only gives, a priori, $C^{2,\alpha}$ regularity for some small $\alpha > 0$.

These observations motivate, on the one hand, a more refined study for the regularity (and size of singularity) of solutions to general fully nonlinear elliptic equations, and on the other hand, the study of the optimal regularity under the convexity assumption.

Partial regularity. Recall that the ellipticity requirement for F implies that F is Lipschitz. Under the slightly more restrictive requirement that F is also C^1 , the following *partial regularity* result was proved by Armstrong, Silvestre, and Smart in [ASS12]:

Theorem 4.29 ([ASS12]). *Let F be uniformly elliptic, and assume in addition that $F \in C^1$. Let $u \in C^0(B_1)$ be any viscosity solution to (4.17).*

Then, there exist some $\varepsilon > 0$ depending only on n , λ , Λ , and a closed subset $\Sigma \subset \overline{B_1}$ with $\dim_{\mathcal{H}} \Sigma \leq n - \varepsilon$, such that $u \in C^2(B_1 \setminus \Sigma)$.

Here, $\dim_{\mathcal{H}}$ denotes the Hausdorff dimension of a set; see [Mat95]. Notice that if $\dim_{\mathcal{H}} \Sigma \leq n - \varepsilon$ then in particular Σ has zero measure.

This result is the best known partial regularity result for solutions of (non-convex) fully nonlinear equations in dimensions $n \geq 3$. Notice that the size of the singular set is not known to be optimal (it could be much smaller!). Moreover, it is an important open problem to decide whether the same statement holds without the regularity assumption $F \in C^1$.

Optimal regularity when F is convex. When F is convex and uniformly elliptic, solutions to (4.17) are known to be $C^{2,\alpha}$ for some small $\alpha > 0$. If $F \in C^\infty$, a bootstrap argument then yields higher regularity for u , but the higher regularity of F is needed. What happens if we just require F to be convex and uniformly elliptic?

Since F is convex, the expression (4.17) can be reformulated as a supremum of linear uniformly elliptic operators as

$$\sup_{a \in \mathcal{A}} L_a u = 0 \quad \text{in } B_1 \subset \mathbb{R}^n,$$

also known as Bellman equation (see (C.3) in the Appendix C), where each of the operators L_a is a linear uniformly elliptic operator.

The question that remains open here is:

What is the optimal regularity of solutions to Bellman equations?

In the simpler model of just two different operators, the previous equation is

$$(4.18) \quad \max\{L_1 u, L_2 u\} = 0 \quad \text{in } B_1 \subset \mathbb{R}^n.$$

The best known result in this direction was proved by Caffarelli, De Silva, and Savin in 2018, and establishes the optimal regularity of solutions to (4.18) in two dimensions:

Theorem 4.30 ([CDS18]). *Let u be any viscosity solution to (4.18) in $B_1 \subset \mathbb{R}^2$. Then*

$$\|u\|_{C^{2,1}(B_{1/2})} \leq C \|u\|_{L^\infty(B_1)},$$

for some constant C depending only on λ and Λ .

The approach used in [CDS18] to show this result does not work in higher dimensions $n \geq 3$, and thus the following question remains open:

Let u be any solution to (4.18), with $n \geq 3$. Is it true that $u \in C^{2,1}$?

— DRAFT —

The obstacle problem

In this last chapter we focus our attention on a third type of nonlinear elliptic PDE: a *free boundary problem*. In this kind of problems we are no longer only interested in the regularity of a solution u , but also in the study of an a priori unknown interphase Γ (the free boundary).

As explained later, there is a wide variety of problems in physics, industry, biology, finance, and other areas which can be described by PDEs that exhibit free boundaries. Many of such problems can be written as variational inequalities, for which the solution is obtained by minimizing a constrained energy functional. And one of the most important and canonical examples is the *obstacle problem*.¹

Given a smooth function φ , the obstacle problem is the following:

$$(5.1) \quad \text{minimize} \quad \frac{1}{2} \int_{\Omega} |\nabla v|^2 dx \quad \text{among all functions } v \geq \varphi.$$

Here, the minimization is subject to boundary conditions $v|_{\partial\Omega} = g$.

The interpretation of such problem is clear: One looks for the least energy function v , but the set of admissible functions consists only of functions that are above a certain “obstacle” φ .

In the two-dimensional case, one can think of the solution v as a “membrane” which is elastic and is constrained to be above φ (see Figure 5.1).

¹Other examples of important free boundary problems include the one-phase or Bernoulli problem, the thin or fractional obstacle problem, etc. We refer the interested reader to [CS05, PSU12, Vel23, Fer22] and the references therein.

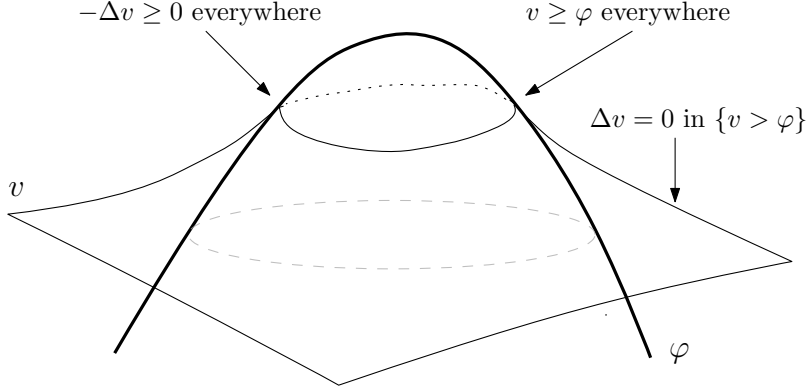

Figure 5.1. The function v minimizes the Dirichlet energy among all functions with the same boundary values situated above the obstacle.

The Euler–Lagrange equation of the minimization problem is the following:

$$(5.2) \quad \begin{cases} v \geq \varphi & \text{in } \Omega \\ \Delta v \leq 0 & \text{in } \Omega \\ \Delta v = 0 & \text{in the set } \{v > \varphi\}, \end{cases}$$

together with the boundary conditions $v|_{\partial\Omega} = g$.

Indeed, notice that if we denote $\mathcal{E}(v) = \frac{1}{2} \int_{\Omega} |\nabla v|^2 dx$, then we will have

$$\mathcal{E}(v + \varepsilon\eta) \geq \mathcal{E}(v) \quad \text{for every } \varepsilon \geq 0 \text{ and } \eta \geq 0, \eta \in C_c^\infty(\Omega),$$

which yields $\Delta v \leq 0$ in Ω . That is, we can perturb v with *nonnegative* functions ($\varepsilon\eta$) and we always get admissible functions ($v + \varepsilon\eta$). However, due to the constraint $v \geq \varphi$, we cannot perturb v with negative functions in all of Ω , but only in the set $\{v > \varphi\}$. This is why we get $\Delta v \leq 0$ *everywhere* in Ω , but $\Delta v = 0$ *only* in $\{v > \varphi\}$. (We will show later that any minimizer v of (5.1) is continuous, so that $\{v > \varphi\}$ is open.)

Alternatively, we may consider $u := v - \varphi$, and the problem is equivalent to

$$(5.3) \quad \begin{cases} u \geq 0 & \text{in } \Omega \\ \Delta u \leq f & \text{in } \Omega \\ \Delta u = f & \text{in the set } \{u > 0\}, \end{cases}$$

where $f := -\Delta\varphi$.

Such solution u can be obtained as follows:

$$(5.4) \quad \text{minimize } \int_{\Omega} \left\{ \frac{1}{2} |\nabla u|^2 + fu \right\} dx \quad \text{among all functions } u \geq 0.$$

In other words, we can make the *obstacle* just zero, by adding a *right-hand side* f . Here, the minimization is subject to the boundary conditions $u|_{\partial\Omega} = \tilde{g}$, with $\tilde{g} := g - \varphi$.

On the Euler–Lagrange equations. As said above, the Euler–Lagrange equations of the minimization problem (5.1) are:

- (i) $v \geq \varphi$ in Ω (v is *above* the *obstacle*).
- (ii) $\Delta v \leq 0$ in Ω (v is a *supersolution*).
- (iii) $\Delta v = 0$ in $\{v > \varphi\}$ (v is *harmonic* where it *does not touch* the obstacle).

These are inequalities, rather than a single PDE. Alternatively, one can write also the Euler–Lagrange equations in the following way:

$$\min\{-\Delta v, v - \varphi\} = 0 \quad \text{in } \Omega.$$

(Notice that this resembles a fully nonlinear equation $\min\{L_1 u, L_2 u\} = 0$, but in the present situation one of the two operators is of order zero.)

Of course, the same can be done for the equivalent problem (5.3). In that case, moreover, the minimization problem (5.4) is equivalent to

$$(5.5) \quad \text{minimize} \quad \int_{\Omega} \left\{ \frac{1}{2} |\nabla u|^2 + f u^+ \right\} dx,$$

where $u^+ = \max\{u, 0\}$. In this way, we can see the problem not as a constrained minimization but as a minimization problem with a *non-smooth* term u^+ in the functional. The Euler–Lagrange equation for this functional is then

$$(5.6) \quad \Delta u = f \chi_{\{u > 0\}} \quad \text{in } \Omega.$$

(Here, χ_A denotes the characteristic function of a set $A \subset \mathbb{R}^n$.) We will show this in detail later.

The free boundary. Let us take a closer look at the obstacle problem (5.3).

One of the most important features of such problem is that it has *two* unknowns: the *solution* u , and the *contact set* $\{u = 0\}$. In other words, there are two regions in Ω : one in which $u = 0$; and one in which $\Delta u = f$.

These regions are characterized by the minimization problem (5.4). Moreover, if we denote

$$\Gamma := \partial\{u > 0\} \cap \Omega,$$

then this is called the *free boundary*, see Figure 5.2.

The obstacle problem is a *free boundary problem*, as it involves an *unknown interface* Γ as part of the problem.

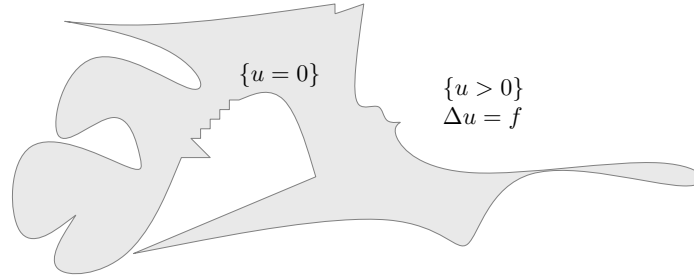

Figure 5.2. The free boundary could, a priori, be very irregular.

Moreover, it is not difficult to see that the fact that u is a nonnegative supersolution must imply $\nabla u = 0$ on Γ , that is, we will have that $u \geq 0$ solves

$$\begin{cases} \Delta u = f & \text{in } \{u > 0\} \\ u = 0 & \text{on } \Gamma \\ \nabla u = 0 & \text{on } \Gamma. \end{cases}$$

This is an alternative way to write the Euler–Lagrange equation of the problem. In this way, the interface Γ appears clearly, and we see that we have *both* Dirichlet *and* Neumann conditions on Γ .

This would usually be an over-determined problem (too many boundary conditions on Γ), but since Γ is also free, it turns out that the problem has a unique solution (where Γ is part of the solution, of course).

5.1. Some motivations and applications

Let us briefly comment on some of the main motivations and applications in the study of the obstacle problem, which are further developed in Appendix D (see also Appendix C). We refer to the books [DL76, KS80, Rod87, Fri88, PSU12], for more details and further applications of obstacle-type problems.

Fluid filtration. The so-called Dam problem aims to describe the filtration of water inside a porous dam. One considers a dam separating two reservoirs of water at different heights, made of a porous medium (permeable to water). Then there is some transfer of water across the dam, and the interior of the dam has a wet part, where water flows, and a dry part. In this setting, an integral of the pressure (with respect to the height of the column of water at each point) solves the obstacle problem, and the free boundary corresponds precisely to the interphase separating the wet and dry parts of the dam.

Phase transitions. The Stefan problem, dating back to the 19th century, is one of the most classical and important free boundary problems. It describes

the temperature of a homogeneous medium undergoing a phase change, typically a body of ice at zero degrees submerged in water.

In this context, it turns out that the integral of the temperature $\theta(x, t)$, namely $u(x, t) := \int_0^t \theta$, solves the parabolic version of the obstacle problem,

$$\begin{cases} u_t - \Delta u = \chi_{\{u>0\}} & \text{in } \Omega \times (0, T) \subset \mathbb{R}^3 \times \mathbb{R}, \\ \partial_t u \geq 0, \\ u \geq 0. \end{cases}$$

The moving interphase separating the solid and liquid is exactly the free boundary $\partial\{u > 0\}$.

Hele-Shaw flow. This two-dimensional model, dating back to 1898, describes a fluid flow between two flat parallel plates separated by a very thin gap. Various problems in fluid mechanics can be approximated to Hele-Shaw flows, and that is why understanding these flows is important.

A Hele-Shaw cell is an experimental device in which a viscous fluid is sandwiched in a narrow gap between two parallel plates. In certain regions, the gap is filled with fluid while in others the gap is filled with air. When liquid is injected inside the device through some sinks (e.g. through a small hole on the top plate) the region filled with liquid grows. In this context, an integral of the pressure solves, for each fixed time t , the obstacle problem. In a similar way to the Dam problem, the free boundary corresponds to the interface between the fluid and the air regions.

Optimal stopping, finance. In probability and finance, the obstacle problem appears when considering optimal stopping problems for stochastic processes.

Indeed, consider a random walk (Brownian motion) inside a domain $\Omega \subset \mathbb{R}^n$, and a payoff function φ defined on the same domain. We can stop the random walk at any moment, and we get the payoff at that position. We want to maximize the expected payoff (by choosing appropriately the stopping strategy). Then, it turns out that the highest expected payoff $v(x)$ starting at a given position x satisfies the obstacle problem (5.2), where the contact set $\{v = \varphi\}$ is the region where we should immediately stop the random walk and get the payoff, while $\{v > \varphi\}$ is the region where we should wait (see Appendix C for more details).

Interacting particle systems. Large systems of interacting particles arise in physical, biological, or material sciences.

In some models, the particles attract each other when they are far, and experience a repulsive force when they are close. In other related models in statistical mechanics, the particles (e.g. electrons) repel with a Coulomb

force and one wants to understand their behavior in presence of some external field that confines them.

In this kind of models, a natural and interesting question is to determine the “equilibrium configurations”. For instance, in Coulomb systems the charges accumulate in some region with a well defined boundary. Interestingly, these problems are equivalent to the obstacle problem — namely, the electric potential $u = u(x)$ generated by the charges solves such problem — and the contact set $\{u = 0\}$ corresponds to the region in which the particles concentrate.

Quasi-Steady Electrochemical Shaping. Consider a metal inside an electrolyte under the action of an electric potential, in such a way that the metal shrinks with time due to a chemical reaction. Then, the integral (in time) of the potential satisfies, for each fixed time, the obstacle problem, whose free boundary corresponds to the shape of the metal at that moment.

Heat control. Trying to automatically control the temperature of a room using only heating devices, under suitable conditions, also yields the obstacle problem (in this case, for the temperature). Here, the free boundary separates the region where the heating devices are active and where they are not.

Elasticity. Finally, in elasticity theory we probably find the most visual representation of the obstacle problem. Given a thin membrane that is affected only by tension forces (thus tries to minimize area), it *approximately* satisfies the obstacle problem, where the contact region is the area where the membrane touches the obstacle.

5.2. Basic properties of solutions I

We proceed now to study the basic properties of solutions to the obstacle problem: existence of solutions, optimal regularity, and nondegeneracy.

We will first study all these properties for minimizers $v \geq \varphi$ of (5.1), and then in the next section we will study independently minimizers $u \geq 0$ of (5.4) or (5.5).

This is not only for completeness and clarity of presentation, but also to have both points of view. For instance, the proof of the optimal regularity of solutions can be done in two completely different ways, one for each of the settings.

Existence of solutions. Existence and uniqueness of solutions follows easily from the fact that the functional $\int_{\Omega} |\nabla v|^2 dx$ is convex, and that we want to minimize it in the closed convex set $\{v \in H^1(\Omega) : v \geq \varphi\}$.

Recall that $w|_{\partial\Omega}$ denotes the trace of w on $\partial\Omega$ whenever it is defined.

Proposition 5.1 (Existence and uniqueness). *Let $\Omega \subset \mathbb{R}^n$ be any bounded Lipschitz domain, and let $g : \partial\Omega \rightarrow \mathbb{R}$ and $\varphi \in H^1(\Omega)$ be such that*

$$\mathcal{C} = \{w \in H^1(\Omega) : w \geq \varphi \text{ in } \Omega, w|_{\partial\Omega} = g\} \neq \emptyset.$$

Then, there exists a unique minimizer of $\int_{\Omega} |\nabla v|^2 dx$ among all functions $v \in H^1(\Omega)$ satisfying $v \geq \varphi$ in Ω and $v|_{\partial\Omega} = g$.

Proof. The proof is quite similar to that of Theorem 1.10. Indeed, let

$$\theta_{\circ} := \inf \left\{ \frac{1}{2} \int_{\Omega} |\nabla w|^2 dx : w \in H^1(\Omega), w|_{\partial\Omega} = g, w \geq \varphi \text{ in } \Omega \right\},$$

that is, the infimum value of $\mathcal{E}(w) = \frac{1}{2} \int_{\Omega} |\nabla w|^2 dx$ among all admissible functions w .

Let us take a sequence of functions $\{v_k\}$ such that

- $v_k \in H^1(\Omega)$
- $v_k|_{\partial\Omega} = g$ and $v_k \geq \varphi$ in Ω .
- $\mathcal{E}(v_k) \rightarrow \theta_{\circ}$ as $k \rightarrow \infty$.

By the Poincaré inequality (Theorem 1.6), the sequence $\{v_k\}$ is uniformly bounded in $H^1(\Omega)$, and therefore a subsequence $\{v_{k_j}\}$ will converge to a certain function v strongly in $L^2(\Omega)$ and weakly in $H^1(\Omega)$. Moreover, by compactness of the trace operator (see **(S5)** in Chapter 1), we will have $v_{k_j}|_{\partial\Omega} \rightarrow v|_{\partial\Omega}$ in $L^2(\partial\Omega)$, so that $v|_{\partial\Omega} = g$. Furthermore, such function v will satisfy $\mathcal{E}(v) \leq \liminf_{j \rightarrow \infty} \mathcal{E}(v_{k_j})$ (by (1.4)-(1.5) from **(S4)** in Chapter 1), and therefore it will be a minimizer of the energy functional. Since $v_{k_j} \geq \varphi$ in Ω and $v_{k_j} \rightarrow v$ in $L^2(\Omega)$, we have $v \geq \varphi$ in Ω . Thus, we have proved the existence of a minimizer v .

The uniqueness of the minimizer follows from the strict convexity of the functional $\mathcal{E}(v)$, exactly as in Theorem 1.10. \square

As in the case of harmonic functions, it is easy to show that if a function v satisfies

$$\begin{cases} v \geq \varphi & \text{in } \Omega \\ \Delta v \leq 0 & \text{in } \Omega \\ \Delta v = 0 & \text{in the set } \{v > \varphi\}, \end{cases}$$

then it must actually be the minimizer of the functional.

There are two alternative ways to construct the solution to the obstacle problem: as the “least supersolution above the obstacle”, or with a “penalized problem”. Let us briefly describe them.

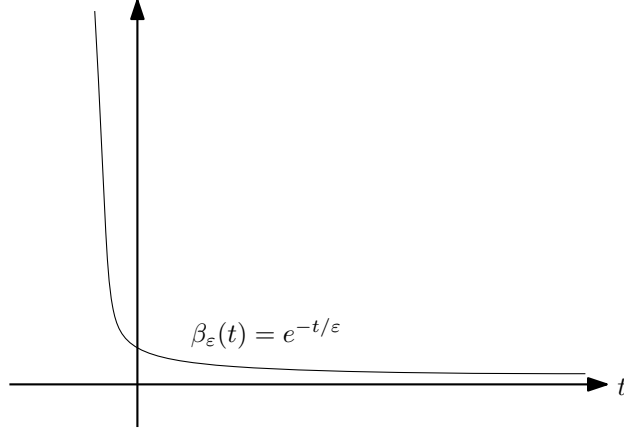

Figure 5.3. The function $\beta_\varepsilon \rightarrow \beta_0$ as $\varepsilon \downarrow 0$.

- Least supersolution: This is related to the existence of viscosity solutions described in Chapter 4. Indeed, we consider

$$v(x) := \inf \left\{ w(x) : w \in C(\bar{\Omega}), -\Delta w \geq 0 \text{ in } \Omega, w \geq \varphi \text{ in } \Omega, w|_{\partial\Omega} \geq g \right\}.$$

Here, the inequality $-\Delta w \geq 0$ in Ω has to be understood in the viscosity sense.

Then, as in Perron's method (recall Chapters 1 and 4), it turns out that v is itself a continuous supersolution, it satisfies $\Delta v = 0$ in $\{v > \varphi\}$, and thus it solves the obstacle problem. Therefore,

$$\left\{ \begin{array}{c} \text{least} \\ \text{supersolution} \end{array} \right\} \longleftrightarrow \left\{ \begin{array}{c} \text{minimizer of} \\ \text{the functional} \end{array} \right\}.$$

- Penalized problem: We consider $\beta_\varepsilon : \mathbb{R} \rightarrow \mathbb{R}$ smooth and convex, converging to

$$\beta_0(t) := \begin{cases} 0 & \text{if } t \geq 0 \\ \infty & \text{if } t < 0. \end{cases}$$

We may take for example $\beta_\varepsilon(t) := e^{-t/\varepsilon}$, see Figure 5.3.

Then, we minimize the functional

$$J_\varepsilon(v) := \frac{1}{2} \int_{\Omega} |\nabla v|^2 dx + \int_{\Omega} \beta_\varepsilon(v - \varphi) dx,$$

subject to the appropriate boundary conditions on $\partial\Omega$, and get a solution $v_\varepsilon \in C^\infty$ of $\Delta v_\varepsilon = \beta'_\varepsilon(v_\varepsilon - \varphi)$ in Ω .

Since $\beta'_\varepsilon \leq 0$ everywhere, and $\beta'_\varepsilon(t) = 0$ for $t \geq 0$, we have

$$\begin{cases} -\Delta v_\varepsilon \geq 0 & \text{everywhere in } \Omega \\ \Delta v_\varepsilon = 0 & \text{in } \{v_\varepsilon > \varphi\}. \end{cases}$$

As $\varepsilon \rightarrow 0$, we have $v_\varepsilon \rightarrow v$, where v is the solution to the obstacle problem. We refer to [PSU12] for more details.

Basic properties of solutions. Let us next prove that any minimizer v of (5.1) is actually continuous and solves (5.2).

From now on we will “forget” about the regularity of the obstacle, and assume that it is as smooth as needed. This is why we will always be dealing with obstacles $\varphi \in C^\infty(\Omega)$. One gets analogous results under much weaker regularity assumptions on φ , which depend on the type of result to be proved. The role of the regularity of the obstacle is beyond the scope of this book, and thus we will always assume φ to be smooth.

We start with the following lemma.

Lemma 5.2. *Let $\Omega \subset \mathbb{R}^n$ be any bounded Lipschitz domain, $\varphi \in C^\infty(\Omega)$, and $v \in H^1(\Omega)$ be any minimizer of (5.1) subject to the boundary conditions $v|_{\partial\Omega} = g$.*

Then, $-\Delta v \geq 0$ in Ω .

Proof. Let

$$\mathcal{E}(v) = \frac{1}{2} \int_{\Omega} |\nabla v|^2 dx.$$

Then, since v minimizes \mathcal{E} among all functions above the obstacle φ (and with fixed boundary conditions on $\partial\Omega$), we have that

$$\mathcal{E}(v + \varepsilon\eta) \geq \mathcal{E}(v) \quad \text{for every } \varepsilon \geq 0 \text{ and } \eta \geq 0, \eta \in C_c^\infty(\Omega).$$

This yields

$$\varepsilon \int_{\Omega} \nabla v \cdot \nabla \eta + \frac{\varepsilon^2}{2} \int_{\Omega} |\nabla \eta|^2 dx \geq 0 \quad \text{for every } \varepsilon \geq 0 \text{ and } \eta \geq 0, \eta \in C_c^\infty(\Omega),$$

and thus

$$\int_{\Omega} \nabla v \cdot \nabla \eta \geq 0 \quad \text{for every } \eta \geq 0, \eta \in C_c^\infty(\Omega).$$

This means that $-\Delta v \geq 0$ in Ω in the weak sense, as desired. \square

From here, by showing first that $\{v > \varphi\}$ is open, we obtain the Euler–Lagrange equations for the functional:

Proposition 5.3. *Let $\Omega \subset \mathbb{R}^n$ be any bounded Lipschitz domain, $\varphi \in C^\infty(\Omega)$, and $v \in H^1(\Omega)$ be any minimizer of (5.1) subject to the boundary conditions $v|_{\partial\Omega} = g$.*

Then, $v \in C(\Omega)$ and it satisfies

$$(5.7) \quad \begin{cases} v \geq \varphi & \text{in } \Omega \\ \Delta v \leq 0 & \text{in } \Omega \\ \Delta v = 0 & \text{in } \{v > \varphi\} \cap \Omega. \end{cases}$$

Proof. By construction, we already know that $v \geq \varphi$ in Ω and, thanks to Lemma 5.2, $-\Delta v \geq 0$ in Ω , i.e. v is (weakly) superharmonic. Up to replacing v in a set of measure zero, we may also assume that v is lower semi-continuous (by Lemma 1.17). Thus, we only need to prove that $\Delta v = 0$ in $\{v > \varphi\} \cap \Omega$ and that v is, in fact, continuous.

In order to do that, let us show first that $\{v > \varphi\} \cap \Omega$ is open. Let $x_o \in \{v > \varphi\} \cap \Omega$ be such that $v(x_o) - \varphi(x_o) > \varepsilon_o > 0$. Since v is lower semi-continuous and φ is continuous, there exists some $\delta > 0$ such that $v(x) - \varphi(x) > \varepsilon_o/2$ for all $x \in B_\delta(x_o)$, and hence $B_\delta(x_o) \subset \{v > \varphi\}$. Since x_o was arbitrary, this means that $\{v > \varphi\}$ is open. This implies, also, that $\Delta v = 0$ weakly in $\{v > \varphi\} \cap \Omega$. Indeed, for any $x_o \in \{v > \varphi\}$ and $\eta \in C_c^\infty(B_\delta(x_o))$ with $|\eta| \leq 1$, we have $v \pm \varepsilon\eta \geq \varphi$ in Ω for all $|\varepsilon| < \varepsilon_o/2$, and therefore it is an admissible competitor to the minimization problem. Thus, we have $\mathcal{E}(v + \varepsilon\eta) \geq \mathcal{E}(v)$ for all $|\varepsilon| < \varepsilon_o$, and differentiating in ε we deduce that v is harmonic in $\{v > \varphi\} \cap \Omega$.

Finally, let us show that v is continuous. We already know, by the regularity of harmonic functions (e.g. Corollary 1.12), that v is continuous in $\{v > \varphi\} \cap \Omega$. Let us now show that v is continuous in $\{v = \varphi\} \cap \Omega$ as well.

Let $y_o \in \{v = \varphi\} \cap \Omega$, and let us argue by contradiction. That is, since v is lower semi-continuous, let us assume that there is a sequence $y_k \rightarrow y_o$ such that $v(y_k) \rightarrow v(y_o) + \varepsilon_o = \varphi(y_o) + \varepsilon_o$ for some $\varepsilon_o > 0$. Since φ is continuous, we may assume also that $y_k \in \{v > \varphi\}$. Let us denote by z_k the projection of y_k towards $\{v = \varphi\}$, so that $\delta_k := |z_k - y_o| \leq 2|y_k - y_o| \downarrow 0$ and $v(z_k) \rightarrow v(y_o) = \varphi(y_o)$. Now, since v is superharmonic by (1.20),

$$v(z_k) \geq \int_{B_{2\delta_k}(y_k)} v = (1 - 2^{-n}) \int_{B_{2\delta_k}(y_k) \setminus B_{\delta_k}(y_k)} v + 2^{-n} \int_{B_{\delta_k}(y_k)} v = I_1 + I_2.$$

Observe that, for the first term, since v is lower semi-continuous and $\delta_k \downarrow 0$, we can assume that, for k large enough, $v \geq \varphi(y_o) - 2^{-n}\varepsilon_o$ in $B_{2\delta_k}$, so that $I_1 \geq (1 - 2^{-n})[\varphi(y_o) - 2^{-n}\varepsilon_o]$. On the other hand, since v is harmonic in $B_{\delta_k}(y_k)$, we have by the mean-value property that $I_2 = 2^{-n}v(y_k)$. Combining everything, we get

$$v(z_k) \geq (1 - 2^{-n})[\varphi(y_o) - 2^{-n}\varepsilon_o] + 2^{-n}v(y_k) \rightarrow \varphi(y_o) + 2^{-2n}\varepsilon_o$$

which contradicts the fact that we had $v(z_k) \rightarrow v(y_o) = \varphi(y_o)$. Hence, v is continuous in Ω . \square

We next prove the following result, which says that v can be characterized as the least supersolution above the obstacle.

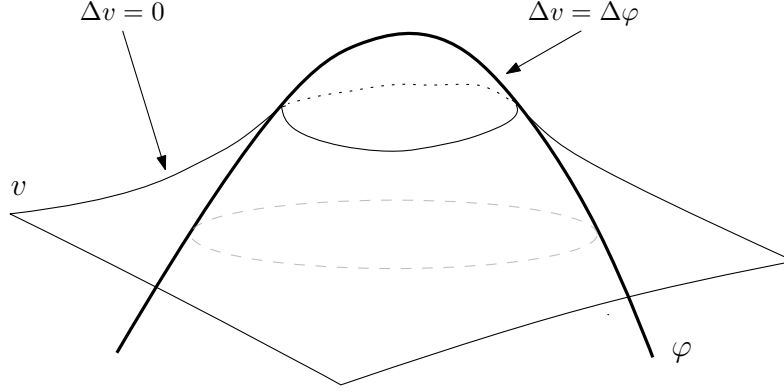

Figure 5.4. Second derivatives are in general discontinuous across the free boundary.

Proposition 5.4 (Least supersolution). *Let $\Omega \subset \mathbb{R}^n$ be any bounded Lipschitz domain, $\varphi \in H^1(\Omega)$, and $v \in H^1(\Omega)$ be any minimizer of (5.1) subject to the boundary conditions $v|_{\partial\Omega} = g$.*

Then, for any function w satisfying $-\Delta w \geq 0$ in Ω , $w \geq \varphi$ in Ω , and $w|_{\partial\Omega} \geq v|_{\partial\Omega}$, we have $w \geq v$ in Ω . In other words, if w is any supersolution above the obstacle φ , then $w \geq v$.

Proof. If w is any function satisfying $-\Delta w \geq 0$ in Ω , $w \geq \varphi$ in Ω , and $w|_{\partial\Omega} \geq v|_{\partial\Omega}$, it simply follows from the maximum principle (Proposition 1.13) that $w \geq v$. Indeed, we have $-\Delta w \geq -\Delta v$ in $\Omega \cap \{v > \varphi\}$, and on the boundary of such set we have $w|_{\partial\Omega} \geq v|_{\partial\Omega}$ and $w \geq \varphi = v$ on $\{v = \varphi\}$. \square

Optimal regularity of solutions. Thanks to Proposition 5.3, we know that any minimizer of (5.1) is continuous and solves (5.7). From now on, we will actually localize the problem and study it in a ball:

$$(5.8) \quad \begin{cases} v \geq \varphi & \text{in } B_1 \\ \Delta v \leq 0 & \text{in } B_1 \\ \Delta v = 0 & \text{in } \{v > \varphi\} \cap B_1. \end{cases}$$

Our next goal is to answer the following question:

Question: *What is the optimal regularity of solutions?*

First, a few important considerations. Notice that in the set $\{v > \varphi\}$ we have $\Delta v = 0$, while in the interior of $\{v = \varphi\}$ we have $\Delta v = \Delta\varphi$ (since $v = \varphi$ there); see Figure 5.4.

Thus, since $\Delta\varphi$ is in general not zero, Δv is *discontinuous* across the free boundary $\partial\{v > \varphi\}$ in general. In particular, $v \notin C^2$.

We will now prove that any minimizer of (5.1) is actually $C^{1,1}$, which gives the:

Answer: $v \in C^{1,1}$ (second derivatives are bounded but not continuous)

The precise statement and proof are given next.

Theorem 5.5 (Optimal regularity). *Let $\varphi \in C^\infty(B_1)$, and v be any solution to (5.8). Then, v is $C^{1,1}$ in $B_{1/2}$, with the estimate*

$$\|v\|_{C^{1,1}(B_{1/2})} \leq C(\|v\|_{L^\infty(B_1)} + \|\varphi\|_{C^{1,1}(B_1)}).$$

The constant C depends only on n .

To prove this, the main step is the following.

Lemma 5.6. *Let $\varphi \in C^\infty(B_1)$, and v be any solution to (5.8). Let $x_o \in \overline{B_{1/2}}$ be any point on $\{v = \varphi\}$.*

Then, for any $r \in (0, \frac{1}{4})$ we have

$$0 \leq \sup_{B_r(x_o)} (v - \varphi) \leq Cr^2,$$

with C depending only on n and $\|\varphi\|_{C^{1,1}(B_1)}$.

Proof. After dividing v by a constant if necessary, we may assume that $\|\varphi\|_{C^{1,1}(B_1)} \leq 1$.

Let $\ell(x) := \varphi(x_o) + \nabla\varphi(x_o) \cdot (x - x_o)$ be the linear part of φ at x_o . Let $r \in (0, \frac{1}{4})$. Then, by $C^{1,1}$ regularity of φ , in $B_r(x_o)$ we have

$$\ell(x) - r^2 \leq \varphi(x) \leq v(x).$$

We want to show that, in the ball $B_r(x_o)$ (see Figure 5.5), we have

$$v(x) \leq \ell(x) + Cr^2.$$

For this, consider

$$w(x) := v(x) - [\ell(x) - r^2].$$

This function w satisfies $w \geq 0$ in $B_r(x_o)$, and $-\Delta w = -\Delta v \geq 0$ in $B_r(x_o)$.

Let us split w into

$$w = w_1 + w_2,$$

with

$$\begin{cases} \Delta w_1 = 0 & \text{in } B_r(x_o) \\ w_1 = w & \text{on } \partial B_r(x_o) \end{cases} \quad \text{and} \quad \begin{cases} -\Delta w_2 \geq 0 & \text{in } B_r(x_o) \\ w_2 = 0 & \text{on } \partial B_r(x_o). \end{cases}$$

Notice that

$$0 \leq w_1 \leq w \quad \text{and} \quad 0 \leq w_2 \leq w.$$

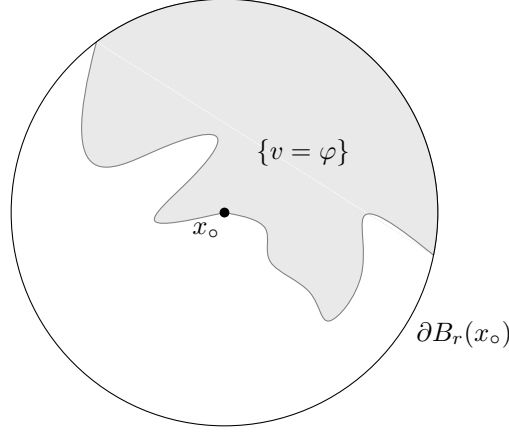

Figure 5.5. The solution v and a free boundary point x_o

We have that

$$w_1(x_o) \leq w(x_o) = v(x_o) - [\ell(x_o) - r^2] = r^2,$$

and thus by the Harnack inequality

$$\|w_1\|_{L^\infty(B_{r/2}(x_o))} \leq Cr^2.$$

For w_2 , notice that $\Delta w_2 = \Delta v$, and in particular $\Delta w_2 = 0$ in $\{v > \varphi\}$. This means that w_2 attains its maximum on $\{v = \varphi\}$. But in the set $\{v = \varphi\}$ we have

$$w_2 \leq w = \varphi - [\ell - r^2] \leq Cr^2,$$

and therefore we deduce that

$$\|w_2\|_{L^\infty(B_r(x_o))} \leq Cr^2.$$

Combining the bounds for w_1 and w_2 , we get $\|w\|_{L^\infty(B_r(x_o))} \leq Cr^2$. Translating this into v , and using that $\|\varphi\|_{C^{1,1}(B_1)} \leq 1$, we find $v - \varphi \leq Cr^2$ in $B_{r/2}(x_o)$. \square

Therefore, we have proved that:

At every free boundary point x_o , v separates from φ at most quadratically.

As shown next, this easily implies the $C^{1,1}$ regularity.

Proof of Theorem 5.5. Dividing v by a constant if necessary, we may assume that $\|v\|_{L^\infty(B_1)} + \|\varphi\|_{C^{1,1}(B_1)} \leq 1$.

We already know that $v \in C^\infty$ in the set $\{v > \varphi\}$ (since v is harmonic), and also in the interior of the set $\{v = \varphi\}$ (since $\varphi \in C^\infty$). Moreover, on the interface $\Gamma = \partial\{v > \varphi\}$ we have proved the quadratic growth $\sup_{B_r(x_o)}(v - \varphi) \leq Cr^2$. Let us prove that this yields the $C^{1,1}$ bound we want.

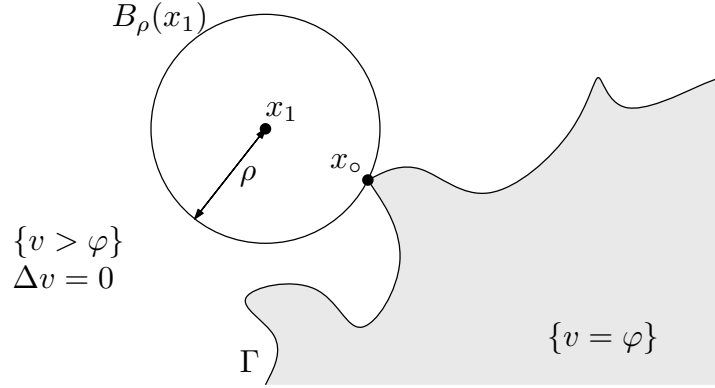

Figure 5.6. A solution v satisfying $\Delta v = 0$ in $B_\rho(x_1) \subset \{v > \varphi\}$.

Let $x_1 \in \{v > \varphi\} \cap B_{1/2}$, and let $x_0 \in \Gamma$ be the closest free boundary point. Denote $\rho = |x_1 - x_0|$. Then, we have $\Delta v = 0$ in $B_\rho(x_1)$ (see the setting in Figure 5.6), and thus we have also $\Delta(v - \ell) = 0$ in $B_\rho(x_1)$, where ℓ is the linear part of φ at x_0 .

By estimates for harmonic functions, we find

$$\|D^2 v\|_{L^\infty(B_{\rho/2}(x_1))} = \|D^2(v - \ell)\|_{L^\infty(B_{\rho/2}(x_1))} \leq \frac{C}{\rho^2} \|v - \ell\|_{L^\infty(B_\rho(x_1))}.$$

But by the growth proved in the previous Lemma, we have $\|v - \ell\|_{L^\infty(B_\rho(x_1))} \leq C\rho^2$, which yields

$$\|D^2 v\|_{L^\infty(B_{\rho/2}(x_1))} \leq \frac{C}{\rho^2} \rho^2 = C.$$

In particular, $|D^2 v(x_1)| \leq C$. We can do this for all $x_1 \in \{v > \varphi\} \cap B_{1/2}$, and on $\partial\{v > \varphi\}$ we have quadratic growth by Lemma 5.6, hence it follows that $\|v\|_{C^{1,1}(B_{1/2})} \leq C$, as wanted. \square

The overall strategy of the proof of optimal regularity is summarized in Figure 5.7.

Nondegeneracy. We now want to prove that, at all free boundary points, v separates from φ *at least* quadratically (we already know *at most* quadratically).

That is, we want

$$(5.9) \quad 0 < cr^2 \leq \sup_{B_r(x_0)} (v - \varphi) \leq Cr^2$$

for all free boundary points $x_0 \in \partial\{v > \varphi\}$.

This property is essential in order to study the free boundary later.

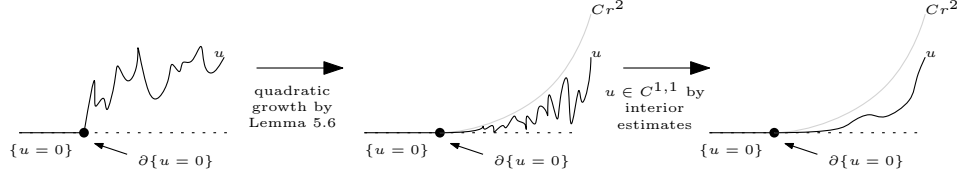

Figure 5.7. Strategy of the proof of Theorem 5.5.

Remark 5.7. Since $-\Delta v \geq 0$ everywhere, it is clear that if $x_o \in \partial\{v > \varphi\}$ is a free boundary point, then necessarily $-\Delta\varphi(x_o) \geq 0$ (otherwise we would have $-\Delta\varphi(x_o) < 0$, and since u touches φ from above at x_o , also $-\Delta v(x_o) < 0$, a contradiction).

Moreover it can be proved that, in fact, if $\Delta\varphi$ and $\nabla\Delta\varphi$ do *not* vanish simultaneously, then $-\Delta\varphi > 0$ near *all* free boundary points [Caf98].

This motivates the following:

Assumption: *The obstacle φ satisfies*

$$-\Delta\varphi \geq c_o > 0$$

in the ball B_1 .

In particular, by Remark 5.7, if $\Delta\varphi$ and $\nabla\Delta\varphi$ do not vanish simultaneously, then we have $-\Delta\varphi > 0$ near any free boundary point, and thus by zooming in if necessary, we will always have that the assumption is satisfied in B_1 , for some small $c_o > 0$.

Thus, the only real assumption here is that $\Delta\varphi$ and $\nabla\Delta\varphi$ do not vanish simultaneously, which is a very mild assumption. Moreover, this is in a sense a *necessary* assumption: without this, the nondegeneracy (5.9) does *not* hold, and no regularity result can be proved for the free boundary. (Without the assumption, one can actually construct counterexamples in which the free boundary is a fractal set with infinite perimeter.)

Proposition 5.8 (Nondegeneracy). *Let $\varphi \in C^\infty(B_1)$, and v be any solution to (5.8). Assume that φ satisfies $-\Delta\varphi \geq c_o > 0$ in B_1 . Then, for every free boundary point $x_o \in \partial\{v > \varphi\} \cap B_{1/2}$, we have*

$$0 < cr^2 \leq \sup_{B_r(x_o)} (v - \varphi) \leq Cr^2 \quad \text{for all } r \in (0, \frac{1}{4}),$$

with a constant $c > 0$ depending only on n and c_o .

Proof. Let $x_1 \in \{v > \varphi\}$ be any point close to x_o (we will then let $x_1 \rightarrow x_o$ at the end of the proof).

Consider the function

$$w(x) := v(x) - \varphi(x) - \frac{c_0}{2n}|x - x_1|^2.$$

Then, in $\{v > \varphi\}$ we have

$$\Delta w = \Delta v - \Delta \varphi - c_0 = -\Delta \varphi - c_0 \geq 0$$

and hence $-\Delta w \leq 0$ in $\{v > \varphi\} \cap B_r(x_1)$. Moreover, $w(x_1) > 0$.

By the maximum principle, w attains a positive maximum on $\partial(\{v > \varphi\} \cap B_r(x_1))$. But on the free boundary $\partial\{v > \varphi\}$ we clearly have $w < 0$. Therefore, there is a point on $\partial B_r(x_1)$ at which $w > 0$. In other words,

$$0 < \sup_{\partial B_r(x_1)} w = \sup_{\partial B_r(x_1)} (v - \varphi) - \frac{c_0}{2n} r^2.$$

Letting now $x_1 \rightarrow x_0$, we find $\sup_{\partial B_r(x_0)} (v - \varphi) \geq cr^2 > 0$, as desired. \square

Summary of basic properties. Let v be any solution to the obstacle problem

$$\begin{cases} v \geq \varphi & \text{in } B_1 \\ \Delta v \leq 0 & \text{in } B_1 \\ \Delta v = 0 & \text{in } \{v > \varphi\} \cap B_1. \end{cases}$$

Then, we have:

- Optimal regularity: $\|v\|_{C^{1,1}(B_{1/2})} \leq C(\|v\|_{L^\infty(B_1)} + \|\varphi\|_{C^{1,1}(B_1)})$
- Nondegeneracy: If $-\Delta \varphi \geq c_0 > 0$, then

$$0 < cr^2 \leq \sup_{B_r(x_0)} (v - \varphi) \leq Cr^2 \quad \text{for all } r \in (0, \frac{1}{2})$$

at all free boundary points $x_0 \in \partial\{v > \varphi\} \cap B_{1/2}$.

- Equivalence with zero obstacle: The problem is equivalent to

$$\begin{cases} u \geq 0 & \text{in } B_1 \\ \Delta u \leq f & \text{in } B_1 \\ \Delta u = f & \text{in } \{u > 0\} \cap B_1, \end{cases}$$

where $f = -\Delta \varphi \geq c_0 > 0$.

We will next provide an alternative approach to the optimal regularity.

5.3. Basic properties of solutions II

We proceed now to study the basic properties of solutions $u \geq 0$ to the obstacle problem (5.4) or (5.5). As explained before, the main point here is that we prove optimal regularity independently from the previous Section.

Throughout this section we will always assume

$$f \geq 0 \quad \text{in } \Omega.$$

Existence of solutions. Since problem (5.4) is equivalent to (5.1), existence and uniqueness of solutions follow easily from Proposition 5.1, as shown next.

Proposition 5.9 (Existence and uniqueness). *Let $\Omega \subset \mathbb{R}^n$ be any bounded Lipschitz domain, and let $g : \partial\Omega \rightarrow \mathbb{R}$ be such that*

$$C = \{u \in H^1(\Omega) : u \geq 0 \text{ in } \Omega, u|_{\partial\Omega} = g\} \neq \emptyset.$$

Then, for any $f \in L^2(\Omega)$ there exists a unique minimizer of

$$\frac{1}{2} \int_{\Omega} |\nabla u|^2 dx + \int_{\Omega} f u$$

among all functions $u \in H^1(\Omega)$ satisfying $u \geq 0$ in Ω and $u|_{\partial\Omega} = g$.

Proof. We follow the proof of Proposition 5.1. Let

$$\theta_{\circ} := \inf \left\{ \frac{1}{2} \int_{\Omega} |\nabla w|^2 dx + \int_{\Omega} f w : w \in H^1(\Omega), w|_{\partial\Omega} = g, w \geq 0 \text{ in } \Omega \right\},$$

that is, the infimum value of $\mathcal{E}(w) = \frac{1}{2} \int_{\Omega} |\nabla w|^2 dx + \int_{\Omega} f w$ among all admissible functions w . Notice that, by Hölder's inequality, $\mathcal{E}(w) < +\infty$ if $w \in H^1(\Omega)$.

We take again a sequence of functions $\{v_k\}$ such that $v_k \in H^1(\Omega)$, $v_k|_{\partial\Omega} = g$, $v_k \geq 0$ in Ω , and $\mathcal{E}(v_k) \rightarrow \theta_{\circ}$ as $k \rightarrow \infty$. By the Poincaré inequality (Theorem 1.6), Hölder's inequality, and the fact that $\mathcal{E}(v_k) \leq \theta_{\circ} + 1$, for k large enough

$$\begin{aligned} \|v_k\|_{H^1(\Omega)}^2 &\leq C \left(\int_{\Omega} |\nabla v_k|^2 + \int_{\partial\Omega} g^2 \right) \leq C \left(\theta_{\circ} + 1 + \int_{\Omega} |f v_k| + \frac{1}{2} \int_{\partial\Omega} g^2 \right) \\ &\leq C \left(\theta_{\circ} + 1 + \|f\|_{L^2(\Omega)} \|v_k\|_{H^1(\Omega)} + \frac{1}{2} \int_{\partial\Omega} g^2 \right). \end{aligned}$$

In particular, $\|v_k\|_{H^1(\Omega)} \leq C$ for some constant C depending only on n , Ω , g , f , and θ_{\circ} (recall that $g \in L^2(\partial\Omega)$ by the trace theorem, **(S5)** in Chapter 1). Hence, a subsequence $\{v_{k_j}\}$ converges to a certain function v strongly in $L^2(\Omega)$ and weakly in $H^1(\Omega)$. By compactness of the trace operator $v_{k_j}|_{\partial\Omega} \rightarrow v|_{\partial\Omega} = g$ in $L^2(\partial\Omega)$. Furthermore, v satisfies $\mathcal{E}(v) \leq \liminf_{j \rightarrow \infty} \mathcal{E}(v_{k_j})$ (by (1.4)-(1.5) from **(S4)** and weak convergence), and therefore it will be a

minimizer of the energy functional. Since $v_{k_j} \geq 0$ in Ω and $v_{k_j} \rightarrow v$ in $L^2(\Omega)$, we have $v \geq 0$ in Ω . Thus, there is a minimizer v .

The uniqueness of the minimizer follows from the strict convexity of the functional $\mathcal{E}(v)$, exactly as in Theorem 1.10. \square

Remark 5.10. Alternatively, we could have denoted $v := u + \varphi$ with φ such that $-\Delta\varphi = f$ in Ω , and use Proposition 5.1.

Furthermore, we have the following equivalence. (Recall that we denote $u^+ = \max\{u, 0\}$, and $u^- = \max\{-u, 0\}$, so that $u = u^+ - u^-$.)

Proposition 5.11. *Let $\Omega \subset \mathbb{R}^n$ be any bounded Lipschitz domain, and let $g : \partial\Omega \rightarrow \mathbb{R}$ be such that*

$$\mathcal{C} = \{u \in H^1(\Omega) : u \geq 0 \text{ in } \Omega, u|_{\partial\Omega} = g\} \neq \emptyset.$$

Then, the following are equivalent.

- (i) u minimizes $\frac{1}{2} \int_{\Omega} |\nabla u|^2 + \int_{\Omega} f u$ among all functions satisfying $u \geq 0$ in Ω and $u|_{\partial\Omega} = g$.
- (ii) u minimizes $\frac{1}{2} \int_{\Omega} |\nabla u|^2 + \int_{\Omega} f u^+$ among all functions satisfying $u|_{\partial\Omega} = g$.

Proof. The two functionals coincide whenever $u \geq 0$. Thus, the only key point is to prove that the minimizer in (ii) must be nonnegative, i.e., $u = u^+$. (Notice that $\mathcal{C} \neq \emptyset$ implies that $g \geq 0$ on $\partial\Omega$.) To show this, recall that the positive part of any H^1 function is still in H^1 , and moreover $|\nabla u|^2 = |\nabla u^+|^2 + |\nabla u^-|^2$ (see **(S9)** in Chapter 1). Thus, we have that (recall that $f \geq 0$ in Ω)

$$\frac{1}{2} \int_{\Omega} |\nabla u^+|^2 + \int_{\Omega} f u^+ \leq \frac{1}{2} \int_{\Omega} |\nabla u|^2 + \int_{\Omega} f u^+,$$

with strict inequality unless $u = u^+$. This means that any minimizer u of the functional in (ii) must be nonnegative, and thus we are done. \square

Basic properties of solutions. Let us next prove that any minimizer of (5.4) is actually a solution to (5.10) below.

We recall that we are always assuming that obstacles are as smooth as necessary, $\varphi \in C^\infty(\Omega)$, and therefore we assume here that $f \in C^\infty(\Omega)$ as well.

Proposition 5.12. *Let $\Omega \subset \mathbb{R}^n$ be any bounded Lipschitz domain, $f \in C^\infty(\Omega)$, and $u \in H^1(\Omega)$ be any minimizer of (5.4) subject to the boundary conditions $u|_{\partial\Omega} = g$.*

Then, u solves

$$(5.10) \quad \Delta u = f \chi_{\{u>0\}} \quad \text{in } \Omega$$

in the weak sense.

In particular, u is $C^{1,\alpha}$ inside Ω , for every $\alpha \in (0, 1)$.

Proof. Notice that, by Proposition 5.11, u is actually a minimizer of

$$\mathcal{E}(u) = \frac{1}{2} \int_{\Omega} |\nabla u|^2 + \int_{\Omega} f u^+$$

subject to the boundary conditions $u|_{\partial\Omega} = g$.

Thus, for any $\eta \in H_0^1(\Omega)$ and $\varepsilon > 0$ we have

$$\mathcal{E}(u + \varepsilon\eta) \geq \mathcal{E}(u).$$

In particular, we obtain

$$0 \leq \lim_{\varepsilon \downarrow 0} \frac{\mathcal{E}(u + \varepsilon\eta) - \mathcal{E}(u)}{\varepsilon} = \int_{\Omega} \nabla u \cdot \nabla \eta + \lim_{\varepsilon \downarrow 0} \int_{\Omega} f \frac{(u + \varepsilon\eta)^+ - u^+}{\varepsilon}.$$

Notice that

$$\lim_{\varepsilon \downarrow 0} \frac{(u + \varepsilon\eta)^+ - u^+}{\varepsilon} = \begin{cases} \eta & \text{in } \{u > 0\} \\ \eta^+ & \text{in } \{u = 0\}, \end{cases}$$

so that we have

$$\int_{\Omega} \nabla u \cdot \nabla \eta + \int_{\Omega} f \eta \chi_{\{u > 0\}} + \int_{\Omega} f \eta^+ \chi_{\{u = 0\}} \geq 0 \quad \text{for all } \eta \in H_0^1(\Omega).$$

Assume first that $\eta \geq 0$, so that

$$\int_{\Omega} \nabla u \cdot \nabla \eta + \int_{\Omega} f \eta \geq 0 \quad \text{for all } \eta \in H_0^1(\Omega), \quad \eta \geq 0,$$

which implies that $\Delta u \leq f$ in the weak sense. On the other hand, if $\eta \leq 0$, then

$$\int_{\Omega} \nabla u \cdot \nabla \eta + \int_{\Omega} f \eta \chi_{\{u > 0\}} \geq 0 \quad \text{for all } \eta \in H_0^1(\Omega), \quad \eta \leq 0,$$

which implies that $\Delta u \geq f \chi_{\{u > 0\}}$ in the weak sense. In all (recall that $f \geq 0$),

$$f \chi_{\{u > 0\}} \leq \Delta u \leq f \quad \text{in } \Omega.$$

(In particular, notice that $\Delta u = f$ in $\{u > 0\}$.) Now, since f is smooth, this implies that $\Delta u \in L_{\text{loc}}^{\infty}(\Omega)$. By Proposition 2.18 we deduce that $u \in C^{1,1-\varepsilon}$ for every $\varepsilon > 0$. Moreover, since $\Delta u \in L_{\text{loc}}^{\infty}(\Omega)$ we have $\Delta u \in L_{\text{loc}}^2(\Omega)$ and by Calderón-Zygmund estimates (see, for example, Remark 2.13) we have $u \in W_{\text{loc}}^{2,2}(\Omega)$. Thus, $\Delta u = 0$ almost everywhere in the level set $\{u = 0\}$ (see **(S9)** in Chapter 1) and we have

$$\Delta u = f \chi_{\{u > 0\}} \quad \text{a.e. in } \Omega.$$

From here we deduce that $\Delta u = f \chi_{\{u > 0\}}$ in Ω in the weak sense. \square

— DRAFT —

Notice that in the previous Section, when dealing with minimizers v of (5.1), it was not easy to prove that v is continuous (see Proposition 5.3). Here, instead, thanks to Proposition 5.12 we simply used Schauder-type estimates for the Laplacian to directly deduce that u is $C^{1,1-\varepsilon}$, which is the almost-optimal regularity of solutions.

Optimal regularity of solutions. Thanks to the previous results, we know that any minimizer of (5.4) is continuous and solves (5.10). From now on, we will localize the problem and study it in a ball:

$$(5.11) \quad \begin{cases} u \geq 0 & \text{in } B_1 \\ \Delta u = f\chi_{\{u>0\}} & \text{in } B_1. \end{cases}$$

Our next goal is to answer the following question:

Question: *What is the optimal regularity of solutions?*

First, a few important considerations. Notice that in the set $\{u > 0\}$ we have $\Delta u = f$, while in the interior of $\{u = 0\}$ we have $\Delta u = 0$ (since $u \equiv 0$ there).

Thus, since f is in general not zero, Δu is *discontinuous* across the free boundary $\partial\{u > 0\}$ in general. In particular, $u \notin C^2$.

We will now prove that any minimizer of (5.4) is actually $C^{1,1}$, which gives the:

Answer: $u \in C^{1,1}$ (*second derivatives are bounded but not continuous*)

The precise statement and proof are given next.

Theorem 5.13 (Optimal regularity). *Let $f \in C^\infty(B_1)$, and let u be any solution to (5.11). Then, u is $C^{1,1}$ inside $B_{1/2}$, with the estimate*

$$\|u\|_{C^{1,1}(B_{1/2})} \leq C(\|u\|_{L^\infty(B_1)} + \|f\|_{\text{Lip}(B_1)}).$$

The constant C depends only on n .

To prove this, the main step is the following.

Lemma 5.14. *Let u be any solution to (5.11). Let $x_\circ \in \overline{B_{1/2}}$ be any point on $\{u = 0\}$. Then, for any $r \in (0, \frac{1}{4})$ we have*

$$0 \leq \sup_{B_r(x_\circ)} u \leq Cr^2,$$

with C depending only on n and $\|f\|_{L^\infty(B_1)}$.

Proof. We have that $\Delta u = f\chi_{\{u>0\}}$ in B_1 , with $f\chi_{\{u>0\}} \in L^\infty(B_1)$. Thus, since $u \geq 0$, we can use the Harnack inequality (Theorem 2.9) for the equation $\Delta u = f\chi_{\{u>0\}}$ in $B_{2r}(x_o)$, to find

$$\sup_{B_r(x_o)} u \leq C \left(\inf_{B_r(x_o)} u + r^2 \|f\chi_{\{u>0\}}\|_{L^\infty(B_{2r}(x_o))} \right).$$

Since $u \geq 0$ and $u(x_o) = 0$, this yields $\sup_{B_r(x_o)} u \leq C\|f\|_{L^\infty(B_1)}r^2$, as wanted. \square

Notice that this proof is significantly shorter than the one given in the previous Section (Lemma 5.6). This is an advantage of using the formulation (5.10).

We have proved the following:

At every free boundary point x_o , u grows (at most) quadratically.

As shown next, this easily implies the $C^{1,1}$ regularity.

Proof of Theorem 5.13. Dividing u by a constant if necessary, we may assume that $\|u\|_{L^\infty(B_1)} + \|f\|_{\text{Lip}(B_1)} \leq 1$.

We already know that $u \in C^\infty$ in the set $\{u > 0\}$ (since $\Delta u = f \in C^\infty$ there), and also inside the set $\{u = 0\}$ (since $u = 0$ there). Moreover, on the interface $\Gamma = \partial\{u > 0\}$ we have proved the quadratic growth $\sup_{B_r(x_o)} u \leq Cr^2$. Let us prove that this yields the $C^{1,1}$ bound we want.

Let $x_1 \in \{u > 0\} \cap B_{1/2}$, and let $x_o \in \Gamma$ be the closest free boundary point. Denote $\rho = |x_1 - x_o|$. Then, we have $\Delta u = f$ in $B_\rho(x_1)$.

By Schauder estimates, we find

$$\|D^2u\|_{L^\infty(B_{\rho/2}(x_1))} \leq C \left(\frac{1}{\rho^2} \|u\|_{L^\infty(B_\rho(x_1))} + \|f\|_{\text{Lip}(B_1)} \right).$$

But by the growth proved in the previous Lemma, we have $\|u\|_{L^\infty(B_\rho(x_1))} \leq C\rho^2$, which yields

$$\|D^2u\|_{L^\infty(B_{\rho/2}(x_1))} \leq C.$$

In particular,

$$|D^2u(x_1)| \leq C.$$

We can do this for each $x_1 \in \{u > 0\} \cap B_{1/2}$, and therefore $\|u\|_{C^{1,1}(B_{1/2})} \leq C$, as wanted. \square

Also, notice that as a consequence of the previous results, we have that as soon as the solution to (5.11) has non-empty contact set, then its $C^{1,1}$ norm is universally bounded.

Corollary 5.15. *Let u be any solution to (5.11), and let us assume that $u(0) = 0$ and $\|f\|_{\text{Lip}(B_1)} \leq 1$. Then,*

$$\|u\|_{C^{1,1}(B_{1/2})} \leq C$$

for some C depending only on n .

Proof. It is an immediate consequence of Theorem 5.13 combined with Lemma 5.14. \square

Nondegeneracy. For completeness, we now state the nondegeneracy in this setting (analogously to Proposition 5.8). That is, at all free boundary points, u grows *at least* quadratically (we already know *at most* quadratically). We want:

$$0 < cr^2 \leq \sup_{B_r(x_o)} u \leq Cr^2$$

for all free boundary points $x_o \in \partial\{u > 0\}$.

This property is essential in order to study the free boundary later. As before, for this we need the following natural assumption:

Assumption: *The right-hand side f satisfies*

$$f \geq c_o > 0$$

in the ball B_1 .

Proposition 5.16 (Nondegeneracy). *Let u be any solution to (5.11). Assume that $f \geq c_o > 0$ in B_1 . Then, for every free boundary point $x_o \in \partial\{u > 0\} \cap B_{1/2}$, we have*

$$0 < cr^2 \leq \sup_{B_r(x_o)} u \leq Cr^2 \quad \text{for all } r \in (0, \tfrac{1}{2}),$$

with a constant $c > 0$ depending only on n and c_o .

Proof. The proof is the one from Proposition 5.8. \square

Summary of basic properties. Let u be any solution to the obstacle problem

$$\begin{cases} u \geq 0 & \text{in } B_1, \\ \Delta u = f\chi_{\{u>0\}} & \text{in } B_1. \end{cases}$$

Then, we have:

• Optimal regularity: $\|u\|_{C^{1,1}(B_{1/2})} \leq C (\|u\|_{L^\infty(B_1)} + \|f\|_{\text{Lip}(B_1)})$

• Nondegeneracy: If $f \geq c_o > 0$, then

$$0 < cr^2 \leq \sup_{B_r(x_o)} u \leq Cr^2 \quad \text{for all } r \in (0, \tfrac{1}{2})$$

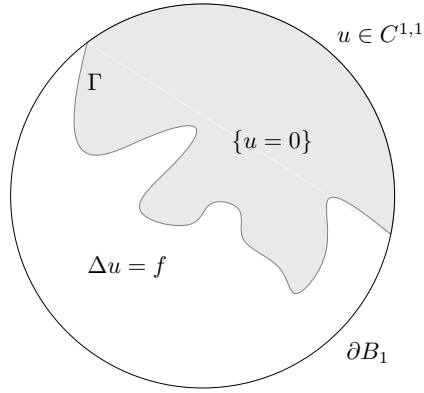

Figure 5.8. A solution to the obstacle problem in B_1 .

at all free boundary points $x_o \in \partial\{u > 0\} \cap B_{1/2}$.

Using these properties, we can now start the study of the free boundary.

5.4. Regularity of free boundaries: an overview

From now on, we consider any solution to

$$(5.12) \quad \begin{cases} u \in C^{1,1}(B_1), \\ u \geq 0 \quad \text{in } B_1, \\ \Delta u = f \quad \text{in } \{u > 0\}, \end{cases}$$

(see Figure 5.8) with

$$(5.13) \quad f \geq c_o > 0 \quad \text{and} \quad f \in C^\infty.$$

Notice that on the interface

$$\Gamma = \partial\{u > 0\} \cap B_1$$

we have that

$$\begin{aligned} u &= 0 \quad \text{on } \Gamma, \\ \nabla u &= 0 \quad \text{on } \Gamma. \end{aligned}$$

The central mathematical challenge in the obstacle problem is to

understand the geometry/regularity of the free boundary Γ .

Notice that, even if we already know the optimal regularity of u (it is $C^{1,1}$), we know nothing about the free boundary Γ . A priori Γ could be a very irregular object, even a fractal set with infinite perimeter.

As we will see, under the natural assumption $f \geq c_o > 0$, it turns out that free boundaries are always smooth, possibly outside a certain set of

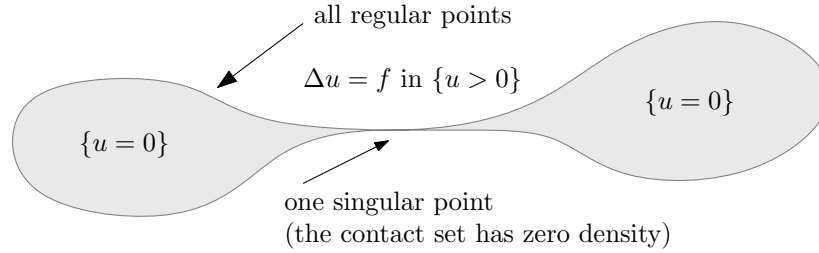

Figure 5.9. Singular points are those where the contact set has zero density.

singular points. In fact, in our proofs we will assume for simplicity that $f \equiv 1$ (or constant). We do that in order to avoid x -dependence and the technicalities associated to it, which gives cleaner proofs. In this way, the main ideas behind the regularity of free boundaries are exposed.

Regularity of free boundaries: main results. Assume from now on that u solves (5.12)-(5.13). Then, the main known results on the free boundary $\Gamma = \partial\{u > 0\}$ can be summarized as follows:

- At every free boundary point $x_o \in \Gamma$, we have

$$0 < cr^2 \leq \sup_{B_r(x_o)} u \leq Cr^2 \quad \forall r \in (0, r_o).$$

- The free boundary Γ splits into *regular points* and *singular points*.
- The set of *regular points* is an open subset of the free boundary, and Γ is C^∞ near these points.
- *Singular points* are those at which the contact set $\{u = 0\}$ has *zero density*, and these points (if any) are contained in an $(n-1)$ -dimensional C^1 manifold.

Summarizing, *the free boundary is smooth, possibly outside a certain set of singular points*. See Figure 5.9.

So far, we have not even proved that Γ has finite perimeter, or anything at all about Γ . Our goal will be to prove that Γ is C^∞ near regular points. This is the main and most important result in the obstacle problem. It was proved by Caffarelli in 1977, and it is one of the major results for which he received the Wolf Prize in 2012 and the Shaw Prize in 2018.

Overview of the strategy. To prove these regularity results for the free boundary, one considers *blow-ups*. Namely, given any free boundary point x_o

— DRAFT —

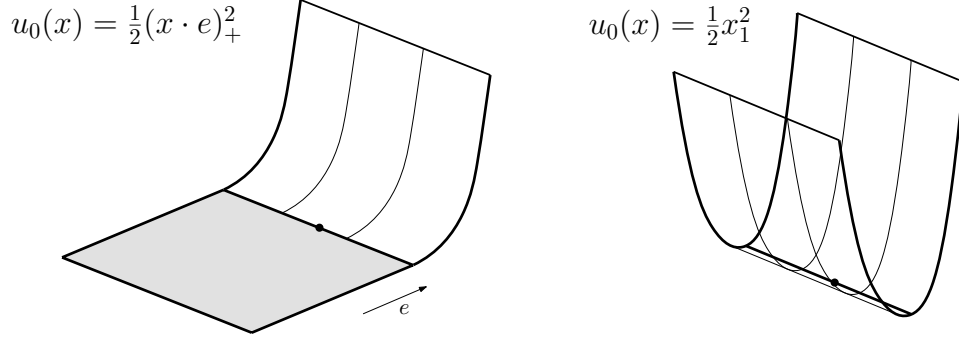

Figure 5.10. Possible blow-ups of the solution to the obstacle problem at free boundary points.

for a solution u of (5.12)-(5.13), one takes the rescalings

$$u_r(x) := \frac{u(x_o + rx)}{r^2},$$

with $r > 0$ small. This is like “zooming in” at a free boundary point.

The factor r^{-2} is chosen so that

$$\|u_r\|_{L^\infty(B_1)} \approx 1$$

as $r \rightarrow 0$; recall that $0 < cr^2 \leq \sup_{B_r(x_o)} u \leq Cr^2$.

Then, by $C^{1,1}$ estimates, we will prove that a subsequence of u_r converges to a function u_0 locally uniformly in \mathbb{R}^n as $r \rightarrow 0$. Such function u_0 is called a *blow-up of u at x_o* .

Any blow-up u_0 is a *global* solution to the obstacle problem, with $f \equiv 1$ (or with $f \equiv \text{constant} > 0$).

Then, the main issue is to *classify blow-ups*: that is, to show that

$$\begin{aligned} \text{either} \quad u_0(x) &= \frac{1}{2}(x \cdot e)_+^2 && \text{(this happens at regular points)} \\ \text{or} \quad u_0(x) &= \frac{1}{2}x^T A x && \text{(this happens at singular points).} \end{aligned}$$

Here, $e \in \mathbb{S}^{n-1}$ is a unit vector, and $A \geq 0$ is a positive semi-definite matrix satisfying $\text{tr}A = 1$. Notice that the contact set $\{u_0 = 0\}$ becomes a half-space in case of regular points, while it has zero measure in case of singular points; see Figure 5.10.

Once this is done, one has to “transfer” the information from the blow-up u_0 to the original solution u . Namely, one shows that, in fact, the free boundary is $C^{1,\alpha}$ near regular points (for some small $\alpha > 0$).

Finally, once we know that the free boundary is $C^{1,\alpha}$, we will “bootstrap” the regularity to C^∞ . This is in a somewhat similar spirit as in *Hilbert’s XIXth problem* (Chapter 3), where the really difficult point was to

prove that minimizers are always $C^{1,\alpha}$. Once this was done, by Schauder estimates (Chapter 2) and a bootstrap argument we saw that solutions are actually C^∞ .

Classifying blow-ups is not easy. Generally speaking, classifying blow-ups is of similar difficulty to proving regularity estimates — recall the blow-up arguments in Chapter 2.

Thus, how can we classify blow-ups? Do we get any extra information on u_0 that we did not have for u ? (Otherwise it seems hopeless!)

The answer is *yes*: CONVEXITY. We will prove that all blow-ups are always *convex*. This is a huge improvement, since this yields that the contact set $\{u_0 = 0\}$ is also convex. Prior to that, we will also show that blow-ups are also *homogeneous*.

So, before the blow-up we had no information on the set $\{u = 0\}$, but after the blow-up we get that $\{u_0 = 0\}$ is a *convex cone*. Thanks to this we will be able to classify blow-ups, and thus to prove the regularity of the free boundary.

The main steps in the proof of the regularity of the free boundary will be the following:

- (1) $0 < cr^2 \leq \sup_{B_r(x_o)} u \leq Cr^2$
- (2) Blow-ups u_0 are *homogeneous* and *convex*.
- (3) If the contact set has *positive density* at x_o , then $u_0(x) = \frac{1}{2}(x \cdot e)_+^2$.
- (4) Deduce that the free boundary is $C^{1,\alpha}$ near x_o .
- (5) Deduce that the free boundary is C^∞ near x_o .

The proof we will present here for the convexity of blow-ups is new, based on the fact that they are homogeneous. We refer to [Caf98], [PSU12], [Wei99], and [KN77], for different proofs of the classification of blow-ups and/or of the regularity of free boundaries.

5.5. Classification of blow-ups

The aim of this Section is to classify all possible blow-ups u_0 . For this, we will first prove that blow-ups are homogeneous, then we will prove that they are convex, and finally we will establish their complete classification.

Homogeneity of blow-ups. We start by proving that blow-ups are homogeneous. This is not essential in the proof of the regularity of the free boundary (see [Caf98]), but it actually simplifies it.

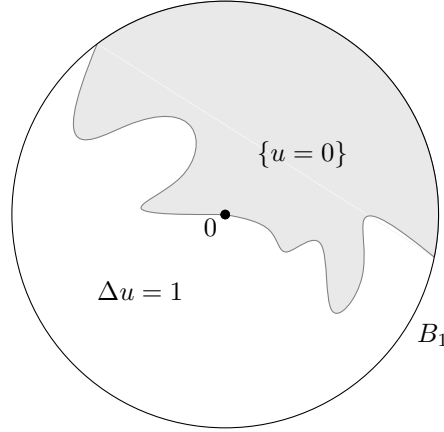

Figure 5.11. A solution u to the obstacle problem with $f \equiv 1$.

Recall that, for simplicity, from now on we will assume that $f \equiv 1$ in B_1 . This is only to avoid x -dependence in the equation, it simplifies some proofs.

Therefore, from now on we consider a solution u satisfying (see Figure 5.11):

$$\begin{aligned}
 (5.14) \quad & u \in C^{1,1}(B_1) \\
 & u \geq 0 \quad \text{in } B_1 \\
 & \Delta u = 1 \quad \text{in } \{u > 0\} \\
 & 0 \text{ is a free boundary point.}
 \end{aligned}$$

We will prove all the results around the origin (without loss of generality).

We will show that, for the original solution u in B_1 , the closer we look at a free boundary point x_o , the closer is the solution to being homogeneous.

Proposition 5.17 (Homogeneity of blow-ups). *Let u be any solution to (5.14). Then, any blow-up of u at 0 is homogeneous of degree 2.*

It is important to remark that not all global solutions to the obstacle problem in \mathbb{R}^n are homogeneous. There exist global solutions u_0 that are convex, $C^{1,1}$, and whose contact set $\{u_0 = 0\}$ is an ellipsoid, for example. However, thanks to the previous result, we find that such non-homogeneous solutions cannot appear as blow-ups, i.e., that all blow-ups must be homogeneous.

We provide two different proofs of Proposition 5.17. The first one uses a monotonicity formula as introduced by Weiss; while the second one does not require any monotonicity formula and is due to Spruck.

Homogeneity of blow-ups à la Weiss. For the first proof of Proposition 5.17, we need the following monotonicity formula due to Weiss [Wei99].

Theorem 5.18 (Weiss' monotonicity formula). *Let u be any solution to (5.14). Then, the quantity*

$$(5.15) \quad W_u(r) := \frac{1}{r^{n+2}} \int_{B_r} \left\{ \frac{1}{2} |\nabla u|^2 + u \right\} - \frac{1}{r^{n+3}} \int_{\partial B_r} u^2$$

is monotone in r , that is,

$$\frac{d}{dr} W_u(r) = \frac{1}{r^{n+4}} \int_{\partial B_r} (x \cdot \nabla u - 2u)^2 dx \geq 0$$

for $r \in (0, 1)$.

Proof. Let $u_r(x) = r^{-2}u(rx)$, and observe that

$$W_u(r) = \int_{B_1} \left\{ \frac{1}{2} |\nabla u_r|^2 + u_r \right\} - \int_{\partial B_1} u_r^2.$$

Using this, together with

$$\frac{d}{dr} (\nabla u_r) = \nabla \frac{d}{dr} u_r,$$

we find

$$\frac{d}{dr} W_u(r) = \int_{B_1} \left\{ \nabla u_r \cdot \nabla \frac{d}{dr} u_r + \frac{d}{dr} u_r \right\} - 2 \int_{\partial B_1} u_r \frac{d}{dr} u_r.$$

Now, integrating by parts we get

$$\int_{B_1} \nabla u_r \cdot \nabla \frac{d}{dr} u_r = - \int_{B_1} \Delta u_r \frac{d}{dr} u_r + \int_{\partial B_1} \partial_\nu(u_r) \frac{d}{dr} u_r.$$

Since $\Delta u_r = 1$ in $\{u_r > 0\}$ and $\frac{d}{dr} u_r = 0$ in $\{u_r = 0\}$, we have

$$\int_{B_1} \nabla u_r \cdot \nabla \frac{d}{dr} u_r = - \int_{B_1} \frac{d}{dr} u_r + \int_{\partial B_1} \partial_\nu(u_r) \frac{d}{dr} u_r.$$

Thus, we deduce

$$\frac{d}{dr} W_u(r) = \int_{\partial B_1} \partial_\nu(u_r) \frac{d}{dr} u_r - 2 \int_{\partial B_1} u_r \frac{d}{dr} u_r.$$

Using that on ∂B_1 we have $\partial_\nu = x \cdot \nabla$, combined with

$$\frac{d}{dr} u_r = \frac{1}{r} \{x \cdot \nabla u_r - 2u_r\}$$

yields

$$\frac{d}{dr} W_u(r) = \frac{1}{r} \int_{\partial B_1} (x \cdot \nabla u_r - 2u_r)^2,$$

which gives the desired result. \square

We now give the:

First proof of Proposition 5.17. Let $u_r(x) = r^{-2}u(rx)$, and notice that we have the scaling property

$$W_{u_r}(\rho) = W_u(\rho r),$$

for any $r, \rho > 0$.

If u_0 is any blow-up of u at 0 then there is a sequence $r_j \rightarrow 0$ satisfying $u_{r_j} \rightarrow u_0$ in $C_{\text{loc}}^1(\mathbb{R}^n)$. Thus, for any $\rho > 0$ we have

$$W_{u_0}(\rho) = \lim_{r_j \rightarrow 0} W_{u_{r_j}}(\rho) = \lim_{r_j \rightarrow 0} W_u(\rho r_j) = W_u(0^+).$$

Notice that the limit $W_u(0^+) := \lim_{r \rightarrow 0} W_u(r)$ exists by monotonicity of W and since $u \in C^{1,1}$ implies $W_u(r) \geq -C$ for all $r \geq 0$.

Hence, the function $W_{u_0}(\rho)$ is *constant* in ρ . However, by Theorem 5.18 this yields that $x \cdot \nabla u_0 - 2u_0 \equiv 0$ in \mathbb{R}^n , and therefore u_0 is homogeneous of degree 2. \square

Remark 5.19. Here, we used that a C^1 function u_0 is 2-homogeneous (i.e. $u_0(\lambda x) = \lambda^2 u_0(x)$ for all $\lambda \in \mathbb{R}_+$) if and only if $x \cdot \nabla u_0 \equiv 2u_0$. This is because $\partial_\lambda|_{\lambda=1} \{\lambda^{-2}u_0(\lambda x)\} = x \cdot \nabla u_0 - 2u_0$.

Homogeneity of blow-ups à la Spruck. We present an alternative (and quite different) proof of the homogeneity of blow-ups. Such proof is due to Spruck [Spr83] and is not based on any monotonicity formula.

Second proof of Proposition 5.17. Let u_0 be a blow-up given by the limit along a sequence $r_k \downarrow 0$,

$$u_0(x) := \lim_{k \rightarrow \infty} r_k^{-2}u(r_k x).$$

By taking polar coordinates $(\varrho, \theta) \in [0, +\infty) \times \mathbb{S}^{n-1}$ with $x = \varrho\theta$, and by denoting $\tilde{u}_0(\varrho, \theta) = u_0(\varrho\theta) = u_0(x)$, we will prove that $u_0(x) = \varrho^2 \tilde{u}_0(1, \theta) = |x|^2 u_0(x/|x|)$.

Let us define $\tau := -\log \varrho$, $\tilde{u}(\varrho, \theta) = u(x)$, and $\psi = \psi(\tau, \theta)$ as

$$\psi(\tau, \theta) := \varrho^{-2} \tilde{u}(\varrho, \theta) = e^{2\tau} u(e^{-\tau} \theta)$$

for $\tau \geq 0$. We observe that, since $\|u\|_{L^\infty(B_r)} \leq Cr^2$, ψ is bounded. Moreover, $\psi \in C^1((0, \infty) \times \mathbb{S}^{n-1}) \cap C^2(\{\psi > 0\})$ from the regularity of u ; and $\partial_\tau \psi$ and $\nabla_\theta \psi$ are not only continuous, but also uniformly bounded in $[0, \infty) \times \mathbb{S}^{n-1}$. Indeed,

$$|\nabla_\theta \psi(\tau, \theta)| \leq e^\tau |\nabla u(e^{-\tau} \theta)| \leq C,$$

since $\|\nabla u\|_{L^\infty(B_r)} \leq Cr$ by $C^{1,1}$ regularity and the fact that $\nabla u(0) = 0$. For the same reason we also obtain

$$|\partial_\tau \psi(\tau, \theta)| \leq 2\psi(\tau, \theta) + e^\tau |\nabla u(e^{-\tau} \theta)| \leq C.$$

Observe that, by assumption, if we denote $\tau_k := -\log r_k$,

$$(5.16) \quad \psi(\tau_k, \theta) \rightarrow \tilde{u}_0(1, \theta) \quad \text{uniformly on } \mathbb{S}^{n-1}, \text{ as } k \rightarrow \infty.$$

Let us now write an equation for ψ . In order to do that, since we know that $\Delta u = \chi_{\{u>0\}}$ and $\chi_{\{u>0\}} = \chi_{\{\psi>0\}}$, we have

$$\Delta(\varrho^2 \psi(-\log \varrho, \theta)) = \chi_{\{\psi>0\}}.$$

By expanding the Laplacian in polar coordinates, $\Delta = \partial_{\varrho\varrho} + \frac{n-1}{\varrho} \partial_{\varrho} + \varrho^{-2} \Delta_{\mathbb{S}^{n-1}}$ (where $\Delta_{\mathbb{S}^{n-1}}$ denotes the spherical Laplacian, i.e. the Laplace–Beltrami operator on \mathbb{S}^{n-1}) we obtain

$$(5.17) \quad 2n\psi - (n+2)\partial_{\tau}\psi + \partial_{\tau\tau}\psi + \Delta_{\mathbb{S}^{n-1}}\psi = \chi_{\{\psi>0\}}.$$

We multiply the previous equality by $\partial_{\tau}\psi$, and integrate in $[0, \tau] \times \mathbb{S}^{n-1}$. We can consider the terms separately, integrating in τ first,

$$2n \int_{\mathbb{S}^{n-1}} \int_0^{\tau} \psi \partial_{\tau}\psi = n \int_{\mathbb{S}^{n-1}} (\psi^2(\tau, \theta) - \psi^2(0, \theta)) d\theta$$

and

$$\int_{\mathbb{S}^{n-1}} \int_0^{\tau} \partial_{\tau\tau}\psi \partial_{\tau}\psi = \frac{1}{2} \int_{\mathbb{S}^{n-1}} ((\partial_{\tau}\psi)^2(\tau, \theta) - (\partial_{\tau}\psi)^2(0, \theta)) d\theta,$$

and then integrating by parts in θ first, to integrate in τ afterwards:

$$\begin{aligned} \int_0^{\tau} \int_{\mathbb{S}^{n-1}} \Delta_{\mathbb{S}^{n-1}}\psi \partial_{\tau}\psi &= -\frac{1}{2} \int_0^{\tau} \int_{\mathbb{S}^{n-1}} \partial_{\tau} |\nabla_{\theta}\psi|^2 \\ &= \frac{1}{2} \int_{\mathbb{S}^{n-1}} (|\nabla_{\theta}\psi|^2(0, \theta) - |\nabla_{\theta}\psi|^2(\tau, \theta)) d\theta. \end{aligned}$$

Finally, since $\partial_{\tau}\psi = 0$ whenever $\psi = 0$, we have $\chi_{\{\psi>0\}} \partial_{\tau}\psi = \partial_{\tau}\psi$ and

$$\int_{\mathbb{S}^{n-1}} \int_0^{\tau} \chi_{\{\psi>0\}} \partial_{\tau}\psi = \int_{\mathbb{S}^{n-1}} (\psi(\tau, \theta) - \psi(0, \theta)) d\theta.$$

In all, plugging back in (5.17) the previous expressions, and using that $\partial_{\tau}\psi$ and $\nabla_{\theta}\psi$ are uniformly bounded in $[0, \infty) \times \mathbb{S}^{n-1}$, we deduce that

$$(5.18) \quad \int_0^{\infty} \int_{\mathbb{S}^{n-1}} (\partial_{\tau}\psi)^2 = \int_0^{\infty} \|\partial_{\tau}\psi\|_{L^2(\mathbb{S}^{n-1})}^2 \leq C < \infty.$$

To finish, now observe that for any $|s| \leq C_*$ fixed and for a sufficiently large k (such that $\tau_k + s \geq 0$),

$$\begin{aligned} \|\psi(\tau_k + s, \cdot) - \tilde{u}_0(1, \cdot)\|_{L^2(\mathbb{S}^{n-1})} &\leq \|\psi(\tau_k + s, \cdot) - \psi(\tau_k, \cdot)\|_{L^2(\mathbb{S}^{n-1})} \\ &\quad + \|\psi(\tau_k, \cdot) - \tilde{u}_0(1, \cdot)\|_{L^2(\mathbb{S}^{n-1})}. \end{aligned}$$

The last term goes to zero, by (5.16). On the other hand, for the first term and by Hölder's inequality

$$\begin{aligned} \|\psi(\tau_k + s, \cdot) - \psi(\tau_k, \cdot)\|_{L^2(\mathbb{S}^{n-1})}^2 &\leq \left\| \int_0^s \partial_\tau \psi(\tau_k + \tau, \cdot) d\tau \right\|_{L^2(\mathbb{S}^{n-1})}^2 \\ &\leq C_* \left| \int_{\tau_k}^{\tau_k + s} \|\partial_\tau \psi\|_{L^2(\mathbb{S}^{n-1})}^2 \right| \rightarrow 0, \end{aligned}$$

as $k \rightarrow \infty$, where we are using (5.18). Hence, $\psi(\tau_k + s, \cdot) \rightarrow \tilde{u}_0(1, \cdot)$ in $L^2(\mathbb{S}^{n-1})$ as $k \rightarrow \infty$, for any fixed $s \in \mathbb{R}$. On the other hand,

$$\psi(\tau_k + s, \theta) = e^{2s} r_k^{-2} u(e^{-2} r_k \theta) \rightarrow e^{2s} u_0(e^{-s} \theta) = e^{2s} \tilde{u}_0(e^{-s}, \theta).$$

That is, for any $\rho = e^{-s} > 0$,

$$\tilde{u}_0(1, \cdot) = \rho^{-2} \tilde{u}_0(\rho, \theta),$$

as we wanted to see. \square

Convexity of blow-ups. By taking advantage of the fact that we know that blow-ups are 2-homogeneous, we can now give a short (and new) proof of the fact that they are also convex. More precisely, we will prove that 2-homogeneous global solutions to the obstacle problem are convex (and in particular, by Proposition 5.17, blow-ups are convex).

Theorem 5.20. *Let $u_0 \in C^{1,1}$ be any 2-homogeneous global solution to*

$$\begin{cases} u_0 \geq 0 & \text{in } \mathbb{R}^n \\ \Delta u_0 = 1 & \text{in } \{u_0 > 0\} \\ 0 \text{ is a free boundary point.} \end{cases}$$

Then, u_0 is convex.

The heuristic idea behind the proof of the previous result is the following: second derivatives $D^2 u_0$ are harmonic in $\{u_0 > 0\}$ and satisfy that $D^2 u_0 \geq 0$ on $\partial\{u_0 > 0\}$ (since $u_0 \geq 0$, it is ‘‘convex at the free boundary’’). Since $D^2 u_0$ is also 0-homogeneous, we can apply the maximum principle and conclude that $D^2 u_0 \geq 0$ everywhere. That is, u_0 is convex. Let us formalize the previous heuristic idea into an actual proof.

We state a short lemma before providing the proof, which says that if $w \geq 0$ is superharmonic in $\{w > 0\}$, then it is superharmonic everywhere. For the sake of generality, we state the lemma for general H^1 functions, but we will use it only for functions that are also continuous.

Lemma 5.21. *Let $\Lambda \subset B_1$ be closed. Let $w \in H^1(B_1)$ be such that $w \geq 0$ on Λ and such that w is superharmonic in the weak sense in $B_1 \setminus \Lambda$. Then $\min\{w, 0\}$ is superharmonic in the weak sense in B_1 .*

Proof. Let us start by assuming that w is, furthermore, continuous. In this case, we define $w_\varepsilon = \min\{w, -\varepsilon\} \in H^1(B_1)$. Then notice that (by continuity) in a neighborhood of $\{w = -\varepsilon\}$, w is superharmonic ($\Delta w \leq 0$). By Lemma 3.9 (we apply the lemma with $v = -w - \varepsilon$) we have that $\Delta w_\varepsilon \leq 0$ in the weak sense, namely, w_ε is superharmonic. Moreover, they are uniformly in H^1 , so up to subsequences they converge weakly to $\min\{w, 0\}$. Since the weak limit of weakly superharmonic functions is superharmonic, we deduce the desired result.

Finally, to remove the continuity assumption on $w \in H^1(B_1)$, we repeat the proof of Lemma 3.9. The only thing we need to check is that $F'(v)\eta \in H_0^1(B_1 \setminus \Lambda)$, which follows from the fact that such function is in $H^1(B_1)$ and vanishes in Λ ; see for example [AH96, Theorem 9.1.3]. \square

We now give the:

Proof of Theorem 5.20. Let $e \in \mathbb{S}^{n-1}$ and consider the second derivatives $\partial_{ee}u_0$. We define

$$w_0 := \min\{\partial_{ee}u_0, 0\}$$

and we claim that w_0 is superharmonic in \mathbb{R}^n , in the sense (1.20).

Indeed, let $\delta_t^2 u_0(x)$ for $t > 0$ be defined by

$$\delta_t^2 u_0(x) := \frac{u_0(x + te) + u_0(x - te) - 2u_0(x)}{t^2}.$$

Now, since $\Delta u_0 = \chi_{\{u_0 > 0\}}$, we have that

$$\Delta \delta_t^2 u_0 = \frac{1}{t^2} (\chi_{\{u_0(\cdot + te)\}} + \chi_{\{u_0(\cdot - te)\}} - 2) \leq 0 \quad \text{in } \{u_0 > 0\}$$

in the weak sense. On the other hand, $\delta_t^2 u_0 \geq 0$ in $\{u_0 = 0\}$ and $\delta_t^2 u_0 \in C^{1,1}$. Thus, by Lemma 5.21, $w_t := \min\{\delta_t^2 u_0, 0\}$ is weakly superharmonic, and hence it satisfies (1.20). Also notice that $\delta_t^2 u_0(x)$ is uniformly bounded independently of t , since $u_0 \in C^{1,1}$, and therefore w_t is uniformly bounded in t and converges pointwise to w_0 as $t \downarrow 0$. In particular, by Lemma 1.16 we have that w_0 is superharmonic in the sense of (1.20), as claimed.

Up to changing it in a set of measure 0, w_0 is lower semi-continuous by Lemma 1.17. In particular, since w_0 is 0-homogeneous, it must attain its minimum at a point $y_o \in B_1$. But since $\int_{B_r(y_o)} w_0$ is non-increasing for $r > 0$, we must have that w_0 is constant. Since it vanishes on the free boundary, we have $w_0 \equiv 0$. That is, for any $e \in \mathbb{S}^{n-1}$ we have that $\partial_{ee}u_0 \geq 0$ and therefore u_0 is convex. \square

Remark 5.22 (Convexity of blow-ups *à la* Caffarelli). The original proof by Caffarelli on the convexity of blow-ups, [Caf77, Caf98], is more involved than the previous one, but obtains a quantitative estimate on the convexity

without using the homogeneity assumption (in particular, it is valid for any global solution).

More precisely, for any solution u to (5.14) in B_1

$$\partial_{ee}u(x) \geq -\frac{C}{|\log|x||^\varepsilon} \quad \text{for all } e \in \mathbb{S}^{n-1}, x \in B_{1/2},$$

for some $\varepsilon > 0$. Notice that $C|\log|x||^{-\varepsilon} \rightarrow 0$ as $x \rightarrow 0$. Thus, u becomes closer and closer to being convex as we approach to the free boundary. Rescaling this result to B_R , and letting $R \rightarrow \infty$, this implies that any global solution is convex.

Finally, we refer to [PSU12, Theorem 5.1] for yet another different proof of the convexity of blow-ups.

Classification of blow-ups. We next want to classify all possible blow-ups for solutions to the obstacle problem (5.14). First, we will prove the following.

Proposition 5.23. *Let u be any solution to (5.14), and let*

$$u_r(x) := \frac{u(rx)}{r^2}.$$

Then, for any sequence $r_k \rightarrow 0$ there is a subsequence $r_{k_j} \rightarrow 0$ such that

$$u_{r_{k_j}} \longrightarrow u_0 \quad \text{in } C_{\text{loc}}^1(\mathbb{R}^n)$$

as $k_j \rightarrow \infty$, for some function u_0 satisfying

$$\begin{cases} u_0 \in C_{\text{loc}}^{1,1}(\mathbb{R}^n) \\ u_0 \geq 0 \quad \text{in } B_1 \\ \Delta u_0 = 1 \quad \text{in } \{u_0 > 0\} \\ 0 \text{ is a free boundary point} \\ u_0 \text{ is convex} \\ u_0 \text{ is homogeneous of degree 2.} \end{cases}$$

Proof. By $C^{1,1}$ regularity of u , and by nondegeneracy, we have that

$$\frac{1}{C} \leq \sup_{B_1} u_r \leq C$$

for some $C > 0$. Moreover, again by $C^{1,1}$ regularity of u , we have

$$\|D^2 u_r\|_{L^\infty(B_{1/(2r)})} \leq C.$$

Since the sequence $\{u_{r_k}\}$, for $r_k \rightarrow 0$, is uniformly bounded in $C^{1,1}(K)$ for each compact set $K \subset \mathbb{R}^n$, there is a subsequence $r_{k_j} \rightarrow 0$ such that

$$u_{r_{k_j}} \longrightarrow u_0 \quad \text{in } C_{\text{loc}}^1(\mathbb{R}^n)$$

for some $u_0 \in C^{1,1}(K)$. Moreover, such function u_0 satisfies $\|D^2 u_0\|_{L^\infty(K)} \leq C$, with C independent of K , and clearly $u_0 \geq 0$ in K .

The fact that $\Delta u_0 = 1$ in $\{u_0 > 0\} \cap K$ can be checked as follows. For any smooth function $\eta \in C_c^\infty(\{u_0 > 0\} \cap K)$ we will have that, for k_j large enough, $u_{r_{k_j}} > 0$ in the support of η , and thus

$$\int_{\mathbb{R}^n} \nabla u_{r_{k_j}} \cdot \nabla \eta \, dx = - \int_{\mathbb{R}^n} \eta \, dx.$$

Since $u_{r_{k_j}} \rightarrow u_0$ in $C^1(K)$, we can take the limit $k_j \rightarrow \infty$ to get

$$\int_{\mathbb{R}^n} \nabla u_0 \cdot \nabla \eta \, dx = - \int_{\mathbb{R}^n} \eta \, dx.$$

Since this can be done for any $\eta \in C_c^\infty(\{u > 0\} \cap K)$, and for every $K \subset \mathbb{R}^n$, it follows that $\Delta u_0 = 1$ in $\{u_0 > 0\}$.

The fact that 0 is a free boundary point for u_0 follows simply by taking limits to $u_{r_{k_j}}(0) = 0$ and $\|u_{r_{k_j}}\|_{L^\infty(B_\rho)} \approx \rho^2$ for all $\rho \in (0, 1)$. Finally, the homogeneity and convexity of u_0 follow from Proposition 5.17 and Theorem 5.20. \square

Our next goal is to prove the following.

Theorem 5.24 (Classification of blow-ups). *Let u be any solution to (5.14), and let u_0 be any blow-up of u at 0. Then,*

(a) either

$$u_0(x) = \frac{1}{2}(x \cdot e)_+^2$$

for some $e \in \mathbb{S}^{n-1}$.

(b) or

$$u_0(x) = \frac{1}{2}x^T A x$$

for some matrix $A \geq 0$ with $\text{tr } A = 1$.

It is important to remark here that, a priori, different subsequences could lead to different blow-ups u_0 .

In order to establish Theorem 5.24, we will need the following.

Lemma 5.25. *Let $\Sigma \subset \mathbb{R}^n$ be any closed convex cone with nonempty interior, and with vertex at the origin. Let $w \in C(\mathbb{R}^n)$ be a function satisfying $\Delta w = 0$ in Σ^c , $w > 0$ in Σ^c , and $w = 0$ in Σ .*

Assume in addition that w is homogeneous of degree 1. Then, Σ must be a half-space.

Proof. By convexity of Σ , there exists a half-space $H = \{x \cdot e > 0\}$, with $e \in \mathbb{S}^{n-1}$, such that $H \subset \Sigma^c$.

Let $v(x) = (x \cdot e)_+$, which is harmonic and positive in H , and vanishes in H^c . By the Hopf Lemma (see Lemma 1.15), we have that $w \geq c_\circ d_\Sigma$ in $\Sigma^c \cap B_1$, where $d_\Sigma(x) = \text{dist}(x, \Sigma)$ and c_\circ is a small positive constant. In particular, since both w and d_Σ are homogeneous of degree 1, we deduce that $w \geq c_\circ d_\Sigma$ in all of Σ^c . Notice that, in order to apply the Hopf Lemma, we used that — by convexity of Σ — the domain Σ^c satisfies the interior ball condition.

Thus, since $d_\Sigma \geq d_{H^c} = v$, we deduce that $w \geq c_\circ v$, for some $c_\circ > 0$. The idea is now to consider the functions w and cv , and let $c > 0$ increase until the two functions touch at one point, which will give us a contradiction (recall that two harmonic functions cannot touch at an interior point). To do this rigorously, define

$$c_* := \sup\{c > 0 : w \geq cv \text{ in } \Sigma^c\}.$$

Notice that $c_* \geq c_\circ > 0$. Then, we consider the function $w - c_*v \geq 0$. Assume that $w - c_*v$ is not identically zero. Such function is harmonic in H and hence, by the strict maximum principle, $w - c_*v > 0$ in H . Then, using the Hopf Lemma in H (see Lemma 1.15) we deduce that $w - c_*v \geq c_\circ d_{H^c} = c_\circ v$, since v is exactly the distance to H^c . But then we get that $w - (c_* + c_\circ)v \geq 0$, a contradiction with the definition of c_* .

Therefore, it must be $w - c_*v \equiv 0$. This means that w is a multiple of v , and therefore $\Sigma = H^c$, a half-space. \square

Remark 5.26 (Alternative proof). An alternative way to argue in the previous lemma could be the following. Any function w which is harmonic in a cone Σ^c and homogeneous of degree α can be written as a function on the sphere, satisfying $\Delta_{\mathbb{S}^{n-1}} w = \mu w$ on $\mathbb{S}^{n-1} \cap \Sigma^c$ with $\mu = \alpha(n + \alpha - 2)$ — in our case $\alpha = 1$. (Here, $\Delta_{\mathbb{S}^{n-1}}$ denotes the spherical Laplacian, i.e. the Laplace–Beltrami operator on \mathbb{S}^{n-1} .) In other words, *homogeneous harmonic functions solve an eigenvalue problem on the sphere*.

Using this, we notice that $w > 0$ in Σ^c and $w = 0$ in Σ imply that w is the *first* eigenfunction of $\mathbb{S}^{n-1} \cap \Sigma^c$, and that the first eigenvalue is $\mu = n - 1$. But, on the other hand, the same happens for the domain $H = \{x \cdot e > 0\}$, since $v(x) = (x \cdot e)_+$ is a positive harmonic function in H . This means that both domains $\mathbb{S}^{n-1} \cap \Sigma^c$ and $\mathbb{S}^{n-1} \cap H$ have the same first eigenvalue μ . But then, by strict monotonicity of the first eigenvalue with respect to domain inclusions, we deduce that $H \subset \Sigma^c$ implies $H = \Sigma^c$, as desired.

We will also need the following.

Lemma 5.27. *Assume that $\Delta u = 1$ in $\mathbb{R}^n \setminus \partial H$, where ∂H is a hyperplane. If $u \in C^1(\mathbb{R}^n)$, then $\Delta u = 1$ in \mathbb{R}^n .*

Proof. Assume $\partial H = \{x_1 = 0\}$. For any ball $B_R \subset \mathbb{R}^n$, we consider the solution to $\Delta w = 1$ in B_R , $w = u$ on ∂B_R , and define $v = u - w$. Then, we have $\Delta v = 0$ in $B_R \setminus \partial H$, and $v = 0$ on ∂B_R . We want to show that u coincides with w , that is, $v \equiv 0$ in B_R .

For this, notice that since v is bounded, for $\kappa > 0$ large enough we have

$$v(x) \leq \kappa(2R - |x_1|) \quad \text{in } B_R,$$

where $2R - |x_1|$ is positive in B_R and harmonic in $B_R \setminus \{x_1 = 0\}$. Thus, we may consider $\kappa^* := \inf\{\kappa \geq 0 : v(x) \leq \kappa(2R - |x_1|) \text{ in } B_R\}$. Assume $\kappa^* > 0$. Since v and $2R - |x_1|$ are continuous in B_R , and $v = 0$ on ∂B_R , we must have a point $p \in B_R$ at which $v(p) = \kappa^*(2R - |p_1|)$. Moreover, since v is C^1 , and the function $2R - |x_1|$ has a wedge on $\partial H = \{x_1 = 0\}$, we must have $p \in B_R \setminus \partial H$. However, this is not possible, as two harmonic functions cannot touch tangentially at an interior point p . This means that $\kappa^* = 0$, and hence $v \leq 0$ in B_R . Repeating the same argument with $-v$ instead of v , we deduce that $v \equiv 0$ in B_R , and thus the lemma is proved. \square

Finally, we will use the following basic property of convex functions.

Lemma 5.28. *Let $u : \mathbb{R}^n \rightarrow \mathbb{R}$ be a convex function such that the set $\{u = 0\}$ contains the straight line $\{te' : t \in \mathbb{R}\}$, $e' \in \mathbb{S}^{n-1}$. Then, $u(x + te') = u(x)$ for all $x \in \mathbb{R}^n$ and all $t \in \mathbb{R}$.*

Proof. After a rotation, we may assume $e' = e_n$. Then, writing $x = (x', x_n) \in \mathbb{R}^{n-1} \times \mathbb{R}$, we have that $u(0, x_n) = 0$ for all $x_n \in \mathbb{R}$, and we want to prove that $u(x', x_n) = u(x', 0)$ for all $x' \in \mathbb{R}^{n-1}$ and all $x_n \in \mathbb{R}$.

Now, by convexity, given x' and x_n , for every $\varepsilon > 0$ and $M \in \mathbb{R}$ we have

$$(1 - \varepsilon)u(x', x_n) + \varepsilon u(0, x_n + M) \geq u((1 - \varepsilon)x', x_n + \varepsilon M).$$

Since $u(0, x_n + M) = 0$, choosing $M = \lambda/\varepsilon$ and letting $\varepsilon \rightarrow 0$ we deduce that

$$u(x', x_n) \geq u(x', x_n + \lambda).$$

Since this can be done for any $\lambda \in \mathbb{R}$ and $x_n \in \mathbb{R}$, the result follows. \square

We finally establish the classification of blow-ups at regular points.

Proof of Theorem 5.24. Let u_0 be any blow-up of u at 0. We already proved that u_0 is convex and homogeneous of degree 2. We divide the proof into two cases.

Case 1. Assume that $\{u_0 = 0\}$ has nonempty interior. Then, we have $\{u_0 = 0\} = \Sigma$, a closed convex cone with nonempty interior.

For any direction $\tau \in \mathbb{S}^{n-1}$ such that $-\tau \in \overset{\circ}{\Sigma}$, we claim that

$$\partial_\tau u_0 \geq 0 \quad \text{in } \mathbb{R}^n.$$

Indeed, for every $x \in \mathbb{R}^n$ we have that $u_0(x + \tau t)$ is zero for $t \ll -1$, and therefore by convexity of u_0 we get that $\partial_t u_0(x + \tau t)$ is monotone non-decreasing in t , and zero for $t \ll -1$. This means that $\partial_t u_0 \geq 0$, and thus $\partial_\tau u_0 \geq 0$ in \mathbb{R}^n , as claimed.

Now, for any such τ , we define $w := \partial_\tau u_0 \geq 0$. Notice that, at least for some $\tau \in \mathbb{S}^{n-1}$ with $-\tau \in \overset{\circ}{\Sigma}$, the function w is not identically zero. Moreover, since it is harmonic in Σ^c — recall that $\Delta u_0 = 1$ in Σ^c — then $w > 0$ in Σ^c .

But then, since w is homogeneous of degree 1, we can apply Lemma 5.25 to deduce that we must necessarily have that Σ is a half-space.

By convexity of u_0 and Lemma 5.28, this means that u_0 is a one-dimensional function, i.e., $u_0(x) = U(x \cdot e)$ for some $U : \mathbb{R} \rightarrow \mathbb{R}$ and some $e \in \mathbb{S}^{n-1}$. Thus, we have that $U \in C^{1,1}$ solves $U''(t) = 1$ for $t > 0$, with $U(t) = 0$ for $t \leq 0$. We deduce that $U(t) = \frac{1}{2}t_+^2$, and therefore $u_0(x) = \frac{1}{2}(x \cdot e)_+^2$.

Case 2. Assume now that $\{u_0 = 0\}$ has empty interior. Then, by convexity, $\{u_0 = 0\}$ is contained in a hyperplane ∂H . Hence, $\Delta u_0 = 1$ in $\mathbb{R}^n \setminus \partial H$, with ∂H being a hyperplane, and $u_0 \in C^{1,1}$. It follows from Lemma 5.27 that $\Delta u_0 = 1$ in all of \mathbb{R}^n . But then all second derivatives of u_0 are harmonic and globally bounded in \mathbb{R}^n , so they must be constant. Hence, u_0 is a quadratic polynomial. Finally, since $u_0(0) = 0$, $\nabla u_0(0) = 0$, and $u_0 \geq 0$, we deduce that $u_0(x) = \frac{1}{2}x^T A x$ for some $A \geq 0$, and since $\Delta u_0 = 1$, we have $\text{tr } A = 1$. \square

5.6. Regularity of the free boundary

The aim of this Section is to prove Theorem 5.38 below, i.e., that if u is any solution to (5.14) satisfying

$$(5.19) \quad \limsup_{r \rightarrow 0} \frac{|\{u = 0\} \cap B_r|}{|B_r|} > 0$$

(i.e., the contact set has positive density at the origin), then the free boundary $\partial\{u > 0\}$ is C^∞ in a neighborhood of the origin.

For this, we will use the classification of blow-ups established in the previous Section.

$C^{1,\alpha}$ regularity of the free boundary. The first step here is to transfer the local information on u given by (5.19) into a blow-up u_0 . More precisely,

we next show that

$$(5.19) \quad \implies \quad \begin{array}{l} \text{The contact set of a blow-up } u_0 \\ \text{has nonempty interior.} \end{array}$$

Lemma 5.29. *Let u be any solution to (5.14), and assume that (5.19) holds. Then, there is at least one blow-up u_0 of u at 0 such that the contact set $\{u_0 = 0\}$ has nonempty interior.*

Proof. Let $r_k \rightarrow 0$ be a sequence along which

$$\lim_{r_k \rightarrow 0} \frac{|\{u = 0\} \cap B_{r_k}|}{|B_{r_k}|} \geq \theta > 0.$$

Such sequence exists (with $\theta > 0$ small enough) by assumption (5.19).

Recall that, thanks to Proposition 5.23, there exists a subsequence $r_{k_j} \downarrow 0$ along which $u_{r_{k_j}} \rightarrow u_0$ uniformly on compact sets of \mathbb{R}^n , where $u_r(x) = r^{-2}u(rx)$ and u_0 is convex.

Assume by contradiction that $\{u_0 = 0\}$ has empty interior. Then, by convexity, we have that $\{u_0 = 0\}$ is contained in a hyperplane, say $\{u_0 = 0\} \subset \{x_1 = 0\}$.

Since $u_0 > 0$ in $\{x_1 \neq 0\}$ and u_0 is continuous, we have that for each $\delta > 0$

$$u_0 \geq \varepsilon > 0 \quad \text{in } \{|x_1| > \delta\} \cap B_1$$

for some $\varepsilon > 0$.

Therefore, by uniform convergence of $u_{r_{k_j}}$ to u_0 in B_1 , there is $r_{k_j} > 0$ small enough such that

$$u_{r_{k_j}} \geq \frac{\varepsilon}{2} > 0 \quad \text{in } \{|x_1| > \delta\} \cap B_1.$$

In particular, the contact set of $u_{r_{k_j}}$ is contained in $\{|x_1| \leq \delta\} \cap B_1$, so

$$\frac{|\{u_{r_{k_j}} = 0\} \cap B_1|}{|B_1|} \leq \frac{|\{|x_1| \leq \delta\} \cap B_1|}{|B_1|} \leq C\delta.$$

Rescaling back to u , we find

$$\frac{|\{u = 0\} \cap B_{r_{k_j}}|}{|B_{r_{k_j}}|} = \frac{|\{u_{r_{k_j}} = 0\} \cap B_1|}{|B_1|} < C\delta.$$

Since we can do this for every $\delta > 0$, we find that $\lim_{r_{k_j} \rightarrow 0} \frac{|\{u=0\} \cap B_{r_{k_j}}|}{|B_{r_{k_j}}|} = 0$, a contradiction. Thus, the lemma is proved. \square

Combining the previous lemma with the classification of blow-ups from the previous Section, we deduce:

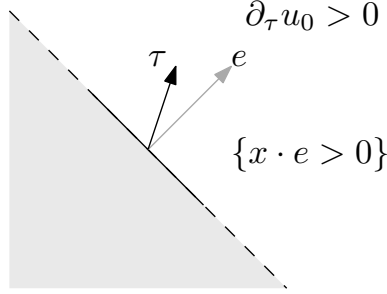

Figure 5.12. Derivatives $\partial_\tau u_0$ are nonnegative if $\tau \cdot e \geq \frac{1}{2}$.

Corollary 5.30. *Let u be any solution to (5.14), and assume that (5.19) holds. Then, there is at least one blow-up of u at 0 of the form*

$$u_0(x) = \frac{1}{2}(x \cdot e)_+^2, \quad e \in \mathbb{S}^{n-1}.$$

Proof. The result follows from Lemma 5.29 and Theorem 5.24. \square

We now want to use this information to show that the free boundary must be smooth in a neighborhood of 0. For this, we start with the following.

Proposition 5.31. *Let u be any solution to (5.14), and assume that (5.19) holds. Fix any $\varepsilon > 0$. Then, there exist $e \in \mathbb{S}^{n-1}$ and $r_\circ > 0$ such that*

$$|u_{r_\circ}(x) - \frac{1}{2}(x \cdot e)_+^2| \leq \varepsilon \quad \text{in } B_1,$$

and

$$|\partial_\tau u_{r_\circ}(x) - (x \cdot e)_+(\tau \cdot e)| \leq \varepsilon \quad \text{in } B_1$$

for all $\tau \in \mathbb{S}^{n-1}$.

Proof. By Corollary 5.30 and Proposition 5.23, we know that there is a subsequence $r_j \rightarrow 0$ for which $u_{r_j} \rightarrow \frac{1}{2}(x \cdot e)_+^2$ in $C_{\text{loc}}^1(\mathbb{R}^n)$, for some $e \in \mathbb{S}^{n-1}$. In particular, for every $\tau \in \mathbb{S}^{n-1}$ we have $u_{r_j} \rightarrow \frac{1}{2}(x \cdot e)_+^2$ and $\partial_\tau u_{r_j} \rightarrow \partial_\tau [\frac{1}{2}(x \cdot e)_+^2]$ uniformly in B_1 .

This means that, given $\varepsilon > 0$, there exists j_\circ such that

$$|u_{r_{j_\circ}}(x) - \frac{1}{2}(x \cdot e)_+^2| \leq \varepsilon \quad \text{in } B_1,$$

and

$$|\partial_\tau u_{r_{j_\circ}}(x) - \partial_\tau [\frac{1}{2}(x \cdot e)_+^2]| \leq \varepsilon \quad \text{in } B_1.$$

Since $\partial_\tau [\frac{1}{2}(x \cdot e)_+^2] = (x \cdot e)_+(\tau \cdot e)$, the proposition is proved. \square

Now, notice that if $(\tau \cdot e) > 0$, then the derivatives $\partial_\tau u_0 = (x \cdot e)_+(\tau \cdot e)$ are *nonnegative*, and strictly positive in $\{x \cdot e > 0\}$ (see Figure 5.12).

We want to transfer this information to u_{r_\circ} , and prove that $\partial_\tau u_{r_\circ} \geq 0$ in B_1 for all $\tau \in \mathbb{S}^{n-1}$ satisfying $\tau \cdot e \geq \frac{1}{2}$. For this, we need a lemma.

Lemma 5.32. *Let u be any solution to (5.14), and consider $u_{r_\circ}(x) = r_\circ^{-2}u(r_\circ x)$ and $\Omega = \{u_{r_\circ} > 0\}$.*

Assume that a function $w \in C(B_1)$ satisfies:

- (a) *w is bounded and harmonic in $\Omega \cap B_1$.*
- (b) *$w = 0$ on $\partial\Omega \cap B_1$.*
- (c) *Denoting $N_\delta := \{x \in B_1 : \text{dist}(x, \partial\Omega) < \delta\}$, we have*

$$w \geq -c_1 \quad \text{in } N_\delta \quad \text{and} \quad w \geq C_2 > 0 \quad \text{in } \Omega \setminus N_\delta.$$

If c_1/C_2 is small enough, and $\delta > 0$ is small enough, then $w \geq 0$ in $B_{1/2} \cap \Omega$.

Proof. Notice that in $\Omega \setminus N_\delta$ we already know that $w > 0$. Let $y_\circ \in N_\delta \cap \Omega \cap B_{1/2}$, and assume by contradiction that $w(y_\circ) < 0$.

Consider, in $B_{1/4}(y_\circ)$, the function

$$v(x) = w(x) - \gamma \left\{ u_{r_\circ}(x) - \frac{1}{2n} |x - y_\circ|^2 \right\}.$$

Then, $\Delta v = 0$ in $B_{1/4}(y_\circ) \cap \Omega$, and $v(y_\circ) < 0$. Thus, v must have a negative minimum in $\partial(B_{1/4}(y_\circ) \cap \Omega)$.

However, if c_1/C_2 and δ are small enough, then we reach a contradiction as follows:

On $\partial\Omega$ we have $v \geq 0$. On $\partial B_{1/4}(y_\circ) \cap N_\delta$ we have

$$v \geq -c_1 - C_\circ \gamma \delta^2 + \frac{\gamma}{2n} \left(\frac{1}{4} \right)^2 \geq 0 \quad \text{on } \partial B_{1/4}(y_\circ) \cap N_\delta.$$

On $\partial B_{1/4}(y_\circ) \cap (\Omega \setminus N_\delta)$ we have

$$v \geq C_2 - C_\circ \gamma \geq 0 \quad \text{on } \partial B_{1/4}(y_\circ) \cap (\Omega \setminus N_\delta).$$

Here, we used that $\|u_{r_\circ}\|_{C^{1,1}(B_1)} \leq C_\circ$, and chose $C_\circ c_1 \leq \gamma \leq C_2/C_\circ$. \square

Using the previous lemma, we can now show that there is a cone of directions τ in which the solution is monotone near the origin.

Proposition 5.33. *Let u be any solution to (5.14), and assume that (5.19) holds. Let $u_r(x) = r^{-2}u(rx)$. Then, there exist $r_\circ > 0$ and $e \in \mathbb{S}^{n-1}$ such that*

$$\partial_\tau u_{r_\circ} \geq 0 \quad \text{in } B_{1/2}$$

for every $\tau \in \mathbb{S}^{n-1}$ satisfying $\tau \cdot e \geq \frac{1}{2}$.

Proof. By Proposition 5.31, for any $\varepsilon > 0$ there exist $e \in \mathbb{S}^{n-1}$ and $r_o > 0$ such that

$$(5.20) \quad \left| u_{r_o}(x) - \frac{1}{2}(x \cdot e)_+^2 \right| \leq \varepsilon \quad \text{in } B_1$$

and

$$(5.21) \quad \left| \partial_\tau u_{r_o}(x) - (x \cdot e)_+(\tau \cdot e) \right| \leq \varepsilon \quad \text{in } B_1$$

for all $\tau \in \mathbb{S}^{n-1}$.

We now want to use Lemma 5.32 to deduce that $\partial_\tau u_{r_o} \geq 0$ if $\tau \cdot e \geq \frac{1}{2}$. First, we claim that

$$(5.22) \quad \begin{aligned} u_{r_o} &> 0 \quad \text{in } \{x \cdot e > C_o \sqrt{\varepsilon}\}, \\ u_{r_o} &= 0 \quad \text{in } \{x \cdot e < -C_o \sqrt{\varepsilon}\}, \end{aligned}$$

and therefore the free boundary $\partial\Omega = \partial\{u_{r_o} > 0\}$ is contained in the strip $\{|x \cdot e| \leq C_o \sqrt{\varepsilon}\}$, for some C_o depending only on n (see Figure 5.13). To prove this, notice that if $x \cdot e > C_o \sqrt{\varepsilon}$ then

$$u_{r_o} > \frac{1}{2}(C_o \sqrt{\varepsilon})^2 - \varepsilon > 0,$$

while if there was a free boundary point x_o in $\{x \cdot e < -C_o \varepsilon\}$ then by nondegeneracy we would get

$$\sup_{B_{C_o \sqrt{\varepsilon}}(x_o)} u_{r_o} \geq c(C_o \sqrt{\varepsilon})^2 > 2\varepsilon,$$

a contradiction with (5.20).

Therefore, we have

$$\partial\Omega \subset \{|x \cdot e| \leq C_o \sqrt{\varepsilon}\}.$$

Now, for each $\tau \in \mathbb{S}^{n-1}$ satisfying $\tau \cdot e \geq \frac{1}{2}$ we define

$$w := \partial_\tau u_{r_o}.$$

In order to use Lemma 5.32, we notice:

- (a) w is bounded and harmonic in $\Omega \cap B_1$.
- (b) $w = 0$ on $\partial\Omega \cap B_1$.
- (c) Thanks to (5.21), if $\delta \gg \sqrt{\varepsilon}$ then w satisfies

$$w \geq -\varepsilon \quad \text{in } N_\delta$$

and

$$w \geq \delta/4 > 0 \quad \text{in } (\Omega \setminus N_\delta) \cap B_1.$$

— DRAFT —

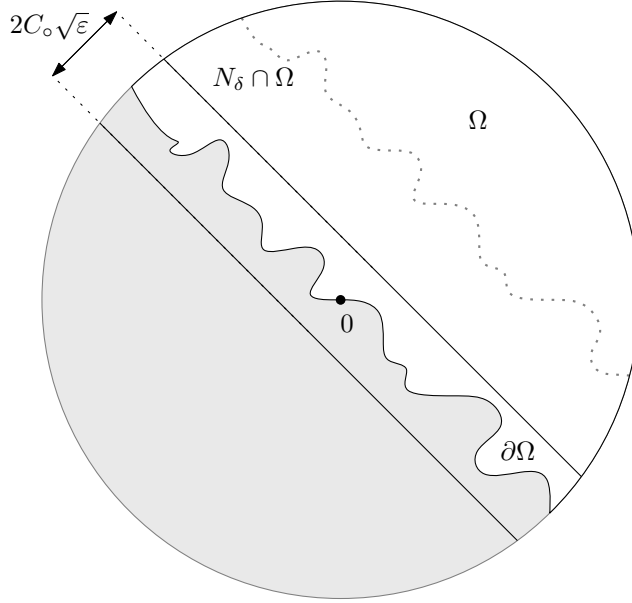

Figure 5.13. The setting in which we use Lemma 5.32.

(We recall $N_\delta := \{x \in B_1 : \text{dist}(x, \partial\Omega) < \delta\}$.)

Indeed, to check the last inequality we use that, by (5.22), we have $\{x \cdot e < \delta - C_0\sqrt{\varepsilon}\} \cap \Omega \subset N_\delta$. Thus, by (5.21), we get that for all $x \in (\Omega \setminus N_\delta) \cap B_1$

$$w \geq \frac{1}{2}(x \cdot e)_+ - \varepsilon \geq \frac{1}{2}\delta - \frac{1}{2}C_0\sqrt{\varepsilon} - \varepsilon \geq \frac{1}{4}\delta,$$

provided that $\delta \gg \sqrt{\varepsilon}$.

Using (a)-(b)-(c), we deduce from Lemma 5.32 that

$$w \geq 0 \quad \text{in } B_{1/2}.$$

Since we can do this for every $\tau \in \mathbb{S}^{n-1}$ with $\tau \cdot e \geq \frac{1}{2}$, the proposition is proved. \square

As a consequence of the previous proposition, we find:

Corollary 5.34. *Let u be any solution to (5.14), and assume that (5.19) holds. Then, there exists $r_0 > 0$ such that the free boundary $\partial\{u_{r_0} > 0\}$ is Lipschitz in $B_{1/2}$. In particular, the free boundary of u , $\partial\{u > 0\}$, is Lipschitz in $B_{r_0/2}$.*

Proof. This follows from the fact that $\partial_\tau u_{r_0} \geq 0$ in $B_{1/2}$ for all $\tau \in \mathbb{S}^{n-1}$ with $\tau \cdot e \geq \frac{1}{2}$ (by Proposition 5.33), as explained next.

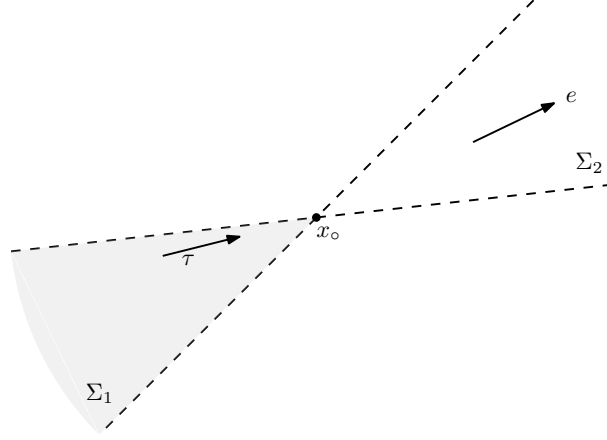

Figure 5.14. Representation of Σ_1 and Σ_2 .

Let $x_o \in B_{1/2} \cap \partial\{u_{r_o} > 0\}$ be any free boundary point in $B_{1/2}$, and let

$$\Theta := \{\tau \in \mathbb{S}^{n-1} : \tau \cdot e > \frac{1}{2}\},$$

$$\Sigma_1 := \{x \in B_{1/2} : x = x_o - t\tau, \text{ with } \tau \in \Theta, t > 0\},$$

and

$$\Sigma_2 := \{x \in B_{1/2} : x = x_o + t\tau, \text{ with } \tau \in \Theta, t > 0\},$$

see Figure 5.14.

We claim that

$$(5.23) \quad \begin{cases} u_{r_o} = 0 & \text{in } \Sigma_1, \\ u_{r_o} > 0 & \text{in } \Sigma_2. \end{cases}$$

Indeed, since $u_{r_o}(x_o) = 0$, it follows from the monotonicity property $\partial_\tau u_{r_o} \geq 0$ — and the nonnegativity of u_{r_o} — that $u_{r_o}(x_o - t\tau) = 0$ for all $t > 0$ and $\tau \in \Theta$. In particular, there cannot be any free boundary point in Σ_1 .

On the other hand, by the same argument, if $u_{r_o}(x_1) = 0$ for some $x_1 \in \Sigma_2$ then we would have $u_{r_o} = 0$ in $\{x \in B_{1/2} : x = x_1 - t\tau, \text{ with } \tau \in \Theta, t > 0\} \ni x_o$, and in particular x_o would not be a free boundary point. Thus, $u_{r_o}(x_1) > 0$ for all $x_1 \in \Sigma_2$, and (5.23) is proved.

Finally, notice that (5.23) yields that the free boundary $\partial\{u_{r_o} > 0\} \cap B_{1/2}$ satisfies both the interior and exterior cone condition, and thus it is Lipschitz. \square

Once we know that the free boundary is Lipschitz, we may assume without loss of generality that $e = e_n$ and that

$$\partial\{u_{r_o} > 0\} \cap B_{1/2} = \{x_n = g(x')\} \cap B_{1/2}$$

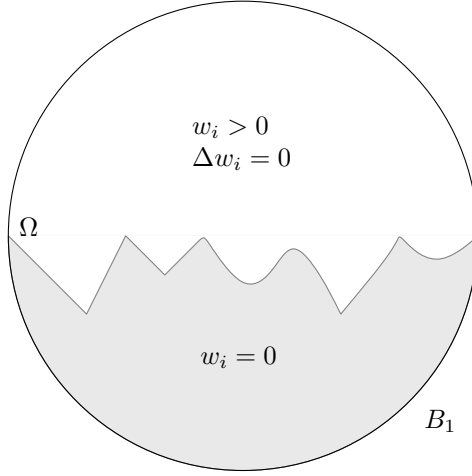

Figure 5.15. Setting of the boundary Harnack.

for a Lipschitz function $g : \mathbb{R}^{n-1} \rightarrow \mathbb{R}$. Here, $x = (x', x_n)$, with $x' \in \mathbb{R}^{n-1}$ and $x_n \in \mathbb{R}$.

Now, we want to prove that Lipschitz free boundaries are $C^{1,\alpha}$. A key ingredient for this will be the following basic property of harmonic functions (see Figure 5.15 for a representation of the setting).

Theorem 5.35 (Boundary Harnack). *Let w_1 and w_2 be positive harmonic functions in $B_1 \cap \Omega$, where $\Omega \subset \mathbb{R}^n$ is any Lipschitz domain.*

Assume that w_1 and w_2 vanish on $\partial\Omega \cap B_1$, and $C_\circ^{-1} \leq \|w_i\|_{L^\infty(B_{1/2})} \leq C_\circ$ for $i = 1, 2$. Then,

$$\frac{1}{C} w_2 \leq w_1 \leq C w_2 \quad \text{in } \bar{\Omega} \cap B_{1/2}.$$

Moreover,

$$\left\| \frac{w_1}{w_2} \right\|_{C^{0,\alpha}(\bar{\Omega} \cap B_{1/2})} \leq C$$

for some small $\alpha > 0$. The constants α and C depend only on n , C_\circ , and Ω .

For completeness, we provide in Appendix B a proof of this result. We refer to [DS20] for the boundary Harnack for more general operators and to [AS19, RT21] for the boundary Harnack for equations with a right hand side.

Remark 5.36. The main point in Theorem 5.35 is that Ω is allowed to be Lipschitz. If Ω is smooth (say, C^2 or even $C^{1,\alpha}$) then it follows from a simple barrier argument that both w_1 and w_2 would be comparable to the distance to $\partial\Omega$, i.e., they vanish at a linear rate from $\partial\Omega$. However, in Lipschitz

domains the result cannot be proved with a simple barrier argument, and it is much more delicate to establish.

The boundary Harnack is a crucial tool in the study of free boundary problems, and in particular in the obstacle problem. Here, we use it to prove that the free boundary is $C^{1,\alpha}$ for some small $\alpha > 0$.

Proposition 5.37. *Let u be any solution to (5.14), and assume that (5.19) holds. Then, there exists $r_o > 0$ such that the free boundary $\partial\{u_{r_o} > 0\}$ is $C^{1,\alpha}$ in $B_{1/4}$, for some small $\alpha > 0$. In particular, the free boundary of u , $\partial\{u > 0\}$, is $C^{1,\alpha}$ in $B_{r_o/4}$.*

Proof. Let $\Omega = \{u_{r_o} > 0\}$. By Corollary 5.34, if $r_o > 0$ is small enough then (possibly after a rotation) we have

$$\Omega \cap B_{1/2} = \{x_n \geq g(x')\} \cap B_{1/2}$$

and the free boundary is given by

$$\partial\Omega \cap B_{1/2} = \{x_n = g(x')\} \cap B_{1/2},$$

where g is Lipschitz.

Let

$$w_2 := \partial_{e_n} u_{r_o}$$

and

$$w_1 := \partial_{e_i} u_{r_o} + \partial_{e_n} u_{r_o}, \quad i = 1, \dots, n-1.$$

Since $\partial_\tau u_{r_o} \geq 0$ in $B_{1/2}$ for all $\tau \in \mathbb{S}^{n-1}$ with $\tau \cdot e_n \geq \frac{1}{2}$, we have that $w_2 \geq 0$ in $B_{1/2}$ and $w_1 \geq 0$ in $B_{1/2}$.

This is because $\partial_{e_i} + \partial_{e_n} = \partial_{e_i+e_n} = \sqrt{2}\partial_\tau$, with $\tau \cdot e_n = 1/\sqrt{2} > \frac{1}{2}$. Notice that we add the term $\partial_{e_n} u_{r_o}$ in w_1 in order to get a nonnegative function $w_2 \geq 0$.

Now since w_1 and w_2 are positive harmonic functions in $\Omega \cap B_{1/2}$, and vanish on $\partial\Omega \cap B_{1/2}$, we can use the boundary Harnack, Theorem 5.35 (or Corollary B.2), to get

$$\left\| \frac{w_1}{w_2} \right\|_{C^{0,\alpha}(\bar{\Omega} \cap B_{1/4})} \leq C$$

for some small $\alpha > 0$. Therefore, since $w_1/w_2 = 1 + \partial_{e_i} u_{r_o} / \partial_{e_n} u_{r_o}$, we deduce

$$(5.24) \quad \left\| \frac{\partial_{e_i} u_{r_o}}{\partial_{e_n} u_{r_o}} \right\|_{C^{0,\alpha}(\bar{\Omega} \cap B_{1/4})} \leq C.$$

Now, we claim that this implies that the free boundary is $C^{1,\alpha}$ in $B_{1/4}$. Indeed, if $u_{r_o}(x) = t$ then the normal vector to the level set $\{u_{r_o} = t\}$ is

given by

$$\nu^i(x) = \frac{\partial_{e_i} u_{r_\circ}}{|\nabla u_{r_\circ}|} = \frac{\partial_{e_i} u_{r_\circ} / \partial_{e_n} u_{r_\circ}}{\sqrt{1 + \sum_{j=1}^{n-1} (\partial_{e_j} u_{r_\circ} / \partial_{e_n} u_{r_\circ})^2}}, \quad i = 1, \dots, n.$$

This is a $C^{0,\alpha}$ function by (5.24), and therefore we can take $t \rightarrow 0$ to find that the free boundary is $C^{1,\alpha}$ (since the normal vector to the free boundary is given by a $C^{0,\alpha}$ function). \square

So far we have proved that

$$\left(\begin{array}{l} \{u = 0\} \text{ has positive} \\ \text{density at the origin} \end{array} \right) \implies \left(\begin{array}{l} \text{any blow-up is} \\ u_0 = \frac{1}{2}(x \cdot e)_+^2 \end{array} \right) \implies \left(\begin{array}{l} \text{free boundary} \\ \text{is } C^{1,\alpha} \text{ near } 0 \end{array} \right)$$

As a last step in this section, we will now prove that $C^{1,\alpha}$ free boundaries are actually C^∞ .

Higher regularity of the free boundary. We want to finally prove the smoothness of free boundaries near regular points.

Theorem 5.38 (Smoothness of the free boundary near regular points). *Let u be any solution to (5.14), and assume that (5.19) holds. Then, the free boundary $\partial\{u > 0\}$ is C^∞ in a neighborhood of the origin.*

For this, we need the following result.

Theorem 5.39 (Higher order boundary Harnack). *Let $\Omega \subset \mathbb{R}^n$ be any $C^{k,\alpha}$ domain, with $k \geq 1$ and $\alpha \in (0, 1)$. Let w_1, w_2 be two solutions of $\Delta w_i = 0$ in $B_1 \cap \Omega$, $w_i = 0$ on $\partial\Omega \cap B_1$, with $w_2 > 0$ in Ω .*

Assume that $C_\circ^{-1} \leq \|w_i\|_{L^\infty(B_{1/2})} \leq C_\circ$. Then,

$$\left\| \frac{w_1}{w_2} \right\|_{C^{k,\alpha}(\bar{\Omega} \cap B_{1/2})} \leq C,$$

where C depends only on n, k, α, C_\circ , and Ω .

Contrary to Theorem 5.35, the proof of Theorem 5.39 is a perturbative argument, in the spirit of (but much more delicate than) the Schauder estimates from Chapter 3. We will not prove the higher order boundary Harnack here; we refer to [DS16] for the proof of such result.

Using Theorem 5.39, we can finally prove Theorem 5.38:

Proof of Theorem 5.38. Let $u_{r_\circ}(x) = r_\circ^{-2}u(r_\circ x)$. By Proposition 5.37, we know that if $r_\circ > 0$ is small enough then the free boundary $\partial\{u_{r_\circ} > 0\}$ is $C^{1,\alpha}$ in B_1 , and (possibly after a rotation) $\partial_{e_n} u_{r_\circ} > 0$ in $\{u_{r_\circ} > 0\} \cap B_1$.

Thus, using the higher order boundary Harnack (Theorem 5.39) with $w_1 = \partial_{e_i} u_{r_o}$ and $w_2 = \partial_{e_n} u_{r_o}$, we find that

$$\left\| \frac{\partial_{e_i} u_{r_o}}{\partial_{e_n} u_{r_o}} \right\|_{C^{1,\alpha}(\bar{\Omega} \cap B_{1/2})} \leq C.$$

Actually, by a simple covering argument we find that

$$(5.25) \quad \left\| \frac{\partial_{e_i} u_{r_o}}{\partial_{e_n} u_{r_o}} \right\|_{C^{1,\alpha}(\bar{\Omega} \cap B_{1-\delta})} \leq C_\delta$$

for any $\delta > 0$.

Now, as in the proof of Proposition 5.37, we notice that if $u_{r_o}(x) = t$ then the normal vector to the level set $\{u_{r_o} = t\}$ is given by

$$\nu^i(x) = \frac{\partial_{e_i} u_{r_o}}{|\nabla u_{r_o}|} = \frac{\partial_{e_i} u_{r_o} / \partial_{e_n} u_{r_o}}{\sqrt{1 + \sum_{j=1}^n (\partial_{e_j} u_{r_o} / \partial_{e_n} u_{r_o})^2}}, \quad i = 1, \dots, n.$$

By (5.25), this is a $C^{1,\alpha}$ function in $B_{1-\delta}$ for any $\delta > 0$, and therefore we can take $t \rightarrow 0$ to find that the normal vector to the free boundary is $C^{1,\alpha}$ inside B_1 . But this means that the free boundary is actually $C^{2,\alpha}$.

Repeating now the same argument, and using that the free boundary is $C^{2,\alpha}$ in $B_{1-\delta}$ for any $\delta > 0$, we find that

$$\left\| \frac{\partial_{e_i} u_{r_o}}{\partial_{e_n} u_{r_o}} \right\|_{C^{2,\alpha}(\bar{\Omega} \cap B_{1-\delta'})} \leq C_{\delta'},$$

which yields that the normal vector is $C^{2,\alpha}$ and thus the free boundary is $C^{3,\alpha}$. Iterating this argument, we find that the free boundary $\partial\{u_{r_o} > 0\}$ is C^∞ inside B_1 , and hence $\partial\{u > 0\}$ is C^∞ in a neighborhood of the origin. \square

This completes the study of *regular* free boundary points. It remains to understand what happens at points where the contact set has *density zero* (see e.g. Figure 5.9). This is the content of the next section.

5.7. Singular points

We finally study the behavior of the free boundary at singular points, i.e., when

$$(5.26) \quad \lim_{r \rightarrow 0} \frac{|\{u = 0\} \cap B_r|}{|B_r|} = 0.$$

For this, we first notice that, as a consequence of the results of the previous Section, we get the following.

Proposition 5.40. *Let u be any solution to (5.14). Then, we have the following dichotomy:*

(a) Either (5.19) holds and all blow-ups of u at 0 are of the form

$$u_0(x) = \frac{1}{2}(x \cdot e)_+^2,$$

for some $e \in \mathbb{S}^{n-1}$.

(b) Or (5.26) holds and all blow-ups of u at 0 are of the form

$$u_0(x) = \frac{1}{2}x^T A x,$$

for some matrix $A \geq 0$ with $\text{tr } A = 1$.

Points of type (a) were studied in the previous Section; they are called *regular* points and the free boundary is C^∞ around them (in particular, the blow-up is unique). Points of type (b) are those at which the contact set has zero density, and are called *singular* points.

To prove the result, we need the following:

Lemma 5.41. *Let u be any solution to (5.14), and assume that (5.26) holds. Then, every blow-up of u at 0 satisfies $|\{u_0 = 0\}| = 0$.*

Proof. Let u_0 be a blow-up of u at 0, i.e., $u_{r_k} \rightarrow u_0$ in $C_{\text{loc}}^1(\mathbb{R}^n)$ along a sequence $r_k \rightarrow 0$, where $u_r(x) = r^{-2}u(rx)$.

Notice that the functions u_r solve

$$\Delta u_r = \chi_{\{u_r > 0\}} \quad \text{in } B_1,$$

in the sense that

$$(5.27) \quad \int_{B_1} \nabla u_r \cdot \nabla \eta \, dx = \int_{B_1} \chi_{\{u_r > 0\}} \eta \, dx \quad \text{for all } \eta \in C_c^\infty(B_1).$$

Moreover, by assumption (5.26), we have $|\{u_r = 0\} \cap B_1| \rightarrow 0$, and thus taking limits $r_k \rightarrow 0$ in (5.27) we deduce that $\Delta u_0 = 1$ in B_1 . Since we know that u_0 is convex, nonnegative, and homogeneous, this implies that $|\{u_0 = 0\}| = 0$. \square

We can now give the:

Proof of Theorem 5.40. By the classification of blow-ups (Theorem 5.24), the possible blow-ups can only have one of the two forms presented. If (5.19) holds for at least one blow-up, thanks to the smoothness of the free boundary (by Proposition 5.37), it holds for all blow-ups, and thus, by Corollary 5.30, $u_0(x) = \frac{1}{2}(x \cdot e)_+^2$ (and in fact, the smoothness of the free boundary yields uniqueness of the blow-up in this case).

If (5.26) holds, then by Lemma 5.41 the blow-up u_0 must satisfy $|\{u_0 = 0\}| = 0$, and thus we are in case (b) (see the proof of Theorem 5.24). \square

DRAFT

In the previous Section we proved that the free boundary is C^∞ in a neighborhood of any regular point. A natural question then is to understand better the solution u near singular points. One of the main results in this direction is the following.

Theorem 5.42 (Uniqueness of blow-ups at singular points). *Let u be any solution to (5.14), and assume that 0 is a singular free boundary point.*

Then, there exists a homogeneous quadratic polynomial $p_2(x) = \frac{1}{2}x^T Ax$, with $A \geq 0$ and $\Delta p_2 = 1$, such that

$$u_r \longrightarrow p_2 \quad \text{in } C_{\text{loc}}^1(\mathbb{R}^n).$$

In particular, the blow-up of u at 0 is unique, and $u(x) = p_2(x) + o(|x|^2)$.

To prove this, we need the following monotonicity formula due to Monneau.

Theorem 5.43 (Monneau's monotonicity formula). *Let u be any solution to (5.14), and assume that 0 is a singular free boundary point.*

Let q be any homogeneous quadratic polynomial with $q \geq 0$, $q(0) = 0$, and $\Delta q = 1$. Then, the quantity

$$M_{u,q}(r) := \frac{1}{r^{n+3}} \int_{\partial B_r} (u - q)^2$$

is monotone in r , that is, $\frac{d}{dr} M_{u,q}(r) \geq 0$.

Proof. We sketch the argument here, and refer to [PSU12, Theorem 7.4] for more details.

We first notice that

$$M_{u,q}(r) = \int_{\partial B_1} \frac{(u - q)^2(rx)}{r^4},$$

and hence a direct computation yields

$$\frac{d}{dr} M_{u,q}(r) = \frac{2}{r^{n+4}} \int_{\partial B_r} (u - q) \{x \cdot \nabla(u - q) - 2(u - q)\}.$$

On the other hand, it turns out that

$$\begin{aligned} \frac{1}{r^{n+3}} \int_{\partial B_r} (u - q) \{x \cdot \nabla(u - q) - 2(u - q)\} &= W_u(r) - W_u(0^+) + \\ &+ \frac{1}{r^{n+2}} \int_{B_r} (u - q) \Delta(u - q), \end{aligned}$$

where $W_u(r)$ (as defined in (5.15)) is monotone increasing in $r > 0$ thanks to Theorem 5.18. Thus, we have

$$\frac{d}{dr} M_{u,q}(r) \geq \frac{2}{r^{n+3}} \int_{B_r} (u - q) \Delta(u - q).$$

But since $\Delta u = \Delta q = 1$ in $\{u > 0\}$, and $(u - q)\Delta(u - q) = q \geq 0$ in $\{u = 0\}$, we have

$$\frac{d}{dr} M_{u,q}(r) \geq \frac{2}{r^{n+3}} \int_{B_r \cap \{u=0\}} q \geq 0,$$

as wanted. \square

We can now give the:

Proof of Theorem 5.42. By Proposition 5.40 (and Proposition 5.23), we know that at any singular point we have a subsequence $r_j \rightarrow 0$ along which $u_{r_j} \rightarrow p$ in $C_{\text{loc}}^1(\mathbb{R}^n)$, where p is a 2-homogeneous quadratic polynomial satisfying $p(0) = 0$, $p \geq 0$, and $\Delta p = 1$. Thus, we can use Monneau's monotonicity formula with such polynomial p to find that

$$M_{u,p}(r) := \frac{1}{r^{n+3}} \int_{\partial B_r} (u - p)^2$$

is monotone increasing in $r > 0$. In particular, the limit $\lim_{r \rightarrow 0} M_{u,p}(r) := M_{u,p}(0^+)$ exists.

Now, recall that we have a sequence $r_j \rightarrow 0$ along which $u_{r_j} \rightarrow p$. In particular, $r_j^{-2} \{u(r_j x) - p(r_j x)\} \rightarrow 0$ locally uniformly in \mathbb{R}^n , i.e.,

$$\frac{1}{r_j^2} \|u - p\|_{L^\infty(B_{r_j})} \rightarrow 0$$

as $r_j \rightarrow 0$. This yields that

$$M_{u,p}(r_j) \leq \frac{1}{r_j^{n+3}} \int_{\partial B_{r_j}} \|u - p\|_{L^\infty(B_{r_j})}^2 \rightarrow 0$$

along the subsequence $r_j \rightarrow 0$, and therefore $M_{u,p}(0^+) = 0$.

Let us show that this implies the uniqueness of blow-ups. Indeed, if there was another subsequence $r_\ell \rightarrow 0$ along which $u_{r_\ell} \rightarrow q$ in $C_{\text{loc}}^1(\mathbb{R}^n)$, for a 2-homogeneous quadratic polynomial q , then we would repeat the argument above to find that $M_{u,q}(0^+) = 0$. But then this yields, by homogeneity of p and q ,

$$\int_{\partial B_1} (p - q)^2 = \frac{1}{r^{n+3}} \int_{\partial B_r} (p - q)^2 \leq 2M_{u,p}(r) + 2M_{u,q}(r) \rightarrow 0,$$

and hence

$$\int_{\partial B_1} (p - q)^2 = 0.$$

This means that $p = q$, and thus the blow-up of u at 0 is unique.

Let us finally show that $u(x) = p(x) + o(|x|^2)$, i.e., $r^{-2} \|u - p\|_{L^\infty(B_r)} \rightarrow 0$ as $r \rightarrow 0$. Indeed, assume by contradiction that there is a subsequence

$r_k \rightarrow 0$ along which

$$r_k^{-2} \|u - p\|_{L^\infty(B_{r_k})} \geq c_1 > 0.$$

Then, there would be a subsequence of r_{k_i} along which $u_{r_{k_i}} \rightarrow u_0$ in $C_{\text{loc}}^1(\mathbb{R}^n)$, for a certain blow-up u_0 satisfying $\|u_0 - p\|_{L^\infty(B_1)} \geq c_1 > 0$. However, by uniqueness of blow-ups it must be $u_0 = p$, and hence we reach a contradiction. \square

We refer to [SY23, Bon01] for an alternative approach to the uniqueness of blow-ups at singular points, not based on monotonicity formulas.

Summarizing, we have proved the following result:

Theorem 5.44. *Let u be any solution to (5.14). Then, we have the following dichotomy:*

(a) *Either all blow-ups of u at 0 are of the form*

$$u_0(x) = \frac{1}{2}(x \cdot e)_+^2 \quad \text{for some } e \in \mathbb{S}^{n-1},$$

and the free boundary is C^∞ in a neighborhood of the origin.

(b) *Or there is a homogeneous quadratic polynomial p , with $p(0) = 0$, $p \geq 0$, and $\Delta p = 1$, such that*

$$\|u - p\|_{L^\infty(B_r)} = o(r^2) \quad \text{as } r \rightarrow 0.$$

In particular, when this happens we have

$$\lim_{r \rightarrow 0} \frac{|\{u = 0\} \cap B_r|}{|B_r|} = 0.$$

The last question that remains to be answered is: How large can the set of singular points be? This is the topic of the following section.

5.8. On the size of the singular set

We finish this chapter with a discussion of more recent results (as well as some open problems) about the set of singular points.

Recall that a free boundary point $x_\circ \in \partial\{u > 0\}$ is singular whenever

$$\lim_{r \rightarrow 0} \frac{|\{u = 0\} \cap B_r(x_\circ)|}{|B_r(x_\circ)|} = 0.$$

The main known result on the size of the singular set reads as follows.

Theorem 5.45 ([Caf98]). *Let u be any solution to (5.14). Let $\Sigma \subset B_1$ be the set of singular points.*

Then, $\Sigma \cap B_{1/2}$ is locally contained in a C^1 manifold of dimension $n - 1$.

This result is sharp, in the sense that it is not difficult to construct examples in which the singular set is $(n - 1)$ -dimensional; see [Sch77].

As explained below, such result essentially follows from the uniqueness of blow-ups at singular points, established in the previous section.

Indeed, given any singular point x_o , let p_{x_o} be the blow-up of u at x_o (recall that p_{x_o} is a nonnegative 2-homogeneous polynomial). Let k be the dimension of the set $\{p_{x_o} = 0\}$ — notice that this is a proper linear subspace of \mathbb{R}^n , so that $k \in \{0, \dots, n - 1\}$ — and define

$$(5.28) \quad \Sigma_k := \{x_o \in \Sigma : \dim(\{p_{x_o} = 0\}) = k\}.$$

Clearly, $\Sigma = \bigcup_{k=0}^{n-1} \Sigma_k$.

The following result gives a more precise description of the singular set.

Proposition 5.46 ([Caf98]). *Let u be any solution to (5.14). Let $\Sigma_k \subset B_1$ be defined by (5.28), $k = 1, \dots, n - 1$. Then, Σ_k is locally contained in a C^1 manifold of dimension k .*

The rough heuristic idea of the proof of this result is as follows. Assume for simplicity that $n = 2$, so that $\Sigma = \Sigma_1 \cup \Sigma_0$.

Let us take a point $x_o \in \Sigma_0$. Then, by Theorem 5.44, we have the expansion

$$(5.29) \quad u(x) = p_{x_o}(x - x_o) + o(|x - x_o|^2)$$

where p_{x_o} is the blow-up of u at x_o (recall that this came from the uniqueness of blow-ups at x_o). By definition of Σ_0 , the polynomial p_{x_o} must be positive outside the origin, and thus by homogeneity satisfies $p_{x_o}(x - x_o) \geq c|x - x_o|^2$, with $c > 0$. This, combined with (5.29), yields then that u must be positive in a neighborhood of x_o . In particular, all points in Σ_0 are isolated.

On the other hand, let us now take a point $x_o \in \Sigma_1$. Then, by definition of Σ_1 the blow-up must necessarily be of the form $p_{x_o}(x) = \frac{1}{2}(x \cdot e_{x_o})^2$, for some $e_{x_o} \in \mathbb{S}^{n-1}$. Again by the expansion (5.29), we find that u is positive in a region of the form

$$\{x \in B_\rho(x_o) : |(x - x_o) \cdot e_{x_o}| > \omega(|x - x_o|)\},$$

where ω is a certain modulus of continuity, and $\rho > 0$ is small (see Figure 5.16).

This is roughly saying that the set Σ_1 “has a tangent plane” at x_o . Repeating the same at any other point $\tilde{x}_o \in \Sigma_1$ we find that the same happens at every point in Σ_1 and, moreover, if \tilde{x}_o is close to x_o then $e_{\tilde{x}_o}$ must be close to e_{x_o} — otherwise the expansions (5.29) at \tilde{x}_o and x_o would not match. Finally, since the modulus ω can be made independent of the

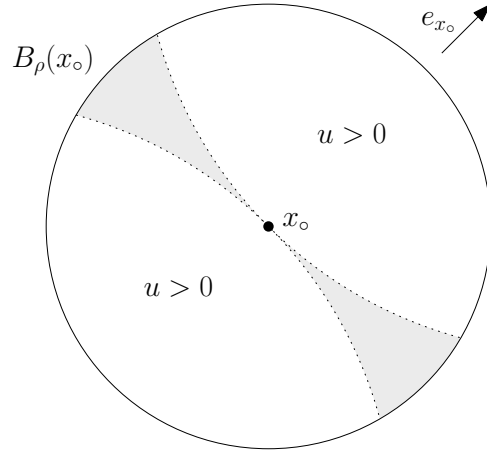

Figure 5.16. u is positive in $\{x \in B_\rho(x_o) : |(x - x_o) \cdot e_{x_o}| > \omega(|x - x_o|)\}$.

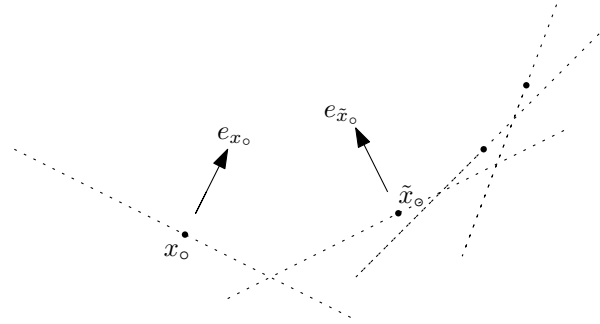

Figure 5.17. Singular points $x_o, \tilde{x}_o \in \Sigma_1$.

point (by a compactness argument), it turns out that the set Σ_1 is contained in a C^1 curve (see Figure 5.17).

What we discussed here is just an heuristic argument; the actual proof uses Whitney’s extension theorem and can be found for example in [PSU12]. Finally, we refer to [CSV18], [FS19], and [FZ21] (and the expository paper [Fig18b]) for some recent finer results about the set of singular points.

Generic regularity. In PDE problems in which singularities may appear, it is very natural and important to understand whether these singularities appear “often”, or if instead “most” solutions have no singularities.

In the context of the obstacle problem, the key question is to understand the generic regularity of free boundaries. Explicit examples show that singular points in the obstacle problem can form a very large set, of dimension

$n - 1$ (as large as the regular set). Still, singular points are expected to be rare (see [Sch74]):

Conjecture (Schaeffer, 1974): *Generically, the weak solution of the obstacle problem is also a strong solution, in the sense that the free boundary is a C^∞ manifold.*

In other words, the conjecture states that, generically, the free boundary has *no* singular points.

The first result in this direction was established by Monneau in 2003, who proved the following.

Theorem 5.47 ([Mon03]). *Schaeffer's conjecture holds in \mathbb{R}^2 .*

More precisely, Monneau considers a 1-parameter family of solutions u_λ , with $\lambda \in (0, 1)$, such that

$$\begin{cases} \Delta u_\lambda = \chi_{\{u_\lambda > 0\}} & \text{in } \Omega \\ u_\lambda = g_\lambda & \text{on } \partial\Omega, \end{cases}$$

with $g_\lambda = g + \lambda$ and $g \geq 0$ on $\partial\Omega$.

Then, the first step is to notice that not only each of the singular sets $\Sigma_\lambda \subset \Omega$ is contained in a C^1 manifold of dimension $(n - 1)$, but actually the union $\bigcup_{\lambda \in (0, 1)} \Sigma_\lambda \subset \Omega$ is still contained in an $(n - 1)$ -dimensional manifold.

After that, we look at the free boundary as a set in $\Omega \times (0, 1) \ni (x, \lambda)$, and notice that it can be written as a graph $\{\lambda = h(x)\}$, for some function h . A second key step in the proof is to show that h is Lipschitz and, furthermore, it has zero gradient at any singular point. This, combined with the coarea formula, yields that in \mathbb{R}^2 the set of singular points is empty for almost every $\lambda \in (0, 1)$, which implies Theorem 5.47.

Finally, the best known result in this direction was established very recently by Figalli, Serra, and the second author.

Theorem 5.48 ([FRS20]). *Schaeffer's conjecture holds in \mathbb{R}^3 and \mathbb{R}^4 .*

The proof of this result is based on a new and very fine understanding of singular points. For this, [FRS20] combines Geometric Measure Theory tools, PDE estimates, several dimension reduction arguments, and even several new monotonicity formulas.

It remains an open problem to decide whether or not Schaeffer's conjecture holds in dimensions $n \geq 5$ or not.

Some properties of Hölder spaces

In this appendix, we prove the properties **(H1)**-**(H8)** stated in Chapter 1.

Recall that, given $\alpha \in (0, 1]$, the Hölder space $C^{0,\alpha}(\overline{\Omega})$ is the set of functions $u \in C(\overline{\Omega})$ such that

$$[u]_{C^{0,\alpha}(\overline{\Omega})} := \sup_{\substack{x,y \in \overline{\Omega} \\ x \neq y}} \frac{|u(x) - u(y)|}{|x - y|^\alpha} < \infty.$$

The Hölder norm is

$$\|u\|_{C^{0,\alpha}(\overline{\Omega})} := \|u\|_{L^\infty(\Omega)} + [u]_{C^{0,\alpha}(\overline{\Omega})}.$$

When $\alpha = 1$, this is the usual space of Lipschitz functions.

More generally, given $k \in \mathbb{N}$ and $\alpha \in (0, 1]$, the space $C^{k,\alpha}(\overline{\Omega})$ is the set of functions $u \in C^k(\overline{\Omega})$ such that the following norm is finite

$$\begin{aligned} \|u\|_{C^{k,\alpha}(\overline{\Omega})} &:= \sum_{j=1}^k \|D^j u\|_{L^\infty(\Omega)} + \sup_{\substack{x,y \in \overline{\Omega} \\ x \neq y}} \frac{|D^k u(x) - D^k u(y)|}{|x - y|^\alpha} \\ &= \|u\|_{C^k(\Omega)} + [D^k u]_{C^{0,\alpha}(\overline{\Omega})}. \end{aligned}$$

Finally, when $\beta > 0$ is *not* an integer, we denote $C^\beta(\overline{\Omega}) := C^{k,\alpha}(\overline{\Omega})$, where $\beta = k + \alpha$, with $k \in \mathbb{N}$, $\alpha \in (0, 1)$.

Next, we give the proofs of the properties of Hölder spaces that we have used throughout the book. Unless stated otherwise, in the following statements we assume $\alpha \in (0, 1)$.

DRAFT

(H1) *Assume*

$$\text{osc}_{B_r(x)} u \leq C_\circ r^\alpha \quad \text{for all } B_r(x) \subset \overline{B_1},$$

where $\text{osc}_A u := \sup_A u - \inf_A u$.

Then, $u \in C^{0,\alpha}(\overline{B_1})$ and $[u]_{C^{0,\alpha}(\overline{B_1})} \leq CC_\circ$, with C depending only on n, α .

• **Proof of (H1)** We want to prove that $|u(z) - u(x)| \leq CC_\circ |z - x|^\alpha$ for all $z, x \in B_1$. Given $z, x \in B_1$, let $r = |z - x|$. For this, we may assume $r < 1/10$ and distinguish two cases:

(i) If $B_r(x) \subset B_1$, then we simply use the assumption to get

$$|u(z) - u(x)| \leq \text{osc}_{B_r(x)} u \leq C_\circ r^\alpha = C_\circ |z - x|^\alpha.$$

(ii) Otherwise, we take \bar{x} and \bar{z} on the segments $\overline{0x}$ and $\overline{0z}$, respectively, such that $|x - \bar{x}| = r$ and $|z - \bar{z}| = r$. Then, by assumption we have $|u(x) - u(\bar{x})| \leq C_\circ r^\alpha$, $|u(z) - u(\bar{z})| \leq C_\circ r^\alpha$, and $|u(\bar{x}) - u(\bar{z})| \leq C_\circ r^\alpha$. The last inequality holds because $|\bar{x} - \bar{z}| < r$, which can be easily checked by construction of \bar{x} and \bar{z} .

Combining the last three inequalities, we deduce that $|u(x) - u(z)| \leq 3C_\circ r^\alpha$, as wanted. \square

We also state and prove the following slight modification of **(H1)**, which will be useful in later proofs. Notice that the difference with respect to the previous statement is that now, given any ball in B_1 , we control the oscillation in the ball with half the radius.

(H1') *Assume*

$$\text{osc}_{B_r(x)} u \leq C_\circ r^\alpha \quad \text{for all } B_{2r}(x) \subset \overline{B_1},$$

where $\text{osc}_A u := \sup_A u - \inf_A u$.

Then, $u \in C^{0,\alpha}(\overline{B_1})$ and $[u]_{C^{0,\alpha}(\overline{B_1})} \leq CC_\circ$, with C depending only on n, α .

• **Proof of (H1')**. We proceed analogously to the proof of **(H1)**. Let $z, x \in B_1$, and let $r = |z - x|$. We may assume that $r < 1/10$. If $B_{2r}(x) \subset B_1$, the result follows by assumption.

Otherwise, let us take \bar{x} and \bar{z} on the segments $\overline{0x}$ and $\overline{0z}$, respectively, such that $|x - \bar{x}| = 2r$ and $|z - \bar{z}| = 2r$. Let us define $x_k = (1 - 2^{-k})x + 2^{-k}\bar{x}$ and $z_k = (1 - 2^{-k})z + 2^{-k}\bar{z}$. Notice that $|x_{k+1} - x_k| = |z_{k+1} - z_k| = 2^{-k}r$. Also, $|x_k| = |x| - 2^{-k+1}r$, so that $B_{2|x_{k+1} - x_k|}(x_k) \subset B_1$. That is, we can use our assumption on x_k and x_{k+1} to get that

$$|u(x_k) - u(x_{k+1})| \leq C_\circ |x_k - x_{k+1}|^\alpha = C_\circ 2^{-k\alpha} r^\alpha.$$

(An analogous result holds for z_k .) On the other hand, by choice of \bar{x} and \bar{z} , they can also be compared in the oscillation of u as

$$|u(\bar{x}) - u(\bar{z})| \leq C_o |\bar{x} - \bar{z}|^\alpha \leq C_o r^\alpha.$$

Putting everything together, we reach that

$$\begin{aligned} |u(x) - u(z)| &\leq \sum_{k \geq 0} |u(x_{k+1}) - u(x_k)| + |u(\bar{x}) - u(\bar{z})| + \sum_{k \geq 0} |u(z_{k+1}) - u(z_k)| \\ &\leq 2 \sum_{k \geq 0} C_o 2^{-k\alpha} r^\alpha + C_o r^\alpha \leq CC_o r^\alpha, \end{aligned}$$

for some constant C depending only on α . \square

(H2) Let $u_{x,r} := \fint_{B_r(x)} u$. Assume

$$\|u - u_{x,r}\|_{L^\infty(B_r(x))} \leq C_o r^\alpha \quad \text{for all } B_r(x) \subset \overline{B_1}.$$

Then, $u \in C^{0,\alpha}(\overline{B_1})$ and $[u]_{C^{0,\alpha}(\overline{B_1})} \leq CC_o$, with C depending only on n, α .

• **Proof of (H2).** By the triangle inequality we have

$$\text{osc}_{B_r(x)} u \leq 2 \|u - u_{x,r}\|_{L^\infty(B_r(x))} \leq 2C_o r^\alpha,$$

and thus the result follows from **(H1)**. \square

(H3) Let $u_{x,r} := \fint_{B_r(x)} u$. Assume

$$\left(\fint_{B_r(x)} |u - u_{x,r}|^2 \right)^{1/2} \leq C_o r^\alpha \quad \text{for all } B_r(x) \subset \overline{B_1}.$$

Then, $u \in C^{0,\alpha}(\overline{B_1})$ and $[u]_{C^{0,\alpha}(\overline{B_1})} \leq CC_o$, with C depending only on n, α .

• **Proof of (H3).** Notice that, for every $z \in B_1$,

$$|u_{x,r} - u_{x,\frac{r}{2}}|^2 \leq 2|u(z) - u_{x,r}|^2 + 2|u(z) - u_{x,\frac{r}{2}}|^2.$$

Thus, integrating in $B_{r/2}(x)$ and using the assumption we deduce

$$\begin{aligned} |u_{x,r} - u_{x,\frac{r}{2}}|^2 &\leq 2 \fint_{B_{r/2}(x)} |u - u_{x,r}|^2 + 2 \fint_{B_{r/2}(x)} |u - u_{x,\frac{r}{2}}|^2 \\ &\leq 2^{n+1} \fint_{B_r(x)} |u - u_{x,r}|^2 + 2 \fint_{B_{r/2}(x)} |u - u_{x,\frac{r}{2}}|^2 \leq CC_o^2 r^{2\alpha}. \end{aligned}$$

This means that

$$|u_{x,r} - u_{x,\frac{r}{2}}| \leq CC_o r^\alpha,$$

and summing a geometric series we get

$$|u_{x,r} - u(x)| \leq \sum_{k \geq 0} |u_{x,\frac{r}{2^k}} - u_{x,\frac{r}{2^{k+1}}}| \leq \sum_{k \geq 0} CC_o \left(\frac{r}{2^k}\right)^\alpha = 2CC_o r^\alpha.$$

Here we used that, up to redefining u on a set of measure zero, by Lebesgue differentiation theorem (Theorem 1.1) we have that $u_{x,r} \rightarrow u(x)$ as $r \rightarrow 0$.

Let now $x, y \in B_1$, $r = 2|x - y|$, and assume that $B_r(x) \subset B_1$. Then, we have

$$\begin{aligned} |u_{x,r} - u_{y,r}|^2 &\leq \int_{B_{r/2}(x)} |u - u_{x,r}|^2 + \int_{B_{r/2}(x)} |u - u_{y,r}|^2 \\ &\leq 2^n \int_{B_r(x)} |u - u_{x,r}|^2 + 2^n \int_{B_r(y)} |u - u_{y,r}|^2 \leq CC_\circ^2 r^{2\alpha}, \end{aligned}$$

and thus

$$|u_{x,r} - u_{y,r}| \leq CC_\circ r^\alpha.$$

Combining the previous estimates, we deduce that for every $x, y \in B_1$ such that $B_{2|x-y|}(x) \subset B_1$, we have

$$|u(x) - u(y)| \leq |u(x) - u_{x,r}| + |u_{x,r} - u_{y,r}| + |u_{y,r} - u(y)| \leq 3CC_\circ r^\alpha.$$

Once we have this, by **(H1')** we are done. \square

(H4) Assume that for every x there is a constant C_x such that

$$\|u - C_x\|_{L^\infty(B_r(x))} \leq C_\circ r^\alpha \quad \text{for all } B_r(x) \subset \overline{B_1}.$$

Then, $u \in C^{0,\alpha}(\overline{B_1})$ and $[u]_{C^{0,\alpha}(\overline{B_1})} \leq CC_\circ$, with C depending only on n, α .

Assume that for every x there is a linear function $\ell_x(y) = a_x + b_x \cdot (y - x)$ such that

$$\|u - \ell_x\|_{L^\infty(B_r(x))} \leq C_\circ r^{1+\alpha} \quad \text{for all } B_r(x) \subset \overline{B_1}.$$

Then, $u \in C^{1,\alpha}(\overline{B_1})$ and $[Du]_{C^{0,\alpha}(\overline{B_1})} \leq CC_\circ$, with C depending only on n, α .

Assume that for every x there is a quadratic polynomial $P_x(y)$ such that

$$\|u - P_x\|_{L^\infty(B_r(x))} \leq C_\circ r^{2+\alpha} \quad \text{for all } B_r(x) \subset \overline{B_1}.$$

Then, $u \in C^{2,\alpha}(\overline{B_1})$ and $[D^2u]_{C^{0,\alpha}(\overline{B_1})} \leq CC_\circ$, with C depending only on n, α .

• **Proof of (H4).** (i) The first statement — with the $C^{0,\alpha}$ norm — follows from **(H1)**.

(ii) Let us sketch the proof of the second statement — with the $C^{1,\alpha}$ norm. Let $x, y \in B_1$ with $y \in B_r(x) \subset B_1$. Notice that, dividing by r and taking $r \rightarrow 0$ in the assumption, it follows that u is differentiable at x and that ℓ_x must be given by $\ell_x(y) = u(x) + \nabla u(x) \cdot (y - x)$. Thus, by assumption, we have

$$u(y) = u(x) + \nabla u(x) \cdot (y - x) + O(r^{1+\alpha})$$

and, for every $z \in B_r(x)$ such that $|z - y| \approx |z - x| \approx |y - x| \approx r$,

$$\begin{aligned} u(z) &= u(x) + \nabla u(x) \cdot (z - x) + O(r^{1+\alpha}) \\ &= u(y) + \nabla u(y) \cdot (z - y) + O(r^{1+\alpha}) \\ &= u(x) + \nabla u(x) \cdot (y - x) + \nabla u(y) \cdot (z - y) + O(r^{1+\alpha}). \end{aligned}$$

From this, we deduce that

$$\nabla u(x) \cdot (z - y) = \nabla u(y) \cdot (z - y) + O(r^{1+\alpha}).$$

Taking z such that $z - y$ is parallel to $\nabla u(y) - \nabla u(x)$, we get

$$\nabla u(x) = \nabla u(y) + O(r^\alpha),$$

as wanted.

(iii) Let us prove the third statement concerning the $C^{2,\alpha}$ norm — the following proof is more general and works also in case (ii).

Let $x, y \in B_r(x_\circ)$ with $|x - y| = r$ and suppose $B_{2r}(x_\circ) \subset B_1$. Let us rescale u around x_\circ , i.e., $u_r(z) := u(x_\circ + rz)$, so that $|\bar{x} - \bar{y}| = 1$, where $x_\circ + r\bar{x} = x$ and $x_\circ + r\bar{y} = y$. Let us define also

$$P_{x,r}(z) := P_x(x_\circ + rz) \quad \text{and} \quad P_{y,r} := P_y(x_\circ + rz).$$

Then,

$$\begin{aligned} \|u_r - P_{x,r}\|_{L^\infty(B_1(\bar{x}))} &= \|u - P_x\|_{L^\infty(B_r(x))} \leq C_\circ r^{2+\alpha}, \\ \|u_r - P_{y,r}\|_{L^\infty(B_1(\bar{y}))} &= \|u - P_y\|_{L^\infty(B_r(y))} \leq C_\circ r^{2+\alpha}. \end{aligned}$$

Hence, if we denote $\bar{w} = \frac{\bar{x} + \bar{y}}{2}$ then $B_{1/2}(\bar{w}) \subset B_1(\bar{x}) \cap B_1(\bar{y})$ and

$$\begin{aligned} \|P_{x,r} - P_{y,r}\|_{L^\infty(B_{1/2}(\bar{w}))} &\leq \|u_r - P_{x,r}\|_{L^\infty(B_1(\bar{x}))} + \|u_r - P_{y,r}\|_{L^\infty(B_1(\bar{y}))} \\ &\leq CC_\circ r^{2+\alpha}. \end{aligned}$$

This means that all the coefficients of the polynomial $P_{x,r} - P_{y,r}$ are controlled by $\tilde{C}C_\circ r^{2+\alpha}$.

Now, notice that if we denote $P_x(z) = a_x + b_x \cdot (z - x) + (z - x)^T M_x (z - x)$ then $P_{x,r}(z) = a_x + r b_x \cdot (z - \bar{x}) + r^2 (z - \bar{x})^T M_x (z - \bar{x})$, and an analogous expression holds for $P_{y,r}$. Hence, we can write

$$\begin{aligned} P_{x,r}(z) - P_{y,r}(z) &= (a_x - a_y + r b_x \cdot (\bar{y} - \bar{x}) + r^2 (\bar{y} - \bar{x})^T M_x (\bar{y} - \bar{x})) \\ &\quad + r (b_x - b_y + 2r (\bar{y} - \bar{x})^T M_x) \cdot (z - \bar{y}) \\ &\quad + r^2 (z - \bar{y})^T (M_x - M_y) (z - \bar{y}). \end{aligned}$$

In particular, by looking at the quadratic and linear coefficients of such polynomial, we have proved that

$$|M_x - M_y| \leq \tilde{C}C_\circ r^\alpha$$

and

$$|b_x - b_y + 2r (\bar{y} - \bar{x})^T M_x| \leq CC_\circ r^{1+\alpha}.$$

Since $r(\bar{y} - \bar{x}) = y - x$, this is equivalent to

$$|b_y - b_x - 2(y - x)^T M_x| \leq CC_\circ r^{1+\alpha}.$$

Notice, also, that

$$\|u - a_x - b_x \cdot (\cdot - x)\|_{L^\infty(B_r(x))} \leq C_\circ r^{2+\alpha} + C_x r^2 \leq 2C_x r^2$$

if r small enough, so that, in particular, arguing as in (i), u is differentiable at x and $a_x = u(x)$, $b_x = \nabla u(x)$.

Thus, using that $r = 2|x - y|$, we have

$$|\nabla u(y) - \nabla u(x) - 2(y - x)^T M_x| \leq CC_\circ |y - x|^{1+\alpha},$$

and letting $y \rightarrow x$ we deduce that ∇u is differentiable at x , with $D^2 u(x) = 2M_x$. An analogous result holds for M_y , so that we have shown that, for any $x, y \in B_r(x_\circ)$ with $|x - y| = r$ and $B_{2r}(x_\circ) \subset B_1$,

$$|D^2 u(x) - D^2 u(y)| \leq \tilde{C} C_\circ r^\alpha.$$

The result now follows by **(H1')**. \square

Remark. Notice that the converse statement to **(H4)** also holds. For example, when $k = 1$, if $u \in C^{1,\alpha}(B_1)$ then we have

$$\|u - \ell_x\|_{L^\infty(B_r(x))} \leq C_\circ r^{1+\alpha} \quad \text{for all } B_r(x) \subset \bar{B}_1,$$

where $\ell_x(y) = u(x) + \nabla u(x) \cdot (y - x)$. Indeed, to show this, we use that

$$u(y) = u(x) + \int_0^1 \nabla u(ty + (1-t)x) \cdot (y - x) dt,$$

combined with

$$|\nabla u(ty + (1-t)x) - \nabla u(x)| \leq C_\circ |ty + (1-t)x - x|^\alpha \leq C_\circ |y - x|^\alpha,$$

to get

$$|u(y) - u(x) - \nabla u(x) \cdot (y - x)| \leq \int_0^1 C_\circ |y - x|^\alpha |y - x| dt = C_\circ |y - x|^{1+\alpha},$$

as wanted.

(H5) Let $\rho_\circ \in (0, 1)$. Assume that, for every $x \in B_{1/2}$, there exists a sequence of quadratic polynomials, $(P_k)_{k \in \mathbb{N}}$ such that

$$\|u - P_k\|_{L^\infty(B_{\rho_\circ^k}(x))} \leq C_\circ \rho_\circ^{k(2+\alpha)} \quad \text{for all } k \in \mathbb{N}.$$

Then, $u \in C^{2,\alpha}(B_{1/2})$ and $[D^2 u]_{C^{0,\alpha}(B_{1/2})} \leq CC_\circ$, with C depending only on n , α , and ρ_\circ .

• **Proof of (H5).** Let us take $x = 0$. By hypothesis, we have

$$\begin{aligned} \|P_{k-1} - P_k\|_{L^\infty(B_{\rho_\circ^k})} &\leq \|u - P_{k-1}\|_{L^\infty(B_{\rho_\circ^k})} + \|u - P_k\|_{L^\infty(B_{\rho_\circ^k})} \\ &\leq CC_\circ \rho_\circ^{k(2+\alpha)}. \end{aligned}$$

Then, we use the following:

Claim. Assume that P is a quadratic polynomial satisfying $\|P\|_{L^\infty(B_r)} \leq \gamma$. If we denote $P(z) = a + b \cdot z + z^T M z$, then we have that

$$|a| \leq C\gamma, \quad |b| \leq \frac{C\gamma}{r}, \quad |M| \leq \frac{C\gamma}{r^2},$$

where C is a constant depending only on n .

To prove the claim, notice that, by rescaling, we have $P_r(z) := P(rz) = a_r + b_r \cdot z + z^T M_r z$, where $a_r = a$, $b_r = rb$, $M_r = r^2 M$. By assumption, we have that $\|P_r\|_{L^\infty(B_1)} \leq \gamma$. Since the coefficients of polynomials on B_1 are controlled by the L^∞ norm, we get that $|a_r| \leq C\gamma$, $|b_r| \leq C\gamma$, and $|M_r| \leq C\gamma$. This proves the claim.

Using the previous claim and the bound on $P_{k-1} - P_k$, we deduce that

$$|a_{k-1} - a_k| \leq CC_\circ \rho_\circ^{k(2+\alpha)}, \quad |b_{k-1} - b_k| \leq CC_\circ \rho_\circ^{k(1+\alpha)},$$

and

$$|M_{k-1} - M_k| \leq CC_\circ \rho_\circ^{k\alpha},$$

where $P_k(z) = a_k + b_k \cdot z + z^T M_k z$.

It follows that P_k converge uniformly to a polynomial $P(z) = a + b \cdot z + z^T M z$, and that

$$\begin{aligned} \|u - P\|_{L^\infty(B_{\rho_\circ^k})} &\leq \|u - P_k\|_{L^\infty(B_{\rho_\circ^k})} + |a_k - a| + \rho_\circ^k |b_k - b| + \rho_\circ^{2k} |M_k - M| \\ &\leq CC_\circ \rho_\circ^{k(2+\alpha)} \end{aligned}$$

for all $k \geq 1$. From this, it follows that for every $r \in (0, 1)$ we have

$$\|u - P\|_{L^\infty(B_r)} \leq CC_\circ r^{2+\alpha}$$

(simply use that for any r we have $\rho_\circ^{k+1} \leq r \leq \rho_\circ^k$ for some k). Thus, since we can do this for every $x \in B_{1/2}$, it follows from **(H4)** that $[D^2 u]_{C^{0,\alpha}(B_{1/2})} \leq CC_\circ$. \square

We refer to Remark A.1 below for a generalization of property **(H5)**.

(H6) Assume that $\alpha \in (0, 1)$, $\|u\|_{L^\infty(B_1)} \leq C_\circ$, and

$$(A.1) \quad \sup_{\substack{h \in B_1 \\ x \in \overline{B_{1-|h|}}}} \frac{|u(x+h) + u(x-h) - 2u(x)|}{|h|^\alpha} \leq C_\circ.$$

Then, $u \in C^{0,\alpha}(\overline{B_1})$ and $\|u\|_{C^{0,\alpha}(\overline{B_1})} \leq CC_\circ$, with C depending only on n, α .

Assume that $\alpha \in (0, 1)$, $\|u\|_{L^\infty(B_1)} \leq C_\circ$, and

$$(A.2) \quad \sup_{\substack{h \in B_1 \\ x \in \overline{B_{1-|h|}}}} \frac{|u(x+h) + u(x-h) - 2u(x)|}{|h|^{1+\alpha}} \leq C_\circ.$$

Then, $u \in C^{1,\alpha}(\overline{B_1})$ and $\|u\|_{C^{1,\alpha}(\overline{B_1})} \leq CC_\circ$, with C depending only on n, α . However, such property fails when $\alpha = 0$.

• **Proof of (H6).** (i) Let us do the case (A.2) first.

Given $h \in B_1$ and $x \in B_{1-|h|}$, let

$$w(h) := \frac{u(x+h) - u(x)}{|h|}.$$

Then, by assumption we have

$$|w(h) - w(h/2)| = \frac{|u(x+h) + u(x) - 2u(x+h/2)|}{|h|} \leq C_\circ |h|^\alpha.$$

Thus, for every $k \geq 0$,

$$|w(h/2^k) - w(h/2^{k+1})| \leq C_\circ |h|^\alpha 2^{-k\alpha}.$$

This implies the existence of the limit $\lim_{t \rightarrow 0} w(th)$, and by summing a geometric series we get

$$|w(h) - \lim_{t \rightarrow 0} w(th)| \leq CC_\circ |h|^\alpha.$$

Since

$$\lim_{t \rightarrow 0} w(th) = \lim_{t \rightarrow 0} \frac{u(x+th) - u(x)}{t|h|} = \frac{h}{|h|} \cdot \nabla u(x),$$

this leads to

$$|u(x+h) - u(x) - h \cdot \nabla u(x)| \leq CC_\circ |h|^{1+\alpha}.$$

Using (H4), we see that the last inequality implies that $[Du]_{C^{0,\alpha}(B_1)} \leq CC_\circ$. Finally, using that $\|u\|_{L^\infty(B_1)} \leq C_\circ$, the result follows.

(ii) Let us do now the case (A.1).

As before, let us define $w(h) := \frac{u(x+h) - u(x)}{|h|}$ and notice that

$$|w(h) - w(h/2)| = \frac{|u(x+h) + u(x) - 2u(x+h/2)|}{|h|} \leq C_\circ |h|^{\alpha-1}.$$

Then, for every $k \geq 0$ we have

$$|w(2^k h) - w(2^{k+1} h)| \leq C_\circ |h|^{\alpha-1} 2^{-k(1-\alpha)}.$$

Take $k_\circ \geq 0$ such that $2^{k_\circ}|h| \approx 1$ (and so that¹ still $x + 2^{k_\circ}h \in B_1$), and add the previous inequality for all $0 \leq k < k_\circ$. Then, by summing a geometric series, we deduce that

$$|w(2^{k_\circ}h) - w(h)| \leq CC_\circ|h|^{\alpha-1}.$$

Since

$$|w(2^{k_\circ}h)| \leq C\|u\|_{L^\infty(B_1)} \leq CC_\circ \leq CC_\circ|h|^{\alpha-1},$$

we finally get

$$|w(h)| \leq |w(2^{k_\circ}h)| + CC_\circ|h|^{\alpha-1} \leq CC_\circ|h|^{\alpha-1}.$$

Translating back to u , this gives the desired result.

(iii) Finally, let us prove that the function

$$u(x) = x \log |x|, \quad x \in (-1, 1),$$

satisfies (A.2) with $\alpha = 0$, but it is not in $C^{0,1}$.

Indeed, let us show that

$$\frac{|(x+h) \log |x+h| + (x-h) \log |x-h| - 2x \log |x||}{|h|} \leq C_\circ$$

for all $x, h \in (-1, 1)$ and for some $C_\circ > 0$. For this, notice that

$$\begin{aligned} \frac{(x+h) \log |x+h| + (x-h) \log |x-h| - 2x \log |x|}{h} &= \\ &= \frac{\left(1 + \frac{h}{x}\right) \log \left|1 + \frac{h}{x}\right| + \left(1 - \frac{h}{x}\right) \log \left|1 - \frac{h}{x}\right|}{\frac{h}{x}} \\ &= \frac{(1+t) \log |1+t| + (1-t) \log |1-t|}{t}, \end{aligned}$$

with $t = h/x$. Such function of t is smooth in $\mathbb{R} \setminus \{0\}$ and has finite limits at $t = 0$ and at $t = \infty$. Therefore, it is globally bounded in \mathbb{R} by some constant C_\circ (actually, $C_\circ < 2$). \square

Remark. We refer to [And97, Section 2] for higher order versions of the characterization (H6).

(H7) Assume that $\alpha \in (0, 1]$, $\|u\|_{L^\infty(B_1)} \leq C_\circ$, and that for every $h \in B_1$ we have

$$\left\| \frac{u(x+h) - u(x)}{|h|^\alpha} \right\|_{C^\beta(B_{1-|h|})} \leq C_\circ,$$

with C_\circ independent of h . Assume in addition that $\alpha + \beta$ is not an integer. Then, $u \in C^{\alpha+\beta}(\overline{B_1})$ and $\|u\|_{C^{\alpha+\beta}(\overline{B_1})} \leq CC_\circ$, with C depending only on n, α, β .

¹Note that this is always possible if $x, y \in B_{9/10}$, for example. If x, y are close to the boundary ∂B_1 , then this is possible for example when $(x-y) \cdot \frac{x}{|x|} > \frac{1}{2}|y-x|$. It is easy to see that we can always reduce to this case.

However, such property fails when $\alpha + \beta$ is an integer.

• **Proof of (H7).** We prove it in case $\beta \in (0, 1]$, the proof for $\beta > 1$ is analogous. Let us define

$$v_h(x) = \frac{u(x+h) - u(x)}{|h|^\alpha}.$$

Then, by assumption we have

$$\sup_{x,y \in B_{1-|h|}} \frac{|v_h(x) - v_h(y)|}{|x-y|^\beta} \leq C_\circ.$$

This is equivalent to

$$\sup_{x,y \in B_{1-|h|}} \frac{|u(x+h) - u(x) - u(y+h) + u(y)|}{|h|^{\alpha+\beta}} \leq C_\circ.$$

Taking $y = x - h$, this yields

$$\sup_{x \in B_{1-2|h|}} \frac{|u(x+h) + u(x-h) - 2u(x)|}{|h|^{\alpha+\beta}} \leq C_\circ.$$

By **(H6)**, we deduce that $\|u\|_{C^{\alpha+\beta}(\overline{B_1})} \leq CC_\circ$ — as long as $\alpha + \beta \neq 1$. \square

(H8) Assume that $u_i \rightarrow u$ uniformly in $\overline{\Omega} \subset \mathbb{R}^n$, and that $\|u_i\|_{C^{k,\alpha}(\overline{\Omega})} \leq C_\circ$, with $\alpha \in (0, 1]$ and for some C_\circ independent of i . Then, $u \in C^{k,\alpha}(\overline{\Omega})$, and

$$\|u\|_{C^{k,\alpha}(\overline{\Omega})} \leq C_\circ.$$

• **Proof of (H8).** Assume first $k = 0$. Then, we have that for every $x, y \in \overline{\Omega}$, $x \neq y$,

$$\|u_i\|_{L^\infty(\Omega)} + \frac{|u_i(x) - u_i(y)|}{|x-y|^\alpha} \leq C_\circ.$$

Taking limits $u_i \rightarrow u$, we deduce that the same inequality holds for u , and thus $\|u\|_{C^{0,\alpha}(\overline{\Omega})} \leq C_\circ$, as wanted.

Assume now that $k \geq 1$. Then, it follows from Arzelà–Ascoli that $D^m u_i \rightarrow D^m u$ uniformly in $\overline{\Omega}$ for $m \leq k$ and thus, as before, taking limits in the inequality

$$\|u_i\|_{C^k(\overline{\Omega})} + \frac{|D^k u_i(x) - D^k u_i(y)|}{|x-y|^\alpha} \leq C_\circ,$$

the result follows. \square

Remark A.1. In relation with property **(H5)**, one can define $\mathcal{L}^{\infty,\beta}$ as the set of functions $u : B_1 \rightarrow \mathbb{R}$ satisfying that, for each $x \in \mathbb{R}$ and each $r \in (0, 1 - |x|)$, there exists some polynomial $P_{x,r}$ of degree $\lfloor \beta \rfloor$ such that

$$\|u - P_{x,r}\|_{L^\infty(B_r(x))} \leq Cr^\beta$$

for some C universal, and where $[\beta]$ denotes the integer part of β . More generally, one can define² $\mathcal{L}^{p,\beta}$ for $p \in [1, \infty]$ as the set of functions u satisfying

$$r^{-\frac{n}{p}} \|u - P_{x,r}\|_{L^p(B_r)} \leq Cr^\beta.$$

Then, it turns out that, for any $\beta > 0$ and $p \geq 1$, $\mathcal{L}^{p,\beta} = \mathcal{L}^{\infty,\beta}$; see [JTW83, Theorem 2]. Moreover, similarly to what we did in (H5), one can prove that if $\beta = k + \alpha$, then

$$\mathcal{L}^{p,k+\alpha} = \mathcal{L}^{\infty,k+\alpha} = C^{k,\alpha}, \quad \text{if } \alpha \in (0, 1) \text{ and } k \in \mathbb{N}.$$

On the other hand, when β is an integer these spaces do not coincide with Hölder spaces. Indeed, for $\beta = 1$ we have

$$\mathcal{L}^{p,1} = \mathcal{L}^{\infty,1} = \Lambda^1,$$

(see [JW84, Section 1.6]), and for $\beta > 1$,

$$u \in \mathcal{L}^{p,\beta} \iff \nabla u \in \mathcal{L}^{p,\beta-1},$$

(see [JTW83, Theorem 3].) Here, Λ^1 denotes the *Zygmund space*, i.e. the set of functions $u : B_1 \rightarrow \mathbb{R}$ such that

$$\sup_{\substack{h \in B_1 \\ x \in B_{1-|h|}}} \frac{|u(x+h) + u(x-h) - 2u(x)|}{|h|} \leq C,$$

for some universal C . Finally, when $\beta = 0$ we have

$$\mathcal{L}^{p,0} = \mathcal{L}^{1,0} = \text{BMO}, \quad \text{if } p \in [1, \infty),$$

where BMO denotes the space of *bounded mean oscillation* functions, see [JN61, JW84]. Notice also that $\nabla u \in \text{BMO}$ implies $u \in \Lambda^1$, but the opposite implication does not hold, see [Str80, Theorem 3.4].

²These spaces are called *Morrey-Campanato spaces* when $p < \infty$ and $\beta < 1$.

— DRAFT —

Proof of the boundary Harnack inequality

The goal of this appendix is to prove the boundary Harnack inequality for Lipschitz domains, Theorem 5.35. The proof we present here is due to De Silva and Savin [DS20], and is different to the one given in the book [CS05].

For simplicity, we consider domains Ω such that

$$(B.1) \quad \begin{aligned} \Omega \cap B_1 \text{ is given by a Lipschitz graph in the } e_n \text{ direction,} \\ \text{with Lipschitz norm } \leq 1, \text{ and with } 0 \in \partial\Omega. \end{aligned}$$

In other words, we consider $(x', x_n) \in \mathbb{R}^{n-1} \times \mathbb{R}$, and let

$$(B.2) \quad \begin{aligned} g : \mathbb{R}^{n-1} \rightarrow \mathbb{R}, \quad [g]_{C^{0,1}(\mathbb{R}^{n-1})} \leq 1, \quad g(0) = 0, \\ \Omega := \{x \in \mathbb{R}^n : x_n > g(x')\}. \end{aligned}$$

The boundary Harnack inequality in Lipschitz domains is the following. (See Figure B.1 for a depiction of the setting in the theorem.)

Theorem B.1 (Boundary Harnack). *Let w_1 and w_2 be positive harmonic functions in $B_1 \cap \Omega$, where $\Omega \subset \mathbb{R}^n$ is a Lipschitz domain as in (B.1)-(B.2).*

Assume that w_1 and w_2 vanish continuously on $\partial\Omega \cap B_1$, and $C_\circ^{-1} \leq \|w_i\|_{L^\infty(B_{1/2})} \leq C_\circ$ for $i = 1, 2$. Then,

$$C^{-1}w_2 \leq w_1 \leq Cw_2 \quad \text{in } \bar{\Omega} \cap B_{1/2}.$$

The constant C depends only on n and C_\circ .

Moreover, an appropriate iteration of the previous result gives the following.

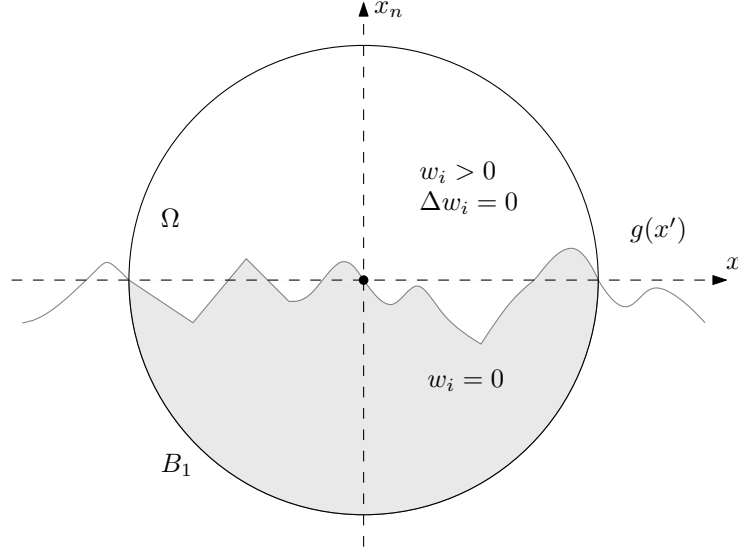

Figure B.1. Depiction of the setting in Theorem B.1 and Corollary B.2.

Corollary B.2. *Let w_1 and w_2 be as in Theorem B.1. Then,*

$$\left\| \frac{w_1}{w_2} \right\|_{C^{0,\alpha}(\bar{\Omega} \cap B_{1/2})} \leq C$$

for some small $\alpha > 0$. The constants α and C depend only on n and C_\circ .

Remark B.3. Notice that, for simplicity, we deal with Lipschitz domains with Lipschitz constant bounded by 1 and, as a consequence, none of the constants appearing in Theorem B.1 depend on the domain Ω . The same proof presented here can be adapted to the case of general Lipschitz domains.

The reasons we consider domains with Lipschitz constant bounded by 1 are to avoid introducing more notation and so that the domain Ω in B_1 has a single connected component. Note, moreover, that when we apply the boundary Harnack in Proposition 5.37, we are doing so to a Lipschitz domain with Lipschitz constant smaller than 1 (therefore, we can directly apply Corollary B.2).

The following two (well-known) lemmas for sub- and superharmonic functions will be used. Notice that these are interior regularity properties.

Lemma B.4 (Weak Harnack Inequality for supersolutions). *Let $u \in C(B_1)$. Then,*

$$\begin{cases} -\Delta u \geq 0 & \text{in } B_1 \\ u \geq 0 & \text{in } B_1 \end{cases} \implies \inf_{B_{1/2}} u \geq c \|u\|_{L^1(B_{1/2})},$$

for some $c > 0$ depending only on n .

Proof. By the mean value property of the Laplace equation, for any $x_o \in B_{1/3}$ we have

$$u(x_o) \geq \frac{1}{|B_{2/3}|} \int_{B_{2/3}(x_o)} u = c \|u\|_{L^1(B_{2/3}(x_o))} \geq c \|u\|_{L^1(B_{1/3})},$$

with c a dimensional constant, so that we have proved the property in a ball of radius $1/3$. Take now any $\bar{x}_o \in \partial B_{1/3}$ and consider the ball $B_{1/6}(\bar{x}_o)$. Notice that we can repeat the previous steps to derive

$$\inf_{B_{1/6}(\bar{x}_o)} u \geq c \|u\|_{L^1(B_{1/6}(\bar{x}_o))}.$$

Moreover, if we denote $\mathcal{B} := B_{1/3} \cap B_{1/6}(\bar{x}_o)$, then

$$\|u\|_{L^1(B_{1/6}(\bar{x}_o))} \geq \int_{\mathcal{B}} u \geq |\mathcal{B}| \inf_{\mathcal{B}} u \geq c \inf_{B_{1/3}} u.$$

From the first result in this proof, we can conclude

$$\inf_{B_{1/2}} u \geq c_1 \inf_{B_{1/3}} u \geq c_2 \|u\|_{L^1(B_{1/3})} \geq c_3 \|u\|_{L^1(B_{1/2})}$$

for some dimensional constant c_3 . In the last step we have used the monotonicity of averages with respect to the radius for superharmonic functions; see for example (1.12). \square

The second lemma reads as follows.

Lemma B.5 (L^∞ bound for subsolutions). *Let $u \in C(B_1)$. Then,*

$$-\Delta u \leq 0 \quad \text{in } B_1 \quad \Rightarrow \quad \sup_{B_{1/2}} u \leq C_\varepsilon \|u\|_{L^\varepsilon(B_1)},$$

for any $\varepsilon > 0$, and for some C_ε depending only on n and ε .

Proof. Again, by the mean value property we have that, for any $r > 0$,

$$\|u\|_{L^\infty(B_{r/2})} \leq C \int_{B_r} u \leq C \|u\|_{L^\infty(B_r)}^{1-\varepsilon} \int_{B_r} |u|^\varepsilon.$$

We now want to use an interpolation inequality. Notice that, for any $\delta > 0$, there exists some C_δ (depending only on δ and ε) such that $\xi^{1-\varepsilon} \leq \delta \xi + C_\delta$ for all $\xi \geq 0$. Taking $\xi = \frac{A}{B}$ with

$$A = \|u\|_{L^\infty(B_r)}, \quad B = \left(C \int_{B_r} |u|^\varepsilon \right)^{\frac{1}{\varepsilon}}$$

we deduce that, for any $\delta > 0$, there exists some C_δ such that

$$\|u\|_{L^\infty(B_{r/2})} \leq C \|u\|_{L^\infty(B_r)}^{1-\varepsilon} \int_{B_r} |u|^\varepsilon \leq \delta \|u\|_{L^\infty(B_r)} + C_\delta \left(C \int_{B_r} |u|^\varepsilon \right)^{\frac{1}{\varepsilon}}.$$

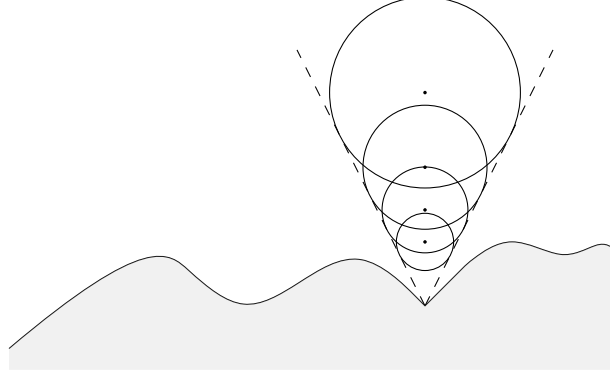

Figure B.2. A chain of balls to apply the Harnack inequality sequentially.

In particular,

$$\|u\|_{L^\infty(B_{r/2})} \leq \delta \|u\|_{L^\infty(B_r)} + C_\delta r^{-\frac{n}{\varepsilon}} \|u\|_{L^\varepsilon(B_1)}.$$

We are now in position to apply Lemma 2.27 with $S(A) = \|u\|_{L^\infty(A)}$, $k = \frac{n}{\varepsilon}$ and $\gamma = C_\delta \|u\|_{L^\varepsilon(B_1)}$, to deduce that

$$\|u\|_{L^\infty(B_{1/2})} \leq C \|u\|_{L^\varepsilon(B_1)},$$

for some constant C depending only on n and ε , as wanted. \square

As a consequence of the previous lemmas we obtain the following two useful results, which are partial steps towards the proof of Theorem B.1. The first one gives an L^∞ bound for u in terms of the value of the function at an interior point in Ω .

Lemma B.6. *Let $u \in C(B_1)$ be a positive harmonic function in $B_1 \cap \Omega$ with $u = 0$ on $B_1 \setminus \Omega$, where $\Omega \subset \mathbb{R}^n$ is a Lipschitz domain as in (B.1)-(B.2). Assume, moreover, that $u(\frac{1}{2}e_n) = 1$. Then,*

$$\|u\|_{L^\infty(B_{1/2})} \leq C,$$

for some constant C depending only on n .

Proof. Notice that since $u \geq 0$ is harmonic whenever $u > 0$, and it is continuous, we have $\Delta u \geq 0$ in B_1 in the viscosity sense.

On the other hand, since g in (B.1) has Lipschitz constant bounded by 1, we have $B_\varrho(\frac{1}{2}e_n) \subset \{\Delta u = 0\}$, with $\varrho = \frac{1}{2\sqrt{2}}$. In particular, by Harnack's inequality (see (2.3)) we have that $u \leq C_n$ in $B_{1/4}(\frac{1}{2}e_n)$. That is, $u(0, x_n) \leq C_n$ for $x_n \in (\frac{1}{4}, \frac{1}{2})$. Repeating iteratively, we get $u(0, x_n) \leq C_n^k$ for $x_n \in (2^{-k-1}, 2^{-k})$ (see Figure B.2 for a sketch of this chain of inequalities), so that $u(0, t) \leq t^{-K}$ for $t \in (0, \frac{1}{2})$, for some large dimensional constant K . We

can repeat the same procedure at all points in $B_{1/2}$ by iterating successive Harnack inequalities, to deduce that

$$u \leq d^{-K} \quad \text{in } B_{1/2}, \quad \text{where } d(x) := \text{dist}(x, \Omega^c).$$

In particular, for $\varepsilon > 0$ small enough we have

$$\int_{B_{1/2}} |u|^\varepsilon \leq C.$$

By Lemma B.5, we deduce that $\|u\|_{L^\infty(B_{1/4})} \leq C$, and the result in $B_{1/2}$ follows from a simple covering argument. \square

The second lemma reads as follows.

Lemma B.7. *Let $\delta > 0$ be small, let $\Omega \subset \mathbb{R}^n$ be a Lipschitz domain as in (B.1)-(B.2), and let $\Omega_\delta := \{x \in \Omega : \text{dist}(x, \Omega^c) \geq \delta\}$. Let $u \in C(B_1)$ satisfy*

$$\begin{cases} \Delta u = 0 & \text{in } \Omega \cap B_1 \\ u = 0 & \text{on } \partial\Omega \cap B_1 \end{cases} \quad \text{and} \quad \begin{cases} u \geq 1 & \text{in } B_1 \cap \Omega_\delta \\ u \geq -\delta & \text{in } B_1. \end{cases}$$

Then, for all $k \in \mathbb{N}$ such that $k\delta \leq \frac{3}{4}$, we have

$$u \geq -\delta(1 - c_\circ)^k \quad \text{in } B_{1-k\delta}$$

for some constant c_\circ depending only on n .

Proof. Let $u^- = \min\{u, 0\}$. Notice that u^- is superharmonic (in the viscosity sense) since $\Delta u^- = 0$ when $u^- < 0$, and $u^- \leq 0$, so we have $\Delta u^- \leq 0$. Let $w = u^- + \delta$. By assumption, $w \geq 0$ and $\Delta w \leq 0$.

Let $x_\circ \in \partial\Omega \cap B_{1-2\delta}$. Let us apply Lemma B.4 to a ball of radius 2δ around x_\circ , so that (after scaling) we deduce

$$\inf_{B_\delta(x_\circ)} w \geq c\delta^{-n} \|w\|_{L^1(B_\delta(x_\circ))}.$$

Notice, now, that since the domain is Lipschitz and $w \geq \delta$ in Ω^c , we can bound $\|w\|_{L^1(B_\delta(x_\circ))} \geq \delta |\{w \geq \delta\} \cap B_\delta(x_\circ)| \geq c\delta^{n+1}$ for some c (see Figure B.3) depending only on n . Thus,

$$\inf_{B_\delta(x_\circ)} w \geq c_\circ \delta.$$

In particular, since $w \geq \delta$ in $B_1 \cap \Omega_\delta$ we have $w \geq c_\circ \delta$ in $B_{1-\delta}$ and therefore $u \geq -\delta(1 - c_\circ)$ in $B_{1-\delta}$. Applying iteratively this inequality for balls of radius $1 - 2\delta, 1 - 3\delta, \dots$, we obtain the desired result. \square

We can now show the following result, which is a key step in the proof of Theorem B.1.

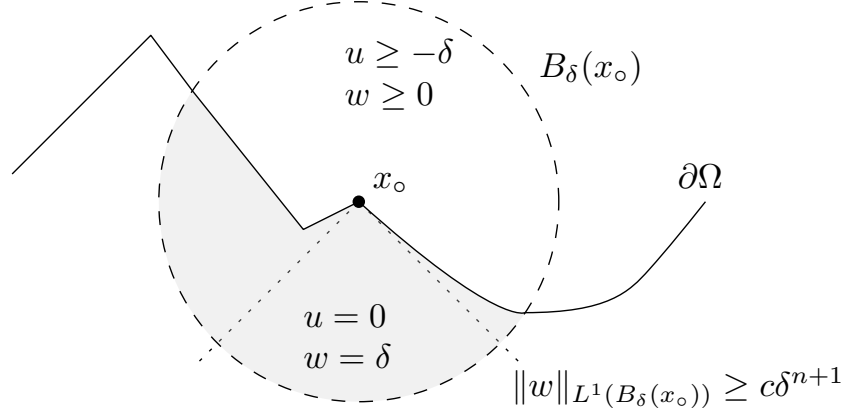

Figure B.3. The fact that the domain is Lipschitz allows us to bound the L^1 norm of w in $B_\delta(x_0)$ from below.

Proposition B.8. *There exists $\delta > 0$, depending only on n , such that the following holds.*

Let $\Omega \subset \mathbb{R}^n$ be a Lipschitz domain as in (B.1)-(B.2), and let $\Omega_\delta := \{x \in \Omega : \text{dist}(x, \Omega^c) \geq \delta\}$. Assume that $u \in C(B_1)$ satisfies

$$\begin{cases} \Delta u = 0 & \text{in } \Omega \cap B_1 \\ u = 0 & \text{on } \partial\Omega \cap B_1 \end{cases} \quad \text{and} \quad \begin{cases} u \geq 1 & \text{in } B_1 \cap \Omega_\delta \\ u \geq -\delta & \text{in } B_1. \end{cases}$$

Then, $u \geq 0$ in $B_{1/2}$.

Proof. It is enough to show that, for some $a > 0$, we have

$$(B.3) \quad \begin{cases} u \geq a & \text{in } B_{1/2} \cap \Omega_{\delta/2} \\ u \geq -\delta a & \text{in } B_{1/2}. \end{cases}$$

Indeed, iterating (B.3) at all scales, and at all points $z \in \partial\Omega \cap B_{1/2}$, we obtain

$$\begin{cases} u \geq a^k & \text{in } B_{2^{-k}}(z) \cap \Omega_{2^{-k}\delta} \\ u \geq -\delta a^k & \text{in } B_{2^{-k}}(z) \end{cases}$$

for all $k \in \mathbb{N}$. In particular, the first inequality yields that $u(z + te_n) \geq 0$ for $z \in \partial\Omega \cap B_{1/2}$ and $t > 0$, and therefore $u \geq 0$ in $B_{1/2}$.

Let us show (B.3). We start with the first inequality. Let $x_0 \in B_{1/2} \cap \Omega_{\delta/2}$, and let us suppose that $\frac{\delta}{2} \leq \text{dist}(x_0, \Omega^c) < \delta$ (otherwise, we are done by assumption). Consider the function $w = u + \delta$, which satisfies $w \geq 0$ in Ω by assumption.

Notice that we can connect the points x_0 and $x_0 + \frac{1}{2}\delta e_n$ with a sequence of (three) overlapping balls in Ω , so that we can apply Harnack's inequality to w to deduce

$$w(x_0) \geq \frac{1}{C} w(x_0 + \frac{1}{2}\delta e_n) \geq \frac{1}{C},$$

for some dimensional constant C , where in the last step we are using that $w(x_\circ + \frac{1}{2}\delta e_n) \geq 1 + \delta$ by assumption. In particular, by taking $\delta > 0$ smaller than $\frac{1}{2C}$, we get

$$u(x_\circ) \geq \frac{1}{C} - \delta \geq \frac{1}{2C} \quad \text{for all } x_\circ \in B_{1/2} \cap \Omega_{\delta/2}.$$

On the other hand, by Lemma B.7 we know that $u \geq -\delta(1 - c_\circ)^k$ in $B_{1-k\delta}$ as long as $k\delta \leq \frac{3}{4}$. If we take $k = \frac{1}{2\delta}$, we deduce

$$u \geq -\delta(1 - c_\circ)^{\frac{1}{2\delta}} \quad \text{in } B_{1/2},$$

and taking δ small enough such that $(1 - c_\circ)^{\frac{1}{2\delta}} \leq \frac{1}{2C}$ we are done. \square

Remark B.9 (Proposition B.8 for small Lipschitz constants). The proofs of Lemma B.7 and Proposition B.8 can be simplified a lot in the case of a domain with small Lipschitz constant.

Indeed, let us assume that the hypotheses of Proposition B.8 hold, where the domain Ω satisfies (B.1)-(B.2) but with Lipschitz constant $L < \frac{1}{n-1}$, and let us consider the harmonic function

$$\varphi(x) = x_n^2 - \frac{1}{n-1} (x_1^2 + x_2^2 + \dots + x_{n-1}^2).$$

Then, for δ small enough, $\varphi \leq u$ on $\partial B_{1/2} \cap \Omega$, and by assumption on the Lipschitz constant of the domain we have that $\varphi \leq 0$ on $\partial\Omega \cap B_1$. In all, the maximum principle gives $\varphi \leq u$ in $B_{1/2} \cap \Omega$, which implies that $u(te_n) \geq 0$ for $t \in [0, \frac{1}{2}]$. By repeating the same argument at all boundary points in $\partial\Omega \cap B_{1/2}$ we reach that $u \geq 0$ in $B_{1/2}$.

We can now give the proof of Theorem B.1.

Proof of Theorem B.1. Thanks to Lemma B.6, up to a constant depending on C_\circ , we may assume $w_1(\frac{1}{2}e_n) = w_2(\frac{1}{2}e_n) = 1$. Then, let us define

$$v = Mw_1 - \varepsilon w_2$$

for some constants M (large) and ε (small) to be chosen. Let $\delta > 0$ be given by Proposition B.8. Then, since w_2 is bounded,

$$v \geq -\varepsilon w_2 \geq -\delta \quad \text{in } B_{1/2}$$

for $\varepsilon > 0$ small enough. On the other hand, by the interior Harnack inequality, we can take M large enough so that $Mw_1 \geq 1 + \delta$ in $B_{1/2} \cap \Omega_\delta$, where we recall that $\Omega_\delta = \{x \in \Omega : \text{dist}(x, \Omega^c) \geq \delta\}$. That is,

$$v = Mw_1 - \varepsilon w_2 \geq 1 \quad \text{in } B_{1/2} \cap \Omega_\delta,$$

for M large enough depending only on n . Thus, the hypotheses of Proposition B.8 are satisfied, and therefore we deduce that $v \geq 0$ in $B_{1/2}$.

This means that, $w_2 \leq Cw_1$ in $B_{1/4}$ for some constant C depending only on n . The inequality in $B_{1/2}$ follows by a covering argument. Finally, reversing the roles of w_1 and w_2 , we obtain the desired result. \square

Finally, we give the:

Proof of Corollary B.2. Let us denote

$$W := \frac{w_1}{w_2},$$

so that we have to prove Hölder regularity for W in $\bar{\Omega} \cap B_{1/2}$.

Notice that, by Theorem B.1, we know that

$$\frac{1}{C} \leq W \leq C \quad \text{in } B_{1/2} \cap \Omega,$$

for some C depending only on n . We start by claiming that, for some $\theta > 0$ and all $k \in \mathbb{N}$, we have

$$(B.4) \quad \text{osc}_{B_{2^{-k-1}}} W \leq (1 - \theta) \text{osc}_{B_{2^{-k}}} W.$$

Indeed, let

$$a_k := \sup_{B_{2^{-k}}} W \quad \text{and} \quad b_k := \inf_{B_{2^{-k}}} W.$$

If we denote $p_k = \frac{1}{2^{k+1}}e_n$, then either $W(p_k) \geq \frac{1}{2}(a_k + b_k)$ or $W(p_k) \leq \frac{1}{2}(a_k + b_k)$.

Suppose first that $W(p_k) \geq \frac{1}{2}(a_k + b_k)$, and let us define

$$v := \frac{w_1 - b_k w_2}{a_k - b_k}.$$

Notice that, by assumption,

$$\frac{1}{2}w_2(p_k) \leq v(p_k) \leq w_2(p_k).$$

In particular, we can apply Theorem B.1 to the pair of functions v and w_2 in the ball $B_{2^{-k}}$, to deduce that $v \geq \frac{1}{C}w_2$ in $B_{2^{-k-1}}$, that is,

$$\frac{w_1 - b_k w_2}{a_k - b_k} \geq \frac{1}{C}w_2 \quad \text{in } B_{2^{-k-1}} \quad \iff \quad \inf_{B_{2^{-k-1}}} W \geq \frac{1}{C}(a_k - b_k) + b_k.$$

Since $\sup_{B_{2^{-k-1}}} W \leq \sup_{B_{2^{-k}}} W \leq a_k$, we deduce that

$$\text{osc}_{B_{2^{-k-1}}} W \leq a_k - \frac{1}{C}(a_k - b_k) - b_k = \left(1 - \frac{1}{C}\right)(a_k - b_k) = (1 - \theta) \text{osc}_{B_{2^{-k}}} W,$$

with $\theta = \frac{1}{C}$, as wanted.

If we assume instead that $W(p_k) \leq \frac{1}{2}(a_k + b_k)$, then the argument is similar taking $v := (a_k w_2 - w_1)/(a_k - b_k)$ instead. In all, (B.4) holds.

In particular, we have shown that, for some small α depending only on n , we have

$$(B.5) \quad \operatorname{osc}_{B_r(x_o)} W \leq Cr^\alpha \quad \text{for all } r \in (0, \frac{1}{4}) \quad \text{and } x_o \in \partial\Omega \cap B_{1/2},$$

(compare with the proof of Corollary 2.7). We now need to combine (B.5) with interior estimates for harmonic functions to deduce our desired result.

Indeed, letting $x, y \in \bar{\Omega} \cap B_{1/2}$, we want to show that

$$(B.6) \quad |W(x) - W(y)| \leq C|x - y|^\alpha,$$

for some constant C depending only on n .

Let $2r = \operatorname{dist}(x, \partial\Omega) = |x - x_*|$, with $x_* \in \partial\Omega$. We consider two cases:

- If $|x - y| \geq \frac{r}{2}$, then we apply (B.5) in a ball $B_\rho(x_*)$ with radius $\rho = 2r + |x - y|$ to deduce that

$$|W(x) - W(y)| \leq \operatorname{osc}_{B_\rho(x_*)} W \leq C(2r + |x - y|)^\alpha \leq C|x - y|^\alpha.$$

- If $|x - y| \leq \frac{r}{2}$, then by (B.5) we know that $\operatorname{osc}_{B_r(x)} W \leq Cr^\alpha$. In particular, if we denote $c_* := W(x)$, then

$$\|w_1 - c_*w_2\|_{L^\infty(B_r(x))} = \|w_2(W - c_*)\|_{L^\infty(B_r(x))} \leq Cr^\alpha \|w_2\|_{L^\infty(B_r(x))}.$$

On the other hand, since $w_1 - c_*w_2$ is harmonic in $B_r(x)$, by Corollary 2.7 (rescaled) we know that

$$[w_1 - c_*w_2]_{C^{0,\alpha}(B_{r/2}(x))} \leq \frac{C}{r^\alpha} \|w_1 - c_*w_2\|_{L^\infty(B_r(x))} \leq C \|w_2\|_{L^\infty(B_r(x))}.$$

Hence,

$$|W(y) - W(x)| = \left| \frac{w_1(y) - c_*w_2(y)}{w_2(y)} \right| \leq C|x - y|^\alpha \frac{\|w_2\|_{L^\infty(B_r(x))}}{w_2(y)}.$$

We finish by noticing that, by Harnack's inequality applied to w_2 in $B_{2r}(x)$, we have $\|w_2\|_{L^\infty(B_r(x))} \leq Cw_2(y)$ for some C depending only on n .

With these two cases, we have shown (B.6). This proves the result. \square

Remark B.10. As said above, the proofs in this Appendix have been carried out in case that Ω is a Lipschitz domain as in (B.1), with Lipschitz constant bounded by 1. This slightly simplifies the notation, and we have that $\Omega \cap B_1$ has only one connected component.

In case of general Lipschitz domains (with Lipschitz constant bounded by L), the same proofs can be carried out, provided that one is slightly more careful with the underlying geometry. A simple way to do this is to prove all the results with $B_{1/2}$ replaced by B_ρ , with $\rho > 0$ small depending on L .

An alternative way to do this is to work with cylinders, rather than balls, as in [DS20].

Probabilistic interpretation of fully nonlinear equations

In this appendix, we heuristically describe the probabilistic interpretation of fully nonlinear elliptic PDEs. This extends the discussion from Section 1.3 in the context of the Laplace operator.

We start by recalling the following probabilistic interpretation of harmonic functions from Chapter 1:

We have a Brownian motion X_t^x , starting at $x \in \Omega$, and a payoff function $g : \partial\Omega \rightarrow \mathbb{R}$. When we hit the boundary $\partial\Omega$ (for the first time) at a point $z \in \partial\Omega$, we get a paid $g(z)$. The question is then:

What is the expected payoff?

It turns out that

$$u(x) := \left\{ \begin{array}{l} \text{expected} \\ \text{payoff} \end{array} \right\} = \mathbb{E}[g(X_\tau^x)] \quad \text{satisfies} \quad \left\{ \begin{array}{l} \Delta u = 0 \quad \text{in } \Omega \\ u = g \quad \text{on } \partial\Omega, \end{array} \right.$$

where τ is the first time at which X_t^x hits $\partial\Omega$.

We already saw this in Chapter 1. Now, we will see more general “probabilistic games” that lead to more general elliptic PDEs.

Stochastic processes. A stochastic process X_t is a collection of random variables indexed by a parameter, that for us is going to be $t \geq 0$, taking values in a state space, that for us is going to be \mathbb{R}^n . One can think of them as simply a “particle” moving randomly in \mathbb{R}^n , with $t \geq 0$ being the time.

The most famous and important stochastic process is the *Brownian motion*, that we already introduced in Section 1.3. We recall that it is characterized by the following properties:

- (1) $X_0 = 0$ almost surely.
- (2) X_t has *no memory* (is independent of the past, or it has independent increments).
- (3) X_t has *stationary increments*: $X_{t+s} - X_s$ is equal in distribution to X_t .
- (4) X_t has *continuous paths* ($t \mapsto X_t$ is continuous) almost surely.
- (5) X_t is *isotropic*, i.e., it is rotationally symmetric in distribution.

A more general class of stochastic processes is obtained by removing the assumption (5).

Infinitesimal generator. The infinitesimal generator of a stochastic process X_t is an operator L defined to act on functions $u : \mathbb{R}^n \rightarrow \mathbb{R}$ by

$$(C.1) \quad Lu(x) := \lim_{t \downarrow 0} \frac{\mathbb{E}[u(x + X_t)] - u(x)}{t}.$$

It takes C^2 functions u , and gives Lu .

For the Brownian motion, we have that L is the Laplacian Δ .

More generally, under the assumptions (1)-(2)-(3)-(4), the infinitesimal generator L will be a second order elliptic operator of the form

$$Lu = \sum_{i,j=1}^n a_{ij} \partial_{ij} u + \sum_{i=1}^n b_i \partial_i u + cu.$$

Why is this infinitesimal generator useful?

The infinitesimal generator of a stochastic process encodes all the information of such process. Indeed, it is a classical fact that the definition of L leads to the formula

$$(C.2) \quad \mathbb{E}[u(x + X_t)] = u(x) + \mathbb{E} \left[\int_0^t Lu(x + X_s) ds \right].$$

(This is analogous to the fundamental theorem of Calculus!)

We can come back to the “expected payoff” problem:

Let $\Omega \subset \mathbb{R}^n$ be a fixed domain, and consider a stochastic process $(x + X_t)$ starting at $x \in \Omega$, satisfying (2)-(3)-(4) above. Given a payoff function $g : \partial\Omega \rightarrow \mathbb{R}$, we have the following: when X_t^x hits the boundary $\partial\Omega$ for the first time at $z \in \partial\Omega$, we get a payoff $g(z)$. (See Figure C.1.)

What is the expected payoff?

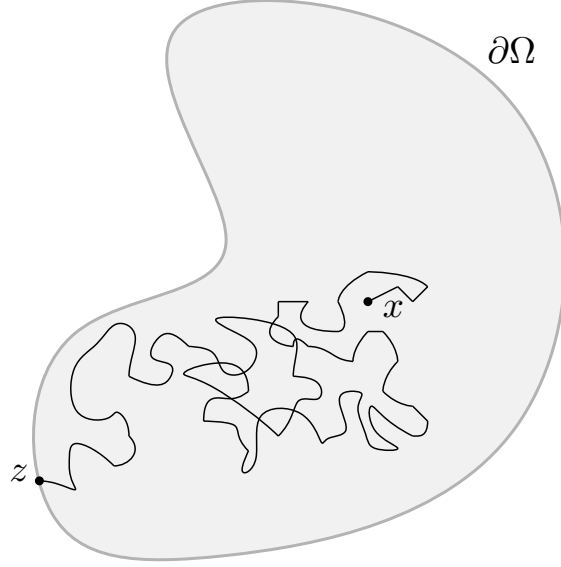

Figure C.1. A stochastic process X_t^x defined in Ω starting at x until it hits the first point on the boundary $z \in \partial\Omega$.

Of course, the expected payoff will depend on $x \in \Omega$. For the Brownian motion, we defined $u(x)$ to be the expected payoff when starting at x , $\mathbb{E}[g(X_\tau^x)]$, where τ is the first time we hit $\partial\Omega$. Then, we observed that, since the Brownian motion is isotropic, u must satisfy the mean value property, and thus u is harmonic: $\Delta u = 0$ in Ω .

Now, for more general stochastic processes, we must use (C.2). Indeed, we define u as before (expected payoff), and notice that if $t > 0$ is small enough, then $x + X_t$ will still be inside Ω , and therefore, the expected payoff is simply equal to $\mathbb{E}[u(x + X_t)]$ (up to a small error), i.e.,

$$u(x) = \mathbb{E}[u(x + X_t)] + o(t) \quad (\text{for } t > 0 \text{ small enough}).$$

where the term $o(t)$ is due to the fact that $x + X_t$ could potentially lie outside of Ω , even for arbitrarily small times $t > 0$.

Now, using the definition of infinitesimal generator, (C.1), we obtain that

$$Lu(x) = \lim_{t \downarrow 0} \frac{\mathbb{E}[u(x + X_t)] - u(x)}{t} = \lim_{t \downarrow 0} \frac{o(t)}{t} = 0.$$

Therefore, for every $x \in \Omega$, we get $Lu(x) = 0$. We clearly have $u = g$ on $\partial\Omega$, thus, u must be the solution of

$$\begin{cases} Lu = 0 & \text{in } \Omega \\ u = g & \text{on } \partial\Omega. \end{cases}$$

Summarizing:

$$\left\{ \begin{array}{l} \text{Expected} \\ \text{payoff for } X_t \end{array} \right\} \longleftrightarrow \left\{ \begin{array}{l} \text{Dirichlet problem for } L \\ \text{(infinitesimal generator)} \end{array} \right\}.$$

Something similar can be done to solve other probabilistic problems related to X_t :

- What is the expected time it will take to exit Ω if we start at x ?

$$\left\{ \begin{array}{l} -Lu = 1 \quad \text{in } \Omega \\ u = 0 \quad \text{on } \partial\Omega. \end{array} \right.$$

- What is the probability density $p(x, t)$ of X_t in \mathbb{R}^n ?

$$\left\{ \begin{array}{l} \partial_t p - Lp = 0 \quad \text{in } \mathbb{R}^n \times (0, \infty) \\ p(\cdot, 0) = \delta_{\{x=0\}} \quad \text{on } \partial\Omega. \end{array} \right.$$

We next see what happens when we have a control, or a two-player game. In that case, we get nonlinear PDEs.

Optimal stopping. We start with the optimal stopping problem. This kind of problem appears very often in Mathematical Finance, for example.

Given a process X_t in \mathbb{R}^n , we can decide at each instant of time whether to stop it or not. When we stop, we get a payoff φ (which depends on the point we stopped at). The goal is to discover what is the optimal strategy so that we maximize the payoff.

Let us consider the process $x + X_t$ (starting at $x \in \mathbb{R}^n$), and a payoff $\varphi \in C_c^\infty(\mathbb{R}^n)$. For any stopping time θ , we get a payoff $\mathbb{E}[\varphi(x + X_\theta)]$, and therefore we want to maximize

$$u(x) := \max_{\theta} \mathbb{E}[\varphi(x + X_\theta)]$$

among all possible stopping times θ (notice that a stopping time θ is actually a random variable; see [Eva13] for more details).

Can we find a PDE for $u(x)$?

Roughly speaking, the only important thing to decide here is:

If we are at x , is it better to stop and get $\varphi(x)$, or to continue and hope for a better payoff later?

Let us find the PDE for u :

- First, since we can always stop (take $\theta = 0$), we have $u(x) \geq \varphi(x)$ for every $x \in \mathbb{R}^n$.
- Second, since we can always continue for some time (take $\theta \geq t_o > 0$), we have that $u(x) \geq \mathbb{E}[u(x + X_t)]$ for $t \leq t_o$. This, combined with (C.2) (or with the definition (C.1)), gives

$$Lu(x) \leq 0 \quad \text{for every } x \in \mathbb{R}^n.$$

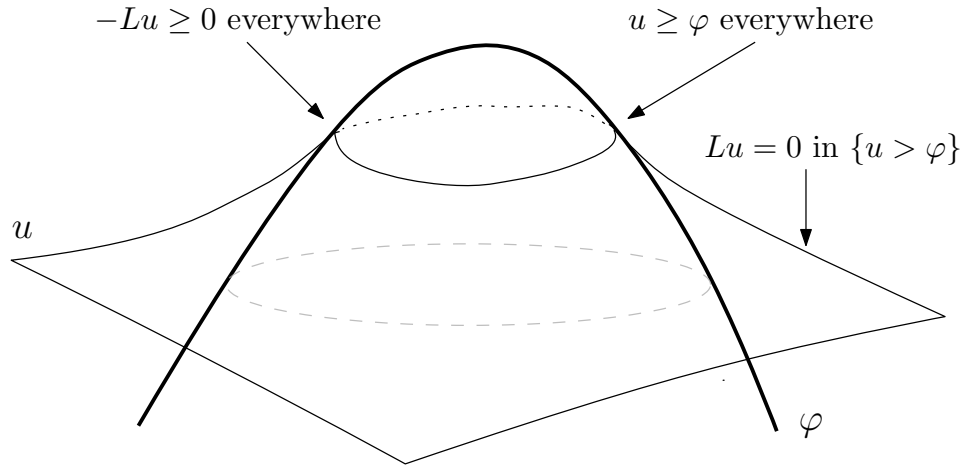

Figure C.2. The obstacle problem.

- Third, at those points where we have $u(x) > \varphi(x)$, we are clearly not stopping there, so we have $u(x) = \mathbb{E}[u(x + X_t)] + o(t)$ for t very small, and thus $Lu(x) = 0$ whenever $u(x) > \varphi(x)$.

The PDE for u is

$$\begin{cases} u \geq \varphi & \text{in } \mathbb{R}^n, \\ -Lu \geq 0 & \text{in } \mathbb{R}^n, \\ Lu = 0 & \text{in } \{u > \varphi\}, \end{cases} \iff \min\{-Lu, u - \varphi\} = 0 \text{ in } \mathbb{R}^n.$$

This is the *obstacle problem* in \mathbb{R}^n from Chapter 5. (See Figure C.2.)

Notice that once we know u , we know the sets $\{u = \varphi\}$ and $\{u > \varphi\}$, so we have the optimal strategy!

Controlled diffusion. Let us now take a different problem, that nonetheless is quite similar to the optimal stopping.

Consider two stochastic processes, $X_t^{(1)}$ and $X_t^{(2)}$, with infinitesimal generators L_1 and L_2 respectively. Let $\Omega \subset \mathbb{R}^n$ be a domain, and let $g : \partial\Omega \rightarrow \mathbb{R}$ be a payoff. We have the same “game” as before (we get a payoff when we hit the boundary), but now we have a *control*: for every $x \in \Omega$, we can choose to move according to $X_t^{(1)}$ or $X_t^{(2)}$.

The question is then:

What is the optimal strategy if we want to maximize the payoff?

— DRAFT —

Notice that now the strategy consists of choosing between $X_t^{(1)}$ and $X_t^{(2)}$ for every $x \in \Omega$. As before, we define

$$u(x) := \max_{\substack{\text{all possible choices} \\ \text{of } a : \Omega \rightarrow \{1, 2\}}} \mathbb{E} [g(X_\tau^a)]$$

(where τ is the time we hit the boundary $\partial\Omega$). Notice that for every $a : \Omega \rightarrow \{1, 2\}$ we have X_t^a , a process which could change from point to point.

Is there any PDE for u ?

The optimality conditions are:

- First, when we are at x we can simply decide to continue with $X_t^{(1)}$, and therefore, $u(x) \geq \mathbb{E} [u(x + X_t^{(1)})]$ for every $x \in \Omega$. This yields $L_1 u(x) \leq 0$ for every $x \in \Omega$.
- Similarly, we can do the same for $X_t^{(2)}$, and get $L_2 u(x) \leq 0$ for every $x \in \Omega$.
- Finally, it turns out that either

$$u(x) = \lim_{t \downarrow 0} \mathbb{E} [u(x + X_t^{(1)})] \quad \text{or} \quad u(x) = \lim_{t \downarrow 0} \mathbb{E} [u(x + X_t^{(2)})],$$

since close to x we are taking either $X_t^{(1)}$ or $X_t^{(2)}$. This means that either $L_1 u(x) = 0$ or $L_2 u(x) = 0$, for every $x \in \Omega$.

Therefore, u satisfies

$$\left\{ \begin{array}{l} -L_1 u \geq 0 \quad \text{in } \Omega, \\ -L_2 u \geq 0 \quad \text{in } \Omega, \\ \text{either } L_1 u = 0 \text{ or } L_2 u = 0 \text{ in } \Omega \end{array} \right. \iff \max\{L_1 u, L_2 u\} = 0 \quad \text{in } \Omega.$$

More generally, if we have a family of processes X_t^α , with $\alpha \in \mathcal{A}$, then the PDE for u becomes

$$(C.3) \quad \max_{\alpha \in \mathcal{A}} \{L_\alpha u\} = 0 \quad \text{in } \Omega.$$

Even more generally, we could have two players, one that wants to maximize the payoff and the other one that wants to minimize the payoff. They have two parameters, $X_t^{\alpha\beta}$, $\alpha \in \mathcal{A}$, $\beta \in \mathcal{B}$, and each player controls one parameter. Then, the optimal payoff solves the PDE

$$(C.4) \quad \min_{\beta \in \mathcal{B}} \max_{\alpha \in \mathcal{A}} \{L_{\alpha\beta} u\} = 0 \quad \text{in } \Omega.$$

Equation (C.3) above is called the Bellman equation (stochastic control).

Equation (C.4) above is called the Isaacs equation (differential games).

These two equations are *fully nonlinear elliptic equations!*

Indeed, assume that we have (C.3), and that the infinitesimal generators $L_\alpha u$ are of the form

$$L_\alpha u = \sum_{i,j=1}^n a_{ij}^{(\alpha)} \partial_{ij} u, \quad (\alpha \in \mathcal{A})$$

with $a_{ij}^{(\alpha)}$ uniformly elliptic: $0 < \lambda \text{Id} \leq (a_{ij}^{(\alpha)})_{ij} \leq \Lambda \text{Id}$. Then, the equation (C.3) is

$$\max_{\alpha \in \mathcal{A}} \left\{ \sum_{i,j=1}^n a_{ij}^{(\alpha)} \partial_{ij} u \right\} = 0 \quad \text{in } \Omega.$$

This is a nonlinear function of the Hessian D^2u :

$$F(D^2u) = 0 \quad \text{in } \Omega, \quad \text{with} \quad F(M) := \max_{\alpha \in \mathcal{A}} \left\{ \sum_{i,j=1}^n a_{ij}^{(\alpha)} M_{ij} \right\}.$$

The function $F : \mathbb{R}^{n \times n} \rightarrow \mathbb{R}$ is the maximum of linear functions. In particular, F is *convex*.

Moreover, F is uniformly elliptic:

$$\begin{aligned} 0 < \lambda \|N\| &\leq \min_{\alpha \in \mathcal{A}} \left\{ \sum_{i,j=1}^n a_{ij}^{(\alpha)} N_{ij} \right\} \leq F(M+N) - F(M) \leq \\ &\leq \max_{\alpha \in \mathcal{A}} \left\{ \sum_{i,j=1}^n a_{ij}^{(\alpha)} N_{ij} \right\} \leq \Lambda \|N\| \end{aligned}$$

for any symmetric matrix $N \geq 0$ (we are using here that $\max f + \min g \leq \max(f+g) \leq \max f + \max g$).

Furthermore, any convex function can be written as the maximum of linear functions (see Figure C.3), and thus:

Remark C.1. Any $F : \mathbb{R}^{n \times n} \rightarrow \mathbb{R}$ which is uniformly elliptic and convex can be written as

$$F(M) = \max_{\alpha \in \mathcal{A}} \left\{ \text{tr}(A^{(\alpha)} M) + c_\alpha \right\} \quad (\text{where } c_\alpha \text{ are constants}).$$

(If F is homogeneous of degree 1, then we do not need the c_α .)

In particular, every fully nonlinear uniformly elliptic equation

$$F(D^2u) = 0 \quad \text{in } \Omega,$$

with F being convex, can be written as a Bellman equation

$$\max_{\alpha \in \mathcal{A}} \{L_\alpha u\} = 0 \quad \text{in } \Omega \quad \text{with} \quad L_\alpha u = \sum_{i,j=1}^n a_{ij}^{(\alpha)} \partial_{ij} u + c_\alpha.$$

Finally, for non-convex F it turns out that:

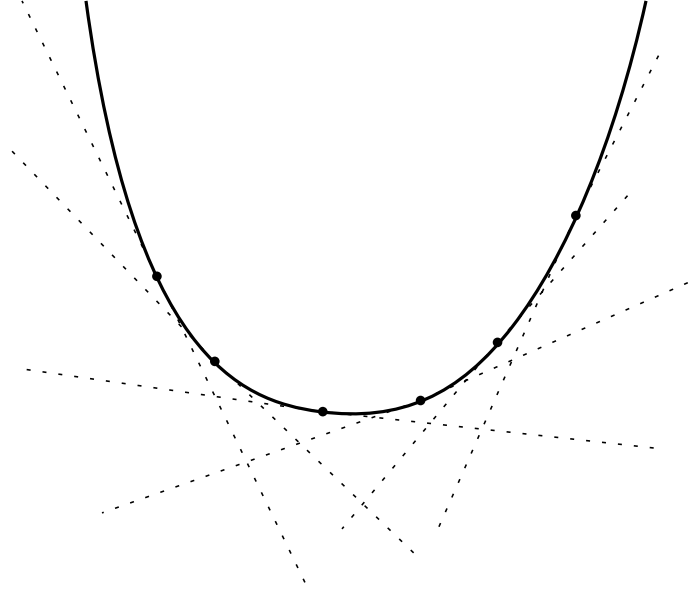

Figure C.3. Convex function as the maximum of linear functions.

Observation. Any $F : \mathbb{R}^{n \times n} \rightarrow \mathbb{R}$ which is uniformly elliptic (not necessarily convex), can be written as

$$F(M) = \min_{\beta \in \mathcal{B}} \max_{\alpha \in \mathcal{A}} \left\{ \sum_{i,j=1}^n a_{ij}^{(\alpha,\beta)} M_{ij} + c_{\alpha\beta} \right\} = \min_{\beta \in \mathcal{B}} \max_{\alpha \in \mathcal{A}} \left\{ \text{tr} \left(A^{(\alpha,\beta)} M \right) + c_{\alpha\beta} \right\}.$$

This is because any Lipschitz function F can be written as the minimum of convex functions, and convex functions can be written as the maximum of linear functions.

In particular, every fully nonlinear uniformly elliptic equation

$$F(D^2u) = 0 \quad \text{in } \Omega$$

can be written as an Isaacs equation

$$\min_{\beta \in \mathcal{B}} \max_{\alpha \in \mathcal{A}} \{L_{\alpha\beta}u\} = 0 \quad \text{in } \Omega \quad \text{with} \quad L_{\alpha\beta}u = \sum_{i,j=1}^n a_{ij}^{(\alpha,\beta)} \partial_{ij}u + c_{\alpha\beta}.$$

Summary: Every fully nonlinear elliptic PDE has an interpretation in terms of a probabilistic game!

Probabilistic interpretation of PDEs.

Expected payoff	\longleftrightarrow	<u>Dirichlet problem</u> $\begin{cases} Lu = 0 & \text{in } \Omega \\ u = g & \text{on } \partial\Omega. \end{cases}$
Expected exit time (or running costs/ non-homogeneous environments)	\longleftrightarrow	<u>Dirichlet problem</u> $\begin{cases} -Lu = f & \text{in } \Omega \\ u = 0 & \text{on } \partial\Omega. \end{cases}$
Distribution of the process	\longleftrightarrow	<u>Heat equation</u> $\partial_t u - Lu = 0.$
Optimal stopping	\longleftrightarrow	<u>Obstacle problem</u> $\min\{-Lu, u - \varphi\} = 0.$
Controlled diffusion	\longleftrightarrow	<u>Fully nonlinear equation</u> $F(D^2u) = 0, \quad F \text{ convex.}$
Two-player games	\longleftrightarrow	<u>Fully nonlinear equation</u> $F(D^2u) = 0.$

One could even consider the equations with x -dependence, or with lower order terms. All equations studied in Chapters 4 and 5 have a probabilistic interpretation.

— DRAFT —

— DRAFT —

Motivations and applications for the obstacle problem

Here, we give a brief overview of the motivations and applications for the obstacle problem listed in Chapter 5. We refer to the books [DL76, KS80, Rod87, Fri88, PSU12] for more details, as well as for further applications of obstacle-type problems.

Fluid filtration. Consider two reservoirs of water at different heights separated by a porous dam. For simplicity, we will assume a flat dam, with rectangular cross section, which yields a problem in \mathbb{R}^2 . Alternatively, one could consider variable cross sections, which would yield an analogous obstacle problem in \mathbb{R}^3 instead.

The dam is permeable to the water, except in the base. Thus, there is some flow of fluid between the two reservoirs across the dam, and some wet part of the cross section depending only on the relative distance to each of the two water sources.

Let us assume one reservoir has water at height 1, and the other has water at height $0 < h < 1$. Let us denote by $\varphi(x)$ the profile of the water through the dam cross section. See Figure D.1 for a representation of the situation.

Let us denote by $u = u(x, y) : [0, 1] \times [0, 1] \rightarrow \mathbb{R}_+$ the hydraulic piezometric head of the fluid, given by the sum between the pressure $p(x, y)$ and

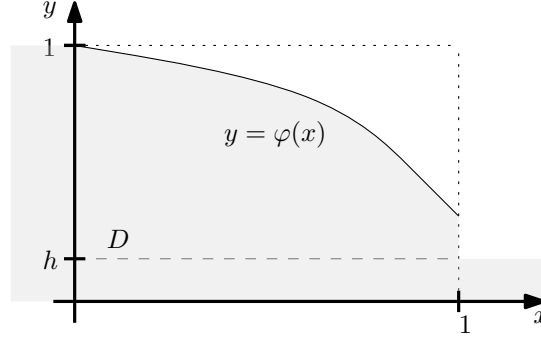

Figure D.1. Graphic representation of the cross section of a porous dam.

the elevation head (i.e., the potential energy of the fluid):

$$u(x, y) = y + \frac{1}{\gamma} p(x, y),$$

where γ is a constant depending on the fluid. The hydraulic head is defined where there is fluid, namely, in

$$D := \{(x, y) \in (0, 1) \times (0, 1) : y < \vartheta(x)\},$$

and is such that $u(0, y) = 1$ for $0 \leq y \leq 1$, and $u(1, y) = h$ for $0 \leq y \leq h$ and $u(1, y) = y$ for $h \leq y \leq \vartheta(1)$.

Here, u itself is an unknown, but D is also to be determined (and therefore, ϑ). In these circumstances we have that $u(x, y) \geq y$ in D , and if we define

$$w(x, y) := \int_y^{\varphi(x)} (u(x, \zeta) - \zeta) d\zeta \quad \text{for } (x, y) \in D,$$

and $w(x, y) \equiv 0$ for $(x, y) \in [0, 1] \times [0, 1] \setminus D$, then w fulfils the equation

$$\Delta w = \chi_{\{w>0\}} = \chi_D \quad \text{in } [0, 1] \times [0, 1].$$

That is, w is a solution to the obstacle problem (see (5.6)) with $f \equiv 1$.

We refer to [Bai74] and the references therein for more details about the Dam problem.

Phase transitions. The Stefan problem, dating back to the 19th century, is the most classical and important free boundary problem. It aims to describe the temperature distribution in a homogeneous medium undergoing a phase change, such as ice melting to water.

We denote by $\theta(x, t)$ the temperature (at position x and time t), and assume $\theta \geq 0$. The function θ satisfies the heat equation $\partial_t \theta - \Delta \theta = 0$ in the region $\{\theta > 0\}$, while the evolution of the free boundary $\partial\{\theta > 0\}$ is

dictated by the Stefan condition $\partial_t \theta = |\nabla_x \theta|^2$ on $\partial\{\theta > 0\}$ — where the gradient is computed from inside $\{\theta > 0\}$.

After the transformation $u(x, t) := \int_0^t \theta(x, \tau) d\tau$ (see [Duv73, Fig18]), the problem is locally equivalent to

$$\begin{cases} \partial_t u - \Delta u = -\chi_{\{u>0\}} & \text{in } B_1 \times (0, T) \subset \mathbb{R}^3 \times \mathbb{R} \\ u \geq 0 \\ \partial_t u \geq 0. \end{cases}$$

This is the parabolic version of the obstacle problem $\Delta u = \chi_{\{u>0\}}$ in B_1 .

Hele-Shaw flow. This model, dating back to 1898, describes a fluid flow between two flat parallel plates separated by a very thin gap. Various problems in fluid mechanics can be approximated to Hele-Shaw flows, and that is why understanding these flows is important.

A Hele-Shaw cell is an experimental device in which a viscous fluid is sandwiched in a narrow gap between two parallel plates. In certain regions, the gap is filled with fluid while in others the gap is filled with air. When liquid is injected inside the device through some sinks (e.g. through a small hole on the top plate) the region filled with liquid grows.

We denote by $p(x, t)$ the pressure of the fluid (at position x and time t). By definition, $\{p > 0\}$ is the region filled with liquid, while in $\{p = 0\}$ there is just air. The pressure p is harmonic in $\{p > 0\}$, and the evolution of the free boundary $\partial\{p > 0\}$ is dictated by $\partial_t p = |\nabla_x p|^2$ on $\partial\{p > 0\}$ — where the gradient is computed from inside $\{p > 0\}$. Notice the striking similarity to the Stefan problem — the only important difference here is that p is harmonic (and not caloric) in the region where it is positive.

After the transformation $u(x, t) = \int_0^t p(x, \tau) d\tau$, it turns out that u solves locally (i.e., outside the region where liquid is injected)

$$\begin{cases} \Delta u = \chi_{\{u>0\}} & \text{in } B_1 \times (0, T) \subset \mathbb{R}^2 \times \mathbb{R} \\ u \geq 0 \\ \partial_t u \geq 0. \end{cases}$$

This means that, for each fixed time t , $u(\cdot, t)$ is a solution to the (stationary) obstacle problem.

Optimal stopping, finance. As explained in Appendix C, the obstacle problem appears when considering optimal stopping problems for stochastic processes.

A typical example is the Black–Scholes model for pricing of American options. An American option is a contract that entitles its owner to buy some financial asset (typically a share of some company) at some specified price (the “strike price”) at any time — often before some specified date.

This option has some value, since in case that the always fluctuating market price of the asset goes higher than the strike price then the option can be “exercised” to buy the asset at the lower price. The Black-Sholes model aims to calculate the rational price $u = u(x, t)$ of an option at any time t prior to the maturity date and depending on the current price x of the financial asset. Since the option can be exercised at any time, determining the “exercise region” (i.e. the region in which it is better to exercise the option) is a part of the problem. Interestingly, this problem leads to an obstacle problem (often parabolic) posed in \mathbb{R}^n , where the dimension n is the number of assets.

We refer to [LS09] and the references therein for more details about such kind of models.

Interacting particle systems. Large systems of interacting particles arise in several models in the natural sciences (one can think of physical particles in Physics or Biology, for example). In such systems the discrete energy can be well approximated by the continuum interacting energy. We denote μ the (probability) measure representing the particle density.

In several models the particles attract each other when they are far, but experience a repulsive force when they are close [CDM16]. Then, the interaction energy E associated to the interaction potential $W \in L^1_{\text{loc}}(\mathbb{R}^3)$, is given by

$$E[\mu] := \frac{1}{2} \int_{\mathbb{R}^3} \int_{\mathbb{R}^3} W(x - y) d\mu(x) d\mu(y).$$

In general, the interaction potential can have very different structures. It is common to assume a repulsive behaviour for particles that are very close (blowing up at zero distance), and attractive behaviour when they are far. A typical assumption is to have $W(z) \sim |z|^{-1}$ near the origin.

In other models in statistical mechanics, the particles (e.g. electrons) repel with a Coulomb force and one wants to understand their behaviour in presence of some external field that confines them [Ser18]. In that case, the interaction energy associated with the system is given by

$$E[\mu] := \frac{1}{2} \int_{\mathbb{R}^3} \int_{\mathbb{R}^3} \frac{d\mu(x) d\mu(y)}{|x - y|} + \int_{\mathbb{R}^3} V d\mu.$$

One of the main questions when dealing with these systems is to understand the “equilibrium configurations”, that is, minimizers of the energy E .

It turns out that, in both cases, any minimizer μ_\circ is given by $\mu_\circ = -\Delta u$, with u satisfying (locally) the obstacle problem

$$\min\{-\Delta u, u - \varphi\} = 0,$$

for some obstacle φ that depends on W (or on V). The free boundary corresponds to the boundary of the region in which the particles concentrate.

We refer to [CDM16, Ser18] and the references therein for a thorough study of these problems.

Quasi-Steady Electrochemical Shaping. Electrochemical Machining (ECM) is an electrochemical method to remove metals (electroconductive) by placing the material inside an electrolytic cell as an anode, surrounded by a fixed cathode. Then an electric potential is applied between a cathode and an anode, which is submerged in an appropriate electrolyte, thus producing a chemical reaction that removes the metal from the anode and gives rise to a *moving boundary*. This method is used to shape extremely hard materials, to produce complicated shapes which are otherwise very difficult to obtain.

Let us suppose we have cylindrical symmetry (that is, both anode and cathode are long cylindrical materials), so that we can work with the cross section and thus in two dimensions. A similar approach works in the three-dimensional case.

Let $\Omega \subset \mathbb{R}^2$ denote the domain enclosed by the cathode, and $\Lambda(0) \subset \Omega$ denote the anode at time $t = 0$ (an electric potential is applied between $\partial\Omega$ and $\partial\Lambda(0)$, where the region $\Omega \setminus \Lambda(0)$ contains the electrolyte). Then, the metal starts to be removed, so that after a time $t \geq 0$, we denote by $\Lambda(t)$ the set defining the anode. By this process we have that $\Lambda(t) \subset \Lambda(t')$ if $t \geq t'$. The boundary $\Gamma(t) = \partial\Lambda(t)$ is unknown, it is a free boundary, which we assume is represented by a function $\gamma : \Omega \rightarrow \mathbb{R}$ as

$$\Gamma(t) = \{(x, y) \in \Omega : \gamma(x, y) = t\},$$

for some function γ to be determined. We assume that $\gamma(x, y) = 0$ in $\Omega \setminus \Lambda(0)$. If we denote by $\pi = \pi(t) > 0$ the potential difference at time $t > 0$ between anode and cathode, then the ECM problem is concerned with finding a function $\eta(t, x, y)$ that solves

$$\begin{aligned} \Delta\eta(t, x, y) &= 0 & \text{in } \Omega \setminus \Gamma(t), & \quad \eta(t, x, y) = 0 & \text{on } \{t > 0\} \times \partial\Omega, \\ \eta(t, x, y) &= \pi(t), & \quad \nabla\eta(t, x, y) \cdot \nabla\gamma(x, y) &= \lambda & \text{on } \{t > 0\} \times \Gamma(t) \end{aligned}$$

(with the convention that the gradient and the Laplacian are only taken in the spatial variables), for some constant $\lambda > 0$ (the ECM constant). Notice that $0 \leq \eta(t, x, y) \leq \pi(t)$ in $\Lambda(t)$ by the maximum principle, and let us extend η to Ω as $\eta(t, x, y) = \pi(t)$ in $\Lambda(t)$. Now, if we define

$$u(t, x, y) = \int_0^t (\pi(s) - \eta(s, x, y)) ds,$$

then $u \geq 0$ and in $\Lambda(0)$, u fulfils

$$\Delta u(t, \cdot, \cdot) = \lambda \chi_{\{u(t, \cdot, \cdot) > 0\}} \quad \text{for any } t > 0.$$

That is, u fulfils an obstacle problem (compare with (5.6)) with $f \equiv \lambda$, for each time $t > 0$. We refer to [Rod87] for more details.

Heat control. Given a domain Ω and a temperature T_o , we have heating devices evenly distributed on Ω that need to ensure that the temperature $u(x)$, $x \in \Omega$, is as close as possible to T_o , by injecting flux proportional to the distance between $u(x)$ and T_o . Due to the limited power of the devices, the heat flux generated by them needs to remain in the interval $(-q, 0]$ for $q \geq 0$.

Thus, the heat flux injected is

$$\Phi(u) = \max\{C(u - T_o)_-, -q\}$$

for some constant $C > 0$. In equilibrium, the temperature satisfies

$$\Delta u = \Phi(u) \quad \text{in } \Omega,$$

In particular, letting $C \rightarrow \infty$, the previous equation becomes

$$\Delta u = -q\chi_{\{u < T_o\}} \quad \text{in } \Omega.$$

Notice that this structure is almost the same as for the obstacle problem (upside down). That is, if we define $w = T_o - u$ then the previous equation becomes

$$\Delta w = q\chi_{\{w > 0\}} \quad \text{in } \Omega,$$

(see the parallelism to (5.6) with $f \equiv q > 0$). If $w \geq 0$ (that is, $u \leq T_o$) then this is exactly the obstacle problem. This can be obtained by putting Dirichlet boundary conditions on $\partial\Omega$ that are $u|_{\partial\Omega} \leq T_o$ (for example, in a room with lateral walls without thermal insulation). We refer to [DL76] for more details.

Elasticity. We finish with probably the most intuitive physical interpretation of the obstacle problem: the deformation of a thin membrane in elasticity theory.

Let us consider an elastic membrane represented by a function in \mathbb{R}^2 , $u : \mathbb{R}^2 \rightarrow \mathbb{R}$, so that $u(x, y)$ represents the vertical displacement with respect to the xy -plane. Given a domain $\Omega \subset \mathbb{R}^2$, we suppose that the membrane has a fixed boundary, that is, we prescribe the value of u on $\partial\Omega$, by some (say continuous) function $g : \partial\Omega \rightarrow \mathbb{R}$. We assume an homogeneous membrane equally stretched in all directions, whose shape is determined by the surface tension. For simplicity we also assume lack of external forces.

In this setting, the shape of the membrane will be such that the total area is minimized, among all possible configurations with the same boundary

values. Namely, the following functional

$$\int_{\Omega} \sqrt{1 + |\nabla w|^2} \, dx \, dy$$

is minimized among functions $w \in H^1(\Omega)$ such that $w|_{\partial\Omega} = g$. This yields the classical Plateau's problem. The Dirichlet energy appears as a lower order approximation of the previous functional. Namely, if we assume that the vertical displacements are not *large* (say, the membrane is *rather* flat), then a Taylor expansion of the functional yields

$$\int_{\Omega} \sqrt{1 + |\nabla w|^2} \, dx \, dy \sim \int_{\Omega} \left(1 + \frac{1}{2} |\nabla w|^2 \right) \, dx \, dy,$$

so that the minimization of the area is *roughly* a minimization of the Dirichlet energy.

The obstacle problem is concerned with finding the membrane that minimizes the Dirichlet energy (thus, approximately the area) among those with prescribed boundary, that lie above a given obstacle $\varphi : \mathbb{R}^2 \rightarrow \mathbb{R}$.

— DRAFT —

Notation

Let us introduce some of the notation be used throughout the book.

Matrix notation.

$A = (a_{ij})_{ij}$	Matrix with (i, j) – th entry denoted by a_{ij} .
\mathcal{M}_n	Space of matrices of size $n \times n$.
Id	Identity matrix.
$\text{tr } A$	Trace of the matrix A , $\text{tr } A = a_{11} + \dots + a_{nn}$.
$\det A$	Determinant of the matrix A .
A^T	Transpose of the matrix A .

Geometric notation.

$\mathbb{R}^n, \mathbb{S}^n$	n -dimensional Euclidean space, n -sphere.
$e_i \in \mathbb{S}^{n-1}$	i – th element of the base, $e_i = (0, \dots, 0, \overset{(i)}{1}, 0, \dots, 0)$.
$x \in \mathbb{R}^n$	Typical point $x = (x_1, \dots, x_n)$.
$ x $	Modulus of the point x , $ x = \sqrt{x_1^2 + \dots + x_n^2}$.
$ U $	n -dimensional Lebesgue measure of a set $U \subset \mathbb{R}^n$.
\mathbb{R}_+^n	$\{x = (x_1, \dots, x_n) \in \mathbb{R}^n : x_n > 0\}$.
∂U	Boundary of the set $U \subset \mathbb{R}^n$.
$V \subset\subset U$	The set V is compactly contained in U , that is $\bar{V} \subset U$.
$B_r(x)$	Ball of radius r centered at x , $B_r(x) := \{y \in \mathbb{R}^n : x - y < r\}$.
$x \cdot y$	For $x, y \in \mathbb{R}^n$, scalar product of x and y , $x \cdot y = x_1y_1 + \dots + x_ny_n$.

Functional notation.

u	In general, u denotes a function $u : \mathbb{R}^n \rightarrow \mathbb{R}$ (unless stated otherwise).
u^+, u^-	Positive and negative part of a function, $u^+ = \max\{u, 0\}$, $u^- = \max\{-u, 0\}$.
χ_E	Characteristic function of the set E , $\chi_E(x) = 1$ for $x \in E$, and $\chi_E(x) = 0$ for $x \notin E$.
$\text{supp } u$	Support of u , $\text{supp } u = \overline{\{x : u(x) \neq 0\}}$.
f_A	Average integral over the positive measure set A , $f_A f := \frac{1}{ A } \int_A f$.

Function spaces. Let $U \subset \mathbb{R}^n$ be an open set.

$C(U), C^0(U)$	Space of continuous functions $u : U \rightarrow \mathbb{R}$.
$C(\bar{U}), C^0(\bar{U})$	Functions $u \in C(U)$ continuous up to the boundary.
$C^k(U), C^k(\bar{U})$	Space of functions k times continuously differentiable.
$C^{k,\alpha}(U)$	Hölder spaces, see Section 1.1.
$C^\infty(U), C^\infty(\bar{U})$	Set of functions in $C^k(U)$ or $C^k(\bar{U})$ for all $k \geq 1$.
$C_c(U), C_c^k(U)$	Set of functions with compact support in U .
$C_0(U), C_0^k(U)$	Set of functions with $u = 0$ on ∂U .
L^p	L^p space, see Section 1.1.
L^∞	L^∞ space, see Section 1.1 (see $\text{esssup}_\Omega u$ below).
$\text{esssup}_\Omega u$	Essential supremum of u in Ω : infimum of the essential upper bounds, $\text{esssup}_\Omega u := \inf\{b > 0 : \{u > b\} = 0\}$.
$W^{1,p}, W_0^{1,p}$	Sobolev spaces, see Section 1.1 and (S7) .
H^1, H_0^1	Sobolev spaces with $p = 2$, see Section 1.1 and (S7) .
$\ \cdot\ _{\mathcal{F}}$	Norm in the functional space $\mathcal{F} \in \{C^0, C^k, L^p, \dots\}$, defined when used for the first times.

Differential notation. Let $u : U \rightarrow \mathbb{R}$ be a function.

$\partial_i u, \partial_{x_i} u, u_{x_i}$	Partial derivative in the e_i direction, $\frac{\partial u}{\partial x_i}$.
$\partial_e u$	Derivative in the $e \in \mathbb{S}^{n-1}$ direction.
$\nabla u, Du$	Gradient, $\nabla u = (\partial_1 u, \dots, \partial_n u)$.
$\partial_{ij} u, \partial_{x_i x_j} u, u_{x_i x_j}$	Second partial derivatives in the directions e_i and e_j , $\frac{\partial^2 u}{\partial x_i \partial x_j}$.
$D^2 u$	Hessian, $D^2 u = (\partial_{ij} u)_{ij} \in \mathcal{M}_n$.
$D^k u$	Higher derivatives forms, $D^k u := (\partial_{i_1 \dots i_k} u)_{i_1, \dots, i_k}$.
$ D^k u(x) $	Norm of $D^k u(x)$ (any equivalent norm).
$\ D^k u(x)\ _{\mathcal{F}}$	Norm of $D^k u$, $\ \ D^k u\ \ _{\mathcal{F}}$.
Δu	Laplacian of u , $\Delta u = \partial_{11} u + \dots + \partial_{nn} u$.

Domains. We say that $\Omega \subset \mathbb{R}^n$ is a domain if it is an open connected set.

A domain Ω is said to be $C^{k,\alpha}$ (resp. C^k) if $\partial\Omega$ can be written locally as the graph of a $C^{k,\alpha}$ (resp. C^k) function.

— DRAFT —

Bibliography

- [AH96] D. Adams, L. Hedberg, *Function Spaces and Potential Theory*, Springer, Grundlehren der mathematischen Wissenschaften, 1996.
- [AS19] M. Allen, H. Shahgholian, *A new boundary Harnack principle (equations with right hand side)*, Arch. Rat. Mech. Anal. **234** (2019), 1413-1444.
- [ACM18] L. Ambrosio, A. Carlotto, A. Massaccesi, *Lectures on Elliptic Partial Differential Equations*, Lecture notes Scuola Normale Superiore di Pisa **18**, Springer, 2018.
- [And97] P. Andersson, *Characterization of pointwise Hölder regularity*, Appl. Comp. Harmon. Anal. **4** (1997), 429-443.
- [ASS12] S. N. Armstrong, L. Silvestre, C. K. Smart, *Partial regularity of solutions of fully nonlinear uniformly elliptic equations*, Comm. Pure Appl. Math. **65** (2012), 1169-1184.
- [Bai74] C. Baiocchi, *Free boundary problems in the theory of fluid flow through porous media*, in Proceedings of the ICM 1974.
- [Bon01] L. P. Bonorino, *Regularity of the free boundary for some elliptic and parabolic problems. I*, Comm. Partial Differential Equations **26** (2001), 175-203.
- [Bre11] H. Brezis, *Functional Analysis, Sobolev spaces and Partial Differential Equations*, Springer, 2011.
- [Caf77] L. Caffarelli, *The regularity of free boundaries in higher dimensions*, Acta Math. **139** (1977), 155-184.
- [Caf89] L. Caffarelli, *Interior a priori estimates for solutions of fully nonlinear equations*, Ann. of Math. **130** (1989), 189-213.
- [Caf98] L. Caffarelli, *The obstacle problem revisited*, J. Fourier Anal. Appl. **4** (1998), 383-402.
- [CC95] L. Caffarelli, X. Cabré, *Fully Nonlinear Elliptic Equations*, American Mathematical Society Colloquium Publications **43**, American Mathematical Society, 1995.
- [CCKS96] L. Caffarelli, M. Crandall, M. Kocan, A. Świąch, *On viscosity solutions of fully nonlinear equations with measurable ingredients*, Comm. Pure Appl. Math. **49** (1996), 365-398.
- [CDS18] L. Caffarelli, D. De Silva, O. Savin, *Two-phase anisotropic free boundary problems and applications to the Bellman equation in 2D*, Arch. Rat. Mech. Anal. **228** (2018), 477-493.

— DRAFT —

- [CS05] L. Caffarelli, S. Salsa, *A Geometric Approach to Free Boundary Problems*, American Mathematical Society, 2005.
- [CS10] L. Caffarelli, L. Silvestre, *On the Evans-Krylov theorem*, Proc. Amer. Math. Soc. **138** (2010), 263-265.
- [CV10] L. Caffarelli, A. Vasseur, *The De Giorgi method for regularity of solutions of elliptic equations and its applications to fluid dynamics*, Discrete Contin. Dyn. Syst. Ser. S **3** (2010), 409-427.
- [CDM16] J. A. Carrillo, M. G. Delgadino, A. Mellet, *Regularity of local minimizers of the interaction energy via obstacle problems*, Comm. Math. Phys. **343** (2016), 747-781.
- [CSV18] M. Colombo, L. Spolaor, B. Velichkov, *A logarithmic epiperimetric inequality for the obstacle problem*, Geom. Funct. Anal. **28** (2018), 1029-1061.
- [DeG57] E. De Giorgi, *Sulla differenziabilità e l'analiticità delle estremali degli integrali multipli regolari*, Memorie della Accademia delle Scienze di Torino. Classe di Scienze Fisiche, Matematiche e Naturali **3** (1957), 25-43.
- [DS10] D. De Silva, O. Savin, *Minimizers of convex functionals arising in random surfaces*, Duke Math. J. **151** (2010), 487-532.
- [DS16] D. De Silva, O. Savin, *A note on higher regularity boundary Harnack inequality*, Disc. Cont. Dyn. Syst. **35** (2015), 6155-6163.
- [DS20] D. De Silva, O. Savin, *A short proof of boundary Harnack inequality*, J. Differential Equations **269** (2020), 2419-2429.
- [DS21] D. De Silva, O. Savin, *Quasi-Harnack inequality*, Amer. J. Math. **143** (2021), 307-331.
- [DV21] S. Dipierro, E. Valdinoci, *Elliptic Partial Differential Equations from an Elementary Viewpoint*, preprint arXiv (2021).
- [Duv73] G. Duvaut, *Résolution d'un problème de Stefan (Fusion d'un bloc de glace a zero degrés)*, C. R. Acad. Sci. Paris **276** (1973), 1461-1463.
- [DL76] G. Duvaut, J. L. Lions, *Inequalities in Mechanics and Physics*, Grundlehren der Mathematischen Wissenschaften, vol. **219**, Springer-Verlag, 1976.
- [EM17] L. Escauriaza, S. Montaner, *Some remarks on the L^p regularity of second derivatives of solutions to non-divergence elliptic equations and the Dini condition*, Rend. Lincei-Mat. Appl. **28** (2017) 49-63.
- [Eva82] L. C. Evans, *Classical solutions of fully nonlinear, convex, second-order elliptic equations*, Comm. Pure Appl. Math. **35** (1982), 333-363.
- [Eva98] L. C. Evans, *Partial Differential Equations*, American Mathematical Society, 1998.
- [Eva13] L. C. Evans, *An Introduction to Stochastic Differential Equations*, American Mathematical Society, 2013.
- [EG92] L. C. Evans, R. Gariepy, *Measure Theory and Fine Properties of Functions*, CRC Press, 1992.
- [Fer22] X. Fernández-Real, *The thin obstacle problem: a survey*, Publ. Mat. **66** (2022), 3-55.
- [Fig18] A. Figalli, *Regularity of interfaces in phase transitions via obstacle problems*, In Proceedings of the International Congress of Mathematicians (ICM 2018), Vol. I, pp. 225-247, World Scientific, Hackensack, NJ, 2019 in Proceedings of the ICM 2018.
- [Fig18b] A. Figalli, *Free boundary regularity in obstacle problems*, Journées équations aux dérivées partielles (2018), 2, 24 p.

- [FRS20] A. Figalli, X. Ros-Oton, J. Serra, *Generic regularity of free boundaries for the obstacle problem*, Publ. Math. Inst. Hautes Études Sci. **132** (2020), 181-292.
- [FS19] A. Figalli, J. Serra, *On the fine structure of the free boundary for the classical obstacle problem*, Invent. Math. **215** (2019), 311-366.
- [FZ21] F. Franceschini, W. Zatoń, *C^∞ partial regularity of the singular set in the obstacle problem*, preprint arXiv (2021).
- [Fri88] A. Friedman, *Variational Principles and Free Boundary Problems*, 2nd edn., Robert E. Krieger Publishing Co., Malabar, FL, 1988.
- [GT77] D. Gilbarg, N. S. Trudinger, *Elliptic Partial Differential Equations Of Second Order*, Grundlehren der Mathematischen Wissenschaften, vol. **224**, Springer-Verlag, 1977.
- [HL97] Q. Han, F. Lin, *Elliptic Partial Differential Equations*, American Mathematical Society, 1997.
- [JTW83] S. Janson, M. Taibleson, G. Weiss, *Elementary characterizations of the Morrey-Campanato spaces*, in Harmonic Analysis, Lecture Notes in Mathematics, Springer Berlin Heidelberg 1983.
- [Jen88] R. Jensen, *The maximum principle for viscosity solutions of fully nonlinear second order partial differential equations*, Arch. Rational Mech. Anal. **101** (1988), 1-27.
- [JMV09] T. Jin, V. Maz'ya, J. Van Schaftingen, *Pathological solutions to elliptic problems in divergence form with continuous coefficients*, C. R. Math. Acad. Sci. Paris **347**, (2009) 773-778.
- [JN61] F. John, L. Nirenberg, *On functions of bounded mean oscillation*, Comm. Pure Appl. Math. **14** (1961), 415-426.
- [JW84] A. Jonsson, H. Wallin *Function spaces on subsets of \mathbb{R}^n* , Mathematical Reports, Harwood Academic Publishers, 1984.
- [Ken94] C. Kenig, *Harmonic Analysis Techniques for Second Order Elliptic Boundary Value Problems*, vol. 83, Published for the Conference Board of the Mathematical Sciences, Washington, DC; by the American Mathematical Society, Providence, RI, 1994.
- [KN77] D. Kinderlehrer, L. Nirenberg, *Regularity in free boundary problems*, Ann. Sc. Norm. Sup. Pisa **4** (1977), 373-391.
- [KS80] D. Kinderlehrer, G. Stampacchia, *An Introduction to Variational Inequalities and Their Applications*, SIAM, 1980.
- [Kry82] N. V. Krylov, *Boundedly inhomogeneous elliptic and parabolic equations*, Izv. Akad. Nauk SSSR Ser. Mat. **46** (1982), 487-523.
- [Kry96] N. V. Krylov, *Lectures on Elliptic and Parabolic Equations in Hölder spaces*, American Mathematical Society, 1996.
- [KS79] N. V. Krylov, M. V. Safonov, *An estimate for the probability of a diffusion process hitting a set of positive measure*, Doklady Akademii Nauk SSSR **245** (1979), 18-20.
- [LS09] P. Laurence, S. Salsa, *Regularity of the free boundary of an American option on several assets*, Comm. Pure Appl. Math. **62** (2009), 969-994.
- [Law10] G. F. Lawler, *Random Walk and the Heat Equation*, American Mathematical Society, 2010.
- [LZ17] D. Li, K. Zhang, *A note on the Harnack inequality for elliptic equations in divergence form*, Proc. Amer. Math. Soc. **145** (2017), 135-137.
- [Mag11] F. Maggi, *Dispense del Corso di Calcolo delle Variazioni*, (Italian) Lecture notes (2011).

- [Mat95] P. Mattila, *Geometry of Sets and Measures in Euclidean Spaces: Fractals and Rectifiability*, Cambridge University Press, 1995.
- [Mon03] R. Monneau, *On the number of singularities for the obstacle problem in two dimensions*, J. Geom. Anal. **13** (2003), 359-389.
- [Moo12] C. Mooney, *Notes on Elliptic PDE*, Lecture notes available at the webpage of the author (2012).
- [Moo19] C. Mooney, *A proof of the Krylov-Safonov theorem without localization*, Comm. Partial Differential Equations **44** (2019), 681-690.
- [Moo20] C. Mooney, *Minimizers of convex functionals with small degeneracy set*, Calc. Var. Partial Differential Equations **59** (2020), 74.
- [Mos61] J. Moser, *On Harnack's theorem for elliptic differential equations*, Comm. Pure Appl. Math. **14** (1961), 577-591.
- [Nad97] N. Nadirashvili, *Nonuniqueness in the martingale problem and the Dirichlet problem for uniformly elliptic operators*, Ann. Scuola Norm. Sup. Pisa Cl. Sci. **24** (1997), 537-549.
- [NTV14] N. Nadirashvili, V. Tkachev, S. Vladuts, *Nonlinear Elliptic Equations and Nonassociative Algebras*, AMS Mathematical Surveys and Monographs, 2014.
- [NV07] N. Nadirashvili, S. Vladuts, *Nonclassical solutions of fully nonlinear elliptic equations*, Geom. Funct. Anal. **17** (2007), 1283-1296.
- [NV08] N. Nadirashvili, S. Vladuts, *Singular viscosity solutions to fully nonlinear elliptic equations*, J. Math. Pures Appl. **89** (2008), 107-113.
- [NV13] N. Nadirashvili, S. Vladuts, *Singular solutions of Hessian elliptic equations in five dimensions*, J. Math. Pures Appl. **100** (2013), 769-784.
- [Nas57] J. F. Nash, *Parabolic equations*, Proc. Nat. Acad. Sci. U.S.A. **43** (1957), 754-758.
- [Nas58] J. F. Nash, *Continuity of solutions of parabolic and elliptic equations*, Amer. J. Math. **80** (1958), 931-954.
- [Nir53] L. Nirenberg, *On nonlinear elliptic Partial Differential Equations and Hölder continuity*, Comm. Pure Appl. Math. **6** (1953), 103-156.
- [PSU12] A. Petrosyan, H. Shahgholian, N. Uraltseva, *Regularity of free boundaries in obstacle-type problems*, Graduate Studies in Mathematics, Vol. **136**. American Mathematical Society, Providence, RI, 2012.
- [Rod87] J.-F. Rodrigues, *Obstacle Problems in Mathematical Physics*, North-Holland mathematics Studies **134**, 1987.
- [RT21] X. Ros-Oton, D. Torres-Latorre, *New boundary Harnack inequalities with a right hand side*, J. Differential Equations **288** (2021), 204-249.
- [Saf87] M. V. Safonov, *Unimprovability of estimates of Hölder constants for solutions of linear elliptic equations with measurable coefficients*, (Russian) Mat. Sb. (N.S.) **132** (1987), 275-288; translation in Math. USSR-Sb. **60** (1988), 269-281.
- [SY23] O. Savin, H. Yu, *Regularity of the singular set in the fully nonlinear obstacle problem*, J. Eur. Math. Soc. (2023), to appear.
- [Sch74] D. G. Schaeffer, *An example of generic regularity for a nonlinear elliptic equation*, Arch. Rat. Mech. Anal. **57** (1974), 134-141.
- [Sch77] D. G. Schaeffer, *Some examples of singularities in a free boundary*, Ann. Scuola Norm. Sup. Pisa **4** (1977), 133-144.
- [Ser18] S. Serfaty, *Systems of points with Coulomb interactions*, In Proceedings of the International Congress of Mathematicians (ICM 2018), Vol. I, pp. 935-977, World Scientific, Hackensack, NJ, 2019.

- [Sil15] L. Silvestre, *Viscosity solutions to elliptic equations*, Lecture Notes available at the webpage of the author (2015).
- [Sim97] L. Simon, *Schauder estimates by scaling*, Calc. Var. Partial Differential Equations **5** (1997), 391-407.
- [Spr83] J. Spruck, *Uniqueness in a diffusion model of population biology*, Comm. Partial Differential Equations **8** (1983), 1605-1620.
- [Str80] R. Strichartz, *Bounded mean oscillation and Sobolev spaces*, Indiana Univ. Math. J. **29** (1980), 539-558.
- [ICM94] S. R. S. Varadhan, *The work of Pierre-Louis Lions*, in Proceedings of the ICM 1994.
- [Vas16] A. Vasseur, *The De Giorgi method for elliptic and parabolic equations and some applications*, Part 4, 195-222, Morningside Lect. Math., **4**, Int. Press, Somerville, MA, 2016.
- [Vel23] B. Velichkov, *Regularity of the One-Phase Free Boundaries*, Lect. Notes Unione Mat. Ital., Springer, Cham, 2023.
- [Wan06] X.-J. Wang, *Schauder estimates for elliptic and parabolic equations*, Chinese Ann. Math. Ser. B **27** (2006), 637-642.
- [Wei99] G. S. Weiss, *A homogeneity improvement approach to the obstacle problem*, Invent. Math. **138** (1999), 23-50.

— DRAFT —

Index

- Arzelà-Ascoli Theorem, 9
- Average integral, 3

- Bellman equation, 100, 206
- Boundary Harnack, 168, 191
 - Higher order regularity, 170
- Boundary regularity Laplace equation, 69
- Brownian motion, 21

- Classification of blow-ups, 150, 158
- Comparison principle
 - Fully nonlinear equations (classical), 98
 - Fully nonlinear equations (viscosity), 107
 - Laplace equation, 14
- Controlled diffusion, 205
- Convex fully nonlinear equations, 100
- Covering argument, 36

- De Giorgi–Nash, 74, 81
- Dirichlet problem
 - Fully nonlinear equations, 113
 - Laplace equation, 9
- Divergence-form PDE, 25

- Elasticity, 216
- Ellipticity condition
 - Fully nonlinear equations, 98
- Ellipticity constants
 - Fully nonlinear equations, 99
 - Linear equations, 25
- Energy inequality, 84

- Energy method, 10
- Equation in divergence form with
 - bounded measurable coefficients, 74, 81
- Equation in non-divergence form with
 - bounded measurable coefficients, 102
- Equations in two variables (fully nonlinear), 102, 120
- Euler–Lagrange for obstacle problem, 126
- Evans–Krylov Theorem, 120
- Existence and uniqueness
 - Laplace equation, 12
 - Minimizers convex functional, 75
 - Obstacle problem, 131, 141
 - Viscosity solutions, 110
- Expected exit time, 204
- Expected hitting time, 23
- Expected payoff, 22, 202
- Extremal operators, 101

- Fluid filtration, 211
- Free boundary, 127
- Fully nonlinear equation, 97
- Fundamental solution, 13

- Generic regularity, 177

- Hölder norm, 6
- Hölder semi-norm, 6
- Hölder space, 6
- Harnack inequality, 26
- Harnack’s inequality, 31

DRAFT

- Heat control, 216
 Hele-Shaw flow, 213
 Higher order Schauder estimates
 Divergence form, 59
 Laplacian, 38
 Non-divergence form, 46
 Hilbert XIXth problem, 71, 94
 Homogeneity of blow-ups, 151
 Hopf Lemma, 16
- Infinitesimal generator, 202
 Integration by parts, 4
 Interacting particle systems, 214
 Interpolation inequalities, 9
 Isaacs equation, 206
- Krylov–Safonov Theorem, 119
- Least supersolution, 134
 Lebesgue differentiation theorem, 3
 Liouville Theorem, 18, 30
- Maximum principle
 Divergence form, 60
 Laplace equation, 14
 Non-divergence form, 48
 Mean value property, 16
 Monneau monotonicity formula, 173
 Morrey inequality, 6
- Nadirashvili–Vladuts counterexamples, 121
 Non-divergence-form PDE, 25
 Nondegeneracy, Obstacle problem, 139, 146
- Obstacle problem, 125
 Optimal regularity, Obstacle problem, 136, 144
 Optimal stopping, 204, 213
 Oscillation decay, 28, 31, 89
- Perron’s method for viscosity solutions, 108
 Phase transitions, 212
 Poincaré inequality, 6
 Poisson kernel, 13
 Probabilistic interpretation of PDEs, 209
 Pucci operators, 101
- Quasi-Steady Electrochemical Shaping, 215
- Regular points, 148
 Regularity of the free boundary, 169
 Higher regularity, 170
- Schaeffer conjecture, 178
 Schauder estimates
 Divergence form, 59
 Laplacian, 36
 Non-divergence form, 46
 Schauder estimates for continuous coefficients
 Divergence form, 65
 Non-divergence form, 64
 Singular points, 148
 Size, 175
 Sobolev inequality, 5
 Sobolev space, 4
 Stability of viscosity solutions, 114
 Subharmonic function, 14
 Superharmonic function, 14
- Two-players game, 206
- Uniform ellipticity condition, 25
 Fully nonlinear equations, 99, 100
 Linear equations, 47
 Uniqueness of blow-ups at singular points, 173
- Viscosity solution, 19, 106
 Viscosity subsolution, 106
 Viscosity supersolution, 106
- Weak solution, 11
 Weiss monotonicity formula, 152