

One-dimensional topological theories with defects: the linear case

Mee Seong Im and Mikhail Khovanov

ABSTRACT. The paper studies the Karoubi envelope of a one-dimensional topological theory with defects and inner endpoints, defined over a field. It turns out that the Karoubi envelope is determined by a symmetric Frobenius algebra \mathcal{K} associated to the theory. The Karoubi envelope is then equivalent to the quotient of the Frobenius–Brauer category of \mathcal{K} modulo the ideal of negligible morphisms. Symmetric Frobenius algebras, such as \mathcal{K} , describe two-dimensional TQFTs for the category of thin flat surfaces, and elements of the algebra can be turned into defects on the side boundaries of these surfaces. We also explain how to couple \mathcal{K} to the universal construction restricted to closed surfaces to define a topological theory of open-closed two-dimensional cobordisms which is usually not an open-closed 2D TQFT.

CONTENTS

1. Introduction	1
2. One-dimensional topological theories with defects over a field	2
2.1. A one-dimensional defect TQFT from a noncommutative power series	2
2.2. One-variable case and comparison to two-dimensional theory	9
2.3. A topological theory when a circular series is added	12
2.4. Karoubi envelope decomposition for arbitrary rational α	16
3. From 1D to 2D	25
3.1. Category of thin flat surfaces and symmetric Frobenius algebras	25
3.2. Open-closed TQFTs and topological theories	30
4. Embeddings into a 1D TQFT and dimensional lifting	36
References	37

1. Introduction

Universal construction [BHMV95, Kho20a] starts with an evaluation function for closed n -manifolds to produce state space for closed $(n-1)$ -manifolds and maps between these spaces associated to n -cobordisms. This results in a functor from the category of n -dimensional cobordisms to the category of vector spaces (if the evaluation function takes values in a field) which usually fails to be a TQFT, with the tensor product of state spaces for two $(n-1)$ -manifolds N_1, N_2 properly embedded

Date: April 4, 2023.

2020 Mathematics Subject Classification. Primary: 18M05, 18M30, 57K16, 16W60, 15A63.

Key words and phrases. Rational noncommutative power series, topological theory, universal construction, topological quantum field theory (TQFT), defects in TQFT, Brauer categories, symmetric Frobenius algebras.

into the state space for their union:

$$(1) \quad A(N_1) \otimes A(N_2) \hookrightarrow A(N_1 \sqcup N_2).$$

Universal construction for foams in \mathbb{R}^3 in place of n -cobordisms is used as an intermediate step in constructing link homology theories [Kho04, MV07, RW20], see also a review in [KK20] and papers [Kho20b, Mei21] for other uses and references for the universal construction.

The universal construction turns out to be interesting already in low dimensions, including in dimensions two [Kho20b, KS21, KOK22, KQR21] and one [Kho20a, IK22, IZ22, IKO23, GIK+23]. In the latter case, one needs to add zero-dimensional defects (0-submanifolds) with labels in a set Σ . An oriented interval with a collection of Σ -labelled defects encodes a word ω , that is, an element of the free monoid Σ^* on the set Σ . An oriented circle with labels in Σ encodes a word up to cyclic equivalence. Given an evaluation of each word and a separate evaluation of words up to cyclic equivalence, there is an associated rigid linear monoidal category, defined and studied in [Kho20a]. It is straightforward to see [Kho20a] that the hom spaces in the resulting categories are finite-dimensional if and only if the evaluations are given by *rational* noncommutative power series [BR90, RRV99].

In the present paper we study this category for a rational evaluation α . The Karoubi closure of the resulting category can be reduced to the Karoubi closure of a category built from a symmetric Frobenius algebra \mathcal{K} that can be extracted from α , as explained in Section 2.4. Sections 2.1-2.3 are devoted to the setup, basic theory and various examples. In Section 3 we review thin flat surface 2D TQFTs associated to symmetric Frobenius algebras and explain how to enhance these TQFTs by 0-dimensional defects floating along the boundary that carry elements of the algebra. Throughout the paper we run comparisons between one-dimensional theories with defects and two-dimensional theories without defects and discuss nonsemisimple versus semisimple TQFTs in two dimensions.

The Boolean analogues of these categories and their relation to automata and regular languages are investigated in [IK22], where the absence of linear structure creates additional complexities.

Acknowledgments. We would like to thank Aaron Lauda and Vladimir Retakh for illuminating discussions. M.S.I. was partially supported by Naval Academy Research Council (Jr. NARC) Fellowship over the summer. M.K. gratefully acknowledges partial support via NSF grants DMS-1807425, DMS-2204033 and Simons Collaboration Award 994328.

2. One-dimensional topological theories with defects over a field

We fix a ground field \mathbf{k} .

2.1. A one-dimensional defect TQFT from a noncommutative power series. Start with a finite set (or alphabet) Σ . Let Σ^* be the set of finite words in letters of Σ (elements of Σ), and Σ_\circ^* be the set of circular words, *i.e.*, elements of Σ^* up to the equivalence relation $\omega_1\omega_2 \sim \omega_2\omega_1$. The empty word \emptyset is included in both Σ^* and Σ_\circ^* . Suppose we are given an evaluation

$$(2) \quad \alpha = (\alpha_1, \alpha_\circ),$$

where

$$(3) \quad \alpha_1 : \Sigma^* \longrightarrow \mathbf{k}, \quad \alpha_\circ : \Sigma_\circ^* \longrightarrow \mathbf{k}$$

are two functions on words and circular words in Σ , respectively, with values in a field \mathbf{k} . To α , following [Kho20a] (also see earlier work [KS21, KOK22] for a similar framework), there is assigned a symmetric \mathbf{k} -linear monoidal category \mathcal{C}_α . Its objects are finite sign sequences ε , thought of as oriented 0-manifolds, and morphisms are \mathbf{k} -linear combinations of oriented 1-cobordisms with 0-dimensional defects, the latter decorated by elements of Σ . See 2.1.1. One-cobordisms can have “inner” boundary points, in addition to “outer” boundary points that define the objects for the morphism. Forming the composition of two such cobordisms may result in components without any “outer” boundary

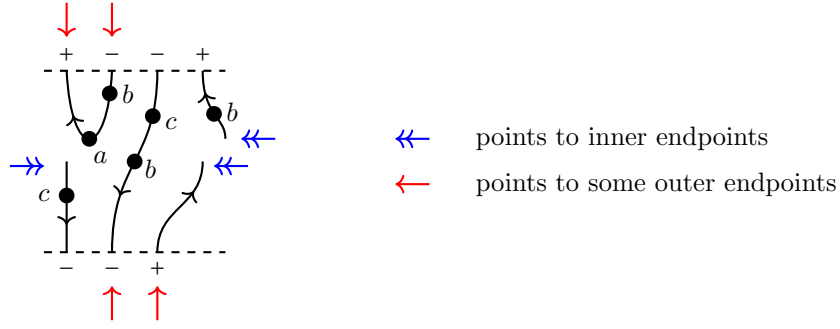

FIGURE 2.1.1. A morphism from $--+$ to $+--+$ in \mathcal{C}_α represented by a diagram with 3 inner endpoints. This diagram has 7 outer endpoints, 3 at the bottom and 4 at the top. Some of these endpoints are indicated by smaller (red and blue) arrows.

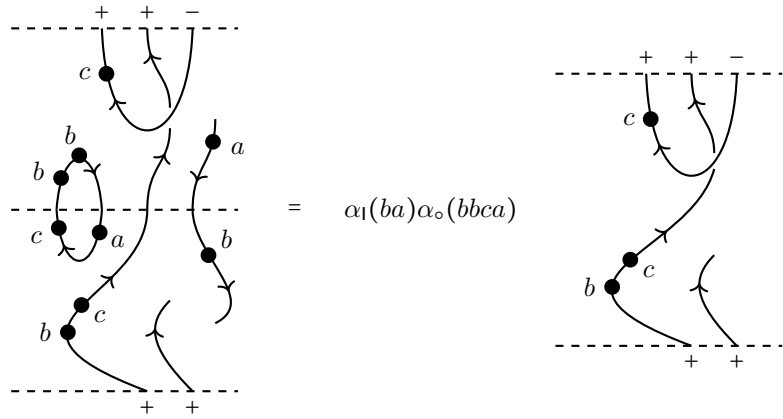

FIGURE 2.1.2. An example of computing the composition of morphisms in \mathcal{C}_α .

points, called *floating* intervals and circles. See 2.1.2. These floating components are evaluated via the interval and circle evaluation functions α_1 and α_o , respectively, and the composition is then reduced to a diagram without floating connected components.

Two linear combinations of such morphisms between sequences ε and ε' are equal if any closures of these two linear combinations evaluate to the same element of \mathbf{k} via α , see [KS21, Kho20a].

The state space $A_\alpha(\varepsilon) := \text{Hom}_{\mathcal{C}_\alpha}(\emptyset_0, \varepsilon)$ of a sequence ε is defined as the space of homs from the empty sign sequence \emptyset_0 to ε in \mathcal{C}_α (we use different notations $\emptyset \in \mathbf{k}\Sigma^*$ for the empty word and \emptyset_0 for the empty oriented 0-manifold and the corresponding object of \mathcal{C}_α).

We say that α is *rational* if the following equivalent conditions hold:

- State spaces $A_\alpha(\varepsilon)$ are finite-dimensional for all ε .
- Hom spaces in \mathcal{C}_α are finite-dimensional.
- Spaces $A(+)$ and $A(+)$ are finite-dimensional.
- $A(+)$ is finite-dimensional.

Each of these conditions is equivalent to both of the noncommutative power series α_1, α_o in (2), (3) being rational in the sense of [BR90] (having a finite-dimensional state space, equivalently, a finite-dimensional syntactic algebra, see also [Kho20a]).

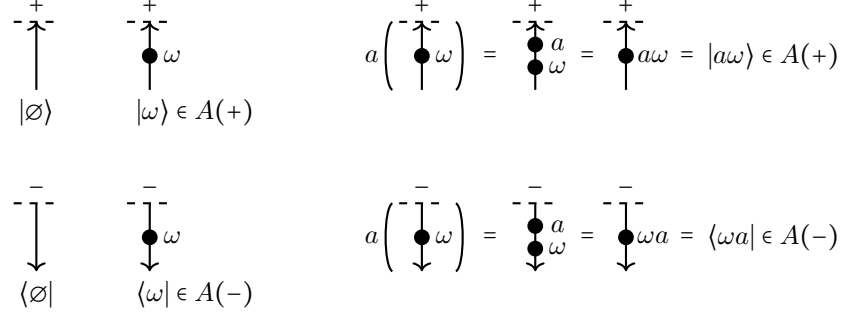

FIGURE 2.1.3. Top row: diagrams of $|\emptyset\rangle, |\omega\rangle \in A(+)$ and the action of a on $|\omega\rangle$. Bottom row: similar diagrams for $A(-)$.

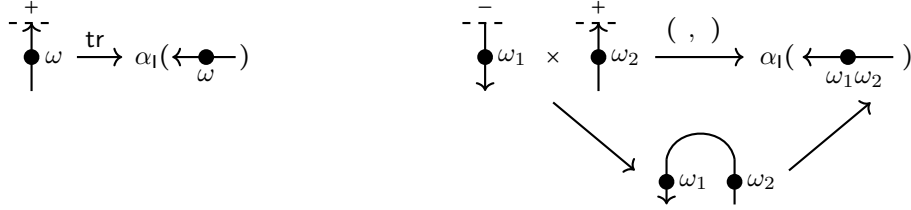

FIGURE 2.1.4. Figure of the trace map on $A(+)$ and of the pairing (6).

Category \mathcal{C}_α is \mathbf{k} -linear and preadditive. For rational α , it is convenient to consider the Karoubi closure $\text{Kar}(\mathcal{C}_\alpha)$ of \mathcal{C}_α (also denoted $\underline{\mathcal{DC}}_\alpha$ in [KS21, Kho20a] in this and related cases) given by forming finite direct sums of objects and then adding objects for idempotent endomorphisms of these direct sums. The category $\text{Kar}(\mathcal{C}_\alpha)$ is \mathbf{k} -linear, additive, idempotent-closed, with finite-dimensional hom spaces over \mathbf{k} . There is a fully-faithful functor

$$(4) \quad \mathcal{C}_\alpha \longrightarrow \text{Kar}(\mathcal{C}_\alpha).$$

Assume from now on that evaluation α is rational. \mathbf{k} -vector space $A(+)$ is a left $\mathbf{k}\Sigma^*$ -module, that is, a module over the ring of noncommutative polynomials in letters in Σ , equivalently the monoid algebra of the free monoid Σ^* . Module $A(+)$ has a distinguished element $|\emptyset\rangle$ corresponding to the diagram with an empty word, and action of $\omega \in \Sigma^*$ that takes it to $|\omega\rangle$. Element $|\emptyset\rangle$ is a cyclic vector in $A(+)$, so $A(+)=\mathbf{k}\Sigma^*|\emptyset\rangle$; see Figure 2.1.3, top row.

$A(-)$ is the dual vector space of $A(+)$, also carrying a distinguished vector $\langle\emptyset|$, with a right action of $\mathbf{k}\Sigma^*$; see Figure 2.1.3, bottom row.

The space $A(+)$ comes with the trace map

$$(5) \quad \text{tr} : A(+)\longrightarrow \mathbf{k}, \quad \text{tr}(|\omega\rangle) = \alpha_1(\omega).$$

Diagrammatically, we evaluate an oriented interval with the word ω written on it using α_1 . The trace map is nondegenerate: if $x \in A(+)$ with $x \neq 0$, then there exists $\omega \in \Sigma^*$ such that $\text{tr}(\omega x) \neq 0$.

The trace map is part of the perfect pairing

$$(6) \quad (,) : A(-) \otimes A(+)\longrightarrow \mathbf{k}, \quad \text{where } \langle\omega_1| \otimes |\omega_2\rangle \mapsto \alpha_1(\omega_1\omega_2),$$

given by concatenating words ω_1, ω_2 written on “half-intervals” into the word $\omega_1\omega_2$ on an interval and evaluating it, see Figure 2.1.4.

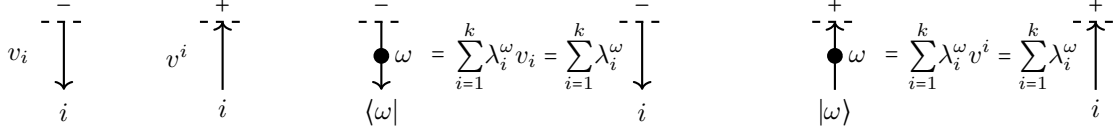

FIGURE 2.1.5. Left: basis vectors v_i and v^i . Middle and right: writing $\langle \omega | \in A(-)$ and $|\omega\rangle \in A(+)$ in these bases. In the special case $\omega = \emptyset$, the half-intervals are undecorated and the corresponding equations are shown in (9).

The pairing makes the left action of $\mathbf{k}\Sigma^*$ on $A(+)$ and the right action of $\mathbf{k}\Sigma^*$ on $A(-)$ adjoint:

$$(x\omega, y) = (x, \omega y) = \alpha_1(x\omega y), \quad x \in A(-), \quad y \in A(+), \quad \omega \in \Sigma^*.$$

Action of Σ^* on $A(+)$ induces a \mathbf{k} -algebra homomorphism

$$(7) \quad \mathbf{k}\Sigma^* \xrightarrow{\phi_\alpha} \text{End}_{\mathbf{k}}(A(+))$$

of the algebra of noncommutative polynomials into a finite-dimensional matrix algebra. Denote by

$$(8) \quad B_0 := \text{im}(\phi_\alpha)$$

the image of $\mathbf{k}\Sigma^*$ in $\text{End}_{\mathbf{k}}(A(+))$. It is a unital subalgebra of the matrix algebra. The algebra B_0 is the entire $\text{End}_{\mathbf{k}}(A(+))$ if and only if the representation $A(+)$ of $\mathbf{k}\Sigma^*$ is absolutely irreducible. Note that $A(+), A(-), B_0$ and the actions above depend only on α_1 , not on α_\circ .

Vice versa, suppose we are given a finite-dimensional representation V of $\mathbf{k}\Sigma^*$ with a cyclic vector v^0 and a nondegenerate trace $\text{tr} : V \rightarrow \mathbf{k}$. Here v^0 corresponds to the undecorated upward-oriented half-interval (half-interval with the empty word \emptyset on it). The trace is nondegenerate in the sense that for any $v \in V, v \neq 0$ there exists a word ω such that $\text{tr}(\omega v) \neq 0$.

To this data one assigns rational noncommutative series via the evaluation $\alpha_1(\omega) = \text{tr}(\omega v^0)$ for $\omega \in \Sigma^*$ so that $A(+)=V=\mathbf{k}\Sigma^*v^0$ and $A(-)=V^*$, where v^0 is a cyclic vector. This gives a bijection between isomorphism classes of rational evaluations (rational noncommutative power series in Σ) and nondegenerate triples (V, v^0, tr) with an action of Σ^* . The action of infinite-dimensional algebra $\mathbf{k}\Sigma^*$ on V factors through a faithful action of the finite-dimensional algebra $B_0 \subset \text{End}_{\mathbf{k}}(V)$.

Also, given a finite-dimensional algebra B_0 with a set of generators Σ , its faithful action on a finite-dimensional vector space V with a cyclic vector v^0 and a nondegenerate trace form on V , this recovers the noncommutative series α_1 via the above recipe, with $A(+)\cong V$.

There is a minimalist way to extend the above structure of $A(+)$ with an action of Σ^* , a cyclic vector and a trace to a symmetric monoidal category \mathcal{C}'_{α_1} , which turns out to be a TQFT with defects. In this construction evaluation of decorated circles is derived from that for decorated intervals. To define \mathcal{C}'_{α_1} , first enhance the graphical calculus for decorated half-intervals by picking a basis $\{v^1, \dots, v^k\}$ of $A(+)$ and the dual basis $\{v_1, \dots, v_k\}$ of $A(-)$, with $k = \dim A(-) = \dim A(+)$. Denote vectors v^i, v_i by placing the label i at the end of the suitably oriented half-interval, see Figure 2.1.5, left. A half-interval decorated by $\omega \in \Sigma^*$ can be written as a linear combination of the basis vectors, by writing $\langle \omega |$ and $|\omega\rangle$ in these bases, see Figure 2.1.5, middle and right. In the special case of undecorated half-intervals, $\omega = \emptyset$, and

$$(9) \quad \langle \emptyset | = \sum_{i=1}^k \lambda_i^\emptyset v_i, \quad |\emptyset\rangle = \sum_{i=1}^k \lambda_i^\emptyset v^i, \quad \lambda_i^\emptyset \in \mathbf{k}.$$

There is then the surgery formula (the dual basis relation), shown in Figure 2.1.6 left, for cutting any half-interval in the middle, where any floating intervals that appear are evaluated via α_1 . This

The figure shows three equations. The first is a surgery formula: a dashed arc with endpoints labeled '+' and '-' is equal to a sum from $i=1$ to k of two diagrams. The first diagram is a vertical line with a '+' sign above it and a '-' sign below it, with a label i at the bottom. The second diagram is a vertical line with a '-' sign above it and a '+' sign below it, with a label i at the bottom. The second equation is $i \longleftarrow j = \delta_{i,j}$. The third equation is $i \xleftarrow{\omega} j = v_i(\omega v^j) = v^j(v_i \omega)$, where a dot is placed on the arrow between i and j .

FIGURE 2.1.6. Left: surgery formula $\text{id} = \sum_{i=1}^k v^i \otimes v_i$ in the symmetric monoidal category \mathcal{C}'_{α_1} . Center: floating i, j -interval evaluates to $(v_i, v^j) = \delta_{i,j}$. Right: a more general floating i, j -interval with the ω dot and its evaluation.

The figure shows an equation: a circle with a dot at the top labeled ω is equal to a sum from $i=1$ to k of a diagram. The diagram in the sum is a circle with a dot at the top labeled ω and two endpoints at the bottom labeled i and i . The right side of the equation is $\text{tr}_{A(+)}(\omega) = \text{tr}_{A(-)}(\omega)$.

FIGURE 2.1.7. An ω -decorated circle evaluates to the trace of operator ω on $A(+)$ and on $A(-)$.

formula also tells us that, for consistency, a circle carrying word ω should be evaluated to the trace of ω acting on $A(+)$ (equivalently, on $A(-)$),

$$(10) \quad \alpha_o(\omega) := \text{tr}_{A(+)}(\omega) = \text{tr}_{A(-)}(\omega),$$

see Figure 2.1.7. Choose an interval on the circle, replace it by the sum of i, i -colored half-intervals, $1 \leq i \leq k$, and evaluate via α_1 . We denote the circular series associated to a rational series α_1 in this way by α_1^{tr} , so that

$$(11) \quad \alpha_1^{\text{tr}}(\omega) = \alpha_o(\omega) = \text{tr}_{A(+)}(\omega).$$

Necessarily, α_1^{tr} is a rational circular series in the same set Σ of variables as α_1 . The coefficient of the empty word \emptyset in this series equals $\dim A(+)$.

To a rational series α_1 we assign a symmetric monoidal category \mathcal{C}'_{α_1} whose objects are finite sign sequences ε . Morphisms from ε to ε' are \mathbf{k} -linear combinations of diagrams of decorated half-intervals and outer arcs, see Figure 2.1.8, left diagram. An arc is *outer* if it has both endpoints on the boundary of the diagram (*i.e.*, among the signed points of ε and ε'). A half-interval has one floating (inner) endpoint and one endpoint on the boundary of the diagram (outer endpoint). Each floating endpoint is either decorated by $i \in \{1, \dots, k\}$ or undecorated. Some evaluation rules for floating cobordisms are given in Figures 2.1.4, 2.1.6, 2.1.7.

To summarize these rules, we observe that in the category \mathcal{C}'_{α_1} arcs and half-intervals can be decorated by words $\omega \in \Sigma^*$. Half-intervals can be decorated by both a label i at the floating (inner) endpoint and words ω . Floating intervals and circles (these appear upon composition of morphisms) are evaluated using the following rules (see rules in Figure 2.1.5 on the right, Figures 2.1.6 and 2.1.7):

- A floating interval with unlabelled endpoints and decorated by word ω evaluates to $\alpha_1(\omega)$. Alternatively, an interval with one or two unlabelled endpoints is evaluated by first converting unlabelled endpoints into a linear combination of labelled endpoints, see equation (9), or, more generally via Figure 2.1.5 by writing $\langle \omega \rangle$ as a linear combination of v_1, \dots, v_k and $|\omega$ as a linear combination of v^1, \dots, v^k .
- An interval with labelled endpoints i, j and decorated by a word ω evaluates to $v^i(v_j \omega)$, see Figure 2.1.6.

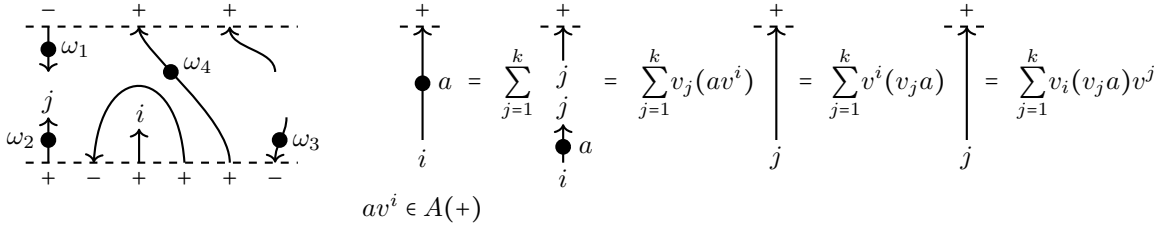

FIGURE 2.1.8. Left: A diagram for a morphism in \mathcal{C}_{α_1} . Right: simplifying an a -decorated half-interval, $a \in \Sigma$ (this works, more generally, for any word ω in place of a letter a). Here $v_j(av^i) = (v_j, av^i) = (v_j a, v^i) = v^i(v_j a)$.

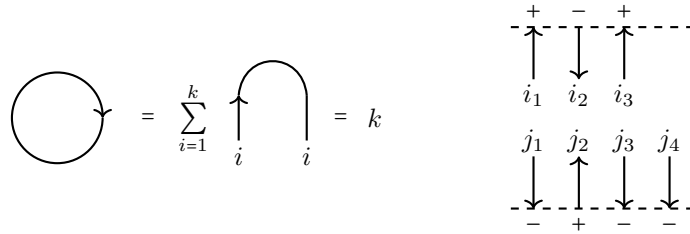

FIGURE 2.1.9. Left: an undecorated circle evaluates to $k = \dim A(+)$ in \mathcal{C}'_{α_1} . Right: a basis element of $\text{Hom}_{\mathcal{C}'_{\alpha_1}}(-+--,+ - +)$, $i_1, \dots, j_4 \in \{1, \dots, k\}$.

- A circle decorated by ω evaluates to the trace of ω on $A(+)$ or $A(-)$, see Figure 2.1.7.

With these evaluation rules at hand, we apply the universal construction to build the category \mathcal{C}'_{α_1} . The evaluation rule for decorated circles makes decomposition of the identity in Figure 2.1.6 hold. Consequently, any outer arc reduces to a linear combination of half-intervals, with endpoint decorated by $i \in \{1, \dots, k\}$. Half-intervals with dots are further reduced to linear combinations of endpoint-decorated dotless half-intervals.

Composing an undecorated outer arc with a possibly decorated half-interval results in a half-interval with the same decoration. Composing two half-intervals results in a floating interval, which is then evaluated via α_1 . An undecorated outer arc can be written as a linear combination of pairs of half-intervals via Figure 2.1.6 relations. In particular, an undecorated circle evaluates to $k = \dim A(+)$, see Figure 2.1.9 left.

The result is a symmetric monoidal \mathbf{k} -linear category \mathcal{C}'_{α_1} . It has easily describable hom spaces. A basis of $\text{Hom}(\varepsilon, \varepsilon')$ is given by drawing the unique diagram of half-intervals ending at all signs of ε and ε' and adding all possible labels $i \in \{1, \dots, k\}$ to each inner endpoint of the diagram, see an example in Figure 2.1.9 on the right. In particular,

$$(12) \quad \dim_{\mathbf{k}}(\text{Hom}(\varepsilon, \varepsilon')) = k^{|\varepsilon|+|\varepsilon'|},$$

where $|\varepsilon|$ is the length of the sequence ε . This category is a one-dimensional TQFT with defects, in the sense that the state space of the concatenation of sequences is the tensor product of state spaces for individual sequences:

$$(13) \quad A(\varepsilon\varepsilon') \cong A(\varepsilon) \otimes A(\varepsilon'), \quad A(\varepsilon) \cong A(\varepsilon_1) \otimes A(\varepsilon_2) \otimes \dots \otimes A(\varepsilon_n),$$

where $\varepsilon = \varepsilon_1\varepsilon_2\dots\varepsilon_n$, $\varepsilon_i \in \{+, -\}$.

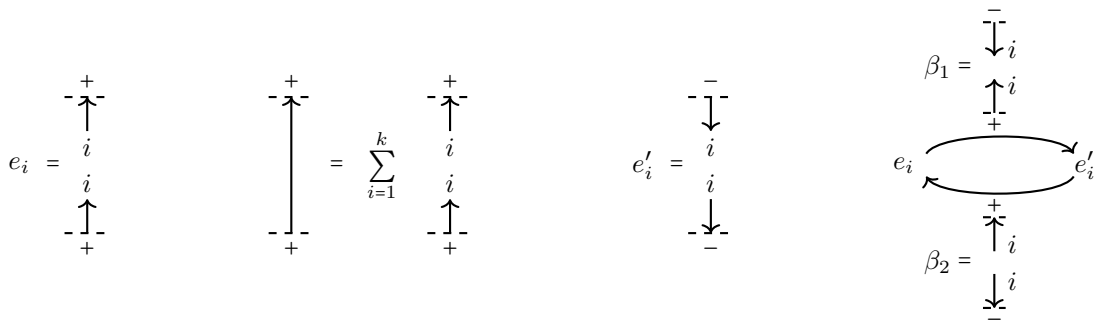

FIGURE 2.1.10. Left to right: idempotent $e_i \in \text{End}_{\mathcal{C}_\alpha}(+)$, idempotent decomposition of id_+ , idempotent $e'_i \in \text{End}_{\mathcal{C}_\alpha}(-)$, equivalence of idempotents e_i, e'_i (morphisms β_1, β_2 are written at top, respectively, bottom arrows).

We emphasize that the category \mathcal{C}'_{α_1} depends only on the interval evaluation α_1 . Evaluation of decorated circles is computed as the trace of the action of Σ^* on the state space $A(+)$ associated to α_1 .

Denote by $\text{Kar}(\mathcal{C}'_{\alpha_1})$ the Karoubi envelope of \mathcal{C}'_{α_1} given by allowing finite direct sums of objects of \mathcal{C}'_{α_1} and then passing to the idempotent closure. Category $\text{Kar}(\mathcal{C}'_{\alpha_1})$ is an additive symmetric monoidal \mathbf{k} -linear category.

Consider idempotents $e_i \in \text{End}_{\mathcal{C}'_{\alpha_1}}(+)$ given by a pair of i -labelled half-intervals, $i = 1, \dots, k$, see Figure 2.1.10 on the left. These are mutually-orthogonal idempotents giving a decomposition of the identity id_+ endomorphism

$$(14) \quad \text{id}_+ = e_1 + e_2 + \dots + e_k, \quad e_i e_j = \delta_{i,j} e_i,$$

see Figure 2.1.10 on the right. There is a similar decomposition of the identity for the dual object $-$ via idempotents e'_1, \dots, e'_k , see Figure 2.1.10.

Note that the dual simple object $(-, e'_i)$, see Figure 2.1.10 in the middle, is isomorphic to $(+, e_i)$, via the pair of morphisms shown in that figure on the right. Recall that idempotent endomorphisms e, e' are *equivalent* (and corresponding objects of the Karoubi envelope are isomorphic) if there exist two-way composable morphisms β_1, β_2 such that $e = \beta_2 \beta_1$ and $e' = \beta_1 \beta_2$. For idempotents e_i, e'_i these two morphisms are written next to the arrows between these idempotents in Figure 2.1.10 on the right.

Furthermore, objects $(+, e_i)$ and $(+, e_j)$ are isomorphic, for $i \neq j$, $1 \leq i, j \leq k$, via the morphisms shown in Figure 2.1.11.

The endomorphism rings of objects $(+, e_i)$ and $(-, e'_i)$ are the ground field \mathbf{k} , and these $2k$ objects, over $i = 1, \dots, k$, are pairwise isomorphic. The generating object $+$ is the sum of k of them. This quickly leads to the following result that $\text{Kar}(\mathcal{C}'_{\alpha_1})$ generated by $(+, e_i), (-, e'_i)$ over $i = 1, \dots, k$ is equivalent to the tensor category $\mathbf{k}\text{-vect}$ of finite-dimensional \mathbf{k} -vector spaces.

PROPOSITION 2.1. The Karoubi envelope of \mathcal{C}'_{α_1} is equivalent, as an additive symmetric monoidal category, to the category of finite-dimensional \mathbf{k} -vector spaces:

$$(15) \quad \text{Kar}(\mathcal{C}'_{\alpha_1}) \cong \mathbf{k}\text{-vect}.$$

PROOF. The equivalence is given by the functor that takes each $(+, e_i)$ to a one-dimensional vector space V_i , each $(-, e'_i)$ to its dual V_i^* and takes $+$ to the k -dimensional space $V = V_1 \oplus \dots \oplus V_k$. \square

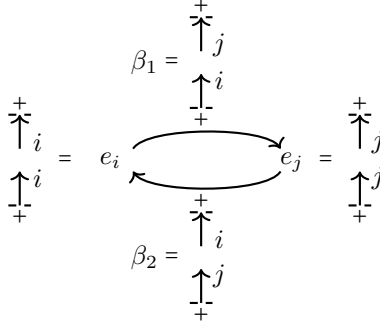

FIGURE 2.1.11. Equivalence of idempotents e_i and e_j and isomorphism of objects $(+, e_i), (+, e_j)$, with morphisms β_1, β_2 written next to top and bottom arrows, respectively.

The proposition tells us that $\text{Kar}(\mathcal{C}'_{\alpha_1})$ has a very simple structure. The complexity of noncommutative rational power series α_1 is hidden in the action of Σ^* on $A(+) \cong V$. More generally, given a TQFT taking values in \mathbf{k} -vector spaces, the target category of that TQFT is $\mathbf{k}\text{-vect}$ or some variation of it, so a version of the above proposition holds as well.

The interesting question here is to *explicitly* compute the circular evaluation α_1^{tr} given a rational interval evaluation α_1 or, equivalently, rational noncommutative power series α_1 . We obtain α_1^{tr} by considering $A(+)$ and the action of $\mathbf{k}\Sigma^*$ on it, so that the coefficient at ω of the noncommutative circular series of α_1^{tr} is the trace of ω on $A(+)$, see (10), and the generating function of the circular evaluation is

$$(16) \quad Z_{\alpha_1}^{\text{tr}} := \sum_{\omega \in \Sigma^*} \text{tr}_{A(+)}(\omega) \omega.$$

For more than one variable, Z_{α_1} is a noncommutative power series in elements of Σ . Circular evaluation α_1^{tr} gives a canonical extension of α_1 to a TQFT with defects. This extension is unique, in appropriate sense. It is straightforward to write down in the 1-variable case, see Section 2.2.

Given a $\mathbf{k}[\Sigma^*]$ -module M , finite-dimensional over \mathbf{k} , its characteristic function $\chi(M)$, defined in [RRV99], is given by

$$(17) \quad \chi(M) := \sum_{\omega \in \Sigma^*} \text{tr}_M(\omega) \omega.$$

Expression (16) is the characteristic function of $\mathbf{k}\Sigma^*$ -module $A(+)$.

2.2. One-variable case and comparison to two-dimensional theory. Consider the above construction in the case of a single variable, $\Sigma = \{a\}$. Then there is only one type of a dot, necessarily labelled a , and n dots on an interval can be denoted by a single dot labelled n . The interval evaluation is encoded by a one-variable power series

$$(18) \quad Z_1(T) := \sum_{n \geq 0} \alpha_{1,n} T^n.$$

A well-known theorem, see [Kho20a, Proposition 2.1] and [Kho20b, Theorem 2.3], says that $Z_1(T)$ is a rational series ($A(+)$ is finite-dimensional) if and only if it is a rational function,

$$(19) \quad Z_1(T) = \frac{P(T)}{Q(T)},$$

for some polynomials $P(T), Q(T)$, with $Q(0) \neq 0$.

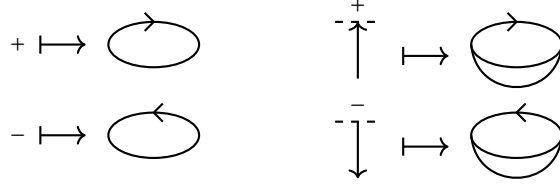

FIGURE 2.2.1. Going from a 1D to a 2D topological theory. Signed points become oriented circles and half-intervals turn into oriented disks.

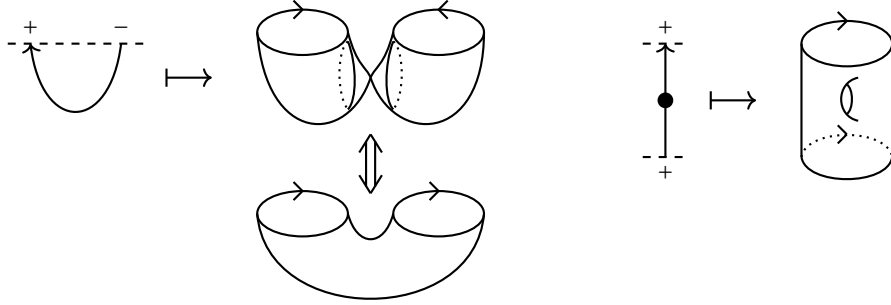

FIGURE 2.2.2. Left: an arc is converted into an annulus. Due to the opposite orientations at the arc's ends, the standard embedding of two oppositely oriented circles into \mathbb{R}^2 extends only to an immersion, not an embedding, of an annulus into the lower half-space. This is not an issue for us due to considering 2D cobordisms, not embedded 2D cobordisms. Right: An arc with a dot is converted to a torus with two punctures.

We would like to explicitly compute α_1^{tr} in this case, given the generating function above (equivalently, given interval evaluation α_1).

The state space $A(+)$ can be identified with the state space $A(1)$ in [Kho20b, Section 2] of a circle in the 2D topological theory [Kho20b] associated to the same generating function $Z_1(T)$. In that 2D topological theory, closed connected oriented surface of genus n evaluates to $\alpha_{1,n} \in \mathbf{k}$, while in our 1D defect topological theory an interval with n dots evaluates to $\alpha_{1,n}$, see the correspondence in Figure 2.2.3 right.

The reason is that there is a functor from the category of (oriented) dotted one-cobordisms to the category of (oriented) two-cobordisms. This functor sends $+$ (and $-$) to an oriented circle. It sends a half-interval to a disk, a dotless arc to an annulus, and an outer arc with a single dot to a two-holed torus, see Figures 2.2.1 and 2.2.2.

There is a bijection between homeomorphism classes of decorated connected dotted 1-manifolds with boundary $+$ and connected oriented surfaces with boundary \mathbb{S}^1 , see Figure 2.2.3 left, where n -dotted half-interval corresponds to a genus n surface with one boundary circle.

This leads to a natural isomorphism of state spaces

$$(20) \quad A(+) \cong A(\mathbb{S}^1)$$

of the 1D topological theory with defects with a rational generating function in (18) for interval evaluation and the 2D topological theory with the same generating function. Notice also a canonical isomorphism $A(+)$ \cong $A(-)$ sending upward-oriented half-interval with n dots to the downward-oriented

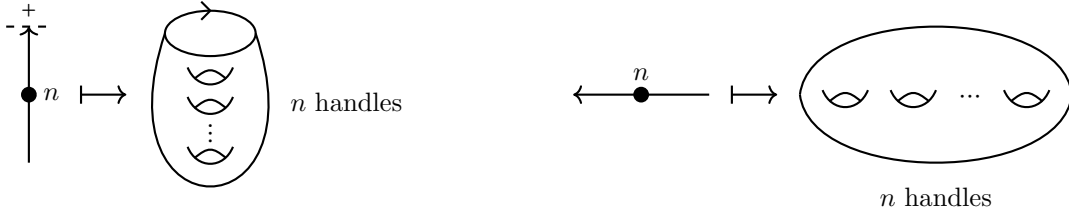

FIGURE 2.2.3. Half-interval with n dots becomes a genus n surface with one boundary circle. An n -dotted interval is transformed into a closed genus n surface.

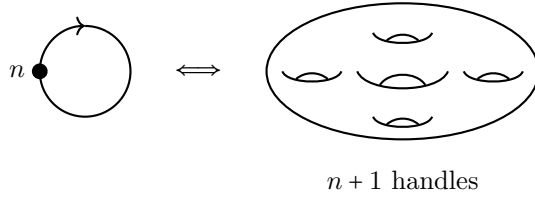

FIGURE 2.2.4. A circle with n dots is mapped to a genus $(n + 1)$ surface.

half-interval with n dots, $n \geq 0$ (this isomorphism exists when $|\Sigma| = 1$ and otherwise requires α_l to be invariant under word reversal).

One can look to compare the state spaces for these two theories (in two different dimensions) beyond a single point and a circle. In the above thickening construction, a circle with n dots corresponds to a genus $n + 1$ closed surface, see Figure 2.2.4, so for the best match we pick the circular series in the 1D theory to be

$$(21) \quad Z_{\alpha_o}(T) = TZ_{\alpha_l}(T), \quad \alpha_{o,n+1} = \alpha_{l,n}, \quad n \geq 0.$$

Then there is a natural \mathbf{k} -linear map

$$(22) \quad A(+ -) \xrightarrow{\psi_{+-}} A(2)$$

from the state space of $+ -$ in the 1D theory to that of two circles in the 2D theory, with the generating functions (18), (21) for the 1D theory and (18) for the 2D theory, given by the above thickening of dotted 1D cobordisms to 2D cobordisms. This map respects evaluations and is, in fact, an isomorphism, so that $A(+ -) \cong A(2)$ in the two theories.

More generally, for any sign sequence ε there is natural map

$$(23) \quad A(\varepsilon) \xrightarrow{\psi_\varepsilon} A(|\varepsilon|)$$

extending to a monoidal functor ψ between corresponding categories for 1D and 2D evaluations. Map ψ_ε is not surjective, for instance, for $|\varepsilon| = 3$ and the constant evaluation function $Z_1(T) = \beta \in \mathbf{k}$, $\beta \neq 1$. Element of $A(3)$ which is the 3-holed sphere is not in the image of ψ_ε , for any length 3 sign sequence ε . Also, ψ_{++} is not, in general, surjective, with the annulus element of $A(2)$ not in its image.

We now come back to the problem of computing α_l^{tr} given α_l , for one-element $\Sigma = \{a\}$. Let us first examine two special cases.

- The generating function $Z_1(T) = \sum_{i=0}^k a_i T^i$ is a polynomial of degree k . Then $\dim A(+) = k + 1$ and the operator of multiplication by a is nilpotent. Consequently, circular evaluation α_o is

the constant function, taking value 0 on any nonzero power of a , with the generating function $Z_o(T) = k + 1$.

- The generating function is a reduced fraction of the form

$$(24) \quad Z_l(T) = \frac{f(T)}{(\lambda - T)^k}, \quad k \geq 1, \quad \lambda \neq 0, \quad \deg(f(T)) < k.$$

Then $A(+)$ is a cyclic $\mathbf{k}[a]$ -module isomorphic to $\mathbf{k}[a]/((\lambda a - 1)^k)$, where we quotient by the reciprocal polynomial of $(\lambda - a)^k$, see [Kho20a]. Note that trace of a^m on this quotient space does not depend on $f(T)$ above, subject to the conditions in (24). Substituting $u = \lambda a - 1$, so that $a = \frac{1}{\lambda}(u + 1)$, the trace of a^m on $\mathbf{k}[u]/(u^k)$ is given by

$$(25) \quad \mathrm{tr}(a^m) = \lambda^{-m} k.$$

A rational function, over an algebraically closed field \mathbf{k} , has a unique partial fraction decomposition

$$(26) \quad Z_l(T) = \frac{P(T)}{Q(T)} = \sum_{i=1}^r \frac{f_i(T)}{(\lambda_i - T)^{k_i}} + f_0(T), \quad \lambda_i \neq 0, \quad \deg(f_i(T)) < k_i, \quad i = 1, \dots, r.$$

Then the trace circular series associated with this generating function is

$$(27) \quad \begin{aligned} Z_{\alpha_1}^{\mathrm{tr}}(T) &= \deg(f_0) + 1 + \sum_{m \geq 0} \left(\sum_{i=1}^r k_i \lambda_i^{-m} T^m \right) \\ &= \deg(f_0) + 1 + \sum_{i=1}^r k_i \sum_{m \geq 0} (\lambda_i^{-1} T)^m \\ &= \deg(f_0) + 1 + \sum_{i=1}^r \frac{k_i}{1 - \lambda_i^{-1} T} \end{aligned}$$

If $Z_l(T)$ in (26) is a proper fraction, that is, $f_0(T) = 0$, we set $\deg(f_0) + 1 = 0$ in (27). Note that the characteristic polynomial for the trace series is a divisor of the characteristic polynomial for the original series.

If eigenvalues of a on $A(+)$ are μ_1, \dots, μ_n , listed with multiplicities, then

$$(28) \quad Z_{\alpha_1}^{\mathrm{tr}}(T) = \sum_{i=1}^n \frac{1}{1 - \mu_i T},$$

which is [RRV99, Example 2.6].

It is an interesting problem to explicitly write down noncommutative trace series $Z_{\alpha_1}^{\mathrm{tr}}(\Sigma)$ associated with an arbitrary rational noncommutative series $Z_{\alpha_1}(\Sigma)$ when the number of variables $|\Sigma|$ is greater than one.

2.3. A topological theory when a circular series is added. To build a more general monoidal category, we additionally pick a circular rational series α_o , see [Kho20a, IK22]. Here $\alpha = (\alpha_l, \alpha_o)$ is a pair: a rational noncommutative series α_l and a circular rational noncommutative series α_o . We build category \mathcal{C}_α from it as in Section 2.1 by evaluating floating decorated intervals and circles via α_l and α_o correspondingly and applying the universal construction to derive further relations on linear combinations of cobordisms with outer boundary, see also [Kho20a, Kho20b, KS20]. As before, objects of \mathcal{C}_α are finite sign sequences ε .

In the category \mathcal{C}_α , state spaces $A(+), A(-)$ depend only on α_l and they are spanned by elements $|\omega\rangle, \omega \in \Sigma^*$, respectively $\langle \omega|, \omega \in \Sigma^*$. State space $A(+)$ is spanned by diagrams of two types:

- (1) pairs of decorated half-intervals with opposite orientations,
- (2) decorated outer arcs,

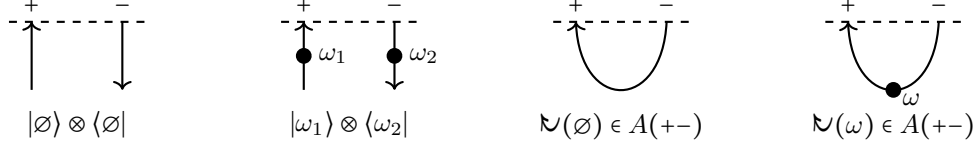

FIGURE 2.3.1. A spanning set for the module $A(+−)$. First and third figure (from the left) are a generator $|\emptyset\rangle \otimes \langle\emptyset|$ of $A(+)$ and $A(-)$ and the unit element 1 of $A(+−)$, respectively.

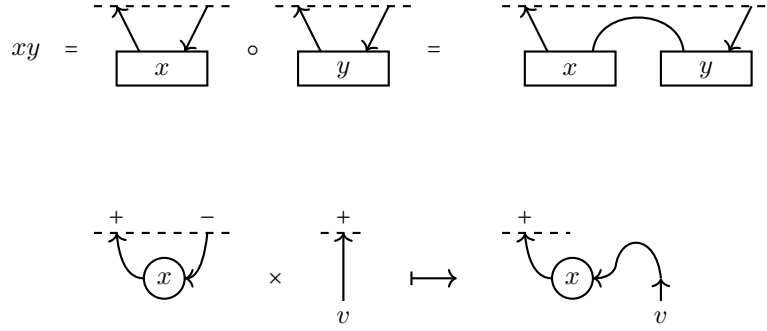

FIGURE 2.3.2. Top: multiplication in $A(+−)$. Bottom: action of $A(+−)$ on $A(+)$.

see Figure 2.3.1.

$A(+−)$ is naturally a unital associative finite-dimensional algebra, with the unit element given by an outer arc with the trivial decoration and with the multiplication shown in Figure 2.3.2. Algebra $A(+−)$ acts on $A(+)$ on the left, see Figure 2.3.2.

Denote by \mathcal{I} the subspace of $A(+−)$ spanned by diagrams of type (1), see Figure 2.3.1 second from left picture. This subspace is a two-sided ideal of $A(+−)$ and a unital \mathbf{k} -algebra with the unit element $1' = \sum_{i=1}^k v^i \otimes v_i$ shown in Figure 2.1.6 on the right hand side of the equality. Note that the equality $1' = 1$ fails unless $\alpha_o = \alpha_1^{\text{tr}}$. In general, the right hand side diagram is the unit element of $A(+−)$ and the left hand side is the idempotent $1'$.

There is a natural algebra isomorphism

$$(29) \quad \mathcal{I} \cong A(+)\otimes A(-) \cong \text{End}(A(+))$$

coming from the faithful action of \mathcal{I} on $A(+)$, given by restricting the action from that of $A(+−)$.

The kernel \mathcal{K} of the action of $A(+−)$ on $A(+)$ is a two-sided ideal of $A(+−)$, complementary to \mathcal{I} , giving a direct product decomposition

$$(30) \quad A(+−) \cong \mathcal{I} \times \mathcal{K}.$$

In this decomposition both terms on the right are unital \mathbf{k} -algebras, with the unit element of \mathcal{K} given by the image of $1 \in A(+−)$ under the projection, that is, by

$$(31) \quad 1_{\mathcal{K}} := 1 - 1' = 1 - \sum_{i=1}^k v^i \otimes v_i.$$

In particular, $1_{\mathcal{K}}$ generates \mathcal{K} as an $A(+−)$ -bimodule.

Denote by U the subspace of $A(+−)$ spanned by diagrams of type (2), that is, by decorated arcs connecting $+$ and $-$ boundary points, see the picture on the right in Figure 2.3.1. Recall that we denote

by $\mathfrak{N}(\omega)$ the arc decorated by ω , see Figure 2.3.1 on the right. U is a unital subalgebra of $A(+)$ and there are algebra inclusions

$$(32) \quad U \subset A(+) \supset A(+) \otimes A(-) \cong \mathcal{I}.$$

Subalgebra U surjects onto \mathcal{K} upon projection to the second term in the direct product (30), and there is a short exact sequence

$$(33) \quad 0 \longrightarrow U \cap \mathcal{I} \longrightarrow U \longrightarrow \mathcal{K} \longrightarrow 0.$$

The first term

$$(34) \quad U' := U \cap \mathcal{I}$$

is a two-sided ideal of U . Elements in U' are linear combinations of decorated arcs (elements of U) that decompose in $A(+)$ into linear combinations of pairs of half-intervals. These decompositions are unique as elements of $A(+) \otimes A(-) \cong \mathcal{I} \subset A(+)$.

This data carries a triple of discrete invariants:

$$(35) \quad (\dim A(+), \dim(U'), \dim \mathcal{K}),$$

which are three non-negative integers. Note that $\dim A(-) = \dim A(+)$, $\dim \mathcal{I} = (\dim A(-))^2$ and $\dim(U') \leq (\dim A(+))^2$.

REMARK 2.2. The natural inclusion $A(+) \otimes A(-) \subset A(+)$ is an isomorphism if and only if $\mathcal{K} = 0$. This is exactly the case when there is a decomposition of the identity, that is, when the undecorated arc $1 \in A(+)$ lies in $\mathcal{I} \cong A(+) \otimes A(-)$, that is, when 1 is *decomposable* (also when $1 = 1'$, see earlier). In this case $A(+)$ is isomorphic to $A(+) \otimes A(-)$ and, more generally, $A(\varepsilon\varepsilon') \cong A(\varepsilon) \otimes A(\varepsilon')$ for any sign sequences $\varepsilon, \varepsilon'$.

Equivalently, the category \mathcal{C}_α gives a TQFT rather than just a topological theory (with defects) if and only if $\mathcal{K} = 0$. This is possible for a unique rational circular series $\alpha_\circ = \alpha_1^{\text{tr}}$ associated with α_1 and with the identity decomposition determined by α_1 , see formula (11). Circular evaluation α_\circ is then the trace of action of words on $A(+)$, see formula (16), with $\alpha_\circ(\omega) = \alpha_1^{\text{tr}}(\omega) = \text{tr}_{A(+)}(\omega)$ for $\omega \in \Sigma^*$. The resulting theory $\alpha = (\alpha_1, \alpha_\circ)$ is a TQFT.

The Boolean version of the identity decomposition (which requires $A(+)$ to be a distributive semilattice) is considered in [IK22].

EXAMPLE 2.3. Consider the case when Σ is empty. Then there are only two closed connected cobordisms, undecorated interval and circle. Suppose they evaluate to 1 and $\lambda \neq 1$, respectively, see Figure 2.3.3, top middle. Then $A(+)$ and $A(-)$ are one-dimensional, with basis vectors v and v^* , respectively, see Figure 2.3.3, top right. The space $A(+)$ is two-dimensional, with the basis shown in Figure 2.3.3, top left. The subalgebra \mathcal{K} is one-dimensional, $\mathcal{K} = \mathbf{k}w$, with a basis element w shown in Figures 2.3.3, bottom left, and 2.3.4. The algebra U is one-dimensional, with the unit element (an arc) as the basis element, see Figure 2.3.4.

In this example $U \cap \mathcal{I} = U \cap \mathcal{K} = 0$, and projection of U onto \mathcal{K} along \mathcal{I} is an algebra isomorphism, See Figure 2.3.4. The triple of parameters is $(1, 0, 1)$. There is algebra decomposition $A(+)$ is isomorphic to $\mathcal{I} \times \mathcal{K} = \mathbf{k}(1-w) \times \mathbf{k}w$.

When $\Sigma = \{a\}$ is a one-element set, decoration of an interval or a circle is determined by the number $n \geq 0$ of dots on it. If an n -dotted interval evaluates to $\alpha_{1,n}$ and n -dotted circle evaluates to $\alpha_{\circ,n}$, the evaluation is encoded by a pair of one-variable power series in a variable T :

$$(36) \quad Z_1(T) := \sum_{n \geq 0} \alpha_{1,n} T^n, \quad Z_\circ(T) := \sum_{n \geq 0} \alpha_{\circ,n} T^n,$$

see Figure 2.3.5. A simple modification of a result from [Kho20a] shows the following.

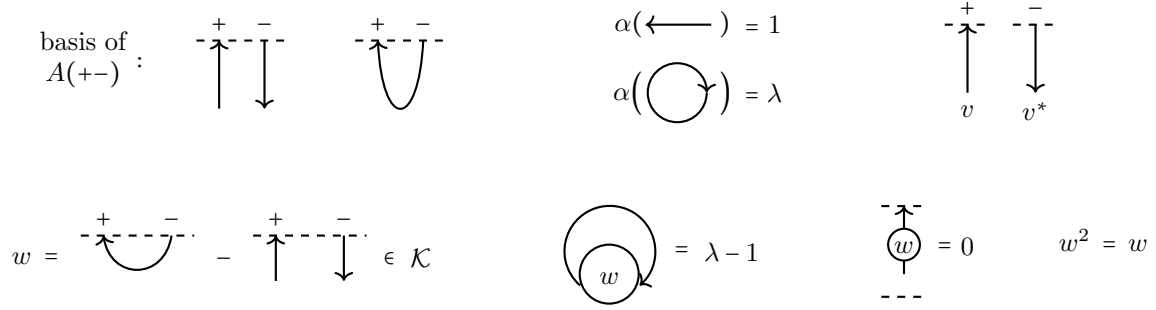

FIGURE 2.3.3. Example 2.3. Top, left to right: a basis of $A(+ -)$, evaluation α , vectors v and v^* . Bottom, left to right: spanning vector w of \mathcal{K} and its properties.

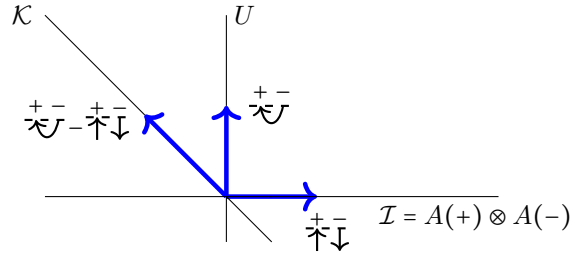

FIGURE 2.3.4. Example 2.3. One-dimensional subspaces \mathcal{I} , U and \mathcal{K} in $A(+ -)$, with $\dim A(+ -) = 2$.



FIGURE 2.3.5. Connected closed cobordisms when Σ has cardinality one and their evaluations $\alpha_{l,n}$ and $\alpha_{o,n}$.

PROPOSITION 2.4. A one-variable evaluation $\alpha = (\alpha_l, \alpha_o)$ is rational (the hom spaces in the category \mathcal{C}_α are finite-dimensional) if and only if both $Z_l(T)$ and $Z_o(T)$ are rational functions in T , i.e.,

$$(37) \quad Z_l(T) = \frac{P_l(T)}{Q_l(T)}, \quad Z_o(T) = \frac{P_o(T)}{Q_o(T)}.$$

It is also easy to see that α is a rational evaluation if and only if the state spaces $A(+)$, $A(+ -)$ are finite-dimensional.

EXAMPLE 2.5. Let us construct an example with parameters $(1, 1, 1)$ as in (35). Since $\dim(U) = 2$, take $\Sigma = \{a\}$. Since $\dim A(+) = 1$, the dot acts by some scalar s on the endpoint, see Figure 2.3.6. Pick evaluation of undecorated interval and circle to be 1 and $\lambda \neq 1$, respectively, and introduce parameter t for the skein relation in Figure 2.3.6 top right.

Attaching half-interval at the top right endpoint in each diagram of the relation implies $s = t + 1$. Closing up the skein relation by an arc with n dots gives an inductive formula for a circle with n dots.

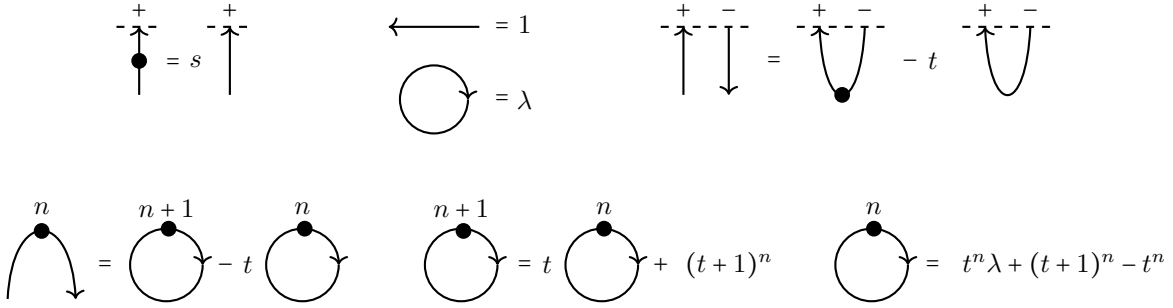
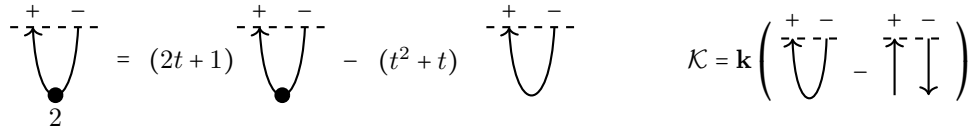
FIGURE 2.3.6. Evaluation (38) and skein relations for that topological theory; $s = t + 1$.FIGURE 2.3.7. Evaluation (38). Left: we have the relation $a^2 = (2t + 1)a - (t^2 + t)$, which can also be written as $(a - t)(a - t - 1) = 0$. Right: \mathcal{K} is a one-dimensional space.

Generating functions (37) are

$$(38) \quad Z_1(T) = \frac{1}{1 - (t+1)T}, \quad Z_o(T) = \frac{\lambda - 1}{1 - tT} + \frac{1}{1 - (t+1)T}.$$

Inductive skein relation to reduce the number of dots is shown in Figure 2.3.7 on the left. Figure 2.3.7 on the right shows the unit element and the basis vector of algebra $\mathcal{K} \cong \mathbf{k}$, equal to $1 - 1'$.

We get a decomposition $A(+ -) \cong \mathcal{I} \times \mathcal{K} \cong \mathbf{k} \times \mathbf{k}$ of $A(+ -)$ into the product of two copies of the ground field.

EXAMPLE 2.6. Let us give an example with $\dim A(+) = 2$, $\dim(U') = 1$, $\dim(\mathcal{K}) = 1$ and $U' = I \cap U$, a nilpotent ideal in U . Let $\Sigma = \{a\}$ and make a nilpotent, $a^2 = 0 \in U$, see Figure 2.3.8. Then $\{\langle \emptyset \rangle, \langle a \rangle\}$ is a basis of $A(+)$ and for the bilinear pairing $A(+ -) \times A(-) \rightarrow \mathbf{k}$ we can choose the one in Figure 2.3.8, with a parameter $\mu \in \mathbf{k}$. Additionally, choose a relation reducing dot on an arc to a pair of dotted half-intervals. Evaluation α is then shown in Figure 2.3.8 second and bottom rows.

Space $A(+ -)$ is spanned by the six vectors, with the pairing given in Figure 2.3.10 (rows 4 and 6 are equal and columns 4 and 6 are equal). Dropping the last row and column gives us a basis of $A(+ -)$ of cardinality 5. See Figure 2.3.9.

The structure of the short exact sequence (33) for this example is shown in Figure 2.3.11 left. The generating functions are

$$(39) \quad Z_1(T) = \mu + T, \quad Z_o(T) = \lambda,$$

see also Figure 2.3.8.

2.4. Karoubi envelope decomposition for arbitrary rational α . We now go back to the case of arbitrary Σ of finite cardinality and a rational pair $\alpha = (\alpha_1, \alpha_o)$. Recall the direct product decomposition of $A(+ -)$ into \mathcal{K} and the matrix ring \mathcal{I} , and the formula for the unit element of \mathcal{K} :

$$(40) \quad A(+ -) \cong \mathcal{I} \times \mathcal{K}, \quad \mathcal{I} \cong \text{End}_{\mathbf{k}}(A(+)), \quad 1_{\mathcal{K}} = 1 - \sum_{i=1}^k v^i \otimes v_i.$$

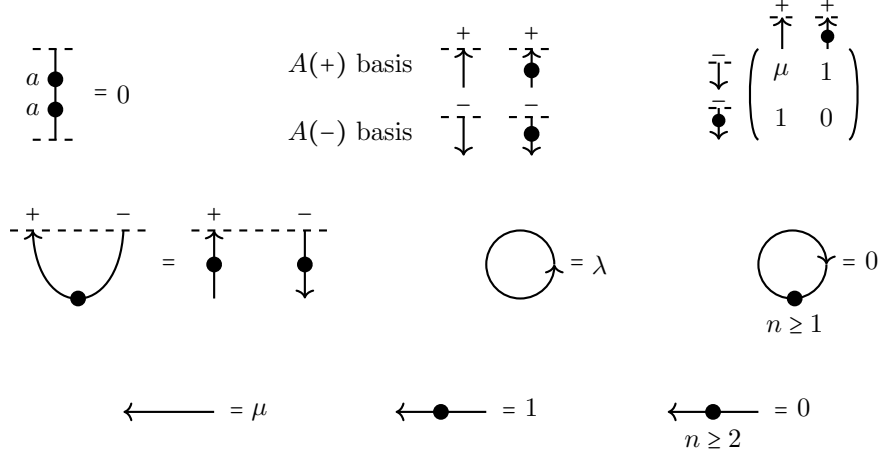

FIGURE 2.3.8. Example 2.6. Evaluation for the generating functions in (39), some relations and bases. Top row: $a^2 = 0$, bases of $A(+)$ and $A(-)$, the matrix of bilinear pairing. Second row: simplification of a dotted arc and circle evaluations. Third row: interval evaluations.

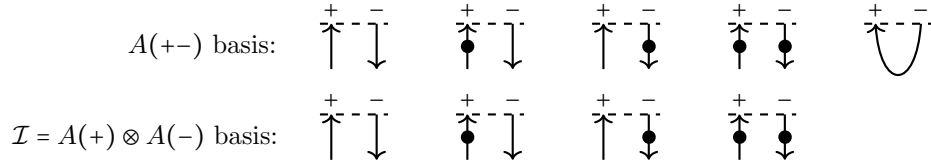

FIGURE 2.3.9. Example 2.6. Bases of $A(+)$ and $A(-)$ for the evaluation (39). In the decomposition $A(+)$ $\simeq \mathcal{K} \times \mathcal{I}$ factor \mathcal{K} is one-dimensional, spanned by the vector in Figure 2.3.12.

Elements of \mathcal{K} placed on arcs act trivially on $A(+)$ and $A(-)$, see Figure 2.4.1. In the earlier examples, elements of \mathcal{K} are shown in Figures 2.3.3, 2.3.7, 2.3.12, where in each case $\dim \mathcal{K} = 1$.

Denote by

$$(41) \quad p : U \subset A(+)$$

the composition of the inclusion of algebra U into $A(+)$ and projection $p_{\mathcal{K}}$ onto \mathcal{K} along \mathcal{I} . The latter map can be written as either left or right multiplication by $1_{\mathcal{K}}$,

$$(42) \quad p_{\mathcal{K}}(y) = 1_{\mathcal{K}} y = y 1_{\mathcal{K}},$$

and, hiding the inclusion, we can write $p(x) = 1_{\mathcal{K}} x = x 1_{\mathcal{K}}$ for $x \in U$.

Furthermore, the surjection $\mathbf{k}\Sigma^* \rightarrow U$ can be composed with p above. Denote the resulting algebra homomorphism by

$$(43) \quad p_* : \mathbf{k}\Sigma^* \rightarrow \mathcal{K}, \quad p_*(\omega) = 1_{\mathcal{K}} \omega = \omega 1_{\mathcal{K}}, \quad \omega \in \Sigma^*,$$

where, when multiplying by $1_{\mathcal{K}}$, we view ω as an element of U or $A(+)$.

Introduce a trace map tr on \mathcal{K} by the circular closure and evaluation, see Figure 2.4.2,

$$(44) \quad \text{tr} : \mathcal{K} \rightarrow \mathbf{k}.$$

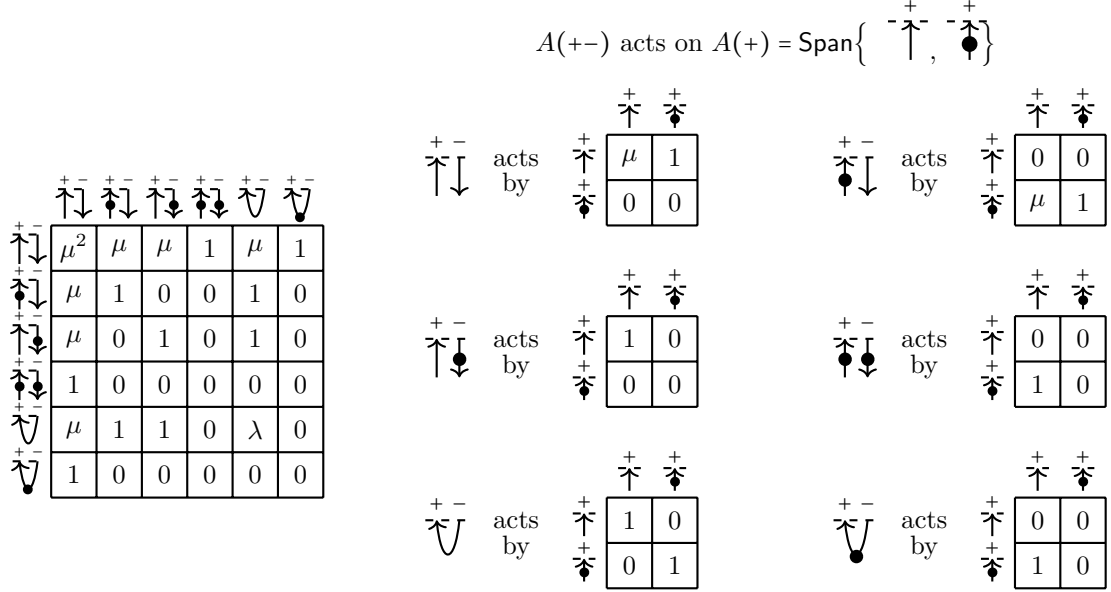

FIGURE 2.3.10. Pairing on $A(+ -)$ for Example 2.6. Left: matrix of bilinear pairing. Right: action of $A(+ -)$ on $A(+)$.

$$\begin{array}{ccccccc}
 0 & \longrightarrow & U \cap \mathcal{I} & \longrightarrow & U & \longrightarrow & \mathcal{K} \longrightarrow 0 \\
 & & \parallel & & \cong & & \parallel \\
 0 & \longrightarrow & (a) & \longrightarrow & \mathbf{k}[a]/(a^2) & \longrightarrow & \mathbf{k} \longrightarrow 0
 \end{array}
 \qquad
 U = \left\langle \begin{array}{c} + \\ \uparrow \\ - \\ \downarrow \end{array}, \begin{array}{c} + \\ \uparrow \\ \bullet \\ \downarrow \end{array} \right\rangle$$

$$U \cap A(+) \otimes A(-) = \left\langle \begin{array}{c} + \\ \bullet \\ \downarrow \end{array} \right\rangle$$

FIGURE 2.3.11. In this short exact sequence, $\dim U = 2$, $\dim \mathcal{K} = 1$, $\dim \mathcal{I} = 4$, and $\dim U \cap \mathcal{I} = 1$. The ideal (a) is nilpotent since $a^2 = 0$. Algebra U is not semisimple and the sequence does not split.

$$\mathcal{K} = \text{Span}_{\mathbf{k}} \left\{ \begin{array}{c} + \\ \uparrow \\ - \\ \downarrow \end{array} + \mu \begin{array}{c} + \\ \bullet \\ \downarrow \end{array} - \begin{array}{c} + \\ \uparrow \\ \bullet \\ \downarrow \end{array} - \begin{array}{c} + \\ \uparrow \\ \downarrow \end{array} \right\}$$

FIGURE 2.3.12. The unit element of \mathcal{K} , Example 2.6, with $\dim(\mathcal{K}) = 1$.

Note that, in general, both α_1 and α_o are used for the evaluation, since elements of \mathcal{K} are linear combinations of elements of U and $A(+)$ \otimes $A(-)$. The circular closure on elements on U , respectively $A(+)$ \otimes $A(-)$, is computed via α_o , respectively α_1 .

The following relation between traces holds:

$$(45) \qquad \text{tr}(p_*(\omega)) = \alpha_o(\omega) - \alpha_1^{\text{tr}}(\omega), \quad \omega \in \Sigma^*,$$

where

$$(46) \qquad \alpha_1^{\text{tr}}(\omega) := \text{tr}_{A(+)}(\omega).$$

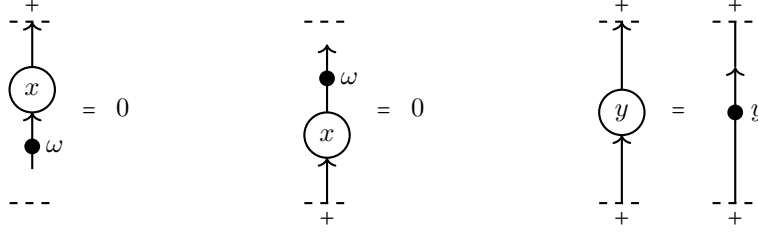

FIGURE 2.4.1. Left: elements $x \in \mathcal{K}$ annihilate $A(+)$ and $A(-)$. Right: two possible notations for $y \in A(+)$. Also see Figure 2.4.5.

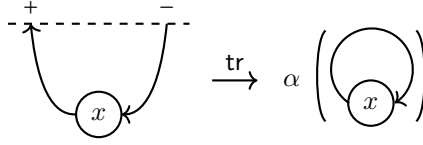

FIGURE 2.4.2. Trace map on $\mathcal{K} \subset A(+)$.

Recall that evaluation α_1^{tr} depends only on the interval evaluation α_1 and is given by the trace of words on $A(+)$.

Note that $\text{tr}(\omega) = \alpha_o(\omega)$, since we view ω as an element of either $\mathbf{k}\Sigma^*$ or U , via the projection onto the latter. In formula (45) projection p_* appears, which introduces an additional term.

REMARK 2.7. If comparing to formula (11), recall that there circular series α_o was picked to depend on α_1 and give a 1D TQFT, while here we are considering arbitrary rational α_1, α_o .

Extending linearly from ω to elements of $\mathbf{k}\Sigma^*$, we get

$$(47) \quad \text{tr}(p_*(z)) = \alpha_o(z) - \alpha_1^{\text{tr}}(z), \quad z \in \mathbf{k}\Sigma^*,$$

PROPOSITION 2.8. Trace tr in formula (44) turns \mathcal{K} into a symmetric Frobenius algebra with the unit element $1_{\mathcal{K}}$.

A Frobenius algebra is called *symmetric* if $\text{tr}(xy) = \text{tr}(yx)$ for any elements x, y .

PROOF. The trace (44) on \mathcal{K} is symmetric, since the circular closure is symmetric. The pairing $A(+)\otimes A(+)\rightarrow\mathbf{k}$ is non-degenerate, and elements of \mathcal{K} are orthogonal to those of $\mathcal{I}=A(+)\otimes A(-)$ in this pairing. Consequently and in view of the direct product (hence direct sum) decomposition (40), any nonzero element of \mathcal{K} can be paired to some element of \mathcal{K} to get a nontrivial evaluation, implying that the trace is non-degenerate. \square

REMARK 2.9. Vice versa, any symmetric Frobenius algebra (B, tr_B) can be obtained from some rational evaluation $\alpha=(\alpha_1, \alpha_o)$ in this way. For that, choose a set Σ of generators of algebra B and form circular series $\alpha_o(\omega)=\text{tr}_B(\omega)$, viewing $\omega\in\Sigma^*$ as an element of B via the monoid homomorphism $\Sigma^*\rightarrow B$, where B is naturally a monoid under multiplication. Set the interval evaluation α_1 identically to zero, $\alpha_1(\omega)=0$ for any word ω . Then $A(+)=0=A(-)$, the trace $\alpha_1^{\text{tr}}=0$, and $\mathcal{K}=A(+)\cong B$ with the trace tr . Similar examples can be produced with $A(+)\neq 0$.

Pair (B, tr_B) as in Remark 2.9 gives rise to monoidal category \mathcal{C}_B obtained via the universal construction as follows. First consider the category \mathcal{C}'_B with objects – finite sign sequences and morphisms finite \mathbf{k} -linear combinations of one-dimensional cobordisms with defects. Floating endpoints are not

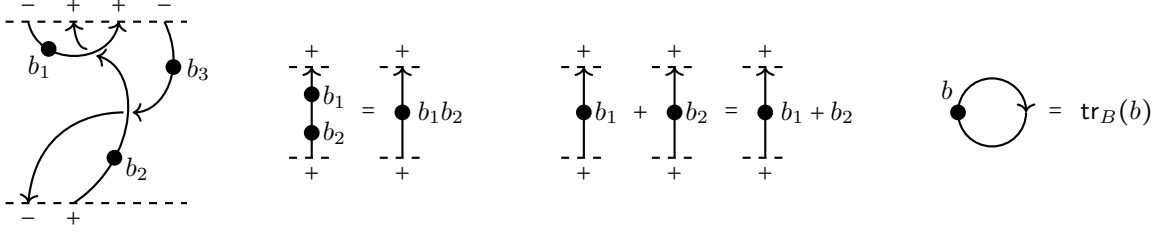

FIGURE 2.4.3. Left: a diagram for a morphism from $--$ to $-+--$ in categories \mathcal{C}'_B and \mathcal{C}_B . Middle: concatenation and addition relations. Right: evaluation of a decorated circle.

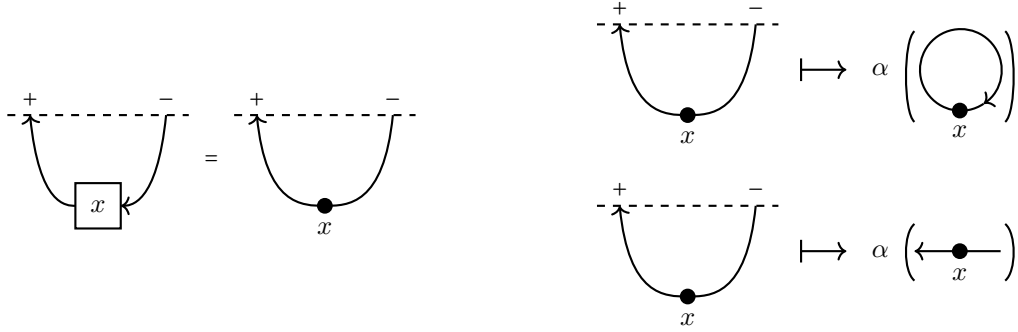

FIGURE 2.4.4. The two trace maps on $A(+--)$.

allowed this time, and defects are labelled by elements of B , see Figure 2.4.3 on the left. Concatenation and addition of defects corresponds to multiplication and addition in B , and decorated circles are evaluated via the trace on B , see Figure 2.4.3.

Since B is not, in general, commutative, it is essential to require strands to be oriented, to make sense of the concatenation formula in Figure 2.4.3 (second diagram from left). The resulting category \mathcal{C}'_B can be thought as a decorated version of the oriented Brauer category and is known as the *Frobenius–Brauer category* [SS22, MS22, Sav21]. Next, we apply the universal construction to \mathcal{C}'_B (since trace tr_B allows to evaluate any closed diagram) to get the quotient category, denoted \mathcal{C}_B . Equivalently, one can define \mathcal{C}_B as the quotient of \mathcal{C}'_B by the ideal of negligible morphisms. Trace on B is omitted from our notations for these two categories, but both \mathcal{C}'_B and \mathcal{C}_B depend on it as well.

REMARK 2.10. Algebra $A(+--)$ carries two trace maps, see Figure 2.4.4. This pair of maps is nondegenerate on $A(+--)$, in a suitable sense. In the above construction only the first trace map is considered.

REMARK 2.11. It is interesting that starting with a 1-dimensional theory with defects one obtains a symmetric Frobenius algebra \mathcal{K} , since the latter describes a 2D TQFT for thin surfaces, see [KQ20, page 19] as well as [LP08, LP09, MS06, Lau06, KQR21], hinting at a sort of dimensional lifting. We discuss this later in the paper, in Section 3.

Algebra $A(+--)$ has an idempotent decomposition (40), which we can write as

$$(48) \quad 1 = 1_{\mathcal{K}} + \sum_{i=1}^k v^i \otimes v_i,$$

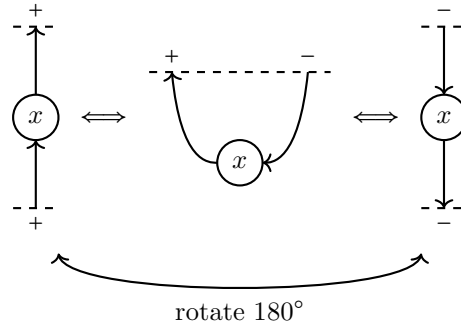

FIGURE 2.4.5. Strand bending leads to isomorphisms (49).

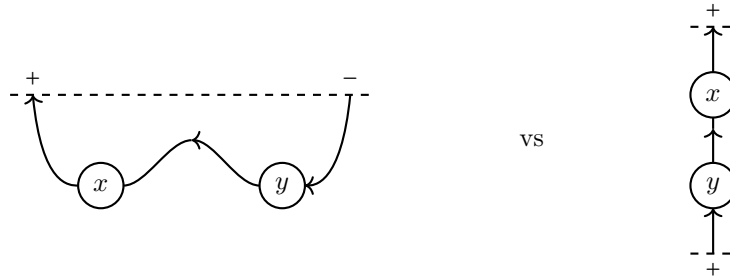

FIGURE 2.4.6. Multiplications in $A(+)$ and $\text{End}_{C_\alpha}(+)$ match under the isomorphism (49).

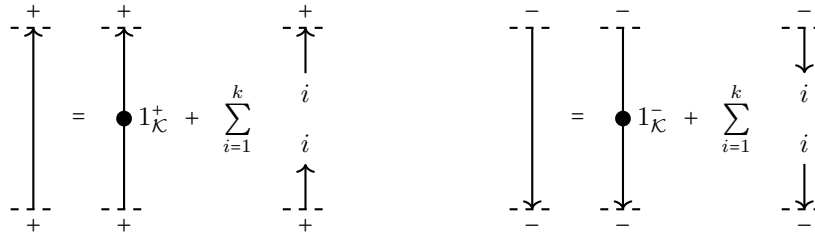

FIGURE 2.4.7. Idempotent decompositions for id_+ and id_- .

with each $v^i \otimes v_i$, $1 \leq i \leq k$ and $1_{\mathcal{K}}$ together constituting $k + 1$ mutually orthogonal idempotents. There are natural algebra isomorphisms

$$(49) \quad \text{End}_{C_\alpha}(+) \cong A(+, -) \cong \text{End}_{C_\alpha}(-)^{\text{op}}.$$

given by bending strands, see Figures 2.4.5 and 2.4.6.

The corresponding orthogonal idempotent decompositions in $\text{End}_{C_\alpha}(+)$ and $\text{End}_{C_\alpha}(-)^{\text{op}}$ are given by

$$(50) \quad \text{id}_+ = 1_{\mathcal{K}} + \sum_{i=1}^k v^i \otimes v_i^*, \quad \text{id}_- = 1_{\mathcal{K}} + \sum_{i=1}^k v_i \otimes v_i^*,$$

see Figure 2.4.7

Consider the Karoubi envelope $\text{Kar}(\mathcal{C}_\alpha)$ of \mathcal{C}_α , also denoted $\underline{\mathcal{D}}\mathcal{C}_\alpha$ in [Kho20a]. Denote by $e_0^+, e_1^+, \dots, e_k^+$ the idempotents in the endomorphism ring of $+$, see (50), so that $e_0^+ = 1_{\mathcal{K}}^+$ and $e_i = v^i \otimes v_i^*$, and use the same notation but with $-$ instead of $+$ for the $-$ object, so that

$$(51) \quad \text{id}_+ = e_0^+ + \dots + e_k^+, \quad \text{id}_- = e_0^- + \dots + e_k^-$$

Objects $+$ and $-$ in the category $\text{Kar}(\mathcal{C}_\alpha)$ are isomorphic to the direct sum of objects

$$(52) \quad + \cong \bigoplus_{i=0}^k (+, e_i^+), \quad - \cong \bigoplus_{i=0}^k (-, e_i^-).$$

For $0 \leq i \leq k$ objects $(+, e_i^+)$ and $(-, e_i^-)$ are dual. Furthermore, we have

PROPOSITION 2.12. Objects $(+, e_i^+)$ and $(-, e_i^-)$ are isomorphic, for $i \geq 1$. Objects $(+, e_i^+)$ and $(+, e_j^+)$ are isomorphic, for $i, j \geq 1$. Each of these objects is isomorphic to the identity object $\mathbf{1}$ of $\text{Kar}(\mathcal{C}_\alpha)$.

PROOF. It is enough to set up pairs of morphisms between the corresponding objects of \mathcal{C}_α such that the compositions are the corresponding idempotents. These morphisms are shown in Figure 2.1.11 for objects $(+, e_i^+)$ and $(+, e_j^+)$. For objects $(+, e_i^+)$ and $(-, e_i^-)$ the morphisms are shown in Figure 2.1.10 on the right. Note also that $\text{End}_{\text{Kar}(\mathcal{C}_\alpha)}((+, e_i^+)) = \mathbf{k}$. Isomorphisms between each of $(+, e_i^+)$ and $(-, e_i^-)$ and $\mathbf{1}$ are given by the half-intervals (up oriented for $+$, down oriented for $-$) with the top or bottom boundary $+$ or $-$. The identity object $\mathbf{1}$ is represented by the empty 0-manifold \emptyset_0 (by the empty sign sequence). \square

COROLLARY 2.13. $2k$ objects $(+, e_1^+), \dots, (+, e_k^+)$ and $(-, e_1^-), \dots, (-, e_k^-)$ are pairwise isomorphic, and each is isomorphic to $\mathbf{1}$. For any of these objects X the endomorphism ring $\text{End}_{\text{Kar}(\mathcal{C}_\alpha)}(X) \cong \mathbf{k}$.

Denote by \mathcal{C}' the full tensor additive subcategory of $\text{Kar}(\mathcal{C}_\alpha)$ generated by these $2k$ objects and $\mathbf{1}$. It is a rigid category.

PROPOSITION 2.14. The category \mathcal{C}' is tensor (symmetric monoidal) equivalent to the category $\mathbf{k}\text{-vect}$ of finite-dimensional \mathbf{k} -vector spaces with the standard tensor structure. It is Karoubi-closed.

PROOF. This is immediate since monoidal generators of \mathcal{C}' are all equivalent to $\mathbf{1}$. The unit object $\mathbf{1} \in \text{Ob}(\text{Kar}(\mathcal{C}_\alpha))$ generates a full monoidal subcategory of $\text{Kar}(\mathcal{C}_\alpha)$ which is monoidal equivalent to $\mathbf{k}\text{-vect}$. \square

Recall the complementary idempotent $e_0^+ = 1_{\mathcal{K}}^+$ to $e_{>0}^+ := e_1^+ + \dots + e_k^+$ in id_+ , see Figure 2.4.7. Likewise, $e_0^- = 1_{\mathcal{K}}^-$ is the complementary idempotent to $e_{>0}^- := e_1^- + \dots + e_k^-$ in id_- . Consider the corresponding objects of $\text{Kar}(\mathcal{C}_\alpha)$:

$$(53) \quad X_0^+ := (+, e_0^+), \quad X_0^- := (-, e_0^-), \quad X_{>0}^+ := (+, e_{>}^+), \quad X_{>0}^- := (-, e_{>}^-).$$

Then the first pair of objects is *monoidal orthogonal* to the second pair in the following strong sense. For any $n > 0, m \geq 0$

$$(54) \quad \text{Hom}_{\text{Kar}(\mathcal{C}_\alpha)}((X_0^+ \oplus X_0^-)^{\otimes n}, (X_{>0}^+ \oplus X_{>0}^-)^{\otimes m}) = 0,$$

$$(55) \quad \text{Hom}_{\text{Kar}(\mathcal{C}_\alpha)}((X_{>0}^+ \oplus X_{>0}^-)^{\otimes m}, (X_0^+ \oplus X_0^-)^{\otimes n}) = 0,$$

that is, the space of homs between any nonempty finite tensor product of X_0^+ and X_0^- and a finite tensor product of $X_{>0}^+$ and $X_{>0}^-$ is zero. In particular, there is only the 0 morphism between any nonempty finite tensor product of X_0^+ and X_0^- and $\mathbf{1}$.

Equations (54), (55) follow from the orthogonality between elements of \mathcal{K} and elements of $A(+)$, $A(-)$ shown in Figure 2.4.1 on the left and center.

Objects X_0^+ and X_0^- are dual. Denote by $\tilde{\mathcal{C}}_\alpha$ the full monoidal additive and Karoubi-closed subcategory of $\text{Kar}(\mathcal{C}_\alpha)$ generated by these two objects (and object $\mathbf{1}$). We now relate this category to the Frobenius–Brauer category $\mathcal{C}'_{\mathcal{K}}$ associated to the Frobenius algebra $(\mathcal{K}, \text{tr}_{\mathcal{K}})$ and its negligible quotient $\mathcal{C}_{\mathcal{K}}$, see earlier.

Recall that to a symmetric Frobenius \mathbf{k} -algebra (B, tr_B) , we have assigned a category \mathcal{C}'_B (the Frobenius–Brauer category) of 1-cobordisms with dots decorated by elements of B subject to relations in Figure 2.4.3. Then category \mathcal{C}_B is the quotient of \mathcal{C}'_B via the universal construction for the evaluation of closed B -decorated 1-manifold via tr_B . Equivalently, \mathcal{C}_B is the *gligible quotient* of \mathcal{C}'_B , the quotient by the 2-sided ideal of negligible morphisms.

Now specialize to the symmetric Frobenius algebra $(\mathcal{K}, \text{tr}_{\mathcal{K}})$ associated to the evaluation α . We have canonical \mathbf{k} -algebra isomorphisms $\text{End}(X_0^+) \cong \mathcal{K} \cong \text{End}(X_0^-)$.

PROPOSITION 2.15. These isomorphisms extend to a monoidal and full functor

$$(56) \quad \mathcal{F}_0 : \mathcal{C}'_{\mathcal{K}} \longrightarrow \text{Kar}(\mathcal{C}_{\alpha})$$

taking the object $+\in \text{Ob}(\mathcal{C}'_{\mathcal{K}})$ to $X_0^+ = (+, e_0^+)$ and object $-$ to $X_0^- = (-, e_0^-)$.

PROOF. The functor \mathcal{F}_0 takes $\mathbf{1}$ to $\mathbf{1}$. It takes an arc carrying a dot labelled $x \in \mathcal{K}$ to the arc with the same label, which is now viewed as a morphism in $\text{Kar}(\mathcal{C}_{\alpha})$ between products of X_0^+ and X_0^- . For instance, The arc in Figure 2.4.4 on the left, for $x \in \mathcal{K}$, can be viewed as a morphism in $\mathcal{C}'_{\mathcal{K}}$ from $\mathbf{1}$ (the identity object in $\mathcal{C}'_{\mathcal{K}}$) to the object $+-$ and, alternatively, as a morphism in $\text{Kar}(\mathcal{C}_{\alpha})$ from $\mathbf{1}$ (the identity object in $\text{Kar}(\mathcal{C}_{\alpha})$) to the object $X_0^+ \otimes X_0^-$.

Earlier computations, including orthogonality relations (54), (55) imply that \mathcal{F}_0 is well-defined and surjective on morphisms (a full functor). \square

Category $\text{Kar}(\mathcal{C}_{\alpha})$ is the Karoubi envelope of \mathcal{C}_{α} , the latter defined via the universal construction for the evaluation α . Restricting evaluation α to closures of elements of $\mathcal{K} \subset A(+)$ results in the trace $\text{tr}_{\mathcal{K}}$ on \mathcal{K} used in the construction of the category $\mathcal{C}'_{\mathcal{K}}$ and its gligible quotient $\mathcal{C}_{\mathcal{K}}$ (quotient via the universal construction). The two evaluations – in categories \mathcal{C}_{α} and $\mathcal{C}'_{\mathcal{K}}$ – match, for the above inclusion $\mathcal{K} \subset A(+)$. Consequently, we obtain the following statement.

PROPOSITION 2.16. Functor \mathcal{F}_0 in (56) factors through the gligible quotient $\mathcal{C}_{\mathcal{K}}$ of $\mathcal{C}'_{\mathcal{K}}$ and induces a fully-faithful and monoidal functor

$$(57) \quad \mathcal{F} : \mathcal{C}_{\mathcal{K}} \longrightarrow \text{Kar}(\mathcal{C}_{\alpha})$$

In particular, functor \mathcal{F}_0 factorizes as the composition

$$(58) \quad \mathcal{C}'_{\mathcal{K}} \longrightarrow \mathcal{C}_{\mathcal{K}} \xrightarrow{\mathcal{F}} \text{Kar}(\mathcal{C}_{\alpha}).$$

where the first arrow is the gligible quotient functor.

Functor \mathcal{F} induces a monoidal functor

$$(59) \quad \text{Kar}(\mathcal{F}) : \text{Kar}(\mathcal{C}_{\mathcal{K}}) \longrightarrow \text{Kar}(\mathcal{C}_{\alpha}).$$

PROPOSITION 2.17. Functor $\text{Kar}(\mathcal{F})$ is an equivalence of categories.

PROOF. Recall the complementary object $X_{>0}^+$ to X_0^+ in $+\in \text{Ob}(\text{Kar}(\mathcal{C}_{\alpha}))$, so that $+\cong X_0^+ \oplus X_{>0}^+$. Likewise, $X_{<0}^-$ is complementary to X_0^- with respect to the object $-$ of $\text{Kar}(\mathcal{C}_{\alpha})$. Objects $X_{>0}^+$ and $X_{<0}^-$ are both isomorphic to the direct sum of k copies of the object $\mathbf{1}$. Consequently, the category $\text{Kar}(\mathcal{C}_{\alpha})$ is equivalent to the Karoubi closure of the monoidal subcategory generated by X_0^+ and X_0^- . Taking earlier propositions into consideration completes the proof. \square

We now explain the meaning of these results. Starting with a rational evaluation $\alpha = (\alpha_1, \alpha_0)$ we formed the decomposition $A(+)$ $\cong \mathcal{I} \times \mathcal{K}$, with $\mathcal{I} \cong A(+)$ $\otimes A(-)$ and the complementary factor \mathcal{K} orthogonal, in a suitable sense, to $A(+)$ and $A(-)$.

Algebra \mathcal{K} is symmetric Frobenius, with the nondegenerate trace given by the closure operation in Figure 2.4.2. Note also the trace formula (45) for the trace computed on the projection from $\mathbf{k}\Sigma^* \subset A(+)$ onto \mathcal{K} as the difference $\alpha_0 - \alpha_1^{\text{tr}}$.

Symmetric Frobenius algebras (Frobenius algebras B with a symmetric trace, $\text{tr}(xy) = \text{tr}(yx)$, $x, y \in B$) are also called just *symmetric* algebras. To the symmetric algebra $(\mathcal{K}, \text{tr}_{\mathcal{K}})$ we assign the Frobenius–Brauer category $\mathcal{C}'_{\mathcal{K}}$ and its gligible quotient $\mathcal{C}_{\mathcal{K}}$. Then there is a natural fully-faithful monoidal functor $\mathcal{F} : \mathcal{C}_{\mathcal{K}} \rightarrow \text{Kar}(\mathcal{C}_{\alpha})$, see Proposition 2.16, inducing an equivalence (59) of Karoubi envelopes of $\mathcal{C}_{\mathcal{K}}$ and \mathcal{C}_{α} .

Conceptually, passing to the Karoubi envelope $\text{Kar}(\mathcal{C}_{\alpha})$ allows one to reduce the consideration to the Frobenius algebra \mathcal{K} together with the trace $\text{tr}_{\mathcal{K}}$ on it. Decorated half-arc morphisms go between $\mathbf{1}$ and summands of $+$ and $-$ objects which are equivalent to $\mathbf{1}$ and can be ignored in the Karoubi envelope. In a sense, no genuinely new idempotents appear when considering half-intervals. Beyond the identity object $\mathbf{1}$ we only need the objects X_0^+, X_0^- coming from \mathcal{K} , tensor products of these objects and summands of these tensor products to describe a category equivalent to $\text{Kar}(\mathcal{C}_{\alpha})$.

General one-variable case. Let us specialize again to a single variable to generalize examples 2.5–2.6. Consider a general one-variable case $\Sigma = \{a\}$, with rational evaluation functions as in (37), (36). State space $A(+)$ depends on $Z_1(T)$ only, and let

$$(60) \quad Z_1(T) = \frac{P_1(T)}{Q_1(T)}, \quad n_1 = \deg(P_1(T)), \quad m_1 = \deg(Q_1(T)),$$

for polynomials $P_1(T), Q_1(T)$ with $Q_1(0) \neq 0$. Consider the polynomial

$$(61) \quad g_1(T) := T^{m_1} Q_1(1/T) T^{\max(0, n_1 - m_1 + 1)} = T^{m_1 + \max(0, n_1 - m_1 + 1)} Q_1(1/T),$$

the product of the reciprocal polynomial of $Q_1(T)$ and a power of T . Then $g_1(T)$ is the characteristic polynomial for the action of a on $A(+)$, see [Kho20b, KOK22] for the equivalent case of the state space of a circle in a two-dimensional topological theory. In particular,

$$(62) \quad \dim A(+) = \dim A(-) = \deg(g_1(T)) = m_1 + \max(0, n_1 - m_1 + 1).$$

and $A(+)$ is a cyclic $\mathbf{k}[a]$ -module given by

$$(63) \quad A(+) \cong \mathbf{k}[a]/(g_1(a)).$$

Note that for any rational series

$$(64) \quad Z(T) = \frac{P(T)}{Q(T)}, \quad n = \deg(P(T)), \quad m = \deg(Q(T)), \quad Q(0) \neq 0,$$

we can form the corresponding polynomial

$$(65) \quad g_Z(T) := T^m Q(1/T) T^{\max(0, n - m + 1)} = T^{m + \max(0, n - m + 1)} Q(1/T),$$

which is the characteristic polynomial for the action of a on the state space $A(+)$ associated to the series $Z(T)$.

In the direct product decomposition $A(+ -) \cong \mathcal{I} \times \mathcal{K}$ the factor $\mathcal{I} \cong A(+) \otimes A(-)$ can be understood from this data. To handle \mathcal{K} , let us start with the potentially larger algebra U . These algebras fit into a diagram of surjective homomorphisms

$$(66) \quad \mathbf{k}[a] \xrightarrow{p_0} U \xrightarrow{p} \mathcal{K}, \quad p_* : \mathbf{k}[a] \rightarrow \mathcal{K}, \quad p_* := p p_0,$$

where map p_0 sends a^n to an arc with n dots (see Figure 2.3.1 on the right and specialize $\omega = a^n$), and p is the composition of the inclusion of U into $A(+ -)$ and projection onto \mathcal{K} , see (41). Finally, let $p_* := p \circ p_0$, see (43).

Algebra U is naturally a quotient $U \cong \mathbf{k}[a]/(g(a))$, for some polynomial $g(a)$. A polynomial $f(a)$ is 0 in U if and only if it (1) acts trivially on $A(+)$ (equivalently, $f(a) \in (g_1(a))$) and (2) belongs to the kernel of the bilinear form on U given by $(f_1, f_2) = \text{tr}(f_1 f_2)$, with the trace given by closing an arc into into a circle and evaluating it via α_{\circ} , see the top right diagram in Figure 2.4.4.

Evaluation α_\circ is encoded by a rational series

$$(67) \quad Z_\circ(T) = \frac{P_\circ(T)}{Q_\circ(T)}, \quad n_\circ = \deg(P_1(T)), \quad m_\circ = \deg(Q_1(T)),$$

with $Q_\circ(0) \neq 0$. Form the polynomial (as in (61))

$$(68) \quad g_\circ(T) := T^{m_\circ} Q_\circ(1/T) T^{\max(0, n_\circ - m_\circ + 1)} = T^{m_\circ + \max(0, n_\circ - m_\circ + 1)} Q_\circ(1/T),$$

Then the principal ideal $(g_\circ(a)) \subset \mathbf{k}[a]$ is the kernel of the above bilinear form, and U is naturally the quotient of $\mathbf{k}[a]$ by the intersection of the two principal ideals $(g_1(a))$ and $(g_\circ(a))$. Let $g_\alpha(a) := \text{lcm}(g_1(a), g_\circ(a))$ be the lcm of these two polynomials. We get a canonical isomorphism

$$(69) \quad U \cong \mathbf{k}[a]/(g_\alpha(a)) \cong \mathbf{k}[a]/(\text{lcm}(g_1(a), g_\circ(a))).$$

Coming back to \mathcal{K} , recall that it is a quotient of U and $\mathbf{k}[a]$, see (66) and (43), via quotient maps p and pp_0 , respectively.

Form the trace series $Z_1^{\text{tr}} := Z_{\alpha_1}^{\text{tr}}(T)$ of $Z_{\alpha_1}(T)$, see formulas (26)-(28), and the difference of the two series

$$(70) \quad Z_{\circ 1}(T) := Z_\circ(T) - Z_1^{\text{tr}}(T).$$

Let $g_{\circ 1}(T)$ be the characteristic polynomial for the action of a associated to these series, see (65).

The relation (45) on the trace, reproduced below,

$$(71) \quad \text{tr}(p_*(\omega)) = \alpha_\circ(\omega) - \alpha_1^{\text{tr}}(\omega), \quad \omega \in \Sigma^*,$$

implies that under the homomorphism p_* in (66) the trace on $\omega = a^n$, viewed as an element of \mathcal{K} , is given by the coefficient at T^n of the series $Z_{\circ 1}(T)$ above. Consequently, there is a natural isomorphism

$$(72) \quad \mathcal{K} \cong \mathbf{k}[a]/(g_{\circ 1}(a)),$$

with $g_{\circ 1}(T)$ associated to the series $Z_{\circ 1}(T)$. The quotient map $U \rightarrow \mathcal{K}$ takes $a \in U$ to $p_*(a) \in \mathcal{K}$. From the isomorphisms

$$(73) \quad U \cong \mathbf{k}[a]/(\text{lcm}(g_1(a), g_\circ(a))), \quad \mathcal{K} \cong \mathbf{k}[a]/(g_{\circ 1}(a))$$

that respect the surjection, we obtain an inclusion of ideals $(\text{lcm}(g_1(a), g_\circ(a))) \subset (g_{\circ 1}(a))$, so that the one-variable polynomial $g_{\circ 1}(T)$ is a divisor of $\text{lcm}(g_1(T), g_\circ(T))$.

3. From 1D to 2D

3.1. Category of thin flat surfaces and symmetric Frobenius algebras. Factorization $A(+ -) \cong \mathcal{I} \times \mathcal{K}$ allows us to understand, as described above, the category $\text{Kar}(\mathcal{C}_\alpha)$. The term \mathcal{I} contributes objects isomorphic to $\mathbf{1}$ to the Karoubi envelope, while the symmetric Frobenius algebra \mathcal{K} leads to a \mathcal{K} -decorated Frobenius–Brauer category and its negligible quotient, which is equivalent to $\text{Kar}(\mathcal{C}_\alpha)$.

Thus, from a one-dimensional theory with defects we can extract a key piece of structure, the symmetric Frobenius algebra $(\mathcal{K}, \text{tr}_\mathcal{K})$ which, on one hand, describes $\text{Kar}(\mathcal{C}_\alpha)$, and on the other has a strongly two-dimensional flavor, since it gives a tensor functor on a suitable category of 2-dimensional cobordisms with corners.

In this section we review the two-dimensional nature of non-necessarily commutative symmetric algebras (B, tr_B) and their interpretation via tensor functors from the category of *thin flat surfaces with boundary and corners* to $\mathbf{k}\text{-vect}$. A version of this correspondence goes back at least to Moore–Segal [MS06], also see [Lau05, Lau06, LP07, LP08, Cap13, KQR21] and unpublished notes [KQ20]. Our modest contribution is to point out that elements of B can be placed as labelled dots (0-dimensional defects) along the inner edges of cobordisms and to provide a neck-cutting formula in this language. We discuss obstacles in the nonsemisimple case to extending a thin surface

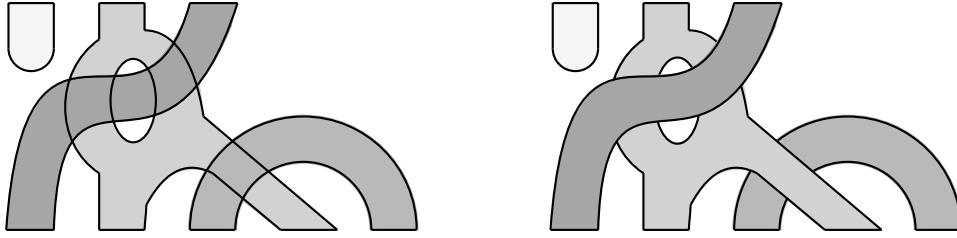

FIGURE 3.1.1. Left: a thin flat surface for a morphism $5 \rightarrow 3$ in TCob_2 . Right: Same morphism represented by a thin flat surface embedded in $\mathbb{R}^2 \times [0, 1]$. Different connected components of a surface are shaded in different ways to make it easier to discern overlapping regions.

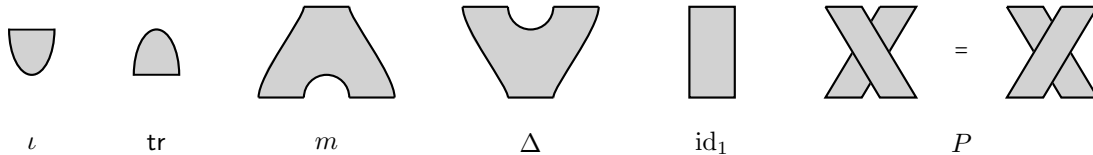

FIGURE 3.1.2. A set of generating morphisms in the symmetric monoidal category TCob_2 . The labels next to morphisms denote the structure maps of a symmetric Frobenius algebra associated to a monoidal functor from TCob_2 to $\mathbf{k}\text{-vect}$, see Proposition 3.1 below. From left to right, these are the unit map ι , the trace map tr , multiplication m and its dual Δ , identity, and permutation map P .

TQFT to an open-closed TQFT as in [MS06, LP07, LP08, Cap13]. We also show how a combination of a symmetric Frobenius algebra and an evaluation series for closed cobordisms leads to a universal construction which occupies an intermediate role between open-closed two-dimensional TQFT [MS06, LP07, LP08] and general two-dimensional topological theories for surfaces with corners [KQR21].

The category TCob_2 of *thin flat surfaces* is defined in [KQR21], where it is denoted TFS. It has objects $n \in \mathbb{Z}_+ = \{0, 1, 2, \dots\}$ represented by n disjoint intervals in \mathbb{R} ordered from left to right. Morphisms from n to m in TCob_2 are surfaces S with boundary and corners together with an immersion into the strip $\mathbb{R} \times [0, 1]$, see Figure 3.1.1 for an example. A surface inherits an orientation from that of $\mathbb{R} \times [0, 1]$. An immersion can have overlaps, that can be perturbed in $\mathbb{R}^2 \times [0, 1]$ into an embedding of S into the latter. Two morphisms are equal if the corresponding oriented surfaces are diffeomorphic rel boundary (forgetting the immersion or the embedding). We refer to [KQR21] for details.

Category TCob_2 is symmetric monoidal, with the monoidal structure given by placing objects and morphisms next to each other, in parallel. Figure 3.1.2 shows a possible set of generating morphisms of the monoidal category TCob_2 . Figure 3.1.3 shows some relations in TCob_2 , and we refer to [Lau05, KQR21] for a complete set of relations.

The following result is well-known, *c.f.*, [MS06, LP07, LP08, LP09, KQ20].

PROPOSITION 3.1. Symmetric monoidal functors $F : \text{TCob}_2 \rightarrow \mathbf{k}\text{-vect}$ are classified by symmetric Frobenius \mathbf{k} -algebras (B, tr_B) , assigning multiplication, unit, trace, comultiplication and permutation maps to cobordisms in Figure 3.1.1.

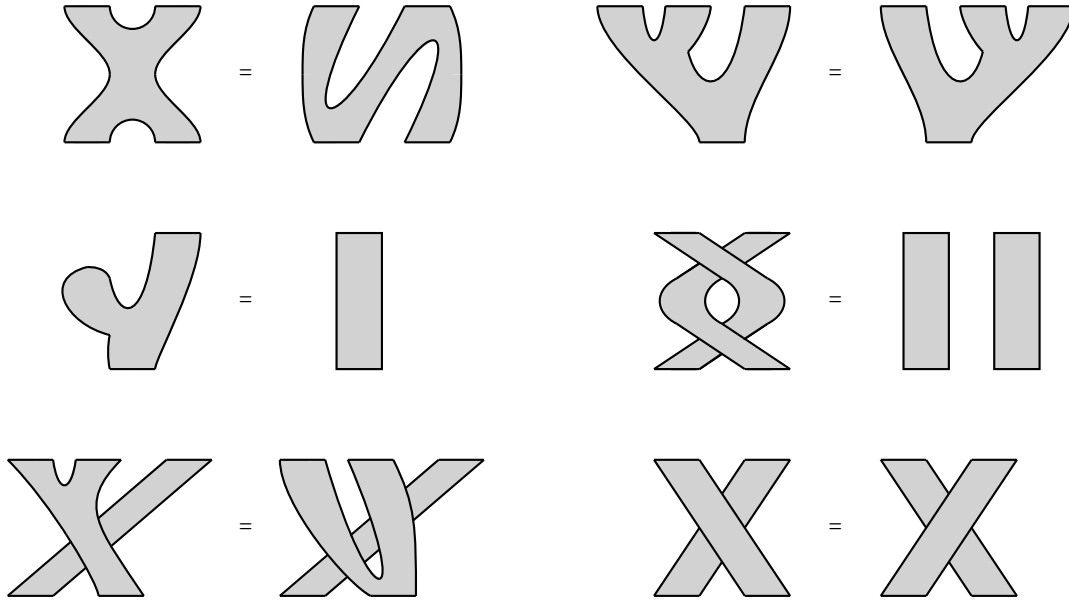
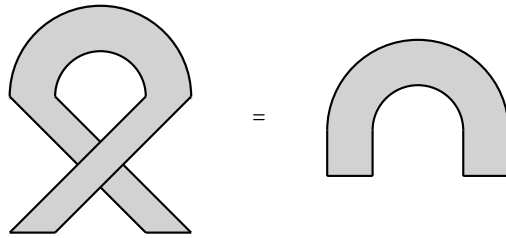
FIGURE 3.1.3. Some relations in TCob_2 on these generating morphisms.FIGURE 3.1.4. Equality of these two morphisms from 2 to 0 corresponds to the symmetricity of the trace: $\text{tr}(xy) = \text{tr}(yx)$, where $x, y \in B$.

Denote the functor associated to (B, tr_B) by F_B . In this notation we suppress the dependence of F_B on the trace map tr_B . Note that the symmetric trace condition comes from the Figure 3.1.4 equality of morphisms in TCob_2 .

The more familiar correspondence is that between *commutative* Frobenius algebras and symmetric monoidal functors from the category Cob_2 of oriented surfaces with boundary to $\mathbf{k}\text{-vect}$. In that case object n of Cob_2 is represented by n circles, not intervals, and the Frobenius algebra is commutative.

In this case of cobordisms between closed 1-manifolds and commutative Frobenius algebras (A, tr_A) the functor can be enhanced by introducing dots floating on the components of a cobordism and labelled by elements of A . Such dotted cobordism can be evaluated to a linear map between tensor powers of A , with dot a denoting multiplication by a map $m_a : A \rightarrow A, m_a(x) = ax$.

A similar enhancement exists for tensor functors $F_B : \text{TCob}_2 \rightarrow \mathbf{k}\text{-vect}$ as above and we could not find it in the literature. We explain it now.

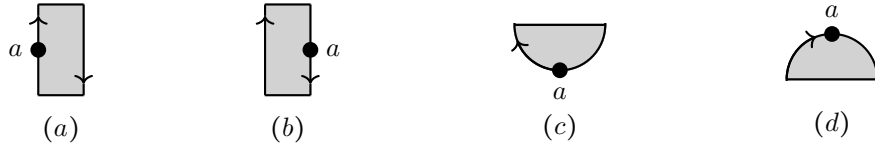

FIGURE 3.1.5. (a) Endomorphism ℓ_a of B , $\ell_a(x) = ax$, (b) Endomorphism r_a of B , $r_a(x) = xa$, (c) Element $a \in B$, (d) Trace map $B \rightarrow \mathbf{k}$, where $x \mapsto \text{tr}(ax)$.

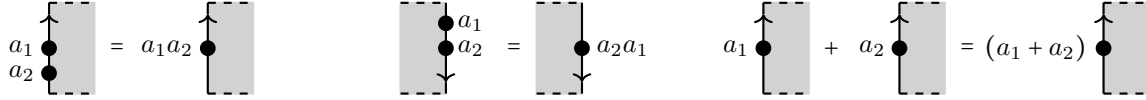

FIGURE 3.1.6. Merging and adding boundary dots.



FIGURE 3.1.7. Dot sliding past local maxima and minima.



FIGURE 3.1.8. Left: the surgery relation. Right: evaluation of a dot on the boundary of disk.

A dot labelled $a \in B$ on a side boundary denotes the endomorphism of multiplication by a in B . The endomorphism is the left multiplication ℓ_a by a if the local orientation at the dot is up and right multiplication by a if the local orientation at the dot is down, see Figure 3.1.5.

Likewise, an a -labelled dot at the side boundary of a half-disk denotes either the element $a \in B$ or the map $x \mapsto \text{tr}(ax)$ from B to \mathbf{k} , see Figure 3.1.5.

Dots can move freely along side boundaries and relations in Figure 3.1.6 hold. Figure 3.1.7 depicts that dots may slide past local maxima and minima.

Pick a basis $\{x_i\}_{i=1}^n$ of the vector space B and the dual basis $\{y_i\}_{i=1}^n$ of B with respect to the trace form, so that $\text{tr}(x_i y_j) = \delta_{i,j}$. Then the surgery relation holds, see Figure 3.1.8 left, that allows to cut a surface along an interval connecting two side boundary points. In particular, any closed surface in TCob_2 (a surface with empty horizontal boundary, that is, an endomorphism of object \emptyset_1), with side boundary decorated by elements of B , can be evaluated to an element of \mathbf{k} . Indeed, each connected component of such surface has nonempty side boundary and the surgery relation can be iteratively applied for an evaluation.

One can further augment possible decorations by allowing elements c of the center $Z(B)$ to float inside a surface. Such a floating dot denotes the multiplication by c endomorphism of B . A floating central element c can land onto a side boundary, see Figure 3.1.9.

Recall from [KQR21] that category TCob_2 has three commuting endomorphisms $\beta_1, \beta_2, \beta_3$ of object 1, see Figure 3.1.10. These endomorphisms were denoted b_1, b_2, b_3 in [KQR21] and satisfy the

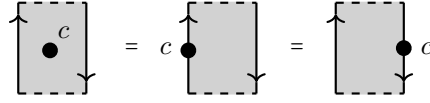

FIGURE 3.1.9. Central element c floating inside a thin surface can move on and off the boundary.

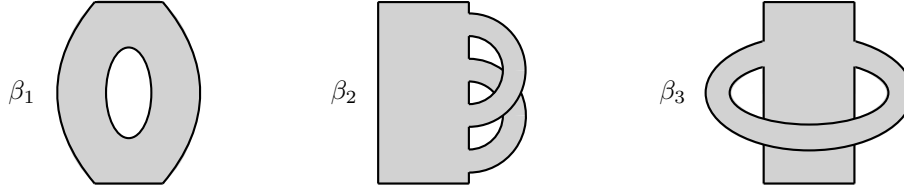

FIGURE 3.1.10. Endomorphisms $\beta_1, \beta_2, \beta_3$ of object 1 in category TCob_2 .

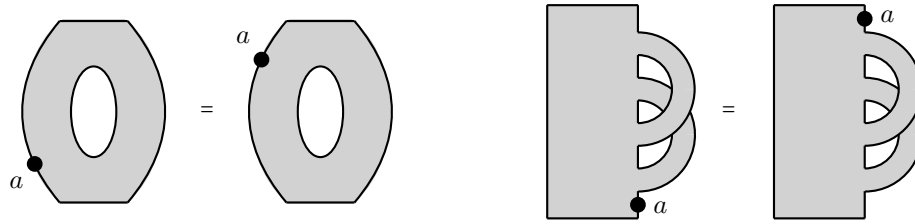

FIGURE 3.1.11. Moving a dot along a side boundary shows that maps $F_B(\beta_1), F_B(\beta_2)$ are B -bimodule maps. Two out of four of these dot moving relations are shown.

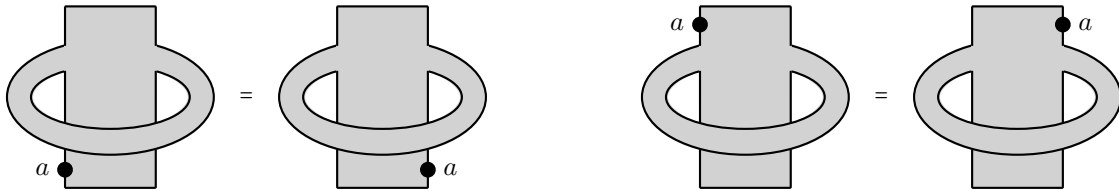

FIGURE 3.1.12. Dot sliding along side boundaries of the β_1 cobordism implies factorization (74) of $F_B(\beta_3)$.

relation $\beta_1\beta_3 = \beta_3^2$. Consider the functor F_B from TCob_2 to $\mathbf{k}\text{-vect}$. It takes these endomorphisms to \mathbf{k} -linear maps $F_B(\beta_1), F_B(\beta_2), F_B(\beta_3)$.

PROPOSITION 3.2. $F_B(\beta_1)$ and $F_B(\beta_2)$ are B -bimodule endomorphisms $B \rightarrow B$, determined by central elements $b_1 := F_B(\beta_1)(1)$ and $b_2 := F_B(\beta_2)(2)$, $b_1, b_2 \in Z(B)$. Map $F_B(\beta_3)$ can be factored as

$$(74) \quad B \xrightarrow{q_B} [B, B] \xrightarrow{\beta_B} Z(B) \xrightarrow{\iota_B} B$$

for a unique linear map β_B , where q_B is the quotient map by the commutator subspace and ι_B the inclusion of the center into B .

PROOF. Maps $F_B(\beta_1)$ and $F_B(\beta_2)$ are B -bimodule maps, since a -dots can be slid along the side edges of these cobordisms from near a corner at the bottom to the matching corner point at the top, see Figure 3.1.11.

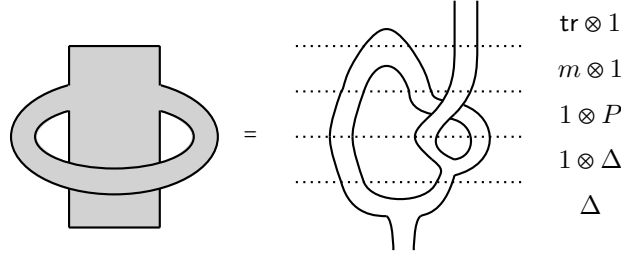

FIGURE 3.1.13. Factorization of the maps β_3 and $F_B(\beta_3)$. Here P is the permutation cobordism.

For the map $F_B(\beta_3)$, a dot a near the bottom left corner can be moved to the dot a near the bottom right corner, by dragging it along a side boundary, see Figure 3.1.12 on the left. Consequently, $F_B(\beta_3)(ab) = F_B(\beta_3)(ba)$ for any $a, b \in B$, so that $F_B(\beta_3)$ factors through map q_B .

Likewise, a -dot at the top left corner of β_3 can be moved to the top right corner of β_3 , by dragging it along a side boundary, see Figure 3.1.12 on the right. This means $aF_B(\beta_3)(b) = F_B(\beta_3)(b)a$ for any $a, b \in B$, that is, $F_B(\beta_3)(b)$ belongs to the center $Z(B)$ of B . Hence, $F_B(\beta_3)$ admits a factorization (74). \square

The map

$$(75) \quad \beta_B : B/[B, B] \longrightarrow Z(B)$$

is associated to a Frobenius algebra B with a symmetric trace.

EXAMPLE 3.3. Consider the group algebra $B = \mathbf{k}[C_p]$ of a prime order cyclic group $C_p = \{1, g | g^p = 1\}$ over a field \mathbf{k} of characteristic p with the trace

$$(76) \quad \text{tr}_B : B \longrightarrow \mathbf{k}, \quad \text{tr}_B(1) = 1, \quad \text{tr}_B(g^i) = 0, \quad 0 < i < p.$$

The comultiplication structure map of this thin surface TQFT is

$$(77) \quad \Delta(g^i) = \sum_{j=0}^{p-1} g^j \otimes g^{i-j}.$$

The map $F_B(\beta_3)$ is the composition

$$(78) \quad (\text{tr}_B \otimes 1)(m \otimes 1)(1 \otimes P)(1 \otimes \Delta)\Delta,$$

see Figure 3.1.13. Computing this map for the group algebra B yields $F_B(\beta_3) = 0$ and $\beta_B = 0$.

Choosing a finite set Σ of labels for the side boundary dots, one obtains a decorated version $\text{TCob}_{2, \Sigma}$ of the thin flat surface category, where side boundaries can carry dots labelled by elements of Σ as in Figures 3.1.5, 3.1.7, for instance. A symmetric Frobenius algebra (B, tr_B) as above together with a map of sets $\Sigma \longrightarrow B$ determines a symmetric monoidal functor $\text{TCob}_{2, \Sigma} \longrightarrow \mathbf{k}\text{-vect}$.

EXAMPLE 3.4. For Frobenius B in Example 3.3 and $\Sigma = \{g\}$, the relations for the resulting functor are shown in Figure 3.1.14, where a dot labelled $i \in \mathbb{Z}/p$ denotes multiplication by g^i at that position (a dot labelled 0 can be erased).

3.2. Open-closed TQFTs and topological theories.

Open-closed 2D TQFTs and knowledgeable Frobenius algebras. The usual category of oriented cobordisms between closed one-manifolds and the category of thin flat surfaces TCob_2 can be unified into the category of open-closed 2D cobordisms [MS06, LP08, Laz01, Lau06]. In that category OCCob_2 objects are compact oriented 1-manifolds with boundary, thus finite unions of intervals and circles. Morphisms are diffeomorphism classes (rel boundary) of oriented surfaces with boundary and

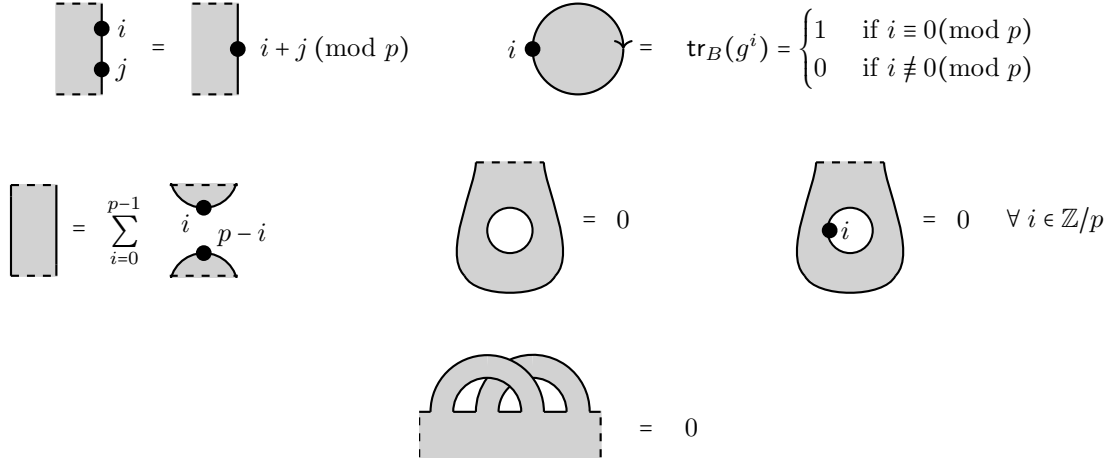

FIGURE 3.1.14. Boundary dots and relations for the thin surface TQFT in Examples 3.3, 3.4. The relation in the top right corner is the trace formula for B . The second and third relations in the second row and the bottom row relation follow from the surgery formula (first relation in the second row) and $\text{char}(\mathbf{k}) = p$.

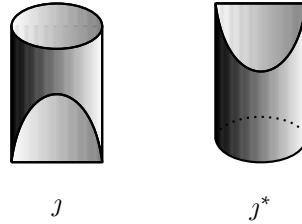

FIGURE 3.2.1. Zipper and cozipper cobordisms j and j^* in OCCob_2 .

corners. These surfaces have *side boundary* and corner points where side boundaries meet top and bottom boundary intervals. We refer to [LP08] for details. As a set of generating morphisms one can take the union of

- standard generating morphisms for thin surfaces in Figure 3.1.2 that correspond to the structure maps of a symmetric Frobenius algebra, and the permutation map P of two intervals,
- standard generating morphisms for the usual category of two-dimensional oriented cobordisms. These morphisms correspond to the structure maps in a commutative Frobenius algebra and the transposition of two circles,
- Zipper and cozipper cobordisms, see Figure 3.2.1, and the transposition of an interval and an circle, similar to the transposition P of two intervals in Figure 3.1.2.

A 2D TQFT for the open-closed category consists of a symmetric Frobenius algebra (B, tr_B) , which is the state space of an interval, and a commutative Frobenius algebra (C, tr_C) , describing the state space of a circle. These two Frobenius algebras are subject to the following interactions:

- (1) There exists a trace-respecting coalgebra homomorphism $j : B \rightarrow C$ (the *zipper homomorphism*), see Figure 3.2.1 left. Its dual is the *cozipper* map $j^* : C \rightarrow B$, see Figure 3.2.1 right. That j is a coalgebra homomorphism comes from diffeomorphisms (rel boundary) in the top row of Figure 3.2.2; j intertwines comultiplication and the counit maps of the two coalgebras. The dual (cozipper) map intertwines the two multiplications and takes the unit element of

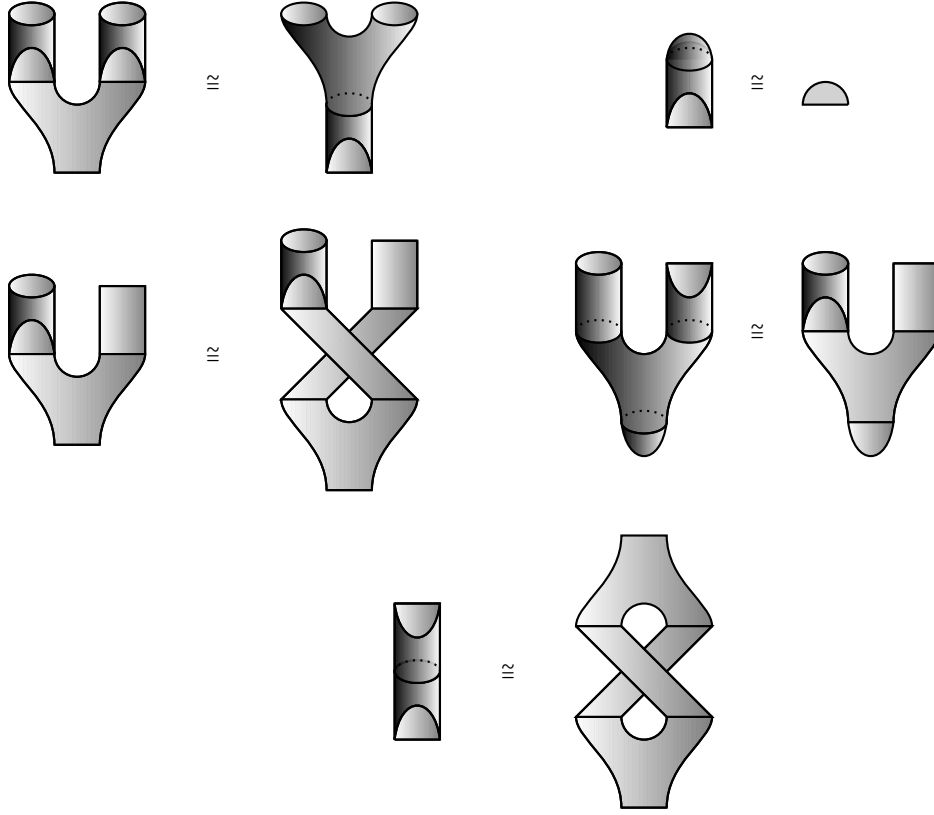

FIGURE 3.2.2. Defining relations in the category OCCob_2 that involve zipper and cozipper homomorphisms.

C to the unit element of B , thus it is an algebra homomorphism. These properties of j^* correspond to the relations given by rotating those in the top row of Figure 3.2.2 by 180° .

(2) Maps j, j^* are subject to

- The *knowledge* relation, shown on the left in the second row in 3.2.2,
- The duality between the zipper and the cozipper, shown on the right in the second row of 3.2.2,
- The Cardy condition, see the third row in 3.2.2.

REMARK 3.5. Lauda and Pfeiffer [LP08, LP09] view a cobordism as a morphism from the top boundary to the bottom boundary, while our convention is the opposite. They also denote a symmetric Frobenius algebra by A instead of our B , and zipper morphism by ι instead of j , so that, for instance, the zipper morphism is $C \xrightarrow{\iota} A$ in [LP08, LP09] and $B \xrightarrow{j} C$ in the present paper.

Such pairs (B, C) are called *knowledgeable Frobenius algebras*, see [LP09, Definition 2.2]. Examples of many such pairs in the literature are build from a *strongly separable* symmetric Frobenius algebra B . An algebra is called strongly separable if the trace form $(a, b)_\ell = \text{tr}_A(L_a \circ L_b)$ is non-degenerate, where L_a is the operator $A \rightarrow A$ of left multiplication by a .

A strongly separable symmetric Frobenius algebra B extends to a knowledgeable Frobenius algebra (B, C) by taking $C = Z(A)$ to be the center of A , see [LP07, LP09]. A strongly separable algebra is necessarily semisimple.

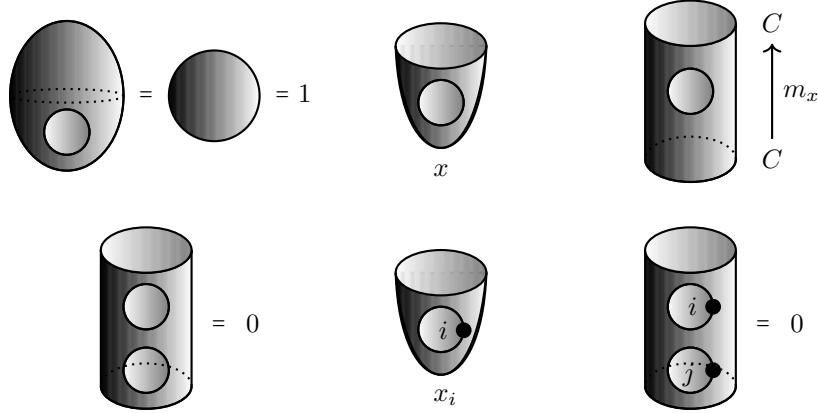

FIGURE 3.2.3. Top row, left to right: evaluation of a one-holed sphere; element $x \in C$ is given by one-holed disk; endomorphism $m_x(c) = xc$ of multiplication by x . Bottom row, left to right: $x^2 = 0$ (cobordism for x^2 contains the cobordism in the center of Figure 3.1.14 as a subcobordism), element $x_i \in C$, products $x_i x_j = 0$.

EXAMPLE 3.6. Consider the thin surface TQFT and the Frobenius algebra B in Examples 3.3, 3.4. One can look to extend this open TQFT F to an open-closed TQFT (to a knowledgeable Frobenius algebra (B, C)). Then the commutative Frobenius algebra C associated to a circle should have a distinguished element $x \in C$, $x = j(1_B)$ shown in Figure 3.2.3 in the top row and given by a cup with a hole in it. It is the image of the identity element 1_B of B under the zipper map j . The trace $\text{tr}_C(x) = 1$ since a dotless disk evaluates to 1, so that $x \neq 0 \in C$. On the other hand, $x^2 = 0$ since the corresponding cobordism contains a subsurface shown in the middle of the second row in Figure 3.1.14, which evaluates to 0. Thus, C contains a subalgebra $\mathbf{k}[x]/(x^2)$.

More generally, C contains elements $x_i = j(g^i)$, $i \in \mathbb{Z}/p$, with $x = x_0$, see Figure 3.2.3 bottom row. We have

$$(79) \quad x_i x_j = 0, \quad i, j \in \mathbb{Z}/p, \quad \Delta_C(x_i) = \sum_{k=0}^{p-1} x_{i+k} \otimes x_{p-k}, \quad \text{tr}_C(x_i) = \delta_{i,0}, \quad j^*(x_i) = 0, \quad i \in \mathbb{Z}/p.$$

These elements (or their linear combinations) may potentially be 0 for $i \neq 0$. The trace on C must be nondegenerate, pairwise products of x_i 's are 0 and $\text{tr}_C(x_i) = 0$ for $i \neq 0$. To avoid introducing more generators for C , we further assume that $x_i = 0$ for $i \neq 0$ and look to complete B to a knowledgeable Frobenius algebra (B, C) with $C \cong \mathbf{k}[x]/(x^2)$. Then the zipper and the cozipper maps are

$$\begin{aligned} j: B &\longrightarrow C, & j(g^i) &= 0, \quad i \neq 0 \in \mathbb{Z}/p, & j(1_B) &= x, & \text{im}(j) &= \mathbf{k}x, \\ j^*: C &\longrightarrow B, & j^*(1_C) &= 1_B, & j^*(x) &= 0, & \text{im}(j^*) &= \mathbf{k}1. \end{aligned}$$

with $j^*j = 0$, map j a coalgebra homomorphism and j^* an algebra homomorphism. Each individual map j, j^* is nonzero but has a one-dimensional image. To define the trace on C , pick a parameter $\lambda \in \mathbf{k}$:

$$(80) \quad \text{tr}_C(1) = \lambda, \quad \text{tr}_C(x) = 1.$$

The multiplication ($x^2 = 0$) and trace on C determine the comultiplication

$$(81) \quad \Delta_C(1) = 1 \otimes x + x \otimes 1 - \lambda x \otimes x, \quad \Delta_C(x) = x \otimes x.$$

The remaining open-closed TQFT relations, as shown in Figure 3.2.2, are straightforward to check.

In this knowledgeable Frobenius algebra, both B and C are nonsemisimple algebras. The handle (or punctured torus) element of C equals $m_C \circ \Delta_C(1) = 2x$, and a closed surface of genus g evaluates to $\alpha_{0,g}$, where

$$(82) \quad \alpha_{0,0} = \lambda, \quad \alpha_{0,1} = 2, \quad \alpha_{0,g} = 0 \text{ for } g > 1$$

(recall that the coefficients belong to a field \mathbf{k} of characteristic p). Evaluation $\alpha_{m,g}$ of a connected surface of genus g with m side boundary circles is

$$(83) \quad \alpha_{1,0} = 1, \quad \alpha_{m,g} = 0 \text{ if } m > 0 \text{ and } g \neq 0.$$

Thus, in this evaluation, at most three coefficients: $\alpha_{0,0}, \alpha_{0,1}, \alpha_{1,0}$ are nonzero.

More generally, $j^*j = 0$ if and only if $\alpha_{m,g} = 0$ for all $m \geq 1, g \geq 1$ and $m \geq 2, g \geq 0$.

Example 3.7 in [LP09] is somewhat similar to the present example, with the algebra B isomorphic to the one above (and $\text{char}(\mathbf{k}) = p$), algebra $C = \mathbf{k}[x]/(x^2 - ht - t)$ two-dimensional and nonsemisimple when parameters h, t satisfy $h^2 = 4t$, but with different zipper and trace maps. In particular, $j^*j \neq 0$ in that example ($\iota \iota^* \neq 0$ in the notations of [LP09]).

In the above example of a knowledgeable Frobenius pair (B, C) both B and C are nonsemisimple and the maps β_B and $F_B(\beta_3)$, see (74) and (75), are zero, so that $j^*j = 0$.

Frobenius algebras that appear in link homology and categorification are typically nonsemisimple, which creates an obstacle to merging link homology with open-closed 2D TQFTs, where a vast majority of examples is built from semisimple Frobenius algebras. This obstruction is discussed in [LP09] and [Cap13]. One well-known way out of this is a functorial extension of link homology to tangles [Kho02] and then to tangle cobordisms [Kho06, BN05].

This discrepancy between semisimple Frobenius algebras common in open-closed TQFTs in dimension two and rather special nonsemisimple Frobenius algebras that give rise to link cobordism TQFTs in dimension four and categorification of quantum invariants is an interesting phenomenon that is not fully understood.

Combining a symmetric Frobenius algebra with the universal construction for closed surfaces. Even when symmetric Frobenius B does not extend to a knowledgeable Frobenius (B, C) it is possible to extend B to a functor from OCCob_2 to the category of vector spaces but with a weaker axioms than that of a TQFT. This can be achieved by combining the Frobenius structure (B, tr_B) with the universal construction.

Symmetric Frobenius algebra (B, tr_B) gives a thin flat surface TQFT. In particular, it evaluates any connected oriented surface $S_{n,g}$ with $n \geq 1$ boundary components and g handles to a number $\alpha_{B,n,g} \in \mathbf{k}$. This number can be computed by viewing the surface as an endomorphism of the identity object 0 of TCob_2 and computing the element of \mathbf{k} it goes to under the functor F_B . Alternatively, one can use the surgery relation in Figure 3.1.8 and other relations in Figures 3.1.8, 3.1.6.

Doing the universal construction in the modification of TCob_2 where side boundaries are decorated by generators of B results in the TQFT F_B .

To extend to all oriented surfaces, we choose an evaluation $\alpha_{0,g} \in \mathbf{k}$ of a closed oriented surface of genus g for all $g \geq 0$. It is convenient to require that the generating function

$$(84) \quad Z_0(T) := \sum_{g \geq 0} \alpha_{0,g} T^g$$

is rational. With this additional choice evaluations of all surfaces $S_{n,g}$, $n, g \geq 0$ of genus g with n boundary circles are defined.

The universal construction can be applied to the category OCCob_2 of open-closed cobordisms. To get a better match with state spaces build from (B, tr_B) for cobordisms that have corners, it is convenient to pick a set W of generators of B and allow these generators to float on side boundaries of cobordisms. One obtains a minor modification, denoted $\text{OCCob}_2(W)$ of the category OCCob_2 .

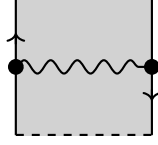

FIGURE 3.2.4. A line defect connecting two boundary points can be labelled by an element of $\text{End}_{\mathbf{k}}(B)$.

Endomorphisms of the 0 object of OCCob_2 that come from surfaces with decorated side boundaries are then evaluated via (B, tr_B) while evaluations of closed surfaces are encoded in the generating function (84).

Let us do the universal construction for $\text{OCCob}_2(W)$ evaluating surfaces with side boundary their possible W -decorations via (B, tr_B) and closed surfaces via coefficients of (84). The resulting category and a functor is an extension of the thin surface TQFT associated with (B, tr_B) . Objects of $\text{OCCob}_2(W)$ are finite unions $I^{\sqcup k} \sqcup (\mathbb{S}^1)^{\sqcup m}$ of intervals and circles. Denote the state space of that one-manifold by $A(k, m)$. Then the surgery formula still applies near each interval component, and the state space simplifies via the isomorphism

$$(85) \quad A(k, m) \cong B^{\otimes k} \otimes A(0, m).$$

That is, the state space is isomorphic to the tensor product of B 's, one for each interval, and the state space of m circles. The latter state space contains a subquotient isomorphic to the state space of m circles in the closed 2D topological theory with the generating function (84), as studied in [Kho20b, KS20, KOK22]. The state space $A(0, m)$ may be strictly bigger than the latter state space, due to the presence of surfaces that bound m circles at the top but have side circles (such surfaces can be viewed as morphisms in $\text{OCCob}_2(W)$ from the identity object 0 to m circles).

This universal construction based on (B, tr_B) and rational power series (84) occupies an intermediate position between open-closed TQFTs and the more general universal construction for surfaces with boundary and corners studied in [KQR21]. In the present case (B, tr_B) allows to evaluate surfaces of all genera with at least one side boundary circle and produce a TQFT (as long as we add additional observables on the boundary lines for generators of B) for these surfaces, then extend to cobordisms that may have top and bottom boundary circles and closed surfaces via (84). Without enlarging OCCob_2 to $\text{OCCob}_2(W)$ the resulting state space of the union of k intervals could be only a subspace of $B^{\otimes k}$.

REMARK 3.7. Going back to the category TCob_2 of thin flat surfaces, one can further introduce one-dimensional interval defects that connect two points on the boundary of a surface. These defects are labelled by endomorphisms of B (by \mathbf{k} -linear maps $B \rightarrow B$), see Figure 3.2.4.

REMARK 3.8. Categorifications of the Heisenberg algebra come from the study of natural transformations on compositions of the induction and restriction functors between symmetric groups or Hecke algebras [Kho14, LS13]. More general categorifications of the Heisenberg algebra [BSW22, Sav19, RS17, BSW21] add elements of a Frobenius algebra as decorations on strands of diagrams in those graphical calculi. The neck-cutting formula in Figure 3.1.8 on the left is called *the Frobenius skein relation* in that case and is referred to as *teleportation* in [BSW22].

A symmetric Frobenius algebra gives a TQFT for thin flat surfaces (two-dimensional objects), which is one of the indications that various Heisenberg algebra categorifications should admit reformulations via a suitable graphical calculus of foam-like objects in \mathbb{R}^3 rather than graphs (or intersecting decorated lines) in \mathbb{R}^2 .

4. Embeddings into a 1D TQFT and dimensional lifting

Embeddings into a 1D TQFT: semisimplicity restriction. It is natural to ask under what conditions on \mathcal{K} and the trace $\mathrm{tr}_{\mathcal{K}}$ is the corresponding one-dimensional theory of arcs with \mathcal{K} -defects and the circle evaluation given by $\mathrm{tr}_{\mathcal{K}}$ embeddable into a one-dimensional TQFT. Oriented 1D TQFTs are described by finite-dimensional vector spaces V , with the state space of $+-$ oriented 0-manifold isomorphic to $V \otimes V^*$. When viewed as an algebra under the composition in Figure 2.4.6 it is naturally isomorphic to the endomorphism or the matrix algebra $\mathrm{End}_{\mathbf{k}}(V) \cong M_n(\mathbf{k})$.

Suppose given a symmetric Frobenius algebra (B, tr_B) . It gives rise to the category of arcs with B -defects and circles evaluated via tr_B and the negligible quotient of that category. A monoidal functor from either of these two categories into a 1D TQFT given by V is described by a homomorphism of algebras $\phi : B \rightarrow M_n(\mathbf{k})$ that converts trace tr_B to the usual trace on the matrix algebra $M_n(\mathbf{k})$, that is $\mathrm{tr}(\phi(a)) = \mathrm{tr}_B(a)$, $\forall a \in B$. That is, ϕ must intertwine the two traces. Then ϕ is necessarily an inclusion and $\mathrm{tr}_B(1) = n = \dim(V)$.

Consider the Jacobson radical $J \subset B$. Then J is a two-sided nilpotent ideal, $J^n = 0$, and B/J is semisimple. Any element $x \in J$ is nilpotent and $\phi(x)$ is a nilpotent matrix, so that $\mathrm{tr}(\phi(x)) = 0$. Consequently, $\mathrm{tr}_B(x) = 0$, for all elements x in the Jacobson radical. Nondegeneracy of tr_B implies that $J = 0$, so that B is semisimple, and we obtain the following result.

PROPOSITION 4.1. A one-dimensional topological theory with B -labelled defects associated to (B, tr_B) can be embedded into a one-dimensional TQFT over \mathbf{k} -vect only if B is semisimple.

We see that tr_B can come from a trace on a matrix algebra in the above way only if B is a semisimple \mathbf{k} -algebra, while in applications (for instance, to link homology) we most often encounter cases when B is not semisimple.

Furthermore, assuming that B is semisimple, only few traces on B correspond to embeddings into one-dimensional TQFTs. Namely, $B \cong \prod_{i=1}^k \mathrm{Mat}_{n_i}(D_i)$ is then isomorphic to the product of matrix algebras over finite-dimensional division rings D_i over F and representation V has the form $V \cong \bigoplus_{i=1}^k V_i$, where

$$(86) \quad V_i \cong (D_i^{n_i})^{r_i}$$

is the sum of r_i copies of the column representation $D_i^{n_i}$ of the matrix algebra $\mathrm{Mat}_{n_i}(D_i)$. Under this isomorphism,

$$(87) \quad \mathrm{tr}_B = \sum_{i=1}^k r_i \mathrm{tr}_i,$$

where tr_i is the trace on $\mathrm{Mat}_{n_i}(D_i)$ with values in \mathbf{k} which is the composition of the matrix algebra trace and the map $\mathrm{tr}'_i : D_i \rightarrow \mathbf{k}$ which is the trace of left multiplication in D_i viewed as a \mathbf{k} -vector space.

For example, suppose that the division ring D_i is commutative, thus it is a field F such that $\mathbf{k} \subset F$ is a finite extension and that $n_i = 1$. Any non-zero \mathbf{k} -linear map $\varepsilon : F \rightarrow \mathbf{k}$ turns F into a commutative Frobenius \mathbf{k} -algebra, but only the trace map $\mathrm{tr}_{\mathbf{k}} : F \rightarrow \mathbf{k}$ and its multiples $r \mathrm{tr}_{\mathbf{k}}$, $r \in \mathbb{N}$ (further assuming that F/\mathbf{k} is separable) come from embeddings into a 1D TQFT.

Dimensional liftings. We see that trace-preserving embeddings of symmetric Frobenius algebras into matrix algebras are scarce. At the same time, a symmetric Frobenius algebra (B, tr_B) gives rise to a 2D TQFT for thin surfaces as explained earlier. A one-dimensional TQFT with defects α produces a two-dimensional TQFT, restricted to thin surfaces, via the symmetric Frobenius algebra $(\mathcal{K}, \mathrm{tr}_{\mathcal{K}})$. This dimensional lifting from one to two dimension can be very loosely compared to the Drinfeld center of a monoidal category (and the Drinfeld double of a Hopf algebra). Monoidal categories are naturally two-dimensional structures, with morphisms often represented by planar diagram. The Drinfeld center of a monoidal category is a braided monoidal category, providing invariants of braids

and lifting the structure one dimension up, from two to three dimensions. Likewise, the Drinfeld double of a Hopf algebra converts a two-dimensional structure (the category of representations of a Hopf algebra is monoidal) to a three-dimensional structure (a quasitriangular Hopf algebra, with the category of representations being a braided monoidal category).

The graphical nature of a monoidal category \mathcal{C} is that of planar networks of morphisms between tensor products of objects of \mathcal{C} . Such planar networks can be thought of as defects in the two-dimensional theory of the underlying plane \mathbb{R}^2 . Drinfeld’s center and doubling constructions lift these “two-dimensional theories with defects” to three-dimensional theories.

Of course, the above discussion and comparison of dimensional liftings is highly informal.

References

- [BHMV95] Christian Blanchet, Nathan Habegger, Gregor Masbaum, and Pierre Vogel, *Topological quantum field theories derived from the Kauffman bracket*, *Topology* **34** (1995), no. 4, 883–927, [https://doi.org/10.1016/0040-9383\(94\)00051-4](https://doi.org/10.1016/0040-9383(94)00051-4).
- [BN05] Dror Bar-Natan, *Khovanov’s homology for tangles and cobordisms*, *Geom. Topol.* **9** (2005), 1443–1499.
- [BR90] Jean Berstel and Christophe Reutenauer, *Zeta functions of formal languages*, *Trans. Amer. Math. Soc.* **321** (1990), no. 2, 533–546, <https://doi.org/10.2307/2001573>.
- [BSW21] Jonathan Brundan, Alistair Savage, and Ben Webster, *Foundations of Frobenius Heisenberg categories*, *J. Algebra* **578** (2021), 115–185.
- [BSW22] ———, *Quantum Frobenius Heisenberg categorification*, *J. Pure Appl. Algebra* **226** (2022), no. 1, Paper No. 106792, 50.
- [Cap13] Carmen Caprau, *Twin TQFTs with Frobenius algebras*, *J. Math.* (2013), Art. ID 407068, 25.
- [GIK⁺23] Paul Gustafson, Mee Seong Im, Remy Kaldawy, Mikhail Khovanov, and Zachary Lihn, *Automata and one-dimensional TQFTs with defects*, arXiv preprint [arXiv:2301.00700](https://arxiv.org/abs/2301.00700) (2023), 1–36.
- [IK22] Mee Seong Im and Mikhail Khovanov, *Topological theories and automata*, arXiv preprint [arXiv:2202.13398](https://arxiv.org/abs/2202.13398) (2022), 1–70.
- [IKO23] Mee Seong Im, Mikhail Khovanov, and Victor Ostrik, *Universal construction in monoidal and non-monoidal settings, the Brauer envelope, and pseudocharacters*, arXiv preprint [arXiv:2303.02696](https://arxiv.org/abs/2303.02696) (2023), 1–59.
- [IZ22] Mee Seong Im and Paul Zimmer, *One-dimensional topological theories with defects and linear generating functions*, *Involve* **15** (2022), no. 2, 319–331.
- [Kho02] Mikhail Khovanov, *A functor-valued invariant of tangles*, *Algebr. Geom. Topol.* **2** (2002), 665–741.
- [Kho04] ———, *$\mathfrak{sl}(3)$ link homology*, *Algebr. Geom. Topol.* **4** (2004), 1045–1081, [arXiv:math/0304375](https://arxiv.org/abs/math/0304375).
- [Kho06] ———, *An invariant of tangle cobordisms*, *Trans. Amer. Math. Soc.* **358** (2006), no. 1, 315–327.
- [Kho14] ———, *Heisenberg algebra and a graphical calculus*, *Fund. Math.* **225** (2014), no. 1, 169–210.
- [Kho20a] ———, *Decorated one-dimensional cobordisms and tensor envelopes of noncommutative recognizable power series*, arXiv preprint [arXiv:2010.05730](https://arxiv.org/abs/2010.05730) (2020), 1–33.
- [Kho20b] ———, *Universal construction of topological theories in two dimensions*, arXiv preprint [arXiv:2007.03361](https://arxiv.org/abs/2007.03361) (2020), 1–56.
- [KK20] Mikhail Khovanov and Nitu Kitchloo, *A deformation of Robert-Wagner foam evaluation and link homology*, arXiv preprint [arXiv:2004.14197](https://arxiv.org/abs/2004.14197) (2020), 1–58.
- [KOK22] Mikhail Khovanov, Victor Ostrik, and Yakov Kononov, *Two-dimensional topological theories, rational functions and their tensor envelopes*, *Selecta Math. (N.S.)* **28** (2022), no. 4, Paper No. 71, 68.
- [KQ20] Mikhail Khovanov and You Qi, *Introduction to categorification: Section 2, Topological Quantum Field Theories*, Lecture notes: *Cob_n and n-d TQFT* (2020), 1–22.
- [KQR21] Mikhail Khovanov, You Qi, and Lev Rozansky, *Evaluating thin flat surfaces*, *Comm. Math. Phys.* **385** (2021), no. 3, 1835–1870, <https://doi.org/10.1007/s00220-021-04011-3>.
- [KS20] Mikhail Khovanov and Radmila Sazdanovic, *Bilinear pairings on two-dimensional cobordisms and generalizations of the Deligne category*, arXiv preprint [arXiv:2007.11640](https://arxiv.org/abs/2007.11640) (2020), 1–15.
- [KS21] ———, *Diagrammatic categorification of the Chebyshev polynomials of the second kind*, *J. Pure Appl. Algebra* **225** (2021), no. 6, Paper No. 106592, 23, <https://doi.org/10.1016/j.jpaa.2020.106592>.
- [Lau05] Aaron Lauda, *Frobenius algebras and planar open string topological field theories*, arXiv preprint [arXiv:math/0508349](https://arxiv.org/abs/math/0508349) (2005), 1–66.
- [Lau06] ———, *Open-Closed Topological Quantum Field Theory and Tangle Homology*, Ph.D. thesis, University of Cambridge, 2006, pp. 1–169.
- [Laz01] Calin Iuliu Lazaroiu, *On the structure of open-closed topological field theory in two dimensions*, *Nuclear Phys. B* **603** (2001), no. 3, 497–530.

- [LP07] Aaron D. Lauda and Hendryk Pfeiffer, *State sum construction of two-dimensional open-closed topological quantum field theories*, *J. Knot Theory Ramifications* **16** (2007), no. 9, 1121–1163.
- [LP08] ———, *Open-closed strings: two-dimensional extended TQFTs and Frobenius algebras*, *Topology Appl.* **155** (2008), no. 7, 623–666.
- [LP09] ———, *Open-closed TQFTS extend Khovanov homology from links to tangles*, *J. Knot Theory Ramifications* **18** (2009), no. 1, 87–150.
- [LS13] Anthony Licata and Alistair Savage, *Hecke algebras, finite general linear groups, and Heisenberg categorification*, *Quantum Topol.* **4** (2013), no. 2, 125–185.
- [Mei21] Ehud Meir, *Interpolations of monoidal categories and algebraic structures by invariant theory*, arXiv preprint [arXiv:2105.04622](https://arxiv.org/abs/2105.04622) (2021), 1–31.
- [MS06] Gregory W. Moore and Graeme Segal, *D-branes and K-theory in 2D topological field theory*, arXiv preprint [arXiv:hep-th/0609042](https://arxiv.org/abs/hep-th/0609042) (2006), 1–88.
- [MS22] Alexandra McSween and Alistair Savage, *Affine oriented Frobenius Brauer categories*, *Communications in Algebra* **0** (2022), no. 0, 1–15.
- [MV07] Marco Mackaay and Pedro Vaz, *The universal \mathfrak{sl}_3 -link homology*, *Algebr. Geom. Topol.* **7** (2007), 1135–1169, <https://doi.org/10.2140/agt.2007.7.1135>.
- [RRV99] Vladimir Retakh, Christophe Reutenauer, and Arkady Vaintrob, *Noncommutative rational functions and Farber’s invariants of boundary links*, *Differential topology, infinite-dimensional Lie algebras, and applications*, *Amer. Math. Soc. Transl. Ser. 2*, vol. 194, Amer. Math. Soc., Providence, RI, 1999, pp. 237–246.
- [RS17] Daniele Rosso and Alistair Savage, *A general approach to Heisenberg categorification via wreath product algebras*, *Math. Z.* **286** (2017), no. 1-2, 603–655.
- [RW20] Louis-Hadrien Robert and Emmanuel Wagner, *A closed formula for the evaluation of foams*, *Quantum Topol.* **11** (2020), no. 3, 411–487, <https://doi.org/10.4171/qt/139>.
- [Sav19] Alistair Savage, *Frobenius Heisenberg categorification*, *Algebr. Comb.* **2** (2019), no. 5, 937–967.
- [Sav21] ———, *Affine oriented Frobenius Brauer categories*, [Presentation Slides](#) (2021), 1–33.
- [SS22] Saima Samchuck-Schnarch, *Frobenius Brauer Categories*, [uOttawa Research](#) (2022), 1–107, PhD Thesis, University of Ottawa.

DEPARTMENT OF MATHEMATICS, UNITED STATES NAVAL ACADEMY, ANNAPOLIS, MD 21402, USA
Email address: meeseongim@gmail.com

DEPARTMENT OF MATHEMATICS, COLUMBIA UNIVERSITY, NEW YORK, NY 10027, USA
Email address: khovanov@math.columbia.edu