

FINITE PRESENTATIONS FOR THE BALANCED SUPERELLIPTIC MAPPING CLASS GROUPS

SUSUMU HIROSE AND GENKI OMORI

ABSTRACT. The balanced superelliptic mapping class group is the normalizer of the transformation group of the balanced superelliptic covering space in the mapping class group of the total surface. We give finite presentations for the balanced superelliptic mapping class groups of closed surfaces, surfaces with one marked point, and surfaces with one boundary component. To give these presentations, we construct finite presentations for corresponding liftable mapping class groups in a different generating set from Ghaswala-Winarski's presentation in [9].

1. INTRODUCTION

Let Σ_g be a connected closed oriented surface of genus $g \geq 0$. For integers $n \geq 1$ and $k \geq 2$ with $g = n(k-1)$, the *balanced superelliptic covering map* $p = p_{g,k}: \Sigma_g \rightarrow \Sigma_0$ is a branched covering map with $2n+2$ branch points $p_1, p_2, \dots, p_{2n+2} \in \Sigma_0$, their unique preimages $\tilde{p}_1, \tilde{p}_2, \dots, \tilde{p}_{2n+2} \in \Sigma_g$, and the covering transformation group generated by the *balanced superelliptic rotation* $\zeta = \zeta_{g,k}$ of order k (precisely defined in Section 2.1 and see Figure 1). When $k = 2$, $\zeta = \zeta_{g,2}$ coincides with the hyperelliptic involution, and for $k \geq 3$, the balanced superelliptic covering space was introduced by Ghaswala and Winarski [10].

For subsets A and B of Σ_g ($g \geq 0$), the *mapping class group* $\text{Mod}(\Sigma_g; A, B)$ of the tuple (Σ_g, A, B) is the group of isotopy classes of orientation-preserving self-homeomorphisms on Σ_g which preserve A setwise and B pointwise. Put $\mathcal{B} = \{p_1, p_2, \dots, p_{2n+2}\} \subset \Sigma_0$ and we denote by D a disk neighborhood of p_{2n+2} in $\Sigma_0 - \mathcal{B}$, by \tilde{D} the preimage of D with respect to p , and by Σ_g^1 (resp. Σ_0^1) the complement of the interior of \tilde{D} (resp. D) in Σ_g (resp. Σ_0). Under the situation above, we define

$$\text{Mod}_{0,2n+2} = \text{Mod}(\Sigma_0; \mathcal{B}, \emptyset), \quad \text{Mod}_{0,2n+2;*} = \text{Mod}(\Sigma_0; \mathcal{B} - \{p_{2n+2}\}, \{p_{2n+2}\}),$$

$$\text{Mod}_{0,2n+1}^1 = \text{Mod}(\Sigma_0^1; \mathcal{B} - \{p_{2n+2}\}, \partial\Sigma_0^1),$$

and for $g \geq 1$,

$$\text{Mod}_g = \text{Mod}(\Sigma_g; \emptyset, \emptyset), \quad \text{Mod}_{g,*} = \text{Mod}(\Sigma_g; \emptyset, \{\tilde{p}_{2n+2}\}), \text{ and}$$

$$\text{Mod}_g^1 = \text{Mod}(\Sigma_g^1; \emptyset, \partial\Sigma_g^1).$$

We regard $\text{Mod}_{0,2n+2;*}$ as the subgroup of $\text{Mod}_{0,2n+2}$ which consists of elements preserving the point p_{2n+2} .

For $g = n(k-1) \geq 1$, an orientation-preserving self-homeomorphism φ on Σ_g (resp. on Σ_g^1 whose restriction to $\partial\Sigma_g^1$ is the identity map) is *symmetric* for $\zeta = \zeta_{g,k}$ if $\varphi \langle \zeta \rangle \varphi^{-1} = \langle \zeta \rangle$ (resp. $\varphi \langle \zeta|_{\Sigma_g^1} \rangle \varphi^{-1} = \langle \zeta|_{\Sigma_g^1} \rangle$). We abuse notation and denote simply $\zeta|_{\Sigma_g^1} = \zeta$. The *balanced superelliptic mapping class group* (or the *symmetric mapping class group*) $\text{SMod}_{g;k}$ (resp. $\text{SMod}_{g,*;k}$ and $\text{SMod}_{g;k}^1$) is the subgroup of

Date: June 7, 2022.

2010 Mathematics Subject Classification. 57S05, 57M07, 57M05, 20F05.

Mod_g (resp. $\text{Mod}_{g,*}$ and Mod_g^1) which consists of elements represented by symmetric homeomorphisms. Ghaswala and McLeay [7] showed that any element in $\text{SMod}_{g;k}^1$ are represented by a homeomorphism which commutes with ζ . Birman and Hilden [4] showed that $\text{SMod}_{g;k}$ (resp. $\text{SMod}_{g,*;k}$ and $\text{SMod}_{g;k}^1$) coincides with the group of symmetric isotopy classes of symmetric homeomorphisms on Σ_g (resp. $(\Sigma_g, \tilde{p}_{2n+2})$ and Σ_g^1).

An orientation-preserving self-homeomorphism φ on Σ_0 (resp. on Σ_0^1 whose restriction to $\partial\Sigma_0^1$ is the identity map) is *liftable* with respect to $p = p_{g,k}$ if there exists an orientation-preserving self-homeomorphism $\tilde{\varphi}$ on Σ_g (resp. on Σ_g^1 whose restriction to $\partial\Sigma_g^1$ is the identity map) such that $p \circ \tilde{\varphi} = \varphi \circ p$ (resp. $p|_{\Sigma_g^1} \circ \tilde{\varphi} = \varphi \circ p|_{\Sigma_g^1}$), namely, the following diagrams commute:

$$\begin{array}{ccc} \Sigma_g & \xrightarrow{\tilde{\varphi}} & \Sigma_g \\ p \downarrow & \circlearrowleft & \downarrow p \\ \Sigma_0 & \xrightarrow{\varphi} & \Sigma_0, \end{array} \quad \begin{array}{ccc} \Sigma_g^1 & \xrightarrow{\tilde{\varphi}} & \Sigma_g^1 \\ p|_{\Sigma_g^1} \downarrow & \circlearrowleft & \downarrow p|_{\Sigma_g^1} \\ \Sigma_0^1 & \xrightarrow{\varphi} & \Sigma_0^1. \end{array}$$

We also abuse notation and denote simply $p|_{\Sigma_g^1} = p$. The *liftable mapping class group* $\text{LMod}_{2n+2;k}$ (resp. $\text{LMod}_{2n+2,*;k}$ and $\text{LMod}_{2n+1;k}^1$) is the subgroup of $\text{Mod}_{0,2n+2}$ (resp. $\text{Mod}_{0,2n+2,*}$ and $\text{Mod}_{0,2n+1}^1$) which consists of elements represented by liftable homeomorphisms for $p_{g,k}$. Birman and Hilden [3] proved that $\text{LMod}_{2n+1;k}^1$ is isomorphic to $\text{SMod}_{g;k}^1$ and $\text{LMod}_{2n+2;k}$ is isomorphic to the quotient of $\text{SMod}_{g;k}$ by $\langle \zeta_{g,k} \rangle$. By Proposition 4.7, we also show that $\text{LMod}_{2n+2,*;k}$ is isomorphic to the quotient of $\text{SMod}_{g,*;k}$ by $\langle \zeta_{g,k} \rangle$.

When $k = 2$, $\zeta = \zeta_{g,2}$ is the hyperelliptic involution and corresponding symmetric mapping class groups are called the hyperelliptic mapping class groups. In this case, $\text{LMod}_{2n+2;2}$ (resp. $\text{LMod}_{2n+2,*;2}$ and $\text{LMod}_{2n+1;2}^1$) is equal to $\text{Mod}_{0,2n+2}$ (resp. $\text{Mod}_{0,2n+2,*}$ and $\text{Mod}_{0,2n+1}^1$) and a finite presentation for $\text{SMod}_{g;2}$ was given by Birman and Hilden [2].

When $k \geq 3$, in Lemma 3.6 of [9], Ghaswala and Winarski gave a necessary and sufficient condition for lifting a homeomorphism on Σ_0 with respect to $p_{g,k}$ (see also Lemma 2.1). By their necessary and sufficient condition, we see that the liftability of a self-homeomorphism on (Σ_0, \mathcal{B}) or $(\Sigma_0^1, \mathcal{B} - \{p_{2n+2}\})$ does not depend on $k \geq 3$ (the liftability depends on only the action on \mathcal{B}). Hence we omit “ k ” in the notation of the liftable mapping class groups for $k \geq 3$ (i.e. we express $\text{LMod}_{2n+2;k} = \text{LMod}_{2n+2}$, $\text{LMod}_{2n+2,*;k} = \text{LMod}_{2n+2,*}$, and $\text{LMod}_{2n+1;k}^1 = \text{LMod}_{2n+1}^1$ for $k \geq 3$). Ghaswala and Winarski constructed a finite presentation for LMod_{2n+2} and calculated the integral first homology group of LMod_{2n+2} ¹.

In this paper, we give another finite presentation for LMod_{2n+2} in a different generating set from Ghaswala-Winarski’s presentation in [9] and finite presentations for the groups $\text{LMod}_{2n+2,*}$, LMod_{2n+1}^1 , $\text{SMod}_{g;k}$, $\text{SMod}_{g,*;k}$, and $\text{SMod}_{g;k}^1$ (Theorems 5.1, 5.2, 5.3, 6.10, 6.11, and 6.12), and calculate their integral first homology groups. The integral first homology group $H_1(G)$ of a group G is isomorphic to the abelianization of G . Put $\mathbb{Z}_l = \mathbb{Z}/l\mathbb{Z}$ for an integer $l \geq 2$. The results about the integral first homology groups of the liftable mapping class groups and the balanced superelliptic mapping class groups are as follows:

Theorem 1.1. *For $n \geq 1$,*

¹The calculation of the first homology group in [9] includes a mistake. The error was corrected in [8]

$$\begin{aligned}
(1) \quad H_1(\text{LMod}_{2n+2}) &\cong \begin{cases} \mathbb{Z} \oplus \mathbb{Z}_2 \oplus \mathbb{Z}_2 & \text{if } n \text{ is odd,} \\ \mathbb{Z} \oplus \mathbb{Z}_2 & \text{if } n \text{ is even,} \end{cases} \\
(2) \quad H_1(\text{LMod}_{2n+2,*}) &\cong \begin{cases} \mathbb{Z} \oplus \mathbb{Z}_2 & \text{if } n = 1, \\ \mathbb{Z}^2 \oplus \mathbb{Z}_n & \text{if } n \geq 2 \text{ is even,} \\ \mathbb{Z}^2 \oplus \mathbb{Z}_{2n} & \text{if } n \geq 3 \text{ is odd,} \end{cases} \\
(3) \quad H_1(\text{LMod}_{2n+1}^1) &\cong \begin{cases} \mathbb{Z}^2 & \text{if } n = 1, \\ \mathbb{Z}^3 & \text{if } n \geq 2. \end{cases}
\end{aligned}$$

We remark that Theorem 1.1 for LMod_{2n+2} was given by Theorem 1.1 in [8].

Theorem 1.2. For $n \geq 1$ and $k \geq 3$ with $g = n(k-1)$,

$$\begin{aligned}
(1) \quad H_1(\text{SMod}_{g;k}) &\cong \begin{cases} \mathbb{Z} \oplus \mathbb{Z}_2 \oplus \mathbb{Z}_2 & \text{if } n \geq 1 \text{ is odd and } k \text{ is odd,} \\ \mathbb{Z} \oplus \mathbb{Z}_2 \oplus \mathbb{Z}_4 & \text{if } n \geq 1 \text{ is odd and } k \text{ is even,} \\ \mathbb{Z} \oplus \mathbb{Z}_2 & \text{if } n \geq 2 \text{ is even,} \end{cases} \\
(2) \quad H_1(\text{SMod}_{g,*;k}) &\cong \begin{cases} \mathbb{Z} \oplus \mathbb{Z}_{2k} & \text{if } n = 1, \\ \mathbb{Z}^2 \oplus \mathbb{Z}_{kn} & \text{if } n \geq 2 \text{ is even,} \\ \mathbb{Z}^2 \oplus \mathbb{Z}_{2kn} & \text{if } n \geq 3 \text{ is odd,} \end{cases} \\
(3) \quad H_1(\text{SMod}_{g;k}^1) &\cong \begin{cases} \mathbb{Z}^2 & \text{if } n = 1, \\ \mathbb{Z}^3 & \text{if } n \geq 2. \end{cases}
\end{aligned}$$

The explicit generators of the first homology groups in Theorem 1.1 and 1.2 are given in their proof in Section 5.3 and 6.3. To give presentations for the liftable mapping class groups in Theorem 5.1, 5.2, and 5.3, we construct a new finite presentation for the pure mapping class group of a 2-sphere in Proposition 3.1. A finite presentation for the pure mapping class group of a 2-sphere was already given by Ghaswala and Winarski [9]. They used a finite presentation for the pure braid group by Margalit and McCammond [12] to construct the presentation for the pure mapping class group of a 2-sphere.

Contents of this paper are as follows. In Section 2, we review the definition of the balanced superelliptic covering map $p_{g,k}$ and Ghaswala-Winarski's necessary and sufficient condition for lifting a homeomorphism on Σ_0 with respect to $p_{g,k}$. We introduce some liftable homeomorphisms on Σ_0 for $p_{g,k}$ in Section 2.2 and review some relations among their liftable elements in Section 2.3. In Section 3, we give a new finite presentation for the pure mapping class group of a 2-sphere (Proposition 3.1). In Section 4, we observe the group structures of the groups $\text{LMod}_{2n+2,*}$, LMod_{2n+1}^1 , and $\text{SMod}_{g;k}^1$ via group extensions (Propositions 4.3, 4.5, and 4.10) and characterize $\text{SMod}_{g,*;k}$ as the image of the forgetful map $\mathcal{F}: \text{SMod}_{g,*;k} \rightarrow \text{SMod}_{g;k}$ (Proposition 4.7). In Section 5, we give finite presentations for the liftable mapping class groups (Theorem 5.1, 5.2, and 5.3) and calculate their integral first homology groups in Section 5.3. Finally, in Section 6, we give finite presentations for the balanced superelliptic mapping class groups (Theorem 6.10, 6.11, and 6.12) and calculate their integral first homology groups in Section 6.3. In Section 6.1, we construct explicit lifts of liftable homeomorphisms introduced in Section 2.2 with respect to $p_{g,k}$.

2. PRELIMINARIES

Throughout this paper, we assume that n is a positive integer.

2.1. The balanced superelliptic covering space. For an integer $k \geq 2$ with $g = n(k-1)$, we describe the surface Σ_g as follows. We take the unit 2-sphere $S^2 = S(1)$ in \mathbb{R}^3 and n mutually disjoint parallel copies $S(2), S(3), \dots, S(n+1)$

of $S(1)$ by translations along the x -axis such that

$$\max(S(i) \cap (\mathbb{R} \times \{0\} \times \{0\})) < \min(S(i+1) \cap (\mathbb{R} \times \{0\} \times \{0\}))$$

for $1 \leq i \leq n$ (see Figure 1). Let ζ be the $(-\frac{2\pi}{k})$ -rotation of \mathbb{R}^3 on the x -axis. Then we remove $2k$ disjoint open disks in $S(i)$ for $2 \leq i \leq n$ and k disjoint open disks in $S(i)$ for $i \in \{1, n+1\}$ which are setwisely preserved by the action of ζ , and connect k boundary components of the punctured $S(i)$ and ones of the punctured $S(i+1)$ by k annuli such that the union of the k annuli is preserved by the action of ζ for each $1 \leq i \leq n$ as in Figure 1. Since the union of the punctured $S(1) \cup S(2) \cup \dots \cup S(n+1)$ and the attached $n \times k$ annuli is homeomorphic to $\Sigma_{g=n(k-1)}$, we regard this union as Σ_g .

By the construction above, the action of ζ on \mathbb{R}^3 induces the action on Σ_g , the quotient space $\Sigma_g / \langle \zeta \rangle$ is homeomorphic to Σ_0 , and the quotient map $p = p_{g,k} : \Sigma_g \rightarrow \Sigma_0$ is a branched covering map with $2n+2$ branch points in Σ_0 . We call the branched covering map $p : \Sigma_g \rightarrow \Sigma_0$ the *balanced superelliptic covering map*. Denote by $\tilde{p}_1, \tilde{p}_2, \dots, \tilde{p}_{2n+2} \in \Sigma_g$ the fixed points of ζ such that $\tilde{p}_i < \tilde{p}_{i+1}$ in $\mathbb{R} \times \{0\} \times \{0\} = \mathbb{R}$ for $1 \leq i \leq 2n+1$, by $p_i \in \Sigma_0$ for $1 \leq i \leq 2n+2$ the image of \tilde{p}_i by p (i.e. $p_1, p_2, \dots, p_{2n+2} \in \Sigma_0$ are branch points of p), and by \mathcal{B} the set of the branch points $p_1, p_2, \dots, p_{2n+2}$. Let D be a 2-disk in $(\Sigma_0 - \mathcal{B}) \cup \{p_{2n+2}\}$ whose interior includes the point p_{2n+2} and \tilde{D} the preimage of D with respect to p . Denote by Σ_g^1 the complement of interior of \tilde{D} in Σ_g and by Σ_0^1 the complement of interior of D in Σ_0 . Then we also call the restriction $p|_{\Sigma_g^1} : \Sigma_g^1 \rightarrow \Sigma_0^1$ the balanced superelliptic covering map and we denote simply $p|_{\Sigma_g^1} = p$.

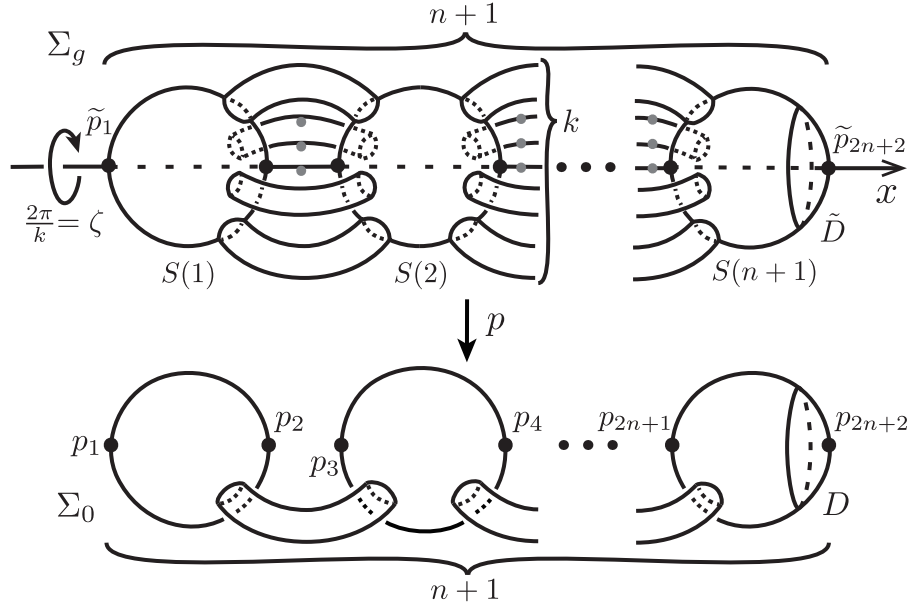

FIGURE 1. The balanced superelliptic covering map $p = p_{g,k} : \Sigma_g \rightarrow \Sigma_0$.

2.2. Lifiable elements for the balanced superelliptic covering map. In this section, we introduce some liftable homeomorphisms on Σ_0 for the balanced superelliptic covering map $p = p_{g,k}$ for $k \geq 3$. For maps or mapping classes f and g , the

product gf means that f apply first, and we often abuse notation and denote a homeomorphism and its isotopy class by the same symbol.

Let l_i ($1 \leq i \leq 2n+1$) be an oriented simple arc on Σ_0 whose endpoints are p_i and p_{i+1} as in Figure 2. Put $L = l_1 \cup l_2 \cup \dots \cup l_{2n+1}$, $L^1 = L \cap \Sigma_0^1$, and $\mathcal{B}^1 = \mathcal{B} - \{p_{2n+2}\}$. The isotopy class of a homeomorphism φ on Σ_0 (resp. Σ_0^1) relative to \mathcal{B} (resp. $\mathcal{B}^1 \cup \partial\Sigma_0^1$) is determined by the isotopy class of the image of L (resp. L^1) by φ relative to \mathcal{B} (resp. $\mathcal{B}^1 \cup \partial\Sigma_0^1$). We identify Σ_0 with the surface on the lower side in Figure 2 by some homeomorphism of Σ_0 .

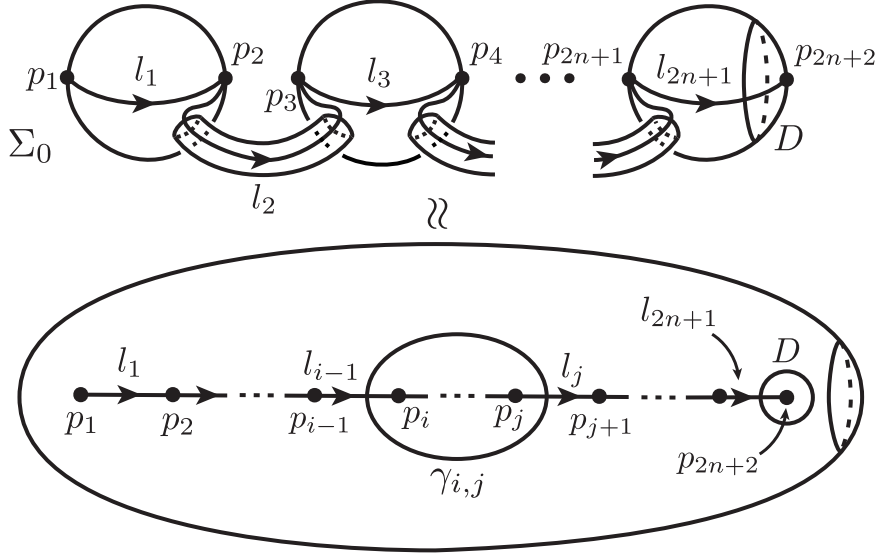

FIGURE 2. A natural homeomorphism of Σ_0 , arcs $l_1, l_2, \dots, l_{2n+1}$, and a simple closed curve $\gamma_{i,j}$ on Σ_0 for $1 \leq i < j \leq 2n+2$.

Let l be a simple arc on Σ_0 whose endpoints lie in \mathcal{B} . A regular neighborhood \mathcal{N} of l in Σ_0 is homeomorphic to a 2-disk. Then the half-twist $\sigma[l]$ is a self-homeomorphism on Σ_0 which is described as the result of anticlockwise half-rotation of l in \mathcal{N} as in Figure 3. We define $\sigma_i = \sigma[l_i]$ for $1 \leq i \leq 2n+1$. As a well-known result, $\text{Mod}_{0,2n+2}$ is generated by $\sigma_1, \sigma_2, \dots, \sigma_{2n+1}$ (see for instance Section 9.1.4 in [6]). Let $\text{Map}(\mathcal{B})$ be the group of self-bijections on \mathcal{B} . Since $\text{Map}(\mathcal{B})$ is naturally identified with the symmetric group S_{2n+2} of degree $2n+2$, the action of $\text{Mod}_{0,2n+2}$ on \mathcal{B} induces the surjective homomorphism

$$\Psi: \text{Mod}_{0,2n+2} \rightarrow S_{2n+2}$$

given by $\Psi(\sigma_i) = (i \ i+1)$.

Put $\mathcal{B}_o = \{p_1, p_3, \dots, p_{2n+1}\}$ and $\mathcal{B}_e = \{p_2, p_4, \dots, p_{2n+2}\}$. An element σ in S_{2n+2} is *parity-preserving* if $\sigma(\mathcal{B}_o) = \mathcal{B}_o$, and is *parity-reversing* if $\sigma(\mathcal{B}_o) = \mathcal{B}_e$. An element f in $\text{Mod}_{0,2n+2}$ is *parity-preserving* (resp. *parity-reversing*) if $\Psi(f)$ is *parity-preserving* (resp. *parity-reversing*). Let W_{2n+2} be the subgroup of S_{2n+2} which consists of parity-preserving or parity-reversing elements, S_{n+1}^o (resp. S_{n+1}^e) the subgroup of S_{2n+2} which consists of elements whose restriction to \mathcal{B}_e (resp. \mathcal{B}_o) is the identity map. Note that S_{n+1}^o (resp. S_{n+1}^e) is a subgroup of W_{2n+2} , isomorphic to S_{n+1} , and generated by transpositions $(1 \ 3), (3 \ 5), \dots, (2n-1 \ 2n+1)$ (resp. $(2 \ 4), (4 \ 6), \dots, (2n \ 2n+2)$). Then we have the following exact sequence:

$$(2.1) \quad 1 \longrightarrow S_{n+1}^o \times S_{n+1}^e \longrightarrow W_{2n+2} \xrightarrow{\pi} \mathbb{Z}_2 \longrightarrow 1,$$

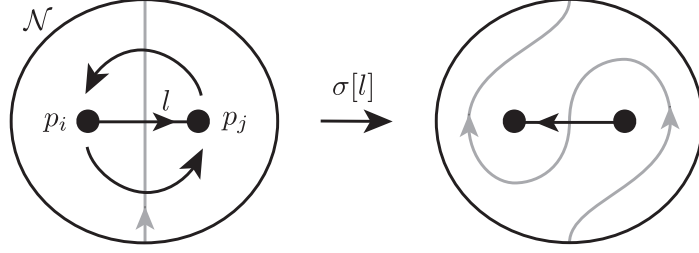
FIGURE 3. The half-twist $\sigma[l]$ along an arc l .

where the homomorphism $\pi: W_{2n+2} \rightarrow \mathbb{Z}_2$ is defined by $\pi(\sigma) = 0$ if σ is parity-preserving and $\pi(\sigma) = 1$ if σ is parity-reversing. Ghaswala and Winarski [9] proved the following lemma.

Lemma 2.1 (Lemma 3.6 in [9]). *Let LMod_{2n+2} be the liftable mapping class group for the balanced superelliptic covering map $p_{g,k}$ for $n \geq 1$ and $k \geq 3$ with $g = n(k-1)$. Then we have*

$$\text{LMod}_{2n+2} = \Psi^{-1}(W_{2n+2}).$$

Lemma 2.1 implies that a mapping class $f \in \text{Mod}_{0,2n+2}$ lifts with respect to $p_{g,k}$ if and only if f is parity-preserving or parity-reversing (in particular, when $k \geq 3$, the liftability of a homeomorphism on Σ_0 or Σ_0^1 does not depend on k). The *pure mapping class group* $\text{PMod}_{0,2n+2}$ is the kernel of the homomorphism $\Psi: \text{Mod}_{0,2n+2} \rightarrow S_{2n+2}$. Since all elements in $\text{PMod}_{0,2n+2}$ is parity-preserving, $\text{PMod}_{0,2n+2}$ is a subgroup of LMod_{2n+2} and we have the following exact sequence:

$$(2.2) \quad 1 \longrightarrow \text{PMod}_{0,2n+2} \longrightarrow \text{LMod}_{2n+2} \xrightarrow{\Psi} W_{2n+2} \longrightarrow 1.$$

We will introduce some explicit liftable elements as follows (their explicit lifts to Σ_g are given in Section 6.1).

The Dehn twist $t_{i,j}$. For a simple closed curve γ on Σ_g ($g \geq 0$), we denote by t_γ the right-handed Dehn twist along γ . Let $\gamma_{i,j}$ for $1 \leq i < j \leq 2n+2$ be a simple closed curve on $\Sigma_0 - (\mathcal{B} \cup D)$ such that $\gamma_{i,j}$ surrounds the $j-i+1$ points p_i, p_{i+1}, \dots, p_j as in Figure 2. We have $\gamma_{i,2n+2} = \gamma_{1,i-1}$ for $i \geq 3$ as an isotopy class of a curve. Then we define $t_{i,j} = t_{\gamma_{i,j}}$ for $1 \leq i < j \leq 2n+2$. Note that $t_{1,2n+1} = t_{1,2n+2} = t_{2,2n+2} = 1$ and $t_{i,2n+2} = t_{1,i-1}$ for $i \geq 3$ in $\text{Mod}_{0,2n+2}$. Since the Dehn twist $t_{i,j}$ preserves \mathcal{B} pointwise, i.e. $t_{i,j}$ lies in $\text{PMod}_{0,2n+2}$, $t_{i,j}$ lifts with respect to $p_{g,k}$ by Lemma 2.1.

The half-twists a_i and b_i . Let α_i (resp. β_i) for $1 \leq i \leq n$ be a simple arc whose endpoints are p_{2i-1} and p_{2i+1} (resp. p_{2i} and p_{2i+2}) as in Figure 4. Then we define $a_i = \sigma[\alpha_i]$ and $b_i = \sigma[\beta_i]$ for $1 \leq i \leq n$. Note that $a_i = \sigma_{2i}\sigma_{2i-1}\sigma_{2i}^{-1}$ and $b_i = \sigma_{2i+1}\sigma_{2i}\sigma_{2i+1}^{-1}$ for $1 \leq i \leq n$. Since $\Psi(a_i) = (2i-1 \ 2i+1)$ and $\Psi(b_i) = (2i \ 2i+2)$ for $1 \leq i \leq n$, the mapping classes a_i and b_i are parity-preserving. Thus, by Lemma 2.1, a_i and b_i lift with respect to $p_{g,k}$. The generating set of Ghaswala-Winarski's finite presentation for LMod_{2n+2} in [9] consists of a_i^{-1} , b_i^{-1} for $1 \leq i \leq n$, some Dehn twists, and one parity-reversing element.

The half-rotation h_i . Let \mathcal{N} be a regular neighborhood of $l_i \cup l_{i+1}$ in $(\Sigma_0 - \mathcal{B}) \cup \{p_i, p_{i+1}, p_{i+2}\}$ for $1 \leq i \leq 2n$. \mathcal{N} is homeomorphic to a 2-disk. Then we denote by h_i the self-homeomorphism on Σ_0 which is described as the result of anticlockwise half-rotation of $l_i \cup l_{i+1}$ in \mathcal{N} as in Figure 5. Note that $h_i = \sigma_i \sigma_{i+1} \sigma_i$ for $1 \leq i \leq 2n$.

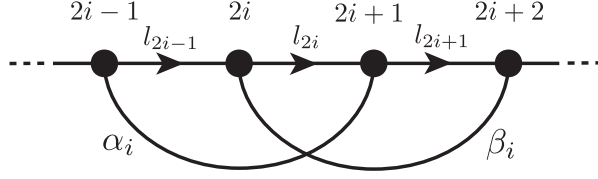
 FIGURE 4. Arcs α_i and β_i ($1 \leq i \leq n$) on Σ_0 .

Since $\Psi(h_i) = (i \ i+2)$ for $1 \leq i \leq 2n$, the mapping class h_i is parity-preserving. Thus, by Lemma 2.1, h_i lifts with respect to $p_{g,k}$.

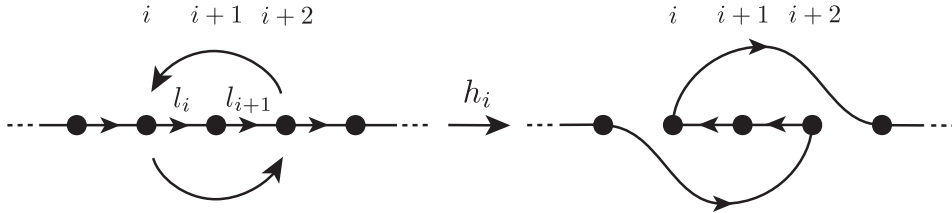
 FIGURE 5. The mapping class h_i ($1 \leq i \leq 2n$) on Σ_0 .

The parity-reversing element r . Let r be the self-homeomorphism on Σ_0 which is described as the result of the π -rotation of Σ_0 on the axis as in Figure 6. We see that $r(l_i) = l_{2n+2-i}^{-1}$ for $1 \leq i \leq 2n+1$ and $\Psi(r) = (1 \ 2n+2)(2 \ 2n+1) \cdots (n+1 \ n+2)$. Thus r is parity-reversing and lifts with respect to $p_{g,k}$ by Lemma 2.1.

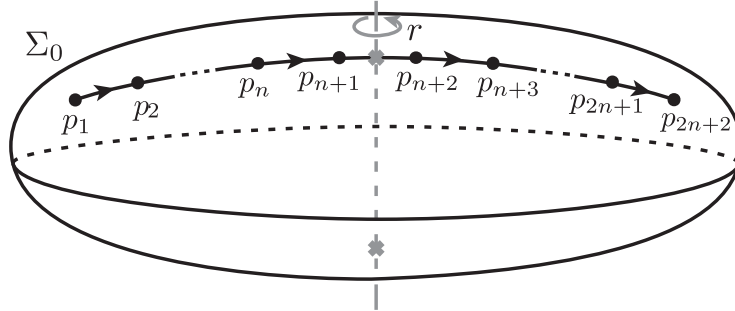
 FIGURE 6. The mapping class r on Σ_0 .

We can regard a mapping class in $\text{Mod}_{0,2n+2}$ which has a representative fixing D pointwise as an element in $\text{Mod}_{0,2n+1}^1$. We regard the mapping classes $t_{i,j}$ for $1 \leq i < j \leq 2n+2$, a_i for $1 \leq i \leq n$, b_i for $1 \leq i \leq n-1$, and h_i for $1 \leq i \leq 2n-1$ as elements in $\text{Mod}_{0,2n+1}^1$.

2.3. Basic relations among liftable elements for the balanced superelliptic covering map. In this section, we review relations among the elements h_i , $t_{i,j}$, and r introduced in Section 2.2. Recall that we regard $\text{LMod}_{2n+2,*}$ as a subgroup of LMod_{2n+2} and for mapping classes $[\varphi]$ and $[\psi]$, $[\psi][\varphi] = [\psi \circ \varphi]$, i.e. $[\varphi]$ apply first.

Commutative relations. For elements f and h in a group G , $f \rightleftharpoons h$ if f commutes with h , namely, the relation $fh = hf$ holds in G . We call such a relation a *commutative relation*. For mapping classes f and h , if their representatives have mutually disjoint supports, then we have $f \rightleftharpoons h$ in the mapping class group. We have the following lemma.

Lemma 2.2. *We have the following relations:*

- (1) $t_{i,j} \rightleftharpoons t_{k,l}$ for $j < k, k \leq i < j \leq l$, or $l < i$ in LMod_{2n+2} and $\text{Mod}_{0,2n+1}^1$,
- (2) $h_i \rightleftharpoons h_j$ for $j - i \geq 3$ in LMod_{2n+2} and for $j - i \geq 3$ and $j \neq 2n$ in $\text{Mod}_{0,2n+1}^1$,
- (3) $h_k \rightleftharpoons t_{i,j}$ for $k + 2 < i, i \leq k < k + 2 \leq j$, or $j < k$ in LMod_{2n+2} and for “ $k + 2 < i, i \leq k < k + 2 \leq j$, or $j < k$ ” and $k \neq 2n$ in $\text{Mod}_{0,2n+1}^1$.

Conjugation relations. For elements f_1, f_2 , and h in a group G , we call the relation $hf_1h^{-1} = f_2$, which is equivalent to $hf_1 = f_2h$, in G a *conjugation relation*. In particular, in the case of $f_1 = t_\gamma$ or $f_1 = \sigma[l]$, and h is a mapping class, the relations $ht_\gamma = t_{h(\gamma)}h$ and $h\sigma[l] = \sigma[h(l)]h$ hold in the mapping class group. By the relations above, we have the following lemma.

Lemma 2.3. *The following relations hold in $\text{LMod}_{2n+2,*}$ and $\text{Mod}_{0,2n+1}^1$:*

- (1) $h_i^{\pm 1}t_{i,i+1} = t_{i+1,i+2}h_i^{\pm 1}$ for $1 \leq i \leq 2n - 1$,
- (2) $h_i^\varepsilon h_{i+1}^\varepsilon t_{i,i+1} = t_{i+2,i+3}h_i^\varepsilon h_{i+1}^\varepsilon$ for $1 \leq i \leq 2n - 2$ and $\varepsilon \in \{1, -1\}$,
- (3) $h_i^\varepsilon h_{i+1}^\varepsilon h_{i+2}^\varepsilon h_i^\varepsilon = h_{i+2}^\varepsilon h_i^\varepsilon h_{i+1}^\varepsilon h_{i+2}^\varepsilon$ for $1 \leq i \leq 2n - 3$ and $\varepsilon \in \{1, -1\}$,

and the following relations hold in LMod_{2n+2} :

- (1) $h_{2n}^{\pm 1}t_{2n,2n+1} = t_{2n+1,2n+2}h_{2n}^{\pm 1}$,
- (2) $h_{2n-1}^\varepsilon h_{2n}^\varepsilon t_{2n-1,2n} = t_{2n+1,2n}h_{2n-1}^\varepsilon h_{2n}^\varepsilon$ for $\varepsilon \in \{1, -1\}$,
- (3) $h_{2n-2}^\varepsilon h_{2n-1}^\varepsilon h_{2n}^\varepsilon h_{2n-1}^\varepsilon = h_{2n}^\varepsilon h_{2n-2}^\varepsilon h_{2n-1}^\varepsilon h_{2n}^\varepsilon$ for $\varepsilon \in \{1, -1\}$,
- (4) $rh_i = h_{2n-i+1}r$ for $1 \leq i \leq 2n$,
- (5) $rt_{i,j} = t_{2n-j+3,2n-i+3}r$ for $1 \leq i < j \leq 2n + 2$.

Lifts of relations in the symmetric group. Recall that we have the surjective homomorphism $\Psi: \text{LMod}_{2n+2} \rightarrow W_{2n+2}$ by Lemma 2.1 and the relations $\Psi(h_i) = (i \ i+2)$ for $1 \leq i \leq 2n$ and $\Psi(r) = (1 \ 2n+2)(2 \ 2n+1) \cdots (n+1 \ n+2)$. By the exact sequence (2.1), W_{2n+2} is a group extension of $S_{n+1}^o \times S_{n+1}^e$ by \mathbb{Z}_2 . For an element σ in $\text{Mod}_{0,2n+2}$, we define $\bar{\sigma} = \Psi(\sigma)$. Then the following relations hold in W_{2n+2} :

- $\bar{h}_i^2 = 1$ for $1 \leq i \leq 2n$,
- $\bar{h}_i \bar{h}_{i+1} \bar{h}_i^{-1} \bar{h}_{i+1}^{-1} = 1$ for $1 \leq i \leq 2n - 1$,
- $\bar{h}_i \bar{h}_{i+2} \bar{h}_i \bar{h}_{i+2}^{-1} \bar{h}_i^{-1} \bar{h}_{i+2}^{-1} = 1$ for $1 \leq i \leq 2n - 2$,
- $\bar{r}^2 = 1$,

By the exact sequence (2.1), products h_i^2 ($1 \leq i \leq 2n$), $h_i h_{i+1} h_i^{-1} h_{i+1}^{-1}$ ($1 \leq i \leq 2n - 1$), $h_i h_{i+2} h_i h_{i+2}^{-1} h_i^{-1} h_{i+2}^{-1}$ ($1 \leq i \leq 2n - 2$), and r^2 lie in $\text{PMod}_{0,2n+2}$. We have the following lemma.

Lemma 2.4. *The following relations hold in $\text{LMod}_{2n+2,*}$ and $\text{Mod}_{0,2n+1}^1$:*

- (1) $h_i^2 = t_{i,i+2}$ for $1 \leq i \leq 2n - 1$,
- (2) $h_i h_{i+1} h_i^{-1} h_{i+1}^{-1} = t_{i,i+1} t_{i+2,i+3}^{-1}$ for $1 \leq i \leq 2n - 2$,
- (3) $h_i h_{i+2} h_i h_{i+2}^{-1} h_i^{-1} h_{i+2}^{-1} = t_{i+1,i+2} t_{i+2,i+3}^{-1}$ for $1 \leq i \leq 2n - 3$,

and the following relations hold in LMod_{2n+2} :

- (1) $h_{2n}^2 = t_{2n,2n+2} = t_{1,2n}$,
- (2) $h_{2n-1} h_{2n} h_{2n-1}^{-1} h_{2n}^{-1} = t_{2n-1,2n} t_{2n+1,2n+2}^{-1} = t_{2n-1,2n} t_{1,2n}^{-1}$,
- (3) $h_{2n-2} h_{2n-1} h_{2n-2} h_{2n-1}^{-1} h_{2n-2}^{-1} = t_{2n-1,2n} t_{2n,2n+1}^{-1}$,
- (4) $r^2 = 1$.

Proof. The relations (1) and (4) clearly hold. We will show the relations (2) and (3) from a point of view of the spherical braid group (we can also prove by observing the image of L and L^1 by these mapping classes). Let SB_{2n+2} be the *spherical braid group* of $2n+2$ strands. For $b_1, b_2 \in SB_{2n+2}$, the product $b_1 b_2$ is a braid as on the right-hand side in Figure 7. Then we have the surjective homomorphism $\Gamma: SB_{2n+2} \rightarrow \text{Mod}_{0,2n+2}$ which maps the half-twist about i -th and $(i+1)$ -st strands as on the left-hand side in Figure 7 to the half-twist $\sigma_i \in \text{Mod}_{0,2n+2}$. We abuse notation and denote simply the half-twist in SB_{2n+2} about i -th and $(i+1)$ -st strands by σ_i , the full-twist in SB_{2n+2} about strands between i -th strand and j -th strand by $t_{i,j}$, and $h_i = \sigma_i \sigma_{i+1} \sigma_i$ for $1 \leq i \leq 2n$. The braid $h_i h_{i+1} h_i^{-1} h_{i+1}^{-1}$ lies on the left-hand side in Figure 8 and we can see that $h_i h_{i+1} h_i^{-1} h_{i+1}^{-1}$ is isotopic to $t_{i,i+1} t_{i+2,i+3}^{-1}$. We can also show that $h_i h_{i+2} h_i h_{i+2}^{-1} h_i^{-1} h_{i+2}^{-1} = t_{i+1,i+2} t_{i+2,i+3}^{-1}$ in SB_{2n+2} as on the right-hand side in Figure 8. We have completed the proof of Lemma 2.4. \square

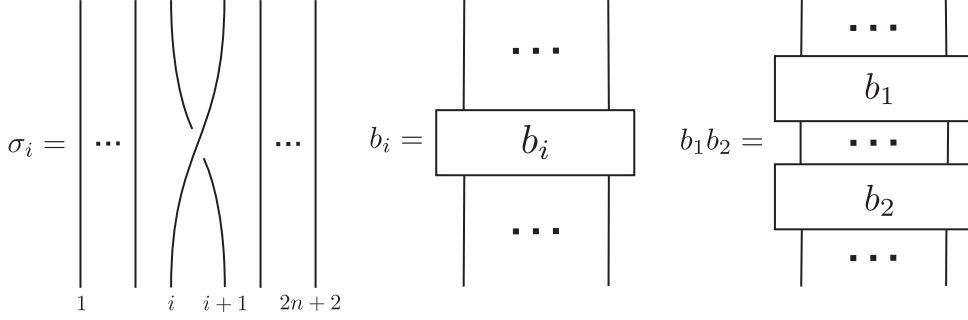

FIGURE 7. The half-twist $\sigma_i \in SB_{2n+2}$ ($1 \leq i \leq 2n+1$) and the product $b_1 b_2$ in SB_{2n+2} for b_i ($i = 1, 2$).

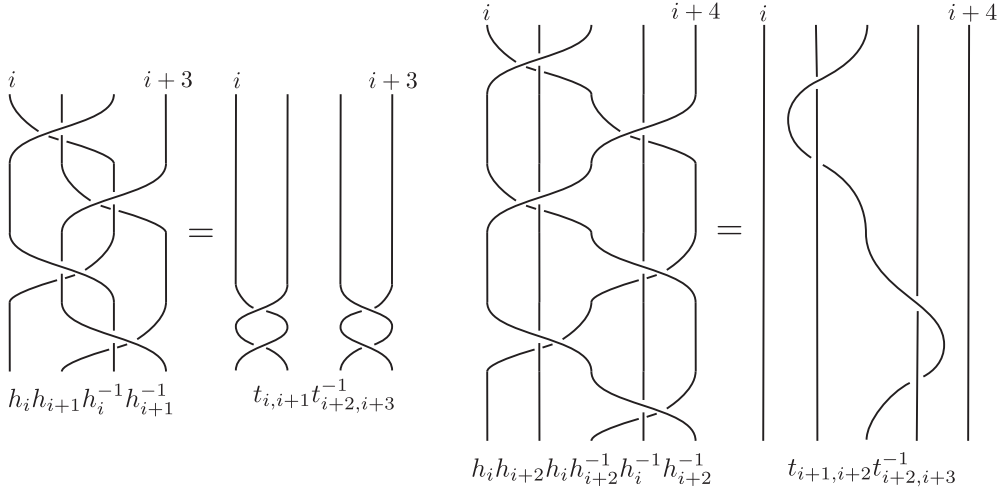

FIGURE 8. Relations $h_i h_{i+1} h_i^{-1} h_{i+1}^{-1} = t_{i,i+1} t_{i+2,i+3}^{-1}$ and $h_i h_{i+2} h_i h_{i+2}^{-1} h_i^{-1} h_{i+2}^{-1} = t_{i+1,i+2} t_{i+2,i+3}^{-1}$ in SB_{2n+2} .

Remark that, up to commutative relations in Lemma 2.2 and conjugation relations in Lemma 2.2, the relation (2) in Lemma 2.4, i.e. $h_i h_{i+1} h_i^{-1} h_{i+1}^{-1} = t_{i,i+1} t_{i+2,i+3}^{-1}$, is equivalent to the relation $h_i h_{i+1} t_{i,i+1} =$

$t_{i,i+1}h_{i+1}h_i$ for $1 \leq i \leq 2n-1$, and the relation (3) in Lemma 2.4, i.e. $h_i h_{i+2} h_i h_{i+2}^{-1} h_i^{-1} h_{i+2}^{-1} = t_{i+1,i+2} t_{i+2,i+3}^{-1}$, is equivalent to the relation $h_i h_{i+2} h_i t_{i+1,i+2}^{-1} = t_{i+2,i+3}^{-1} h_{i+2} h_i h_{i+2}$ for $1 \leq i \leq 2n-2$.

An expression of $t_{i,j}$ for $j-i \geq 3$ by product of h_k and $t_{l,l+1}$. By Lemma 2.4, we have $t_{i,i+2} = h_i^2$ for $1 \leq i \leq 2n$. In the case of $j-i \geq 3$, an expression of $t_{i,j}$ by product of h_k ($1 \leq k \leq 2n$) and $t_{l,l+1}$ ($1 \leq l \leq 2n+1$) is given by the following lemma.

Lemma 2.5. *The following relations hold in LMod_{2n+2} :*

$$t_{i,j} = \begin{cases} h_i^2 & \text{for } j-i=2, \\ t_{j-1,j}^{-\frac{j-i-3}{2}} \cdots t_{i+2,i+3}^{-\frac{j-i-3}{2}} t_{i,i+1}^{-\frac{j-i-3}{2}} (h_{j-2} \cdots h_{i+1} h_i)^{\frac{j-i+1}{2}} & \text{for } 2n+1 \geq j-i \geq 3 \text{ is odd,} \\ t_{j-2,j-1}^{-\frac{j-i-2}{2}} \cdots t_{i+2,i+3}^{-\frac{j-i-2}{2}} t_{i,i+1}^{-\frac{j-i-2}{2}} h_{j-2} \cdots h_{i+2} h_i h_i h_{i+2} \cdots h_{j-2} & \cdot (h_{j-3} \cdots h_{i+1} h_i)^{\frac{j-i}{2}} \text{ for } 2n \geq j-i \geq 4 \text{ is even.} \end{cases}$$

For $j \leq 2n+1$, the relations above hold in $\text{LMod}_{2n+2,*}$ and $\text{Mod}_{0,2n+1}^1$.

We call the relation in Lemma 2.5 for $1 \leq i < j \leq 2n+2$ the relation $(T_{i,j})$. Recall that we have $t_{2n+1,2n+2} = t_{1,2n}$ and $t_{1,2n+1} = t_{2,2n+2} = t_{1,2n+2} = 1$ in LMod_{2n+2} . Thus the relation

$$t_{2n-1,2n}^{-n+1} \cdots t_{3,4}^{-n+1} t_{1,2}^{-n+1} h_{2n-1} \cdots h_3 h_1 h_1 h_3 \cdots h_{2n-1} (h_{2n-2} \cdots h_2 h_1)^n = 1$$

holds in $\text{LMod}_{2n+2,*}$ and the relations

$$t_{2n,2n+1}^{-n+1} \cdots t_{4,5}^{-n+1} t_{2,3}^{-n+1} h_{2n} \cdots h_4 h_2 h_2 h_4 \cdots h_{2n} (h_{2n-1} \cdots h_3 h_2)^n = 1$$

and

$$t_{1,2n}^{-n+1} t_{2n-1,2n}^{-n+1} \cdots t_{3,4}^{-n+1} t_{1,2}^{-n+1} (h_{2n} \cdots h_2 h_1)^{n+1} = 1$$

hold in LMod_{2n+2} . We will give a precise proof of Lemma 2.5 in the proof of Lemma 5.12 by proving that the relations $(T_{i,j})$ are equivalent to lantern relations up to the relations in Lemmas 2.2, 2.3, and 2.4. However, we can check that the relations in Lemma 2.5 holds in LMod_{2n+2} and $\text{Mod}_{0,2n+1}^1$ from a point of view of the spherical braid group as a similar argument in the proof of Lemma 2.4. Recall the surjective homomorphism $\Gamma: SB_{2n+2} \rightarrow \text{Mod}_{0,2n+2}$ defined in the proof of Lemma 2.4. For instance, $t_{i,i+5}$ is expressed by the braid as on the right-hand side in Figure 9 and the product $t_{i,i+1}^{-1} t_{i+2,i+3}^{-1} t_{i+4,i+5}^{-1} (h_{i+3} h_{i+2} h_{i+1} h_i)^3$ is the braid as on the left-hand side in Figure 9. By the deformation by an isotopy as in Figure 9, we can show that the braid $t_{i,i+5}$ coincides with the braid $t_{i,i+1}^{-1} t_{i+2,i+3}^{-1} t_{i+4,i+5}^{-1} (h_{i+3} h_{i+2} h_{i+1} h_i)^3$. For the case of $t_{i,i+6}$, we also have a deformation by an isotopy which gives $t_{i,i+6} = t_{i,i+1}^{-2} t_{i+2,i+3}^{-2} t_{i+4,i+5}^{-2} h_{i+4} h_{i+2} h_i h_i h_{i+2} h_{i+4} (h_{i+3} h_{i+2} h_{i+1} h_i)^3$ as in Figure 10.

Pentagonal relations. Pentagonal relations are given in the following lemma.

Lemma 2.6 (Pentagonal relation). *Let Σ be a 2-sphere with five boundary components and $\alpha, \beta, \gamma, \delta,$ and ε simple closed curves on Σ , each one of which separates Σ into two 2-spheres with three and four boundary components as on the left-hand side in Figure 11. Then we have the following relation in $\text{Mod}(\Sigma, \emptyset, \partial\Sigma)$:*

$$t_\varepsilon^{-1} t_\gamma t_\beta t_\alpha t_\delta^{-1} = t_\delta^{-1} t_\alpha t_\beta t_\gamma t_\varepsilon^{-1}.$$

We call the relation in Lemma 2.6 a *pentagonal relation*. Lemma 2.6 is proved after the next lemma.

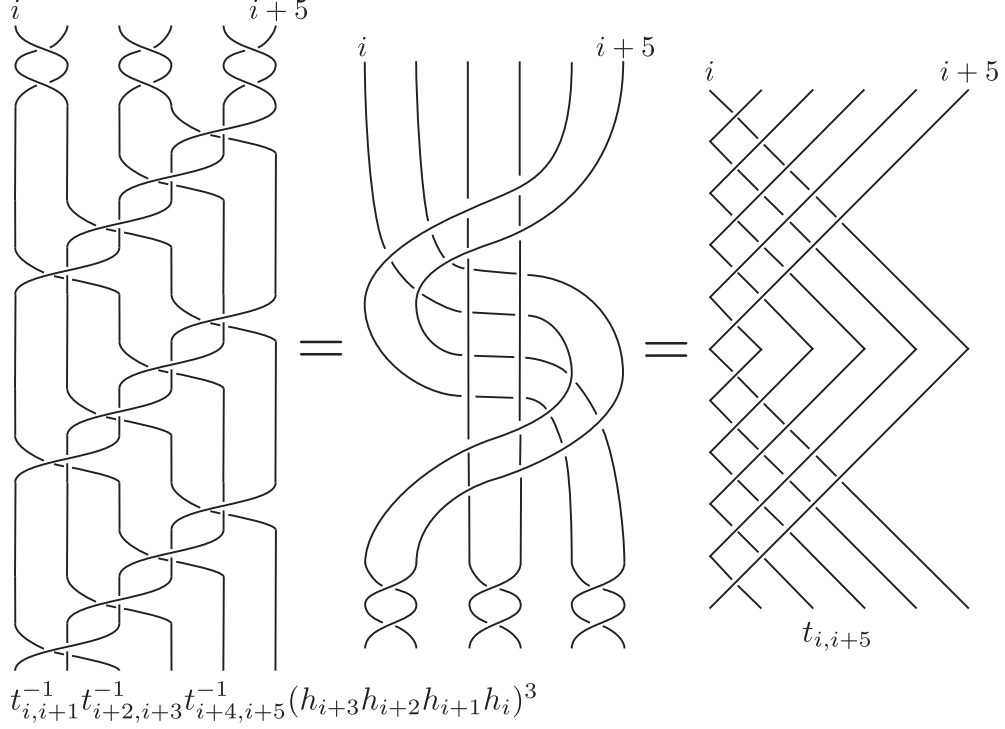

FIGURE 9. The relation $t_{i,i+1}^{-1} t_{i+2,i+3}^{-1} t_{i+4,i+5}^{-1} (h_{i+3} h_{i+2} h_{i+1} h_i)^3 = t_{i,i+5}$ in SB_{2n+2} .

We consider a pentagon whose vertices are labeled in turn by α , β , γ , δ , and ε and take the path $(\delta, \alpha, \beta, \gamma, \varepsilon)$ which passes through δ , α , β , γ , and ε sequentially as on the right-hand side in Figure 11. Note that two vertices in the pentagon are jointed by an edge if and only if these labeling two simple closed curves are not disjoint. The path $(\delta, \alpha, \beta, \gamma, \varepsilon)$ or its inverse is corresponding to the pentagonal relation $t_\varepsilon^{-1} t_\gamma t_\beta t_\alpha t_\delta^{-1} = t_\delta^{-1} t_\alpha t_\beta t_\gamma t_\varepsilon^{-1}$. By the $\frac{2\pi}{5}$ -rotation of the path $(\delta, \alpha, \beta, \gamma, \varepsilon)$, we obtain the path $(\gamma, \varepsilon, \alpha, \beta, \delta)$ in the pentagon and the corresponding pentagonal relation

$$t_\delta^{-1} t_\beta t_\alpha t_\varepsilon t_\gamma^{-1} = t_\gamma^{-1} t_\varepsilon t_\alpha t_\beta t_\delta^{-1}.$$

We can check that this pentagonal relation, corresponding to $(\gamma, \varepsilon, \alpha, \beta, \delta)$, is equivalent to the pentagonal relation corresponding to $(\delta, \alpha, \beta, \gamma, \varepsilon)$ up to commutative relations.

Throughout this paragraph and Section 3, we consider the pure mapping class group $\text{PMod}_{0,n}$ of 2-sphere with n marked point not only for even n , but also for any positive integer n . In odd n cases, we can similarly define the n marked points set $\mathcal{B} = \{p_1, p_2, \dots, p_n\}$ in Σ_0 , the simple closed curve $\gamma_{i,j}$ on $\Sigma_0 - \mathcal{B}$ for $1 \leq i < j \leq n$ as in Figure 2, and the Dehn twist $t_{i,j}$ along $\gamma_{i,j}$. Recall that $t_{i,j}$ lies in $\text{PMod}_{0,n}$ for $1 \leq i < j \leq n$. For $1 \leq i < j < k < l < m \leq n$, simple closed curves $\gamma_{i,k-1}$, $\gamma_{j,l-1}$, $\gamma_{k,m-1}$, $\gamma_{i,l-1}$, and $\gamma_{j,m-1}$ are lie on Σ_0 as in Figure 12. We call the pentagonal relation corresponding to the path $(\gamma_{i,l-1}, \gamma_{i,k-1}, \gamma_{j,l-1}, \gamma_{k,m-1}, \gamma_{j,m-1})$, i.e.

$$t_{j,m-1}^{-1} t_{k,m-1} t_{j,l-1} t_{i,k-1} t_{i,l-1}^{-1} = t_{i,l-1}^{-1} t_{i,k-1} t_{j,l-1} t_{k,m-1} t_{j,m-1}^{-1},$$

the *pentagonal relation* $(P_{i,j,k,l,m})$ or the *relation* $(P_{i,j,k,l,m})$.

We review the lantern relation in the next lemma to prove Lemma 2.6.

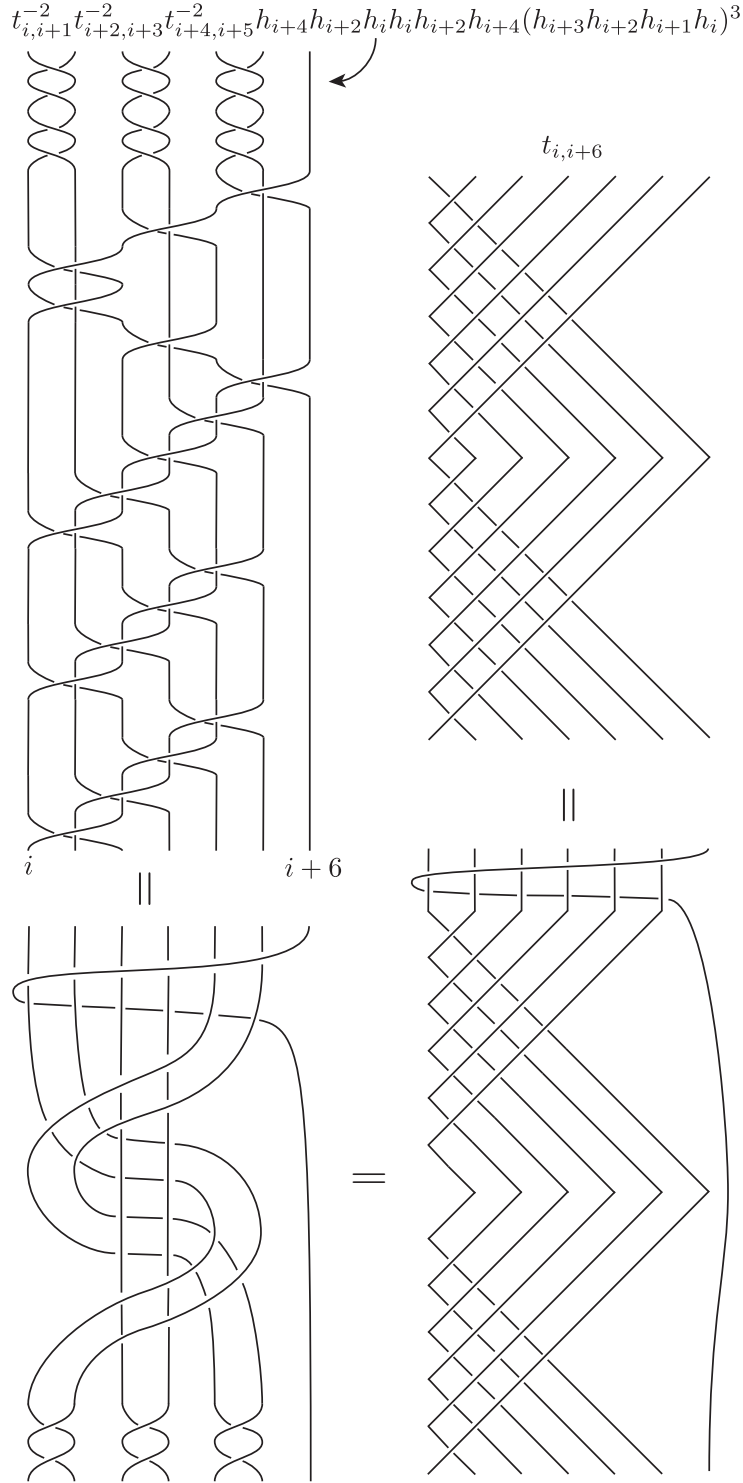

FIGURE 10. The relation $t_{i,i+1}^{-2} t_{i+2,i+3}^{-2} t_{i+4,i+5}^{-2} h_{i+4} h_{i+2} h_i h_{i+2} h_{i+4} \cdot (h_{i+3} h_{i+2} h_{i+1} h_i)^3 = t_{i,i+6}$ in SB_{2n+2} .

Lemma 2.7 (Lantern relation). *Let Σ be a 2-sphere with four boundary components, α , β , and γ simple closed curves on Σ each one of which separates Σ into*

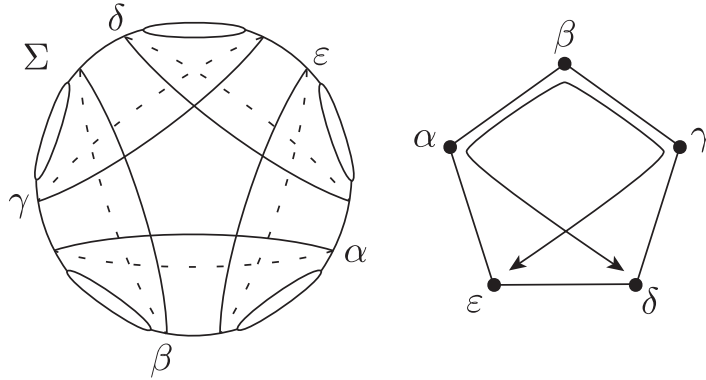

FIGURE 11. Simple closed curves α , β , γ , δ , and ε on Σ and a pentagon whose vertices are labeled by these curves.

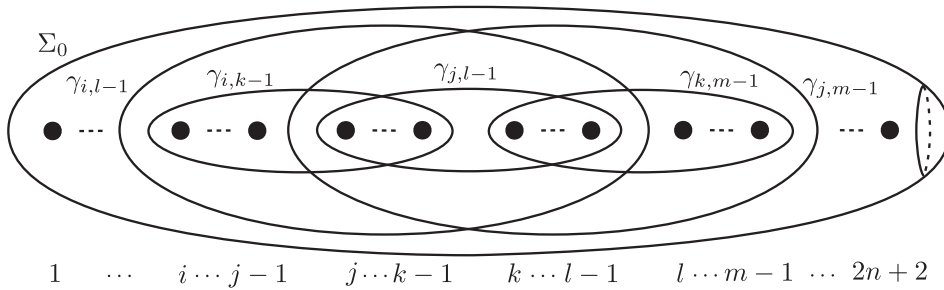

FIGURE 12. Simple closed curves $\gamma_{i,k-1}$, $\gamma_{j,l-1}$, $\gamma_{k,m-1}$, $\gamma_{i,l-1}$, and $\gamma_{j,m-1}$ on Σ_0 .

two 2-spheres with three boundary components as in Figure 13, and δ_i ($i = 1, 2, 3, 4$) the boundary curve of Σ . Then we have the following relation in $\text{Mod}(\Sigma, \emptyset, \partial\Sigma)$:

$$t_\alpha t_\beta t_\gamma = t_{\delta_1} t_{\delta_2} t_{\delta_3} t_{\delta_4}.$$

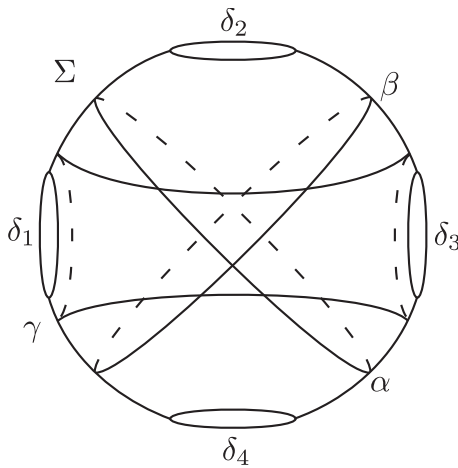

FIGURE 13. Simple closed curves α , β , γ , and δ_i ($i = 1, 2, 3, 4$) on Σ .

Proof of Lemma 2.6. Let α , β , γ , δ , and ε be simple closed curves on Σ as in Figure 11 and Σ' the subsurface of Σ which is cut off by α and homeomorphic to a 2-sphere with four boundary components. Denote by δ_1 , δ_2 , and δ_3 the boundary curves of Σ' , each one of which is not α , and by γ_1 and γ_2 the simple closed curves on Σ' as in Figure 14. By Lemma 2.7, we have the two lantern relations

$$t_\delta t_\gamma t_{\gamma_1} = t_\alpha t_{\delta_1} t_{\delta_2} t_{\delta_3} \quad \text{and} \quad t_\gamma t_\delta t_{\gamma_2} = t_\alpha t_{\delta_1} t_{\delta_2} t_{\delta_3}.$$

These relations are equivalent to the relations

$$(2.3) \quad t_\gamma^{-1} t_\delta^{-1} t_\alpha = t_{\delta_1}^{-1} t_{\delta_2}^{-1} t_{\delta_3}^{-1} t_{\gamma_1} \quad \text{and}$$

$$(2.4) \quad t_\delta^{-1} t_\gamma^{-1} t_\alpha = t_{\delta_1}^{-1} t_{\delta_2}^{-1} t_{\delta_3}^{-1} t_{\gamma_2}.$$

Since $t_\beta t_\varepsilon^{-1} t_{\gamma_2} t_\varepsilon t_\beta^{-1} = t_{t_\beta t_\varepsilon^{-1}(\gamma_2)} = t_{\gamma_1}$ and $t_\beta t_\varepsilon^{-1}$ commutes with t_{δ_i} ($i = 1, 2, 3$), by the conjugation of the relation (2.4) by $t_\beta t_\varepsilon^{-1}$, we have the relation

$$(2.5) \quad t_\beta t_\varepsilon^{-1} t_\delta^{-1} t_\gamma^{-1} t_\alpha t_\varepsilon t_\beta^{-1} = t_{\delta_1}^{-1} t_{\delta_2}^{-1} t_{\delta_3}^{-1} t_{\gamma_1}.$$

Thus, by the relation (2.3) and (2.5), we have

$$\begin{aligned} & t_\beta t_\varepsilon^{-1} t_\delta^{-1} t_\gamma^{-1} t_\alpha t_\varepsilon t_\beta^{-1} = t_\gamma^{-1} t_\delta^{-1} t_\alpha \\ & \xrightarrow{\text{COMM}} t_\beta t_\varepsilon^{-1} t_\delta^{-1} t_\alpha t_\varepsilon t_\gamma^{-1} t_\beta^{-1} = t_\gamma^{-1} t_\delta^{-1} t_\alpha \\ & \xleftarrow{\text{CONJ}} t_\gamma t_\beta t_\varepsilon^{-1} t_\delta^{-1} t_\alpha = t_\delta^{-1} t_\alpha t_\beta t_\gamma t_\varepsilon^{-1} \\ & \xrightarrow{\text{COMM}} t_\varepsilon^{-1} t_\gamma t_\beta t_\alpha t_\delta^{-1} = t_\delta^{-1} t_\alpha t_\beta t_\gamma t_\varepsilon^{-1}, \end{aligned}$$

where “COMM” and “CONJ” mean deformations of relations by commutative relations and conjugations of relations, respectively, “ $A_1 \underline{A} A_2$ ” (resp. “ $A_1 \underline{A} A_2$ ”) means that deforming the word $A_1 A A_2$ by moving A right (resp. left), and denote $A' \underline{A} = B \xrightarrow{\text{CONJ}} A' = B A^{-1}$ and $\underline{A} A' = B \xleftarrow{\text{CONJ}} A' = A^{-1} B$. We have completed the proof of Lemma 2.6. \square

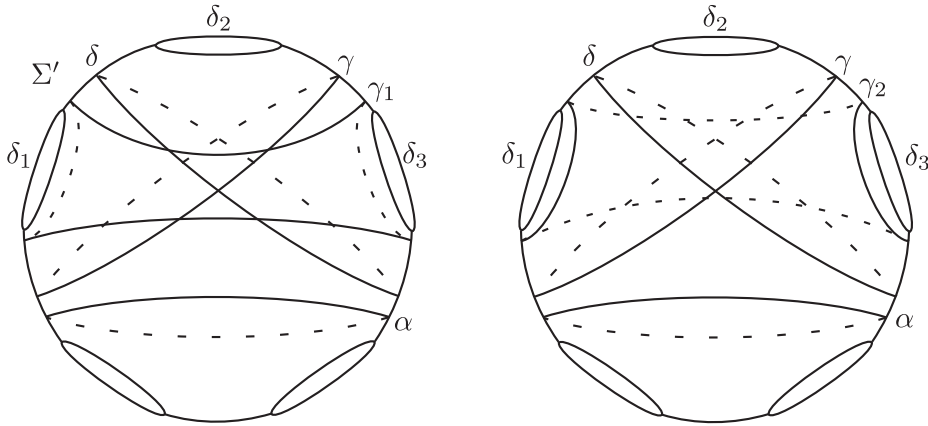

FIGURE 14. Simple closed curves γ_1 , γ_2 , and δ_i ($i = 1, 2, 3$) on Σ' .

3. A FINITE PRESENTATION FOR THE PURE MAPPING CLASS GROUP OF A 2-SPHERE

In this section, we consider the pure mapping class group $\text{PMod}_{0,n}$ of a 2-sphere with n marked point not only for even n , but also for any positive integer n . Recall that $\mathcal{B} = \{p_1, p_2, \dots, p_n\}$ is the n marked points set in Σ_0 and $t_{i,j}$ is the Dehn twist along the simple closed curve $\gamma_{i,j}$ on $\Sigma_0 - \mathcal{B}$ for $1 \leq i < j \leq n$ as in Figure 2. We will prove the following proposition in this section.

Proposition 3.1. *The group $\text{PMod}_{0,n}$ admits the presentation with generators $t_{i,j}$ for $1 \leq i < j \leq n-1$ with $(i, j) \neq (1, n-1)$, and the following defining relations:*

- (1) commutative relations $t_{i,j} \varpi t_{k,l}$ for $j < k, k \leq i < j \leq l$, or $l < i$,
 - (2) pentagonal relations $(P_{i,j,k,l,m})$ for $1 \leq i < j < k < l < m \leq n$,
- i.e. $t_{j,m-1}^{-1} t_{k,m-1} t_{j,l-1} t_{i,k-1} t_{i,l-1}^{-1} = t_{i,l-1}^{-1} t_{i,k-1} t_{j,l-1} t_{k,m-1} t_{j,m-1}^{-1}$.

The relation (1) and (2) in Proposition 3.1 are reviewed in Lemma 2.2 and after Lemma 2.6, respectively.

To prove Proposition 3.1 and theorems in Sections 5 and 6, we review a relationship between a group extension and group presentations as follows. Let G be a group and let $H = \langle X \mid R \rangle$ and $Q = \langle Y \mid S \rangle$ be presented groups which have the short exact sequence

$$1 \longrightarrow H \xrightarrow{\iota} G \xrightarrow{\nu} Q \longrightarrow 1.$$

We take a preimage $\tilde{y} \in G$ of $y \in Q$ with respect to ν for each $y \in Q$. Then we put $\tilde{X} = \{\iota(x) \mid x \in X\} \subset G$ and $\tilde{Y} = \{\tilde{y} \mid y \in Y\} \subset G$. Denote by \tilde{r} the word in \tilde{X} which is obtained from $r \in R$ by replacing each $x \in X$ by $\iota(x)$ and also denote by \tilde{s} the word in \tilde{Y} which is obtained from $s \in S$ by replacing each $y \in Y$ by \tilde{y} . We note that $\tilde{r} = 1$ in G . Since $\tilde{s} \in G$ is an element in $\ker \nu = \iota(H)$ for each $s \in S$, there exists a word v_s in \tilde{X} such that $\tilde{s} = v_s$ in G . Since $\iota(H)$ is a normal subgroup of G , for each $x \in X$ and $y \in Y$, there exists a word $w_{x,y}$ in \tilde{X} such that $\tilde{y}\iota(x)\tilde{y}^{-1} = w_{x,y}$ in G . The next lemma follows from an argument of the combinatorial group theory (for instance, see [11, Proposition 10.2.1, p139]).

Lemma 3.2. *Under the situation above, the group G admits the presentation with the generating set $\tilde{X} \cup \tilde{Y}$ and following defining relations:*

- (A) $\tilde{r} = 1$ for $r \in R$,
- (B) $\tilde{s} = v_s$ for $s \in S$,
- (C) $\tilde{y}\iota(x)\tilde{y}^{-1} = w_{x,y}$ for $x \in X$ and $y \in Y$.

Proof of Proposition 3.1. We proceed by induction on $n = |\mathcal{B}| \geq 1$. Put $\mathcal{B}^1 = \{p_1, p_2, \dots, p_{n-1}\}$ and $\Sigma_{0,n-1} = \Sigma_0 - \mathcal{B}^1$. Then we regard $\text{PMod}_{0,n-1}$ as the group $\text{Mod}(\Sigma_0, \emptyset, \mathcal{B}^1)$. Let $\mathcal{F}: \text{PMod}_{0,n} \rightarrow \text{PMod}_{0,n-1}$ be the forgetful homomorphism which is defined by the correspondence $[\varphi] \mapsto [\varphi]$. Birman [1] constructed the following exact sequence (see also Section 4.2 in [6]):

$$(3.1) \quad \pi_1(\Sigma_{0,n-1}, p_n) \xrightarrow{\Delta} \text{PMod}_{0,n} \xrightarrow{\mathcal{F}} \text{PMod}_{0,n-1} \longrightarrow 1,$$

where for $\gamma \in \pi_1(\Sigma_{0,n-1}, p_n)$, $\Delta(\gamma)$ is a self-homeomorphism on Σ_0 which is the result of pushing p_n along γ once and for $\gamma_1, \gamma_2 \in \pi_1(\Sigma_{0,n-1}, p_n)$, the product $\gamma_1 \gamma_2$ means $\gamma_1 \gamma_2(t) = \gamma_2(2t)$ for $0 \leq t \leq \frac{1}{2}$ and $\gamma_1 \gamma_2(t) = \gamma_1(2t-1)$ for $\frac{1}{2} \leq t \leq 1$. We remark that $\pi_1(\Sigma_{0,n-1}, p_n)$ is trivial for $n \in \{1, 2\}$ and $\text{PMod}_{0,0} = \text{Mod}(\Sigma_0, \emptyset, \emptyset)$ is also trivial. Hence the groups $\text{PMod}_{0,1}$ and $\text{PMod}_{0,2}$ are trivial. For $n \geq 3$, $\pi_1(\Sigma_{0,n-1}, p_n)$ is generated by loops $\omega_1, \omega_2, \dots, \omega_{n-2}$ on $\Sigma_0 - \mathcal{B}^1$ based at p_n as in Figure 15. In the case of $n = 3$, $\pi_1(\Sigma_{0,2}, p_3)$ is the infinite cyclic group and the image of the homomorphism $\Delta: \pi_1(\Sigma_{0,2}, p_3) \rightarrow \text{PMod}_{0,3}$ is trivial. By the exact sequence (3.1), we show that $\text{PMod}_{0,3}$ is trivial. In the cases $n \in \{1, 2, 3\}$,

the Dehn twist along any simple closed curve on $\Sigma_0 - \mathcal{B}$ is trivial in $\text{PMod}_{0,n}$. Thus, Proposition 3.1 is true for the cases $n \in \{1, 2, 3\}$. In the case of $n \geq 4$, since $\pi_1(\Sigma_{0,n-1}, p_n)$ is isomorphic to the free group of rank $n - 2$, the center of $\pi_1(\Sigma_{0,n-1}, p_n)$ is trivial for $n \geq 4$. Thus, the homomorphism Δ is injective by Corollary 1.2 in [1], and we will apply Lemma 3.2 to the exact sequence (3.1).

The base case of this induction is the case $n = 4$. We remark that the presentation for $\text{PMod}_{0,4}$ in Proposition 3.1 has generators $t_{1,2}$ and $t_{2,3}$, and no relations. Since $\text{PMod}_{0,3}$ is trivial and $\pi_1(\Sigma_{0,n-1}, p_n)$ is isomorphic to the free group of rank 2 and generated by ω_1 and ω_2 , $\text{PMod}_{0,4}$ is isomorphic to the free group of rank 2 and generated by $\Delta(\omega_1)$ and $\Delta(\omega_2)$ by the exact sequence (3.1). We can show that $\Delta(\omega_1) = t_{2,3}^{-1}$ and $\Delta(\omega_2) = t_{1,2}$, and thus, Proposition 3.1 is true for the case $n = 4$.

We assume $n \geq 5$. By the inductive hypothesis, $\text{PMod}_{0,n-1}$ admits the presentation with generators $t_{i,j}$ for $1 \leq i < j \leq n - 2$ with $(i, j) \neq (1, n - 2)$, and the following defining relations:

- (1) Commutative relations $t_{i,j} \varpi t_{k,l}$ for $j < k, k \leq i < j \leq l$, or $l < i$,
- (2) Pentagonal relations $(P_{i,j,k,l,m})$ for $1 \leq i < j < k < l < m \leq n - 1$,
i.e. $t_{j,m-1}^{-1} t_{k,m-1} t_{j,l-1} t_{i,k-1} t_{i,l-1}^{-1} = t_{i,l-1}^{-1} t_{i,k-1} t_{j,l-1} t_{k,m-1} t_{j,m-1}^{-1}$.

We naturally regard the generator $t_{i,j}$ of this presentation for $\text{PMod}_{0,n-1}$ as an element of $\text{PMod}_{0,n}$ and denote by X_{n-1} the generating set of the presentation above for $\text{PMod}_{0,n-1}$. Recall that $\pi_1(\Sigma_{0,n-1}, p_n)$ is isomorphic to the free group of rank $n - 2$ and generated by $\omega_1, \omega_2, \dots, \omega_{n-2}$. By applying Lemma 3.2 to the exact sequence (3.1) and the finite presentations for $\text{PMod}_{0,n-1}$ and $\pi_1(\Sigma_{0,n-1}, p_n)$, we have the finite presentation for $\text{PMod}_{0,n}$ whose generating set is $X_{n-1} \cup \{\Delta(\omega_1), \Delta(\omega_2), \dots, \Delta(\omega_{n-2})\}$ and the defining relations are as follows:

- (A) no relations,
- (B) (1) commutative relations $t_{i,j} \varpi t_{k,l}$ for $t_{i,j}, t_{k,l} \in X_{n-1}$ and $j < k, k \leq i < j \leq l$, or $l < i$,
- (2) pentagonal relations $(P_{i,j,k,l,m})$ for $1 \leq i < j < k < l < m \leq n - 1$,
- (C) $t_{i,j} \Delta(\omega_k) t_{i,j}^{-1} = w_{k;i,j}$ for $1 \leq k \leq n - 2, 1 \leq i < j \leq n - 2$ and $(i, j) \neq (1, n - 2)$,

where $w_{k;i,j}$ is some product of $\Delta(\omega_1), \Delta(\omega_2), \dots, \Delta(\omega_{n-2})$. We can show that

$$\Delta(\omega_i) = t_{1,i} t_{i+1,n-1}^{-1} \quad \text{for } 1 \leq i \leq n - 3 \quad \text{and} \quad \Delta(\omega_{n-2}) = t_{1,n-2}.$$

By substituting $\Delta(\omega_i)$ in generators and relations of the presentation for $\text{PMod}_{0,n}$ above for the corresponding product $t_{1,i} t_{i+1,n-1}^{-1}$ or $t_{1,n-2}$ and using Tietze transformations, we obtain a presentation for $\text{PMod}_{0,n}$ whose generators are $t_{i,j}$ for $1 \leq i < j \leq n - 1$ with $(i, j) \neq (1, n - 1)$.

It is enough for completing the proof of Proposition 3.1 to prove that the relation (C) in the presentation for $\text{PMod}_{0,n}$ above is obtained from commutative relations and the pentagonal relations $(P_{i,j,k,l,m})$ for $1 \leq i < j < k < l < m \leq n$. Since $t_{i,j} \Delta(\omega_k) t_{i,j}^{-1} = \Delta(t_{i,j}(\omega_k))$, we will express $t_{i,j}(\omega_k)$ by a product of $\omega_1, \omega_2, \dots, \omega_{n-2}$ in $\pi_1(\Sigma_{0,n-1}, p_n)$ for $1 \leq k \leq n - 2, 1 \leq i < j \leq n - 2$ and $(i, j) \neq (1, n - 2)$. In the cases $j \leq k$ or $k \leq i - 1$, since the simple closed curve $\gamma_{i,j}$ is disjoint from ω_k , we have $t_{i,j}(\omega_k) = \omega_k$. Thus, in this case, the relation (C) coincides with the relation $t_{i,j} \Delta(\omega_k) t_{i,j}^{-1} = \Delta(\omega_k)$ and is obtained from commutative relations.

In the case $i \leq k \leq j - 1$, $\gamma_{i,j}$ and ω_k transversely intersect at two points and $t_{i,j}(\omega_k)$ is a loop based at p_n as in Figure 16. As a product of $\omega_1, \omega_2, \dots, \omega_{n-2}$ in $\pi_1(\Sigma_{0,n-1}, p_n)$, we have $t_{i,j}(\omega_k) = \omega_j \omega_{i-1}^{-1} \omega_k \omega_j^{-1} \omega_{i-1}$. Since the relations $t_{i,j} \Delta(\omega_k) t_{i,j}^{-1} = \Delta(\omega_j) \Delta(\omega_{i-1})^{-1} \Delta(\omega_k) \Delta(\omega_j)^{-1} \Delta(\omega_{i-1}), \Delta(\omega_{i-1}) = t_{1,i-1} t_{i,n-1}^{-1}$,

$\Delta(\omega_k) = t_{1,k}t_{k+1,n-1}^{-1}$, and

$$\Delta(\omega_j) = \begin{cases} t_{1,j}t_{j+1,n-1}^{-1} & \text{for } 2 \leq j \leq n-3, \\ t_{1,n-2} & \text{for } j = n-2, \end{cases}$$

hold in $\text{PMod}_{0,n}$, we have the relation

$$\begin{aligned} & t_{i,j}t_{1,k}t_{k+1,n-1}^{-1}t_{i,j}^{-1} \\ = & \begin{cases} t_{1,j}t_{j+1,n-1}^{-1} \cdot t_{i,n-1} \xrightarrow{t_{1,i-1}^{-1}} t_{1,k}t_{k+1,n-1}^{-1} \cdot t_{j+1,n-1}t_{1,j}^{-1} \cdot t_{1,i-1}t_{i,n-1}^{-1} & \text{for } 2 \leq j \leq n-3, \\ t_{1,n-2} \cdot t_{i,n-1} \xrightarrow{t_{1,i-1}^{-1}} t_{1,k}t_{k+1,n-1}^{-1} \cdot t_{1,n-2}^{-1} \cdot t_{1,i-1}t_{i,n-1}^{-1} & \text{for } j = n-2 \end{cases} \\ \stackrel{\text{COMM}}{=} & \begin{cases} t_{1,j} \xrightarrow{t_{j+1,n-1}^{-1}} t_{i,n-1}t_{1,k}t_{k+1,n-1}^{-1}t_{j+1,n-1}t_{1,j}^{-1}t_{i,n-1}^{-1} & \text{for } 2 \leq j \leq n-3, \\ t_{1,n-2}t_{i,n-1}t_{1,k}t_{k+1,n-1}^{-1}t_{1,n-2}^{-1}t_{i,n-1}^{-1} & \text{for } j = n-2 \end{cases} \\ \stackrel{\text{COMM}}{=} & t_{1,j}t_{i,n-1}t_{1,k}t_{k+1,n-1}^{-1}t_{1,j}^{-1}t_{i,n-1}^{-1}. \end{aligned}$$

Thus, we have

$$\begin{aligned} & t_{i,j}t_{1,k}t_{k+1,n-1}^{-1}t_{i,j}^{-1} = t_{1,j}t_{i,n-1}t_{1,k}t_{k+1,n-1}^{-1}t_{1,j}^{-1}t_{i,n-1}^{-1} \\ \stackrel{\text{COMM}}{\iff} & t_{i,j}t_{1,k}t_{k+1,n-1}^{-1}t_{i,j}^{-1} = t_{1,j}t_{i,n-1}t_{k+1,n-1}^{-1}t_{1,k}t_{1,j}^{-1}t_{i,n-1}^{-1} \\ \stackrel{\text{CONJ}}{\iff} & t_{k+1,n-1}t_{i,n-1}^{-1} \xrightarrow{t_{1,j}^{-1}} t_{1,j}t_{i,j}t_{1,k} = t_{1,k}t_{1,j}^{-1}t_{i,n-1}^{-1}t_{i,j}t_{k+1,n-1} \\ \stackrel{\text{COMM}}{\iff} & t_{k+1,n-1}t_{i,n-1}^{-1}t_{i,j}t_{1,k}t_{1,j}^{-1} = t_{1,j}^{-1}t_{1,k}t_{i,n-1}^{-1}t_{i,j}t_{k+1,n-1} \\ \stackrel{\text{COMM}}{\iff} & t_{i,n-1}^{-1}t_{k+1,n-1}t_{i,j}t_{1,k}t_{1,j}^{-1} = t_{1,j}^{-1}t_{1,k}t_{i,j}t_{k+1,n-1}t_{i,n-1}^{-1}. \end{aligned}$$

Therefore the relation (C) for $1 \leq i \leq k \leq j-1 \leq n-3$ is equivalent to the pentagonal relation $(P_{1,i,k+1,j+1,n})$ up to commutative relations and we have completed the proof of Proposition 3.1. \square

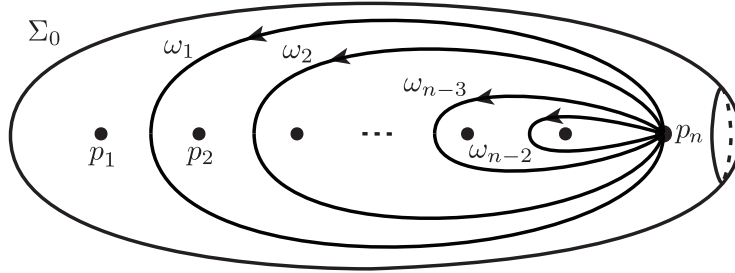

FIGURE 15. Loops $\omega_1, \omega_2, \dots, \omega_{n-2}$ on $\Sigma_0 - \mathcal{B}^1$ based at p_n .

4. GROUP STRUCTURES OF LIFTABLE MAPPING CLASS GROUPS AND BALANCED SUPERELLIPTIC MAPPING CLASS GROUPS VIA GROUP EXTENSIONS

4.1. Group structures of liftable mapping class groups with either one marked point or one boundary component. In this section, we observe the group structures of $\text{LMod}_{2n+2,*}$ and LMod_{2n+1}^1 via group extensions. Recall that, under the identification of the symmetric group S_{2n+2} with the group of self-bijections on $\mathcal{B} = \{p_1, p_2, \dots, p_{2n+2}\}$, the image of the liftable mapping class group

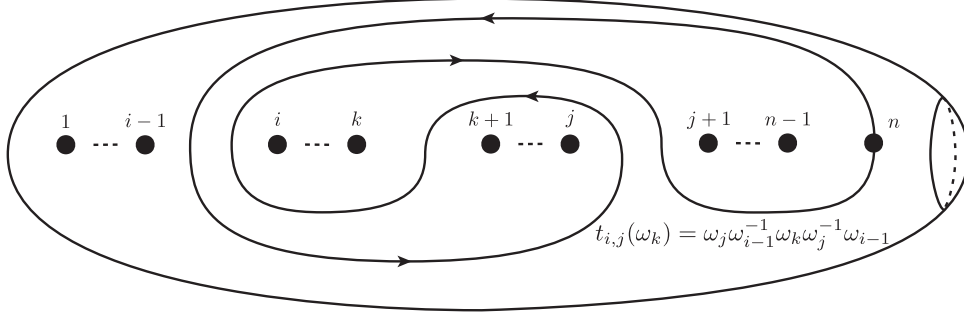

FIGURE 16. A loop $t_{i,j}(\omega_k) = \omega_j \omega_{i-1}^{-1} \omega_k \omega_j^{-1} \omega_{i-1}$ for $i \leq k \leq j-1$.

LMod_{2n+2} by the surjective homomorphism $\Psi: \text{Mod}_{0,2n+2} \rightarrow S_{2n+2}$ coincides with the group $W_{2n+2} \cong (S_{n+1}^o \times S_n^e) \rtimes \mathbb{Z}_2$ by Lemma 2.1 (see Section 2.2). Let $W_{2n+2;*}$ be the subgroup of W_{2n+2} which consists of elements preserving p_{2n+2} and S_n^e the subgroup of W_{2n+2} which consists of elements whose restriction to $\mathcal{B}^o \cup \{p_{2n+2}\}$ is the identity map. By the definitions, all elements in $W_{2n+2;*}$ are parity-preserving and S_n^e coincides with the intersection $S_{n+1}^e \cap W_{2n+2;*}$. Note that S_n^e is isomorphic to S_n and generated by transpositions $(2\ 4), (4\ 6), \dots, (2n-2\ 2n)$. Then we have the following lemma.

Lemma 4.1. *We have $W_{2n+2;*} = S_{n+1}^o \times S_n^e$.*

Proof. Since $S_{n+1}^o \times S_n^e$ is generated by transpositions $\{(i\ i+2) \mid 1 \leq i \leq 2n-1\}$ and these transpositions are parity-preserving and fix p_{2n+2} , the group $S_{n+1}^o \times S_n^e$ is a subgroup of $W_{2n+2;*}$.

For any $\sigma \in W_{2n+2;*}$, we define $\sigma_o, \sigma_e \in W_{2n+2;*}$ as follows:

$$\sigma_o(i) = \begin{cases} \sigma(i) & \text{for } i \in \mathcal{B}_o, \\ i & \text{for } i \in \mathcal{B}_e, \end{cases} \quad \sigma_e(i) = \begin{cases} \sigma(i) & \text{for } i \in \mathcal{B}_e, \\ i & \text{for } i \in \mathcal{B}_o. \end{cases}$$

Since σ preserves p_{2n+2} , by the definitions, we have $\sigma_o \in S_{n+1}^o, \sigma_e \in S_n^e$ and $\sigma = \sigma_o \sigma_e \in S_{n+1}^o \times S_n^e$. We have completed the proof of Lemma 4.1. \square

Recall that we regard $\text{LMod}_{2n+2,*}$ as the subgroup of LMod_{2n+2} which consists of elements fixing the point p_{2n+2} . The next lemma determines the image of $\text{LMod}_{2n+2,*}$ with respect to Ψ .

Lemma 4.2. *We have $\Psi(\text{LMod}_{2n+2,*}) = W_{2n+2;*}$.*

Proof. We take a mapping class $f \in \text{LMod}_{2n+2,*}$. By Lemma 2.1, the image $\Psi(f)$ lies in W_{2n+2} . Since $f(p_{2n+2}) = p_{2n+2}$, $\Psi(f)$ is parity-preserving and fixes p_{2n+2} . Thus we have $\Psi(f) \in W_{2n+2;*}$ and $\Psi(\text{LMod}_{2n+2,*})$ is a subgroup of $W_{2n+2;*}$.

By Lemma 4.1, $W_{2n+2;*}$ is generated by $(i\ i+2)$ for $1 \leq i \leq 2n-1$. Recall that $h_i \in \text{LMod}_{2n+2}$ for $1 \leq i \leq 2n$ is the half-rotation as in Figure 5 and for $1 \leq i \leq 2n-1$, h_i lies in $\text{LMod}_{2n+2,*}$. Since $\Psi(h_i) = (i\ i+2)$ for $1 \leq i \leq 2n$, the restriction of Ψ to $\text{LMod}_{2n+2,*}$ is a surjection on to $W_{2n+2;*}$. We have completed the proof of Lemma 4.2. \square

Recall that all elements in the pure mapping class group $\text{PMod}_{0,2n+2}$ is liftable with respect to the balanced superelliptic covering map $p = p_{g,k}$ and fixes p_{2n+2} . Thus $\text{PMod}_{0,2n+2}$ is a subgroup of $\text{LMod}_{2n+2,*}$. By Lemma 4.2 and restricting the exact sequence (2.2) in Section 2.2 to $\text{LMod}_{2n+2,*}$, we have the following proposition.

Proposition 4.3. *We have the following exact sequence:*

$$(4.1) \quad 1 \longrightarrow \text{PMod}_{0,2n+2} \longrightarrow \text{LMod}_{2n+2,*} \xrightarrow{\Psi} W_{2n+2,*} \longrightarrow 1.$$

The inclusion $\iota: \Sigma_0^1 \hookrightarrow \Sigma_0 = \Sigma_0^1 \cup D$ induces the surjective homomorphism $\iota_*: \text{Mod}_{0,2n+1}^1 \rightarrow \text{Mod}_{0,2n+2,*}$ whose kernel is the infinite cyclic group generated by the Dehn twist $t_{\partial D}$ along ∂D . The homomorphism ι_* is called the *capping homomorphism*. We have the following lemma.

Lemma 4.4. *We have $\iota_*(\text{LMod}_{2n+1}^1) = \text{LMod}_{2n+2,*}$.*

Proof. Assume that $g = n(k-1)$. For any $f \in \text{LMod}_{2n+1}^1$, there exists a representative $\varphi \in f$ and a self-homeomorphism $\tilde{\varphi}$ on Σ_g^1 whose restriction to $\partial\Sigma_g^1$ is the identity map such that $p \circ \tilde{\varphi} = \varphi \circ p$. Denote by φ' (resp. $\tilde{\varphi}'$) the self-homeomorphism on Σ_0 (resp. Σ_g) which is the extension of φ' (resp. $\tilde{\varphi}'$) by the identity map on D (resp. \tilde{D}). By the definitions, we have $p \circ \tilde{\varphi}' = \varphi' \circ p$, i.e. φ' is liftable with respect to $p: \Sigma_g \rightarrow \Sigma_0$, and $\varphi(p_{2n+2}) = p_{2n+2}$. Thus, by the definition of ι_* , we have $\iota_*(f) = [\varphi'] \in \text{LMod}_{2n+2,*}$ and $\iota_*(\text{LMod}_{2n+1}^1) \subset \text{LMod}_{2n+2,*}$.

For any $f \in \text{LMod}_{2n+2,*}$, we take a liftable representative $\varphi \in f$ with respect to $p: \Sigma_g \rightarrow \Sigma_0$. Since φ fixes $p_{2n+2} \in D$, there exists an isotopy $\varphi_t: \Sigma_0 \rightarrow \Sigma_0$ ($t \in [0, 1]$) such that $\varphi_t(\mathcal{B}) = \mathcal{B}$ for $t \in [0, 1]$, $\varphi_0 = \varphi$, and $\varphi_1|_D = \text{id}_D$. Since the liftability with respect to p of a self-homeomorphism on Σ_0 is preserved by isotopies fixing \mathcal{B} , φ_1 is also liftable with respect to p . Hence there exists a self-homeomorphism $\tilde{\varphi}_1$ on Σ_g such that $p \circ \tilde{\varphi}_1 = \varphi_1 \circ p$. Since $\varphi_1|_D = \text{id}_D$, the restriction $\tilde{\varphi}_1|_{\tilde{D}}: \tilde{D} \rightarrow \tilde{D}$ is a covering transformation of the k -fold branched covering space $p|_{\tilde{D}}: \tilde{D} \rightarrow D$, namely $\tilde{\varphi}_1|_{\tilde{D}} = \zeta^l|_{\tilde{D}}$ for some $0 \leq l \leq k-1$. We define $\varphi' = \varphi_1|_{\Sigma_0^1}: \Sigma_0^1 \rightarrow \Sigma_0^1$ and $\tilde{\varphi}' = (\zeta^{-l} \circ \tilde{\varphi}_1)|_{\Sigma_g^1}: \Sigma_g^1 \rightarrow \Sigma_g^1$. By the definitions, $\tilde{\varphi}'$ is the lift of φ' with respect to p whose restriction to $\partial\Sigma_g^1$ is the identity map. Thus, the mapping class $[\varphi']$ lies in LMod_{2n+1}^1 and we have $\iota_*([\varphi']) = [\varphi_1] = [\varphi_0 = \varphi] = f$ in $\text{LMod}_{2n+2,*}$. Therefore, $\iota_*(\text{LMod}_{2n+1}^1) \supset \text{LMod}_{2n+2,*}$ and we have completed the proof of Lemma 4.4. \square

The next proposition gives the group extension of $\text{LMod}_{2n+2,*}$ by the capping homomorphism.

Proposition 4.5. *We have the following exact sequence:*

$$(4.2) \quad 1 \longrightarrow \langle t_{\partial D} \rangle \longrightarrow \text{LMod}_{2n+1}^1 \xrightarrow{\iota_*} \text{LMod}_{2n+2,*} \longrightarrow 1.$$

Proof. Recall that we have the exact sequence

$$1 \longrightarrow \langle t_{\partial D} \rangle \longrightarrow \text{Mod}_{0,2n+1}^1 \xrightarrow{\iota_*} \text{Mod}_{0,2n+2,*} \longrightarrow 1.$$

By Lemma 4.4 and restricting the exact sequence above to LMod_{2n+1}^1 , we have the following exact sequence:

$$1 \longrightarrow \langle t_{\partial D} \rangle \cap \text{LMod}_{2n+1}^1 \longrightarrow \text{LMod}_{2n+1}^1 \xrightarrow{\iota_*} \text{LMod}_{2n+2,*} \longrightarrow 1.$$

Thus, it is enough for completing the proof of Proposition 4.5 to prove that $t_{\partial D}$ is liftable with respect to p . Let ζ' be a self-homeomorphism on Σ_g which is described as a result of a $(-\frac{2\pi}{k})$ -rotation of $\Sigma_g^1 \subset \Sigma_g$ fixing the disk \tilde{D} pointwise (for instance, in the case of $k=3$, ζ' is a $(-\frac{2\pi}{3})$ -rotation as on the top in Figure 17). Since the restriction of ζ' to \tilde{D} is identity, we regard ζ' as an element in $\text{SMod}_{g;k}^1$. Recall that $L = l_1 \cup l_2 \cup \dots \cup l_{2n+1}$ as in Figure 2 and denote by \tilde{L} the preimage of L with respect to p . We remark that the isotopy class of a self-homeomorphism on Σ_0 (resp. Σ_g) relative to $D \cup \mathcal{B}$ (resp. \tilde{D}) is determined by the isotopy class of the image of L (resp. \tilde{L}) relative to $D \cup \mathcal{B}$ (resp. \tilde{D}). We can show that $p(\zeta'(\tilde{L}))$

is isotopic to $t_{\partial D}(L)$ relative to $D \cup \mathcal{B}$ (in the case $k = 3$, see Figure 17). Thus, $t_{\partial D}$ is liftable with respect to p and we can take a lift of $t_{\partial D}$ by ζ' . Therefore, $\langle t_{\partial D} \rangle \cap \text{LMod}_{2n+1}^1 = \langle t_{\partial D} \rangle$ and we have completed the proof of Proposition 4.5. \square

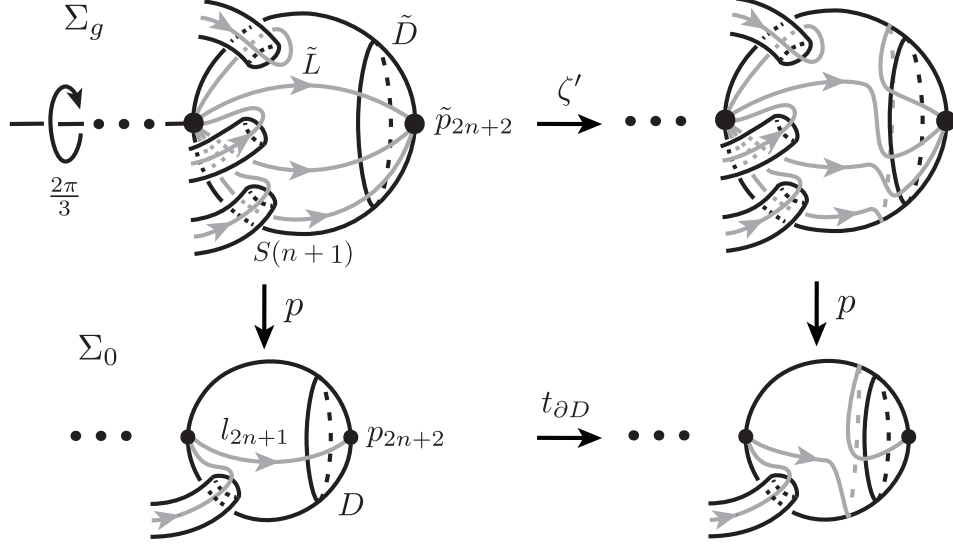

FIGURE 17. The images of L by $t_{\partial D}$ and of \tilde{L} by ζ' for $k = 3$.

4.2. The forgetful homomorphism and the capping homomorphism for the balanced superelliptic mapping class groups. In this section, we will observe the forgetful homomorphism and the capping homomorphism for the balanced superelliptic mapping class groups. Suppose that $n \geq 1$, $k \geq 3$, and $g = n(k - 1)$. Let $\mathcal{F}: \text{Mod}_{g,*} \rightarrow \text{Mod}_g$ be the forgetful homomorphism which is defined by the correspondence $[\varphi] \mapsto [\varphi]$. Recall that $\tilde{p}_{2n+2} \in \Sigma_g$ is the preimage of $p_{2n+2} \in \Sigma_0$ with respect to $p_{g,k}$ and the product $\gamma_1\gamma_2$ for $\gamma_1, \gamma_2 \in \pi_1(\Sigma_g, \tilde{p}_{2n+2})$ means $\gamma_1\gamma_2(t) = \gamma_2(2t)$ for $0 \leq t \leq \frac{1}{2}$ and $\gamma_1\gamma_2(t) = \gamma_1(2t - 1)$ for $\frac{1}{2} \leq t \leq 1$. Birman [1] constructed the following exact sequence (see also Section 4.2 in [6]):

$$(4.3) \quad 1 \longrightarrow \pi_1(\Sigma_g, \tilde{p}_{2n+2}) \xrightarrow{\Delta} \text{Mod}_{g,*} \xrightarrow{\mathcal{F}} \text{Mod}_g \longrightarrow 1,$$

where $\Delta(\gamma)$ for $\gamma \in \pi_1(\Sigma_g, \tilde{p}_{2n+2})$ is a self-homeomorphism on Σ_g which is described as the result of pushing p_{2n+2} along γ once. As a generalization of Theorem 3.1 in [5], we have the following lemma.

Lemma 4.6. *For $g \geq 2$, the restriction $\mathcal{F}|_{\text{SMod}_{g,*,k}}: \text{SMod}_{g,*,k} \rightarrow \text{Mod}_g$ is injective.*

Proof. We will prove this lemma by a similar argument of Brendle and Margalit [5]. By the exact sequence (4.3), we have $\ker \mathcal{F}|_{\text{SMod}_{g,*,k}} = \text{SMod}_{g,*,k} \cap \Delta(\pi_1(\Sigma_g, \tilde{p}_{2n+2}))$. Thus, it is enough for completing the proof of Lemma 4.6 to show that $\zeta\Delta(\alpha) \neq \Delta(\alpha)\zeta^l$ in $\text{SMod}_{g,*,k}$ for any $1 \leq l \leq k - 1$ and a nontrivial element $\alpha \in \pi_1(\Sigma_g, \tilde{p}_{2n+2})$. For $2 \leq l \leq k - 1$, since

$$\mathcal{F}(\zeta\Delta(\alpha)) = \zeta \neq \zeta^l = \mathcal{F}(\Delta(\alpha)\zeta^l),$$

we have $\zeta\Delta(\alpha) \neq \Delta(\alpha)\zeta^l$ in $\text{SMod}_{g,*,k}$. Hence we will show that $\zeta\Delta(\alpha)\zeta^{-1} \neq \Delta(\alpha)$ in $\text{SMod}_{g,*,k}$ for any nontrivial element $\alpha \in \pi_1(\Sigma_g, \tilde{p}_{2n+2})$. By the injectivity of Δ and $\zeta\Delta(\alpha)\zeta^{-1} = \Delta(\zeta(\alpha))$, this condition is equivalent to $\zeta(\alpha) \neq \alpha$ in $\pi_1(\Sigma_g, \tilde{p}_{2n+2})$.

Denote by Σ'_g a $4nk$ -gon which is obtained from Σ_g by cutting Σ_g along $p^{-1}(l_1 \cup l_2 \cup \dots \cup l_{2n})$. We take a hyperbolic structure on Σ_g such that ζ is an isometry on Σ_g and Σ'_g is realized as a fundamental domain of the universal covering $\tilde{p}: \mathbb{H}^2 \rightarrow \Sigma_g$ which is a hyperbolic $4nk$ -gon in the hyperbolic plane \mathbb{H}^2 . Let $\tilde{p}_{2n+2} \in \mathbb{H}^2$ be the center point of $\Sigma'_g \subset \mathbb{H}^2$ and $\tilde{\zeta}$ the $(-\frac{2\pi}{k})$ -rotation of \mathbb{H}^2 around \tilde{p}_{2n+2} . By the construction of Σ'_g and the definition of $\tilde{\zeta}$, the isometry $\tilde{\zeta}$ acts on $\Sigma'_g \subset \mathbb{H}^2$ and $\tilde{\zeta}$ is a lift of ζ with respect to $\tilde{p}: \mathbb{H}^2 \rightarrow \Sigma_g$. Since \tilde{p}_{2n+2} is the unique fixed point of $\tilde{\zeta}$ and any point in $\tilde{p}^{-1}(\{\tilde{p}_1, \tilde{p}_2, \dots, \tilde{p}_{2n+1}\})$ is not fixed by $\tilde{\zeta}$, the point \tilde{p}_{2n+2} is a lift of \tilde{p}_{2n+2} with respect to $\tilde{p}: \mathbb{H}^2 \rightarrow \Sigma_g$.

Let $\alpha: [0, 1] \rightarrow \Sigma_g$ be a loop based at \tilde{p}_{2n+2} which is non-trivial in $\pi_1(\Sigma_g, \tilde{p}_{2n+2})$ and $\tilde{\alpha}: [0, 1] \rightarrow \mathbb{H}^2$ a lift of α with respect to \tilde{p} such that the origin of $\tilde{\alpha}$ is \tilde{p}_{2n+2} . Since $\pi_1(\Sigma_g, \tilde{p}_{2n+2})$ freely acts on $\tilde{p}^{-1}(\tilde{p}_{2n+2})$ as the covering transformation group of \tilde{p} , $\alpha \cdot \tilde{p}_{2n+2} = \tilde{\alpha}(1)$ does not coincide with \tilde{p}_{2n+2} . Assume that $\zeta \circ \alpha = \alpha$. Then the composition $\tilde{\zeta} \circ \tilde{\alpha}$ is also a lift of $\zeta \circ \alpha = \alpha$ with respect to \tilde{p} such that its origin is \tilde{p}_{2n+2} since $\tilde{\zeta}$ fixes \tilde{p}_{2n+2} . Since we have $\tilde{\zeta} \circ \tilde{\alpha} = \tilde{\alpha}$ by the unique lifting property, we show that $\tilde{\zeta}(\tilde{\alpha}(1)) = \tilde{\alpha}(1)$, namely $\tilde{\zeta}$ has distinct two fixed points \tilde{p}_{2n+2} and $\tilde{\alpha}(1)$. This contradicts the fact that $\tilde{\zeta}$ has the unique fixed point. Therefore, we have $\zeta \circ \alpha \neq \alpha$ and have completed the proof of Lemma 4.6. \square

We remark that the image of the restriction $\mathcal{F}|_{\text{SMod}_{g,*,k}}$ is included in $\text{SMod}_{g;k}$ and $\mathcal{F}|_{\text{SMod}_{g,*,k}}: \text{SMod}_{g,*,k} \rightarrow \text{SMod}_{g;k}$ is not surjective.

Let $\theta: \text{SMod}_{g;k} \rightarrow \text{LMod}_{2n+2}$ be the surjective homomorphism with the kernel $\langle \zeta \rangle$ which is obtained from the Birman-Hilden correspondence [3], namely θ is defined as follows: for $f \in \text{SMod}_{g;k}$ and a symmetric representative $\varphi \in f$ for ζ , we define $\hat{\varphi}: \Sigma_0 \rightarrow \Sigma_0$ by $\hat{\varphi}(x) = p(\varphi(\tilde{x}))$ for some $\tilde{x} \in p^{-1}(x)$. Then $\theta(f) = [\hat{\varphi}] \in \text{LMod}_{2n+2}$. We have the following proposition.

Proposition 4.7. *For $g \geq 2$, we have $\mathcal{F}(\text{SMod}_{g,*,k}) = \theta^{-1}(\text{LMod}_{2n+2,*})$.*

Proof. For any $f \in \text{SMod}_{g,*,k}$, we take a symmetric representative $\varphi \in f$ and the corresponding homeomorphism $\hat{\varphi}: \Sigma_0 \rightarrow \Sigma_0$ defined above. Since φ preserves the point \tilde{p}_{2n+2} by the definition of $\text{SMod}_{g,*,k}$ and $\varphi \circ p = p \circ \hat{\varphi}$ holds, $\hat{\varphi}$ also preserves the point $p(\tilde{p}_{2n+2}) = p_{2n+2}$. Thus, we have $\theta(f) = [\hat{\varphi}] \in \text{LMod}_{2n+2,*}$ and show that $\mathcal{F}(\text{SMod}_{g,*,k}) \subset \theta^{-1}(\text{LMod}_{2n+2,*})$.

For $f \in \text{SMod}_{g,k}$, we assume that $\theta(f) \in \text{LMod}_{2n+2,*}$. Then there exist a representative $\varphi \in \theta(f)$ with $\varphi(p_{2n+2}) = p_{2n+2}$ and a homeomorphism $\tilde{\varphi}: \Sigma_g \rightarrow \Sigma_g$ such that $p \circ \tilde{\varphi} = \varphi \circ p$. Then, since \tilde{p}_{2n+2} is the unique preimage of p_{2n+2} with respect to p , we can see that $\tilde{\varphi}(\tilde{p}_{2n+2}) = \tilde{p}_{2n+2}$. Since $f[\tilde{\varphi}]^{-1}$ lies in the kernel of θ , there exists $0 \leq l \leq k-1$ such that $f[\tilde{\varphi}]^{-1} = \zeta^l$. Hence we have $f = \zeta^l[\tilde{\varphi}] \in \text{SMod}_{g,*,k}$. Since ζ and $\tilde{\varphi}$ preserve the point \tilde{p}_{2n+2} , the composition $\zeta^l \circ \tilde{\varphi}$ also preserves \tilde{p}_{2n+2} . Thus we have the mapping class $\zeta^l[\tilde{\varphi}] \in \text{SMod}_{g,*,k}$ and $f = \mathcal{F}(\zeta^l[\tilde{\varphi}]) \in \mathcal{F}(\text{SMod}_{g,*,k})$. Therefore, we have completed the proof of Proposition 4.7. \square

By Lemma 4.6 and Proposition 4.7, we regard $\text{SMod}_{g,*,k}$ as a subgroup of $\text{SMod}_{g;k}$ which consists of elements represented by symmetric elements preserving \tilde{p}_{2n+2} . The next lemma is given by Proposition 2.1 in [7].

Lemma 4.8. *For $g \geq 2$, any element in $\text{SMod}_{g;k}^1$ has representative which commutes with ζ .*

The inclusion $\tilde{\iota}: \Sigma_g^1 \hookrightarrow \Sigma_g = \Sigma_g^1 \cup \tilde{D}$ induces the surjective homomorphism $\tilde{\iota}_*: \text{Mod}_g^1 \rightarrow \text{Mod}_{g,*}$ whose kernel is the infinite cyclic group generated by the Dehn twist $t_{\partial\tilde{D}}$ along $\partial\tilde{D}$. The homomorphism $\tilde{\iota}_*$ is also called the *capping homomorphism*. We have the following lemma.

Lemma 4.9. *For $g \geq 2$, $\tilde{\iota}_*(\text{SMod}_{g;k}^1) = \text{SMod}_{g,*;k}$.*

Proof. For any $f \in \text{SMod}_{g;k}^1$, by Lemma 4.8, there exists a representative φ of f such that φ commutes with ζ . Denote by φ' the self-homeomorphism on $\Sigma_g = \Sigma_g^1 \cup \tilde{D}$ which is the extension of φ by the identity map on \tilde{D} . By the definition, φ' commutes with ζ and preserves \tilde{p}_{2n+2} . Thus $\tilde{\iota}_*(f) = [\varphi'] \in \text{SMod}_{g,*;k}$, namely we have $\tilde{\iota}_*(\text{SMod}_{g;k}^1) \subset \text{SMod}_{g,*;k}$.

Recall that $\theta: \text{SMod}_{g;k} \rightarrow \text{LMod}_{2n+2}$ is the surjective homomorphism with the kernel $\langle \zeta \rangle$ which is obtained from the Birman-Hilden correspondence [3] and we regard $\text{SMod}_{g,*;k}$ as a subgroup of $\text{SMod}_{g;k}$ by Lemma 4.6. By Proposition 4.7, the restriction $\theta: \text{SMod}_{g,*;k} \rightarrow \text{LMod}_{2n+2,*}$ is surjective. By the result of Birman and Hilden [3], we have an isomorphism $\theta^1: \text{SMod}_{g;k}^1 \rightarrow \text{LMod}_{2n+1}^1$ which is similarly defined to θ as before Proposition 4.7. Then we have the following commutative diagram:

$$\begin{array}{ccc} \text{SMod}_{g;k}^1 & \xrightarrow{\tilde{\iota}_*} & \text{SMod}_{g,*;k} \\ \theta^1 \downarrow & \circlearrowleft & \downarrow \theta \\ \text{LMod}_{2n+1}^1 & \xrightarrow{\iota_*} & \text{LMod}_{2n+2,*} \end{array}$$

We also recall that ζ' is the self-homeomorphism on Σ_g which is defined in the proof of Proposition 4.5 (see also Figure 17). Remark that the restriction of ζ' to \tilde{D} is the identity map and $\tilde{\iota}_*([\zeta']) = [\zeta] \in \text{SMod}_{g,*;k}$.

We take any $f \in \text{SMod}_{g,*;k}$. By Lemma 4.4, ι_* is surjective, there exists $\hat{f}' \in \text{LMod}_{2n+1}^1$ such that $\iota_*(\hat{f}') = \theta(f)$. Put $f'_0 = (\theta^1)^{-1}(\hat{f}') \in \text{SMod}_{g;k}^1$. Since we have

$$\begin{aligned} \theta(\tilde{\iota}_*(f'_0) \cdot f^{-1}) &= \theta(\tilde{\iota}_*(f'_0)) \cdot \theta(f)^{-1} = \iota_*(\theta^1(f'_0)) \cdot \theta(f)^{-1} \\ &= \iota_*(\hat{f}') \cdot \theta(f)^{-1} = \theta(f) \cdot \theta(f)^{-1} \\ &= 1, \end{aligned}$$

there exists an integer $0 \leq l \leq k-1$ such that $\tilde{\iota}_*(f'_0) \cdot f^{-1} = [\zeta]^l \in \text{SMod}_{g,*;k}$. Thus we have $[\zeta']^{-l} f'_0 \in \text{SMod}_{g;k}^1$ and

$$\begin{aligned} \tilde{\iota}_*([\zeta']^{-l} f'_0) &= \tilde{\iota}_*([\zeta'])^{-l} \tilde{\iota}_*(f'_0) = [\zeta]^{-l} [\zeta]^l f \\ &= f. \end{aligned}$$

Therefore we have $\tilde{\iota}_*(\text{SMod}_{g;k}^1) \supset \text{SMod}_{g,*;k}$ and have completed the proof of Lemma 4.9. \square

The capping homomorphism $\tilde{\iota}_*: \text{Mod}_g^1 \rightarrow \text{Mod}_{g,*}$ induces the exact sequence

$$1 \longrightarrow \langle t_{\partial\tilde{D}} \rangle \longrightarrow \text{Mod}_g^1 \xrightarrow{\tilde{\iota}_*} \text{Mod}_{g,*} \longrightarrow 1.$$

Since $t_{\partial\tilde{D}}$ commutes with ζ , we have $\langle t_{\partial\tilde{D}} \rangle \cap \text{SMod}_{g;k}^1 = \langle t_{\partial\tilde{D}} \rangle$. By Lemma 4.9 and restricting the exact sequence above to $\text{SMod}_{g;k}^1$, we have the following proposition.

Proposition 4.10. *For $g \geq 2$, we have the following exact sequence:*

$$(4.4) \quad 1 \longrightarrow \langle t_{\partial\tilde{D}} \rangle \longrightarrow \text{SMod}_{g;k}^1 \xrightarrow{\tilde{\iota}_*} \text{SMod}_{g,*;k} \longrightarrow 1.$$

5. PRESENTATIONS FOR THE LIFTABLE MAPPING CLASS GROUPS

Recall that we assume the n is a positive integer throughout this paper.

5.1. Main theorems for the liftable mapping class groups. Recall that for elements f and h in a group G , $f \rightleftharpoons h$ means the commutative relation $fh = hf$ in G . Main theorems of this paper for the liftable mapping class groups are as follows.

Theorem 5.1. *The group LMod_{2n+1}^1 admits the presentation with generators h_i for $1 \leq i \leq 2n - 1$ and $t_{i,j}$ for $1 \leq i < j \leq 2n + 1$, and the following defining relations:*

- (1) commutative relations
 - (a) $h_i \rightleftharpoons h_j$ for $j - i \geq 3$,
 - (b) $t_{i,j} \rightleftharpoons t_{k,l}$ for $j < k$, $k \leq i < j \leq l$, or $l < i$,
 - (c) $h_k \rightleftharpoons t_{i,j}$ for $k + 2 < i$, $i \leq k < k + 2 \leq j$, or $j < k$,
- (2) relations among h_i 's and $t_{j,j+1}$'s:
 - (a) $h_i^{\pm 1} t_{i,i+1} = t_{i+1,i+2} h_i^{\pm 1}$ for $1 \leq i \leq 2n - 1$,
 - (b) $h_i^\varepsilon h_{i+1}^\varepsilon t_{i,i+1} = t_{i+2,i+3} h_i^\varepsilon h_{i+1}^\varepsilon$ for $1 \leq i \leq 2n - 2$ and $\varepsilon \in \{1, -1\}$,
 - (c) $h_i^\varepsilon h_{i+1}^\varepsilon h_{i+2}^\varepsilon h_i^\varepsilon = h_{i+2}^\varepsilon h_i^\varepsilon h_{i+1}^\varepsilon h_{i+2}^\varepsilon$ for $1 \leq i \leq 2n - 3$ and $\varepsilon \in \{1, -1\}$,
 - (d) $h_i h_{i+1} t_{i,i+1} = t_{i,i+1} h_{i+1} h_i$ for $1 \leq i \leq 2n - 2$,
 - (e) $h_i h_{i+2} h_i t_{i+1,i+2}^{-1} = t_{i+2,i+3}^{-1} h_{i+2} h_i h_{i+2}$ for $1 \leq i \leq 2n - 3$,
- (3) the pentagonal relations $(P_{i,j,k,l,m})$ for $1 \leq i < j < k < l < m \leq 2n + 2$, i.e. $t_{j,m-1}^{-1} t_{k,m-1} t_{j,l-1} t_{i,k-1} t_{i,l-1}^{-1} = t_{i,l-1}^{-1} t_{i,k-1} t_{j,l-1} t_{k,m-1} t_{j,m-1}^{-1}$,
- (4) (a) the relations $(T_{i,j})$ for $1 \leq i < j \leq 2n + 1$, i.e.

$$t_{i,j} = \begin{cases} h_i^2 & \text{for } j - i = 2, \\ t_{j-1,j}^{-\frac{j-i-3}{2}} \cdots t_{i+2,i+3}^{-\frac{j-i-3}{2}} t_{i,i+1}^{-\frac{j-i-3}{2}} (h_{j-2} \cdots h_{i+1} h_i)^{\frac{j-i+1}{2}} & \text{for } 2n - 1 \geq j - i \geq 3 \text{ is odd,} \\ t_{j-2,j-1}^{-\frac{j-i-2}{2}} \cdots t_{i+2,i+3}^{-\frac{j-i-2}{2}} t_{i,i+1}^{-\frac{j-i-2}{2}} h_{j-2} \cdots h_{i+2} h_i h_i h_{i+2} \cdots h_{j-2} & \cdot (h_{j-3} \cdots h_{i+1} h_i)^{\frac{j-i}{2}} \text{ for } 2n \geq j - i \geq 4 \text{ is even.} \end{cases}$$

Remark that by the relation (1) (b) in Theorem 5.1, if $j - i$ is even, then $t_{i,i+1}$ commutes with $t_{j,j+1}$. The relations (2) (a)–(c) in Theorem 5.1 are the relations (1)–(3) in Lemma 2.3, i.e. conjugation relations, and the relations (2) (d) and (e) in Theorem 5.1 are equivalent to the relations (2) and (3) in Lemma 2.4 up to the relations (2) (a) and (b) in Theorem 5.1.

Theorem 5.2. *The group $\text{LMod}_{2n+2,*}$ admits the presentation which is obtained from the finite presentation for LMod_{2n+1}^1 in Theorem 5.1 by adding the relation*

$$(4) (b) t_{1,2n+1} = 1.$$

Theorem 5.3. *The group LMod_{2n+2} admits the presentation which is obtained from the finite presentation for $\text{LMod}_{2n+2,*}$ in Theorem 5.2 by adding generators h_{2n} and r , and the following relations:*

- (4) (c) $t_{1,2n}^{-n+1} t_{2n-1,2n}^{-n+1} \cdots t_{3,4}^{-n+1} t_{1,2}^{-n+1} (h_{2n} \cdots h_2 h_1)^{n+1} = 1$,
- (5) relations among r and h_i 's or $t_{i,j}$'s:
 - (a) $r^2 = 1$,
 - (b) $r h_i = h_{2n-i+1} r$ for $1 \leq i \leq 2n$,
 - (c) $r t_{i,i+1} = t_{2n-i+2,2n-i+3} r$ for $2 \leq i \leq 2n$,
 - (d) $r t_{1,j} = t_{1,2n-j+2} r$ for $2 \leq j \leq 2n$.

The defining relations above are introduced in Lemma 2.2, 2.3, 2.4, 2.5, and 2.6. By Theorems 5.1, 5.2, and 5.3, we have the following corollary.

Corollary 5.4. *(1) The groups LMod_{2n+1}^1 and $\text{LMod}_{2n+2,*}$ are generated by $h_1, h_2, \dots, h_{2n-1}$, and $t_{1,2}$,*

(2) The group LMod_{2n+2} is generated by $h_1, h_3, \dots, h_{2n-1}, t_{1,2}$, and r .

Proof. By Theorem 5.1, LMod_{2n+1}^1 is generated by h_i for $1 \leq i \leq 2n-1$ and $t_{i,j}$ for $1 \leq i < j \leq 2n+1$. By the relation (4) (a) in Theorem 5.1, $t_{i,j}$ for $1 \leq i < j \leq 2n+1$ is a product of h_i ($1 \leq i \leq 2n-1$) and $t_{i,i+1}$ ($1 \leq i \leq 2n$). By the relation (2) (a) in Theorem 5.1, we show that $t_{i,i+1}$ is a product of $h_1, h_2, \dots, h_{2n-1}$, and $t_{1,2}$. By Lemma 4.4, we have $\iota_*(\text{LMod}_{2n+1}^1) = \text{LMod}_{2n+2,*}$. Therefore, LMod_{2n+1}^1 and $\text{LMod}_{2n+2,*}$ are generated by $h_1, h_2, \dots, h_{2n-1}$, and $t_{1,2}$.

By Theorem 5.3, LMod_{2n+2} is generated by h_i for $1 \leq i \leq 2n$, $t_{i,j}$ for $1 \leq i < j \leq 2n+1$, and r . By a similar argument in the case (1), every $t_{i,j}$ is a product of h_i ($1 \leq i \leq 2n$) and $t_{1,2}$. By the relation (2) (d) in Theorem 5.3, we show that h_2, h_4, \dots, h_{2n} are products of $h_1, h_3, \dots, h_{2n-1}, t_{1,2}$, and r . Therefore, LMod_{2n+2} is generated by $h_1, h_3, \dots, h_{2n-1}, t_{1,2}$, and r , and we have completed Corollary 5.4. \square

5.2. Proofs of presentations for the liftable mapping class groups.

Throughout this section, a label in a deformation of a relation indicates one of relations in Theorems 5.1, 5.2, and 5.3. For instance, $A \stackrel{(1)(a)}{=} B$ (resp. $A = B \stackrel{(1)(a)}{\iff} A' = B'$) means that B (resp. the relation $A' = B'$) is obtained from A (resp. the relation $A = B$) by the relation (1) (a) in Theorem 5.1. First, we prove the following lemma.

Lemma 5.5. *In LMod_{2n+2} , the relations*

- (1) (a') $h_i \rightleftharpoons h_{2n}$ for $1 \leq i \leq 2n-3$,
- (c') $h_{2n} \rightleftharpoons t_{i,j}$ for $1 \leq i < j \leq 2n-1$,
- (2) (a') $h_{2n}^{\pm 1} t_{2n,2n+1} = t_{1,2n} h_{2n}^{\pm 1}$,
- (b') $h_{2n-1}^{\varepsilon} h_{2n}^{\varepsilon} t_{2n-1,2n} = t_{1,2n} h_{2n-1}^{\varepsilon} h_{2n}^{\varepsilon}$ for $\varepsilon \in \{1, -1\}$,
- (c') $h_{2n-2}^{\varepsilon} h_{2n-1}^{\varepsilon} h_{2n}^{\varepsilon} h_{2n-2}^{\varepsilon} = h_{2n}^{\varepsilon} h_{2n-2}^{\varepsilon} h_{2n-1}^{\varepsilon} h_{2n}^{\varepsilon}$ for $\varepsilon \in \{1, -1\}$,
- (d') $h_{2n-1} h_{2n} t_{2n-1,2n} = t_{2n-1,2n} h_{2n} h_{2n-1}$,
- (e') $h_{2n-2} h_{2n} h_{2n-2} t_{2n-1,2n}^{-1} = t_{2n,2n+1}^{-1} h_{2n+2} h_{2n} h_{2n+2}$,
- (4) (a') $t_{1,2n-1} = h_{2n}^2$

is obtained from the relations (1), (2), (4) (a), and (5) in Theorem 5.3.

Proof. By the conjugations by r , the relations (1) (a'), (c'), (2) (a'), (b'), (c'), and (4) (a') are obtained from the relations (1) (a), (c), (2) (a), (b), (c), and (4) (a) up to the relations (5) (b), (c), (d). For instance, for the relation (2) (b'), we have

$$\begin{aligned}
& h_{2n-1}^{\varepsilon} h_{2n}^{\varepsilon} t_{2n-1,2n} = t_{1,2n} h_{2n-1}^{\varepsilon} h_{2n}^{\varepsilon} \\
& \stackrel{\text{CONJ}}{\iff} r h_{2n-1}^{\varepsilon} h_{2n}^{\varepsilon} t_{2n-1,2n} r^{-1} = r t_{1,2n} h_{2n-1}^{\varepsilon} h_{2n}^{\varepsilon} r^{-1} \\
(5) \stackrel{(b),(c),(d)}{\iff} & h_2^{\varepsilon} h_1^{\varepsilon} t_{3,4} = t_{1,2} h_2^{\varepsilon} h_1^{\varepsilon} \\
& \stackrel{\text{CONJ}}{\iff} t_{1,2}^{-1} h_2^{\varepsilon} h_1^{\varepsilon} = h_2^{\varepsilon} h_1^{\varepsilon} t_{3,4}^{-1} \\
& \stackrel{\text{inverse}}{\iff} h_1^{-\varepsilon} h_2^{-\varepsilon} t_{1,2} = t_{3,4} h_1^{-\varepsilon} h_2^{-\varepsilon} \\
& \iff \text{the relation (2) (b) for } i = 1.
\end{aligned}$$

For the relation (2) (d'), we have

$$\begin{aligned}
& h_{2n-1} h_{2n} t_{2n-1,2n} = t_{2n-1,2n} h_{2n} h_{2n-1} \\
& \stackrel{\text{CONJ}}{\iff} r h_{2n-1} h_{2n} t_{2n-1,2n} r^{-1} = r t_{2n-1,2n} h_{2n} h_{2n-1} r^{-1} \\
(5) \stackrel{(b),(c),(d)}{\iff} & h_2 h_1 t_{3,4} = t_{3,4} h_1 h_2 \\
& \stackrel{(2)(b)}{\iff} t_{1,2} h_2 h_1 = h_1 h_2 t_{1,2}
\end{aligned}$$

\iff the relation (2) (d) for $i = 1$.

Hence the relation (2) (d') is obtained from the relation (2). By a similar argument, we can check that the relation (2) (e') is obtained from the relations (1) and (2). We have completed the proof of Lemma 5.5. \square

By Lemma 5.5, the relations (1) (a'), (c'), (2) (a')–(e'), and (4) (a') in Lemma 5.5 are obtained from the relations in Theorems 5.3. For conveniences, throughout this paper, we call the relations (1) (a'), (c'), (2) (a')–(e'), and (4) (a') in Lemma 5.5 the relations (1) (a), (c), (2) (a)–(e), and (4) (a), respectively.

Recall that W_{2n+2} is the subgroup of the symmetric group S_{2n+2} which consists of parity-preserving or parity-reversing elements, we define $\bar{h}_i = (i \ i+2)$ for $1 \leq i \leq 2n$ and $\bar{r} = (1 \ 2n+2)(2 \ 2n+1) \cdots (n+1 \ n+2)$ (see Sections 2.2 and 2.3). First we give a finite presentation for W_{2n+2} which is slightly different from Ghaswala-Winarski's presentation in Lemma 4.2 of [9].

Lemma 5.6. *The group W_{2n+2} admits the presentation with generators \bar{h}_i for $1 \leq i \leq 2n$ and \bar{r} , and the following defining relations:*

- (1) $\bar{h}_i^2 = 1$ for $1 \leq i \leq 2n$,
- (2) $\bar{h}_i \bar{h}_j \bar{h}_i^{-1} \bar{h}_j^{-1} = 1$ for “ $j - i = 1$ or $j - i \geq 3$ ” and $1 \leq i < j \leq 2n$,
- (3) $\bar{h}_i \bar{h}_{i+2} \bar{h}_i \bar{h}_{i+2}^{-1} \bar{h}_i^{-1} \bar{h}_{i+2}^{-1} = 1$ for $1 \leq i \leq 2n - 2$,
- (4) $\bar{r}^2 = 1$,
- (5) $\bar{r} \bar{h}_i = \bar{h}_{2n-i+1} \bar{r}$ for $1 \leq i \leq 2n$.

Proof. We will apply Lemma 3.2 to the exact sequence (2.1). Since the subgroup $S_{n+1}^o \times S_{n+1}^e$ of W_{2n+2} is isomorphic to $S_{n+1} \times S_{n+1}$, the group $S_{n+1}^o \times S_{n+1}^e$ has the presentation with generators \bar{h}_i for $1 \leq i \leq 2n$ and the following defining relations:

- $\bar{h}_i^2 = 1$ for $1 \leq i \leq 2n$,
- $\bar{h}_i \bar{h}_j \bar{h}_i^{-1} \bar{h}_j^{-1} = 1$ for “ $j - i = 1$ or $j - i \geq 3$ ” and $1 \leq i < j \leq 2n$,
- $\bar{h}_i \bar{h}_{i+2} \bar{h}_i \bar{h}_{i+2}^{-1} \bar{h}_i^{-1} \bar{h}_{i+2}^{-1} = 1$ for $1 \leq i \leq 2n - 2$.

Since \mathbb{Z}_2 in the exact sequence (2.1) is generated by an element which is represented by a parity-reversing element, $\pi(\bar{r})$ generates the group \mathbb{Z}_2 . By applying Lemma 3.2 to the exact sequence (2.1) and presentations for $S_{n+1}^o \times S_{n+1}^e$ and \mathbb{Z}_2 above, we have the presentation for W_{2n+2} whose generators are \bar{h}_i for $1 \leq i \leq 2n$ and \bar{r} and the defining relations are as follows:

- (A) (1) $\bar{h}_i^2 = 1$ for $1 \leq i \leq 2n$,
- (2) $\bar{h}_i \bar{h}_j \bar{h}_i^{-1} \bar{h}_j^{-1} = 1$ for “ $j - i = 1$ or $j - i \geq 3$ ” and $1 \leq i < j \leq 2n$,
- (3) $\bar{h}_i \bar{h}_{i+2} \bar{h}_i \bar{h}_{i+2}^{-1} \bar{h}_i^{-1} \bar{h}_{i+2}^{-1} = 1$ for $1 \leq i \leq 2n - 2$,
- (B) $\bar{r}^2 = 1$,
- (C) $\bar{r} \bar{h}_i \bar{r}^{-1} = \bar{h}_{2n-i+1}$ for $1 \leq i \leq 2n$.

This presentation is equivalent to the presentation in Lemma 5.6. Therefore, we have completed the proof of Lemma 5.6. \square

By Lemma 4.1, we have $W_{2n+2;*} = S_{n+1}^o \times S_n^e$. Since $S_{n+1}^o \times S_n^e$ is isomorphic to $S_{n+1} \times S_n$, we have the following lemma.

Lemma 5.7. *For $n \geq 1$, $W_{2n+2;*}$ admits the presentation with generators \bar{h}_i for $1 \leq i \leq 2n - 1$ and the following defining relations:*

- (1) $\bar{h}_i^2 = 1$ for $1 \leq i \leq 2n - 1$,
- (2) $\bar{h}_i \bar{h}_j \bar{h}_i^{-1} \bar{h}_j^{-1} = 1$ for “ $j - i = 1$ or $j - i \geq 3$ ” and $1 \leq i < j \leq 2n - 1$,
- (3) $\bar{h}_i \bar{h}_{i+2} \bar{h}_i \bar{h}_{i+2}^{-1} \bar{h}_i^{-1} \bar{h}_{i+2}^{-1} = 1$ for $1 \leq i \leq 2n - 3$.

Applying Lemma 3.2 to the exact sequence (4.1) in Proposition 4.3, we have the following proposition.

Proposition 5.8. *The group $\text{LMod}_{2n+2,*}$ admits the presentation with generators h_i for $1 \leq i \leq 2n-1$ and $t_{i,j}$ for $1 \leq i \leq j \leq 2n+1$, and the following defining relations:*

- (1) commutative relations
 - (a) $h_i \rightleftharpoons h_j$ for $j-i \geq 3$,
 - (b) $t_{i,j} \rightleftharpoons t_{k,l}$ for $j < k, k \leq i < j \leq l$, or $l < i$,
 - (c) $h_k \rightleftharpoons t_{i,j}$ for $k+2 < i, i \leq k < k+2 \leq j$, or $j < k$,
- (2) pentagonal relations $(P_{i,j,k,l,m})$ for $1 \leq i < j < k < l < m \leq 2n+2$,
i.e. $t_{j,m-1}^{-1} t_{k,m-1} t_{j,l-1} t_{i,k-1} t_{i,l-1}^{-1} = t_{i,l-1}^{-1} t_{i,k-1} t_{j,l-1} t_{k,m-1} t_{j,m-1}^{-1}$,
- (3) lifts of relations in the symmetric group
 - (a) $h_i^2 = t_{i,i+2}$ for $1 \leq i \leq 2n-1$,
 - (b) $h_i h_{i+1} h_i^{-1} h_{i+1}^{-1} = t_{i,i+1} t_{i+2,i+3}^{-1}$ for $1 \leq i \leq 2n-2$,
 - (c) $h_i h_{i+2} h_i h_{i+2}^{-1} h_i^{-1} h_{i+2}^{-1} = t_{i+1,i+2} t_{i+2,i+3}^{-1}$ for $1 \leq i \leq 2n-3$,
- (4) (a) $h_k t_{i,j} h_k^{-1} = \begin{cases} t_{i+1,j} t_{i-1,i} t_{i-2,j} t_{i-1,j}^{-1} t_{i-2,i}^{-1} & \text{for } k = i-2 \text{ and } 3 \leq i < j \leq 2n+1, \\ t_{i+2,j} t_{i-1,j} t_{i-1,i} t_{i+1,j}^{-1} t_{i-1,i+1}^{-1} & \text{for } k = i-1 \text{ and } 2 \leq i < j-1 \leq 2n, \\ t_{i-1,i} & \text{for } k = i-1 \text{ and } 2 \leq i = j-1 \leq 2n, \\ t_{i,j-1} t_{j,j+1} t_{i,j+2} t_{i,j+1}^{-1} t_{j,j+2}^{-1} & \text{for } k = j \text{ and } 1 \leq i < j \leq 2n-1, \\ t_{i,j-2} t_{j,j+1} t_{i,j+1} t_{i,j-1}^{-1} t_{j-1,j+1}^{-1} & \text{for } k = j-1 \text{ and } 2 \leq i+1 < j \leq 2n, \\ t_{j,j+1} & \text{for } k = j-1 \text{ and } 2 \leq i+1 = j \leq 2n, \end{cases}$
- (5) $t_{i,i} = t_{1,2n+1} = 1$ for $1 \leq i \leq 2n+1$.

Proof. By Proposition 3.1 and adding the generator $t_{1,2n+1}$ and the relation $t_{1,2n+1} = 1$, $\text{PMod}_{0,2n+2}$ admits the presentation with generators $t_{i,j}$ ($1 \leq i < j \leq 2n+1$) and the following defining relations:

- (1) $t_{i,j} \rightleftharpoons t_{k,l}$ for $j < k, k \leq i < j \leq l$, or $l < i$,
- (2) pentagonal relations $(P_{i,j,k,l,m})$ for $1 \leq i < j < k < l < m \leq 2n+1$,
- (3) $t_{1,2n+1} = 1$,

and by Lemma 5.7, $W_{2n+2,*}$ admits the presentation with generators \bar{h}_i ($1 \leq i \leq 2n-1$) and the following defining relations:

- (1) $\bar{h}_i^2 = 1$ for $1 \leq i \leq 2n-1$,
- (2) $\bar{h}_i \bar{h}_j \bar{h}_i^{-1} \bar{h}_j^{-1} = 1$ for “ $j-i = 1$ or $j-i \geq 3$ ” and $1 \leq i < j \leq 2n-1$,
- (3) $\bar{h}_i \bar{h}_{i+2} \bar{h}_i \bar{h}_{i+2}^{-1} \bar{h}_i^{-1} \bar{h}_{i+2}^{-1} = 1$ for $1 \leq i \leq 2n-3$.

Since $\Psi(h_i) = \bar{h}_i$ for $1 \leq i \leq 2n-1$ and the relations $h_i^2 = t_{i,i+2}$ ($1 \leq i \leq 2n-1$), $h_i \rightleftharpoons h_j$ ($j-i > 3$), $h_i h_{i+1} h_i^{-1} h_{i+1}^{-1} = t_{i,i+1} t_{i+2,i+3}^{-1}$ ($1 \leq i \leq 2n-2$), and $h_i h_{i+2} h_i h_{i+2}^{-1} h_i^{-1} h_{i+2}^{-1} = t_{i+1,i+2} t_{i+2,i+3}^{-1}$ ($1 \leq i \leq 2n-3$) hold in $\text{LMod}_{2n+2,*}$ by Lemma 2.2 and 2.4, applying Lemma 3.2 to the exact sequence (4.1) in Proposition 4.3, we show that $\text{LMod}_{2n+2,*}$ has the presentation whose generators are h_i ($1 \leq i \leq 2n-1$) and $t_{i,j}$ ($1 \leq i \leq j \leq 2n+1$) and defining relations are as follows:

- (A) (a) $t_{i,j} \rightleftharpoons t_{k,l}$ for $j < k, k \leq i < j \leq l$, or $l < i$,
- (b) pentagonal relations $(P_{i,j,k,l,m})$ for $1 \leq i < j < k < l < m \leq 2n+2$,
- (c) $t_{1,2n+1} = 1$,
- (B) (a) $h_i^2 = t_{i,i+2}$ for $1 \leq i \leq 2n-1$,
- (b) $h_i \rightleftharpoons h_j$ for $j-i > 3$,
- (c) $h_i h_{i+1} h_i^{-1} h_{i+1}^{-1} = t_{i,i+1} t_{i+2,i+3}^{-1}$ for $1 \leq i \leq 2n-2$,
- (d) $h_i h_{i+2} h_i h_{i+2}^{-1} h_i^{-1} h_{i+2}^{-1} = t_{i+1,i+2} t_{i+2,i+3}^{-1}$ for $1 \leq i \leq 2n-3$,
- (C) $h_k t_{i,j} h_k^{-1} = w_{i,j;k}$ for $1 \leq i < j \leq 2n+1$, $(i,j) \neq (1,2n+1)$, and $1 \leq k \leq 2n-1$,

where $w_{i,j;k}$ is a word in $\{t_{i,j}^\varepsilon \mid 1 \leq i < j \leq 2n+1, (i,j) \neq (1,2n+1), \varepsilon \in \{\pm 1\}\}$. The relations (A) (a) and (B) (b) above coincide with the relations (1) (b) and

(a) in Proposition 5.8, the relation (A) (b) above coincides with the relation (2) in Proposition 5.8, and the relations (B) (a), (c), and (d) above coincide with the relations (3) (a), (b), and (c) in Proposition 5.8, respectively. We add generators $t_{i,i}$ ($1 \leq i \leq 2n+1$) and relations $t_{i,i} = 1$ ($1 \leq i \leq 2n+1$) to this finite presentation for $\text{LMod}_{2n+2,*}$ above. The relations (A) (c) above and $t_{i,i} = 1$ for $1 \leq i \leq 2n+1$ coincide with the relations (5) in Proposition 5.8. It is sufficient for completing the proof of Proposition 5.8 to prove that the relations (C) above coincide with the relations (1) (c) and (4) (a) in Proposition 5.8.

In the cases of $k+2 < i$, $i \leq k < k+2 \leq j$, or $j < k$, the simple closed curve $\gamma_{i,j}$ is isotopic to a simple closed curve on $\Sigma_0 - \mathcal{B}$ which is disjoint from the support of h_k . Hence, in these cases, we have $w_{i,j;k} = t_{i,j}$ and the relation (C) coincides with the relation (1) (c) in Proposition 5.8. In the case of $k = i-1$ and $i = j-1$, we have $h_{i-1}(\gamma_{i,i+1}) = \gamma_{i-1,i}$. Hence, by the conjugation relation, we have $w_{i,i+1;i-1} = t_{i-1,i}$ and the relation (C) above for $k = i-1$ and $i = j-1$ coincides with the relation (4) (a) for $k = i-1$ and $i = j-1$ in Proposition 5.8. Similarly, in the case of $k = j-1$ and $i+1 = j$, the relation (C) above for $k = j-1$ and $i = j-1$ coincides with the relation (4) (a) for $k = j-1$ and $i = j-1$ in Proposition 5.8.

In the case of $k = i-2$, $h_k(\gamma_{i,j})$ is a simple closed curve on $\Sigma_0 - \mathcal{B}$ as on the upper left-hand side in Figure 18 and we have $h_k t_{i,j} h_k^{-1} = t_{h_k(\gamma_{i,j})}$ by the conjugation relation. By the lantern relation (see on the upper left-hand side in Figure 18), we have

$$\begin{aligned} & h_k t_{i,j} h_k^{-1} \cdot t_{i-2,i} t_{i-1,j} = t_{i+1,j} t_{i-1,i} t_{i-2,j} \\ \Leftrightarrow & h_k t_{i,j} h_k^{-1} = t_{i+1,j} t_{i-1,i} t_{i-2,j} t_{i-1,j}^{-1} t_{i-2,i}^{-1}. \end{aligned}$$

Thus, in this case, we have $w_{i,j;k} = t_{i+1,j} t_{i-1,i} t_{i-2,j} t_{i-1,j}^{-1} t_{i-2,i}^{-1}$ and the relation (C) above for $k = i-2$ coincides with the relation (4) (a) for $k = i-2$ in Proposition 5.8.

In the case of $k = i-1$ and $i < j-1$, $h_k(\gamma_{i,j})$ is a simple closed curve on $\Sigma_0 - \mathcal{B}$ as on the upper right-hand side in Figure 18. By the lantern relation and the conjugation relation (see on the upper right-hand side in Figure 18), we have

$$\begin{aligned} & h_k t_{i,j} h_k^{-1} \cdot t_{i-1,i+1} t_{i+1,j} = t_{i+2,j} t_{i-1,j} t_{i-1,i} \\ \Leftrightarrow & h_k t_{i,j} h_k^{-1} = t_{i+2,j} t_{i-1,j} t_{i-1,i} t_{i+1,j}^{-1} t_{i-1,i+1}^{-1}. \end{aligned}$$

Thus, in this case, we have $w_{i,j;k} = t_{i+2,j} t_{i-1,j} t_{i-1,i} t_{i+1,j}^{-1} t_{i-1,i+1}^{-1}$ and the relation (C) above for $k = i-1$ and $i < j-1$ coincides with the relation (4) (a) for $k = i-1$ and $i < j-1$ in Proposition 5.8.

Similarly, by using the lantern relations as on the lower left-hand side for the case $k = j$ and the lower right-hand side for the case $k = j-1$ and $i+1 < j$ in Figure 18, we have $w_{i,j;k} = t_{i,j-1} t_{j,j+1} t_{i,j+2} t_{i,j+1}^{-1} t_{j,j+2}^{-1}$ for $k = j$ and $w_{i,j;k} = t_{i,j-2} t_{j,j+1} t_{i,j+1} t_{i,j-1}^{-1} t_{j-1,j+1}^{-1}$ for $k = j-1$ and $i+1 < j$. These relations coincide with the relation (4) (a) for the case $k = j$ and the case $k = j-1$ and $i+1 < j$ in Proposition 5.8, respectively. Therefore $\text{LMod}_{2n+2,*}$ admits the presentation in Proposition 5.8 and we have completed the proof of Proposition 5.8. \square

Applying Lemma 3.2 to the exact sequence (2.2), we have the following proposition.

Proposition 5.9. *The group LMod_{2n+2} admits the presentation which is obtained from the finite presentation for $\text{LMod}_{2n+2,*}$ in Proposition 5.8 by adding generators h_{2n} , $t_{1,0}$, and r , and the following relations:*

- (3) lifts of relations in the symmetric group
- (d) $r^2 = 1$,

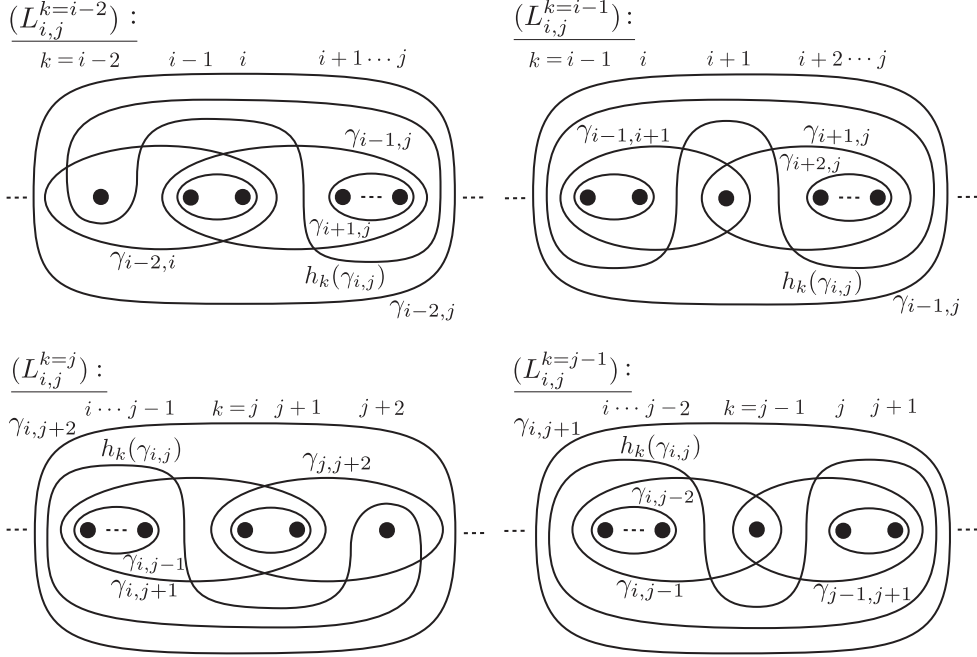

FIGURE 18. Lantern relations $(L_{i,j}^{k=i-2})$, $(L_{i,j}^{k=i-1})$, $(L_{i,j}^{k=j})$, and $(L_{i,j}^{k=j-1})$ in the proof of Proposition 5.8.

$$\begin{aligned}
& (e) \quad rh_i = h_{2n-i+1}r \quad \text{for } 1 \leq i \leq 2n, \\
(4) \quad & (b) \quad h_{2n}t_{i,j}h_{2n}^{-1} \\
& = \begin{cases} t_{i,2n-1}t_{2n,2n+1}t_{1,i-1}t_{i,2n+1}^{-1}t_{1,2n-1}^{-1} \\ \text{for } j = 2n \text{ and } 1 \leq i \leq 2n-1, \\ t_{i,2n-1}t_{1,2n}t_{1,i-1}t_{i,2n}^{-1}t_{1,2n-1}^{-1} & \text{for } j = 2n+1 \text{ and } 1 \leq i \leq 2n-1, \\ t_{1,2n} & \text{for } i+1 = j = 2n+1, \end{cases} \\
& (c) \quad rt_{i,j}r^{-1} = \begin{cases} t_{2n-j+3,2n-i+3} & \text{for } 2 \leq i < j \leq 2n+1, \\ t_{1,2n-j+2} & \text{for } i = 1 \text{ and } 2 \leq j \leq 2n, \end{cases} \\
(5) \quad & t_{1,0} = 1.
\end{aligned}$$

Proof. By Lemma 5.6, W_{2n+2} admits the presentation with generators \bar{h}_i ($1 \leq i \leq 2n$) and \bar{r} , and the following defining relations:

- (1) $\bar{h}_i^2 = 1$ for $1 \leq i \leq 2n$,
- (2) $\bar{h}_i\bar{h}_j\bar{h}_i^{-1}\bar{h}_j^{-1} = 1$ for “ $j-i=1$ or $j-i \geq 3$ ” and $1 \leq i < j \leq 2n$,
- (3) $\bar{h}_i\bar{h}_{i+2}\bar{h}_i\bar{h}_{i+2}^{-1}\bar{h}_i^{-1}\bar{h}_{i+2}^{-1} = 1$ for $1 \leq i \leq 2n-2$,
- (4) $\bar{r}^2 = 1$,
- (5) $\bar{r}\bar{h}_i = \bar{h}_{2n-i+1}\bar{r}$ for $1 \leq i \leq 2n$.

The relations $r^2 = 1$, $rh_i = h_{2n-i+1}r$ ($1 \leq i \leq 2n$), $rt_{i,j}r^{-1} = t_{2n-j+3,2n-i+3}$ ($1 \leq i < j \leq 2n+1$), and $t_{i,2n+2} = t_{1,i-1}$ ($3 \leq i \leq 2n+1$) hold in LMod_{2n+2} by Lemma 2.3 and 2.4. By applying Lemma 3.2 to the exact sequence (2.2) and an argument in the proof of Proposition 5.8, we show that LMod_{2n+2} has the presentation whose generators are h_i ($1 \leq i \leq 2n$), r , and $t_{i,j}$ ($1 \leq i \leq j \leq 2n+1$) and defining relations are as follows:

- (A) (a) $t_{i,j} \rightleftharpoons t_{k,l}$ for $j < k$, $k \leq i < j \leq l$, or $l < i$,
- (b) pentagonal relations $(P_{i,j,k,l,m})$ for $1 \leq i < j < k < l < m \leq 2n+2$,
- (c) $t_{1,2n+1} = 1$,
- (B) (a) $h_i^2 = t_{i,i+2}$ for $1 \leq i \leq 2n-1$,

- (b) $h_{2n}^2 = t_{1,2n-1}$,
- (c) $h_i \overleftrightarrow{=} h_j$ for $j - i > 3$,
- (d) $h_i h_{i+1} h_i^{-1} h_{i+1}^{-1} = t_{i,i+1} t_{i+2,i+3}^{-1}$ for $1 \leq i \leq 2n - 2$,
- (e) $h_{2n-1} h_{2n} h_{2n-1}^{-1} h_{2n}^{-1} = t_{2n-1,2n} t_{1,2n}^{-1}$,
- (f) $h_i h_{i+2} h_i h_{i+2}^{-1} h_i^{-1} h_{i+2}^{-1} = t_{i+1,i+2} t_{i+2,i+3}^{-1}$ for $1 \leq i \leq 2n - 2$,
- (g) $r^2 = 1$,
- (h) $r h_i = h_{2n-i+1} r$ for $1 \leq i \leq 2n$,
- (C) (a) $h_k t_{i,j} h_k^{-1} = w_{i,j;k}$ for $1 \leq i < j \leq 2n + 1$, $(i, j) \neq (1, 2n + 1)$, and $1 \leq k \leq 2n$,
- (b) $r t_{i,j} r^{-1} = \begin{cases} t_{2n-j+3,2n-i+3} & \text{for } 2 \leq i < j \leq 2n + 1, \\ t_{1,2n-j+2} & \text{for } i = 1 \text{ and } 2 \leq j \leq 2n, \end{cases}$

where $w_{i,j;k}$ is a word in $\{t_{i,j}^\varepsilon \mid 1 \leq i < j \leq 2n + 1, (i, j) \neq (1, 2n + 1), \varepsilon \in \{\pm 1\}\}$.

We add generators $t_{i,i}$ ($1 \leq i \leq 2n + 1$) and $t_{1,0}$, and relations $t_{i,i} = t_{1,0} = 1$ ($1 \leq i \leq 2n + 1$) to this finite presentation for LMod_{2n+2} above (these relations are included in the relations (5) in Proposition 5.8 and (5) in Proposition 5.9). Remark that for $k \leq 2n - 1$, $w_{i,j;k}$ is calculated in the proof of Proposition 5.8 and coincides with $t_{i,j}$ or a right side of the relations (4) (a) in Proposition 5.8. The relations (A) (a), (B) (c) for $j \leq 2n - 1$, and (C) (a) for $k + 2 < i$, $i \leq k < k + 2 \leq j$, or $j < k \leq 2n - 1$ above coincide with the relations (1) (b), (a), and (c) in Proposition 5.8, the relation (A) (b) above coincides with the relation (2) in Proposition 5.8, the relations (B) (a), (d), and (f) for $i \leq 2n - 3$ above coincide with the relations (3) (a), (b), and (c) in Proposition 5.8, the relations (B) (g), (h), and (C) (b) above coincide with the relations (3) (d), (e), and (4) (c) in Proposition 5.9, the relation (C) (a) for $k \in \{i - 2, i - 1, j, j + 1\}$ and $k \leq 2n - 1$ coincides with the relation (4) (a) in Proposition 5.8, and the relations (A) (c) and $t_{i,i} = t_{1,0} = 1$ for $1 \leq i \leq 2n + 1$ above coincide with the relations (5) in Proposition 5.8, respectively.

Since by Lemma 5.5, the relations (B) (b), (c) for $j = 2n$, (e), and (f) for $i = 2n - 2$ above are obtained from the relations (B) (a), (c) for $j \leq 2n - 1$, (d), (f) for $i \leq 2n - 3$, (h), and (C) (b) above, we remove these relations from the presentation for LMod_{2n+2} above and the resulting presentation also gives a presentation for LMod_{2n+2} . Hence, it is sufficient for completing the proof of Proposition 5.9 to prove that the relations (C) (a) for $k = 2n$ above are obtained from the relations in Proposition 5.8 and 5.9.

In the case of $j \leq 2n - 1$, we have $h_{2n} t_{i,j} h_{2n}^{-1} = t_{i,j}$ and this relation is equivalent to the relation (1) (c) for $k = 1$ in Proposition 5.8 up to the relations (3) (e) and (4) (c) in Proposition 5.9. In the case of $i = 2n$ and $j = 2n + 1$, by the conjugation relation, we have $h_{2n} t_{2n,2n+1} h_{2n}^{-1} = t_{1,2n}$ and this relation coincides with the relation (4) (b) for $i + 1 = j = 2n + 1$ in Proposition 5.9.

In the cases $j = 2n$ or “ $j = 2n + 1$ and $i \leq 2n - 1$ ”, by the lantern relations as on the lower side in Figure 18 and an argument as in the proof of Proposition 5.8, we have $h_{2n} t_{i,j} h_{2n}^{-1} = t_{i,2n-1} t_{2n,2n+1} t_{1,i-1} t_{i,2n+1}^{-1} t_{1,2n-1}^{-1}$ for $j = 2n$ and $1 \leq i \leq 2n - 1$, and $h_{2n} t_{i,j} h_{2n}^{-1} = t_{i,2n-1} t_{1,2n} t_{1,i-1} t_{i,2n}^{-1} t_{1,2n-1}^{-1}$ for $j = 2n + 1$ and $1 \leq i \leq 2n - 1$. These relations coincide with the relations (4) (b) for “ $j = 2n$ and $1 \leq i \leq 2n - 1$ ” or “ $j = 2n + 1$ and $1 \leq i \leq 2n - 1$ ” in Proposition 5.9. Therefore we have completed the proof of Proposition 5.9. \square

For conveniences, we call the relation (4) (a) in Proposition 5.8 for $k = i - 2$ and $3 \leq i < j \leq 2n + 1$ as on the upper left-hand side in Figure 18 the relation $(L_{i,j}^{k=i-2})$, for $k = i - 1$ and $2 \leq i < j - 1 \leq 2n$ as on the upper right-hand side in Figure 18 the relation $(L_{i,j}^{k=i-1})$, for $k = j$ and $1 \leq i < j \leq 2n - 1$ as on the lower left-hand side in Figure 18 the relation $(L_{i,j}^{k=j})$, and for $k = j - 1$ and $2 \leq i + 1 < j \leq 2n$ as on

the lower right-hand side in Figure 18 the relation $(L_{i,j}^{k=j-1})$, respectively. Remark that “ $k = i - 2$ ”, “ $k = i - 1$ ”, “ $k = j$ ”, and “ $k = j - 1$ ” in $(L_{i,j}^{k=i-2})$, $(L_{i,j}^{k=i-1})$, $(L_{i,j}^{k=j})$, and $(L_{i,j}^{k=j-1})$ are symbols and not variables, respectively. Similarly, we also call the relation (4) (b) in Proposition 5.9 for $j = 2n$ and $1 \leq i \leq 2n - 1$ the relation $(L_{i,2n}^{k=j})$ and for $j = 2n + 1$ and $1 \leq i \leq 2n - 1$ the relation $(L_{i,2n+1}^{k=j-1})$, respectively. As corollaries of Propositions 5.8 and 5.9, we have the following two corollaries.

Corollary 5.10. *The group $\text{LMod}_{2n+2,*}$ admits the presentation with generators h_i for $1 \leq i \leq 2n - 1$ and $t_{i,j}$ for $1 \leq i \leq j \leq 2n + 1$, and the following defining relations:*

- (1) commutative relations
 - (a) $h_i \rightleftharpoons h_j$ for $j - i \geq 3$,
 - (b) $t_{i,j} \rightleftharpoons t_{k,l}$ for $j < k$, $k \leq i < j \leq l$, or $l < i$,
 - (c) $h_k \rightleftharpoons t_{i,j}$ for $k + 2 < i$, $i \leq k < k + 2 \leq j$, or $j < k$,
- (2) relations among h_i 's and $t_{j,j+1}$'s:
 - (a) $h_i^{\pm 1} t_{i,i+1} = t_{i+1,i+2} h_i^{\pm 1}$ for $1 \leq i \leq 2n - 1$,
 - (b) $h_i^\varepsilon h_{i+1}^\varepsilon t_{i,i+1} = t_{i+2,i+3} h_i^\varepsilon h_{i+1}^\varepsilon$ for $1 \leq i \leq 2n - 2$ and $\varepsilon \in \{1, -1\}$,
 - (c) $h_i^\varepsilon h_{i+1}^\varepsilon h_{i+2}^\varepsilon h_i^\varepsilon = h_{i+2}^\varepsilon h_{i+1}^\varepsilon h_{i+2}^\varepsilon$ for $1 \leq i \leq 2n - 3$ and $\varepsilon \in \{1, -1\}$,
 - (d) $h_i h_{i+1} t_{i,i+1} = t_{i,i+1} h_{i+1} h_i$ for $1 \leq i \leq 2n - 2$,
 - (e) $h_i h_{i+2} h_i t_{i+1,i+2}^{-1} = t_{i+2,i+3}^{-1} h_{i+2} h_i h_{i+2}$ for $1 \leq i \leq 2n - 3$,
- (3) pentagonal relations $(P_{i,j,k,l,m})$ for $1 \leq i < j < k < l < m \leq 2n + 2$,
i.e. $t_{j,m-1}^{-1} t_{k,m-1} t_{j,l-1} t_{i,k-1} t_{i,l-1}^{-1} = t_{i,l-1}^{-1} t_{i,k-1} t_{j,l-1} t_{k,m-1} t_{j,m-1}^{-1}$,
- (4) (a) $h_i^2 = t_{i,i+2}$ for $1 \leq i \leq 2n - 1$,
 (b) the relations $(L_{i,j}^{k=i-2})$ for $3 \leq i < j \leq 2n + 1$,
 i.e. $h_{i-2} t_{i,j} h_{i-2}^{-1} = t_{i+1,j} t_{i-1,i} t_{i-2,j} t_{i-1,j}^{-1} t_{i-2,i}^{-1}$,
 (c) the relations $(L_{i,j}^{k=i-1})$ for $2 \leq i < j - 1 \leq 2n$,
 i.e. $h_{i-1} t_{i,j} h_{i-1}^{-1} = t_{i+2,j} t_{i-1,j} t_{i-1,i} t_{i+1,j}^{-1} t_{i-1,i+1}^{-1}$,
 (d) the relations $(L_{i,j}^{k=j})$ for $1 \leq i < j \leq 2n - 1$,
 i.e. $h_j t_{i,j} h_j^{-1} = t_{i,j-1} t_{j,j+1} t_{i,j+2} t_{i,j+1}^{-1} t_{j,j+2}^{-1}$,
 (e) the relations $(L_{i,j}^{k=j-1})$ for $2 \leq i + 1 < j \leq 2n$,
 i.e. $h_{j-1} t_{i,j} h_{j-1}^{-1} = t_{i,j-2} t_{j,j+1} t_{i,j+1} t_{i,j-1}^{-1} t_{j-1,j+1}^{-1}$,
 (f) $t_{i,i} = t_{1,2n+1} = 1$ for $1 \leq i \leq 2n + 1$.

Remark that the relations (1), (2), and (3) in Corollary 5.10 coincide with the relations (1), (2), and (3) in Theorem 5.2.

Corollary 5.11. *The group LMod_{2n+2} admits the presentation which is obtained from the finite presentation for $\text{LMod}_{2n+2,*}$ in Corollary 5.10 by adding generators h_{2n} , $t_{1,0}$, and r , and the following relations:*

- (4) (g) the relations $(L_{i,2n}^{k=j})$ for $1 \leq i \leq 2n - 1$,
 i.e. $h_{2n} t_{i,2n} h_{2n}^{-1} = t_{i,2n-1} t_{2n,2n+1} t_{1,i-1} t_{i,2n+1}^{-1} t_{1,2n-1}^{-1}$,
 (h) the relations $(L_{i,2n+1}^{k=j-1})$ for $1 \leq i \leq 2n - 1$,
 i.e. $h_{2n} t_{i,2n+1} h_{2n}^{-1} = t_{i,2n-1} t_{1,2n} t_{1,i-1} t_{i,2n}^{-1} t_{1,2n-1}^{-1}$,
 (i) $h_{2n} t_{2n,2n+1} h_{2n}^{-1} = t_{1,2n}$,
 (j) $t_{1,0} = 1$,
- (5) relations among r and h_i 's or $t_{i,j}$'s:
 - (a) $r^2 = 1$,
 - (b) $rh_i = h_{2n-i+1} r$ for $1 \leq i \leq 2n$,
 - (c) $rt_{i,j} = t_{2n-j+3,2n-i+3} r$ for $2 \leq i < j \leq 2n + 1$,
 - (d) $rt_{1,j} = t_{1,2n-j+2} r$ for $2 \leq j \leq 2n$.

Remark that the relations (5) (a), (b), and (d) in Corollary 5.11 coincide with the relations (5) (a), (b), and (d) in Theorem 5.3 and the relation (5) (c) in Theorem 5.3 coincides with the relation (5) (c) in Corollary 5.11 for the case $j = i + 1$.

Proof of Corollary 5.10. We consider the finite presentation which is obtained from the finite presentation for $\text{LMod}_{2n+2,*}$ in Proposition 5.8 by adding the relation (2) in Corollary 5.10. Since $\text{LMod}_{2n+2,*}$ admits the relations (2) in Corollary 5.10 by Lemma 2.3 and 2.4, the group which is obtained from this finite presentation is also isomorphic to $\text{LMod}_{2n+2,*}$. The generating set of the presentation in Proposition 5.8 coincides with one of in Corollary 5.10 and the relations (1), (2), (3) (a), and (5) in Proposition 5.8 coincide with the relations (1), (3), (4) (a), and (f) in Corollary 5.10. The relations (3) (b) and (c) in Proposition 5.8 are equivalent to the relations (2) (d) and (e) in Corollary 5.10 up to the relations (1), (2) (a), and (b) in Corollary 5.10. The relation (4) (a) for the case “ $k = i - 1$ and $2 \leq i = j - 1 \leq 2n$ ” or “ $k = j - 1$ and $2 \leq i + 1 = j \leq 2n$ ” in Proposition 5.8 coincides with the relation (2) (a) in Corollary 5.10 and ones of other cases coincide with the relations (4) (b)–(e) in Corollary 5.10 (see before Corollary 5.10). Thus, by Teitze transformations, $\text{LMod}_{2n+2,*}$ has the presentation which is obtained from the presentation considered in the top of this proof by removing the relations (3) (b) and (c) in Proposition 5.8, and this presentation coincides with the presentation in Corollary 5.10. Therefore, we have completed the proof of Corollary 5.10. \square

Proof of Corollary 5.11. We consider the finite presentation which is obtained from the finite presentation for LMod_{2n+2} in Proposition 5.9 by adding the relation (2) in Corollary 5.11. The group which is obtained from this finite presentation is isomorphic to LMod_{2n+2} . The generating set of the presentation in Proposition 5.9 coincides with one of in Corollary 5.11 and the relations (3) (d), (e), (4) (b), (c), and (5) in Proposition 5.9 coincide with the relations (5) (a), (b), (4) (g)–(i), (c) and (d), and (4) (j) in Corollary 5.11. Thus, by Teitze transformations and an argument in the proof of Corollary 5.10, $\text{LMod}_{2n+2,*}$ has the presentation which is obtained from the presentation considered in the top of this proof by removing the relations (3) (b) and (c) in Proposition 5.9, and this presentation coincides with the presentation in Corollary 5.11. Therefore, we have completed the proof of Corollary 5.11. \square

Recall that the relation $(T_{i,j})$ for $1 \leq i < j \leq 2n + 2$ is reviewed in Lemma 2.5. The relation (4) (a) in Theorem 5.1 is the relation $(T_{i,j})$ for $1 \leq i < j \leq 2n + 1$ and the relations (4) (b) and (c) in Theorem 5.3 are obtained from the relations $(T_{1,2n+1})$, $(T_{1,2n+2})$, and $t_{1,2n+1} = t_{1,2n+2} = 1$. The following four lemmas are proved in Section 5.6.

Lemma 5.12. (1) *The relation $(L_{i,j}^{k=j})$ for $1 \leq i < j \leq 2n - 1$ is equivalent to the relation $(T_{i,j+2})$ up to the relations (1) and (2) in Theorem 5.1, $(T_{i',j'})$ for $i \leq i' < j' \leq j + 2$ and $j' - i' < j - i + 2$, and $t_{l,i} = 1$ for $1 \leq l \leq 2n + 1$.*
 (2) *The relation $(L_{1,2n}^{k=j})$ is equivalent to the relation*

$$t_{1,2n}^{-n+1} t_{2n-1,2n}^{-n+1} \cdots t_{3,4}^{-n+1} t_{1,2}^{-n+1} (h_{2n} \cdots h_2 h_1)^{n+1} = 1$$

up to the relations (1) and (2) in Theorem 5.3, $(T_{i',j'})$ for $1 \leq i' < j' \leq 2n + 1$ and $j' - i' < 2n + 1$, and $t_{l,i} = t_{1,0} = 1$ for $1 \leq l \leq 2n - 1$.

We remark that Lemma 5.12 also give Lemma 2.5.

Lemma 5.13. (1) *The relation $(L_{i,j}^{k=j-1})$ for $2 \leq i + 1 < j \leq 2n$ is obtained from the relations (1) and (2) in Theorem 5.1, $(T_{j-1,j+1})$, and $(L_{i,j-1}^{k=j})$.*

(2) The relation $(L_{i,2n+1}^{k=j-1})$ for $1 \leq i \leq 2n-1$ is obtained from the relations (1) and (2) in Theorem 5.3, $(T_{2n,2n+2})$, and $(L_{i,2n}^{k=j})$.

Lemma 5.14. The relation $(L_{i,j}^{k=i-2})$ for $3 \leq i < j \leq 2n+1$ is equivalent to the relation $(T_{i-2,j})$ up to the relations (1) and (2) in Theorem 5.1, $(T_{i',j'})$ for $i-2 \leq i' < j' \leq j$ and $j'-i' < j-i$, and $t_{l,l} = 1$ for $1 \leq l \leq 2n+1$.

Lemma 5.15. The relation $(L_{i,j}^{k=i-1})$ for $2 \leq i < j-1 \leq 2n$ is obtained from the relations (1) and (2) in Theorem 5.1, $(T_{i-1,i+1})$, and $(L_{i+1,j}^{k=i-2})$.

Proof of Theorem 5.2. We consider the finite presentation which is obtained from the finite presentation for $\text{LMod}_{2n+2,*}$ in Corollary 5.10 by adding the relations (4) (a) for $j-i \geq 3$ and (b) in Theorem 5.2. Since $\text{LMod}_{2n+2,*}$ admits the relations (4) (a) for $j-i \geq 3$ and (b) in Theorem 5.2, the group which is obtained from this finite presentation is also isomorphic to $\text{LMod}_{2n+2,*}$. The generators of this presentation in Theorem 5.2 are obtained from the generators of the presentation in Corollary 5.10 by removing $t_{i,i}$ for $1 \leq i \leq 2n+1$, and the relations (1)–(3) in Corollary 5.10 coincide with the relations (1)–(3) in Theorem 5.2. The relation (4) (a) in Corollary 5.10 coincides with the relations (4) (a) in Theorem 5.2 for $j-i = 2$.

By Lemmas 5.12 (1) and 5.14, the relation (4) (d) and (b) in Corollary 5.10 are obtained from the relations in Theorem 5.2 and $t_{l,l} = 1$ for $1 \leq l \leq 2n+1$, respectively. By these facts and Lemmas 5.13 and 5.15, the relation (4) (e) and (c) in Corollary 5.10 are also obtained from the relations in Theorem 5.2 and $t_{l,l} = 1$ for $1 \leq l \leq 2n+1$. Thus, by applying Tietze transformations to the finite presentation for $\text{LMod}_{2n+2,*}$ which was considered in the top of this proof, we have the finite presentation for $\text{LMod}_{2n+2,*}$ which is obtained from the presentation in Theorem 5.2 by adding the generators $t_{i,i}$ for $1 \leq i \leq 2n+1$ and the relations $t_{i,i} = 1$ for $1 \leq i \leq 2n+1$. Since $t_{i,i}$ for $1 \leq i \leq 2n+1$ does not appear in the relations in Theorem 5.2, by applying Tietze transformations again, $\text{LMod}_{2n+2,*}$ admits the presentation which is the result of removing the generators $t_{i,i}$ for $1 \leq i \leq 2n+1$ and the relations $t_{i,i} = 1$ for $1 \leq i \leq 2n+1$ from this presentation for $\text{LMod}_{2n+2,*}$. Therefore we have completed the proof of Theorem 5.2. \square

We prepare the following two lemmas which are proved in Sections 5.4 and 5.5, respectively.

Lemma 5.16. For $1 \leq i < j \leq 2n+1$ such that $j-i \geq 3$ is odd, the relation

$$\begin{aligned} & t_{j-1,j}^{-\frac{j-i-3}{2}} \cdots t_{i+2,i+3}^{-\frac{j-i-3}{2}} t_{i,i+1}^{-\frac{j-i-3}{2}} (h_{j-2} \cdots h_{i+1} h_i)^{\frac{j-i+1}{2}} \\ &= t_{i,i+1}^{-\frac{j-i-3}{2}} t_{i+2,i+3}^{-\frac{j-i-3}{2}} \cdots t_{j-1,j}^{-\frac{j-i-3}{2}} (h_i h_{i+1} \cdots h_{j-2})^{\frac{j-i+1}{2}} \end{aligned}$$

is obtained from the relations (1) and (2) in Theorem 5.1.

Lemma 5.17. For $1 \leq i < j \leq 2n+1$ such that $j-i \geq 4$ is even, the relation

$$\begin{aligned} & t_{j-2,j-1}^{-\frac{j-i-2}{2}} \cdots t_{i+2,i+3}^{-\frac{j-i-2}{2}} t_{i,i+1}^{-\frac{j-i-2}{2}} h_{j-2} \cdots h_{i+2} h_i h_{i+2} \cdots h_{j-2} (h_{j-3} \cdots h_{i+1} h_i)^{\frac{j-i}{2}} \\ &= t_{i+1,i+2}^{-\frac{j-i-2}{2}} t_{i+3,i+4}^{-\frac{j-i-2}{2}} \cdots t_{j-1,j}^{-\frac{j-i-2}{2}} h_i h_{i+2} \cdots h_{j-2} h_{j-2} \cdots h_{i+2} h_i (h_{i+1} h_{i+2} \cdots h_{j-2})^{\frac{j-i}{2}} \end{aligned}$$

is obtained from the relations (1) and (2) in Theorem 5.1.

Proof of Theorem 5.3. We consider the finite presentation which is obtained from the finite presentation for LMod_{2n+2} in Corollary 5.11 by adding the relations (4) (a) for $j-i \geq 3$, (b), and (c) in Theorem 5.3. The group which is obtained from this finite presentation is isomorphic to LMod_{2n+2} . Remark that the relations (1)–(3), (4) (a), (5) (a), (b), (c) for $j = i+1$, and (d) in Corollary 5.11 coincide with the relations (1)–(3), (4) (a) for $j-i = 2$, and (5) (a), (b), (c), and (d) in Theorem 5.3,

respectively. By an argument in the proof of Theorem 5.2, the relation (4) (b)–(e) in Corollary 5.11 are obtained from the relations in Theorem 5.3 and the relations $t_{l,l} = 1$ for $1 \leq l \leq 2n + 1$. Thus, we will show that the relations (4) (g), (h), (i) and (5) (c) for $2 \leq i < j - 1 \leq 2n$ in Corollary 5.11 are obtained from the relations in Theorem 5.3 and the relations $t_{l,l} = t_{1,0} = 1$ for $1 \leq l \leq 2n + 1$.

First, for the relation (5) (c) for $2 \leq i < j - 1 \leq 2n$ in Corollary 5.11, we have

$$\begin{aligned}
& rt_{i,j}r^{-1} \\
(4)\underline{(a)} & \begin{cases} rh_i^2r^{-1} & \text{for } j-i=2, \\ r(t_{j-1,j}^{-\frac{j-i-3}{2}} \cdots t_{i+2,i+3} t_{i,i+1}^{-\frac{j-i-3}{2}} (h_{j-2} \cdots h_{i+1} h_i)^{\frac{j-i+1}{2}})r^{-1} \\ & \text{for } 2n-1 \geq j-i \geq 3 \text{ is odd,} \\ r(t_{j-2,j-1}^{-\frac{j-i-2}{2}} \cdots t_{i+2,i+3} t_{i,i+1}^{-\frac{j-i-2}{2}} h_{j-2} \cdots h_{i+2} h_i h_i h_{i+2} \cdots h_{j-2} \\ & \cdot (h_{j-3} \cdots h_{i+1} h_i)^{\frac{j-i}{2}})r^{-1} & \text{for } 2n-2 \geq j-i \geq 4 \text{ is even,} \end{cases} \\
(5)\underline{(b)} & \begin{cases} h_{2n-i+1}^2 & \text{for } j-i=2, \\ t_{2n-j+3,2n-j+4}^{-\frac{j-i-3}{2}} \cdots t_{2n-i,2n-i+1}^{-\frac{j-i-3}{2}} t_{2n-i+2,2n-i+3}^{-\frac{j-i-3}{2}} \\ & \cdot (h_{2n-j+3} \cdots h_{2n-i} h_{2n-i+1})^{\frac{j-i+1}{2}} & \text{for } 2n-1 \geq j-i \geq 3 \text{ is odd,} \\ (5)\underline{(c)} & \begin{cases} t_{2n-j+4,2n-j+5}^{-\frac{j-i-2}{2}} \cdots t_{2n-i,2n-i+1}^{-\frac{j-i-2}{2}} t_{2n-i+2,2n-i+3}^{-\frac{j-i-2}{2}} \\ & \cdot h_{2n-j+3} \cdots h_{2n-i-1} h_{2n-i+1} h_{2n-i+1} h_{2n-i-1} \cdots h_{2n-j+3} \\ & \cdot (h_{2n-j+4} \cdots h_{2n-i} h_{2n-i+1})^{\frac{j-i}{2}} & \text{for } 2n-2 \geq j-i \geq 4 \text{ is even,} \end{cases} \\
\text{Lem. 5.16} & \begin{cases} h_{2n-i+1}^2 & \text{for } j-i=2, \\ t_{2n-i+2,2n-i+3}^{-\frac{j-i-3}{2}} t_{2n-i,2n-i+1}^{-\frac{j-i-3}{2}} \cdots t_{2n-j+3,2n-j+4}^{-\frac{j-i-3}{2}} \\ & \cdot (h_{2n-i+1} h_{2n-i} \cdots h_{2n-j+3})^{\frac{j-i+1}{2}} & \text{for } 2n-1 \geq j-i \geq 3 \text{ is odd,} \\ \text{Lem. 5.17} & \begin{cases} t_{2n-i+1,2n-i+2}^{-\frac{j-i-2}{2}} t_{2n-i-1,2n-i}^{-\frac{j-i-2}{2}} \cdots t_{2n-j+3,2n-j+4}^{-\frac{j-i-2}{2}} \\ & \cdot h_{2n-i+1} h_{2n-i-1} \cdots h_{2n-j+3} h_{2n-j+3} \cdots h_{2n-i-1} h_{2n-i+1} \\ & \cdot (h_{2n-i} h_{2n-i-1} \cdots h_{2n-j+3})^{\frac{j-i}{2}} & \text{for } 2n-2 \geq j-i \geq 4 \text{ is even,} \end{cases} \\
(4)\underline{(a)} & \begin{cases} h_{2n-i+1}^2 & \text{for } j-i=2, \\ t_{2n-i+2,2n-i+3}^{-\frac{j-i-3}{2}} t_{2n-i,2n-i+1}^{-\frac{j-i-3}{2}} \cdots t_{2n-j+3,2n-j+4}^{-\frac{j-i-3}{2}} \\ & \cdot (h_{2n-i+1} h_{2n-i} \cdots h_{2n-j+3})^{\frac{j-i+1}{2}} & \text{for } 2n-1 \geq j-i \geq 3 \text{ is odd,} \\ \text{Lem. 5.17} & \begin{cases} t_{2n-i+1,2n-i+2}^{-\frac{j-i-2}{2}} t_{2n-i-1,2n-i}^{-\frac{j-i-2}{2}} \cdots t_{2n-j+3,2n-j+4}^{-\frac{j-i-2}{2}} \\ & \cdot h_{2n-i+1} h_{2n-i-1} \cdots h_{2n-j+3} h_{2n-j+3} \cdots h_{2n-i-1} h_{2n-i+1} \\ & \cdot (h_{2n-i} h_{2n-i-1} \cdots h_{2n-j+3})^{\frac{j-i}{2}} & \text{for } 2n-2 \geq j-i \geq 4 \text{ is even,} \end{cases} \\
(4)\underline{(a)} & t_{2n-j+3,2n-i+3}. \end{aligned}
\end{aligned}$$

Thus the relation (5) (c) for $2 \leq i < j - 1 \leq 2n$ in Corollary 5.11 is obtained from the relations in Theorem 5.3 (in particular, all the relations $rt_{i,j}r^{-1} = t_{2n-j+3,2n-i+3}$ are obtained from the relations in Theorem 5.3).

By Lemma 5.5, the relation (4) (i) is obtained from the relations in Theorem 5.3. By Lemma 5.12 (2), the relation (4) (g) for $i = 1$ (i.e. the relation $(L_{1,2n}^{k=j})$) is obtained from the relations in Theorem 5.3 and $t_{l,l} = t_{1,0} = 1$ for $1 \leq l \leq 2n + 1$. Using the relations (5) in Theorem 5.3 and all $rt_{i,j}r^{-1} = t_{2n-j+3,2n-i+3}$, the conjugation of the relation (4) (g) for $2 \leq i \leq 2n$ (i.e. the relation $(L_{i,2n}^{k=j})$) by r coincides with the relation $(L_{3,2n-i+3}^{k=i-2})$. Since $2n - i + 3 \leq 2n - 2 + 3 = 2n + 1$, by Lemma 5.14, the relation $(L_{3,2n-i+3}^{k=i-2})$ is also obtained from the relations in Theorem 5.3 and $t_{l,l} = 1$ for $1 \leq l \leq 2n + 1$. Hence the relations (4) (g) are obtained from the relations in Theorem 5.3 and $t_{l,l} = 1$ for $1 \leq l \leq 2n + 1$. By this fact and Lemma 5.13 (2), the relations (4) (h) are obtained from the relations in Theorem 5.3 and $t_{l,l} = 1$ for $1 \leq l \leq 2n + 1$.

By an argument above, the relations (4) (g), (h), (i) and (5) (c) for $2 \leq i < j - 1 \leq 2n$ in Corollary 5.11 are obtained from the relations in Theorem 5.3 and the relations $t_{l,l} = t_{1,0} = 1$ for $1 \leq l \leq 2n + 1$. Thus, by applying Tietze transformations to the finite presentation for LMod_{2n+2} which was considered in the top of this proof, we have the finite presentation for LMod_{2n+2} which is obtained from the presentation in Theorem 5.3 by adding the generators $t_{i,i}$ for $1 \leq i \leq 2n + 1$ and $t_{1,0}$ and the relations $t_{i,i} = t_{1,0} = 1$ for $1 \leq i \leq 2n + 1$. Since the generators $t_{i,i}$

for $1 \leq i \leq 2n + 1$ and $t_{1,0}$ do not appear in the relations in Theorem 5.3, by applying Tietze transformations again, LMod_{2n+2} admits the presentation which is the result of removing the generators $t_{i,i}$ for $1 \leq i \leq 2n + 1$ and $t_{1,0}$ and the relations $t_{i,i} = t_{1,0} = 1$ for $1 \leq i \leq 2n + 1$ from this presentation for LMod_{2n+2} . Therefore we have completed the proof of Theorem 5.3. \square

Proof of Theorem 5.1. We will apply Lemma 3.2 to the exact sequence (4.2) in Proposition 4.5 and the finite presentation for $\text{LMod}_{2n+2,*}$ in Theorem 5.2. The Dehn twist $t_{\partial D}$ coincides with $t_{1,2n+1}$ by the definition, is non-trivial in LMod_{2n+1}^1 , and commutes with any element in LMod_{2n+1}^1 . The generators which appear in the relations (1)–(3), and (4) (a) in Theorem 5.2 are supported on the complement of the disk D in Σ_0 and these relations hold up to isotopies fixing D pointwise. Hence we regard relations (1)–(3), and (4) (a) in Theorem 5.2 as the relations in LMod_{2n+1}^1 and these relations coincide with the relations (1)–(3), and (4) (a) in Theorem 5.1. By applying Lemma 3.2 to the exact sequence (4.2) in Proposition 4.5 and the finite presentation for $\text{LMod}_{2n+2,*}$ in Theorem 5.2, we have the presentation for LMod_{2n+1}^1 whose generators are h_i for $1 \leq i \leq 2n - 1$, $t_{i,j}$ for $1 \leq i < j \leq 2n + 1$, and t_D , and defining relations are the relations (1)–(3), and (4) (a) in Theorem 5.1, $t_D = t_{1,2n+1}$, $t_D \varpi h_i$ for $1 \leq i \leq 2n - 1$, $t_D \varpi t_{i,j}$ for $1 \leq i < j \leq 2n + 1$. By Tietze transformations, LMod_{2n+1}^1 admits the presentation which is the result of replacing t_D by $t_{1,2n+1}$ in the commutative relations above and removing the generator t_D and the relation $t_D = t_{1,2n+1}$ from this presentation for LMod_{2n+2} . The relations $t_{1,2n+1} \varpi h_i$ for $1 \leq i \leq 2n - 1$ and $t_{1,2n+2} \varpi t_{i,j}$ for $1 \leq i < j \leq 2n + 1$ coincide with the relations (1) (c) and (b) in Theorem 5.1, respectively. Therefore we have completed the proof of Theorem 5.1. \square

5.3. The first homology groups of the liftable mapping class groups. Recall the the integral first homology group $H_1(G)$ of a group G is isomorphic to the abelianization of G . In this section, we prove Theorem 1.1 by using the finite presentations in Theorems 5.1, 5.2, and 5.3. For conveniences, we denote the equivalence class in $H_1(\text{LMod}_{2n+1}^1)$ (resp. $H_1(\text{LMod}_{2n+2,*})$ and $H_1(\text{LMod}_{2n+2})$) of an element h in LMod_{2n+1}^1 (resp. $\text{LMod}_{2n+2,*}$ and LMod_{2n+2}) by h .

Proof of Theorem 1.1 for LMod_{2n+1}^1 . We will calculate $H_1(\text{LMod}_{2n+1}^1)$ by using the finite presentation for LMod_{2n+1}^1 in Theorem 5.1. When $n = 1$, the presentations for LMod_{2n+1}^1 in Theorem 5.1 has the generators h_1 , $t_{1,2}$, $t_{2,3}$, and $t_{1,3}$ and the relation (1) (b) $t_{i,i+1} \varpi t_{1,3}$ ($i = 1, 2$), (c) $h_1 \varpi t_{1,3}$, (2) (a) $h_1^{\pm 1} t_{1,2} = t_{2,3} h_1^{\pm 1}$, and (4) (a) $t_{1,3} = h_1^2$. Hence, as a presentation for an abelian group (i.e. we omit commutative relations), we have

$$\begin{aligned} H_1(\text{LMod}_3^1) &\cong \langle h_1, t_{1,2}, t_{2,3}, t_{1,3} \mid t_{1,2} = t_{2,3}, t_{1,3} = h_1^2 \rangle \\ &\cong \langle h_1, t_{1,2} \rangle \\ &\cong \mathbb{Z}[h_1] \oplus \mathbb{Z}[t_{1,2}]. \end{aligned}$$

Thus, $H_1(\text{LMod}_3^1)$ is isomorphic to \mathbb{Z}^2 .

Assume that $n \geq 2$. The relations (2) (a) and (b) in Theorem 5.1 are equivalent to the relations $t_{i,i+1} = t_{i+1,i+2}$ ($1 \leq i \leq 2n - 1$) in $H_1(\text{LMod}_{2n+1}^1)$. The relations (2) (c) and (2) (e) in Theorem 5.1 are equivalent to the relations $h_i = h_{i+2}$ ($1 \leq i \leq 2n - 3$) in $H_1(\text{LMod}_{2n+1}^1)$ up to the relations $t_{i,i+1} = t_{i+1,i+2}$ ($1 \leq i \leq 2n - 1$) in $H_1(\text{LMod}_{2n+1}^1)$. The relations (3) and (2) (d) in Theorem 5.1 are equivalent to the trivial relation in $H_1(\text{LMod}_{2n+1}^1)$. By the relation (4) (a) in Theorem 5.1, $t_{i,j}$ for $1 \leq i < j \leq 2n + 1$ and $j - i \geq 2$ is a product of h_i for $1 \leq i \leq 2n - 1$ and $t_{i,i+1}$ for $1 \leq i \leq 2n$. Hence, as a presentation for an abelian

group, we have

$$\begin{aligned}
& H_1(\text{LMod}_{2n+1}^1) \\
& \cong \langle h_i \ (1 \leq i \leq 2n-1), t_{i,j} \ (1 \leq i < j \leq 2n+1) | \text{the relations (2), (4) (a)} \rangle \\
& \cong \langle h_i \ (1 \leq i \leq 2n-1), t_{i,i+1} \ (1 \leq i \leq 2n) | \text{the relations (2)} \rangle \\
& \cong \langle h_1, h_2, t_{1,2} | \rangle \\
& \cong \mathbb{Z}[h_1] \oplus \mathbb{Z}[h_2] \oplus \mathbb{Z}[t_{1,2}].
\end{aligned}$$

Therefore, $H_1(\text{LMod}_{2n+1}^1)$ for $n \geq 2$ is isomorphic to \mathbb{Z}^3 and we have completed the proof of Theorem 1.1 for LMod_{2n+1}^1 . \square

Proof of Theorem 1.1 for $\text{LMod}_{2n+2,}$.* We will calculate $H_1(\text{LMod}_{2n+2,*})$ by using the finite presentations for $\text{LMod}_{2n+2,*}$ in Theorem 5.2. By Theorem 5.2, the presentation for $\text{LMod}_{2n+2,*}$ is obtained from the presentation for LMod_{2n+1}^1 in Theorem 5.1 by adding the relation $t_{1,2n+1} = 1$. When $n = 1$, as a presentation for an abelian group, we have

$$\begin{aligned}
H_1(\text{LMod}_{4,*}) & \cong \langle h_1, t_{1,2}, t_{2,3}, t_{1,3} | t_{1,2} = t_{2,3}, t_{1,3} = h_1^2, t_{1,3} = 1 \rangle \\
& \cong \langle h_1, t_{1,2} | h_1^2 = 1 \rangle \\
& \cong \mathbb{Z}[t_{1,2}] \oplus \mathbb{Z}_2[h_1].
\end{aligned}$$

Thus, $H_1(\text{LMod}_{4,*})$ is isomorphic to $\mathbb{Z} \oplus \mathbb{Z}_2$.

Assume that $n \geq 2$. By an argument similar to the proof of Theorem 1.1 for LMod_{2n+1}^1 , the relations (1), (2), and (3) in Theorem 5.2 are equivalent to the relations $t_{i,i+1} = t_{i+1,i+2}$ for $1 \leq i \leq 2n-1$ and $h_i = h_{i+2}$ for $1 \leq i \leq 2n-1$ in $H_1(\text{LMod}_{2n+2,*})$. By the relation (4) (a) in Theorem 5.2, we have $t_{1,2n+1} = t_{1,2}^{-n(n-1)} h_1^{n(n+1)} h_2^{n(n-1)}$ in $H_1(\text{LMod}_{2n+2,*})$. Up to these relations, the relation (4) (b) in Theorem 5.2 is equivalent to the relation $t_{1,2}^{-n(n-1)} h_1^{n(n+1)} h_2^{n(n-1)} = 1$ in $H_1(\text{LMod}_{2n+2,*})$. Hence, as a presentation for an abelian group, we have

$$\begin{aligned}
H_1(\text{LMod}_{2n+2,*}) & \cong \langle h_1, h_2, t_{1,2} | t_{1,2}^{-n(n-1)} h_1^{n(n+1)} h_2^{n(n-1)} = 1 \rangle \\
& \cong \langle h_1, h_2, t_{1,2}, X | (h_1^2 X^{n-1})^n = 1, X = t_{1,2}^{-1} h_1 h_2 \rangle \\
& \cong \langle h_1, h_2, X | (h_1^2 X^{n-1})^n = 1 \rangle.
\end{aligned}$$

When n is odd, we have

$$\begin{aligned}
\langle h_1, h_2, X | (h_1^2 X^{n-1})^n = 1 \rangle & \cong \langle h_1, h_2, X, Y | Y^{2n} = 1, Y = h_1 X^{\frac{n-1}{2}} \rangle \\
& \cong \langle h_2, X, Y | Y^{2n} = 1 \rangle \\
& \cong \mathbb{Z}[h_2] \oplus \mathbb{Z}[X] \oplus \mathbb{Z}_{2n}[Y],
\end{aligned}$$

where $X = t_{1,2}^{-1} h_1 h_2$ and $Y = h_1 X^{\frac{n-1}{2}} = t_{1,2}^{-\frac{n-1}{2}} h_1^{\frac{n+1}{2}} h_2^{\frac{n-1}{2}}$. Thus, $H_1(\text{LMod}_{2n+2,*})$ for odd $n \geq 3$ is isomorphic to $\mathbb{Z}^2 \oplus \mathbb{Z}_{2n}$. When n is even, we have

$$\begin{aligned}
\langle h_1, h_2, X | (h_1^2 X^{n-1})^n = 1 \rangle & \cong \langle h_1, h_2, X, Y | (Y^2 X^{-1})^n = 1, Y = h_1 X^{\frac{n}{2}} \rangle \\
& \cong \langle h_2, X, Y | (Y^2 X^{-1})^n = 1 \rangle \\
& \cong \langle h_2, X, Y, Z | Z^n = 1, Z = Y^2 X^{-1} \rangle \\
& \cong \langle h_2, Y, Z | Z^n = 1 \rangle \\
& \cong \mathbb{Z}[h_2] \oplus \mathbb{Z}[Y] \oplus \mathbb{Z}_n[Z],
\end{aligned}$$

where $Y = h_1 X^{\frac{n}{2}} = t_{1,2}^{-\frac{n}{2}} h_1^{\frac{n+2}{2}} h_2^{\frac{n}{2}}$ and $Z = Y^2 X^{-1} = t_{1,2}^{-n+1} h_1^{n+1} h_2^{n-1}$. Therefore, $H_1(\text{LMod}_{2n+2,*})$ for even n is isomorphic to $\mathbb{Z}^2 \oplus \mathbb{Z}_n$ and we have completed the proof of Theorem 1.1 for $\text{LMod}_{2n+2,*}$. \square

We give another proof of Theorem 1.1 in [8] as follows.

Proof of Theorem 1.1 for LMod_{2n+2} . We will calculate $H_1(\text{LMod}_{2n+2})$ by using the finite presentations for LMod_{2n+2} in Theorem 5.3. By an argument similar to the proof of Theorem 1.1 for LMod_{2n+1}^1 , the relations (1), (2), and (3) in Theorem 5.3 are equivalent to the relations $t_{i,i+1} = t_{i+1,i+2}$ for $1 \leq i \leq 2n-1$ and $h_i = h_{i+2}$ for $1 \leq i \leq 2n-1$ in $H_1(\text{LMod}_{2n+2})$. Since the relations (5) (b) and (c) in Theorem 5.3 are equivalent to the relations $h_i = h_{2n-i+1}$ for $1 \leq i \leq 2n$ and $t_{i,i+1} = t_{2n-i+2,2n-i+3}$ for $2 \leq i \leq 2n$, we have $h_i = h_j$ for any $1 \leq i < j \leq 2n$ in $H_1(\text{LMod}_{2n+2})$. By an argument in the proof of Theorem 1.1 for $\text{LMod}_{2n+2,*}$, the relation (4) (b) in Theorem 5.3 is equivalent to the relation

$$1 = t_{1,2}^{-n(n-1)} h_1^{n(n+1)} h_2^{n(n-1)} = t_{1,2}^{-n(n-1)} h_1^{2n^2} = (t_{1,2}^{-n+1} h_1^{2n})^n$$

in $H_1(\text{LMod}_{2n+2})$. Since we have $t_{1,2n} = t_{2n+1,2n+2}$ and $t_{2n+1,2n} = h_{2n} \cdots h_2 h_1 t_{1,2} h_1^{-1} h_2^{-1} \cdots h_{2n}^{-1}$ in LMod_{2n+2} , the relation $t_{1,2n} = t_{1,2}$ holds in $H_1(\text{LMod}_{2n+2})$. Thus, the relation (4) (c) in Theorem 5.3 is equivalent to the relation

$$1 = t_{1,2}^{-(n-1)(n+1)} h_1^{2n(n+1)} = (t_{1,2}^{-n+1} h_1^{2n})^{n+1}$$

in $H_1(\text{LMod}_{2n+2})$. By these two relations in $H_1(\text{LMod}_{2n+2})$, we obtain the relation $t_{1,2}^{-n+1} h_1^{2n} = 1$ in $H_1(\text{LMod}_{2n+2})$. We can see that these two relations are obtained from the relation $t_{1,2}^{-n+1} h_1^{2n} = 1$ in $H_1(\text{LMod}_{2n+2})$. We remark that when $n = 1$, the relation $t_{1,2}^{-n+1} h_1^{2n} = 1$ in $H_1(\text{LMod}_{2n+2})$ is equivalent to the relation $h_1^2 = 1$.

The relation (5) (d) in Theorem 5.3 is equivalent to the relation $t_{1,j} = t_{1,2n-j+2}$ for $2 \leq j \leq 2n$ in $H_1(\text{LMod}_{2n+2})$. We remark that when $n = 1$, this relation is equivalent to the trivial relation in $H_1(\text{LMod}_{2n+2})$. By the relation (4) (a), we have

$$t_{1,j} = \begin{cases} t_{2i-1,2i}^{-(i-2)} \cdots t_{3,4}^{-(i-2)} t_{1,2}^{-(i-2)} (h_{2i-2} \cdots h_2 h_1)^i & \text{for } j = 2i \geq 4, \\ t_{2i-1,2i}^{-(i-1)} \cdots t_{3,4}^{-(i-1)} t_{1,2}^{-(i-1)} h_{2i-1} \cdots h_3 h_1 h_1 h_3 \cdots h_{2i-1} (h_{2i-2} \cdots h_2 h_1)^i & \text{for } j = 2i+1 \geq 5 \end{cases}$$

in LMod_{2n+2} , and the relations $t_{1,j} = t_{1,2n-j+2}$ for $2 \leq j \leq 2n$ in $H_1(\text{LMod}_{2n+2})$ are equivalent to the following relations:

- (A) $t_{1,2} = t_{1,2}^{-n(n-2)} h_1^{2n(n-1)} \Leftrightarrow 1 = t_{1,2}^{-(n-1)^2} h_1^{2n(n-1)} = (t_{1,2}^{-n+1} h_1^{2n})^{n-1}$
for $j = 2$,
- (B) $h_1^2 = t_{1,2}^{-(n-1)(n-2)} h_1^{2(n-1)^2} \Leftrightarrow 1 = t_{1,2}^{-(n-1)(n-2)} h_1^{2n(n-2)} = (t_{1,2}^{-n+1} h_1^{2n})^{n-2}$
for $j = 3$,
- (C) $t_{1,2}^{-i(i-2)} h_1^{2i(i-1)} = t_{1,2}^{-(n-i-1)(n-i+1)} h_1^{2(n-i)(n-i+1)}$
 $\Leftrightarrow 1 = t_{1,2}^{-n^2+2in-2i+1} h_1^{2(n^2-(2i-1)n)} = (t_{1,2}^{-n+1} h_1^{2n})^{n-2i+1}$
for $j = 2i$ and $2 \leq i \leq n$, and
- (D) $t_{1,2}^{-i(i-1)} h_1^{2i^2} = t_{1,2}^{-(n-i)(n-i-1)} h_1^{2(n-i)^2}$
 $\Leftrightarrow 1 = t_{1,2}^{-n^2+(2i+1)n-2i} h_1^{2n(n-2i)} = (t_{1,2}^{-n+1} h_1^{2n})^{n-2i}$
for $j = 2i+1$ and $2 \leq i \leq n-1$

in $H_1(\text{LMod}_{2n+2})$. Hence the relations (A)–(D) in $H_1(\text{LMod}_{2n+2})$ above are obtained from the relation $t_{1,2}^{-n+1} h_1^{2n} = 1$ in $H_1(\text{LMod}_{2n+2})$.

When $n = 1$, by an argument above, we have

$$\begin{aligned} H_1(\text{LMod}_4) &\cong \langle h_1, t_{1,2}, r \mid r^2 = 1, h_1^2 = 1 \rangle \\ &\cong \mathbb{Z}[t_{1,2}] \oplus \mathbb{Z}_2[h_1] \oplus \mathbb{Z}_2[r]. \end{aligned}$$

as a presentation for an abelian group. Thus, $H_1(\text{LMod}_4)$ is isomorphic to $\mathbb{Z} \oplus \mathbb{Z}_2^2$.

Assume $n \geq 2$. By an argument above, as a presentation for an abelian group, we have

$$\begin{aligned} H_1(\text{LMod}_{2n+2}) &\cong \langle h_1, t_{1,2}, r \mid r^2 = 1, t_{1,2}^{-n+1} h_1^{2n} = 1 \rangle \\ &\cong \langle h_1, t_{1,2}, r, X \mid r^2 = 1, t_{1,2} X^n = 1, X = t_{1,2}^{-1} h_1^2 \rangle \\ &\cong \langle h_1, r, X \mid r^2 = 1, X^{n-1} h_1^2 = 1 \rangle. \end{aligned}$$

When n is odd, we have

$$\begin{aligned} &\langle h_1, r, X \mid r^2 = 1, X^{n-1} h_1^2 = 1 \rangle \\ &\cong \langle h_1, r, X, Y \mid r^2 = 1, Y^2 = 1, Y = X^{\frac{n-1}{2}} h_1 \rangle \\ &\cong \langle r, X, Y \mid r^2 = 1, Y^2 = 1 \rangle \\ &\cong \mathbb{Z}[X] \oplus \mathbb{Z}_2[r] \oplus \mathbb{Z}_2[Y], \end{aligned}$$

where $X = t_{1,2}^{-1} h_1^2$ and $Y = X^{\frac{n-1}{2}} h_1 = t_{1,2}^{-\frac{n-1}{2}} h_1^n$. Thus $H_1(\text{LMod}_{2n+2})$ for odd $n \geq 3$ is isomorphic to $\mathbb{Z} \oplus \mathbb{Z}_2^2$. When n is even, we have

$$\begin{aligned} &\langle h_1, r, X \mid r^2 = 1, X^{n-1} h_1^2 = 1 \rangle \\ &\cong \langle h_1, r, X, Y \mid r^2 = 1, X^{-1} Y^2 = 1, Y = X^{\frac{n}{2}} h_1 \rangle \\ &\cong \langle r, X, Y \mid r^2 = 1, X^{-1} Y^2 = 1 \rangle \\ &\cong \langle r, Y \mid r^2 = 1 \rangle \\ &\cong \mathbb{Z}[Y] \oplus \mathbb{Z}_2[r], \end{aligned}$$

where $Y = X^{\frac{n}{2}} h_1 = t_{1,2}^{-\frac{n}{2}} h_1^{n+1}$. Therefore, $H_1(\text{LMod}_{2n+2})$ for even n is isomorphic to $\mathbb{Z} \oplus \mathbb{Z}_2$ and we have completed the proof of Theorem 1.1 for LMod_{2n+2} . \square

5.4. Proof of Lemma 5.16. In this section, we prove Lemma 5.16 and introduce some useful relations in liftable mapping class groups which are obtained from relations in Theorems 5.1, 5.2, and 5.3 and are also used in Sections 5.5 and 5.6. After this, throughout Section 5, a label of a relation indicates one of relations in Theorems 5.1, 5.2, and 5.3. Remark that $t_{2n+1,2n+2} = t_{1,2n}$. The next lemma is immediately obtained by using the relations (1), (2) (a), (b), and $t_{2n+1,2n+2} = t_{1,2n}$.

Lemma 5.18. (A) *Up to the relations (1), (2) (a), (b), and $t_{2n+1,2n+2} = t_{1,2n}$, the relation (2) (d), i.e. $h_i h_{i+1} t_{i,i+1} = t_{i,i+1} h_{i+1} h_i$ for $1 \leq i \leq 2n-1$, is equivalent to the following relations:*

$$\begin{aligned} h_i h_{i+1} t_{i,i+1} &= h_{i+1} h_i t_{i+2,i+3}, & t_{i+2,i+3} h_i h_{i+1} &= t_{i,i+1} h_{i+1} h_i, \\ h_i h_{i+1} &= h_{i+1} h_i t_{i,i+1}^{-1} t_{i+2,i+3}, & h_i h_{i+1} &= t_{i,i+1} t_{i+2,i+3}^{-1} h_{i+1} h_i, \\ h_{i+1} h_i &= h_i h_{i+1} t_{i,i+1}^{-1} t_{i+2,i+3}, & h_{i+1} h_i &= t_{i,i+1}^{-1} t_{i+2,i+3} h_i h_{i+1}. \end{aligned}$$

(B) *Up to the relations (1), (2) (a), (b), and $t_{2n+1,2n+2} = t_{1,2n}$, the relation (2) (e), i.e. $h_i h_{i+2} h_i t_{i+1,i+2}^{-1} = t_{i+2,i+3}^{-1} h_{i+2} h_i h_{i+2}$ for $1 \leq i \leq 2n-2$, is equivalent to the following relations:*

$$\begin{aligned} t_{i+1,i+2}^{-1} h_i h_{i+2} h_i &= t_{i+2,i+3}^{-1} h_{i+2} h_i h_{i+2}, & h_i h_{i+2} h_i t_{i+1,i+2}^{-1} &= h_{i+2} h_i h_{i+2} t_{i+2,i+3}^{-1}, \\ t_{i+1,i+2}^{-1} h_i h_{i+2} h_i &= h_{i+2} h_i h_{i+2} t_{i+2,i+3}^{-1}, & h_i h_{i+2} h_i &= t_{i+2,i+3}^{-1} h_{i+2} h_i h_{i+2} t_{i+1,i+2}, \\ h_i h_{i+2} h_i &= t_{i+1,i+2} h_{i+2} h_i h_{i+2} t_{i+2,i+3}^{-1}, & h_i h_{i+2} h_i &= t_{i+1,i+2} t_{i+2,i+3}^{-1} h_{i+2} h_i h_{i+2}, \\ h_i h_{i+2} h_i &= h_{i+2} h_i h_{i+2} t_{i+2,i+3}^{-1} t_{i+1,i+2}. \end{aligned}$$

We also call the relations in (A) and (B) of Lemma 5.18 the relations (2) (d) and (2) (e), respectively.

Lemma 5.19. For $1 \leq i < j \leq 2n+2$ in the case of LMod_{2n+2} , $1 \leq i < j \leq 2n+1$ in the case of LMod_{2n+1}^1 , and $1 \leq l \leq 2n+1$ such that $j-i \geq 3$ is odd and $l-i$ is even, the relation

$$(h_{j-2} \cdots h_{i+1} h_i)^{\frac{j-i+1}{2}} \rightleftharpoons t_{l,l+1}$$

is obtained from the relations (1), (2), and $t_{2n+1,2n+2} = t_{1,2n}$.

Proof. In the cases of $l \leq i-2$ or $j+1 \leq l$, the relation $(h_{j-2} \cdots h_{i+1} h_i)^{\frac{j-i+1}{2}} \rightleftharpoons t_{l,l+1}$ is obtained from the relations (1) (c). Since $j-i$ is odd and $l-i$ is even, $j-l$ is odd and we have $l \notin \{i+1, j\}$. Hence we suppose that $i \leq l \leq j-1$. By the relations (2) (a), (b), we have the relations $h_l t_{l,l+1} = t_{l+1,l+2} h_l$, $h_{l-1} h_{l-2} t_{l,l+1} = t_{l-2,l-1} h_{l-1} h_{l-2}$, $h_{2n} t_{2n,2n+1} = t_{1,2n} h_{2n}$, and $h_{2n} h_{2n-1} t_{1,2n} = t_{2n-1,2n} h_{2n} h_{2n-1}$. Thus, by also using the relations (1) (c), for $j \leq 2n+1$ and $i \leq l \leq j-1$ with even $l-i$, we have

$$(h_{j-2} \cdots h_{i+1} h_i) t_{l,l+1} = \begin{cases} t_{j-1,j} (h_{j-2} \cdots h_{i+1} h_i) & \text{for } l = i, \\ t_{l-2,l-1} (h_{j-2} \cdots h_{i+1} h_i) & \text{for } i+2 \leq l \leq j-1, \end{cases}$$

and when $j = 2n+2$, for $i \leq l \leq 2n+1$ with even $l-i$, we have

$$(h_{2n} \cdots h_{i+1} h_i) t_{l,l'} = \begin{cases} t_{1,2n} (h_{2n} \cdots h_{i+1} h_i) & \text{for } (l,l') = (i, i+1), \\ t_{l-2,l-1} (h_{2n} \cdots h_{i+1} h_i) & \text{for } i+2 \leq l \leq 2n-1 \\ & \text{and } l' = l+1, \\ t_{2n-1,2n} (h_{2n} \cdots h_{i+1} h_i) & \text{for } (l,l') = (1, 2n). \end{cases}$$

We can see that the subgroup of LMod_{2n+2} or $\text{LMod}_{2n+2,*}$ generated by $h_{j-2} \cdots h_{i+1} h_i$ acts on the $\frac{j-i+1}{2}$ points set $\{t_{i,i+1}, t_{i+2,i+3}, \dots, t_{j-1,j-2}\}$ by conjugations and the action of $h_{j-2} \cdots h_{i+1} h_i$ has order $\frac{j-i+1}{2}$. Therefore the relation $(h_{j-2} \cdots h_{i+1} h_i)^{\frac{j-i+1}{2}} t_{l,l+1} = t_{l,l+1} (h_{j-2} \cdots h_{i+1} h_i)^{\frac{j-i+1}{2}}$ holds in LMod_{2n+1}^1 for $j \leq 2n+1$ and LMod_{2n+2} and is obtained from the relations (1), (2), and $t_{2n+1,2n+2} = t_{1,2n}$. We have completed the proof of Lemma 5.19. \square

Lemma 5.20. For $1 \leq i < j \leq 2n+2$ in the case of LMod_{2n+2} , $1 \leq i < j \leq 2n+1$ in the case of LMod_{2n+1}^1 , $1 \leq l \leq 2n+1$, and a product A of generators for LMod_{2n+2} (resp. for LMod_{2n+1}^1) in Theorem 5.3 (resp. in Theorem 5.3) commuting with $t_{l+1,l+2}$, we assume that $j-i \geq 4$ and $l-i$ are even and $l \neq j$. Then, the relation

$$h_{j-2} \cdots h_{i+2} h_i A h_i h_{i+2} \cdots h_{j-2} \rightleftharpoons t_{l,l+1}$$

is obtained from the relations (1), (2), and $t_{2n+1,2n+2} = t_{1,2n}$.

Proof. In the cases of $l \leq i-2$ or $j+1 \leq l$, the relation $h_{j-2} \cdots h_{i+2} h_i A h_i h_{i+2} \cdots h_{j-2} \rightleftharpoons t_{l,l+1}$ is obtained from the relations (1) (c) and $t_{2n+1,2n+2} = t_{1,2n}$. Since $j-i$ and $l-i$ are even, $j-l$ is also even and we have $l \notin \{i-1, j-1\}$. Hence we suppose that $i \leq l \leq j-2$. Then, up to the relation $t_{2n+1,2n+2} = t_{1,2n}$, we have

$$\begin{aligned} & h_{j-2} \cdots h_{i+2} h_i A h_i h_{i+2} \cdots h_{j-2} \cdot \underbrace{t_{l,l+1}}_{\leftarrow} \\ \stackrel{(1)(c)}{=} & h_{j-2} \cdots h_{i+2} h_i h_i A h_i h_{i+2} \cdots h_{l-2} \underline{h_l} \cdot \underline{t_{l,l+1}} \cdot h_{l+2} \cdots h_{j-2} \\ \stackrel{(2)(a)}{=} & h_{j-2} \cdots h_{i+2} h_i A h_i h_{i+2} \cdots h_{l-2} \cdot \underline{t_{l+1,l+2}} \cdot h_l h_{l+2} \cdots h_{j-2} \\ & \leftarrow \\ \stackrel{(1)}{=} & h_{j-2} \cdots h_{l+2} \underline{h_l} \cdot \underline{t_{l+1,l+2}} \cdot h_{l-2} \cdots h_{i+2} h_i A h_i h_{i+2} \cdots h_{j-2} \\ \stackrel{(2)(a)}{=} & h_{j-2} \cdots h_{l+2} \cdot \underline{t_{l,l+1}} \cdot h_l h_{l-2} \cdots h_{i+2} h_i A h_i h_{i+2} \cdots h_{j-2} \\ & \leftarrow \end{aligned}$$

$$\stackrel{(1)(c)}{=} t_{l,l+1} \cdot h_{j-2} \cdots h_{i+2} h_i A h_i h_{i+2} \cdots h_{j-2}.$$

Therefore, the relation $h_{j-2} \cdots h_{i+2} h_i A h_i h_{i+2} \cdots h_{j-2} \stackrel{\rightrightarrows}{=} t_{l,l+1}$ is obtained from the relations (1) (c), (2) (a), and $t_{2n+1,2n+2} = t_{1,2n}$, and we have completed the proof of Lemma 5.20. \square

As a corollary of Lemma 5.20, we have the following corollary.

Corollary 5.21. *For $1 \leq i < j \leq 2n+2$ in the case of LMod_{2n+2} , $1 \leq i < j \leq 2n+1$ in the case of LMod_{2n+1}^1 , and $1 \leq l \leq 2n+1$ such that $j-i \geq 4$ and $l-i$ are even and $l \neq j$, the relation*

$$h_{j-2} \cdots h_{i+2} h_i h_i h_{i+2} \cdots h_{j-2} \stackrel{\rightrightarrows}{=} t_{l,l+1}$$

is obtained from the relations (1), (2), and $t_{2n+1,2n+2} = t_{1,2n}$.

Lemma 5.22. *For $1 \leq i < j \leq 2n+2$ in the case of LMod_{2n+2} , $1 \leq i < j \leq 2n+1$ in the case of LMod_{2n+1}^1 , $1 \leq l \leq 2n-1$, and a product A of generators for LMod_{2n+2} (resp. for LMod_{2n+1}^1) in Theorem 5.3 (resp. in Theorem 5.3), we assume that $j-i \geq 4$ and $l-i$ are even and $l \notin \{i-2, j\}$, and each generator which appears in A commutes with $h_{l+1} t_{l+2, l+3}^{-1} h_{l+2} t_{l+1, l+2}$. Then, the relation*

$$h_{j-2} \cdots h_{i+2} h_i A h_i h_{i+2} \cdots h_{j-2} \stackrel{\rightrightarrows}{=} h_{l+1} h_l$$

is obtained from the relations (1), (2), and $t_{2n+1,2n+2} = t_{1,2n}$.

Proof. In the cases of $l+1 \leq i-3$ or $j+1 \leq l$, the relation $h_{j-2} \cdots h_{i+2} h_i A h_i h_{i+2} \cdots h_{j-2} \stackrel{\rightrightarrows}{=} h_{l+1} h_l$ is obtained from the relation (1). Since $j-i$ and $l-i$ are even, $j-l$ is also even and we have $l \notin \{i-3, i-1, j-1\}$. Hence we suppose that $i \leq l \leq j-2$. By Lemma 5.18, up to the relations (2) (a), (b), and $t_{2n+1,2n+2} = t_{1,2n}$, the relation (2) (d) is equivalent to the relations $h_l h_{l+1} = h_{l+1} h_l t_{l, l+1}^{-1} t_{l+2, l+3}$ and $h_{l+1} h_l = h_l h_{l+1} t_{l+2, l+3}^{-1} t_{l, l+1}$, and the relation (2) (e) is equivalent to the relation $h_l h_{l+2} h_l = t_{l+2, l+3}^{-1} h_{l+2} h_l h_{l+2} t_{l+1, l+2}$. Then, up to the relation $t_{2n+1,2n+2} = t_{1,2n}$, we have

$$\begin{aligned} & h_{j-2} \cdots h_{i+2} h_i A h_i h_{i+2} \cdots h_{j-2} \cdot \underbrace{h_{l+1} h_l}_{\leftarrow} \\ \stackrel{(1)(a)}{=} & h_{j-2} \cdots h_{i+2} h_i A h_i h_{i+2} \cdots h_l \underbrace{h_{l+2} \cdot h_{l+1}}_{\leftarrow} h_l \cdot h_{l+4} \cdots h_{j-2} \\ \stackrel{(2)(d)}{=} & h_{j-2} \cdots h_{i+2} h_i A h_i h_{i+2} \cdots h_{l-2} \underbrace{h_l \cdot h_{l+1}}_{\leftarrow} h_{l+2} t_{l+3, l+4}^{-1} t_{l+1, l+2} \cdot h_l \cdot h_{l+4} \cdots h_{j-2} \\ \stackrel{(2)(d)}{=} & h_{j-2} \cdots h_{i+2} h_i A h_i h_{i+2} \cdots h_{l-2} \cdot h_{l+1} h_l \underbrace{t_{l, l+1}^{-1} t_{l+2, l+3}}_{\leftarrow} \cdot h_{l+2} t_{l+3, l+4}^{-1} t_{l+1, l+2} h_l \\ & \cdot h_{l+4} \cdots h_{j-2} \\ \stackrel{(1)(c)}{=} & h_{j-2} \cdots h_{i+2} h_i A h_i h_{i+2} \cdots h_{l-2} \cdot h_{l+1} h_l h_{l+2} \underbrace{t_{l, l+1}^{-1} t_{l+1, l+2}}_{\leftarrow} h_l \cdot h_{l+4} \cdots h_{j-2} \\ \stackrel{(2)(a)}{=} & h_{j-2} \cdots h_{i+2} h_i A h_i h_{i+2} \cdots h_{l-2} \cdot h_{l+1} \underbrace{h_l h_{l+2} h_l t_{l+1, l+2}^{-1}}_{\leftarrow} t_{l, l+1} \cdot h_{l+4} \cdots h_{j-2} \\ \stackrel{(2)(e)}{=} & h_{j-2} \cdots h_{i+2} h_i A h_i h_{i+2} \cdots h_{l-2} \cdot h_{l+1} t_{l+2, l+3}^{-1} h_{l+2} h_l h_{l+2} \underbrace{t_{l, l+1}}_{\leftarrow} \cdot h_{l+4} \cdots h_{j-2} \\ \stackrel{(1)(c)}{=} & h_{j-2} \cdots h_{i+2} h_i A h_i h_{i+2} \cdots h_{l-2} \cdot h_{l+1} t_{l+2, l+3}^{-1} h_{l+2} t_{l+1, l+2} \underbrace{h_l h_{l+2}}_{\leftarrow} \cdot h_{l+4} \cdots h_{j-2} \\ \stackrel{(2)(a)}{=} & h_{j-2} \cdots h_{l+2} \cdot \underbrace{h_{l+1} h_l t_{l+2, l+3}^{-1}}_{\leftarrow} h_{l+2} t_{l+1, l+2} \cdot h_{l-2} \cdots h_{i+2} h_i A h_i h_{i+2} \cdots h_{j-2} \\ \stackrel{(2)(d)}{=} & h_{j-2} \cdots h_{l+2} \cdot h_{l+1} \underbrace{h_l t_{l, l+1}^{-1}}_{\leftarrow} h_{l+2} t_{l+1, l+2} \cdot h_{l-2} \cdots h_{i+2} h_i A h_i h_{i+2} \cdots h_{j-2} \end{aligned}$$

$$\begin{aligned}
& \stackrel{(2)(a)}{=} h_{j-2} \cdots h_{l+4} \underline{h_{l+2} \cdot h_{l+1} t_{l+1, l+2}^{-1}} h_l h_{l+2} t_{l+1, l+2} \cdot h_{l-2} \cdots h_{i+2} h_i A h_i h_{i+2} \cdots h_{j-2} \\
& \stackrel{(2)(d)}{=} h_{j-2} \cdots h_{l+4} \cdot h_{l+1} \underline{h_{l+2} t_{l+3, l+4}^{-1}} h_l h_{l+2} t_{l+1, l+2} \cdot h_{l-2} \cdots h_{i+2} h_i A h_i h_{i+2} \cdots h_{j-2} \\
& \stackrel{(2)(a)}{=} h_{j-2} \cdots h_{l+4} \cdot h_{l+1} \underline{t_{l+2, l+3}^{-1}} h_{l+2} h_l h_{l+2} t_{l+1, l+2} \cdot h_{l-2} \cdots h_{i+2} h_i A h_i h_{i+2} \cdots h_{j-2} \\
& \stackrel{(2)(e)}{=} h_{j-2} \cdots h_{l+4} \cdot \underline{h_{l+1} h_l h_{l+2} h_l} \cdot h_{l-2} \cdots h_{i+2} h_i A h_i h_{i+2} \cdots h_{j-2} \\
& \stackrel{(1)(a)}{=} h_{l+1} h_l \cdot h_{j-2} \cdots h_{i+2} h_i A h_i h_{i+2} \cdots h_{j-2}.
\end{aligned}$$

Therefore, the relation $h_{j-2} \cdots h_{i+2} h_i A h_i h_{i+2} \cdots h_{j-2} \rightleftharpoons h_{l+1} h_l$ is obtained from the relations (1), (2), and $t_{2n+1, 2n+2} = t_{1, 2n}$, and we have completed the proof of Lemma 5.22. \square

As a corollary of Lemma 5.22, we have the following.

Corollary 5.23. *For $1 \leq i < j \leq 2n+2$ in the case of LMod_{2n+2} and $1 \leq i < j \leq 2n+1$ in the case of LMod_{2n+1}^1 such that $j-i \geq 4$ is even, the relation*

$$h_{j-2} \cdots h_{i+2} h_i h_i h_{i+2} \cdots h_{j-2} \rightleftharpoons (h_{j-3} \cdots h_{i+1} h_i)^{\frac{j-i}{2}}$$

is obtained from the relations (1), (2), and $t_{2n+1, 2n+2} = t_{1, 2n}$.

Lemma 5.24. *For $1 \leq i < j \leq 2n$ in the case of LMod_{2n+2} and $1 \leq i < j \leq 2n-1$ in the case of LMod_{2n+1}^1 such that $j-i \geq 3$ is odd, the relations*

$$\begin{aligned}
(1) \quad & \begin{cases} h_i h_{i+2} \cdots h_{j-1} (h_{j-2} \cdots h_{i+1} h_i)^{\frac{j-i+1}{2}} = (h_{j-1} \cdots h_{i+1} h_i)^{\frac{j-i+1}{2}}, \\ (h_i h_{i+1} \cdots h_{j-2})^{\frac{j-i+1}{2}} h_{j-1} \cdots h_{i+2} h_i = (h_i h_{i+1} \cdots h_{j-1})^{\frac{j-i+1}{2}}, \end{cases} \\
(2) \quad & \begin{cases} h_{i+1} h_{i+3} \cdots h_j (h_{j-1} \cdots h_{i+1} h_i)^{\frac{j-i+1}{2}} = (h_j \cdots h_{i+1} h_i)^{\frac{j-i+1}{2}}, \\ (h_i h_{i+1} \cdots h_{j-1})^{\frac{j-i+1}{2}} h_j \cdots h_{i+3} h_{i+1} = (h_i h_{i+1} \cdots h_j)^{\frac{j-i+1}{2}} \end{cases}
\end{aligned}$$

are obtained from the relations (1) and (2).

Proof. For $i \leq l \leq j-3$, we have the relations $h_l (h_{j-1} h_{j-2} \cdots h_{i+1} h_i) = (h_{j-1} h_{j-2} \cdots h_{i+1} h_i) h_{l+2}$ and $(h_i h_{i+1} \cdots h_{j-2} h_{j-1}) h_l = h_{l+2} (h_i h_{i+1} \cdots h_{j-2} h_{j-1})$ by the relations (1) (a) and (2) (c). Then we have

$$\begin{aligned}
& h_i h_{i+2} \cdots h_{j-1} (h_{j-2} \cdots h_{i+1} h_i)^{\frac{j-i+1}{2}} \\
&= h_i h_{i+2} \cdots h_{j-5} \underline{h_{j-3} (h_{j-1} h_{j-2} \cdots h_{i+1} h_i)} (h_{j-2} \cdots h_{i+1} h_i)^{\frac{j-i-1}{2}} \\
& \stackrel{(1)(a)}{=} \stackrel{(2)(c)}{=} h_i h_{i+2} \cdots h_{j-5} (h_{j-1} h_{j-2} \cdots h_{i+1} h_i) h_{j-1} (h_{j-2} \cdots h_{i+1} h_i)^{\frac{j-i-1}{2}} \\
&= h_i h_{i+2} \cdots h_{j-7} \underline{h_{j-5} (h_{j-1} h_{j-2} \cdots h_{i+1} h_i)^2} (h_{j-2} \cdots h_{i+1} h_i)^{\frac{j-i-3}{2}} \\
& \stackrel{(1)(a)}{=} \stackrel{(2)(c)}{=} h_i h_{i+2} \cdots h_{j-7} (h_{j-1} h_{j-2} \cdots h_{i+1} h_i)^3 (h_{j-2} \cdots h_{i+1} h_i)^{\frac{j-i-5}{2}} \\
& \quad \vdots \\
& \stackrel{(1)(a)}{=} \stackrel{(2)(c)}{=} h_i (h_{j-1} h_{j-2} \cdots h_{i+1} h_i)^{\frac{j-i-1}{2}} (h_{j-2} \cdots h_{i+1} h_i) \\
& \stackrel{(1)(a)}{=} \stackrel{(2)(c)}{=} (h_{j-1} h_{j-2} \cdots h_{i+1} h_i)^{\frac{j-i+1}{2}}
\end{aligned}$$

and

$$\begin{aligned}
& (h_i h_{i+1} \cdots h_{j-2})^{\frac{j-i+1}{2}} h_{j-1} \cdots h_{i+2} h_i \\
&= (h_i h_{i+1} \cdots h_{j-2})^{\frac{j-i-1}{2}} \underline{(h_i h_{i+1} \cdots h_{j-2} h_{j-1}) h_{j-3} h_{j-5} \cdots h_{i+2} h_i}
\end{aligned}$$

$$\begin{aligned}
& \stackrel{(1)(a)}{=} (h_i h_{i+1} \cdots h_{j-2})^{\frac{j-i-1}{2}} h_{j-1} (h_i h_{i+1} \cdots h_{j-2} h_{j-1}) h_{j-5} \cdots h_{i+2} h_i \\
& \stackrel{(2)(c)}{=} (h_i h_{i+1} \cdots h_{j-2})^{\frac{j-i-3}{2}} (h_i h_{i+1} \cdots h_{j-2} h_{j-1})^2 h_{j-5} h_{j-7} \cdots h_{i+2} h_i \\
& \stackrel{(1)(a)}{=} (h_i h_{i+1} \cdots h_{j-2})^{\frac{j-i-5}{2}} (h_i h_{i+1} \cdots h_{j-2} h_{j-1})^3 h_{j-7} \cdots h_{i+2} h_i \\
& \stackrel{(2)(c)}{=} \vdots \\
& \stackrel{(1)(a)}{=} (h_i h_{i+1} \cdots h_{j-2} h_{j-1})^{\frac{j-i+1}{2}}. \\
& \stackrel{(2)(c)}{=}
\end{aligned}$$

Thus the relations $h_i h_{i+2} \cdots h_{j-1} (h_{j-2} \cdots h_{i+1} h_i)^{\frac{j-i+1}{2}} = (h_{j-1} \cdots h_{i+1} h_i)^{\frac{j-i+1}{2}}$ and $(h_i h_{i+1} \cdots h_{j-2})^{\frac{j-i+1}{2}} h_{j-1} \cdots h_{i+2} h_i = (h_i h_{i+1} \cdots h_{j-1})^{\frac{j-i+1}{2}}$ are obtained from the relations (1) (a) and (2) (c).

Since the relations $h_l (h_j h_{j-1} \cdots h_{i+1} h_i) = (h_j h_{j-1} \cdots h_{i+1} h_i) h_{l+2}$ and $(h_i h_{i+1} \cdots h_{j-2} h_{j-1}) h_l = h_{l+2} (h_i h_{i+1} \cdots h_{j-2} h_{j-1})$ for $i \leq l \leq j-2$ are obtained from the relations (1) (a) and (2) (c), by a similar argument above, the relations $h_{i+1} h_{i+3} \cdots h_j (h_{j-1} \cdots h_{i+1} h_i)^{\frac{j-i+1}{2}} = (h_j \cdots h_{i+1} h_i)^{\frac{j-i+1}{2}}$ and $(h_i h_{i+1} \cdots h_{j-1})^{\frac{j-i+1}{2}} h_j \cdots h_{i+3} h_{i+1} = (h_i h_{i+1} \cdots h_j)^{\frac{j-i+1}{2}}$ are also obtained from the relations (1) (a) and (2) (c). Therefore we have completed the proof of Lemma 5.24. \square

By an argument similar to the proof of Lemma 5.24, we also have the following lemma.

Lemma 5.25. *For $1 \leq i < j \leq 2n$ in the case of LMod_{2n+2} and $1 \leq i < j \leq 2n-1$ in the case of LMod_{2n+1}^1 such that $j-i \geq 3$ is odd, the relations*

$$\begin{aligned}
(1) \quad & \begin{cases} h_{j-1} \cdots h_{i+2} h_i (h_{i+1} h_{i+2} \cdots h_{j-1})^{\frac{j-i+1}{2}} = (h_i h_{i+1} \cdots h_{j-1})^{\frac{j-i+1}{2}}, \\ (h_{j-1} \cdots h_{i+2} h_{i+1})^{\frac{j-i+1}{2}} h_i h_{i+2} \cdots h_{j-1} = (h_{j-1} \cdots h_{i+1} h_i)^{\frac{j-i+1}{2}}, \end{cases} \\
(2) \quad & \begin{cases} h_{j-1} \cdots h_{i+2} h_i (h_{i+1} h_{i+2} \cdots h_j)^{\frac{j-i+1}{2}} = (h_i h_{i+1} \cdots h_j)^{\frac{j-i+1}{2}}, \\ (h_j \cdots h_{i+2} h_{i+1})^{\frac{j-i+1}{2}} h_i h_{i+2} \cdots h_{j-1} = (h_j \cdots h_{i+1} h_i)^{\frac{j-i+1}{2}} \end{cases}
\end{aligned}$$

are obtained from the relations (1) and (2).

Lemma 5.26. *For $1 \leq i < j \leq 2n+2$ in the case of LMod_{2n+2} and $1 \leq i < j \leq 2n+1$ in the case of LMod_{2n+1}^1 such that $j-i \geq 3$ is odd, the relation*

$$\begin{aligned}
& h_{j-2} \cdots h_{i+1} h_i (h_{i+1} h_{i+3} \cdots h_{j-2}) \\
& = t_{j-1, j}^{\frac{j-i-3}{2}} t_{i+1, i+2}^{-1} t_{i+3, i+4}^{-1} \cdots t_{j-2, j-1}^{-1} h_{j-2} \cdots h_{i+3} h_{i+1} t_{i, i+1} (h_{i+1} h_{i+3} \cdots h_{j-2}) \\
& \quad \cdot h_{j-3} \cdots h_{i+2} h_i
\end{aligned}$$

is obtained from the relations (1), (2), and $t_{2n+1, 2n+2} = t_{1, 2n}$.

Proof. In the case of $j-i=3$, the relation in Lemma 5.26 is equivalent to the relation (2) (d) up to the relation (2) (a). We assume that $j-i \geq 5$ is odd. Then we have

$$\begin{aligned}
& h_{j-2} \cdots h_{i+1} h_i (h_{i+1} h_{i+3} \cdots h_{j-2}) \\
& \stackrel{(2)(d)}{=} h_{j-2} \cdots h_{i+2} h_{i+1} \cdot t_{i+2, i+3}^{-1} t_{i, i+1} h_{i+1} \xrightarrow{\rightarrow} h_{i+3} h_{i+5} \cdots h_{j-2} \\
& \stackrel{(1)(a)}{=} h_{j-2} \cdots h_{i+2} h_{i+1} \cdot t_{i+2, i+3}^{-1} t_{i, i+1} (h_{i+1} h_{i+3} \cdots h_{j-2}) \cdot h_i.
\end{aligned}$$

We will show that the relation

$$h_{j-2} \cdots h_{i+2} h_{i+1} \cdot t_{i+2, i+3}^{-1} t_{i, i+1} (h_{i+1} h_{i+3} \cdots h_{j-2}) h_i$$

$$= h_{j-2} \cdots h_{i+4} h_{i+3} \cdot t_{i+3,i+4} \cdot t_{i+1,i+2}^{-1} t_{i+4,i+5}^{-1} h_{i+1} t_{i,i+1} (h_{i+1} h_{i+3} \cdots h_{j-2}) h_{i+2} h_i$$

is obtained from the relations (1), (2), and $t_{2n+1,2n+2} = t_{1,2n}$ as follows:

$$\begin{aligned}
& h_{j-2} \cdots h_{i+3} h_{i+2} h_{i+1} \cdot t_{i+2,i+3}^{-1} t_{i,i+1} (h_{i+1} h_{i+3} \cdots h_{j-2}) h_i \\
\stackrel{(2)(d)}{=} & h_{j-2} \cdots h_{i+4} h_{i+3} \cdot t_{i+1,i+2}^{-1} t_{i+3,i+4} h_{i+1} h_{i+2} \cdot t_{i+2,i+3}^{-1} t_{i,i+1} (h_{i+1} h_{i+3} \cdots h_{j-2}) \\
& \cdot h_i \\
\stackrel{(2)(a)}{\stackrel{(1)(c)}{=}} & h_{j-2} \cdots h_{i+4} h_{i+3} \cdot t_{i+1,i+2}^{-1} t_{i+3,i+4} h_{i+1} t_{i+3,i+4}^{-1} t_{i,i+1} h_{i+2} (h_{i+1} h_{i+3} \cdots h_{j-2}) \\
& \cdot h_i \\
\stackrel{(2)(d)}{=} & h_{j-2} \cdots h_{i+4} h_{i+3} \cdot t_{i+1,i+2}^{-1} t_{i+3,i+4} h_{i+1} \xrightarrow{\rightarrow} t_{i+3,i+4}^{-1} t_{i,i+1} \cdot t_{i+1,i+2}^{-1} t_{i+3,i+4} h_{i+1} h_{i+2} \\
& \cdot h_{i+3} h_{i+5} \cdots h_{j-2} \cdot h_i \\
\stackrel{(2)(d)}{\stackrel{(1)(b)}{=}} & h_{j-2} \cdots h_{i+4} h_{i+3} \cdot t_{i+1,i+2}^{-1} t_{i+3,i+4} h_{i+1} t_{i,i+1} t_{i+1,i+2}^{-1} h_{i+1} \\
& \cdot t_{i+2,i+3} t_{i+4,i+5}^{-1} h_{i+3} \xrightarrow{\rightarrow} h_{i+2} \cdot h_{i+5} h_{i+7} \cdots h_{j-2} \cdot h_i \\
\stackrel{(2)(d)}{\stackrel{(1)(b)}{=}} & h_{j-2} \cdots h_{i+4} h_{i+3} \cdot t_{i+3,i+4} t_{i+1,i+2}^{-1} h_{i+1} t_{i,i+1} h_{i+1} \\
& \cdot t_{i+4,i+5}^{-1} h_{i+3} \cdot h_{i+5} h_{i+7} \cdots h_{j-2} \cdot h_{i+2} h_i \\
& \xleftarrow{\leftarrow} \\
\stackrel{(1)(c)}{\stackrel{(1)(b)}{=}} & h_{j-2} \cdots h_{i+4} h_{i+3} \cdot t_{i+3,i+4} \cdot t_{i+1,i+2}^{-1} t_{i+4,i+5}^{-1} h_{i+1} t_{i,i+1} (h_{i+1} h_{i+3} \cdots h_{j-2}) h_{i+2} h_i.
\end{aligned}$$

When $j - i = 5$, the last expression coincides with

$$h_{i+3} \cdot t_{i+3,i+4} \cdot t_{i+1,i+2}^{-1} t_{i+4,i+5}^{-1} h_{i+1} t_{i,i+1} (h_{i+1} h_{i+3} \cdots h_{j-2}) h_{i+2} h_i.$$

For the case that $j - i \geq 7$ is odd, we will prove that for odd $1 \leq l \leq j - i - 2$, the relation

$$\begin{aligned}
& h_{i+l+1} h_{i+l} \cdot t_{i+l,i+l+1}^{-1} t_{i+1,i+2}^{-1} t_{i+3,i+4}^{-1} \cdots t_{i+l-2,i+l-1}^{-1} \cdot t_{i+l+1,i+l+2}^{-1} \\
& \cdot h_{i+l-2} \cdots h_{i+3} h_{i+1} t_{i,i+1} (h_{i+1} h_{i+3} \cdots h_{j-2}) \\
= & t_{i+l+2,i+l+3}^{-1} t_{i+1,i+2}^{-1} t_{i+3,i+4}^{-1} \cdots t_{i+l,i+l+1}^{-1} \cdot t_{i+l+3,i+l+4}^{-1} \\
& \cdot h_{i+l} \cdots h_{i+3} h_{i+1} t_{i,i+1} (h_{i+1} h_{i+3} \cdots h_{j-2}) h_{i+l+1}
\end{aligned}$$

is obtained from the relations (1), (2), and $t_{2n+1,2n+2} = t_{1,2n}$ as follows:

$$\begin{aligned}
& h_{i+l+1} h_{i+l} \cdot t_{i+l,i+l+1}^{-1} t_{i+1,i+2}^{-1} t_{i+3,i+4}^{-1} \cdots t_{i+l-2,i+l-1}^{-1} \cdot t_{i+l+1,i+l+2}^{-1} \\
& \cdot h_{i+l-2} \cdots h_{i+3} h_{i+1} t_{i,i+1} (h_{i+1} h_{i+3} \cdots h_{j-2}) \\
\stackrel{(2)(d)}{=} & t_{i+l,i+l+1}^{-1} t_{i+l+2,i+l+3} h_{i+l} h_{i+l+1} \cdot t_{i+l,i+l+1}^{-1} t_{i+1,i+2}^{-1} t_{i+3,i+4}^{-1} \cdots t_{i+l-2,i+l-1}^{-1} \\
& \cdot t_{i+l+1,i+l+2}^{-1} h_{i+l-2} \cdots h_{i+3} h_{i+1} t_{i,i+1} (h_{i+1} h_{i+3} \cdots h_{j-2}) \\
\stackrel{(2)(b)}{\stackrel{(1)(c)}{=}} & t_{i+l,i+l+1}^{-1} \cdot t_{i+l+2,i+l+3}^{-1} t_{i+1,i+2}^{-1} t_{i+3,i+4}^{-1} \cdots t_{i+l-2,i+l-1}^{-1} h_{i+l} h_{i+l+1} \\
& \cdot t_{i+l+1,i+l+2}^{-1} h_{i+l-2} \cdots h_{i+3} h_{i+1} t_{i,i+1} (h_{i+1} h_{i+3} \cdots h_{j-2}) \\
\stackrel{(2)(a)}{\stackrel{(1)}{=}} & t_{i+l,i+l+1}^{-1} \cdot t_{i+l+2,i+l+3}^{-1} t_{i+1,i+2}^{-1} t_{i+3,i+4}^{-1} \cdots t_{i+l-2,i+l-1}^{-1} h_{i+l} t_{i+l+2,i+l+3}^{-1} \\
& \cdot h_{i+l-2} \cdots h_{i+3} h_{i+1} t_{i,i+1} (h_{i+1} h_{i+3} \cdots h_{i+l-2} \cdot h_{i+l+1} \cdot h_{i+l} h_{i+l+2} \cdots h_{j-2})
\end{aligned}$$

$$\begin{aligned}
& \stackrel{(2)(d)}{=} \frac{t_{i+l,i+l+1}^{-1} \cdot t_{i+l+2,i+l+3}^{\frac{l+3}{2}} t_{i+1,i+2}^{-1} t_{i+3,i+4}^{-1} \cdots t_{i+l-2,i+l-1}^{-1} h_{i+l} t_{i+l+2,i+l+3}^{-1}}{\rightarrow} \\
& \quad \cdot h_{i+l-2} \cdots h_{i+3} h_{i+1} t_{i,i+1} (h_{i+1} h_{i+3} \cdots h_{i+l-2} \\
& \quad \cdot t_{i+l,i+l+1}^{-1} t_{i+l+2,i+l+3} h_{i+l} \underline{h_{i+l+1}} \cdot h_{i+l+2} h_{i+l+4} \cdots h_{j-2}) \\
& \stackrel{(2)(d)}{=} \frac{t_{i+l+2,i+l+3}^{\frac{l+3}{2}} t_{i+1,i+2}^{-1} t_{i+3,i+4}^{-1} \cdots t_{i+l,i+l+1}^{-1} h_{i+l} t_{i+l+2,i+l+3}^{-1}}{\rightarrow} \\
& \quad \cdot h_{i+l-2} \cdots h_{i+3} h_{i+1} t_{i,i+1} (h_{i+1} h_{i+3} \cdots h_{i+l-2} \cdot t_{i+l,i+l+1}^{-1} t_{i+l+2,i+l+3} \\
& \quad \cdot h_{i+l} \cdot t_{i+l+1,i+l+2} t_{i+l+3,i+l+4}^{-1} \underline{h_{i+l+2} h_{i+l+1}} \cdot h_{i+l+4} \cdots h_{j-2}) \\
& \stackrel{(2)(d)}{=} \frac{t_{i+l+2,i+l+3}^{\frac{l+3}{2}} t_{i+1,i+2}^{-1} t_{i+3,i+4}^{-1} \cdots t_{i+l,i+l+1}^{-1} h_{i+l} t_{i+l+2,i+l+3}^{-1}}{\rightarrow} \\
& \quad \cdot h_{i+l-2} \cdots h_{i+3} h_{i+1} t_{i,i+1} (h_{i+1} h_{i+3} \cdots h_{i+l-2} \cdot \underline{t_{i+l+2,i+l+3} t_{i+l+3,i+l+4}^{-1}} \\
& \quad \cdot h_{i+l} h_{i+l+2} \cdot h_{i+l+4} \cdots h_{j-2}) h_{i+l+1} \\
& \stackrel{(1)(b)}{=} \frac{t_{i+l+2,i+l+3}^{\frac{l+3}{2}} t_{i+1,i+2}^{-1} t_{i+3,i+4}^{-1} \cdots t_{i+l,i+l+1}^{-1} \cdot t_{i+l+3,i+l+4}^{-1}}{\rightarrow} \\
& \stackrel{(1)(c)}{=} h_{i+l} \cdots h_{i+3} h_{i+1} t_{i,i+1} (h_{i+1} h_{i+3} \cdots h_{j-2}) h_{i+l+1}.
\end{aligned}$$

Hence, by using this relation inductively, for odd $j - i \geq 7$, we have

$$\begin{aligned}
& h_{j-2} \cdots h_{i+4} h_{i+3} \cdot t_{i+3,i+4} \cdot t_{i+1,i+2}^{-1} t_{i+4,i+5}^{-1} h_{i+1} t_{i,i+1} (h_{i+1} h_{i+3} \cdots h_{j-2}) h_{i+2} h_i \\
& = h_{j-2} \cdots h_{i+6} h_{i+5} \cdot t_{i+5,i+6}^2 t_{i+1,i+2}^{-1} t_{i+3,i+4}^{-1} t_{i+6,i+7}^{-1} h_{i+3} h_{i+1} t_{i,i+1} \\
& \quad \cdot (h_{i+1} h_{i+3} \cdots h_{j-2}) h_{i+4} h_{i+2} h_i \\
& = h_{j-2} \cdots h_{i+8} h_{i+7} \cdot t_{i+7,i+8}^3 t_{i+1,i+2}^{-1} t_{i+3,i+4}^{-1} t_{i+5,i+6}^{-1} t_{i+8,i+9}^{-1} h_{i+5} h_{i+3} h_{i+1} t_{i,i+1} \\
& \quad \cdot (h_{i+1} h_{i+3} \cdots h_{j-2}) h_{i+6} h_{i+4} h_{i+2} h_i \\
& \quad \vdots \\
& = h_{j-2} \cdot t_{j-2,j-1}^{\frac{j-i-3}{2}} \cdot t_{i+1,i+2}^{-1} t_{i+3,i+4}^{-1} \cdots t_{j-4,j-3}^{-1} \cdot t_{j-1,j}^{-1} \\
& \quad \cdot h_{j-4} \cdots h_{i+3} h_{i+1} t_{i,i+1} (h_{i+1} h_{i+3} \cdots h_{j-2}) h_{j-3} \cdots h_{i+2} h_i.
\end{aligned}$$

Thus, for odd $j - i \geq 5$, up to the relations (1), (2), and $t_{2n+1,2n+2} = t_{1,2n}$, we have

$$\begin{aligned}
& h_{j-2} \cdots h_{i+1} h_i (h_{i+1} h_{i+3} \cdots h_{j-2}) \\
& = \frac{h_{j-2} \cdot t_{j-2,j-1}^{\frac{j-i-3}{2}} \cdot t_{i+1,i+2}^{-1} t_{i+3,i+4}^{-1} \cdots t_{j-4,j-3}^{-1} \cdot t_{j-1,j}^{-1}}{\rightarrow} \\
& \quad \cdot h_{j-4} \cdots h_{i+3} h_{i+1} t_{i,i+1} (h_{i+1} h_{i+3} \cdots h_{j-2}) h_{j-3} \cdots h_{i+2} h_i \\
& \stackrel{(2)(a)}{=} \frac{t_{j-1,j}^{\frac{j-i-3}{2}} \cdot t_{i+1,i+2}^{-1} t_{i+3,i+4}^{-1} \cdots t_{j-4,j-3}^{-1} \cdot t_{j-2,j-1}^{-1}}{\rightarrow} \\
& \stackrel{(1)(c)}{=} h_{j-2} \cdots h_{i+3} h_{i+1} t_{i,i+1} h_{i+1} h_{i+3} \cdots h_{j-2} \cdot h_{j-3} \cdots h_{i+2} h_i.
\end{aligned}$$

Therefore, we have completed the proof of Lemma 5.26. \square

Lemma 5.27. For $1 \leq i < j \leq 2n + 2$ in the case of LMod_{2n+2} and $1 \leq i < j \leq 2n + 1$ in the case of LMod_{2n+1}^1 such that $j - i \geq 3$ is odd, the relation

$$\begin{aligned}
& (h_{j-4} \cdots h_{i+1} h_i)^{\frac{j-i-1}{2}} \\
& \Leftrightarrow t_{i+1,i+2}^{-1} t_{i+3,i+4}^{-1} \cdots t_{j-2,j-1}^{-1} h_{j-2} \cdots h_{i+3} h_{i+1} t_{i,i+1} h_{i+1} h_{i+3} \cdots h_{j-2}
\end{aligned}$$

is obtained from the relations (1), (2), and $t_{2n+1,2n+2} = t_{1,2n}$.

Proof. In the case of $j - i = 3$, the relation in Lemma 5.27 coincides with the trivial relation. We assume that $j - i \geq 5$ is odd. Then we have

$$h_{j-2} h_{j-4} \cdots h_{i+1} t_{i,i+1} h_{i+1} \cdots \underline{h_{j-4} h_{j-2}} \cdot (h_{j-4} h_{j-5} \cdots h_i)$$

$$\begin{aligned}
& \stackrel{(2)(e)}{=} h_{j-2}h_{j-4} \cdots h_{i+1}t_{i,i+1}h_{i+1} \cdots h_{j-8}h_{j-6} \cdot \underbrace{t_{j-3,j-2}t_{j-2,j-1}^{-1}h_{j-2}h_{j-4}h_{j-2}}_{\leftarrow} \\
& \quad \cdot h_{j-5}h_{j-6} \cdots h_i \\
& \stackrel{(1)}{=} \underline{h_{j-2}h_{j-4} \cdot t_{j-3,j-2} \cdot t_{j-2,j-1}^{-1}h_{j-2}} \cdot h_{j-6}h_{j-8} \cdots h_{i+1}t_{i,i+1}h_{i+1} \cdots h_{j-4}h_{j-2} \\
& \quad \cdot h_{j-5}h_{j-6} \cdots h_i \\
& \stackrel{(2)(a)}{=} t_{j-4,j-3} \underline{h_{j-2}h_{j-4}h_{j-2}t_{j-1,j}^{-1}} \cdot h_{j-6}h_{j-8} \cdots h_{i+1}t_{i,i+1}h_{i+1} \cdots h_{j-4}h_{j-2} \\
& \stackrel{(1)(c)}{=} \cdot h_{j-5}h_{j-6} \cdots h_i \\
& \stackrel{(2)(e)}{=} t_{j-4,j-3}t_{j-2,j-1}t_{j-3,j-2}^{-1}h_{j-4} \underline{h_{j-2}h_{j-4}t_{j-1,j}^{-1}} \cdot h_{j-6}h_{j-8} \cdots h_{i+1} \\
& \quad \cdot t_{i,i+1}h_{i+1} \cdots h_{j-4}h_{j-2} \cdot h_{j-5}h_{j-6} \cdots h_i \\
& \stackrel{(2)(a)}{=} t_{j-4,j-3}t_{j-2,j-1}h_{j-4}t_{j-4,j-3}^{-1}t_{j-2,j-1}^{-1} \cdot h_{j-2}h_{j-4} \cdots h_{i+1} \\
& \stackrel{(1)(c)}{=} \cdot t_{i,i+1}h_{i+1} \cdots h_{j-4}h_{j-2} \cdot \underbrace{h_{j-5}h_{j-6} \cdots h_{i+1}h_i}_{\leftarrow} \\
& \stackrel{\text{Lem.5.22}}{=} t_{j-4,j-3}t_{j-2,j-1}h_{j-4}t_{j-4,j-3}^{-1}t_{j-2,j-1}^{-1} \cdot h_{j-5}h_{j-6} \cdots h_{i+1} \\
& \quad \cdot h_{j-2}h_{j-4} \cdots h_{i+1}t_{i,i+1}h_{i+1} \cdots h_{j-4}h_{j-2} \cdot \underbrace{h_i}_{\leftarrow} \\
& \stackrel{(1)(a)}{=} t_{j-4,j-3}t_{j-2,j-1}h_{j-4}t_{j-4,j-3}^{-1}t_{j-2,j-1}^{-1} \cdot h_{j-5}h_{j-6} \cdots h_{i+1} \\
& \quad \cdot h_{j-2}h_{j-4} \cdots h_{i+1} \underline{t_{i,i+1}h_{i+1}h_i} \cdot h_{i+3} \cdots h_{j-4}h_{j-2} \\
& \stackrel{(2)(d)}{=} t_{j-4,j-3}t_{j-2,j-1}h_{j-4}t_{j-4,j-3}^{-1}t_{j-2,j-1}^{-1} \cdot h_{j-5}h_{j-6} \cdots h_{i+1} \\
& \stackrel{(2)(b)}{=} \cdot h_{j-2}h_{j-4} \cdots \underline{h_{i+1}t_{i+2,i+3}h_i}h_{i+1} \cdot h_{i+3} \cdots h_{j-4}h_{j-2} \\
& \stackrel{(2)(a)}{=} t_{j-4,j-3}t_{j-2,j-1}h_{j-4}t_{j-4,j-3}^{-1}t_{j-2,j-1}^{-1} \cdot h_{j-5}h_{j-6} \cdots h_{i+1} \cdot h_{j-2}h_{j-4} \cdots h_{i+3} \\
& \quad \cdot t_{i+1,i+2} \underline{h_{i+1}h_i}h_{i+1} \cdot h_{i+3} \cdots h_{j-4}h_{j-2} \\
& \stackrel{(2)(d)}{=} t_{j-4,j-3}t_{j-2,j-1}h_{j-4}t_{j-4,j-3}^{-1}t_{j-2,j-1}^{-1} \cdot h_{j-5}h_{j-6} \cdots h_{i+1} \cdot h_{j-2}h_{j-4} \cdots h_{i+3} \\
& \quad \cdot t_{i+1,i+2}t_{i,i+1}^{-1} \underline{t_{i+2,i+3}h_i}h_{i+1}h_{i+1} \cdot h_{i+3} \cdots h_{j-4}h_{j-2} \\
& \stackrel{(2)(b)}{=} t_{j-4,j-3}t_{j-2,j-1}h_{j-4}t_{j-4,j-3}^{-1}t_{j-2,j-1}^{-1} \cdot h_{j-5}h_{j-6} \cdots h_{i+1} \cdot h_{j-2}h_{j-4} \cdots h_{i+3} \\
& \quad \cdot \underbrace{t_{i+1,i+2}t_{i,i+1}^{-1}h_i}_{\leftarrow}h_{i+1}t_{i,i+1}h_{i+1} \cdot h_{i+3} \cdots h_{j-4}h_{j-2} \\
& \stackrel{(1)(a)}{=} t_{j-4,j-3}t_{j-2,j-1}h_{j-4}t_{j-4,j-3}^{-1}t_{j-2,j-1}^{-1} \cdot h_{j-5}h_{j-6} \cdots h_{i+1} \cdot t_{i+1,i+2} \underline{t_{i,i+1}^{-1}h_i} \\
& \stackrel{(1)(c)}{=} \cdot h_{j-2}h_{j-4} \cdots h_{i+1}t_{i,i+1}h_{i+1} \cdots h_{j-4}h_{j-2} \\
& \stackrel{(1)(b)}{=} t_{j-4,j-3}t_{j-2,j-1}h_{j-4}t_{j-2,j-1}^{-1} \cdot h_{j-5}h_{j-6} \cdots h_{i+1}h_it_{i+1,i+2}^{-1} \\
& \stackrel{(2)(a)}{=} \cdot h_{j-2}h_{j-4} \cdots h_{i+1}t_{i,i+1}h_{i+1} \cdots h_{j-4}h_{j-2} \\
& \stackrel{(1)(c)}{=} t_{j-4,j-3}t_{j-2,j-1}h_{j-4}h_{j-5} \cdots h_it_{j-2,j-1}^{-1}t_{i+1,i+2}^{-1} \\
& \quad \cdot h_{j-2}h_{j-4} \cdots h_{i+1}t_{i,i+1}h_{i+1} \cdots h_{j-4}h_{j-2}.
\end{aligned}$$

Thus we have

$$h_{j-2}h_{j-4} \cdots h_{i+1}t_{i,i+1}h_{i+1} \cdots h_{j-4}h_{j-2}(h_{j-4}h_{j-5} \cdots h_i)^{\frac{j-i-1}{2}}$$

$$= (t_{j-4,j-3}t_{j-2,j-1}h_{j-4}h_{j-5} \cdots h_i t_{j-2,j-1}^{-1} t_{i+1,i+2}^{-1})^{\frac{j-i-1}{2}} \\ \cdot h_{j-2}h_{j-4} \cdots h_{i+1}t_{i,i+1}h_{i+1} \cdots h_{j-4}h_{j-2}.$$

Hence it is enough for completing the proof of Lemma 5.27 to prove that

$$(t_{j-4,j-3}t_{j-2,j-1}h_{j-4}h_{j-5} \cdots h_i t_{j-2,j-1}^{-1} t_{i+1,i+2}^{-1})^{\frac{j-i-1}{2}} \\ = t_{j-2,j-1} \cdots t_{i+3,i+4}t_{i+1,i+2}(h_{j-4} \cdots h_{i+1}h_i)^{\frac{j-i-1}{2}} t_{i+1,i+2}^{-1} t_{i+3,i+4}^{-1} \cdots t_{j-2,j-1}^{-1}.$$

We have

$$\begin{aligned} & \frac{(t_{j-4,j-3}t_{j-2,j-1}h_{j-4}h_{j-5} \cdots h_i t_{j-2,j-1}^{-1} t_{i+1,i+2}^{-1})^{\frac{j-i-1}{2}}}{(1)(b)} \\ & \frac{t_{j-2,j-1}(t_{j-4,j-3}h_{j-4}h_{j-5} \cdots h_i t_{i+1,i+2}^{-1})^{\frac{j-i-1}{2}} t_{j-2,j-1}^{-1}}{=} \\ & = \frac{t_{j-2,j-1}t_{j-4,j-3}h_{j-4}h_{j-5} \cdots h_i t_{i+1,i+2}^{-1}(t_{j-4,j-3}h_{j-4}h_{j-5} \cdots h_i t_{i+1,i+2}^{-1})^{\frac{j-i-5}{2}}}{=} \\ & \frac{t_{j-4,j-3}h_{j-4}h_{j-5} \cdots h_i t_{i+1,i+2}^{-1} t_{j-2,j-1}^{-1}}{(1)(b)} \\ & \frac{t_{j-2,j-1}t_{j-4,j-3}h_{j-4}h_{j-5} \cdots h_i t_{j-4,j-3}(t_{i+1,i+2}^{-1} h_{j-4}h_{j-5} \cdots h_i t_{j-4,j-3})^{\frac{j-i-5}{2}}}{=} \\ & \frac{\cdot t_{i+1,i+2}^{-1} h_{j-4}h_{j-5} \cdots h_i t_{i+1,i+2}^{-1} t_{j-2,j-1}^{-1}}{(1)} \\ & \frac{t_{j-2,j-1}t_{j-4,j-3}t_{j-6,j-5} \cdot h_{j-4}h_{j-5} \cdots h_i (t_{i+1,i+2}^{-1} h_{j-4}h_{j-5} \cdots h_i t_{j-4,j-3})^{\frac{j-i-5}{2}}}{(2)(b)} \\ & \frac{\cdot h_{j-4}h_{j-5} \cdots h_i \cdot t_{i+1,i+2}^{-1} t_{i+3,i+4}^{-1} t_{j-2,j-1}^{-1}}{(1)} \\ & \frac{t_{j-2,j-1}t_{j-4,j-3}t_{j-6,j-5} \cdot h_{j-4}h_{j-5} \cdots h_i (t_{j-6,j-5}h_{j-4}h_{j-5} \cdots h_i t_{i+3,i+4}^{-1})^{\frac{j-i-5}{2}}}{(2)(b)} \\ & \frac{\cdot h_{j-4}h_{j-5} \cdots h_i \cdot t_{i+1,i+2}^{-1} t_{i+3,i+4}^{-1} t_{j-2,j-1}^{-1}}{=} \\ & = \frac{t_{j-2,j-1}t_{j-4,j-3}t_{j-6,j-5} \cdot h_{j-4}h_{j-5} \cdots h_i \cdot t_{j-6,j-5}h_{j-4}h_{j-5} \cdots h_i t_{i+3,i+4}^{-1}}{=} \\ & \frac{(t_{j-6,j-5}h_{j-4}h_{j-5} \cdots h_i t_{i+3,i+4}^{-1})^{\frac{j-i-9}{2}}}{=} \\ & \frac{\cdot t_{j-6,j-5}h_{j-4}h_{j-5} \cdots h_i t_{i+3,i+4}^{-1} \cdot h_{j-4}h_{j-5} \cdots h_i \cdot t_{i+1,i+2}^{-1} t_{i+3,i+4}^{-1} t_{j-2,j-1}^{-1}}{(1)} \\ & \frac{t_{j-2,j-1}t_{j-4,j-3}t_{j-6,j-5}t_{j-8,j-7}(h_{j-4}h_{j-5} \cdots h_i)^2 t_{i+3,i+4}^{-1}}{(2)(b)} \\ & \frac{(t_{j-6,j-5}h_{j-4}h_{j-5} \cdots h_i t_{i+3,i+4}^{-1})^{\frac{j-i-9}{2}} t_{j-6,j-5}(h_{j-4}h_{j-5} \cdots h_i)^2}{=} \\ & \frac{\cdot t_{i+1,i+2}^{-1} t_{i+3,i+4}^{-1} t_{i+5,i+6}^{-1} t_{j-2,j-1}^{-1}}{=} \\ & = \frac{t_{j-2,j-1}t_{j-4,j-3}t_{j-6,j-5}t_{j-8,j-7}(h_{j-4}h_{j-5} \cdots h_i)^2 t_{j-6,j-5}}{=} \\ & \frac{(t_{i+3,i+4}^{-1} h_{j-4}h_{j-5} \cdots h_i t_{j-6,j-5})^{\frac{j-i-9}{2}} t_{i+3,i+4}^{-1} (h_{j-4}h_{j-5} \cdots h_i)^2}{=} \\ & \frac{\cdot t_{i+1,i+2}^{-1} t_{i+3,i+4}^{-1} t_{i+5,i+6}^{-1} t_{i+7,i+8}^{-1} t_{j-2,j-1}^{-1}}{(1)} \\ & \frac{t_{j-2,j-1}t_{j-4,j-3}t_{j-6,j-5}t_{j-8,j-7}t_{j-10,j-9}(h_{j-4}h_{j-5} \cdots h_i)^2}{(2)(b)} \\ & \frac{(t_{i+3,i+4}^{-1} h_{j-4}h_{j-5} \cdots h_i t_{j-6,j-5})^{\frac{j-i-9}{2}} (h_{j-4}h_{j-5} \cdots h_i)^2}{=} \\ & \frac{\cdot t_{i+1,i+2}^{-1} t_{i+3,i+4}^{-1} t_{i+5,i+6}^{-1} t_{i+7,i+8}^{-1} t_{j-2,j-1}^{-1}}{(1)} \\ & \frac{t_{j-2,j-1}t_{j-4,j-3}t_{j-6,j-5}t_{j-8,j-7}t_{j-10,j-9}(h_{j-4}h_{j-5} \cdots h_i)^2}{(2)(b)} \\ & \frac{(t_{j-8,j-7}h_{j-4}h_{j-5} \cdots h_i t_{i+5,i+6}^{-1})^{\frac{j-i-9}{2}} (h_{j-4}h_{j-5} \cdots h_i)^2}{=} \\ & \frac{\cdot t_{i+1,i+2}^{-1} t_{i+3,i+4}^{-1} t_{i+5,i+6}^{-1} t_{i+7,i+8}^{-1} t_{j-2,j-1}^{-1}}{=} \end{aligned}$$

$$\begin{aligned}
& \vdots \\
& \begin{cases}
(1) & \left\{ \begin{aligned}
& t_{j-2,j-1} \cdots t_{i+3,i+4} t_{i+1,i+2} (h_{j-4} h_{j-5} \cdots h_i)^{\frac{j-i-3}{4}} \\
& \cdot \frac{t_{\frac{j+i-5}{2}, \frac{j+i-3}{2}} h_{j-4} h_{j-5} \cdots h_i t_{\frac{j+i-1}{2}, \frac{j+i+1}{2}}^{-1} (h_{j-4} h_{j-5} \cdots h_i)^{\frac{j-i-3}{4}}}{t_{i+1,i+2}^{-1} t_{i+3,i+4}^{-1} \cdots t_{j-2,j-1}^{-1}} \text{ for } \frac{j-i-1}{2} \text{ is odd,} \\
(2)(b) & \left\{ \begin{aligned}
& t_{j-2,j-1} \cdots t_{i+5,i+6} t_{i+3,i+4} (h_{j-4} h_{j-5} \cdots h_i)^{\frac{j-i-5}{4}} \\
& \cdot (t_{\frac{j+i-3}{2}, \frac{j+i-1}{2}} h_{j-4} h_{j-5} \cdots h_i t_{\frac{j+i-3}{2}, \frac{j+i-1}{2}}^{-1})^2 (h_{j-4} h_{j-5} \cdots h_i)^{\frac{j-i-5}{4}} \\
& \cdot \frac{t_{i+1,i+2}^{-1} t_{i+3,i+4}^{-1} \cdots t_{j-6,j-5}^{-1} \cdot t_{j-2,j-1}^{-1}}{t_{i+1,i+2}^{-1} t_{i+3,i+4}^{-1} \cdots t_{j-6,j-5}^{-1} \cdot t_{j-2,j-1}^{-1}} \\
& = t_{j-2,j-1} \cdots t_{i+5,i+6} t_{i+3,i+4} (h_{j-4} h_{j-5} \cdots h_i)^{\frac{j-i-5}{4}} t_{\frac{j+i-3}{2}, \frac{j+i-1}{2}}^{-1} \\
& \cdot (h_{j-4} h_{j-5} \cdots h_i)^2 \frac{t_{\frac{j+i-3}{2}, \frac{j+i-1}{2}}^{-1} (h_{j-4} h_{j-5} \cdots h_i)^{\frac{j-i-5}{4}}}{t_{i+1,i+2}^{-1} t_{i+3,i+4}^{-1} \cdots t_{j-6,j-5}^{-1} \cdot t_{j-2,j-1}^{-1}} \\
& \cdot t_{i+1,i+2}^{-1} t_{i+3,i+4}^{-1} \cdots t_{j-6,j-5}^{-1} \cdot t_{j-2,j-1}^{-1} \text{ for } \frac{j-i-1}{2} \text{ is even,}
\end{aligned} \right. \\
(1) & t_{j-2,j-1} \cdots t_{i+3,i+4} t_{i+1,i+2} (h_{j-4} \cdots h_{i+1} h_i)^{\frac{j-i-1}{2}} t_{i+1,i+2}^{-1} t_{i+3,i+4}^{-1} \cdots t_{j-2,j-1}^{-1}. \\
(2)(b) &
\end{cases}
\end{cases}
\end{aligned}$$

Therefore we have completed the proof of Lemma 5.27. \square

Lemma 5.28. *For $1 \leq i < j \leq 2n+2$ in the case of LMod_{2n+2} and $1 \leq i < j \leq 2n+1$ in the case of LMod_{2n+1}^1 such that $j-i \geq 3$ is odd, the relation*

$$(h_{j-2} \cdots h_{i+1} h_i)^{\frac{j-i+1}{2}} = (h_i h_{i+1} \cdots h_{j-2})^{\frac{j-i+1}{2}}$$

is obtained from the relations (1), (2), $t_{2n+1,2n+2} = t_{1,2n}$, and relations in Corollary 5.23, Lemmas 5.24, 5.26, and 5.27.

Proof. We proceed by induction on $\frac{j-i+1}{2} \geq 2$. In the case of $\frac{j-i+1}{2} = 2$, i.e. $j-2 = i+1$, we have

$$\underline{h_{i+1} h_i} \cdot \underline{h_{i+1} h_i} \stackrel{(2)(d)}{=} h_i h_{i+1} t_{i,i+1} t_{i+2,i+3}^{-1} \cdot h_i h_{i+1} t_{i,i+1} t_{i+2,i+3}^{-1} \stackrel{(2)(a)}{=} h_i h_{i+1} h_i h_{i+1} \stackrel{(2)(b)}{=} h_i h_{i+1} h_i h_{i+1}.$$

Thus Lemma 5.28 is true for $\frac{j-i+1}{2} = 2$.

Assume $\frac{j-i+1}{2} \geq 3$. By the inductive hypothesis, the relation

$$(h_{j-4} \cdots h_{i+1} h_i)^{\frac{j-i-1}{2}} = (h_i h_{i+1} \cdots h_{j-4})^{\frac{j-i-1}{2}}$$

holds in LMod_{2n+1}^1 for $j \leq 2n+1$ and LMod_{2n+2} . Then we have

$$\begin{aligned}
& (h_{j-2} \cdots h_{i+1} h_i)^{\frac{j-i+1}{2}} = h_{j-2} \cdots h_{i+1} h_i \underline{(h_{j-2} \cdots h_{i+1} h_i)^{\frac{j-i-1}{2}}} \\
& \stackrel{\text{Lem.5.24}}{=} h_{j-2} \cdots h_{i+1} h_i \cdot h_{i+1} h_{i+3} \cdots h_{j-2} \underline{(h_{j-3} \cdots h_{i+1} h_i)^{\frac{j-i-1}{2}}} \\
& \stackrel{\text{Lem.5.24}}{=} h_{j-2} \cdots h_{i+1} h_i \cdot h_{i+1} h_{i+3} \cdots h_{j-2} \cdot h_i h_{i+2} \cdots h_{j-3} \underline{(h_{j-4} \cdots h_{i+1} h_i)^{\frac{j-i-1}{2}}} \\
& \stackrel{\text{Lem.5.26}}{=} \frac{t_{\frac{j-i-3}{2}, j}^{-1} t_{i+1,i+2}^{-1} t_{i+3,i+4}^{-1} \cdots t_{j-2,j-1}^{-1} h_{j-2} \cdots h_{i+3} h_{i+1} t_{i,i+1} h_{i+1} h_{i+3} \cdots h_{j-2}}{t_{j-1,j}^{-1} t_{i+1,i+2}^{-1} t_{i+3,i+4}^{-1} \cdots t_{j-2,j-1}^{-1} h_{j-2} \cdots h_{i+3} h_{i+1} t_{i,i+1} h_{i+1} h_{i+3} \cdots h_{j-2}} \\
& \quad \cdot \underline{h_{j-3} \cdots h_{i+2} h_i \cdot h_i h_{i+2} \cdots h_{j-3} (h_{j-4} \cdots h_{i+1} h_i)^{\frac{j-i-1}{2}}} \\
& \stackrel{\text{Cor.5.23}}{=} \frac{t_{\frac{j-i-3}{2}, j}^{-1} t_{i+1,i+2}^{-1} t_{i+3,i+4}^{-1} \cdots t_{j-2,j-1}^{-1} h_{j-2} \cdots h_{i+3} h_{i+1} t_{i,i+1} h_{i+1} h_{i+3} \cdots h_{j-2}}{t_{j-1,j}^{-1} t_{i+1,i+2}^{-1} t_{i+3,i+4}^{-1} \cdots t_{j-2,j-1}^{-1} h_{j-2} \cdots h_{i+3} h_{i+1} t_{i,i+1} h_{i+1} h_{i+3} \cdots h_{j-2}} \\
& \quad \cdot \underline{(h_{j-4} \cdots h_{i+1} h_i)^{\frac{j-i-1}{2}} h_{j-3} \cdots h_{i+2} h_i \cdot h_i h_{i+2} \cdots h_{j-3}} \\
& \stackrel{\text{Lem.5.27}}{=} \frac{t_{\frac{j-i-3}{2}, j}^{-1} (h_{j-4} \cdots h_{i+1} h_i)^{\frac{j-i-1}{2}} t_{i+1,i+2}^{-1} t_{i+3,i+4}^{-1} \cdots t_{j-2,j-1}^{-1}}{t_{j-1,j}^{-1} t_{i+1,i+2}^{-1} t_{i+3,i+4}^{-1} \cdots t_{j-2,j-1}^{-1}} \\
& \quad \cdot h_{j-2} \cdots h_{i+3} h_{i+1} t_{i,i+1} h_{i+1} h_{i+3} \cdots h_{j-2} \\
& \quad \cdot h_{j-3} \cdots h_{i+2} h_i h_{i+2} \cdots h_{j-3} \\
& \stackrel{(1)(c)}{=} \underline{(h_{j-4} \cdots h_{i+1} h_i)^{\frac{j-i-1}{2}} t_{j-1,j}^{-1} t_{i+1,i+2}^{-1} t_{i+3,i+4}^{-1} \cdots t_{j-2,j-1}^{-1}}
\end{aligned}$$

$$\begin{aligned}
& \frac{\cdot h_{j-2} \cdots h_{i+3} h_{i+1} t_{i,i+1} h_{i+1} h_{i+3} \cdots h_{j-2} \cdot h_{j-3} \cdots h_{i+2} h_i h_i h_{i+2} \cdots h_{j-3}}{\text{Lem.5.26}} \\
& \frac{(h_{j-4} \cdots h_{i+1} h_i)^{\frac{j-i-1}{2}} h_{j-2} \cdots h_{i+1} h_i \cdot h_{i+1} h_{i+3} \cdots h_{j-2} \cdot h_i h_{i+2} \cdots h_{j-3}}{=} \\
& \frac{(h_i h_{i+1} \cdots h_{j-4})^{\frac{j-i-1}{2}} h_{j-2} \cdots h_{i+1} h_i \cdot \frac{h_{i+1} h_{i+3} \cdots h_{j-2}}{\rightarrow} \cdot h_i h_{i+2} \cdots h_{j-3}}{(1)(a)} \\
& \frac{(h_i h_{i+1} \cdots h_{j-4})^{\frac{j-i-1}{2}} h_{j-2} \cdots h_{i+1} h_i \cdot \frac{h_{i+1} h_i \cdot h_{i+3} h_{i+2} \cdots h_{j-2} h_{j-3}}{\rightarrow}}{(2)(d)} \\
& \frac{\cdot h_{j-3} h_{j-2} t_{j-3,j-2} t_{j-1,j}^{-1} \cdots h_{i+2} h_{i+3} t_{i+2,i+3} t_{i+4,i+5}^{-1} \cdot h_i h_{i+1} t_{i,i+1} t_{i+2,i+3}^{-1}}{\rightarrow} \\
& \frac{\cdot t_{i+2,i+3} t_{i,i+1}^{-1} h_i h_{i+1} \cdot \frac{t_{i+4,i+5} t_{i+2,i+3}^{-1}}{\leftarrow} h_{i+2} h_{i+3} \cdots \frac{t_{j-1,j} t_{j-3,j-2}^{-1}}{\leftarrow} h_{j-3} h_{j-2}}{(1)(c)} \\
& \frac{(h_i h_{i+1} \cdots h_{j-4})^{\frac{j-i-1}{2}} h_{j-3} h_{j-2} t_{j-3,j-2} h_{j-5} h_{j-4} \cdots \frac{t_{i+4,i+5} h_{i+2} h_{i+3}}{t_{i+2,i+3}} \frac{t_{i+2,i+3}}{h_i h_{i+1}}}{\cdot \frac{h_i h_{i+1} \cdot t_{i+2,i+3}^{-1}}{h_{i+2} h_{i+3} t_{i+4,i+5}^{-1}} \cdots \frac{h_{j-5} h_{j-4} t_{j-3,j-2}^{-1}}{h_{j-3} h_{j-2}}} \\
& \frac{(h_i h_{i+1} \cdots h_{j-4})^{\frac{j-i-1}{2}} h_{j-3} h_{j-2} h_{j-5} h_{j-4} t_{j-5,j-4} h_{j-7} h_{j-6} \cdots \frac{t_{i+4,i+5} h_{i+2} h_{i+3}}{t_{i+2,i+3} h_i h_{i+1}}}{\cdot \frac{h_i h_{i+1} t_{i+2,i+3}^{-1}}{h_{i+2} h_{i+3} t_{i+4,i+5}^{-1}} \cdots \frac{h_{j-7} h_{j-6} t_{j-5,j-4}^{-1}}{h_{j-5} h_{j-4} h_{j-3} h_{j-2}}} \\
& \frac{(h_i h_{i+1} \cdots h_{j-4})^{\frac{j-i-1}{2}} h_{j-3} h_{j-2} \cdots h_{j-7} h_{j-6} t_{j-7,j-6} h_{j-9} h_{j-8} \cdots \frac{t_{i+2,i+3} h_i h_{i+1}}{\cdot \frac{h_i h_{i+1} \cdot t_{i+2,i+3}^{-1}}{\cdots h_{j-9} h_{j-8} t_{j-7,j-6}^{-1} h_{j-7} h_{j-6} \cdots h_{j-3} h_{j-2}}}} \\
& \vdots \\
& \frac{(h_i h_{i+1} \cdots h_{j-4})^{\frac{j-i-1}{2}} h_{j-3} h_{j-2} \cdot \frac{h_{j-5} h_{j-4} \cdots \frac{h_{i+2} h_{i+3}}{\leftarrow} \cdot \frac{h_i h_{i+1}}{\leftarrow}}{\leftarrow}}{\cdot h_i h_{i+1} \cdot h_{i+2} h_{i+3} \cdots h_{j-5} h_{j-4} \cdot h_{j-3} h_{j-2}} \\
& \frac{(h_i h_{i+1} \cdots h_{j-4})^{\frac{j-i-1}{2}} h_{j-3} h_{j-5} \cdots h_{i+2} h_i \cdot h_{j-2} h_{j-4} \cdots h_{i+3} h_{i+1}}{(1)(a)} \\
& \frac{\cdot h_i h_{i+1} \cdots h_{j-2}}{\text{Lem.5.24}} \\
& (h_i h_{i+1} \cdots h_{j-2})^{\frac{j-i+1}{2}}.
\end{aligned}$$

Therefore, we have completed the proof of Lemma 5.28. \square

Lemma 5.28 give the proof of Lemma 5.16 as follows.

Proof of Lemma 5.16. Assume that $j - i \geq 3$ is odd for $1 \leq i < j \leq 2n + 1$. Then we have

$$\begin{aligned}
& \frac{t_{j-1,j}^{-\frac{j-i-3}{2}} \cdots t_{i+2,i+3}^{-\frac{j-i-3}{2}} t_{i,i+1}^{-\frac{j-i-3}{2}} (h_{j-2} \cdots h_{i+1} h_i)^{\frac{j-i+1}{2}}}{\text{Lem.5.16}} \\
& \frac{t_{j-1,j}^{-\frac{j-i-3}{2}} \cdots t_{i+2,i+3}^{-\frac{j-i-3}{2}} t_{i,i+1}^{-\frac{j-i-3}{2}} (h_i h_{i+1} \cdots h_{j-2})^{\frac{j-i+1}{2}}}{(1)(b)} \\
& \frac{t_{i,i+1}^{-\frac{j-i-3}{2}} t_{i+2,i+3}^{-\frac{j-i-3}{2}} \cdots t_{j-1,j}^{-\frac{j-i-3}{2}} (h_i h_{i+1} \cdots h_{j-2})^{\frac{j-i+1}{2}}}{=}
\end{aligned}$$

Since $j \leq 2n + 1$, $t_{2n+1,2n+2}$ does not appear in the relation above. Therefore the relation in Lemma 5.28 which is used above is obtained from the relations (1) and (2), and we have completed the proof of Lemma 5.16. \square

5.5. Proof of Lemma 5.17. In this section, we prove Lemma 5.17. To prove this lemma, we prepare the following six technical lemmas.

Lemma 5.29. *For $1 \leq i < j \leq 2n$ such that $j - i \geq 4$ is even, the relation*

$$\begin{aligned} & h_{j-2}(h_{j-3} \cdots h_{i+1} h_i) \\ &= (h_{j-3} \cdots h_{i+1} h_i) t_{i,i+1}^{-\frac{j-i-4}{2}} h_i^{-1} h_{i+2}^{-1} \cdots h_{j-4}^{-1} h_{j-2} h_{j-4} \cdots h_{i+2} h_i t_{j-1,j}^{-1} t_{i,i+1}^{\frac{j-i-2}{2}} \end{aligned}$$

is obtained from the relations (1) and (2).

Proof. We have

$$\begin{aligned} & \underline{h_{j-2} \cdot h_{j-3} h_{j-4} \cdots h_i} \\ (2)(d) \quad & \xrightarrow{\underline{h_{j-3} h_{j-4} h_{j-5} \cdots h_i}} h_{j-3} h_{j-2} \underline{t_{j-1,j}^{-1}} t_{j-3,j-2} \cdot h_{j-4} h_{j-5} \cdots h_i \\ (2)(a) \quad & \xrightarrow{(1)} (h_{j-3} h_{j-4}) h_{j-4}^{-1} h_{j-2} h_{j-4} \underline{t_{j-1,j}^{-1} t_{j-4,j-3}} \cdot h_{j-5} h_{j-6} \cdots h_i \\ (2)(a) \quad & \xrightarrow{(1)(c)} h_{j-3} h_{j-4} \cdot h_{j-4}^{-1} h_{j-2} h_{j-4} h_{j-5} \underline{t_{j-1,j}^{-1} t_{j-5,j-4}} \cdot h_{j-6} h_{j-7} \cdots h_i \\ (2)(d) \quad & \xrightarrow{(1)(c)} h_{j-3} h_{j-4} \cdot h_{j-4}^{-1} h_{j-2} h_{j-5} h_{j-4} \underline{t_{j-3,j-2}^{-1} t_{j-1,j}^2 t_{j-5,j-4}^2} \cdot h_{j-6} h_{j-7} \cdots h_i \\ (1) \quad & \xrightarrow{(2)(a)} h_{j-3} h_{j-4} \cdot \underline{h_{j-4}^{-1} h_{j-5} h_{j-2} h_{j-4} t_{j-3,j-2}^{-1} h_{j-6} t_{j-1,j}^2 t_{j-6,j-5}^{-1}} \cdot h_{j-7} h_{j-8} \cdots h_i \\ (2)(d) \quad & \xrightarrow{(2)(a)} h_{j-3} h_{j-4} h_{j-5} \cdot t_{j-5,j-4}^{-1} h_{j-4}^{-1} \underline{t_{j-4,j-3} h_{j-2} h_{j-4} t_{j-3,j-2}^{-1} h_{j-6} t_{j-1,j}^2 t_{j-6,j-5}^{-1}} \\ & \cdot h_{j-7} h_{j-8} \cdots h_i \\ (1)(c) \quad & \xrightarrow{(2)(a)} h_{j-3} h_{j-4} h_{j-5} h_{j-6} \cdot \underline{h_{j-6}^{-1} t_{j-5,j-4}^{-1} h_{j-4}^{-1} h_{j-2} h_{j-4} h_{j-6} t_{j-1,j}^2 t_{j-6,j-5}^{-1}} \\ & \cdot h_{j-7} h_{j-8} \cdots h_i \\ (1)(c) \quad & \xrightarrow{(2)(a)} (h_{j-3} h_{j-4} h_{j-5} h_{j-6}) \underline{t_{j-6,j-5}^{-1} h_{j-6}^{-1} h_{j-4}^{-1} h_{j-2} h_{j-4} h_{j-6} t_{j-1,j}^2 t_{j-6,j-5}^{-1}} \\ & \cdot h_{j-7} h_{j-8} \cdots h_i. \end{aligned}$$

By an inductive argument, for a positive odd $3 \leq l \leq j - i - 7$, the relation

$$\begin{aligned} & (h_{j-3} h_{j-4} \cdots h_{j-l-3}) t_{j-l-3,j-l-2}^{-\frac{l-1}{2}} h_{j-l-3}^{-1} \cdots h_{j-6}^{-1} h_{j-4}^{-1} h_{j-2} h_{j-4} h_{j-6} \cdots h_{j-l-3} t_{j-1,j}^{-1} \\ & \cdot t_{j-l-3,j-l-2}^{\frac{l+1}{2}} h_{j-l-4} \cdots h_{i+1} h_i = (h_{j-3} h_{j-4} \cdots h_{j-l-5}) t_{j-l-5,j-l-4}^{-\frac{l+1}{2}} h_{j-l-5}^{-1} \cdots h_{j-6}^{-1} h_{j-4}^{-1} \\ & \cdot h_{j-2} h_{j-4} h_{j-6} \cdots h_{j-l-5} t_{j-1,j}^{-1} \cdot t_{j-l-5,j-l-4}^{\frac{l+3}{2}} h_{j-l-6} \cdots h_{i+1} h_i \end{aligned}$$

is obtained from the relations (1) and (2). Thus, up to the relations (1) and (2), we have

$$\begin{aligned} & h_{j-2}(h_{j-3} h_{j-4} \cdots h_i) \\ &= (h_{j-3} h_{j-4} \cdots h_{i+2}) t_{i+2,i+3}^{-\frac{j-i-6}{2}} h_{i+2}^{-1} \cdots h_{j-6}^{-1} h_{j-4}^{-1} h_{j-2} h_{j-4} h_{j-6} \cdots h_{i+2} \\ & \cdot t_{j-1,j}^{-1} t_{i+2,i+3}^{\frac{j-i-4}{2}} h_{i+1} h_i \\ (2)(a) \quad & \xrightarrow{(1)(c)} h_{j-3} h_{j-4} \cdots h_{i+2} \cdot t_{i+2,i+3}^{-\frac{j-i-6}{2}} h_{i+2}^{-1} \cdots h_{j-6}^{-1} h_{j-4}^{-1} h_{j-2} h_{j-4} h_{j-6} \cdots \underline{h_{i+2} \cdot h_{i+1} h_i} \\ & \cdot t_{j-1,j}^{-1} t_{i,i+1}^{\frac{j-i-4}{2}} \\ (2)(d) \quad & \xrightarrow{(2)(a)} h_{j-3} h_{j-4} \cdots h_{i+2} \cdot t_{i+2,i+3}^{-\frac{j-i-6}{2}} h_{i+2}^{-1} \cdots h_{j-6}^{-1} h_{j-4}^{-1} h_{j-2} h_{j-4} h_{j-6} \cdots h_{i+4} \end{aligned}$$

$$\begin{aligned}
& \cdot \frac{h_{i+1} h_{i+2} t_{i+3, i+4}^{-1} t_{i+1, i+2} h_i t_{j-1, j}^{-1} t_{i, i+1}^{\frac{j-i-4}{2}}}{\leftarrow} \\
(1) & \quad h_{j-3} h_{j-4} \cdots h_{i+2} \cdot t_{i+2, i+3}^{-\frac{j-i-6}{2}} h_{i+2}^{-1} h_{i+1} \\
(2)(a) & \quad \cdot h_{i+4}^{-1} \cdots h_{j-6}^{-1} h_{j-4}^{-1} h_{j-2} h_{j-4} h_{j-6} \cdots h_{i+4} h_{i+2} t_{i+3, i+4}^{-1} h_i t_{j-1, j}^{-1} t_{i, i+1}^{\frac{j-i-2}{2}} \\
(2)(d) & \quad h_{j-3} h_{j-4} \cdots h_{i+2} \cdot t_{i+2, i+3}^{-\frac{j-i-6}{2}} h_{i+1} t_{i+1, i+2}^{-1} t_{i+3, i+4} h_{i+2}^{-1} \\
(2)(a) & \quad \cdot h_{i+4}^{-1} \cdots h_{j-6}^{-1} h_{j-4}^{-1} h_{j-2} h_{j-4} h_{j-6} \cdots h_{i+4} h_{i+2} t_{i+3, i+4}^{-1} h_i t_{j-1, j}^{-1} t_{i, i+1}^{\frac{j-i-2}{2}} \\
(2)(a) & \quad h_{j-3} \cdots h_{i+2} h_{i+1} \cdot t_{i+1, i+2}^{-\frac{j-i-4}{2}} h_{i+2}^{-1} t_{i+2, i+3} \\
& \quad \rightarrow \\
(1)(a) & \quad \cdot h_{i+4}^{-1} \cdots h_{j-6}^{-1} h_{j-4}^{-1} h_{j-2} h_{j-4} h_{j-6} \cdots h_{i+4} h_{i+2} t_{i+3, i+4}^{-1} h_i t_{j-1, j}^{-1} t_{i, i+1}^{\frac{j-i-2}{2}} \\
(1)(a) & \quad h_{j-3} \cdots h_{i+1} h_i \cdot h_i^{-1} t_{i+1, i+2}^{-\frac{j-i-4}{2}} h_{i+2}^{-1} \\
& \quad \cdot h_{i+4}^{-1} \cdots h_{j-6}^{-1} h_{j-4}^{-1} h_{j-2} h_{j-4} h_{j-6} \cdots h_{i+4} t_{i+2, i+3} h_{i+2} t_{i+3, i+4}^{-1} h_i t_{j-1, j}^{-1} t_{i, i+1}^{\frac{j-i-2}{2}} \\
(2)(a) & \quad (h_{j-3} \cdots h_{i+1} h_i) t_{i, i+1}^{-\frac{j-i-4}{2}} h_i^{-1} h_{i+2}^{-1} \\
& \quad \cdot h_{i+4}^{-1} \cdots h_{j-6}^{-1} h_{j-4}^{-1} h_{j-2} h_{j-4} h_{j-6} \cdots h_{i+4} h_{i+2} h_i t_{j-1, j}^{-1} t_{i, i+1}^{\frac{j-i-2}{2}}
\end{aligned}$$

Therefore, we have completed the proof of Lemma 5.29. \square

Lemma 5.30. For $1 \leq i < j \leq 2n$ such that $j - i \geq 4$ is even, the relation

$$\begin{aligned}
& t_{i, i+1}^{-\frac{j-i-4}{2}} h_i^{-1} h_{i+2}^{-1} \cdots h_{j-4}^{-1} h_{j-2} h_{j-4} \cdots h_{i+2} h_i t_{j-1, j}^{-1} t_{i, i+1}^{\frac{j-i-2}{2}} (h_{j-2} \cdots h_{i+1} h_i) \\
& = (h_{j-2} \cdots h_{i+1} h_i) t_{i+2, i+3}^{-\frac{j-i-4}{2}} t_{i, i+1}^{-\frac{j-i-2}{2}} h_i t_{i+2, i+3}^{\frac{j-i-2}{2}} t_{i, i+1}^{\frac{j-i-4}{2}}
\end{aligned}$$

is obtained from the relations (1) and (2).

Proof. We have

$$\begin{aligned}
& t_{i, i+1}^{-\frac{j-i-4}{2}} h_i^{-1} \cdots h_{j-6}^{-1} h_{j-4}^{-1} h_{j-2} h_{j-4} h_{j-6} \cdots h_i t_{j-1, j}^{-1} t_{i, i+1}^{\frac{j-i-2}{2}} (h_{j-2} h_{j-3} \cdots h_i) \\
(1) & \quad t_{i, i+1}^{-\frac{j-i-4}{2}} h_i^{-1} \cdots h_{j-6}^{-1} h_{j-4}^{-1} h_{j-2} h_{j-4} h_{j-6} \cdots h_i (h_{j-2} h_{j-3} \cdots h_i) t_{i, i+1}^{-1} t_{i+2, i+3}^{\frac{j-i-2}{2}} \\
(2) & \quad \leftarrow \\
(1)(a) & \quad t_{i, i+1}^{-\frac{j-i-4}{2}} h_i^{-1} \cdots h_{j-6}^{-1} h_{j-4}^{-1} h_{j-2} h_{j-4} h_{j-6} \cdot h_{j-6} h_{j-8} \cdots h_i \cdot h_{j-3} h_{j-4} \cdots h_i \\
& \quad \cdot t_{i, i+1}^{-1} t_{i+2, i+3}^{\frac{j-i-2}{2}} \\
(2)(e) & \quad t_{i, i+1}^{-\frac{j-i-4}{2}} h_i^{-1} \cdots h_{j-8}^{-1} h_{j-6}^{-1} \cdot h_{j-2} h_{j-4} t_{j-3, j-2}^{-1} t_{j-2, j-1} \cdot h_{j-6} h_{j-8} \cdots h_i \\
& \quad \leftarrow \quad \rightarrow \\
& \quad \cdot h_{j-3} h_{j-4} \cdots h_i t_{i, i+1}^{-1} t_{i+2, i+3}^{\frac{j-i-2}{2}} \\
(1)(a) & \quad h_{j-2} t_{i, i+1}^{-\frac{j-i-4}{2}} h_i^{-1} \cdots h_{j-8}^{-1} h_{j-6}^{-1} \cdot h_{j-4} \cdot h_{j-6} h_{j-8} \cdots h_i \\
(1)(c) & \quad \cdot t_{j-3, j-2}^{-1} t_{j-2, j-1} h_{j-3} h_{j-4} \cdots h_i t_{i, i+1}^{-1} t_{i+2, i+3}^{\frac{j-i-2}{2}} \\
(2)(e) & \quad h_{j-2} t_{i, i+1}^{-\frac{j-i-4}{2}} h_i^{-1} \cdots h_{j-8}^{-1} h_{j-6}^{-1} \cdot h_{j-4} \cdot h_{j-6} h_{j-8} \cdots h_i \\
& \quad \cdot t_{j-3, j-2}^{-1} h_{j-3} h_{j-4} \cdots h_i t_{i+2, i+3}^{\frac{j-i-2}{2}}
\end{aligned}$$

$$\begin{aligned}
& \stackrel{(2)(a)}{=} h_{j-2} t_{i,i+1}^{-\frac{j-i-4}{2}} h_i^{-1} \cdots h_{j-8}^{-1} h_{j-6}^{-1} \cdot h_{j-4} \cdot h_{j-6} h_{j-8} \cdots h_i \\
& \quad \cdot \underbrace{h_{j-3} t_{j-2,j-1}^{-1} h_{j-4} h_{j-5} \cdots h_i t_{i+2,i+3}^{\frac{j-i-2}{2}}}_{\leftarrow} \\
& \stackrel{(1)(a)}{=} h_{j-2} t_{i,i+1}^{-\frac{j-i-4}{2}} h_i^{-1} \cdots h_{j-8}^{-1} h_{j-6}^{-1} \cdot \underline{h_{j-4} h_{j-3}} \cdot h_{j-6} h_{j-8} \cdots h_i \\
& \quad \cdot t_{j-2,j-1}^{-1} h_{j-4} h_{j-5} \cdots h_i t_{i+2,i+3}^{\frac{j-i-2}{2}} \\
& \stackrel{(2)(d)}{=} h_{j-2} t_{i,i+1}^{-\frac{j-i-4}{2}} h_i^{-1} \cdots h_{j-8}^{-1} h_{j-6}^{-1} \cdot \underline{h_{j-3} t_{j-3,j-2}^{-1} h_{j-4}} \cdot h_{j-6} h_{j-8} \cdots h_i \\
& \stackrel{(1)(2)}{=} \quad \quad \quad \leftarrow \\
& \quad \cdot h_{j-4} h_{j-5} \cdots h_i t_{i+2,i+3}^{\frac{j-i-2}{2}} \\
& \stackrel{(2)(d)}{=} (h_{j-2} h_{j-3}) t_{i,i+1}^{-\frac{j-i-4}{2}} t_{j-3,j-2}^{-1} h_i^{-1} \cdots h_{j-8}^{-1} h_{j-6}^{-1} h_{j-4} h_{j-6} h_{j-8} \cdots h_i \\
& \stackrel{(1)(c)}{=} \quad \quad \quad \cdot (h_{j-4} h_{j-5} \cdots h_i) t_{i+2,i+3}^{\frac{j-i-2}{2}}
\end{aligned}$$

By an inductive argument, for a positive odd $3 \leq l \leq j - i - 5$, the relation

$$\begin{aligned}
& (h_{j-2} h_{j-3} \cdots h_{j-l}) t_{i,i+1}^{-\frac{j-i-4}{2}} t_{j-l,j-l+1}^{-\frac{l-1}{2}} h_i^{-1} \cdots h_{j-l-5}^{-1} h_{j-l-3}^{-1} h_{j-l-1} h_{j-l-3} h_{j-l-5} \cdots h_i \\
& \cdot (h_{j-l-1} h_{j-l-2} \cdots h_i) t_{i,i+1}^{\frac{l-3}{2}} t_{i+2,i+3}^{\frac{j-i-2}{2}} = (h_{j-2} h_{j-3} \cdots h_{j-l-2}) t_{i,i+1}^{-\frac{j-i-4}{2}} t_{j-l-2,j-l-1}^{-\frac{l+1}{2}} \\
& \cdot h_i^{-1} \cdots h_{j-l-7}^{-1} h_{j-l-5}^{-1} h_{j-l-3} h_{j-l-5} h_{j-l-7} \cdots h_i (h_{j-l-3} h_{j-l-4} \cdots h_i) t_{i,i+1}^{\frac{l-1}{2}} t_{i+2,i+3}^{\frac{j-i-2}{2}}
\end{aligned}$$

is obtained from the relations (1) and (2). Thus, up to the relations (1) and (2), we have

$$\begin{aligned}
& t_{i,i+1}^{-\frac{j-i-4}{2}} h_i^{-1} \cdots h_{j-6}^{-1} h_{j-4}^{-1} h_{j-2} h_{j-4} h_{j-6} \cdots h_i t_{j-1,j}^{-1} t_{i,i+1}^{\frac{j-i-2}{2}} \cdot h_{j-2} h_{j-3} \cdots h_i \\
& = h_{j-2} h_{j-3} \cdots h_{i+3} t_{i,i+1}^{-\frac{j-i-4}{2}} t_{i+3,i+4}^{-\frac{j-i-4}{2}} h_i^{-1} \underline{h_{i+2} h_i} \cdot h_{i+2} h_{i+1} h_i t_{i,i+1}^{\frac{j-i-6}{2}} t_{i+2,i+3}^{\frac{j-i-2}{2}} \\
& \stackrel{(2)(e)}{=} h_{j-2} h_{j-3} \cdots h_{i+3} t_{i,i+1}^{-\frac{j-i-4}{2}} t_{i+3,i+4}^{-\frac{j-i-4}{2}} h_{i+2} t_{i,i+1}^{-1} h_i t_{i+2,i+3} h_{i+1} h_i t_{i,i+1}^{\frac{j-i-6}{2}} t_{i+2,i+3}^{\frac{j-i-2}{2}} \\
& \stackrel{(2)(a)}{=} h_{j-2} h_{j-3} \cdots h_{i+3} t_{i,i+1}^{-\frac{j-i-4}{2}} \underline{h_{i+2} t_{i,i+1}^{-1} t_{i+2,i+3}} h_i h_{i+1} h_i t_{i,i+1}^{\frac{j-i-4}{2}} t_{i+2,i+3}^{\frac{j-i-2}{2}} \\
& \stackrel{(1)}{=} \quad \quad \quad \leftarrow \\
& \stackrel{(2)(d)}{=} h_{j-2} h_{j-3} \cdots h_{i+2} t_{i,i+1}^{-\frac{j-i-2}{2}} t_{i+2,i+3}^{-\frac{j-i-4}{2}} h_{i+1} h_i t_{i+2,i+3} t_{i,i+1}^{-1} h_i t_{i,i+1}^{\frac{j-i-4}{2}} t_{i+2,i+3}^{\frac{j-i-2}{2}} \\
& \stackrel{(1)}{=} \quad \quad \quad \cdot h_{i+2} t_{i,i+1}^{-\frac{j-i-2}{2}} t_{i+2,i+3}^{-\frac{j-i-4}{2}} t_{i+2,i+3} t_{i,i+1}^{-1} h_i t_{i,i+1}^{\frac{j-i-4}{2}} t_{i+2,i+3}^{\frac{j-i-2}{2}} \\
& \stackrel{(2)(a)}{=} h_{j-2} h_{j-3} \cdots h_i t_{i+2,i+3}^{-\frac{j-i-2}{2}} t_{i+2,i+3}^{-\frac{j-i-4}{2}} t_{i+2,i+3} t_{i,i+1}^{-1} h_i t_{i,i+1}^{\frac{j-i-4}{2}} t_{i+2,i+3}^{\frac{j-i-2}{2}} \\
& \stackrel{(2)(b)}{=} \quad \quad \quad \cdot h_i t_{i+2,i+3}^{-\frac{j-i-2}{2}} t_{i+2,i+3}^{-\frac{j-i-4}{2}} t_{i+2,i+3} t_{i,i+1}^{-1} h_i t_{i,i+1}^{\frac{j-i-4}{2}} t_{i+2,i+3}^{\frac{j-i-2}{2}} \\
& \stackrel{(1)(b)}{=} h_{j-2} h_{j-3} \cdots h_i t_{i,i+1}^{-\frac{j-i-2}{2}} t_{i+2,i+3}^{-\frac{j-i-4}{2}} h_i t_{i+2,i+3}^{\frac{j-i-2}{2}} t_{i+2,i+3}^{\frac{j-i-4}{2}}
\end{aligned}$$

Therefore, we have completed the proof of Lemma 5.30. \square

Lemma 5.31. For $1 \leq i < j \leq 2n$ such that $j - i \geq 4$ is even, the relation

$$\begin{aligned}
& (t_{i+2,i+3} t_{i,i+1}^{-\frac{j-i-4}{2}} h_i t_{i+2,i+3}^{\frac{j-i-2}{2}} t_{i,i+1}^{\frac{j-i-4}{2}} h_{j-2} \cdots h_{i+1} h_i)^{\frac{j-i-4}{2}} = (h_{j-2} \cdots h_{i+1} h_i)^{\frac{j-i-4}{2}} \\
& \cdot t_{j-2,j-1}^{-\frac{j-i-4}{2}} t_{j-4,j-3}^{-\frac{j-i-2}{2}} \cdots t_{i+4,i+5}^{-\frac{j-i-2}{2}} t_{i+2,i+3}^{-\frac{j-i-2}{2}} h_{j-4} \cdots h_{i+4} h_{i+2} t_{i+2,i+3}^{\frac{j-i-4}{2}} t_{i+4,i+5}^{\frac{j-i-2}{2}} t_{i+6,i+7}^{\frac{j-i-2}{2}} \cdots t_{j-2,j-1}^{\frac{j-i-2}{2}}
\end{aligned}$$

is obtained from the relations (1) and (2).

Proof. We have

$$\begin{aligned}
& (t_{i+2,i+3} t_{i,i+1}^{-\frac{j-i-4}{2}} h_i t_{i+2,i+3}^{\frac{j-i-2}{2}} t_{i,i+1}^{\frac{j-i-4}{2}} h_{j-2} \cdots h_{i+2} h_{i+1} h_i)^{\frac{j-i-4}{2}} \\
& \quad \quad \quad \leftarrow \\
& \stackrel{(1)(a)}{=} (h_{j-2} \cdots h_{i+5} h_{i+4} t_{i+2,i+3}^{-\frac{j-i-4}{2}} t_{i,i+1}^{-\frac{j-i-2}{2}} h_i t_{i+2,i+3}^{\frac{j-i-2}{2}} h_{i+3} h_{i+2} t_{i,i+1}^{\frac{j-i-4}{2}} h_{i+1} h_i)^{\frac{j-i-4}{2}} \\
& \stackrel{(1)(c)}{=} \quad \quad \quad \cdot h_{i+5} h_{i+4} t_{i+2,i+3}^{-\frac{j-i-4}{2}} t_{i,i+1}^{-\frac{j-i-2}{2}} h_i t_{i+2,i+3}^{\frac{j-i-2}{2}} h_{i+3} h_{i+2} t_{i,i+1}^{\frac{j-i-4}{2}} h_{i+1} h_i)^{\frac{j-i-4}{2}}
\end{aligned}$$

$$\begin{aligned}
& \cdot t_{i+6,i+7}^{-\frac{j-i-4}{2}} t_{i+4,i+5}^{-\frac{j-i-2}{2}} h_{i+4} t_{i+6,i+7}^{\frac{j-i-2}{2}} t_{i+2,i+3}^{-\frac{j-i-2}{2}} h_{i+2} t_{i+4,i+5}^{\frac{j-i-2}{2}} t_{i+2,i+3}^{\frac{j-i-4}{2}} \\
& \vdots \\
= & (h_{j-2} \cdots h_{i+1} h_i)^{\frac{j-i-4}{2}} t_{j-2,j-1}^{-\frac{j-i-4}{2}} t_{j-4,j-3}^{-\frac{j-i-2}{2}} h_{j-4} \overbrace{t_{j-2,j-1}^{\frac{j-i-2}{2}}}^{\rightarrow} \overbrace{t_{j-6,j-5}^{-\frac{j-i-2}{2}}}^{\leftarrow} h_{j-6} \\
& \cdots \overbrace{t_{i+8,i+9}^{\frac{j-i-4}{2}}}^{\rightarrow} \overbrace{t_{i+4,i+5}^{-\frac{j-i-2}{2}}}^{\leftarrow} h_{i+4} \overbrace{t_{i+6,i+7}^{\frac{j-i-2}{2}}}^{\rightarrow} \overbrace{t_{i+2,i+3}^{-\frac{j-i-2}{2}}}^{\leftarrow} h_{i+2} \overbrace{t_{i+4,i+5}^{\frac{j-i-2}{2}}}^{\rightarrow} \overbrace{t_{i+2,i+3}^{\frac{j-i-4}{2}}}^{\leftarrow} \\
\stackrel{(1)(b)}{=} & (h_{j-2} \cdots h_{i+1} h_i)^{\frac{j-i-4}{2}} t_{j-2,j-1}^{-\frac{j-i-4}{2}} t_{j-4,j-3}^{-\frac{j-i-2}{2}} \cdots t_{i+4,i+5}^{-\frac{j-i-2}{2}} t_{i+2,i+3}^{-\frac{j-i-2}{2}} \\
\stackrel{(1)(c)}{=} & \cdot h_{j-4} \cdots h_{i+4} h_{i+2} t_{i+2,i+3}^{\frac{j-i-4}{2}} t_{i+4,i+5}^{\frac{j-i-2}{2}} t_{i+6,i+7}^{\frac{j-i-2}{2}} \cdots t_{j-2,j-1}^{\frac{j-i-2}{2}}.
\end{aligned}$$

Therefore, we have completed the proof of Lemma 5.31. \square

Lemma 5.32. For $1 \leq i < j \leq 2n$ such that $j - i \geq 4$ is even, the relation

$$\begin{aligned}
& h_i^{-1} h_{i+2}^{-1} \cdots h_{j-4}^{-1} h_{j-2} h_{j-4} \cdots h_{i+2} h_i \\
= & h_{j-2} h_{j-4} \cdots h_{i+2} h_i t_{i+1,i+2}^{-1} h_{i+2}^{-1} \cdots h_{j-4}^{-1} h_{j-2}^{-1} t_{j-1,j}
\end{aligned}$$

is obtained from the relations (1) and (2).

Proof. We have

$$\begin{aligned}
& h_i^{-1} \cdots h_{j-6}^{-1} h_{j-4}^{-1} h_{j-2} h_{j-4} h_{j-6} \cdots h_i \\
\stackrel{(2)(e)}{=} & h_i^{-1} \cdots h_{j-8}^{-1} h_{j-6}^{-1} \cdot \overbrace{h_{j-2} h_{j-4} t_{j-3,j-2}^{-1}}^{\leftarrow} \overbrace{h_{j-2}^{-1} t_{j-1,j}}^{\rightarrow} \cdot h_{j-6} h_{j-8} \cdots h_i \\
\stackrel{(2)(a)}{=} & \\
\stackrel{(1)(a)}{=} & h_{j-2} \cdot h_i^{-1} \cdots h_{j-8}^{-1} h_{j-6}^{-1} \cdot h_{j-4} \cdot h_{j-6} h_{j-8} \cdots h_i \cdot t_{j-3,j-2}^{-1} h_{j-2}^{-1} t_{j-1,j} \\
\stackrel{(1)(c)}{=} & \\
\stackrel{(2)(e)}{=} & h_{j-2} \cdot h_i^{-1} \cdots h_{j-10}^{-1} h_{j-8}^{-1} \cdot \overbrace{h_{j-4} h_{j-6} t_{j-5,j-4}^{-1}}^{\leftarrow} \overbrace{h_{j-4}^{-1} t_{j-3,j-2}}^{\rightarrow} \cdot h_{j-8} h_{j-10} \cdots h_i \\
\stackrel{(2)(a)}{=} & \\
& \cdot t_{j-3,j-2}^{-1} h_{j-2}^{-1} t_{j-1,j} \\
\stackrel{(1)(a)}{=} & h_{j-2} h_{j-4} \cdot h_i^{-1} \cdots h_{j-10}^{-1} h_{j-8}^{-1} \cdot h_{j-6} \cdot h_{j-8} h_{j-10} \cdots h_i \cdot t_{j-5,j-4}^{-1} h_{j-4}^{-1} h_{j-2}^{-1} t_{j-1,j} \\
\stackrel{(1)(c)}{=} & \\
& \vdots \\
\stackrel{(1)(a)}{=} & h_{j-2} h_{j-4} \cdots h_{i+2} \cdot h_i \cdot t_{i+1,i+2}^{-1} h_{i+2}^{-1} \cdots h_{j-4}^{-1} h_{j-2}^{-1} t_{j-1,j} \\
\stackrel{(1)(c)}{=} &
\end{aligned}$$

Therefore, we have completed the proof of Lemma 5.32. \square

Lemma 5.33. For $1 \leq i < j \leq 2n$ such that $j - i \geq 4$ is even, the relation

$$\begin{aligned}
& (h_{j-2} h_{j-2} h_{j-3} \cdots h_{i+1} h_i)^{\frac{j-i}{2}} \\
= & (h_{j-2} h_{j-3} \cdots h_{i+1} h_i)^{\frac{j-i}{2}} t_{j-2,j-1}^{-\frac{j-i-4}{2}} t_{j-4,j-3}^{-\frac{j-i-2}{2}} \cdots t_{i+2,i+3}^{-\frac{j-i-2}{2}} t_{i,i+1}^{-\frac{j-i-2}{2}} h_{j-4} \cdots h_{i+2} h_i \\
& \cdot h_{j-2} \cdots h_{i+4} h_{i+2} h_i t_{i+1,i+2}^{-1} h_{i+2}^{-1} h_{i+4}^{-1} \cdots h_{j-2}^{-1} t_{i,i+1}^{\frac{j-i-2}{2}} t_{i+2,i+3}^{\frac{j-i-2}{2}} \cdots t_{j-2,j-1}^{\frac{j-i-2}{2}}
\end{aligned}$$

is obtained from the relations (1) and (2).

Proof. Recall that the relations in Lemmas 5.29, 5.30, 5.31, and 5.32 are obtained from the relations (1) and (2). Then we have

$$\begin{aligned}
& (h_{j-2} h_{j-2} h_{j-3} \cdots h_{i+1} h_i)^{\frac{j-i}{2}} \\
\stackrel{\text{Lem.5.29}}{=} & (h_{j-2} h_{j-3} \cdots h_{i+1} h_i \cdot t_{i,i+1}^{-\frac{j-i-4}{2}} h_i^{-1} h_{i+2}^{-1} \cdots h_{j-4}^{-1} h_{j-2} h_{j-4} \cdots h_{i+2} h_i t_{j-1,j}^{-1} t_{i,i+1}^{\frac{j-i-2}{2}})^{\frac{j-i}{2}}
\end{aligned}$$

$$\begin{aligned}
&= h_{j-2} \cdots h_{i+1} h_i \\
&\quad \cdot \frac{(t_{i,i+1}^{-\frac{j-i-4}{2}} h_i^{-1} h_{i+2}^{-1} \cdots h_{j-4}^{-1} h_{j-2} h_{j-4} \cdots h_{i+2} h_i t_{j-1,j}^{-1} t_{i,i+1}^{\frac{j-i-2}{2}} h_{j-2} \cdots h_{i+1} h_i)^{\frac{j-i-2}{2}}}{\cdot t_{i,i+1}^{-\frac{j-i-4}{2}} h_i^{-1} h_{i+2}^{-1} \cdots h_{j-4}^{-1} h_{j-2} h_{j-4} \cdots h_{i+2} h_i t_{j-1,j}^{-1} t_{i,i+1}^{\frac{j-i-2}{2}}} \\
\stackrel{\text{Lem.5.30}}{=} & h_{j-2} \cdots h_{i+1} h_i (h_{j-2} \cdots h_{i+1} h_i \cdot t_{i+2,i+3}^{-\frac{j-i-4}{2}} t_{i,i+1}^{-\frac{j-i-2}{2}} h_i t_{i+2,i+3}^{\frac{j-i-2}{2}} t_{i,i+1}^{\frac{j-i-4}{2}})^{\frac{j-i-2}{2}} \\
&\quad \cdot t_{i,i+1}^{-\frac{j-i-4}{2}} h_i^{-1} h_{i+2}^{-1} \cdots h_{j-4}^{-1} h_{j-2} h_{j-4} \cdots h_{i+2} h_i t_{j-1,j}^{-1} t_{i,i+1}^{\frac{j-i-2}{2}} \\
&= \frac{(h_{j-2} \cdots h_{i+1} h_i)^2 (t_{i+2,i+3}^{-\frac{j-i-4}{2}} t_{i,i+1}^{-\frac{j-i-2}{2}} h_i t_{i+2,i+3}^{\frac{j-i-2}{2}} t_{i,i+1}^{\frac{j-i-4}{2}} h_{j-2} \cdots h_{i+1} h_i)^{\frac{j-i-4}{2}}}{\cdot t_{i,i+1}^{-\frac{j-i-2}{2}} t_{i+2,i+3}^{-\frac{j-i-4}{2}} h_i t_{i+2,i+3}^{\frac{j-i-2}{2}} h_i^{-1} h_{i+2}^{-1} \cdots h_{j-4}^{-1} h_{j-2} h_{j-4} \cdots h_{i+2} h_i t_{j-1,j}^{-1} t_{i,i+1}^{\frac{j-i-2}{2}}} \\
\stackrel{\text{Lem.5.31}}{=} & (h_{j-2} \cdots h_{i+1} h_i)^{\frac{j-i}{2}} t_{j-2,j-1}^{-\frac{j-i-4}{2}} t_{j-4,j-3}^{-\frac{j-i-2}{2}} \cdots t_{i+4,i+5}^{-\frac{j-i-2}{2}} t_{i+2,i+3}^{-\frac{j-i-2}{2}} h_{j-4} \cdots h_{i+4} h_{i+2} \\
&\quad \cdot t_{i+2,i+3}^{\frac{j-i-4}{2}} t_{i+4,i+5}^{\frac{j-i-2}{2}} t_{i+6,i+7}^{\frac{j-i-2}{2}} \cdots t_{j-2,j-1}^{\frac{j-i-2}{2}} \\
&\quad \cdot \frac{t_{i,i+1}^{-\frac{j-i-2}{2}} t_{i+2,i+3}^{-\frac{j-i-4}{2}} h_i t_{i+2,i+3}^{\frac{j-i-2}{2}} h_i^{-1} h_{i+2}^{-1} \cdots h_{j-4}^{-1} h_{j-2} h_{j-4} \cdots h_{i+2} h_i t_{j-1,j}^{-1} t_{i,i+1}^{\frac{j-i-2}{2}}}{\leftarrow} \\
&\stackrel{(1)(b)}{=} (h_{j-2} \cdots h_{i+1} h_i)^{\frac{j-i}{2}} t_{j-2,j-1}^{-\frac{j-i-4}{2}} t_{j-4,j-3}^{-\frac{j-i-2}{2}} \cdots t_{i+2,i+3}^{-\frac{j-i-2}{2}} t_{i,i+1}^{-\frac{j-i-2}{2}} h_{j-4} \cdots h_{i+2} h_i \\
&\stackrel{(1)(c)}{=} \cdot t_{i+2,i+3}^{\frac{j-i-2}{2}} t_{i+4,i+5}^{\frac{j-i-2}{2}} \cdots t_{j-2,j-1}^{\frac{j-i-2}{2}} h_i^{-1} h_{i+2}^{-1} \cdots h_{j-4}^{-1} h_{j-2} h_{j-4} \cdots h_{i+2} h_i t_{j-1,j}^{-1} t_{i,i+1}^{\frac{j-i-2}{2}} \\
\stackrel{\text{Lem.5.32}}{=} & (h_{j-2} \cdots h_{i+1} h_i)^{\frac{j-i}{2}} t_{j-2,j-1}^{-\frac{j-i-4}{2}} t_{j-4,j-3}^{-\frac{j-i-2}{2}} \cdots t_{i+2,i+3}^{-\frac{j-i-2}{2}} t_{i,i+1}^{-\frac{j-i-2}{2}} h_{j-4} \cdots h_{i+2} h_i \\
&\quad \cdot t_{i+2,i+3}^{\frac{j-i-2}{2}} t_{i+4,i+5}^{\frac{j-i-2}{2}} \cdots t_{j-2,j-1}^{\frac{j-i-2}{2}} h_{j-2} h_{j-4} \cdots h_{i+2} h_i t_{i+1,i+2}^{-1} h_{i+2}^{-1} \cdots h_{j-4}^{-1} h_{j-2}^{-1} t_{i,i+1}^{\frac{j-i-2}{2}} \\
&\stackrel{(1)}{=} (h_{j-2} \cdots h_{i+1} h_i)^{\frac{j-i}{2}} t_{j-2,j-1}^{-\frac{j-i-4}{2}} t_{j-4,j-3}^{-\frac{j-i-2}{2}} \cdots t_{i+2,i+3}^{-\frac{j-i-2}{2}} t_{i,i+1}^{-\frac{j-i-2}{2}} h_{j-4} \cdots h_{i+2} h_i \\
&\stackrel{(2)}{=} \cdot h_{j-2} h_{j-4} \cdots h_{i+2} h_i t_{i+1,i+2}^{-1} h_{i+2}^{-1} \cdots h_{j-4}^{-1} h_{j-2}^{-1} t_{i,i+1}^{\frac{j-i-2}{2}} t_{i+2,i+3}^{\frac{j-i-2}{2}} \cdots t_{j-2,j-1}^{\frac{j-i-2}{2}}
\end{aligned}$$

Therefore, we have completed the proof of Lemma 5.33. \square

The next lemma follows from the relations (1) (a) and (2) (c).

Lemma 5.34. For $1 \leq i < j \leq 2n$ such that $j - i \geq 4$ is even, the relation

$$h_{j-2} \cdots h_{i+2} h_i (h_{j-2} \cdots h_{i+1} h_i)^{\frac{j-i}{2}} = (h_{j-2}^2 h_{j-3} \cdots h_{i+1} h_i)^{\frac{j-i}{2}}$$

is obtained from the relations (1) and (2).

We prove Lemma 5.17 as follows.

Proof of Lemma 5.17. Recall that the relations in Lemmas 5.19, 5.24, 5.34, and 5.33, and Corollary 5.21 are obtained from the relations (1) and (2). Then we have

$$\begin{aligned}
&\frac{t_{j-2,j-1}^{-\frac{j-i-2}{2}} \cdots t_{i+2,i+3}^{-\frac{j-i-2}{2}} t_{i,i+1}^{-\frac{j-i-2}{2}} h_{j-2} \cdots h_{i+2} h_i h_i h_{i+2} \cdots h_{j-2} (h_{j-3} \cdots h_{i+1} h_i)^{\frac{j-i}{2}}}{\rightarrow} \\
\stackrel{\text{Cor.5.21}}{=} & h_{j-2} \cdots h_{i+2} h_i h_i h_{i+2} \cdots h_{j-2} (h_{j-3} \cdots h_{i+1} h_i)^{\frac{j-i}{2}} t_{j-2,j-1}^{-\frac{j-i-2}{2}} \cdots t_{i+2,i+3}^{-\frac{j-i-2}{2}} t_{i,i+1}^{-\frac{j-i-2}{2}} \\
\stackrel{\text{Lem.5.19}}{=} & h_{j-2} \cdots h_{i+2} h_i (h_{j-2} \cdots h_{i+1} h_i)^{\frac{j-i}{2}} t_{j-2,j-1}^{-\frac{j-i-2}{2}} \cdots t_{i+2,i+3}^{-\frac{j-i-2}{2}} t_{i,i+1}^{-\frac{j-i-2}{2}} \\
\stackrel{\text{Lem.5.24}}{=} & \frac{(h_{j-2} h_{j-2} h_{j-3} \cdots h_{i+1} h_i)^{\frac{j-i}{2}} t_{j-2,j-1}^{-\frac{j-i-2}{2}} \cdots t_{i+2,i+3}^{-\frac{j-i-2}{2}} t_{i,i+1}^{-\frac{j-i-2}{2}}}{\stackrel{\text{Lem.5.34}}{=} (h_{j-2} h_{j-2} h_{j-3} \cdots h_{i+1} h_i)^{\frac{j-i}{2}} t_{j-2,j-1}^{-\frac{j-i-2}{2}} \cdots t_{i+2,i+3}^{-\frac{j-i-2}{2}} t_{i,i+1}^{-\frac{j-i-2}{2}}} \\
\stackrel{\text{Lem.5.33}}{=} & (h_{j-2} h_{j-3} \cdots h_{i+1} h_i)^{\frac{j-i}{2}} t_{j-2,j-1}^{-\frac{j-i-4}{2}} t_{j-4,j-3}^{-\frac{j-i-2}{2}} \cdots t_{i+2,i+3}^{-\frac{j-i-2}{2}} t_{i,i+1}^{-\frac{j-i-2}{2}}
\end{aligned}$$

$$\begin{aligned}
& \cdot h_{j-4} \cdots h_{i+2} h_i \cdot \overleftarrow{h_{j-2} \cdots h_{i+4} h_{i+2} h_i t_{i+1, i+2}^{-1} \cdot h_{i+2} h_{i+4}^{-1} \cdots h_{j-2}^{-1}} \\
(1)(a) \quad & \overline{(h_{j-2} h_{j-3} \cdots h_{i+1} h_i)^{\frac{j-i}{2}} t_{j-2, j-1}^{-\frac{j-i-4}{2}} t_{j-4, j-3}^{-\frac{j-i-2}{2}} \cdots t_{i+2, i+3}^{-\frac{j-i-2}{2}} t_{i, i+1}^{-\frac{j-i-2}{2}}} \\
& \cdot h_{j-4} h_{j-2} \cdots h_{i+4} h_{i+6} h_{i+2} h_{i+4} \cdot \overleftarrow{h_i h_{i+2} \cdot h_i t_{i+1, i+2}^{-1}} \\
& \cdot h_{i+2} h_{i+4}^{-1} \cdots h_{j-2}^{-1} \\
(2)(e) \quad & \overline{(h_{j-2} h_{j-3} \cdots h_{i+1} h_i)^{\frac{j-i}{2}} t_{j-2, j-1}^{-\frac{j-i-4}{2}} t_{j-4, j-3}^{-\frac{j-i-2}{2}} \cdots t_{i+2, i+3}^{-\frac{j-i-2}{2}} t_{i, i+1}^{-\frac{j-i-2}{2}}} \\
& \cdot h_{j-4} h_{j-2} \cdots h_{i+4} h_{i+6} h_{i+2} h_{i+4} \cdot \overleftarrow{h_{i+2} h_i h_{i+2} t_{i+2, i+3}^{-1}} \\
& \cdot h_{i+2} h_{i+4}^{-1} \cdots h_{j-2}^{-1} \\
(2)(e) \quad & \overline{(h_{j-2} h_{j-3} \cdots h_{i+1} h_i)^{\frac{j-i}{2}} t_{j-2, j-1}^{-\frac{j-i-4}{2}} t_{j-4, j-3}^{-\frac{j-i-2}{2}} \cdots t_{i+2, i+3}^{-\frac{j-i-2}{2}} t_{i, i+1}^{-\frac{j-i-2}{2}}} \\
& \cdot h_{j-4} h_{j-2} \cdots \overleftarrow{h_{i+4} h_{i+6} \cdot h_{i+4} h_{i+2} h_{i+4} t_{i+4, i+5}^{-1} t_{i+3, i+4}} \cdot h_i h_{i+2} t_{i+2, i+3}^{-1} \\
& \cdot h_{i+2} h_{i+4}^{-1} \cdots h_{j-2}^{-1} \\
(2)(e) \quad & \overline{(h_{j-2} h_{j-3} \cdots h_{i+1} h_i)^{\frac{j-i}{2}} t_{j-2, j-1}^{-\frac{j-i-4}{2}} t_{j-4, j-3}^{-\frac{j-i-2}{2}} \cdots t_{i+2, i+3}^{-\frac{j-i-2}{2}} t_{i, i+1}^{-\frac{j-i-2}{2}}} \\
& \cdot h_{j-4} h_{j-2} \cdots \overleftarrow{h_{i+6} h_{i+8} \cdot h_{i+6} h_{i+4} h_{i+6} t_{i+6, i+7}^{-1} t_{i+5, i+6}} \\
& \cdot h_{i+2} h_{i+4} t_{i+4, i+5}^{-1} t_{i+3, i+4} \cdot h_i h_{i+2} t_{i+2, i+3}^{-1} \\
& \cdot h_{i+2} h_{i+4}^{-1} \cdots h_{j-2}^{-1} \\
(2)(e) \quad & \overline{(h_{j-2} h_{j-3} \cdots h_{i+1} h_i)^{\frac{j-i}{2}} t_{j-2, j-1}^{-\frac{j-i-4}{2}} t_{j-4, j-3}^{-\frac{j-i-2}{2}} \cdots t_{i+2, i+3}^{-\frac{j-i-2}{2}} t_{i, i+1}^{-\frac{j-i-2}{2}}} \\
& \cdot h_{j-4} h_{j-2} \cdots h_{i+8} h_{i+10} \cdot h_{i+8} h_{i+6} h_{i+8} t_{i+8, i+9}^{-1} t_{i+7, i+8} \\
& \cdot h_{i+4} h_{i+6} t_{i+6, i+7}^{-1} t_{i+5, i+6} \cdot h_{i+2} h_{i+4} t_{i+4, i+5}^{-1} t_{i+3, i+4} \cdot h_i h_{i+2} t_{i+2, i+3}^{-1} \\
& \cdot h_{i+2} h_{i+4}^{-1} \cdots h_{j-2}^{-1} \\
& \vdots \\
(2)(e) \quad & \overline{(h_{j-2} h_{j-3} \cdots h_{i+1} h_i)^{\frac{j-i}{2}} t_{j-2, j-1}^{-\frac{j-i-4}{2}} t_{j-4, j-3}^{-\frac{j-i-2}{2}} \cdots t_{i+2, i+3}^{-\frac{j-i-2}{2}} t_{i, i+1}^{-\frac{j-i-2}{2}}} \\
& \cdot h_{j-2} \cdot h_{j-4} h_{j-2} t_{j-2, j-1}^{-1} t_{j-3, j-2} \cdot \overleftarrow{h_{j-6} h_{j-4} t_{j-4, j-3}^{-1} t_{j-5, j-4}} \cdots \\
& \cdot \overleftarrow{h_{i+2} h_{i+4} t_{i+4, i+5}^{-1} t_{i+3, i+4}} \cdot \overleftarrow{h_i h_{i+2} t_{i+2, i+3}^{-1}} \cdot h_{i+2} h_{i+4}^{-1} \cdots h_{j-2}^{-1} \\
(1)(a) \quad & \overline{(h_{j-2} h_{j-3} \cdots h_{i+1} h_i)^{\frac{j-i}{2}}} \\
(1)(c) \quad & \overline{t_{j-2, j-1}^{-\frac{j-i-4}{2}} t_{j-4, j-3}^{-\frac{j-i-2}{2}} \cdots t_{i+2, i+3}^{-\frac{j-i-2}{2}} t_{i, i+1}^{-\frac{j-i-2}{2}} h_{j-2} \cdots h_{i+2} h_i} \\
& \cdot \overleftarrow{h_{j-2} t_{j-2, j-1}^{-1} t_{j-3, j-2}} \cdot \overleftarrow{h_{j-4} t_{j-4, j-3}^{-1} t_{j-5, j-4}} \cdots \overleftarrow{h_{i+4} t_{i+4, i+5}^{-1} t_{i+3, i+4}} \\
& \cdot \overleftarrow{h_{i+2} t_{i+2, i+3}^{-1}} \cdot h_{i+2} h_{i+4}^{-1} \cdots h_{j-2}^{-1} \\
(1)(b) \quad & \overline{(h_{j-2} h_{j-3} \cdots h_{i+1} h_i)^{\frac{j-i}{2}} h_{j-2} \cdots h_{i+2} h_i t_{i+1, i+2}^{-\frac{j-i-2}{2}} t_{i+3, i+4}^{-\frac{j-i-2}{2}} \cdots t_{j-1, j}^{-\frac{j-i-2}{2}}} \\
\text{Lem.5.25} \quad & \overline{(h_{j-2} h_{j-3} \cdots h_{i+1})^{\frac{j-i}{2}} h_i h_{i+2} \cdots h_{j-2} h_{j-2} \cdots h_{i+2} h_i} \\
& \cdot \overleftarrow{t_{i+1, i+2}^{-\frac{j-i-2}{2}} t_{i+3, i+4}^{-\frac{j-i-2}{2}} \cdots t_{j-1, j}^{-\frac{j-i-2}{2}}} \\
\text{Lem.5.28} \quad & \overline{(h_{i+1} h_{i+2} \cdots h_{j-2})^{\frac{j-i}{2}} h_i h_{i+2} \cdots h_{j-2} h_{j-2} \cdots h_{i+2} h_i} \\
& \xrightarrow{\quad} \xrightarrow{\quad}
\end{aligned}$$

$$\begin{aligned}
& \cdot t_{i+1, i+2}^{-\frac{j-i-2}{2}} t_{i+3, i+4}^{-\frac{j-i-2}{2}} \cdots t_{j-1, j}^{-\frac{j-i-2}{2}} \\
= & t_{i+1, i+2}^{-\frac{j-i-2}{2}} t_{i+3, i+4}^{-\frac{j-i-2}{2}} \cdots t_{j-1, j}^{-\frac{j-i-2}{2}} h_i h_{i+2} \cdots h_{j-2} h_{j-2} \cdots h_{i+2} h_i \\
& \cdot (h_{i+1} h_{i+2} \cdots h_{j-2})^{\frac{j-i}{2}}.
\end{aligned}$$

The last commutative relations are analogies of the relations in Corollaries 5.21, 5.23, and Lemma 5.20, and also obtained from the relations (1) and (2). Therefore, we have completed the proof of Lemma 5.17. \square

5.6. Proofs of Lemmas 5.12, 5.13, 5.14, and 5.15. In this section, we prove Lemmas 5.12, 5.13, 5.14, and 5.15. To prove these lemmas, we prepare the following four technical lemmas.

Lemma 5.35. *For $1 \leq i < j \leq 2n+1$ in the case of LMod_{2n+2} and $1 \leq i < j \leq 2n$ in the case of LMod_{2n+1}^1 such that $j-i \geq 3$ is odd, the relation*

$$\begin{aligned}
& h_i h_{i+1} \cdots h_{j-2} h_{j-1} \\
= & t_{i, i+1}^{\frac{j-i+1}{2}} (h_i h_{i+2} \cdots h_{j-1}) t_{i+2, i+3}^{-1} t_{i+4, i+5}^{-1} \cdots t_{j-1, j}^{-1} (h_{i+1} h_{i+3} \cdots h_{j-2}).
\end{aligned}$$

is obtained from the relations (1), (2), and $t_{2n+1, 2n+2} = t_{1, 2n}$.

Proof. We have

$$\begin{aligned}
& h_i h_{i+1} \cdots h_{j-3} h_{j-2} h_{j-1} \\
\stackrel{(2)(d)}{=} & h_i h_{i+1} \cdots h_{j-5} h_{j-4} h_{j-3} \cdot t_{j-2, j-1}^{-1} t_{j, j+1}^{-1} h_{j-1} h_{j-2} \\
\stackrel{(2)(a)}{=} & h_i h_{i+1} \cdots h_{j-5} \cdot t_{j-4, j-3} h_{j-4} h_{j-3} \cdot t_{j, j+1}^{-1} h_{j-1} h_{j-2} \\
\stackrel{(2)(d)}{=} & h_i h_{i+1} \cdots h_{j-5} \cdot t_{j-4, j-3}^2 t_{j-2, j-1}^{-1} h_{j-3} h_{j-4} t_{j, j+1}^{-1} h_{j-1} h_{j-2} \\
& \rightarrow \\
\stackrel{(1)(c)}{=} & h_i h_{i+1} \cdots h_{j-7} h_{j-6} h_{j-5} \cdot t_{j-4, j-3}^2 t_{j-2, j-1}^{-1} t_{j, j+1}^{-1} \cdot h_{j-3} h_{j-1} \cdot h_{j-4} h_{j-2} \\
\stackrel{(1)(a)}{=} & h_i h_{i+1} \cdots h_{j-7} \cdot t_{j-6, j-5}^2 h_{j-6} h_{j-5} \cdot t_{j-2, j-1}^{-1} t_{j, j+1}^{-1} \cdot h_{j-3} h_{j-1} \cdot h_{j-4} h_{j-2} \\
\stackrel{(2)(a)}{=} & h_i h_{i+1} \cdots h_{j-7} \cdot t_{j-6, j-5}^2 h_{j-6} h_{j-5} \cdot t_{j-2, j-1}^{-1} t_{j, j+1}^{-1} \cdot h_{j-3} h_{j-1} \cdot h_{j-4} h_{j-2} \\
\stackrel{(2)(d)}{=} & h_i h_{i+1} \cdots h_{j-7} \cdot t_{j-6, j-5}^3 t_{j-4, j-3}^{-1} h_{j-5} h_{j-6} \cdot t_{j-2, j-1}^{-1} t_{j, j+1}^{-1} \cdot h_{j-3} h_{j-1} \\
& \rightarrow \\
& \cdot h_{j-4} h_{j-2} \\
\stackrel{(1)(c)}{=} & h_i h_{i+1} \cdots h_{j-7} \cdot t_{j-6, j-5}^3 t_{j-4, j-3}^{-1} t_{j-2, j-1}^{-1} t_{j, j+1}^{-1} \cdot h_{j-5} h_{j-3} h_{j-1} \\
\stackrel{(1)(a)}{=} & \cdot h_{j-6} h_{j-4} h_{j-2} \\
& \vdots \\
= & h_i t_{i+1, i+2}^{\frac{j-i+1}{2}} t_{i+3, i+4}^{-1} \cdots t_{j-2, j-1}^{-1} t_{j, j+1}^{-1} \cdot h_{i+2} \cdots h_{j-3} h_{j-1} \cdot h_{i+1} \cdots h_{j-4} h_{j-2} \\
\stackrel{(2)(a)}{=} & t_{i, i+1}^{\frac{j-i+1}{2}} (h_i \cdots h_{j-3} h_{j-1}) t_{i+2, i+3}^{-1} \cdots t_{j-3, j-2}^{-1} t_{j-1, j}^{-1} (h_{i+1} \cdots h_{j-4} h_{j-2}).
\end{aligned}$$

Therefore, we have completed the proof of Lemma 5.35. \square

Lemma 5.36. *For $1 \leq i < j \leq 2n+2$ in the case of LMod_{2n+2} and $1 \leq i < j \leq 2n+1$ in the case of LMod_{2n+1}^1 such that $j-i \geq 3$ is odd, the relation*

$$\begin{aligned}
& (h_{j-1} \cdots h_{i+2} h_i h_{i+2} \cdots h_{j-1}) t_{i+2, i+3}^{-1} t_{i+4, i+5}^{-1} \cdots t_{j-1, j}^{-1} \\
= & (h_i \cdots h_{j-3} h_{j-1} h_{j-3} \cdots h_i) t_{i+1, i+2}^{-1} t_{i+3, i+4}^{-1} \cdots t_{j-2, j-1}^{-1}
\end{aligned}$$

is obtained from the relations (1), (2), and $t_{2n+1, 2n+2} = t_{1, 2n}$.

Proof. When $j - i = 3$, the relation in Lemma 5.36 is equivalent to the relation (2) (e). Assume $j - i \geq 5$. We have

$$\begin{aligned}
& (h_{j-1} \cdots h_{i+4} \underline{h_{i+2} h_i h_{i+2} h_{i+4}} \cdots h_{j-1}) t_{i+2, i+3}^{-1} t_{i+4, i+5}^{-1} \cdots t_{j-1, j}^{-1} \\
\stackrel{(2)(e)}{=} & h_{j-1} \cdots h_{i+6} h_{i+4} \cdot \underbrace{h_i h_{i+2} h_i t_{i+1, i+2}^{-1}}_{\leftarrow} \underbrace{t_{i+2, i+3}^{-1}}_{\rightarrow} \cdot h_{i+4} h_{i+6} \cdots h_{j-1} \\
& \cdot t_{i+2, i+3}^{-1} t_{i+4, i+5}^{-1} \cdots t_{j-1, j}^{-1} \\
\stackrel{(1)(a)}{=} & h_i (h_{j-1} \cdots h_{i+6} \underline{h_{i+4} h_{i+2} h_{i+4}} h_{i+6} \cdots h_{j-1}) h_i t_{i+1, i+2}^{-1} \\
\stackrel{(1)(c)}{=} & \cdot t_{i+4, i+5}^{-1} t_{i+6, i+7}^{-1} \cdots t_{j-1, j}^{-1} \\
\stackrel{(2)(e)}{=} & h_i \cdot h_{j-1} \cdots h_{i+8} h_{i+6} \cdot \underbrace{h_{i+2} h_{i+4} h_{i+2} t_{i+3, i+4}^{-1}}_{\leftarrow} \underbrace{t_{i+4, i+5}^{-1}}_{\rightarrow} \cdot h_{i+6} h_{i+8} \cdots h_{j-1} \\
& \cdot h_i t_{i+1, i+2}^{-1} \cdot t_{i+4, i+5}^{-1} t_{i+6, i+7}^{-1} \cdots t_{j-1, j}^{-1} \\
\stackrel{(1)}{=} & h_i h_{i+2} (h_{j-1} \cdots h_{i+8} h_{i+6} h_{i+4} h_{i+6} h_{i+8} \cdots h_{j-1}) h_{i+2} h_i t_{i+1, i+2}^{-1} t_{i+3, i+4}^{-1} \\
& \cdot t_{i+6, i+7}^{-1} t_{i+8, i+9}^{-1} \cdots t_{j-1, j}^{-1} \\
& \vdots \\
= & (h_i \cdots h_{j-3} h_{j-1} h_{j-3} \cdots h_i) t_{i+1, i+2}^{-1} t_{i+3, i+4}^{-1} \cdots t_{j-2, j-1}^{-1}.
\end{aligned}$$

Therefore, we have completed the proof of Lemma 5.36. \square

Lemma 5.37. For $1 \leq i < j \leq 2n + 2$ in the case of LMod_{2n+2} and $1 \leq i < j \leq 2n + 1$ in the case of LMod_{2n+1}^1 such that $j - i \geq 3$ is odd, the relation

$$h_{j-3}^{-1} \cdots h_{i+2}^{-1} h_i^{-1} (h_{j-2} \cdots h_{i+3} h_{i+1}) h_i h_{i+2} \cdots h_{j-3} = (h_{j-2} \cdots h_{i+3} h_{i+1}) t_{i, i+1}^{-1} t_{j-1, j}^{-1}$$

is obtained from the relations (1), (2), and $t_{2n+1, 2n+2} = t_{1, 2n}$.

Proof. When $j - i = 3$, the relation in Lemma 5.37 is equivalent to the relation (2) (d). Assume $j - i \geq 5$. We have

$$\begin{aligned}
& h_{j-3}^{-1} \cdots h_{i+2}^{-1} h_i^{-1} (h_{j-2} \cdots h_{i+3} \underline{h_{i+1}}) h_i h_{i+2} \cdots h_{j-3} \\
\stackrel{(2)(d)}{=} & h_{j-3}^{-1} \cdots h_{i+2}^{-1} h_i^{-1} \cdot h_{j-2} \cdots h_{i+5} h_{i+3} \cdot \underbrace{h_i h_{i+1} t_{i, i+1}^{-1}}_{\leftarrow} t_{i+2, i+3}^{-1} \cdot h_{i+2} h_{i+4} \cdots h_{j-3} \\
\stackrel{(1)(a)}{=} & h_{j-3}^{-1} \cdots h_{i+4}^{-1} h_{i+2}^{-1} (h_{j-2} \cdots h_{i+5} h_{i+3} \cdot h_{i+1}) \underline{t_{i, i+1}^{-1} t_{i+2, i+3}^{-1}} \cdot h_{i+2} h_{i+4} \cdots h_{j-3} \\
\stackrel{(2)(a)}{=} & h_{j-3}^{-1} \cdots h_{i+4}^{-1} h_{i+2}^{-1} \cdot h_{j-2} \cdots h_{i+5} h_{i+3} \cdot \underline{h_{i+1} h_{i+2} t_{i, i+1}^{-1}} t_{i+3, i+4}^{-1} \\
\stackrel{(1)(c)}{=} & \cdot h_{i+4} h_{i+6} \cdots h_{j-3} \\
\stackrel{(2)(d)}{=} & h_{j-3}^{-1} \cdots h_{i+4}^{-1} h_{i+2}^{-1} \cdot h_{j-2} \cdots h_{i+5} \underline{h_{i+3}} \cdot \underline{h_{i+2} h_{i+1} t_{i+1, i+2}^{-1}} t_{i, i+1}^{-1} \\
\stackrel{(1)(b)}{=} & \cdot h_{i+4} h_{i+6} \cdots h_{j-3} \\
\stackrel{(2)(d)}{=} & h_{j-3}^{-1} \cdots h_{i+4}^{-1} h_{i+2}^{-1} \cdot h_{j-2} \cdots h_{i+7} h_{i+5} \cdot \underline{h_{i+2} h_{i+3} t_{i+2, i+3}^{-1}} t_{i+4, i+5}^{-1} \\
\stackrel{(1)(b)}{=} & \cdot h_{i+1} t_{i+1, i+2}^{-1} t_{i, i+1}^{-1} \cdot h_{i+4} h_{i+6} \cdots h_{j-3} \\
\stackrel{(1)(a)}{=} & h_{j-3}^{-1} \cdots h_{i+6}^{-1} h_{i+4}^{-1} \cdot h_{j-2} \cdots h_{i+7} h_{i+5} \cdot \underline{h_{i+3} t_{i+2, i+3}^{-1} t_{i+4, i+5}^{-1}} h_{i+1} t_{i+1, i+2}^{-1} t_{i, i+1}^{-1} \\
& \cdot h_{i+4} h_{i+6} \cdots h_{j-3} \\
\stackrel{(1)(c)}{=} & h_{j-3}^{-1} \cdots h_{i+6}^{-1} h_{i+4}^{-1} \cdot h_{j-2} \cdots h_{i+7} h_{i+5} \cdot h_{i+3} h_{i+1} \underline{t_{i+1, i+2}^{-1} t_{i+4, i+5}^{-1}} t_{i+1, i+2}^{-1} t_{i, i+1}^{-1} \\
\stackrel{(2)(a)}{=} & \rightarrow
\end{aligned}$$

$$\begin{aligned}
& \cdot h_{i+4}h_{i+6} \cdots h_{j-3} \\
(1)\underline{(b)} \quad & h_{j-3}^{-1} \cdots h_{i+6}^{-1}h_{i+4}^{-1}(h_{j-2} \cdots h_{i+7}h_{i+5} \cdot h_{i+3}h_{i+1})t_{i,i+1}t_{i+4,i+5}^{-1} \\
& \cdot h_{i+4}h_{i+6} \cdots h_{j-3}.
\end{aligned}$$

By an inductive argument, for a positive even $2 \leq l \leq j - i - 11$, the relation

$$\begin{aligned}
& h_{j-3}^{-1} \cdots h_{i+l+6}^{-1}h_{i+l+4}^{-1}(h_{j-2} \cdots h_{i+3}h_{i+1})t_{i,i+1}t_{i+l+4,i+l+5}^{-1} \cdot h_{i+l+4}h_{i+l+6} \cdots h_{j-3} \\
& = h_{j-3}^{-1} \cdots h_{i+l+8}^{-1}h_{i+l+6}^{-1}(h_{j-2} \cdots h_{i+3}h_{i+1})t_{i,i+1}t_{i+l+6,i+l+7}^{-1} \cdot h_{i+l+6}h_{i+l+8} \cdots h_{j-3}
\end{aligned}$$

is obtained from the relations (1), (2), and $t_{2n+1,2n+2} = t_{1,2n}$. Thus, up to the relations (1), (2), and $t_{2n+1,2n+2} = t_{1,2n}$, we have

$$\begin{aligned}
& h_{j-3}^{-1} \cdots h_{i+2}^{-1}h_i^{-1}(h_{j-2} \cdots h_{i+3}h_{i+1})h_i h_{i+2} \cdots h_{j-3} \\
& = h_{j-3}^{-1}(h_{j-2} \cdots h_{i+3}h_{i+1})t_{i,i+1}t_{j-3,j-2}^{-1} \cdot h_{j-3} \\
(2)\underline{(a)} \quad & h_{j-3}^{-1}(h_{j-2} \cdots h_{i+3}h_{i+1})t_{i,i+1} \underbrace{h_{j-3}t_{j-2,j-1}^{-1}}_{\leftarrow} \\
(1)\underline{(c)} \quad & h_{j-3}^{-1} \cdot h_{j-2} \underline{h_{j-4} \cdot h_{j-3}} \cdot h_{j-6} \cdots h_{i+3}h_{i+1}t_{i,i+1}t_{j-2,j-1}^{-1} \\
(1)\underline{(a)} \quad & \\
(2)\underline{(d)} \quad & h_{j-3}^{-1} \cdot h_{j-2} \underline{h_{j-3}h_{j-4}t_{j-4,j-3}^{-1}t_{j-2,j-1}^{-1}} \cdot h_{j-6} \cdots h_{i+3}h_{i+1}t_{i,i+1}t_{j-2,j-1}^{-1} \\
(1)\underline{(c)} \quad & \xrightarrow{\hspace{1cm}} \\
(2)\underline{(d)} \quad & h_{j-2} \underline{t_{j-3,j-2}t_{j-1,j}^{-1}h_{j-4}t_{j-4,j-3}^{-1}} \cdot h_{j-6} \cdots h_{i+3}h_{i+1}t_{i,i+1} \\
(1)\underline{(c)} \quad & \\
(2)\underline{(a)} \quad & h_{j-2} \underline{h_{j-4}t_{j-4,j-3}t_{j-1,j}^{-1}t_{j-4,j-3}^{-1}} \cdot h_{j-6} \cdots h_{i+3}h_{i+1}t_{i,i+1} \\
& \xrightarrow{\hspace{1cm}} \\
(1)\underline{(a)} \quad & (h_{j-2}h_{j-4}h_{j-6} \cdots h_{i+3}h_{i+1})t_{i,i+1}t_{j-1,j}^{-1}. \\
(1)\underline{(c)} \quad &
\end{aligned}$$

Therefore, we have completed the proof of Lemma 5.37. \square

Lemma 5.38. For $1 \leq i < j \leq 2n$ in the case of LMod_{2n+2} and $1 \leq i < j \leq 2n - 1$ in the case of LMod_{2n+1}^1 such that $j - i \geq 3$ is odd, the relation

$$h_j \cdots h_{i+3}h_{i+1} \cdot h_{j-1} \cdots h_{i+2}h_i = t_{j+1,j+2}^{-\frac{j-i-1}{2}}(h_j \cdots h_{i+1}h_i)t_{i+3,i+4}t_{i+5,i+6} \cdots t_{j,j+1}$$

is obtained from the relations (1), (2), and $t_{2n+1,2n+2} = t_{1,2n}$.

Proof. We have

$$\begin{aligned}
& h_j \cdots h_{i+3} \underline{h_{i+1}} \cdot h_{j-1} \cdots h_{i+2}h_i \\
& \xrightarrow{\hspace{1cm}} \\
(1)\underline{(a)} \quad & h_j \cdots h_{i+5}h_{i+3} \cdot h_{j-1} \cdots h_{i+6}h_{i+4} \cdot \underline{h_{i+1}h_{i+2}h_i} \\
(2)\underline{(d)} \quad & h_j \cdots h_{i+5}h_{i+3} \cdot h_{j-1} \cdots h_{i+6}h_{i+4} \cdot t_{i+3,i+4}^{-1} \underline{h_{i+2}h_{i+1}t_{i+3,i+4}h_i} \\
(2)\underline{(a)} \quad & \xrightarrow{\hspace{1cm}} \\
(1)\underline{(c)} \quad & h_j \cdots h_{i+5} \underline{h_{i+3}} \cdot h_{j-1} \cdots h_{i+6}h_{i+4} \cdot t_{i+3,i+4}^{-1} (h_{i+2}h_{i+1}h_i)t_{i+3,i+4} \\
& \xrightarrow{\hspace{1cm}} \\
(1)\underline{(a)} \quad & h_j \cdots h_{i+7}h_{i+5} \cdot h_{j-1} \cdots h_{i+8}h_{i+6} \cdot \underline{h_{i+3}h_{i+4}} \cdot t_{i+3,i+4}^{-1} h_{i+2}h_{i+1}h_i t_{i+3,i+4} \\
(2)\underline{(d)} \quad & h_j \cdots h_{i+7}h_{i+5} \cdot h_{j-1} \cdots h_{i+8}h_{i+6} \cdot t_{i+5,i+6}^{-1} \underline{h_{i+4}h_{i+3}t_{i+5,i+6}} \\
(2)\underline{(a)} \quad & \xrightarrow{\hspace{1cm}} \\
& \cdot t_{i+3,i+4}^{-1} h_{i+2}h_{i+1}h_i t_{i+3,i+4} \\
(1)\underline{(a)} \quad & h_j \cdots h_{i+7}h_{i+5} \cdot h_{j-1} \cdots h_{i+8}h_{i+6} \\
(1)\underline{(c)} \quad &
\end{aligned}$$

$$\begin{aligned}
& \cdot t_{i+5,i+6}^{-1} h_{i+4} h_{i+3} \cdot t_{i+3,i+4}^{-1} h_{i+2} h_{i+1} h_i t_{i+3,i+4} t_{i+5,i+6} \\
(2)\underline{(a)} \quad & h_j \cdots h_{i+7} h_{i+5} \cdot h_{j-1} \cdots h_{i+8} h_{i+6} \\
(1)(c) \quad & \cdot t_{i+5,i+6}^{-2} (h_{i+4} h_{i+3} h_{i+2} h_{i+1} h_i) t_{i+3,i+4} t_{i+5,i+6} \\
& \vdots \\
& = \frac{h_j \cdot t_{j,j+1}^{-\frac{j-i-1}{2}} (h_{j-1} \cdots h_{i+1} h_i) \cdot t_{i+3,i+4} t_{i+5,i+6} \cdots t_{j,j+1}}{t_{j+1,j+2}^{-\frac{j-i-1}{2}} (h_j h_{j-1} \cdots h_{i+1} h_i) t_{i+3,i+4} t_{i+5,i+6} \cdots t_{j,j+1}}. \\
(2)\underline{(a)} \quad & t_{j+1,j+2}^{-\frac{j-i-1}{2}} (h_j h_{j-1} \cdots h_{i+1} h_i) t_{i+3,i+4} t_{i+5,i+6} \cdots t_{j,j+1}.
\end{aligned}$$

Therefore, we have completed the proof of Lemma 5.38. \square

Proof of Lemma 5.12. First, we remark that the relation $(L_{i,j}^{k=j})$ is equivalent to the following relation:

$$\begin{aligned}
& h_j t_{i,j} h_j^{-1} = t_{i,j-1} t_{j,j+1} t_{i,j+2} t_{i,j+1}^{-1} t_{j,j+2}^{-1} \\
\stackrel{\text{CONJ}}{\iff} & t_{i,j+2} = t_{j,j+1}^{-1} t_{i,j-1}^{-1} h_j t_{i,j} h_j^{-1} t_{j,j+2} t_{i,j+1}.
\end{aligned}$$

In the case of $j - i = 1$, by the relation $t_{i,i} = 1$, we have

$$\begin{aligned}
t_{i,i+3} & = t_{i+1,i+2}^{-1} h_{i+1} t_{i,i+1} h_{i+1}^{-1} t_{i+1,i+3} t_{i,i+2} \\
& \stackrel{(T_{i,i+2})}{=} t_{i+1,i+2}^{-1} h_{i+1} t_{i,i+1} h_{i+1} h_i h_i \stackrel{(2)(d)}{=} t_{i+1,i+2}^{-1} h_{i+1} t_{i+2,i+3} h_i h_{i+1} h_i \\
& \stackrel{(2)(a)}{=} h_{i+1} h_i h_{i+1} h_i.
\end{aligned}$$

Thus the relation $(L_{i,i+1}^{k=j})$ is equivalent to the relation $(T_{i,i+3})$ up to the relations (2) (a), (2) (d), $(T_{i,i+2})$, and $(T_{i+1,i+3})$. In the case of $j - i = 2$, the relation $(L_{i,i+2}^{k=j})$ is equivalent to the following relation:

$$\begin{aligned}
t_{i,i+4} & = t_{i+2,i+3}^{-1} t_{i,i+1}^{-1} h_{i+2} t_{i,i+2} h_{i+2}^{-1} t_{i+2,i+4} t_{i,i+3} \\
& \stackrel{(T_{i,i+3})}{=} t_{i+2,i+3}^{-1} t_{i,i+1}^{-1} h_{i+2} t_{i,i+2} h_{i+2}^{-1} t_{i+2,i+4} (h_{i+1} h_i)^2 \\
& \stackrel{(T_{i,i+2})}{=} t_{i+2,i+3}^{-1} t_{i,i+1}^{-1} h_{i+2} h_i^2 h_{i+2}^{-1} h_{i+2}^2 (h_{i+1} h_i)^2 \\
& \stackrel{(T_{i+2,i+4})}{=} t_{i+2,i+3}^{-1} t_{i,i+1}^{-1} h_{i+2} h_i h_i h_{i+2} (h_{i+1} h_i)^2.
\end{aligned}$$

Thus the relation $(L_{i,i+2}^{k=j})$ is equivalent to the relation $(T_{i,i+4})$ up to the relations $(T_{i',j'})$ for $i \leq i' < j' \leq j + 2$ and $2 > j' - i'$.

Assume that $j - i \geq 6$ is even. Then the relation $(L_{i,j}^{k=j})$ is equivalent to the following relation:

$$\begin{aligned}
& t_{i,j+2} \\
& = t_{j,j+1}^{-1} t_{i,j-1}^{-1} h_j t_{i,j} h_j^{-1} t_{j,j+2} t_{i,j+1} \\
& \stackrel{(T_{i,j-1})}{=} t_{j,j+1}^{-1} \cdot (h_{j-3} \cdots h_{i+1} h_i)^{-\frac{j-i}{2}} \frac{t_{i,i+1}^{-\frac{j-i-4}{2}} t_{i+2,i+3}^{-\frac{j-i-4}{2}} \cdots t_{j-2,j-1}^{-\frac{j-i-4}{2}}}{\leftarrow} \cdot h_j t_{i,j} h_j^{-1} t_{j,j+2} \\
& \stackrel{(T_{i,j+1})}{=} \frac{\cdot t_{j,j+1}^{-\frac{j-i-2}{2}} \cdots t_{i+2,i+3}^{-\frac{j-i-2}{2}} t_{i,i+1}^{-\frac{j-i-2}{2}} (h_{j-1} \cdots h_{i+1} h_i)^{\frac{j-i+2}{2}}}{\rightarrow} \\
& \stackrel{\text{Lem.5.19}}{=} t_{j,j+1}^{-1} t_{j-2,j-1}^{-\frac{j-i-4}{2}} \cdots t_{i+2,i+3}^{-\frac{j-i-4}{2}} t_{i,i+1}^{-\frac{j-i-4}{2}} (h_{j-3} \cdots h_{i+1} h_i)^{-\frac{j-i}{2}} \cdot h_j t_{i,j} h_j^{-1} t_{j,j+2} \\
(1)(b) \quad &
\end{aligned}$$

$$\begin{aligned}
& \cdot (h_{j-1} \cdots h_{i+1} h_i)^{\frac{j-i+2}{2}} t_{j,j+1}^{-\frac{j-i-2}{2}} \cdots t_{i+2,i+3}^{-\frac{j-i-2}{2}} t_{i,i+1}^{-\frac{j-i-2}{2}} \\
\stackrel{(T_{i,j})}{=} & t_{j,j+1}^{-1} t_{j-2,j-1}^{\frac{j-i-4}{2}} \cdots t_{i+2,i+3}^{\frac{j-i-4}{2}} t_{i,i+1}^{\frac{j-i-4}{2}} (h_{j-3} \cdots h_{i+1} h_i)^{-\frac{j-i}{2}} \underline{h_j} \\
\stackrel{(T_{j,j+2})}{=} & \cdot \frac{t_{j-2,j-1}^{-\frac{j-i-2}{2}} \cdots t_{i+2,i+3}^{-\frac{j-i-2}{2}} t_{i,i+1}^{-\frac{j-i-2}{2}}}{\leftarrow} h_{j-2} \cdots h_{i+2} h_i h_i h_{i+2} \cdots h_{j-2} \\
& \cdot (h_{j-3} \cdots h_{i+1} h_i)^{\frac{j-i}{2}} h_j (h_{j-1} \cdots h_{i+1} h_i)^{\frac{j-i+2}{2}} t_{j,j+1}^{-\frac{j-i-2}{2}} \cdots t_{i+2,i+3}^{-\frac{j-i-2}{2}} t_{i,i+1}^{-\frac{j-i-2}{2}} \\
\stackrel{(1)(c)}{=} & t_{j,j+1}^{-1} t_{j-2,j-1}^{\frac{j-i-4}{2}} \cdots t_{i+2,i+3}^{\frac{j-i-4}{2}} t_{i,i+1}^{\frac{j-i-4}{2}} h_j \underline{h_{j-2,j-1}^{-\frac{j-i-2}{2}} \cdots t_{i+2,i+3}^{-\frac{j-i-2}{2}} t_{i,i+1}^{-\frac{j-i-2}{2}}} \\
\stackrel{\text{Lem.5.19}}{=} & \cdot (h_{j-3} \cdots h_{i+1} h_i)^{-\frac{j-i}{2}} \underline{h_{j-2} \cdots h_{i+2} h_i h_i h_{i+2} \cdots h_{j-2}} \\
& \cdot (h_{j-3} \cdots h_{i+1} h_i)^{\frac{j-i}{2}} h_j (h_{j-1} \cdots h_{i+1} h_i)^{\frac{j-i+2}{2}} t_{j,j+1}^{-\frac{j-i-2}{2}} \cdots t_{i+2,i+3}^{-\frac{j-i-2}{2}} t_{i,i+1}^{-\frac{j-i-2}{2}} \\
\stackrel{(1)(c)}{=} & t_{j,j+1}^{-1} t_{j-2,j-1}^{-1} \cdots t_{i+2,i+3}^{-1} t_{i,i+1}^{-1} h_j h_{j-2} \cdots h_{i+2} h_i h_i h_{i+2} \cdots h_{j-2} h_j \\
\stackrel{\text{Cor.5.23}}{=} & \cdot (h_{j-1} \cdots h_{i+1} h_i)^{\frac{j-i+2}{2}} t_{j,j+1}^{-\frac{j-i-2}{2}} \cdots t_{i+2,i+3}^{-\frac{j-i-2}{2}} t_{i,i+1}^{-\frac{j-i-2}{2}} \\
& \cdot (h_{j-1} \cdots h_{i+1} h_i)^{-\frac{j-i}{2}} t_{j,j+1}^{-\frac{j-i}{2}} \cdots t_{i+2,i+3}^{-\frac{j-i}{2}} t_{i,i+1}^{-\frac{j-i}{2}} h_j \cdots h_{i+2} h_i h_i h_{i+2} \cdots h_j (h_{j-1} \cdots h_{i+1} h_i)^{\frac{j-i+2}{2}} \\
\stackrel{\text{Lem.5.19}}{=} & \\
\stackrel{\text{Cor.5.21}}{=} &
\end{aligned}$$

Recall that the relations in Lemma 5.19, Corollaries 5.21, and 5.23 for $j \leq 2n+1$ are obtained from the relations (1) and (2). Thus the relation $(L_{i,j}^{k=j})$ for even $j-i \geq 6$ is equivalent to the relation $(T_{i,j+2})$ up to the relations (1), (2), and $(T_{i',j'})$ for $i \leq i' < j' \leq j+2$ and $j-i+2 > j'-i'$.

Assume that $j-i \geq 5$ is odd. Then the relation $(L_{i,j}^{k=j})$ is equivalent to the following relation:

$$\begin{aligned}
& t_{i,j+2} \\
= & t_{j,j+1}^{-1} t_{i,j-1}^{-1} h_j t_{i,j} h_j^{-1} t_{j,j+2} t_{i,j+1} \\
\stackrel{(T_{i,j-1})}{=} & t_{j,j+1}^{-1} \cdot (h_{j-4} \cdots h_{i+1} h_i)^{-\frac{j-i-1}{2}} h_{j-3}^{-1} \cdots h_{i+2}^{-1} h_i^{-1} h_{i+2}^{-1} h_{i+2}^{-1} \cdots h_{j-3}^{-1} \\
\stackrel{(T_{i,j+1})}{=} & \cdot \frac{t_{i,i+1}^{\frac{j-i-3}{2}} t_{i+2,i+3}^{\frac{j-i-3}{2}} \cdots t_{j-3,j-2}^{\frac{j-i-3}{2}} \cdot h_j t_{i,j} h_j^{-1} t_{j,j+2} \cdot t_{j-1,j}^{-\frac{j-i-1}{2}} \cdots t_{i+2,i+3}^{-\frac{j-i-1}{2}} t_{i,i+1}^{-\frac{j-i-1}{2}}}{\leftarrow \hspace{10em} \rightarrow} \\
& \cdot h_{j-1} \cdots h_{i+2} h_i h_i h_{i+2} \cdots h_{j-1} (h_{j-2} \cdots h_{i+1} h_i)^{\frac{j-i+1}{2}} \\
\stackrel{\text{Lem.5.19}}{=} & t_{j,j+1}^{-1} t_{i,i+1}^{\frac{j-i-3}{2}} t_{i+2,i+3}^{\frac{j-i-3}{2}} \cdots t_{j-3,j-2}^{\frac{j-i-3}{2}} \cdot (h_{j-4} \cdots h_{i+1} h_i)^{-\frac{j-i-1}{2}} \\
\stackrel{\text{Cor.5.21}}{=} & \rightarrow \\
& \cdot h_{j-3}^{-1} \cdots h_{i+2}^{-1} h_i^{-1} h_{i+2}^{-1} h_{i+2}^{-1} \cdots h_{j-3}^{-1} \cdot h_j t_{i,j} h_j^{-1} t_{j,j+2} \\
& \cdot h_{j-1} \cdots h_{i+2} h_i h_i h_{i+2} \cdots h_{j-1} (h_{j-2} \cdots h_{i+1} h_i)^{\frac{j-i+1}{2}} \underline{t_{j-1,j}^{-\frac{j-i-1}{2}} \cdots t_{i+2,i+3}^{-\frac{j-i-1}{2}} t_{i,i+1}^{-\frac{j-i-1}{2}}} \\
& \rightarrow \\
\stackrel{(1)}{=} & t_{i,i+1}^{-1} t_{i+2,i+3}^{-1} \cdots t_{j-3,j-2}^{-1} t_{j-1,j}^{-\frac{j-i-1}{2}} \cdot (h_{j-4} \cdots h_{i+1} h_i)^{-\frac{j-i-1}{2}} \\
\stackrel{\text{CONJ}}{=} & \cdot h_{j-3}^{-1} \cdots h_{i+2}^{-1} h_i^{-1} h_{i+2}^{-1} h_{i+2}^{-1} \cdots h_{j-3}^{-1} \cdot t_{j,j+1}^{-1} \cdot h_j t_{i,j} h_j^{-1} t_{j,j+2} \\
& \cdot h_{j-1} \cdots h_{i+2} h_i h_i h_{i+2} \cdots h_{j-1} (h_{j-2} \cdots h_{i+1} h_i)^{\frac{j-i+1}{2}} \\
\stackrel{(T_{i,j})}{=} & t_{i,i+1}^{-1} t_{i+2,i+3}^{-1} \cdots t_{j-3,j-2}^{-1} t_{j-1,j}^{-\frac{j-i-1}{2}} \cdot (h_{j-4} \cdots h_{i+1} h_i)^{-\frac{j-i-1}{2}} \\
\stackrel{\text{Lem.5.24}}{=} & \cdot h_{j-3}^{-1} \cdots h_{i+2}^{-1} h_i^{-1} h_{i+2}^{-1} h_{i+2}^{-1} \cdots h_{j-3}^{-1} \cdot t_{j,j+1}^{-1} \cdot h_j \underline{t_{j-1,j}^{-\frac{j-i-3}{2}} \cdots t_{i+2,i+3}^{-\frac{j-i-3}{2}} t_{i,i+1}^{-\frac{j-i-3}{2}}}
\end{aligned}$$

$$\begin{aligned}
& \cdot (h_{j-2} \cdots h_{i+1} h_i)^{\frac{j-i+1}{2}} h_j^{-1} t_{j,j+2} \cdot h_{j-1} \cdots h_{i+2} h_i (h_{j-1} \cdots h_{i+1} h_i)^{\frac{j-i+1}{2}} \\
\text{(T}_{j,j+2}\text{)} & t_{i,i+1}^{-1} t_{i+2,i+3}^{-1} \cdots t_{j-3,j-2}^{-1} t_{j-1,j}^{-\frac{j-i-1}{2}} \cdot (h_{j-4} \cdots h_{i+1} h_i)^{-\frac{j-i-1}{2}} \\
\text{(2)(a)} & \cdot \frac{h_{j-3}^{-1} \cdots h_{i+2}^{-1} h_i^{-1} h_{i+2}^{-1} h_i^{-1} \cdots h_{j-3}^{-1} \cdot h_j t_{j+1,j+2}^{-\frac{j-i-3}{2}} \cdots t_{i+2,i+3}^{-\frac{j-i-3}{2}} t_{i,i+1}^{-\frac{j-i-3}{2}}}{(h_{j-2} \cdots h_{i+1} h_i)^{\frac{j-i+1}{2}} h_j \cdot h_{j-1} \cdots h_{i+2} h_i (h_{j-1} \cdots h_{i+1} h_i)^{\frac{j-i+1}{2}}} \\
\text{Cor.5.23} & t_{i,i+1}^{-1} t_{i+2,i+3}^{-1} \cdots t_{j-3,j-2}^{-1} t_{j-1,j}^{-\frac{j-i-1}{2}} h_{j-3}^{-1} \cdots h_{i+2}^{-1} h_i^{-1} h_i^{-1} h_{i+2}^{-1} \cdots h_{j-3}^{-1} \\
\text{(2)(d)} & \cdot \frac{(h_{j-4} \cdots h_{i+1} h_i)^{-\frac{j-i-1}{2}} h_j t_{j+1,j+2}^{-1} t_{j-1,j}^{-\frac{j-i-3}{2}} t_{j-3,j-2}^{-\frac{j-i-3}{2}} \cdots t_{i+2,i+3}^{-\frac{j-i-3}{2}} t_{i,i+1}^{-\frac{j-i-3}{2}}}{\leftarrow \leftarrow} \\
& \cdot (h_{j-2} \cdots h_{i+1} h_i)^{\frac{j-i+1}{2}} \frac{t_{j-1,j}^{-1} t_{j+1,j+2} h_{j-1} h_j}{\leftarrow \rightarrow} \cdot h_{j-3} \cdots h_{i+2} h_i (h_{j-1} \cdots h_{i+1} h_i)^{\frac{j-i+1}{2}} \\
\text{(1)} & t_{i,i+1}^{-1} t_{i+2,i+3}^{-1} \cdots t_{j-3,j-2}^{-1} t_{j-1,j}^{-\frac{j-i-1}{2}} h_j \cdot h_{j-3}^{-1} \cdots h_{i+2}^{-1} h_i^{-1} h_i^{-1} h_{i+2}^{-1} \cdots h_{j-3}^{-1} \\
\text{Lem.5.19} & \cdot \frac{t_{j-3,j-2}^{-\frac{j-i-3}{2}} \cdots t_{i+2,i+3}^{-\frac{j-i-3}{2}} t_{i,i+1}^{-\frac{j-i-3}{2}}}{\leftarrow} (h_{j-4} \cdots h_{i+1} h_i)^{-\frac{j-i-1}{2}} t_{j-1,j}^{-\frac{j-i-1}{2}} \\
& \cdot (h_{j-2} \cdots h_{i+1} h_i)^{\frac{j-i+1}{2}} h_{j-1} h_{j-3} \cdots h_{i+2} h_i \cdot h_j (h_{j-1} \cdots h_{i+1} h_i)^{\frac{j-i+1}{2}} \\
\text{Cor.5.21} & \frac{t_{i,i+1}^{-\frac{j-i-1}{2}} t_{i+2,i+3}^{-\frac{j-i-1}{2}} \cdots t_{j-3,j-2}^{-\frac{j-i-1}{2}} t_{j-1,j}^{-\frac{j-i-1}{2}}}{(1)} h_j \cdot h_{j-3}^{-1} \cdots h_{i+2}^{-1} h_i^{-1} h_i^{-1} h_{i+2}^{-1} \cdots h_{j-3}^{-1} \\
& \cdot \frac{(h_{j-4} \cdots h_{i+1} h_i)^{-\frac{j-i-1}{2}} t_{j-1,j}^{-\frac{j-i-1}{2}}}{\leftarrow} (h_{j-2} \cdots h_{i+1} h_i)^{\frac{j-i+1}{2}} \\
& \cdot h_{j-1} h_{j-3} \cdots h_{i+2} h_i \cdot h_j (h_{j-1} \cdots h_{i+1} h_i)^{\frac{j-i+1}{2}} \\
\text{Lem.5.28} & \frac{t_{j-1,j}^{-\frac{j-i-1}{2}} \cdots t_{i+2,i+3}^{-\frac{j-i-1}{2}} t_{i,i+1}^{-\frac{j-i-1}{2}}}{(1)(b)} h_j \cdot h_{j-3}^{-1} \cdots h_{i+2}^{-1} h_i^{-1} h_i^{-1} h_{i+2}^{-1} \cdots h_{j-3}^{-1} \\
& \cdot \frac{(h_i h_{i+1} \cdots h_{j-4})^{-\frac{j-i-1}{2}} t_{j-1,j}^{-\frac{j-i-1}{2}}}{\leftarrow} (h_i h_{i+1} \cdots h_{j-2})^{\frac{j-i-1}{2}} \\
& \cdot h_i h_{i+1} \cdots h_{j-2} \cdot h_{j-1} h_{j-3} \cdots h_{i+2} h_i \cdot h_j (h_{j-1} \cdots h_{i+1} h_i)^{\frac{j-i+1}{2}} \\
\text{Lem.5.24} & \frac{t_{j-1,j}^{-\frac{j-i-1}{2}} \cdots t_{i+2,i+3}^{-\frac{j-i-1}{2}} t_{i,i+1}^{-\frac{j-i-1}{2}}}{(2)(c)} h_j \cdot h_{j-3}^{-1} \cdots h_{i+2}^{-1} h_i^{-1} (h_i h_{i+1} \cdots h_{j-3})^{-\frac{j-i-1}{2}} \\
& \cdot t_{j-1,j}^{-\frac{j-i-1}{2}} (h_i h_{i+1} \cdots h_{j-2})^{\frac{j-i-1}{2}} h_{j-1} \cdots h_{i+4} h_{i+2} \cdot \frac{h_i h_{i+1} \cdots h_{j-2} h_{j-1}}{h_j (h_{j-1} \cdots h_{i+1} h_i)^{\frac{j-i+1}{2}}} \\
\text{Lem.5.35} & \frac{t_{j-1,j}^{-\frac{j-i-1}{2}} \cdots t_{i+2,i+3}^{-\frac{j-i-1}{2}} t_{i,i+1}^{-\frac{j-i-1}{2}}}{\leftarrow} h_j \cdot h_{j-3}^{-1} \cdots h_{i+2}^{-1} h_i^{-1} (h_i h_{i+1} \cdots h_{j-3})^{-\frac{j-i-1}{2}} \\
& \cdot \frac{t_{j-1,j}^{-\frac{j-i-1}{2}}}{\leftarrow} (h_i h_{i+1} \cdots h_{j-2})^{\frac{j-i-1}{2}} h_{j-1} \cdots h_{i+4} h_{i+2} \cdot \frac{t_{i,i+1}^{-\frac{j-i+1}{2}} h_i h_{i+2} \cdots h_{j-1}}{\leftarrow} \\
& \cdot t_{i+2,i+3}^{-1} t_{i+4,i+5}^{-1} \cdots t_{j-1,j}^{-1} h_{i+1} h_{i+3} \cdots h_{j-2} \cdot h_j (h_{j-1} \cdots h_{i+1} h_i)^{\frac{j-i+1}{2}} \\
\text{(1)(c)} & \frac{t_{j-1,j}^{-\frac{j-i-1}{2}} \cdots t_{i+2,i+3}^{-\frac{j-i-1}{2}} t_{i,i+1}^{-\frac{j-i-1}{2}}}{\leftarrow} h_j \cdot h_{j-3}^{-1} \cdots h_{i+2}^{-1} h_i^{-1} (h_i h_{i+1} \cdots h_{j-3})^{-\frac{j-i-1}{2}} \\
\text{Lem.5.24} & \cdot t_{j-1,j}^{-\frac{j-i-1}{2}} (h_i h_{i+1} \cdots h_{j-2})^{\frac{j-i-1}{2}} t_{i,i+1}^{-\frac{j-i+1}{2}} h_{j-1} \cdots h_{i+4} h_{i+2} \cdot h_i h_{i+2} \cdots h_{j-1} \\
& \cdot t_{i+2,i+3}^{-1} t_{i+4,i+5}^{-1} \cdots t_{j-1,j}^{-1} (h_j \cdots h_{i+1} h_i)^{\frac{j-i+1}{2}} \\
\text{(2)(b)} & \frac{t_{j-1,j}^{-\frac{j-i-1}{2}} \cdots t_{i+2,i+3}^{-\frac{j-i-1}{2}} t_{i,i+1}^{-\frac{j-i-1}{2}}}{\leftarrow} h_j \cdot h_{j-3}^{-1} \cdots h_{i+2}^{-1} h_i^{-1} (h_i h_{i+1} \cdots h_{j-3})^{-\frac{j-i-1}{2}} \\
& \cdot \frac{(h_i h_{i+1} \cdots h_{j-2})^{\frac{j-i-1}{2}}}{\leftarrow} h_{j-1} \cdots h_{i+4} h_{i+2} \cdot h_i h_{i+2} \cdots h_{j-1}
\end{aligned}$$

$$\begin{aligned}
& \cdot t_{i+2,i+3}^{-1} t_{i+4,i+5}^{-1} \cdots t_{j-1,j}^{-1} (h_j \cdots h_{i+1} h_i)^{\frac{j-i+1}{2}} \\
\text{Lem.5.24} \quad & \stackrel{=}{=} \frac{t_{j-1,j}^{-\frac{j-i-1}{2}} \cdots t_{i+2,i+3}^{-\frac{j-i-1}{2}} t_{i,i+1}^{-\frac{j-i-1}{2}} h_j \cdot h_{j-3}^{-1} \cdots h_{i+2}^{-1} h_i^{-1} \cdot h_{j-2} \cdots h_{i+3} h_{i+1}}{h_{j-1} \cdots h_{i+4} h_{i+2} \cdot h_i h_{i+2} \cdots h_{j-1} \cdot t_{i+2,i+3}^{-1} t_{i+4,i+5}^{-1} \cdots t_{j-1,j}^{-1}} \\
& \cdot (h_j \cdots h_{i+1} h_i)^{\frac{j-i+1}{2}} \\
\text{Lem.5.36} \quad & \stackrel{=}{=} \frac{t_{j-1,j}^{-\frac{j-i-1}{2}} \cdots t_{i+2,i+3}^{-\frac{j-i-1}{2}} t_{i,i+1}^{-\frac{j-i-1}{2}} h_j \cdot h_{j-3}^{-1} \cdots h_{i+2}^{-1} h_i^{-1} \cdot h_{j-2} \cdots h_{i+3} h_{i+1}}{h_i \cdots h_{j-3} h_{j-1} h_{j-3} \cdots h_i t_{i+1,i+2}^{-1} t_{i+3,i+4}^{-1} \cdots t_{j-2,j-1}^{-1}} \\
& \cdot (h_j \cdots h_{i+1} h_i)^{\frac{j-i+1}{2}} \\
\text{Lem.5.37} \quad & \stackrel{=}{=} \frac{t_{j-1,j}^{-\frac{j-i-1}{2}} \cdots t_{i+2,i+3}^{-\frac{j-i-1}{2}} t_{i,i+1}^{-\frac{j-i-1}{2}} h_j \cdot h_{j-2} \cdots h_{i+3} h_{i+1} t_{i,i+1}^{-1} t_{j-1,j}^{-1}}{h_{j-1} h_{j-3} \cdots h_i t_{i+1,i+2}^{-1} t_{i+3,i+4}^{-1} \cdots t_{j-2,j-1}^{-1} (h_j \cdots h_{i+1} h_i)^{\frac{j-i+1}{2}}} \\
& \stackrel{(1)}{\stackrel{=}{(2)(a)}} \frac{t_{j-1,j}^{-\frac{j-i-1}{2}} \cdots t_{i+2,i+3}^{-\frac{j-i-1}{2}} t_{i,i+1}^{-\frac{j-i-1}{2}} h_j \cdot h_{j-2} \cdots h_{i+3} h_{i+1} \cdot h_{j-1} h_{j-3} \cdots h_i}{\cdot t_{i+3,i+4}^{-1} \cdots t_{j-2,j-1}^{-1} t_{j,j+1}^{-1} (h_j \cdots h_{i+1} h_i)^{\frac{j-i+1}{2}}} \\
\text{Lem.5.38} \quad & \stackrel{=}{=} \frac{t_{j-1,j}^{-\frac{j-i-1}{2}} \cdots t_{i+2,i+3}^{-\frac{j-i-1}{2}} t_{i,i+1}^{-\frac{j-i-1}{2}} \cdot \frac{t_{j+1,j+2}^{-\frac{j-i-1}{2}} h_j \cdots h_{i+1} h_i t_{i+3,i+4} t_{i+5,i+6} \cdots t_{j,j+1}}{\leftarrow}}{t_{i+3,i+4}^{-1} \cdots t_{j-2,j-1}^{-1} t_{j,j+1}^{-1} (h_j \cdots h_{i+1} h_i)^{\frac{j-i+1}{2}}} \\
& \stackrel{(1)(a)}{\stackrel{=}{(2)(a)}} \frac{t_{j+1,j+2}^{-\frac{j-i-1}{2}} \cdots t_{i+2,i+3}^{-\frac{j-i-1}{2}} t_{i,i+1}^{-\frac{j-i-1}{2}} (h_j \cdots h_{i+1} h_i)^{\frac{j-i+3}{2}}}{\leftarrow}.
\end{aligned}$$

Recall that the relations in Lemma 5.24, 5.36, 5.37, and 5.38 for $j \leq 2n+1$ are also obtained from the relations (1) and (2). Therefore the relation $(L_{i,j}^{k=j})$ for even $j-i \geq 6$ is equivalent to the relation $(T_{i,j+2})$ up to the relations (1), (2), and $(T_{i',j'})$ for $i \leq i' < j' \leq j+2$ and $j-i+2 > j'-i'$, and we have completed the proof of Lemma 5.12. \square

By an argument similar to the proof of Lemma 5.12 of the odd $j-i$ case and Lemma 5.5, we have the following lemma:

Proof of Lemma 5.13. First, we remark that the relation $(L_{i,j-1}^{k=j})$ is equivalent to the following relation:

$$\begin{aligned}
& h_{j-1} t_{i,j-1} h_{j-1}^{-1} = \frac{t_{i,j-2} t_{j-1,j} t_{i,j+1} t_{i,j}^{-1} t_{j-1,j+1}^{-1}}{\leftarrow} \\
& \stackrel{\text{CONJ}}{\iff} t_{i,j-2}^{-1} h_{j-1} t_{i,j-1} h_{j-1}^{-1} \frac{t_{j-1,j+1} t_{i,j} t_{i,j+1}^{-1}}{\leftarrow} = t_{j-1,j} \\
& \stackrel{(T_{j-1,j+1})}{\iff} t_{i,j-2}^{-1} h_{j-1} t_{i,j-1} h_{j-1}^{-1} t_{i,j} t_{i,j+1}^{-1} = t_{j-1,j}.
\end{aligned}$$

Then we have

$$\begin{aligned}
& (L_{i,j}^{k=j-1}) \iff h_{j-1} t_{i,j} h_{j-1}^{-1} = \frac{t_{i,j-2} t_{j,j+1} t_{i,j+1} t_{i,j-1}^{-1} t_{j-1,j+1}^{-1}}{\leftarrow} \\
& \stackrel{(1)(b)}{\iff} h_{j-1} t_{i,j} h_{j-1}^{-1} = \frac{t_{i,j-2} t_{i,j+1} t_{i,j-1}^{-1} t_{j,j+1} t_{j-1,j+1}^{-1}}{\leftarrow} \\
& \stackrel{\text{CONJ}}{\iff} \frac{t_{i,j-1}^{-1} t_{i,j+1}^{-1} t_{i,j-2}^{-1} h_{j-1} t_{i,j} h_{j-1}^{-1} t_{j-1,j+1}}{\rightarrow} = t_{j,j+1} \\
& \stackrel{(1)}{\iff} \frac{t_{i,j-2}^{-1} t_{i,j-1} h_{j-1} t_{i,j} t_{i,j+1}^{-1} h_{j-1}}{(T_{j-1,j+1})} = t_{j,j+1} \\
& \iff \frac{h_{j-1}^{-1} h_{j-1} t_{i,j-2}^{-1} t_{i,j-1} h_{j-1} t_{i,j} t_{i,j+1}^{-1} h_{j-1}}{\rightarrow} = t_{j,j+1}
\end{aligned}$$

$$\begin{aligned}
& \stackrel{(1)(c)}{\iff} h_{j-1}^{-1} t_{i,j-2}^{-1} h_{j-1} t_{i,j-1} h_{j-1} t_{i,j} t_{i,j+1}^{-1} h_{j-1} = t_{j,j+1} \\
& \stackrel{(L_{i,j-1}^{k=j})}{\iff} h_{j-1}^{-1} t_{j-1,j} h_{j-1} = t_{j,j+1} \\
& \iff (2) \text{ (a)}.
\end{aligned}$$

Therefore we have completed the proof of Lemma 5.13. \square

By an argument similar to the proof of Lemma 5.13 and Lemma 5.5, we have the following lemma:

Let $D_{i,j}$ for $1 \leq i < j \leq 2n+2$ be the disk in Σ_0 with boundary $\gamma_{i,j}$ which contains the points p_i, p_{i+1}, \dots, p_j and $h_{i,j}$ a self-homeomorphism on (Σ_0, \mathcal{B}) with support $D_{i,j}$ which is described as the result of half-rotation of $l_i \cup l_{i+1} \cup \dots \cup l_{j-1}$ as in Figure 19. We remark that $h_{i,j}$ is liftable for even $j-i$ and $h_{1,2n+2}$ is isotopic to r . Since we have the relations $h_{i,j}^{\pm 1} h_l h_{i,j}^{\mp 1} = h_{j+i-l-2}$ for $i \leq l \leq j-1$ and $h_{i,j}^{\pm 1} t_{k,l} h_{i,j}^{\mp 1} = t_{j+i-l, j+i-k}$ for $i \leq k < l \leq j$, by a similar argument in the proof of Lemma 5.5, the conjugations by $h_{i,j}^{\pm 1}$ of the relations (1) and (2) among generators supported on $D_{i,j}$ are obtained from the relations (1) and (2) among generators supported on $D_{i,j}$. Then we have the following lemma.

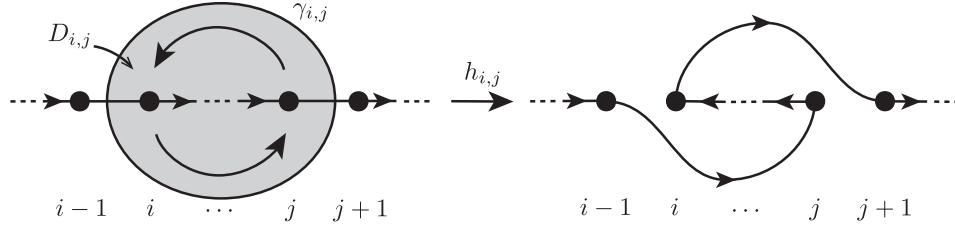

FIGURE 19. The mapping class $h_{i,j}$.

Proof of Lemma 5.14. By the relations $h_{i,j}^{\pm 1} h_l h_{i,j}^{\mp 1} = h_{j+i-l-2}$ for $i \leq l \leq j-1$ and $h_{i,j}^{\pm 1} t_{k,l} h_{i,j}^{\mp 1} = t_{j+i-l, j+i-k}$ for $i \leq k < l \leq j$, the conjugation of the relation $(L_{i,j}^{k=i-2})$ by $h_{i-2,j}$ coincides with the relation $(L_{i-2,j-2}^{k=j})$. By Lemma 5.12, the relation $(L_{i-2,j-2}^{k=j})$ is equivalent to the relation $(T_{i-2,j})$ up to the relations (1), (2), $(T_{i',j'})$ for $i \leq i' < j' \leq j$ and $j-i > j'-i'$, and $t_{i,i} = 1$ for $1 \leq i \leq 2n-1$. By an argument in the proof of Lemma 5.12, these using relations (1), (2), $(T_{i',j'})$, and $t_{i,i} = 1$ are supported on $D_{i-2,j}$. Thus the conjugations of these relations (1) and (2) by $h_{i-2,j}^{-1}$ are obtained from the relations (1) and (2).

By Lemma 5.16 and Lemma 5.17, the conjugation of the relation $(T_{i-2,j})$ by $h_{i-2,j}^{-1}$ is equivalent to the relation $(T_{i-2,j})$ up to the relations (1) and (2), and the conjugation of the relation $(T_{i',j'})$ for $i \leq i' < j' \leq j$ by $h_{i-2,j}^{-1}$ is also equivalent to a relation $(T_{i'',j''})$ for some $i \leq i'' < j'' \leq j$ up to the relations (1) and (2). Thus, the relation $(L_{i,j}^{k=i-2})$ is equivalent to the relation $(T_{i-2,j})$ up to the relations (1) and (2) in Theorem, $(T_{i',j'})$ for $i-2 \leq i' < j' \leq j$ and $j-i > j'-i'$, and $t_{i,i} = 1$ for $1 \leq i \leq 2n-1$. Therefore, we have completed the proof of Lemma 5.14. \square

Proof of Lemma 5.15. By the relations $h_{i,j}^{\pm 1} h_l h_{i,j}^{\mp 1} = h_{j+i-l-2}$ for $i \leq l \leq j-1$ and $h_{i,j}^{\pm 1} t_{k,l} h_{i,j}^{\mp 1} = t_{j+i-l, j+i-k}$ for $i \leq k < l \leq j$, the conjugation of the relation $(L_{i,j}^{k=i-1})$ by $h_{i-1,j}$ coincides with the relation $(L_{i-1,j-1}^{k=j-1})$. By Lemma 5.13 and its proof, the relation $(L_{i-1,j-1}^{k=j-1})$ is obtained from the relations (1) and (2) among generators supported on $D_{i-1,j}$, and the relations $(T_{j-2,j})$ and $(L_{i-1,j-2}^{k=j})$. The conjugations by

$h_{i-1,j}^{-1}$ of these relations (1) and (2) are obtained from the relations (1) and (2), and the conjugations by $h_{i-1,j}^{-1}$ of the relations $(T_{j-2,j})$ and $(L_{i-1,j-2}^{k=j})$ coincide with the relations $(T_{i-1,i+1})$ and $(L_{i+1,j}^{k=i-2})$, respectively. Therefore, the relation $(L_{i,j}^{k=i-1})$ is obtained from the relations (1), (2), $(T_{i-1,i+1})$, and $(L_{i+1,j}^{k=i-2})$ and we have completed the proof of Lemma 5.15. \square

6. PRESENTATIONS FOR THE BALANCED SUPERELLIPTIC MAPPING CLASS GROUPS

Throughout this section, we assume that $g = n(k-1)$ for $n \geq 1$ and $k \geq 3$.

6.1. Explicit lifts of generators for the liftable mapping class groups. In this section, we give explicit lifts of generators for the liftable mapping class groups in Theorems 5.1, 5.2, and 5.3 with respect to the balanced superelliptic covering map $p = p_{g,k}: \Sigma_g \rightarrow \Sigma_0$. First, we consider lifts of the half-twists a_i and b_i for $1 \leq i \leq n$ which are reviewed in Section 2.2.

Let a be a simple arc on Σ_0 whose boundary lies in either $\mathcal{B}_o = \{p_1, p_3, \dots, p_{2n+1}\}$ or $\mathcal{B}_e = \{p_2, p_4, \dots, p_{2n+2}\}$ and interior does not intersect with \mathcal{B} . We denote $\partial a = \{p_i, p_j\}$ for $i < j$ (i.e. $j-i$ is even), $\bar{l}_m = l_m$ for $m = i, j$ if i and j are odd, and $\bar{l}_m = l_{m-1}$ for $m = i, j$ if i and j are even (see Figure 20). Let \mathcal{N} be a regular neighborhood of a in $(\Sigma_0 - \mathcal{B}) \cup \{p_i, p_j\}$ whose intersection with \bar{l}_m for each $m = i, j$ is an arc which connects $\partial \mathcal{N}$ and p_m as in Figure 20. When the point p_{2n+2} does not lie in ∂a , suppose that \mathcal{N} is disjoint from the disk D .

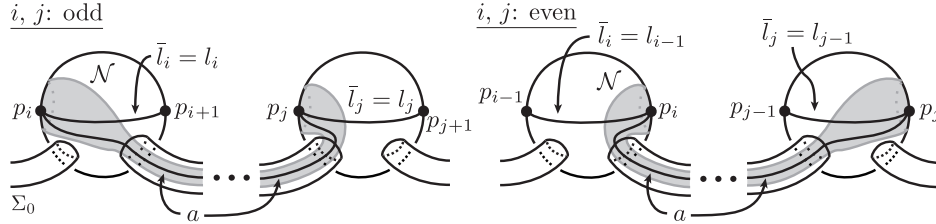

FIGURE 20. A regular neighborhood \mathcal{N} of a simple arc a on Σ_0 with endpoints p_i and p_j for even $j-i$, $\bar{l}_m = l_m$ for $m = i, j$ if i and j are odd, and $\bar{l}_m = l_{m-1}$ for $m = i, j$ if i and j are even.

The neighborhood \mathcal{N} is constructed by connecting small disk neighborhoods of p_i and p_j by a thin band in Σ_0 whose core is a subset of a as on the lower side in Figure 21. Let c be an oriented simple proper arc in \mathcal{N} which transversely intersects with a at one point as on the lower left-hand side in Figure 21. Remark that the image $\sigma[a](c)$ is a simple arc as on the lower right-hand side in Figure 21 and the isotopy class of $\sigma[a]$ relative to $\partial \mathcal{N}$ is determined by the isotopy class of $\sigma[a](c)$ relative to $\partial \mathcal{N}$.

The total space Σ_g of the balanced superelliptic covering map $p: \Sigma_g \rightarrow \Sigma_0$ is constructed by cutting Σ_0 along $l_1 \cup l_3 \cup \dots \cup l_{2n+1}$ and pasting its k copies along the cut off $2k$ copies of $l_1 \cup l_3 \cup \dots \cup l_{2n+1}$. Remark that when i and j are odd (resp. even), the balanced superelliptic rotation $\zeta = \zeta_{g,k}$ acts on the small disk neighborhoods of \tilde{p}_i and \tilde{p}_j by the counter-clockwise (resp. clockwise) $\frac{2\pi}{k}$ -rotation. Since $\partial l_{2s-1} = \{p_{2s-1}, p_{2s}\}$ for $1 \leq s \leq n+1$, for $m = i, j$, $\bar{l}_m = l_m$ lies in $l_1 \cup l_3 \cup \dots \cup l_{2n+1}$ if i and j are odd, and $\bar{l}_m = l_{m-1}$ lies in $l_1 \cup l_3 \cup \dots \cup l_{2n+1}$ if i and j are even (see Figure 20). Thus the preimage $\tilde{\mathcal{N}} = p^{-1}(\mathcal{N}) \subset \Sigma_g$ is topologically constructed by cutting \mathcal{N} along $\bar{l}_i \cap \mathcal{N}$ and $\bar{l}_j \cap \mathcal{N}$ and pasting these k copies along

the cut off $2k$ copies of $\bar{l}_i \cap \mathcal{N}$ and $\bar{l}_j \cap \mathcal{N}$ as on the upper and middle left-hand side in Figure 21.

Let \tilde{a}^l for $1 \leq l \leq k$ be a lift of a with respect to p such that $\zeta^l(\tilde{a}^1) = \tilde{a}^{l+1}$ for $1 \leq l \leq k-1$. Then we denote by γ^1 a simple closed curve on $\tilde{\mathcal{N}}$ which is isotopic to $\tilde{a}^1 \cup \tilde{a}^2$ and $\gamma^l = \zeta^{l-1}(\gamma^1)$ for $2 \leq l \leq k$ (see the upper and middle left-hand side in Figure 21). Remark that γ^l for $2 \leq l \leq k-1$ (resp. γ^k) is also isotopic to $\tilde{a}^l \cup \tilde{a}^{l+1}$ (resp. $\tilde{a}^k \cup \tilde{a}^1$). Under the situation above, we have the following lemma that is a specialized version of Proposition 5.3 in [7].

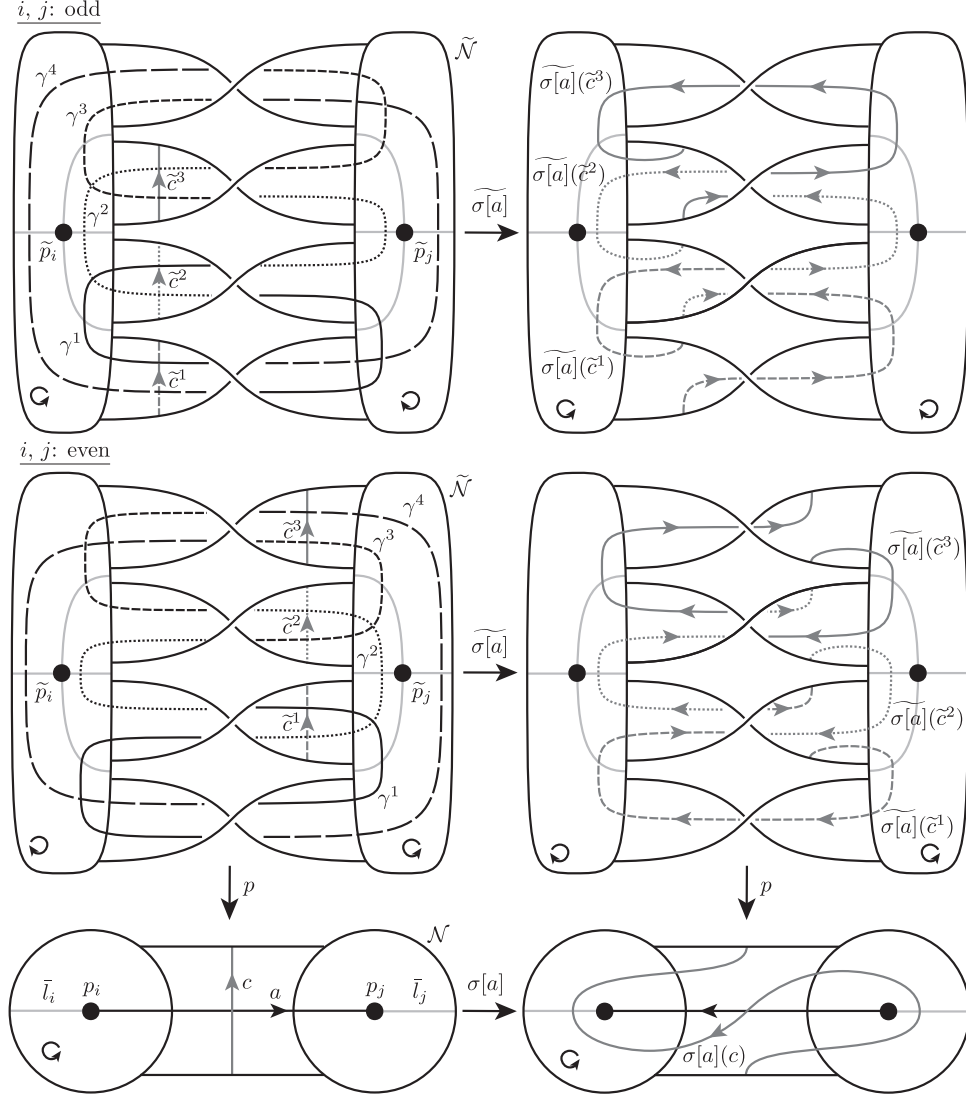

FIGURE 21. A construction of the preimage $\tilde{\mathcal{N}}$ of \mathcal{N} with respect to $p_{g,k}$ when $k = 4$ and the images of \tilde{c}^i by $\tilde{\sigma}[a]$ for $i = 1, 2, 3$.

Lemma 6.1. *The relations*

$$\tilde{\sigma}[a] = \begin{cases} t_{\gamma^1} t_{\gamma^2} \cdots t_{\gamma^{k-1}} & \text{for } i \text{ and } j \text{ are odd,} \\ t_{\gamma^{k-1}} t_{\gamma^{k-2}} \cdots t_{\gamma^1} & \text{for } i \text{ and } j \text{ are even} \end{cases}$$

hold relative to $\partial\tilde{\mathcal{N}}$ for some lift $\tilde{\sigma}[a]$ of $\sigma[a]$ with respect to p .

Proof. Let \tilde{c}^l for $1 \leq l \leq k$ be the lift of c with respect to p such that \tilde{c}^l transversely intersects with \tilde{a}^l (resp. \tilde{a}^{l+1}) at one point when i and j are odd (resp. even). Remark that $\zeta^l(\tilde{c}^1) = \tilde{c}^{l+1}$ for $1 \leq l \leq k-1$. Since the surface which is obtained from $\tilde{\mathcal{N}}$ by cutting along $\tilde{c}^1 \sqcup \tilde{c}^2 \sqcup \cdots \sqcup \tilde{c}^{k-1}$ is a disk, the isotopy class of $\sigma[a]$ relative to $\partial\tilde{\mathcal{N}}$ is determined by the isotopy class of the image $\sigma[a](\tilde{c}^1 \sqcup \tilde{c}^2 \sqcup \cdots \sqcup \tilde{c}^{k-1})$ relative to $\partial\tilde{\mathcal{N}}$.

The image $\sigma[a](\tilde{c}^1 \sqcup \tilde{c}^2 \sqcup \cdots \sqcup \tilde{c}^{k-1})$ in $\sigma[a](\tilde{\mathcal{N}}) = \tilde{\mathcal{N}}$ for some lift $\sigma[a]$ is obtained by cutting and pasting of k copies of $\sigma[a](\mathcal{N})$ as in the lower right-hand side in Figure 21 as the same way to construct $\tilde{\mathcal{N}}$ from \mathcal{N} (see the upper and middle right-hand side in Figure 21). By the construction, when i and j are odd (resp. even), \tilde{c}^l for $1 \leq l \leq k-1$ is disjoint from γ^s for $l+1 \leq s \leq k-1$ (resp. $1 \leq s \leq l-1$) and transversely intersects with γ^l at one point, and $\sigma[a](\tilde{c}^l)$ is disjoint from γ^s for $1 \leq s \leq l-1$ (resp. $l+1 \leq s \leq k-1$). Since we can check that $t_{\gamma^l}(\tilde{c}^l) = \sigma[a](\tilde{c}^l)$ for $1 \leq l \leq k-1$, when i and j are odd, we have

$$\begin{aligned}
& t_{\gamma^1} \cdots t_{\gamma^{k-2}} t_{\gamma^{k-1}} (\tilde{c}^1 \sqcup \cdots \sqcup \tilde{c}^{k-2} \sqcup \tilde{c}^{k-1}) \\
&= t_{\gamma^1} \cdots t_{\gamma^{k-3}} t_{\gamma^{k-2}} (t_{\gamma^{k-1}}(\tilde{c}^1) \sqcup \cdots \sqcup t_{\gamma^{k-1}}(\tilde{c}^{k-2}) \sqcup t_{\gamma^{k-1}}(\tilde{c}^{k-1})) \\
&= t_{\gamma^1} \cdots t_{\gamma^{k-3}} t_{\gamma^{k-2}} (\tilde{c}^1 \sqcup \cdots \sqcup \tilde{c}^{k-2} \sqcup \sigma[a](\tilde{c}^{k-1})) \\
&= t_{\gamma^1} \cdots t_{\gamma^{k-3}} (t_{\gamma^{k-2}}(\tilde{c}^1) \sqcup \cdots \sqcup t_{\gamma^{k-2}}(\tilde{c}^{k-3}) \sqcup t_{\gamma^{k-2}}(\tilde{c}^{k-2}) \sqcup t_{\gamma^{k-2}}(\sigma[a](\tilde{c}^{k-1}))) \\
&= t_{\gamma^1} \cdots t_{\gamma^{k-3}} (\tilde{c}^1 \sqcup \cdots \sqcup \tilde{c}^{k-3} \sqcup \sigma[a](\tilde{c}^{k-2}) \sqcup \sigma[a](\tilde{c}^{k-1})) \\
&\vdots \\
&= \sigma[a](\tilde{c}^1) \sqcup \cdots \sqcup \sigma[a](\tilde{c}^{k-2}) \sqcup \sigma[a](\tilde{c}^{k-1}) \\
&= \sigma[a](\tilde{c}^1 \sqcup \cdots \sqcup \tilde{c}^{k-2} \sqcup \tilde{c}^{k-1}).
\end{aligned}$$

Similarly, we also have $t_{\gamma^{k-1}} t_{\gamma^{k-2}} \cdots t_{\gamma^1} (\tilde{c}^1 \sqcup \cdots \sqcup \tilde{c}^{k-2} \sqcup \tilde{c}^{k-1}) = \sigma[a](\tilde{c}^1 \sqcup \cdots \sqcup \tilde{c}^{k-2} \sqcup \tilde{c}^{k-1})$ when i and j are even. Therefore, we have $t_{\gamma^1} t_{\gamma^2} \cdots t_{\gamma^{k-1}} = \sigma[a]$ when i and j are odd and $t_{\gamma^{k-1}} t_{\gamma^{k-2}} \cdots t_{\gamma^1} = \sigma[a]$ when i and j are even, and we have completed the proof of Lemma 6.1. \square

Under the situation above and for odd i and j , by conjugation relations, we have

$$\begin{aligned}
\zeta t_{\gamma^1} t_{\gamma^2} \cdots t_{\gamma^{k-1}} \zeta^{-1} &= t_{\gamma^2} t_{\gamma^3} \cdots t_{\gamma^k} \\
&= (t_{\gamma^2} t_{\gamma^3} \cdots t_{\gamma^{k-1}}) t_{\gamma^k} (t_{\gamma^2} t_{\gamma^3} \cdots t_{\gamma^{k-1}})^{-1} \cdot t_{\gamma^2} t_{\gamma^3} \cdots t_{\gamma^{k-1}} \\
&= t_{\gamma^1} t_{\gamma^2} \cdots t_{\gamma^{k-1}}
\end{aligned}$$

relative to $\partial\tilde{\mathcal{N}}$. Similarly, for even i and j , we also have

$$\zeta t_{\gamma^{k-1}} t_{\gamma^{k-2}} \cdots t_{\gamma^1} \zeta^{-1} = t_{\gamma^k} t_{\gamma^{k-1}} \cdots t_{\gamma^2} = t_{\gamma^{k-1}} t_{\gamma^{k-2}} \cdots t_{\gamma^1}$$

relative to $\partial\tilde{\mathcal{N}}$. Hence $\sigma[a]$ commutes with ζ relative to $\partial\tilde{\mathcal{N}}$.

When $i < j \leq 2n-1$, by an assumption, since $\tilde{\mathcal{N}}$ does not intersect with the disk \tilde{D} (i.e. $\tilde{\mathcal{N}}$ does not include the point \tilde{p}_{2n+2}), the relation in Lemma 6.1 is also holds relative to $\partial\tilde{\mathcal{N}} \cup \tilde{D}$, namely, $\sigma[a]$ lifts to an element of $\text{SMod}_{g,*,k}$ and $\text{SMod}_{g;k}^1$ and the relation in Lemma 6.1 is also holds in $\text{SMod}_{g,*,k}$ and $\text{SMod}_{g;k}^1$. However, when $j = 2n+2$, the relation $t_{\gamma^k} t_{\gamma^{k-1}} \cdots t_{\gamma^2} = t_{\gamma^{k-1}} t_{\gamma^{k-2}} \cdots t_{\gamma^1}$ does not hold in $\text{SMod}_{g,*,k}$ and $\text{SMod}_{g;k}^1$ and $t_{\gamma^1} t_{\gamma^2} \cdots t_{\gamma^{k-1}}$ does not commute with ζ . Recall that ζ' is a self-homeomorphism on Σ_g which is described as a result of a $(-\frac{2\pi}{k})$ -rotation of $\Sigma_g^1 \subset \Sigma_g$ fixing the disk \tilde{D} pointwise (see Figure 17). As a corollary of Lemma 6.1, we have the following corollary.

Corollary 6.2. *Let a be a simple arc on Σ_0 such that $\partial a = \{p_i, p_j\} \subset \mathcal{B}$ with $j - i > 0$ is even and the interior of the arc a does not intersect with \mathcal{B} . Then, for $j \leq 2n + 1$, a lift $\widetilde{\sigma}[a]$ of $\sigma[a]$ with respect to p commutes with ζ (resp. ζ') in $\text{SMod}_{g,*,k}$ (resp. $\text{SMod}_{g,k}^1$), and for $j = 2n + 2$, $\widetilde{\sigma}[a]$ commutes with ζ in $\text{SMod}_{g,k}$.*

Let \widetilde{l}_i^l for $1 \leq i \leq 2n + 1$ and $1 \leq l \leq k$ be a lift of l_i with respect to p such that $\zeta(\widetilde{l}_i^l) = \widetilde{l}_i^{l+1}$ for $1 \leq l \leq k - 1$ and $\zeta(\widetilde{l}_i^k) = \widetilde{l}_i^1$. We consider a homeomorphism of Σ_g as in Figure 22 and identify Σ_g with the surface as on the lower side in Figure 22. Let α_i^l and β_i^l for $1 \leq i \leq n$ and $1 \leq l \leq k - 1$ be simple closed curves on Σ_g as in Figures 23 and 24. Remark that α_i^l (resp. β_i^l) intersects with $\alpha_i^{l\pm 1}$, $\alpha_{i\pm 1}^l$, and $\alpha_{i\pm 1}^{l\mp 1}$ (resp. $\beta_i^{l\pm 1}$, $\beta_{i\pm 1}^l$, and $\beta_{i\pm 1}^{l\pm 1}$) at one point. By applying an argument before Lemma 6.1 to the arc $a = \alpha_i$ or $a = \beta_i$ on Σ_0 and Lemma 6.1 (see also Figures 23 and 24), we have the following lemma.

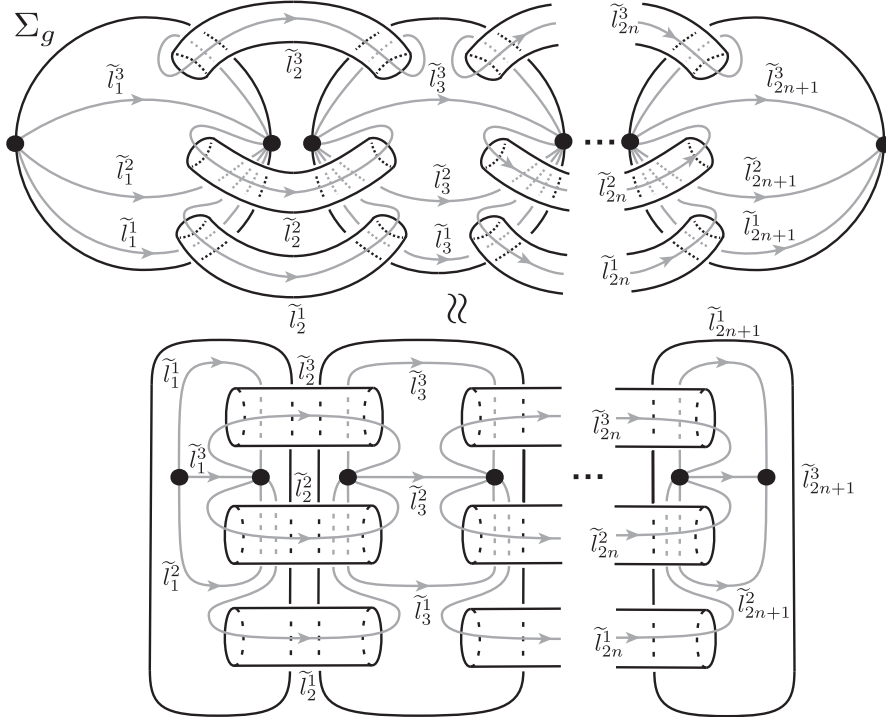

FIGURE 22. A natural homeomorphism of Σ_g when $k = 3$.

Lemma 6.3. *The relations*

$$(1) \widetilde{a}_i = t_{\alpha_i^1} t_{\alpha_i^2} \cdots t_{\alpha_i^{k-1}} \quad \text{for } 1 \leq i \leq n,$$

$$(2) \widetilde{b}_i = t_{\beta_i^{k-1}} t_{\beta_i^{k-2}} \cdots t_{\beta_i^1} \quad \text{for } 1 \leq i \leq n - 1$$

hold relative to $\partial \widetilde{\mathcal{N}} \cup \widetilde{\mathcal{D}}$ for some lifts \widetilde{a}_i and \widetilde{b}_i of a_i and b_i with respect to p , respectively, and the relation

$$\widetilde{b}_n = t_{\beta_n^{k-1}} t_{\beta_n^{k-2}} \cdots t_{\beta_n^1}$$

holds relative to $\partial \widetilde{\mathcal{N}}$ for some lift \widetilde{b}_n of b_n with respect to p .

By Lemma 6.3, we regard the relations $\widetilde{a}_i = t_{\alpha_i^1} t_{\alpha_i^2} \cdots t_{\alpha_i^{k-1}}$ for $1 \leq i \leq n$ and $\widetilde{b}_i = t_{\beta_i^{k-1}} t_{\beta_i^{k-2}} \cdots t_{\beta_i^1}$ for $1 \leq i \leq n - 1$ as relations in $\text{SMod}_{g,*,k}$ and $\text{SMod}_{g,k}^1$, and also regard the relation $\widetilde{b}_n = t_{\beta_n^{k-1}} t_{\beta_n^{k-2}} \cdots t_{\beta_n^1}$ as a relation in $\text{SMod}_{g,k}$.

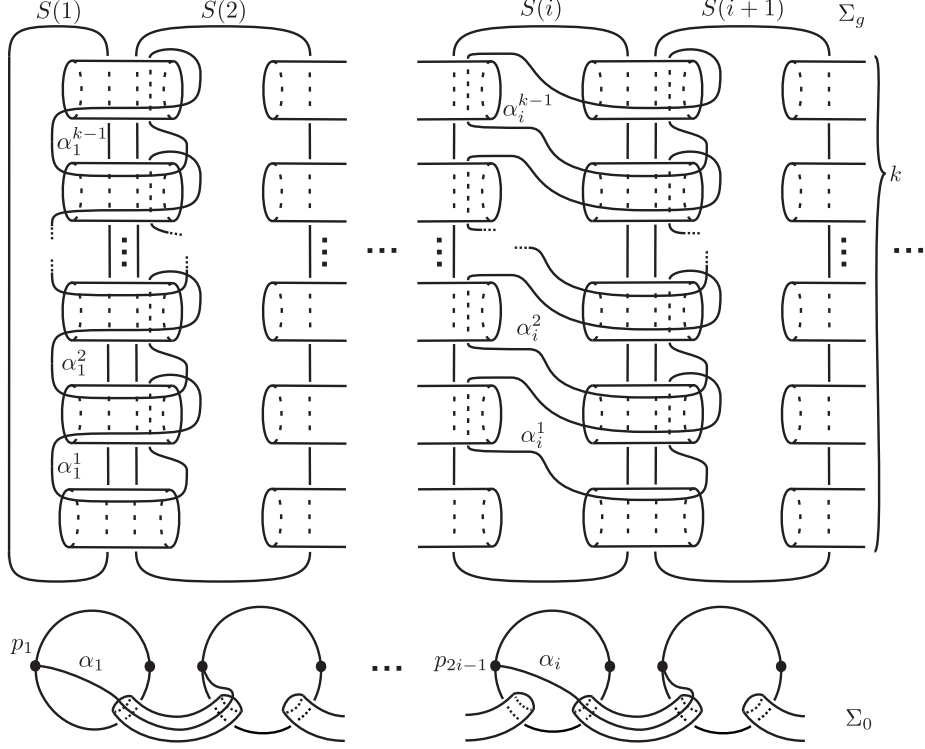

FIGURE 23. Simple closed curves α_i^l on Σ_g for $1 \leq i \leq n$ and $1 \leq l \leq k-1$.

A simple closed curve γ on $\Sigma_0 - \mathcal{B}$ lifts with respect to p if there exists a simple closed curve $\tilde{\gamma}$ on $\Sigma_g - p^{-1}(\mathcal{B})$ such that the restriction $p|_{\tilde{\gamma}}: \tilde{\gamma} \rightarrow \gamma$ is bijective. By Lemma 3.3 in [9], a simple closed curve γ on $\Sigma_0 - \mathcal{B}$ lifts with respect to $p = p_{g,k}$ if and only if the algebraic intersection number of γ and $l_1 \cup l_3 \cup \dots \cup l_{2n+1}$ is zero mod k . Hence the simple closed curve $\gamma_{i,j}$ on Σ_0 (see Figure 2) for odd $j-i$ lifts with respect to p . For instance, $\gamma_{i,i+1}$ for $2 \leq i \leq 2n$ transversely intersects with l_{i-1} and l_{i+1} at one point, respectively, is disjoint from other l_j ($j \neq i-1, i+1$), and the algebraic intersection number of $\gamma_{i,i+1}$ and $l_{i-1} \cup l_{i+1}$ is zero. Thus, a lift of $\gamma_{i,i+1}$ with respect to p is the simple closed curve γ_i^l on Σ_g for $1 \leq l \leq k$ as in Figure 25. Similarly, since the simple closed curves $\gamma_{1,2}$ and $\gamma_{2n+1,2n+2}$ intersect with l_2 and l_{2n} , respectively, lifts of $\gamma_{1,2}$ and $\gamma_{2n+1,2n+2}$ with respect to p are the simple closed curves γ_1^l and γ_{2n+1}^l on Σ_g for $1 \leq l \leq k$ as in Figure 25. Remark that γ_i^l for odd (resp. even) i intersects with $\gamma_{i\pm 1}^{l+\varepsilon}$ for $\varepsilon = -1, 0$ (resp. $\varepsilon = 0, 1$) at one point. We can take a lift of the Dehn twist along a liftable simple closed curve on Σ_0 by the product of the Dehn twists along all lifts of the simple closed curve. Thus, we have the following lemma.

Lemma 6.4. For $1 \leq i \leq 2n+1$, the relation

$$\tilde{t}_{i,i+1} = t_{\gamma_i^1} t_{\gamma_i^2} \cdots t_{\gamma_i^k}$$

holds relative to \tilde{D} for some lift $\tilde{t}_{i,i+1}$ of $t_{i,i+1}$ with respect to p .

By Lemma 6.4, we regard the relation $\tilde{t}_{i,i+1} = t_{\gamma_i^1} t_{\gamma_i^2} \cdots t_{\gamma_i^k}$ for $1 \leq i \leq 2n+1$ as a relation in $\text{SMod}_{g,*;k} \subset \text{SMod}_{g;k}$ and $\text{SMod}_{g;k}^1$. Since the homeomorphisms ζ and ζ' preserve the set $\gamma_i^1 \cup \gamma_i^2 \cup \dots \cup \gamma_i^k$, we have the following corollary.

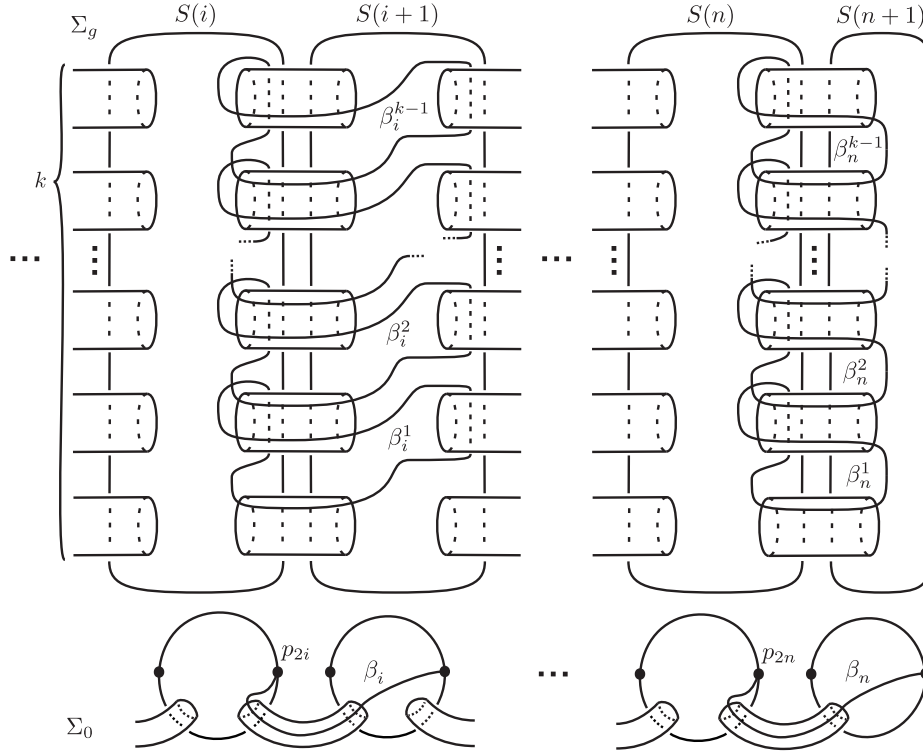

FIGURE 24. Simple closed curves β_i^l on Σ_g for $1 \leq i \leq n$ and $1 \leq l \leq k-1$.

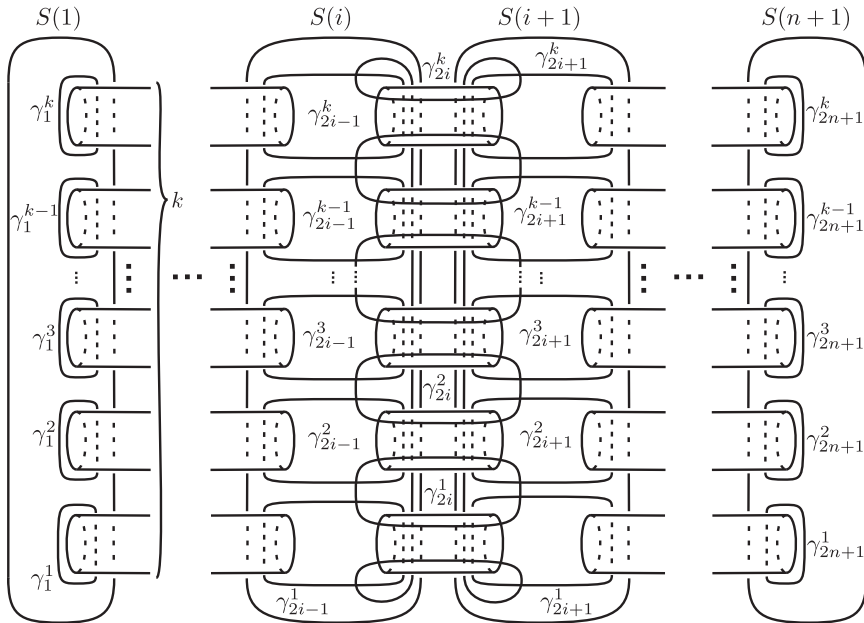

FIGURE 25. Simple closed curves γ_i^l on Σ_g for $1 \leq i \leq 2n+1$ and $1 \leq l \leq k$.

Corollary 6.5. For $1 \leq i \leq 2n+1$, $\tilde{t}_{i,i+1}$ commutes with ζ (resp. ζ') in $\text{SMod}_{g,*,k}$ (resp. $\text{SMod}_{g;k}^1$).

By using Lemma 6.3 and 6.4, we have the following lemma.

Lemma 6.6. *The relations*

$$(1) \tilde{h}_i = t_{\gamma_i^1} t_{\gamma_{i+1}^1} t_{\gamma_i^2} t_{\gamma_{i+1}^2} \cdots t_{\gamma_i^{k-1}} t_{\gamma_{i+1}^{k-1}} t_{\gamma_i^k} \quad \text{for odd } 1 \leq i \leq 2n-1,$$

$$(2) \tilde{h}_i = t_{\gamma_i^k} t_{\gamma_{i+1}^k} t_{\gamma_i^{k-1}} t_{\gamma_{i+1}^{k-1}} \cdots t_{\gamma_i^2} t_{\gamma_{i+1}^2} t_{\gamma_i^1} \quad \text{for even } 2 \leq i \leq 2n-2$$

hold relative to \tilde{D} for some lift \tilde{h}_i of h_i with respect to p , and the relation

$$\tilde{h}_{2n} = t_{\gamma_{2n}^k} t_{\gamma_{2n+1}^k} t_{\gamma_{2n}^{k-1}} t_{\gamma_{2n+1}^{k-1}} \cdots t_{\gamma_{2n}^2} t_{\gamma_{2n+1}^2} t_{\gamma_{2n}^1}$$

holds for some lift \tilde{h}_{2n} of h_{2n} with respect to p .

Proof. Since the isotopy class of a homeomorphism on Σ_0 relative to \mathcal{B} (resp. $\mathcal{B} \cup D$) is determined by the isotopy class of the image of L relative to \mathcal{B} (resp. $\mathcal{B} \cup D$), we have $h_{2i-1} = t_{2i-1,2i} a_i$ for $1 \leq i \leq n$ and $h_{2i} = t_{2i,2i+1} b_i$ for $1 \leq i \leq n-1$ in $\text{LMod}_{2n+2,*}$ and LMod_{2n+1}^1 , and $h_{2n} = t_{2n,2n+1} b_n$ in LMod_{2n+2} by Figure 26. Thus the product $\tilde{t}_{2i-1,2i} \tilde{a}_i$ (resp. $\tilde{t}_{2i,2i+1} \tilde{b}_i$) is a lift of h_{2i-1} (resp. h_{2i}) with respect to p . Since the products $t_{\alpha_i^1} t_{\alpha_i^2} \cdots t_{\alpha_i^{k-1}}$, $t_{\beta_i^{k-1}} t_{\beta_i^{k-2}} \cdots t_{\beta_i^1}$ for $1 \leq i \leq n$ for $1 \leq i \leq n$, and $t_{\gamma_j^1} t_{\gamma_j^2} \cdots t_{\gamma_j^k}$ for $1 \leq j \leq 2n+1$ are lifts of a_i , b_i , and $t_{j,j+1}$ by Lemmas 6.3 and 6.4, respectively, we denote $\tilde{a}_i = t_{\alpha_i^1} t_{\alpha_i^2} \cdots t_{\alpha_i^{k-1}}$, $\tilde{b}_i = t_{\beta_i^{k-1}} t_{\beta_i^{k-2}} \cdots t_{\beta_i^1}$ for $1 \leq i \leq n$, and $\tilde{t}_{i,i+1} = t_{\gamma_i^1} t_{\gamma_i^2} \cdots t_{\gamma_i^k}$ for $1 \leq i \leq 2n+1$. For $1 \leq i \leq n$, $t_{\alpha_i^l}$ commutes with $t_{\gamma_{2i-1}^{l'}}$ for $1 \leq l \leq k-2$ and $l+2 \leq l' \leq k$, and the relation $t_{\gamma_{2i-1}^{l+1}} t_{\alpha_i^l} = t_{\gamma_{2i-1}^l} t_{\gamma_{2i-1}^{l+1}}$ holds for $1 \leq l \leq k-1$. Hence, for $1 \leq i \leq n$, we have

$$\begin{aligned} \tilde{h}_{2i-1} &= \tilde{t}_{2i-1,2i} \tilde{a}_i \\ &= t_{\gamma_{2i-1}^1} t_{\gamma_{2i-1}^2} \cdots t_{\gamma_{2i-1}^k} \cdot \underbrace{t_{\alpha_i^1}}_{\leftarrow} \cdots \underbrace{t_{\alpha_i^{k-2}} t_{\alpha_i^{k-1}}}_{\leftarrow} \\ &\stackrel{\text{COMM}}{=} t_{\gamma_{2i-1}^1} t_{\gamma_{2i-1}^2} t_{\alpha_i^1} \underbrace{t_{\gamma_{2i-1}^3} t_{\alpha_i^2}}_{\leftarrow} \cdots \underbrace{t_{\gamma_{2i-1}^k} t_{\alpha_i^{k-1}}}_{\leftarrow} \\ &\stackrel{\text{CONJ}}{=} t_{\gamma_{2i-1}^1} t_{\gamma_{2i-1}^2} t_{\gamma_{2i-1}^3} t_{\gamma_{2i-1}^4} \cdots t_{\gamma_{2i-1}^{k-1}} t_{\gamma_{2i-1}^k}. \end{aligned}$$

Thus we have completed the proof of Lemma 6.6 for odd $1 \leq i \leq 2n-1$.

Similarly, for $1 \leq i \leq n$, $t_{\beta_i^l}$ commutes with $t_{\gamma_{2i}^{l'}}$ for $2 \leq l \leq k-1$ and $1 \leq l' \leq l-1$, and the relation $t_{\gamma_{2i}^l} t_{\beta_i^l} = t_{\gamma_{2i+1}^{l+1}} t_{\gamma_{2i}^l}$ holds for $1 \leq l \leq k-1$. Hence, for $1 \leq i \leq n$, we have

$$\begin{aligned} \tilde{h}_{2i} &= \tilde{t}_{2i,2i+1} \tilde{b}_i \\ &= t_{\gamma_{2i}^k} t_{\gamma_{2i}^{k-1}} \cdots t_{\gamma_{2i}^1} \cdot \underbrace{t_{\beta_i^{k-1}}}_{\leftarrow} \cdots \underbrace{t_{\beta_i^2} t_{\beta_i^1}}_{\leftarrow} \\ &\stackrel{\text{COMM}}{=} t_{\gamma_{2i}^k} \underbrace{t_{\gamma_{2i}^{k-1}} t_{\beta_i^{k-1}}}_{\leftarrow} \cdots \underbrace{t_{\gamma_{2i}^2} t_{\beta_i^2}}_{\leftarrow} \underbrace{t_{\gamma_{2i}^1} t_{\beta_i^1}}_{\leftarrow} \\ &\stackrel{\text{CONJ}}{=} t_{\gamma_{2i}^k} t_{\gamma_{2i+1}^k} t_{\gamma_{2i}^{k-1}} \cdots t_{\gamma_{2i+1}^3} t_{\gamma_{2i}^2} t_{\gamma_{2i+1}^2} t_{\gamma_{2i}^1}. \end{aligned}$$

Therefore we have completed the proof of Lemma 6.6. \square

By Corollaries 6.2 and 6.5, and the fact that $\tilde{h}_{2i-1} = \tilde{t}_{2i-1,2i} \tilde{a}_i$ and $\tilde{h}_{2i} = \tilde{t}_{2i,2i+1} \tilde{b}_i$ for $1 \leq i \leq n$ in the proof of Lemma 6.6, we have the following corollary.

Corollary 6.7. For $1 \leq i \leq 2n-1$, \tilde{h}_i commutes with ζ (resp. ζ') in $\text{SMod}_{g,*,k}$ (resp. $\text{SMod}_{g;k}^1$). \tilde{h}_{2n} commutes with ζ in $\text{SMod}_{g;k}$.

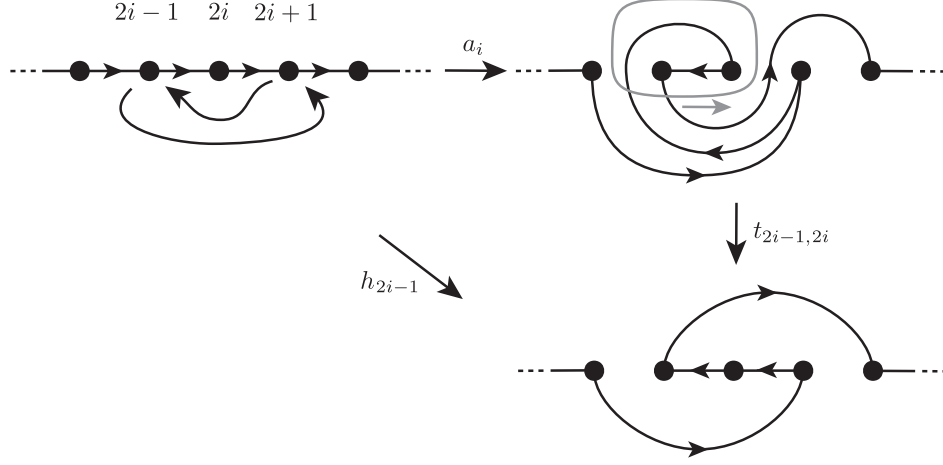

FIGURE 26. The relation $h_{2i-1} = t_{2i-1,2i}a_i$ for $1 \leq i \leq n$ in LMod_{2n+2} . Similarly, we have the relation $h_{2i} = t_{2i,2i+1}b_i$ for $1 \leq i \leq n$ in LMod_{2n+2} .

Let \tilde{r} be a homeomorphism on Σ_g which satisfies $\tilde{r}(\tilde{l}_{2i-1}^l) = (\tilde{l}_{2n-2i+3}^{k-l+2})^{-1}$ for $1 \leq i \leq n+1$ and $2 \leq l \leq k$ and $\tilde{r}(\tilde{l}_{2i}^l) = (\tilde{l}_{2n-2i+2}^{k-l+1})^{-1}$ for $1 \leq i \leq n$ and $1 \leq l \leq k$. Remark that \tilde{r} is uniquely determined up to isotopy and is described as the result of the π -rotation of Σ_g as in Figure 27. The rotation axis of \tilde{r} intersects with Σ_g at two points in $S(\frac{n+1}{2})$ for odd n , at two points in the handle intersecting with $\tilde{l}_{n+1}^{\frac{k+1}{2}}$ for even n and odd k , and at no points for even n and k . In actuality, the arc $\tilde{l}_{n+1}^{\frac{k+1}{2}}$ in the case of even n and odd k must intersect with the rotation axis of \tilde{r} , however, we describe $\tilde{l}_{n+1}^{\frac{k+1}{2}}$ in Figure 27 as a parallel arc of $\tilde{l}_{n+1}^{\frac{k+1}{2}}$ to see well. Since $r(l_i) = l_{2n-i+2}^{-1}$ for $1 \leq i \leq 2n+1$, \tilde{r} is a lift of r with respect to p . Since we have

$$\tilde{r}\zeta\tilde{r}^{-1}(\tilde{l}_{2i-1}^l) = \tilde{r}\zeta((\tilde{l}_{2n-2i+3}^{k-l+1})^{-1}) = \tilde{r}((\tilde{l}_{2n-2i+3}^{k-l+2})^{-1}) = \tilde{l}_{2i-1}^{l-1}$$

for $1 \leq i \leq k \bmod k$ and $1 \leq i \leq 2n+1$, the following lemma holds.

Lemma 6.8. *The relation $\tilde{r}\zeta\tilde{r}^{-1} = \zeta^{-1}$ holds in $\text{SMod}_{g;k}$.*

Let δ_i^l for $1 \leq i \leq n$ and $1 \leq l \leq k$ be a non-separating simple closed curve on Σ_g which transversely intersects with \tilde{l}_{2i}^l at one point and does not intersect with other \tilde{l}_j^l , and let δ_i for $2 \leq i \leq n+1$ be a separating simple closed curve on Σ_g which transversely intersects with \tilde{l}_{2i-1}^l for each $1 \leq l \leq k$ at one point and does not intersect with other \tilde{l}_j^l as in Figure 28. Remark that $\delta_1^l = \gamma_1^l$ and $\delta_n^l = \gamma_{2n+1}^l$ for $1 \leq l \leq k$, and $\delta_{n+1} = \partial\tilde{D}$. Denote by $\zeta_i = \zeta_{g,k;i}$ for $2 \leq i \leq n+1$ the self-homeomorphism on Σ_g which is described as the result of $-(\frac{2\pi}{k})$ -rotation of Σ_g fixing the subsurface that is cut off by δ_i and includes \tilde{D} as in Figure 28. We also remark that $\zeta_{n+1} = \zeta'$ in $\text{SMod}_{g;k}^1$ and $\zeta_{n+1} = \zeta$ in $\text{SMod}_{g;k}$. Since δ_i^l for $1 \leq i \leq n$ and $1 \leq l \leq k$ is a lift of $\gamma_{1,2i}$ with respect to p and the isotopy class of a homeomorphism on Σ_g is determined by the isotopy class of the image of \tilde{L} , we have the following lemma.

Lemma 6.9. *The relations*

- (1) $\tilde{t}_{1,2i} = t_{\delta_1^1} t_{\delta_2^2} \cdots t_{\delta_i^k}$ for $1 \leq i \leq n$,
- (2) $\tilde{t}_{1,2i-1} = \zeta_i$ for $2 \leq i \leq n+1$

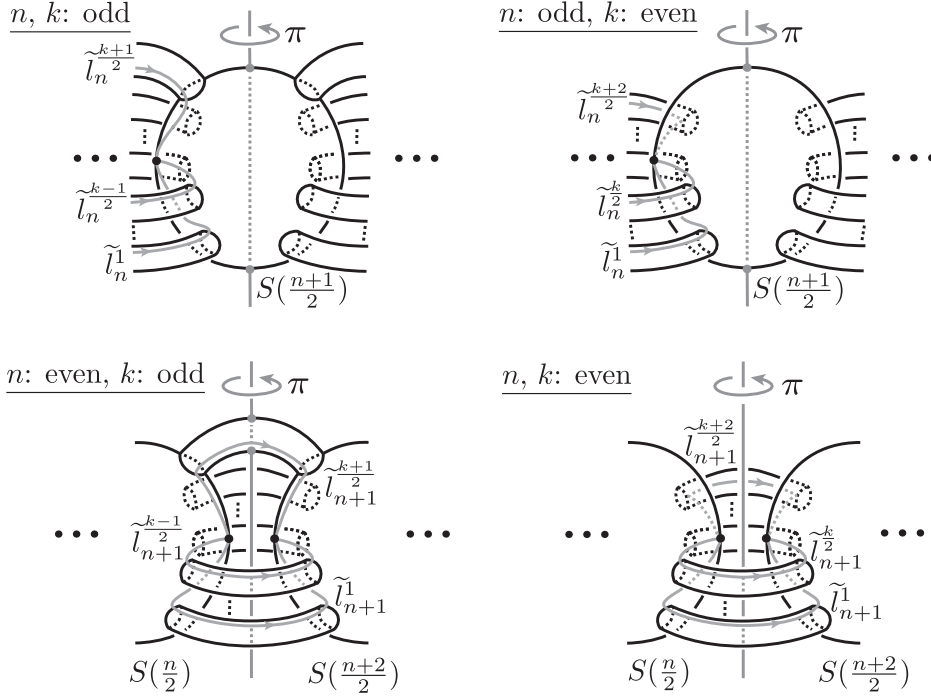
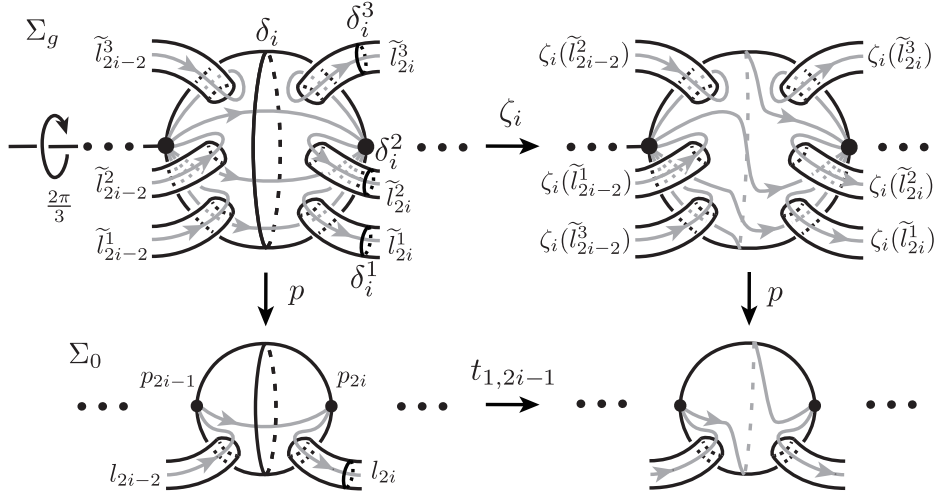
 FIGURE 27. A lift \tilde{r} of r with respect to p .

 FIGURE 28. Simple closed curves δ_i^l for $1 \leq i \leq n$ and $1 \leq l \leq k$ and δ_i for $2 \leq i \leq n+1$ on Σ_g , and the homeomorphism ζ_i for $2 \leq i \leq n+1$ on Σ_g when $k = 3$.

hold relative to \tilde{D} for some lift $\tilde{t}_{1,j}$ of $t_{1,j}$ ($1 \leq j \leq 2n+1$) with respect to p .

6.2. Main theorems for the balanced superelliptic mapping class groups.

We define $\tilde{h}_i = t_{\gamma_i^1} t_{\gamma_{i+1}^1} t_{\gamma_i^2} t_{\gamma_{i+1}^2} \cdots t_{\gamma_i^{k-1}} t_{\gamma_{i+1}^{k-1}} t_{\gamma_i^k}$ for odd $1 \leq i \leq 2n-1$, $\tilde{h}_i = t_{\gamma_i^k} t_{\gamma_{i+1}^k} t_{\gamma_i^{k-1}} t_{\gamma_{i+1}^{k-1}} \cdots t_{\gamma_i^2} t_{\gamma_{i+1}^2} t_{\gamma_i^1}$ for even $2 \leq i \leq 2n-2$, and $\tilde{t}_{i,i+1} = t_{\gamma_i^1} t_{\gamma_i^2} \cdots t_{\gamma_i^k}$

for $1 \leq i \leq 2n+1$ (see also Figure 25). Main theorems for the balanced superelliptic mapping class groups are as follows.

Theorem 6.10. *For $n \geq 1$ and $k \geq 3$ with $g = n(k-1)$, $\text{SMod}_{g;k}^1$ admits the presentation with generators \tilde{h}_i for $1 \leq i \leq 2n-1$ and $\tilde{t}_{i,j}$ for $1 \leq i < j \leq 2n+1$, and the following defining relations:*

- (1) commutative relations
 - (a) $\tilde{h}_i \rightleftharpoons \tilde{h}_j$ for $j-i > 3$,
 - (b) $\tilde{t}_{i,j} \rightleftharpoons \tilde{t}_{k,l}$ for $j < k, k \leq i < j \leq l$, or $l < i$,
 - (c) $\tilde{h}_k \rightleftharpoons \tilde{t}_{i,j}$ for $k+2 < i, i \leq k < k+2 \leq j$, or $j < k$,
- (2) relations among \tilde{h}_i 's and $\tilde{t}_{j,j+1}$'s:
 - (a) $\tilde{h}_i^{\pm 1} \tilde{t}_{i,i+1} = \tilde{t}_{i+1,i+2} \tilde{h}_i^{\pm 1}$ for $1 \leq i \leq 2n-2$,
 - (b) $\tilde{h}_i^\varepsilon \tilde{h}_{i+1}^\varepsilon \tilde{t}_{i,i+1} = \tilde{t}_{i+2,i+3} \tilde{h}_i^\varepsilon \tilde{h}_{i+1}^\varepsilon$ for $1 \leq i \leq 2n-2$ and $\varepsilon \in \{1, -1\}$,
 - (c) $\tilde{h}_i^\varepsilon \tilde{h}_{i+1}^\varepsilon \tilde{h}_{i+2}^\varepsilon \tilde{h}_i^\varepsilon = \tilde{h}_{i+2}^\varepsilon \tilde{h}_i^\varepsilon \tilde{h}_{i+1}^\varepsilon \tilde{h}_{i+2}^\varepsilon$ for $1 \leq i \leq 2n-2$ and $\varepsilon \in \{1, -1\}$,
 - (d) $\tilde{h}_i \tilde{h}_{i+1} \tilde{t}_{i,i+1} = \tilde{t}_{i,i+1} \tilde{h}_{i+1} \tilde{h}_i$ for $1 \leq i \leq 2n-2$,
 - (e) $\tilde{h}_i \tilde{h}_{i+2} \tilde{h}_i \tilde{t}_{i+1,i+2}^{-1} = \tilde{t}_{i+2,i+3}^{-1} \tilde{h}_{i+2} \tilde{h}_i \tilde{h}_{i+2}$ for $1 \leq i \leq 2n-3$,
- (3) lifts of the pentagonal relations $(P_{i,j,k,l,m})$ for $1 \leq i < j < k < l < m \leq 2n+2$,
i.e. $\tilde{t}_{j,m-1}^{-1} \tilde{t}_{k,m-1} \tilde{t}_{j,l-1} \tilde{t}_{i,k-1} \tilde{t}_{i,l-1}^{-1} = \tilde{t}_{i,l-1}^{-1} \tilde{t}_{i,k-1} \tilde{t}_{j,l-1} \tilde{t}_{k,m-1} \tilde{t}_{j,m-1}^{-1}$,
- (4) (a) lifts of the relations $(T_{i,j})$, i.e.

$$\tilde{t}_{i,j} = \begin{cases} \tilde{h}_i^2 & \text{for } j-i = 2, \\ \tilde{t}_{j-1,j}^{-\frac{j-i-3}{2}} \cdots \tilde{t}_{i+2,i+3}^{-\frac{j-i-3}{2}} \tilde{t}_{i,i+1}^{-\frac{j-i-3}{2}} (\tilde{h}_{j-2} \cdots \tilde{h}_{i+1} \tilde{h}_i)^{\frac{j-i+1}{2}} & \text{for } 2n-1 \geq j-i \geq 3 \text{ is odd,} \\ \tilde{t}_{j-2,j-1}^{-\frac{j-i-2}{2}} \cdots \tilde{t}_{i+2,i+3}^{-\frac{j-i-2}{2}} \tilde{t}_{i,i+1}^{-\frac{j-i-2}{2}} \tilde{h}_{j-2} \cdots \tilde{h}_{i+2} \tilde{h}_i \tilde{h}_{i+2} \cdots \tilde{h}_{j-2} & \cdot (\tilde{h}_{j-3} \cdots \tilde{h}_{i+1} \tilde{h}_i)^{\frac{j-i}{2}} \text{ for } 2n \geq j-i \geq 4 \text{ is even.} \end{cases}$$

Since $\theta^1: \text{SMod}_{g;k}^1 \rightarrow \text{LMod}_{2n+1}^1$ is an isomorphism (the definitions is reviewed in Section 4.2), $\theta^1(\tilde{h}_i) = h_i$ for $1 \leq i \leq 2n-1$ by Lemma 6.4, and $\theta^1(\tilde{t}_{i,i+1}) = t_{i,i+1}$ for $1 \leq i \leq 2n+1$ by Lemma 6.6, Theorem 6.10 is immediately obtained from Theorem 5.1.

Theorem 6.11. *For $n \geq 1$ and $k \geq 3$ with $g = n(k-1)$, $\text{SMod}_{g,*;k}$ admits the presentation which is obtained from the finite presentation for $\text{SMod}_{g;k}^1$ in Theorem 6.10 by adding the relation*

$$(4) (b) \tilde{t}_{1,2n+1}^k = 1.$$

We remark that $\zeta = \tilde{t}_{1,2n+1}$ by an argument in the proof of Proposition 4.5 (see also the before the proof of Theorem 6.11). We define $\tilde{h}_{2n} = t_{\gamma_{2n}^k} t_{\gamma_{2n+1}^k} t_{\gamma_{2n}^{k-1}} t_{\gamma_{2n+1}^{k-1}} \cdots t_{\gamma_{2n}^2} t_{\gamma_{2n+1}^2} t_{\gamma_{2n}^1}$. By Lemma 6.6 and an argument before Lemma 6.8, \tilde{h}_{2n} and \tilde{r} are preimages of h_{2n} and r with respect to $\theta: \text{SMod}_{g;k} \rightarrow \text{LMod}_{2n+2}$, respectively.

Theorem 6.12. *For $n \geq 1$ and $k \geq 3$ with $g = n(k-1)$, $\text{SMod}_{g;k}$ admits the presentation which is obtained from the finite presentation for $\text{SMod}_{g,*;k}$ in Theorem 6.11 by adding generators \tilde{h}_{2n} and \tilde{r} , and the following relations:*

- (1) commutative relation
 - (d) $\tilde{h}_{2n} \rightleftharpoons \tilde{t}_{1,2n+1}$,
- (4) (c) $\tilde{t}_{1,2n}^{-n+1} \tilde{t}_{2n-1,2n}^{-n+1} \cdots \tilde{t}_{3,4}^{-n+1} \tilde{t}_{1,2}^{-n+1} (\tilde{h}_{2n} \cdots \tilde{h}_2 \tilde{h}_1)^{n+1} = 1$,
- (5) relations among \tilde{r} and \tilde{h}_i 's or $\tilde{t}_{j,j+1}$'s:
 - (a) $\tilde{r}^2 = 1$,

- (b) $\tilde{r}\tilde{h}_i = \tilde{h}_{2n-i+1}\tilde{r}$ for $1 \leq i \leq 2n$,
- (c) $\tilde{r}\tilde{t}_{i,i+1} = \tilde{t}_{2n-i+2,2n-i+3}\tilde{r}$ for $2 \leq i \leq 2n$,
- (d) $\tilde{r}\tilde{t}_{1,j} = \tilde{t}_{1,2n-j+2}\tilde{r}$ for even $2 \leq j \leq 2n$,
- (e) $\tilde{r}\tilde{t}_{1,j}\tilde{r}^{-1}\tilde{t}_{1,2n-j+2}^{-1} = \tilde{t}_{1,2n+1}^{-1}$ for odd $3 \leq j \leq 2n-1$,
- (f) $\tilde{r}\tilde{t}_{1,2n+1} = \tilde{t}_{1,2n+1}^{-1}\tilde{r}$.

As a corollary of Theorems 6.10, 6.11, and 6.12, we have the following corollary.

Corollary 6.13. For $n \geq 1$ and $k \geq 2$ with $g = n(k-1)$,

- (1) $\text{SMod}_{g;k}^1$ and $\text{SMod}_{g,*,k}$ are generated by $\tilde{h}_1, \tilde{h}_2, \dots, \tilde{h}_{2n-1}$, and $\tilde{t}_{1,2}$,
- (2) $\text{SMod}_{g;k}$ is generated by $\tilde{h}_1, \tilde{h}_3, \dots, \tilde{h}_{2n-1}, \tilde{t}_{1,2}$, and \tilde{r} .

Proof. We proceed by a similar argument in the proof of Corollary 5.4. By Theorem 6.10, LMod_{2n+1}^1 is generated by \tilde{h}_i for $1 \leq i \leq 2n-1$ and $\tilde{t}_{i,j}$ for $1 \leq i < j \leq 2n+1$. By the relation (4) (a) in Theorem 6.10, $\tilde{t}_{i,j}$ for $1 \leq i < j \leq 2n+1$ is a product of \tilde{h}_i ($1 \leq i \leq 2n-1$) and $\tilde{t}_{i,i+1}$ ($1 \leq i \leq 2n$). By the relation (2) (a) in Theorem 6.10, we show that $\tilde{t}_{i,i+1}$ is a product of $\tilde{h}_1, \tilde{h}_2, \dots, \tilde{h}_{2n-1}$, and $\tilde{t}_{1,2}$. By Lemma 4.9, we have $\tilde{t}_*(\text{SMod}_{g;k}^1) = \text{SMod}_{g,*,k}$. Therefore, $\text{SMod}_{g;k}^1$ and $\text{SMod}_{g,*,k}$ are generated by $\tilde{h}_1, \tilde{h}_2, \dots, \tilde{h}_{2n-1}$, and $\tilde{t}_{1,2}$.

By Theorem 6.12, $\text{SMod}_{g;k}$ is generated by \tilde{h}_i for $1 \leq i \leq 2n$, $\tilde{t}_{i,j}$ for $1 \leq i < j \leq 2n+1$, and \tilde{r} . As a similar argument in the case (1), every $\tilde{t}_{i,j}$ is a product of \tilde{h}_i ($1 \leq i \leq 2n-1$) and $\tilde{t}_{1,2}$. By the relation (2) (d) in Theorem 6.12, we show that $\tilde{h}_2, \tilde{h}_4, \dots, \tilde{h}_{2n}$ are products of $\tilde{h}_1, \tilde{h}_3, \dots, \tilde{h}_{2n-1}, \tilde{t}_{1,2}$, and \tilde{r} . Therefore, $\text{SMod}_{g;k}$ is generated by $\tilde{h}_1, \tilde{h}_3, \dots, \tilde{h}_{2n-1}, \tilde{t}_{1,2}$, and \tilde{r} , and we have completed Corollary 6.13. \square

Recall that $g = n(k-1)$ for $n \geq 1$ and $k \geq 3$. We remark that $t_{1,2n+1} = t_{\partial D}$ in LMod_{2n+1}^1 , ζ' is the lift of $t_{1,2n+1}$ with respect to $p: \Sigma_g^1 \rightarrow \Sigma_0^1$ (i.e. $\tilde{t}_{1,2n+1} = \zeta'$), and $(\zeta')^k = t_{\partial \bar{D}}$ in $\text{SMod}_{g;k}^1$ (see the proof of Proposition 4.5).

Proof of Theorem 6.11. By the remark above, the exact sequence (4.4) in Proposition 4.10 induces the following exact sequence:

$$1 \longrightarrow \langle \tilde{t}_{1,2n+1}^k \rangle \longrightarrow \text{SMod}_{g;k}^1 \xrightarrow{\tilde{t}_*} \text{SMod}_{g,*,k} \longrightarrow 1.$$

Clearly, we have $\tilde{t}_*(\tilde{h}_i) = \tilde{h}_i \in \text{SMod}_{g,*,k}$ for $1 \leq i \leq 2n-1$ and $\tilde{t}_*(\tilde{t}_{i,i+1}) = \tilde{t}_{i,i+1} \in \text{SMod}_{g,*,k}$ for $1 \leq i \leq 2n$. Put $\tilde{t}_{i,j} = \tilde{t}_*(\tilde{t}_{i,j}) \in \text{SMod}_{g,*,k}$ for $2n \geq j-i \geq 2$. Then \tilde{t}_* maps the relations (1)–(3) and (4) (a) in Theorem 6.10 to the relations (1)–(3) and (4) (a) in Theorem 6.11, respectively. Thus, a presentation for $\text{SMod}_{g,*,k}$ is obtained from the presentation for $\text{SMod}_{g;k}^1$ in Theorem 6.10 by adding the relation $\tilde{t}_{1,2n+1}^k = 1$, and this presentation coincides with the presentation in Theorem 6.11. Therefore, we have completed the proof of Theorem 6.11. \square

To prove Theorem 6.12, we prepare some lemmas. Since $\tilde{r}(\gamma_i^l) = \gamma_{2n-i+2}^{k-l+1}$ for $1 \leq l \leq k$ and odd $1 \leq i \leq 2n+1$, $\tilde{r}(\gamma_i^l) = \gamma_{2n-i+2}^{k-l}$ for $1 \leq l \leq k-1$ and even $2 \leq i \leq 2n$, and $\tilde{r}(\gamma_i^k) = \gamma_{2n-i+2}^k$ for even $2 \leq i \leq 2n$, by using conjugation relations, we have the following lemma.

Lemma 6.14. For $1 \leq i \leq 2n$, the relation $\tilde{r}\tilde{h}_i\tilde{r}^{-1} = \tilde{h}_{2n-i+1}$ holds in $\text{SMod}_{g;k}$.

Since $\tilde{r}(\gamma_i^1 \cup \gamma_i^2 \cup \dots \cup \gamma_i^k) = \gamma_{2n-i+2}^1 \cup \gamma_{2n-i+2}^2 \cup \dots \cup \gamma_{2n-i+2}^k$, we have the following lemma.

Lemma 6.15. For $1 \leq i \leq 2n+1$, the relation $\tilde{r}\tilde{t}_{i,i+1}\tilde{r}^{-1} = \tilde{t}_{2n-i+2,2n-i+3}$ holds in $\text{SMod}_{g;k}$.

The conjugation $\tilde{r}\zeta_i\tilde{r}^{-1}$ for $2 \leq i \leq n$ is the self-homeomorphism on Σ_g which is described as the result of $\frac{2\pi}{k}$ -rotation of Σ_g fixing the subsurface that is cut off by δ_{n-i+2} and does not include \tilde{D} . Thus the product $\zeta_{n-i+2}\tilde{r}\zeta_i^{-1}\tilde{r}^{-1}$ coincides with ζ in $\text{SMod}_{g;k}$. Since we can also see that $\tilde{r}(\delta_i^1 \cup \delta_i^2 \cup \cdots \cup \delta_i^k) = \delta_{n-i+1}^1 \cup \delta_{n-i+1}^2 \cup \cdots \cup \delta_{n-i+1}^k$, we have the following lemma.

Lemma 6.16. *The relations*

- (1) $\tilde{r}\tilde{t}_{1,2i}\tilde{r}^{-1} = \tilde{t}_{1,2n-2i+2}$ for $1 \leq i \leq n$,
- (2) $\zeta_{n-i+2}\tilde{r}\zeta_i^{-1}\tilde{r}^{-1} = \zeta$ for $2 \leq i \leq n$

hold in $\text{SMod}_{g;k}$.

By Lemma 2.5, we have $t_{1,2n}^{-n+1}t_{2n-1,2n}^{-n+1} \cdots t_{3,4}^{-n+1}t_{1,2}^{-n+1}(h_{2n} \cdots h_2h_1)^{n+1} = t_{1,2n+2}$ in LMod_{2n+2} . Since $\gamma_{1,2n+2}$ does not intersect with $L = l_1 \cup l_2 \cup \cdots \cup l_{2n+1}$, $\gamma_{1,2n+2}$ lifts a simple closed curve on Σ_g which bounds a disk in Σ_g . Thus we have the following lemma.

Lemma 6.17. *The relation*

$$\tilde{t}_{1,2n}^{-n+1}\tilde{t}_{2n-1,2n}^{-n+1} \cdots \tilde{t}_{3,4}^{-n+1}\tilde{t}_{1,2}^{-n+1}(\tilde{h}_{2n} \cdots \tilde{h}_2\tilde{h}_1)^{n+1} = 1$$

holds in $\text{SMod}_{g;k}$.

Proof of Theorem 6.12. From the Birman-Hilden correspondence [3], we have the exact sequence

$$1 \longrightarrow \langle \zeta \rangle \longrightarrow \text{SMod}_{g;k} \xrightarrow{\theta} \text{LMod}_{2n+2} \longrightarrow 1.$$

We will apply Lemma 3.2 to the exact sequence above and the presentation for LMod_{2n+2} in Theorem 5.3.

First, by Lemmas 6.4 and 6.6, we have $\theta(\tilde{h}_i) = h_i$ for $1 \leq i \leq 2n$, $\theta(\tilde{t}_{i,i+1}) = t_{i,i+1}$ for $1 \leq i \leq 2n+1$, and $\theta(\tilde{r}) = r$. Since the forgetful homomorphism $\mathcal{F}: \text{SMod}_{g,*;k} \hookrightarrow \text{SMod}_{g;k}$ is injective by Lemma 4.6, we regard $\text{SMod}_{g,*;k}$ as a subgroup of $\text{SMod}_{g;k}$ and denote $\tilde{t}_{i,j} = \mathcal{F}(\tilde{t}_{i,j}) \in \text{SMod}_{g;k}$ for $2n \geq j-i \geq 2$. Since $\tilde{t}_{1,2i} = t_{\delta_i^1}t_{\delta_i^2} \cdots t_{\delta_i^k}$ for $1 \leq i \leq n$ and $\tilde{t}_{1,2i-1} = \zeta_i$ for $2 \leq i \leq n+1$ in $\text{SMod}_{g;k}^1$ by Lemma 6.9 and the injectivity of $\theta^1: \text{SMod}_{g;k}^1 \rightarrow \text{LMod}_{2n+1}^1$, we also have $\tilde{t}_{1,2i} = t_{\delta_i^1}t_{\delta_i^2} \cdots t_{\delta_i^k}$ for $1 \leq i \leq n$ and $\tilde{t}_{1,2i-1} = \zeta_i$ for $2 \leq i \leq n+1$ in $\text{SMod}_{g;k}$ (in particular, $\tilde{t}_{1,2n+1} = \zeta$ in $\text{SMod}_{g;k}$).

By Theorem 6.11 and using \mathcal{F} , the relations (1) (a)–(c), (2) (a)–(e), (3), (4) (a), and (b) in Theorem 6.12 are hold in $\text{SMod}_{g;k}$. By Corollary 6.7 and Lemmas 6.17, 6.14, 6.15, and 6.8, the relations (1) (d), (4) (c), (5) (b), (c), and (f) in Theorem 6.12 hold in $\text{SMod}_{g;k}$. Since \tilde{r} is defined as a π -rotation of Σ_g , the relation (5) (a) holds in $\text{SMod}_{g;k}$. By Lemma 6.16, the relations (5) (d) and (5) (e) hold in $\text{SMod}_{g;k}$. By the argument above and applying Lemma 3.2 to the exact sequence above and the presentation for LMod_{2n+2} in Theorem 5.3, we have the presentation for $\text{SMod}_{g;k}$ whose generators are \tilde{h}_i for $1 \leq i \leq 2n$, $\tilde{t}_{i,j}$ for $1 \leq i < j \leq 2n+1$, and \tilde{r} , and the following defining relations:

- (A) $\tilde{t}_{1,2n+1}^k = 1$,
- (B) the relations (1) (a)–(c), (2) (a)–(e), (3), (4) (a)–(c), (5) (a)–(e) in Theorem 6.12,
- (C) (a) $\tilde{h}_i\tilde{t}_{1,2n+1}\tilde{h}_i^{-1} = \tilde{t}_{1,2n+1}$ for $1 \leq i \leq 2n$,
- (b) $\tilde{t}_{i,j}\tilde{t}_{1,2n+1}\tilde{t}_{i,j}^{-1} = \tilde{t}_{1,2n+1}$ for $1 \leq i < j \leq 2n+1$,
- (c) $\tilde{r}\tilde{t}_{1,2n+1}\tilde{r}^{-1} = \tilde{t}_{1,2n+1}^{-1}$.

The generators of the presentation for $\text{SMod}_{g;k}$ above coincide with the generators of the presentation for $\text{SMod}_{g;k}$ in Theorem 6.12. The relation (A) above coincides with the relation (2) (e) in Theorem 6.12. The relations (C) (a) and (b)

above coincide with the relations (1) (c) and (b) in Theorem 6.12, respectively. The relation (C) (c) above coincides with the relation (5) (f) in Theorem 6.12. Therefore, the presentation for $\text{SMod}_{g;k}$ above is equivalent to the presentation in Theorem 6.12 and we have completed the proof of Theorem 6.12. \square

6.3. The first homology groups of the balanced superelliptic mapping class groups. In this section, we will prove Theorem 1.2. For conveniences, we denote the equivalence class in $H_1(\text{SMod}_{g;k}^1)$ (resp. $H_1(\text{SMod}_{g,*;k})$ and $H_1(\text{SMod}_{g;k})$) of an element h in $\text{SMod}_{g;k}^1$ (resp. $\text{SMod}_{g,*;k}$ and $\text{SMod}_{g;k}$) by h . Recall that $g = n(k-1)$ for $n \geq 1$ and $k \geq 3$. By an isomorphism $\theta^1: \text{SMod}_{g;k}^1 \rightarrow \text{LMod}_{2n+1}^1$ and Theorem 1.1 for LMod_{2n+1}^1 , we have

$$H_1(\text{SMod}_{g;k}^1) \cong \begin{cases} \mathbb{Z}^2 & \text{if } n = 1, \\ \mathbb{Z}^3 & \text{if } n \geq 2. \end{cases}$$

Proof of Theorem 1.2 for $\text{SMod}_{g,;k}$.* The exact sequence (4.4) in Proposition 4.10 induces the exact sequence:

$$1 \longrightarrow \langle \tilde{t}_{1,2n+1}^k \rangle \longrightarrow H_1(\text{SMod}_{g;k}^1) \xrightarrow{\tilde{t}_*} H_1(\text{SMod}_{g,*;k}) \longrightarrow 1.$$

By Theorem 1.1 and its proof for $\text{LMod}_{2n+2,*}$, we have $H_1(\text{LMod}_3^1) \cong \mathbb{Z}[\tilde{h}_1] \oplus \mathbb{Z}[\tilde{t}_{1,2}]$ and $H_1(\text{SMod}_{g;k}^1) \cong \mathbb{Z}[\tilde{h}_1] \oplus \mathbb{Z}[\tilde{h}_2] \oplus \mathbb{Z}[\tilde{t}_{1,2}]$ for $n \geq 2$. Since we have $\tilde{t}_{1,3} = \tilde{h}_1^2$ by the relation (4) (a) in Theorem 6.10, when $n = 1$, as a presentation for an abelian group, we have

$$H_1(\text{SMod}_{k-1,*;k}) \cong \langle \tilde{h}_1, \tilde{t}_{1,2} \mid (\tilde{h}_1^2)^k = 1 \rangle \cong \mathbb{Z}[\tilde{t}_{1,2}] \oplus \mathbb{Z}_{2k}[\tilde{h}_1].$$

Since we have

$$\tilde{t}_{1,2n+1} = \tilde{t}_{2n-1,2n}^{-n+1} \cdots \tilde{t}_{3,4}^{-n+1} \tilde{t}_{1,2}^{-n+1} \tilde{h}_{2n-1} \cdots \tilde{h}_3 \tilde{h}_1 \tilde{h}_1 \tilde{h}_3 \cdots \tilde{h}_{2n-1} (\tilde{h}_{2n-2} \cdots \tilde{h}_2 \tilde{h}_1)^n$$

by the relation (4) (a) in Theorem 6.10, the relation

$$\tilde{t}_{1,2n+1}^k = (\tilde{t}_{1,2}^{-n(n-1)} \tilde{h}_1^{n(n+1)} \tilde{h}_2^{n(n-1)})^k = (\tilde{t}_{1,2}^{-n+1} \tilde{h}_1^{n+1} \tilde{h}_2^{n-1})^{kn}$$

holds in $H_1(\text{LMod}_{2n+2,*})$. Thus, when $n \geq 2$, as a presentation for an abelian group, we have

$$\begin{aligned} H_1(\text{SMod}_{g,*;k}) &\cong \langle \tilde{h}_1, \tilde{h}_2, \tilde{t}_{1,2} \mid (\tilde{t}_{1,2}^{-n+1} \tilde{h}_1^{n+1} \tilde{h}_2^{n-1})^{kn} = 1 \rangle \\ &\cong \langle \tilde{h}_1, \tilde{h}_2, \tilde{t}_{1,2}, X \mid (X^{n-1} \tilde{h}_1^2)^{kn} = 1, X = \tilde{t}_{1,2}^{-1} \tilde{h}_1 \tilde{h}_2 \rangle \\ &\cong \langle \tilde{h}_1, \tilde{h}_2, X \mid (\tilde{h}_1^2 X^{n-1})^{kn} = 1 \rangle. \end{aligned}$$

By an argument similar to the proof of Theorem 1.1 for $\text{LMod}_{2n+2,*}$, we have

$$H_1(\text{SMod}_{g,*;k}) \cong \begin{cases} \mathbb{Z}[\tilde{h}_2] \oplus \mathbb{Z}[X] \oplus \mathbb{Z}_{2kn}[Y_1] & \text{if } n \geq 3 \text{ is odd,} \\ \mathbb{Z}[\tilde{h}_2] \oplus \mathbb{Z}[Y_2] \oplus \mathbb{Z}_{kn}[Z] & \text{if } n \geq 2 \text{ is even,} \end{cases}$$

where $X = \tilde{t}_{1,2}^{-1} \tilde{h}_1 \tilde{h}_2$, $Y_1 = \tilde{t}_{1,2}^{-\frac{n-1}{2}} \tilde{h}_1^{\frac{n+1}{2}} \tilde{h}_2^{\frac{n-1}{2}}$, $Y_2 = \tilde{t}_{1,2}^{-\frac{n}{2}} \tilde{h}_1^{\frac{n+2}{2}} \tilde{h}_2^{\frac{n}{2}}$, and $Z = \tilde{t}_{1,2}^{-n+1} \tilde{h}_1^{n+1} \tilde{h}_2^{n-1}$. Therefore, we have completed the proof of Theorem 1.2 for $\text{SMod}_{g,*;k}$. \square

Proof of Theorem 1.2 for $\text{SMod}_{g;k}$. We will calculate $H_1(\text{SMod}_{g;k})$ by using the finite presentations for $\text{SMod}_{g;k}$ in Theorem 6.12. We proceed by an argument similar to the proof of Theorem 1.1 for LMod_{2n+2} . By an argument similar to the proof of Theorem 1.1 for LMod_{2n+2} , the relations (1), (2) (a)–(e), (3), (5) (b), (c), and (f) in Theorem 6.12 are equivalent to the relations $\tilde{t}_{i,i+1} = \tilde{t}_{i+1,i+2}$ for $1 \leq i \leq 2n-1$ and $\tilde{h}_i = \tilde{h}_{i+1}$ for $1 \leq i \leq 2n-1$ in $H_1(\text{LMod}_{2n+1}^1)$. By an

argument similar to the proof of Theorem 1.1 for LMod_{2n+2} , in $H_1(\text{SMod}_{g;k})$, the relations (5) (d), (4) (b), (c), and (5) (g) in Theorem 6.12 are equivalent to the following relations:

- (A) $(\tilde{t}_{1,2}^{-n+1}\tilde{h}_1^{2n})^{kn} = 1$,
- (B) $(\tilde{t}_{1,2}^{-n+1}\tilde{h}_1^{2n})^{n+1} = 1$,
- (C) $(\tilde{t}_{1,2}^{-n+1}\tilde{h}_1^{2n})^{n-2i+1} = 1$ for $1 \leq i \leq n$, and
- (D) $(\tilde{t}_{1,2}^{-n+1}\tilde{h}_1^{2n})^{n-2i} = (\tilde{t}_{1,2}^{-n+1}\tilde{h}_1^{2n})^n \Leftrightarrow (\tilde{t}_{1,2}^{-n+1}\tilde{h}_1^{2n})^{2i} = 1$ for $1 \leq i \leq n-1$

Up to the relation (B) above, the relation (C) for $1 \leq i \leq n-1$ is equivalent to the relation (D) for $1 \leq i \leq n-1$. The relation (C) for $i = n$ coincides with the relation (B). Up to the relation (B), the relation (A) is equivalent to the relation $(\tilde{t}_{1,2}^{-n+1}\tilde{h}_1^{2n})^k = 1$. The relations (D) for $2 \leq i \leq n-1$ are obtained from the relation (D) for $i = 1$. Thus the relations (A)–(D) are equivalent to the relations

- (A') $(\tilde{t}_{1,2}^{-n+1}\tilde{h}_1^{2n})^k = 1$,
- (B') $(\tilde{t}_{1,2}^{-n+1}\tilde{h}_1^{2n})^{n+1} = 1$, and
- (C') $(\tilde{t}_{1,2}^{-n+1}\tilde{h}_1^{2n})^2 = 1$.

When n is even or k is odd, by the relation (C'), we have the relation $\tilde{t}_{1,2}^{-n+1}\tilde{h}_1^{2n} = 1$ in $H_1(\text{SMod}_{g;k})$. When n is odd and k is even, the relations (A') and (B') are obtained from the relation (C'). Thus the relations (A')–(C') above are equivalent to the relation $\tilde{t}_{1,2}^{-n+1}\tilde{h}_1^{2n} = 1$ when n is even or k is odd, and $(\tilde{t}_{1,2}^{-n+1}\tilde{h}_1^{2n})^2 = 1$ when n is odd and k is even.

When n is even or k is odd, by arguments above and in the proof of Theorem 1.1 for LMod_{2n+2} , we have

$$\begin{aligned} H_1(\text{SMod}_{g;k}) &\cong \langle \tilde{h}_1, \tilde{t}_{1,2}, \tilde{r} \mid \tilde{r}^2 = 1, \tilde{t}_{1,2}^{-n+1}\tilde{h}_1^{2n} = 1 \rangle \\ &\cong \begin{cases} \mathbb{Z}[\tilde{t}_{1,2}] \oplus \mathbb{Z}_2[\tilde{h}_1] \oplus \mathbb{Z}_2[\tilde{r}] & \text{if } n = 1, \\ \mathbb{Z}[X] \oplus \mathbb{Z}_2[\tilde{r}] \oplus \mathbb{Z}_2[Y_1] & \text{if } n \geq 3 \text{ is odd,} \\ \mathbb{Z}[Y_2] \oplus \mathbb{Z}_2[\tilde{r}] & \text{if } n \geq 2 \text{ is even,} \end{cases} \end{aligned}$$

where $X = \tilde{t}_{1,2}^{-1}\tilde{h}_1^2$, $Y_1 = \tilde{t}_{1,2}^{-\frac{n-1}{2}}\tilde{h}_1^n$, and $Y_2 = \tilde{t}_{1,2}^{-\frac{n}{2}}\tilde{h}_1^{n+1}$.

When n is odd and k is even, by an argument above, we have

$$\begin{aligned} H_1(\text{SMod}_{g;k}) &\cong \langle \tilde{h}_1, \tilde{t}_{1,2}, \tilde{r} \mid \tilde{r}^2 = 1, (\tilde{t}_{1,2}^{-n+1}\tilde{h}_1^{2n})^2 = 1 \rangle \\ &\cong \langle \tilde{h}_1, \tilde{t}_{1,2}, \tilde{r}, X \mid \tilde{r}^2 = 1, (X^{n-1}\tilde{h}_1^2)^2 = 1, X = \tilde{t}_{1,2}^{-1}\tilde{h}_1^2 \rangle \\ &\cong \langle \tilde{h}_1, \tilde{r}, X \mid \tilde{r}^2 = 1, (X^{n-1}\tilde{h}_1^2)^2 = 1 \rangle \\ &\cong \langle \tilde{h}_1, \tilde{r}, X, Y \mid \tilde{r}^2 = 1, Y^4 = 1, Y = X^{\frac{n-1}{2}}\tilde{h}_1 \rangle \\ &\cong \langle \tilde{r}, X, Y \mid \tilde{r}^2 = 1, Y^4 = 1 \rangle \\ &\cong \mathbb{Z}[X] \oplus \mathbb{Z}_2[\tilde{r}] \oplus \mathbb{Z}_4[Y], \end{aligned}$$

where $X = \tilde{t}_{1,2}^{-1}\tilde{h}_1^2$ and $Y = X^{\frac{n-1}{2}}\tilde{h}_1 = \tilde{t}_{1,2}^{-\frac{n-1}{2}}\tilde{h}_1^n$. Therefore we have completed the proof of Theorem 1.2 for $\text{SMod}_{g;k}$ \square

Acknowledgement: The authors would like to express their gratitude to Tyrone Ghaswala for helpful advices and telling them Proposition 5.3 in [7] that is a generalized version of Lemma 6.1. The first author was supported by JSPS KAKENHI Grant Numbers JP16K05156 and JP20K03618. The second author was supported by JSPS KAKENHI Grant Numbers JP19K23409 and 21K13794.

REFERENCES

- [1] J. S. Birman, *Mapping class groups and their relationship to braid groups*, Comm. Pure Appl. Math. **22** (1969), 213–238.
- [2] J. S. Birman, H. M. Hilden, *On the mapping class groups of closed surfaces as covering spaces*, Advances in the Theory of Riemann Surfaces (Proc. Conf., Stony Brook, N.Y., 1969), Ann. of Math. Studies 66, Princeton Univ. Press, Princeton, N.J., 81–115, 1971.
- [3] J. S. Birman, H. M. Hilden, *Lifting and projecting homeomorphisms*, Arch. Math. (Basel) **23** (1972), 428–434.
- [4] J. S. Birman, H. M. Hilden, *On isotopies of homeomorphisms of Riemann surfaces*, Ann. of Math. (2) **97** (1973), 424–439.
- [5] T. E. Brendle, D. Margalit, *Point pushing, homology, and the hyperelliptic involution*, Michigan Math. J. **62** (2013), 451–473.
- [6] B. Farb, D. Margalit, *A primer on mapping class groups*, Princeton University Press, Princeton, NJ, 2012.
- [7] T. Ghaswala, A. McLeay, *Mapping class groups of covers with boundary and braid group embeddings*, Algebr. Geom. Topol. **20** (2020), no. 1, 239–278.
- [8] T. Ghaswala, R. R. Winarski, *The liftable mapping class group of balanced superelliptic covers*, arXiv:1604.03908.
- [9] T. Ghaswala, R. R. Winarski, *The liftable mapping class group of balanced superelliptic covers*, New York J. Math. **23** (2017), 133–164.
- [10] T. Ghaswala, R. R. Winarski, *Lifting homeomorphisms and cyclic branched covers of spheres*, Michigan Math. J. **66** (2017), no. 4, 885–890.
- [11] D.L. Johnson: Presentations of Groups, London Math. Soc. Stud. Texts **15**, 1990.
- [12] D. Margalit, J. McCammond, *Geometric presentations for the pure braid group*, J. Knot Theory Ramifications **18** (2009), no. 1, 1–20.

(SUSUMU HIROSE) DEPARTMENT OF MATHEMATICS, FACULTY OF SCIENCE AND TECHNOLOGY,
 TOKYO UNIVERSITY OF SCIENCE, 2641 YAMAZAKI, NODA-SHI, CHIBA, 278-8510 JAPAN
Email address: hirose_susumu@ma.noda.tus.ac.jp

(GENKI OMORI) DEPARTMENT OF MATHEMATICS, FACULTY OF SCIENCE AND TECHNOLOGY,
 TOKYO UNIVERSITY OF SCIENCE, 2641 YAMAZAKI, NODA-SHI, CHIBA, 278-8510 JAPAN
Email address: omori_genki@ma.noda.tus.ac.jp