

POSITIVE RICCI CURVATURE AND THE LENGTH OF A SHORTEST PERIODIC GEODESIC.

REGINA ROTMAN

ABSTRACT. Let M^n be a closed Riemannian manifold of dimension $n \geq 2$, with Ricci curvature $Ric \geq n - 1$. We will show that any sphere of dimension m in the space of closed loops on M^n is homotopic to the sphere in the space of closed loops of length at most $8\pi m$. It follows that the length of a shortest periodic geodesic on M^n is bounded from above by $8\pi(n - 1)$.

1. MAIN RESULTS.

Periodic geodesics are fundamental objects of Riemannian Geometry. In particular, it has been of long interest to bound the length of a shortest periodic geodesic in terms of the other geometric parameters of the manifold, such as its volume, diameter and \ or curvature. Specifically, M. Gromov asked whether there exists a constant $c(n)$ such that on any closed Riemannian manifold of dimension n and volume vol , the length of the shortest closed geodesic can be majorized by $c(n)vol^{\frac{1}{n}}$, (see [G]). A similar question can be posed in terms of diameter of the manifold instead of its volume. The above questions were well-studied in dimension 2, beginning with results of K. Loewner and P. Pu, who have established sharp upper bounds in cases of a Riemannian 2-torus and a Riemannian RP^2 respectively. Some other notable contributions include those of J. Hebda, Yu. Burago and V. Zalgaller, A. Treibergs, M. Gromov, C. Bavard, (who proved a sharp upper bound in the case of Riemannian Klein bottle), as well as M. Katz and S. Sabourau, (see [Ba], [H], [G], [KS1], [KS2], as well as [BrZ], [CrK], [K] for surveys of some of the results). Among the surfaces, the most challenging case was that of a Riemannian 2-sphere. The first area and diameter upper bounds in this case were found by C. B. Croke in [Cr], where it was shown that in the case of a Riemannian 2-sphere M of area A and diameter d , the length of the shortest periodic geodesic $l(M)$ can be majorized by $31\sqrt{A}$ and $9d$. Those bounds were later improved in [M], [S], [NR1], and [R1]. A local optimal area upper bound for the length of a closed periodic geodesic on the 2-sphere in a neighbourhood of the singular metric obtained

Date: February, 23, 2022.

by gluing two equilateral triangles along their boundary was established in [B1]. The only known curvature-free estimate in dimension higher than two is the result of M. Gromov for the class of 1-essential manifolds (see [G] and also [N], which contains the best currently known bound).

However, there were established a few upper bounds for the length of a shortest periodic geodesic in terms of sectional and Ricci curvature bounds, starting from the results of W. Ballman, G. Thorbergsson, W. Ziller, ([BITZI]), who dealt with the case of $\frac{1}{4}$ -pinched metric of positive sectional curvature on spheres. Other prior results include the case of convex hypersurfaces, due to Croke, ([Cr]) and Treibergs, ([T]), as well as the more recent result for the metrics on closed Riemannian manifolds with diameter bounded above, volume bounded below and sectional curvature bounded below, (see [NR2]), and the very recent results of N. Wu and Z. Zhu dealing with the case of manifolds of dimension four with the bounded Ricci curvature [WZ], as well as the result of I. Adelstein and F. Vargas Pallete ([AVP]), in which they further improve the diameter upper bound for the length of the shortest closed geodesic on a positively curved Riemannian 2-sphere.

In this paper we will prove the following theorem.

Theorem 1.1. *Let M^n be a closed Riemannian manifold of dimension n and $Ric \geq n - 1$. Let $f : S^m \rightarrow \Omega_p M^n$ be (a map of) a sphere of dimension $m \geq 1$ in the space of all piecewise differentiable loops based at some point $p \in M^n$, $\Omega_p M^n$ on M^n . Then there exists a homotopy $H : S^m \times [0, 1]$ such that $H(*, 0) = f$ and $H(*, 1) = \tilde{f}$, where $\tilde{f} : S^m \rightarrow \Omega_p^{8\pi m} M^n$. Here $\Omega_p^{8\pi m} M^n$ is the space of piecewise differentiable loops based at p of length at most $8\pi m$ on M^n . Moreover, if the image of the original map f is contained inside $\Omega_p^L M^n$, one can choose H so that its image is contained in $\Omega_p^{L+8\pi m+o(1)}$.*

Remark: It is easy to see that for closed Riemannian manifolds with $Ric \geq (n - 1)$ and $\pi_1(M^n) \neq \{0\}$, the length of a shortest periodic geodesic, $l(M^n) \leq \pi$. In fact, let C be a free homotopy class. Let $\alpha = \inf \text{length}(\gamma), \gamma \in C$. (The proof of) Bonnet-Myers Theorem implies that the index of any piecewise differentiable curve of length $> \pi$ is at least 1. In particular, any piecewise differentiable closed curve of length $> \pi$ can be continuously shortened. Therefore, $\alpha \leq \pi$. By Cartan's theorem, there exists a closed curve $\tilde{\gamma} \in C$ of length α , which is a closed geodesic, (see [DC]).

In 1959 it was proven by A. Fet and L. Lusternik that on any closed Riemannian manifold M^n there exists at least one periodic geodesic. The proof uses Morse theory on the space ΛM^n of piecewise differentiable closed

curves on M^n . From the homotopy theory it follows that there exists an integer q such that $\pi_q(M^n) = \{0\}$, while $\pi_q(\Lambda M^n) \neq \{0\}$. Note that we can identify points on M^n with constant curves on M^n . Let us consider the Energy functional, E on ΛM^n , and let $f : S^q \rightarrow \Lambda M^n$ be a non-contractible sphere in ΛM^n . Let us try to deform this sphere to M^n , identified with the space of constant curves on M^n , along the integral curves of ∇E . This should be impossible, since if one succeeds, one can then contract this sphere in M^n , thus reaching a contradiction. Therefore, there exists a critical point of E that should prevent one from contracting this sphere to M^n . This critical point is a periodic geodesic on M^n .

We can see that in conjunction with Theorem 1.1 the proof of Fet and Lusternik theorem implies the following result:

Theorem 1.2. *Let M^n be a closed Riemannian manifold of dimension n with the Ricci curvature $Ric \geq n - 1$. Let q be the smallest integer such that $\pi_{q+1}(M^n) \neq \{0\}$.*

Then there exists a periodic geodesic on M^n of length at most $8\pi q \leq 8\pi(n - 1)$.

From the above result it immediately follows that the length of a shortest periodic geodesic on any Riemannian manifold with Ricci curvature bounded from below by $\frac{n-1}{r^2}$ for some positive r is bounded from above by $8\pi r q$, where q is the smallest integer such that $\pi_q(M^n) = \{0\}$, $\pi_{q+1}(M^n) \neq \{0\}$.

Another set of related questions deals with bounding the length of such objects as critical points of the length functional on the space of graphs on a manifold, on the space of closed curves based at a given point and on the space of curves between a fixed pair of points. Those objects are geodesic nets, geodesic loops and geodesics respectively. Many curvature-free upper bounds are known in the case of nets, loops and segments, starting from the result of S. Sabourau, who established the first curvature-free diameter and volume upper bounds for the length of the shortest geodesic loop on a closed Riemannian manifold, (see [S2]). For other results of similar nature see [B], [NR3], [NR4], [NR5], [NR6], [NR7], [R2], [R3], [R4], [R5]. Another result that immediately follows from Theorem 1.1 is the following quantitative version of J. P. Serre's theorem that states that for any pair of points $p, q \in M^n$ of a closed Riemannian manifold M^n there exist infinitely many geodesics that connect these points. Note that when $p = q$, this result implies that at any point $p \in M^n$, there exists infinitely many geodesic loops, (see [Se]). The first effective proof of this theorem was presented by A. Schwartz, who in particular demonstrated that given any pair of points $p, q \in M^n$, where M^n is a closed Riemannian manifold, there exists at least k geodesics connecting them of length at most $c(M^n)k$, where $c(M^n)$

depends on a Riemannian metric on M^n , (see [Sc]). Together with A. Nabutovsky, we have shown that in the case of a Riemannian 2-sphere, one can take $c(M^n) = 22$, (20 when $p = q$), (see [NR5], [NR6]). These bounds were recently significantly improved by H. Y. Cheng in [Ch].

Theorem 1.3. *Let M^n be a closed Riemannian manifold of dimension n with Ricci curvature $\geq n - 1$. Then*

- (1) *given any point $p \in M^n$ there exists at least k geodesic loops based at p of length at most $16\pi(n - 1)k$;*
- (2) *given a pair of points $p, q \in M^n$ there exist at least k geodesics of length at most $\pi(16k(n - 1) + 1)$.*

Theorem 1.3 improves the previously known bound for the length of the first k geodesic loops based at p from [NR7] in the case of the manifolds with a positive Ricci curvature. While in the theorem in [NR7] that states that on any closed Riemannian manifold there exist at least k geodesic loops of length at most $4nk^2d$, the bound is quadratic in k , in case of the manifolds with positive Ricci curvature, one can improve this to be a linear bound in k .

2. MAIN IDEAS

Let M^n be a closed Riemannian manifold. The existence of a closed geodesic theorem of Fet and Lyusternik, as well as that of infinitely many geodesics between a pair of points of Serre rely on the Morse Theory on ΛM^n and $\Omega_{p,q}M^n$ respectively. Thus, as we have demonstrated the quantitative versions of these theorems can be obtained by constructing of the short spheres of an appropriate dimension in the given spaces of curves. This, in turn is obtained from obtaining a relevant sweep-out of the manifold. While, it has been demonstrated that one cannot hope to construct such sweep-outs in the general situation, (see [FK], [L]), usually such sweep-outs are prevented by the existence of stationary objects of index zero. However, in our case of manifolds with a positive Ricci curvature, we demonstrate such short sweep-outs are indeed possible.

The proof of Theorem 1.1 has the following two main ingredients.

- (1) The first ingredient is Bonnet- Myers Theorem, which implies that when M^n is a Riemannian manifold with $Ric \geq n - 1$, the diameter d of M^n is $\leq \pi$. It also implies that geodesics of length $> \pi$ between any pair of points $p, q \in M^n$ has index ≥ 1 . This, in particular, is true for geodesic loops.
- (2) The second ingredient is the idea introduced in [NR7] that can be informally phrased as the following observation: whenever one can shorten fixed point loops via loops of controlled length, one can also shorten families of fixed point loops over loops of controlled length. We would like to stress, that the families of loops can be shortened even if the fixed point

homotopies are not continuous with respect to the original curves. In other words, it can happen that two “close” loops are shortened by homotopies that are “far” from each other.

The following theorem (Theorem 2.1) is a slight modification of Theorem 1.1 in [NR7], that can be restated to say that if for some positive integer k and some point p in a closed Riemannian manifold M^n no locally minimizing geodesic loops based at p have length in the interval $(2(k-1)d, 2kd]$, then every map $f : S^m \rightarrow \Omega_p M^n$ is homotopic to $\tilde{f} : S^m \rightarrow \Omega_p^L M^n$, where $L = ((4k+2)m + (2k-3))d + v$. Here d is the diameter of M^n , n is the dimension, $\Omega_p M^n$ denotes the space of piecewise differentiable loops based at p , whereas $\Omega_p^L M^n$ denotes the of piecewise differentiable loops based at p of length at most L . While in the statement of the above theorem, we assumed that k is a positive integer, it is easy to see that the conclusion of the theorem will also hold for any positive real number k .

Remark. Note that if we then take $k = \frac{\pi}{2d} + 1$ (d being the diameter of M^n as before) then by Bonnet-Myers Theorem, there will be no locally minimizing loops based at any $p \in M^n$ with length greater than π . Thus, this relaxed hypothesis of Theorem 1.1 in [NR2] is satisfied for such a k . It then immediately follows that for an arbitrary small positive v the length of a shortest periodic geodesic on M^n is at most

$[(4(\frac{\pi}{2d} + 1) + 2)q + (2(\frac{\pi}{2d} + 1) - 3)]d \leq [(\frac{2\pi}{d} + 6)q + (\frac{\pi}{d} - 1)]d + v \leq 8\pi q + \pi - d + v \leq 9\pi q + v$. This is only a slightly worse bound than stipulated in our theorem.

One can, however, use methods of [NR7] to prove a slightly stronger results than Theorem 1.1 in [NR7].

Theorem 2.1. *Let M^n be a closed Riemannian manifold of dimension n and diameter d . Suppose $d \leq a$ for some positive real number a . Let $p \in M^n$ be an arbitrary point of M^n and k be some positive real number for which no geodesic loop based at p of index zero has length l such that $2(k-1)a < l \leq 2ka$. Then every map $f : S^m \rightarrow \Omega_p M^n$ is homotopic to a map $\tilde{f} : S^m \rightarrow \Omega_p^L M^n$, where $L = ((4k+2)m + (2k-3))a + v$, where v is an arbitrarily small positive number.*

Then Theorems 1.1 and 1.2 immediately follow from Theorem 2.1:

Proof of Theorems 1.1 and 1.2. As we observed, Bonnet-Myers theorem implies that closed Riemannian manifolds with $Ric \geq n-1$ satisfy the hypothesis of Theorem 2.1 with $k = \frac{3}{2}$ and $a = \pi$. Thus, we obtain Theorem 1.1. Now let q be the smallest positive integer number such that $\pi_{q+1}(M^n)$ is non-trivial. Consider a non-contractible map $S^{q+1} \rightarrow M^n$ and the corresponding map $S^q \rightarrow \Omega_p M^n$, where p is any point in M^n . We saw that if $q = 0$, the length of the shortest periodic geodesic does not exceed π , so

we can assume that $q \geq 1$. Apply Theorem 1.1 to conclude that this map is homotopic to a map $S^q \rightarrow \Omega_p^{8\pi q} M^n \subset \Lambda^{8\pi q} M^n$. Now the proof of the Fet-Lyusternik theorem immediately implies that the length of a shortest periodic geodesic on M^n is at most $8\pi q$. \square

Now we will sketch the proof of Theorem 1.3 from Theorem 2.1.

Proof of Theorem 1.3. The proof of Theorem 1.3 likewise directly follows from Theorem 1.1 as follows: Rational homotopy theory implies the existence of a non-trivial even-dimensional cohomology class of dimension $\leq 2(n-1)$ on a path/loop space on a closed Riemannian manifold M^n , whose cup powers are not trivial, (see [NR7], [FHT]). The classes generated by those cup powers will correspond to the different geodesic paths/loops in a Morse situation. Otherwise, if the two classes happen to correspond to the same critical point, Lyusternik and Schnirellmann theory would imply the existence of the whole critical level. As it was further demonstrated by A. Schwartz in [Sc], one can consider dual homology classes under the Pontryagin powers instead of the cohomology classes under the cup powers. Thus, if one can represent the corresponding class by short segments/loops, it will further imply the existence of short paths/loops in all dimensions, (see [NR7]). Now we again observe that Bonnet-Myers theorem and Theorem 2.1 imply that this class can be represented by loops of length $\leq 16\pi(n-1)$ (correspondingly, paths $\leq \pi(16(n-1)+1)$). The Pontryagin powers can be represented by loops of length $\leq 16\pi(n-1)k$ (correspondingly, paths of length $\leq \pi(16(n-1)k+1)$). \square

3. SUMMARY OF THE PROOF OF THEOREM 2.1

The proof of Theorem 2.1 is very similar to the proof of Theorem 1.1 of [NR7]. Therefore, only the summary of the proof will be included here for the paper to be self-contained.

The starting point of the proof is the following effective version of the elementary topological lemma (Lemma 2.1 from [NR7]) and its higher dimensional generalization (Lemma 2.2 from [NR7]). Let $\alpha : [0, 1] \rightarrow M^n$ be a piecewise differentiable path in M^n . Then $\bar{\alpha}$ will denote $\alpha(1-t)$ in the statement of the lemma and thereafter in the paper. Moreover, if β is another path in M^n , such that $\alpha(1) = \beta(0)$, then $\alpha * \beta$ will denote their product.

Informally, the following lemma can be viewed as follows: consider two edges starting and ending at the same pair of points p, q . By looking at a concatenation of these edges we can view them as a loop based at p . Then if this loop is path homotopic to another loop based at p via loops of short length, there is a ‘‘short’’ path homotopy between the first edge and a concatenation of the loop followed by the second edge.

Lemma 3.1. *Let γ_1, γ_2 be two paths on a complete Riemannian manifold M^n of length l_1, l_2 respectively, such that $\gamma_1(0) = \gamma_2(0) = p$, and $\gamma_1(1) = \gamma_2(1) = q$. Let $\alpha = \alpha_0 = \gamma_1 * \bar{\gamma}_2$. This is a loop based at point p . Suppose further that there exists a path homotopy $H(t, \tau)$ between α_0 and a loop α_1 over the loops α_τ of length at most l_3 . Then there exists a path homotopy $\tilde{H}(t, \tau)$ between γ_1 and $\alpha_1 * \gamma_2$ over curves of length at most $l_3 + l_2$. Similarly, γ_2 is path homotopic to $\bar{\alpha}_1 * \gamma_1$ over the curves of length at most $l_1 + l_3$.*

Proof. We are going to construct a homotopy $\tilde{H}(t, \tau)$ between γ_1 and $\alpha_1 * \gamma_2$ as follows. For the illustration of the proof see Fig. 1. First note that γ_1 is path homotopic to $\gamma_1 * \bar{\gamma}_2 * \gamma_2$. The typical curve in this homotopy consists of γ_1 followed by a longer and longer segment of γ_2 taken twice with the opposite orientation. That is, one goes a short distance from p towards q along γ_2 , and then goes back to q , (see Fig. 1 (b), (c), (d)). The curves in this homotopy are bounded by $l_1 + 2l_2 \leq l_3 + l_2$. Next, $\gamma_1 * \bar{\gamma}_2$ is path homotopic to α_1 via the curves α_τ of length $\leq l_3$. Therefore, the path $\gamma_1 * \bar{\gamma}_2 * \gamma_2$ is path homotopic to $\alpha_1 * \gamma_2$ along the curves $\alpha_\tau * \gamma_2$ of length at most $l_2 + l_3$; (see Fig. 1 (d,e)). \square

Remark: One can apply Lemma 3.1 in the situation, when α_1 is a constant path at p . In this case the resulting homotopy will be a short path homotopy between γ_1 and γ_2 .

Below we will state the higher dimensional generalization of this lemma.

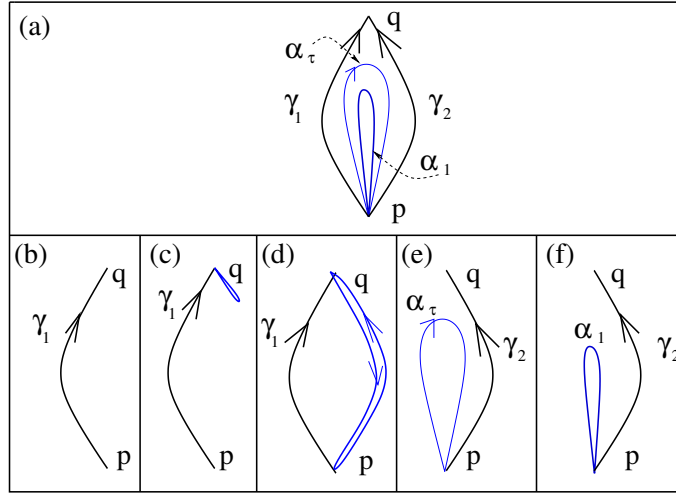

FIGURE 1. Illustration of the proof of Lemma 3.1

Let $p, q \in M^n$ be a pair of points on a complete Riemannian manifold of dimension n , and let $\Omega_{p,q}^L M^n$ be the space of piecewise differentiable curves on M^n of length at most L .

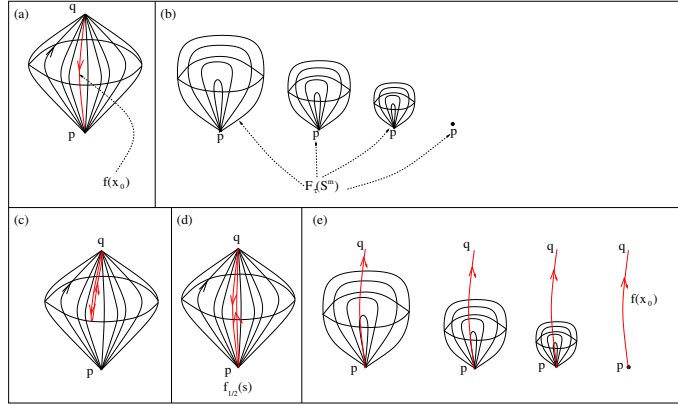

FIGURE 2. Illustration of the proof of Lemma 3.2

Lemma 3.2. *Let $f : S^m \rightarrow \Omega_{p,q}^L M^n$ be a continuous map from the m -dimensional sphere into $\Omega_{p,q}^L M^n$. Let l be the length of the curve $f(x_0)$ for some $x_0 \in S^m$ (see Fig. 2 (a)).*

*Consider a sphere in the space of loops based at p that is formed by concatenating the paths in the image of f by $f(x_0)$. That is we define $F : S^m \rightarrow \Omega_p^{L+l} M^n$ as $F(x) = f(x) * f(x_0)$. Then, if there exists a homotopy $F_\tau : S^m \rightarrow \Omega_p^{L+l} M^n$ contracting the sphere to p (See Fig. 2 (b)), then there exists a homotopy $f_\tau : S^m \rightarrow \Omega_{p,q}^{L+2l} M^n$, $\tau \in [0, 1]$, between $f = f_0$ and the constant map f_1 of S^m identically equal to $f(x_0)$ (see Fig. 2 (c)-(e)).*

Proof. The homotopy is constructed first by attaching to each curve $f(x)$ longer and longer segment of $f(x_0)$ taken twice with different orientations. Eventually, we will attach the curve $\overline{f(x_0)} * f(x_0)$. Formally speaking, f is homotopic to $f_{\frac{1}{2}}$ defined as $f_{\frac{1}{2}}(s) = f(x) * f(x_0) * f(x_0) = F(x) * f(x_0)$.

Next we contract the sphere F using the homotopy F_t , $t \in [0, 1]$, while the curve $f(x_0)$ that is attached to each loop stays fixed, (see Fig. 2 (c)). \square

The main tool used in Theorem 1.1 is a curve shortening process described in the following theorem

Theorem 3.3. *Let M^n be a closed Riemannian manifold of diameter d . Suppose that $d \leq a$ for some positive real number a . Let $\alpha = \alpha(t)$ be a curve on M^n connecting an arbitrary pair of points $p, q \in M^n$. Assume that there exists an interval $(l, l + 2a + \delta]$, such that there are no geodesic loops based at $p \in M^n$ with length in this interval of index zero with respect to the length functional on $\Omega_p M^n$ for some positive δ . Then there exists a curve $\tilde{\alpha} = \tilde{\alpha}(t)$ of length $\leq l + a$ connecting p and q and a path homotopy between α and $\tilde{\alpha}$ such that the lengths of all curves in this path homotopy are at most $L + 2a$.*

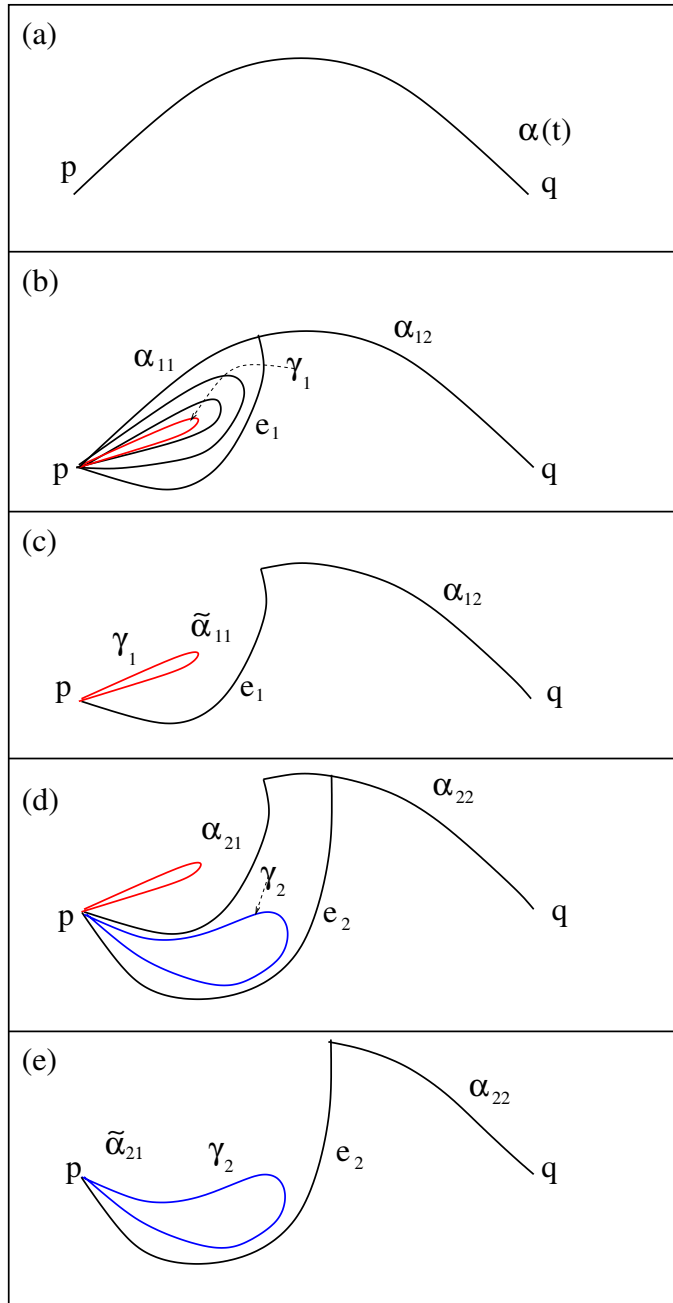

FIGURE 3. Curve shortening process

Moreover, there exists a one-parameter family of curves: γ_s^α that continuously connect p with points of $\alpha(t)$ satisfying the following conditions:
 (a) length $(\gamma_s^\alpha) \leq l + 3a + \delta$;

(b) for every s , γ_s^α connects p with $\alpha(\tau(s))$, where $\tau(s)$ is a function of s satisfying $\tau(s_1) \leq \tau(s_2)$ whenever $s_1 < s_2$;

(c) There exists two partitions of $[0, 1]$, $P = \{0 = t_0^\alpha < t_1^\alpha < \dots < t_{k^\alpha}^\alpha = 1\}$ and $Q = \{0 = r_0^\alpha < r_1^\alpha < \dots < r_{2k^\alpha}^\alpha = 1\}$, such that

(1) the endpoint of γ_s^α remains constant for $s \in [r_{2i-1}^\alpha, r_{2i}^\alpha]$;

(2) for every $s \in [r_{2i}^\alpha, r_{2i+1}^\alpha]$, the endpoint of γ_s^α is $\alpha(t)$ for some $t \in [t_i^\alpha, t_{i+1}^\alpha]$. Moreover, $\tau(s)$ is strictly increasing on $[r_{2i}^\alpha, r_{2i+1}^\alpha]$, and $\tau([r_{2i}^\alpha, r_{2i+1}^\alpha]) = [t_i, t_{i+1}]$.

(3) the length of $\gamma_{s_{2i}^\alpha}^\alpha \leq l + a$ for all i .

(4) the curve $\gamma_{r_{2i}^\alpha}^\alpha = \gamma_1^\alpha$ is the final curve in the curve shortening above.

Proof of Theorem 3.3.

Let $\alpha : [0, L] \rightarrow M^n$ be a curve of length L parametrized by the ar-length (see Fig. 3 (a)). If $L \leq l + a$, then we are done. Suppose $L > l + a$. Consider the segment $\alpha|_{[0, l+a+\delta]}$, where δ is specified in the hypothesis of the theorem, (or possibly smaller, if the whole curve α is shorter than that) of α , which we will denote $\alpha_{11} = \alpha_{11}(t)$, and the segment $\alpha|_{[l+a+\delta, L]}$ denoted $\alpha_{12} = \alpha_{12}(t)$ (see Fig. 3 (b)).

Let us connect points p and $\alpha(l + a + \delta)$ by a minimal geodesic, e_1 (of length $\leq d \leq a$) (see Fig. 3 (b)). Then curves α_{11} and e_1 form a loop $\alpha_{11} * \bar{e}_1$ of length $\leq l + 2a + \delta$ based at p .

Consider a (possibly trivial) shortest loop γ_1 of index zero that can be connected with $\alpha_{11} * \bar{e}_1$ by a length non-increasing path homotopy, (see Fig. 3 (b)). The length of γ_1 is at most l by our assumption.

By Lemma 3.1, α_{11} is path homotopic to the curve $\gamma_1 * e_1 = \tilde{\alpha}_{11}$ along the curves of length at most $l + 3a + \delta$ and, thus, the original curve α is homotopic to a new curve $\tilde{\alpha}_{11} * \alpha_{12}$ along the curves of length at most $L + 2a$, (see Fig. 3 (c)).

Note that the length L_1 of this new curve $\alpha_1 = \tilde{\alpha}_{11} * \alpha_{12}$ is at most $L - \delta$. Assuming that L_1 is still greater than $l + a$, we repeat the process again: We parametrize α_1 by its arlength. Now, let $\alpha_{21} = \alpha_1|_{[0, l+d+\delta]}$ and $\alpha_{22} = \alpha_1|_{[l+d+\delta, L_1]}$, (see Fig. 3 (d)). If it so happens that the length L_1 of α_1 is less than $l + a + \delta$, then we use $L_1 - l - a$ as the new value of δ , but otherwise keep the old value of δ .

Connect the points p and $\alpha_1(l + d + \delta)$ by a minimal geodesic segment e_2 , (see Fig. 3 (d)). Then α_{21} and e_2 form a loop $\alpha_{21} * \bar{e}_2$ based at p of length at most $l + 2a + \delta$.

Again, we use the length shortening to contract this loop to the shortest possible loop γ_2 of index 0 keeping the vertex fixed, (see Fig. 3 (e)). By our assumption the length of γ_2 is at most l .

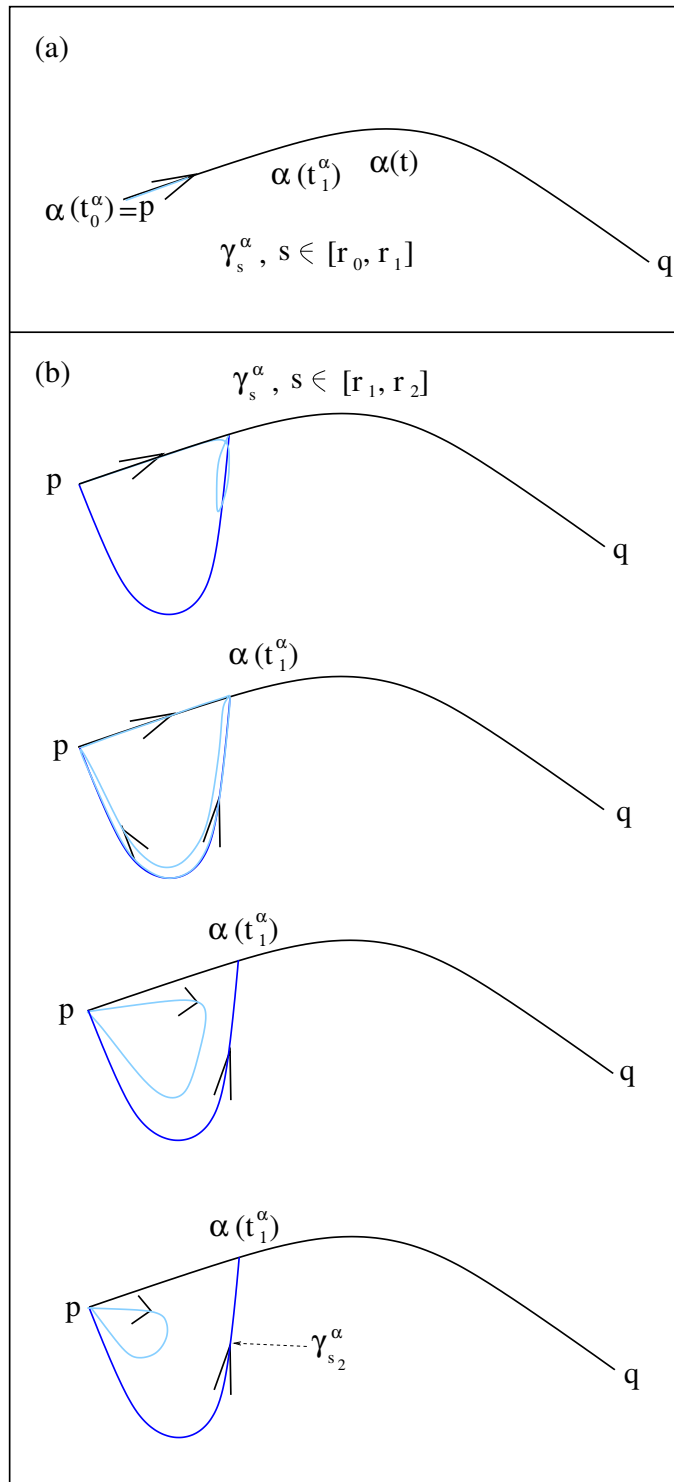

FIGURE 4. Constructing 1-parameter family of curves: γ_s^α

Thus, α_{21} is path-homotopic to $\tilde{\alpha}_{21} = \gamma_2 * \sigma_2$ along the curves of length at most $l + 3a + \delta$. It follows that α_1 is homotopic to $\alpha_2 = \tilde{\alpha}_{21} * \alpha_{22}$ along the curves of length at most $L + 2a$, (see Fig. 3 (e)).

Let k be the number of steps to sufficiently shorten $\alpha(t)$. One can see that $k = \lfloor \frac{L-l-a}{\delta} \rfloor + 1$.

In the process of shortening the original curve $\alpha(t)$ we are constructing the axillary curves γ_s^α in the following way: we connect p with the points of $\alpha(t)$ by minimizing geodesics: e_1, e_2, \dots, e_k . Each points that are distance δ apart on $\alpha(t)$ are being connected, started from the point $\alpha(l + a + \delta)$. We next construct γ_s^α by repeated application of Lemma 3.1. As we have shown in the process of the proof, the resulting family of curves γ_s^α continuously connects p with points of $\alpha(t)$ satisfying the following conditions:

- (a) length $(\gamma_s^\alpha) \leq l + 3a + \delta$;
- (b) for every s , γ_s^α connects p with $\alpha(\tau(s))$, where $\tau(s)$ is a function of s satisfying $\tau(s_1) \leq \tau(s_2)$ whenever $s_1 < s_2$;
- (c) There exists two partitions of $[0, 1]$, $P = \{0 = t_0^\alpha < t_1^\alpha < \dots < t_{k^\alpha}^\alpha = 1\}$ and $Q = \{0 = r_0^\alpha < r_1^\alpha < \dots < r_{2k^\alpha}^\alpha = 1\}$, such that
 - (1) the endpoint of γ_s^α remains constant for $s \in [r_{2i-1}^\alpha, r_{2i}^\alpha]$;
 - (2) for every $s \in [r_{2i}^\alpha, r_{2i+1}^\alpha]$, the endpoint of γ_s^α is $\alpha(t)$ for some $t \in [t_i^\alpha, t_{i+1}^\alpha]$. Moreover, $\tau(s)$ is strictly increasing on $[r_{2i}^\alpha, r_{2i+1}^\alpha]$, and $\tau([r_{2i}^\alpha, r_{2i+1}^\alpha]) = [t_i, t_{i+1}]$.
 - (3) the length of $\gamma_{s_{2i}^\alpha}^\alpha \leq l + a$ for all i , since each of those curves consist of a geodesic e_i of length at most a with a loop attached of length at most l .
 - (4) the curve $\gamma_{r_{2i}^\alpha}^\alpha = \gamma_1^\alpha$ is the final curve in the curve shortening above.

□

On Figure 4, we have depicted the curves γ_s^α , where $s \in [r_0, r_1]$, (Fig. 4(a)) and for $s \in [r_1, r_2]$, (Fig. 4 (b)). Note that for $s \in [r_0, r_1]$, γ_s^α will be just longer and longer segments of α , whereas $\gamma_s^\alpha, s \in [r_1, r_2]$ will be obtained via Lemma 3.1. Therefore, they will be the curves interpolating between α_{11} and $\gamma_1 * e_1$. Note also that $\gamma_2^\alpha = \gamma_1 * e_1$. Hence, its length will be at most the length of the loop γ_1 , which is at most $l + a$ plus the length of the geodesic e_1 , which is at most a .

Note also that the partition P^α can be chosen as fine as desired.

The one-parameter family γ_s^α is schematically pictured on Fig. 5 (a), while Fig. 5(b) depicts the typical curves in the homotopy $H_\alpha(s)$ between α and γ_1^α . One can see that a typical curve in the homotopy consists of γ_s^α followed by the tail part of the original curve α that gets shorter and shorter. From now on we will refer to these curves as partial shortenings of α . Suppose we would have applied our curve shortening algorithm to a segment of α , $\alpha|_{[0,x]}$ for some $x \in [0, 1]$ as it is depicted on Fig. 5 (c)? It is easy to see that in this case we will obtain a 1-parameter subfamily of the original

family γ_s^α , that is we will get only the first portion of the curves that connect p with the points of $\alpha(t)$ for $t \leq x$.

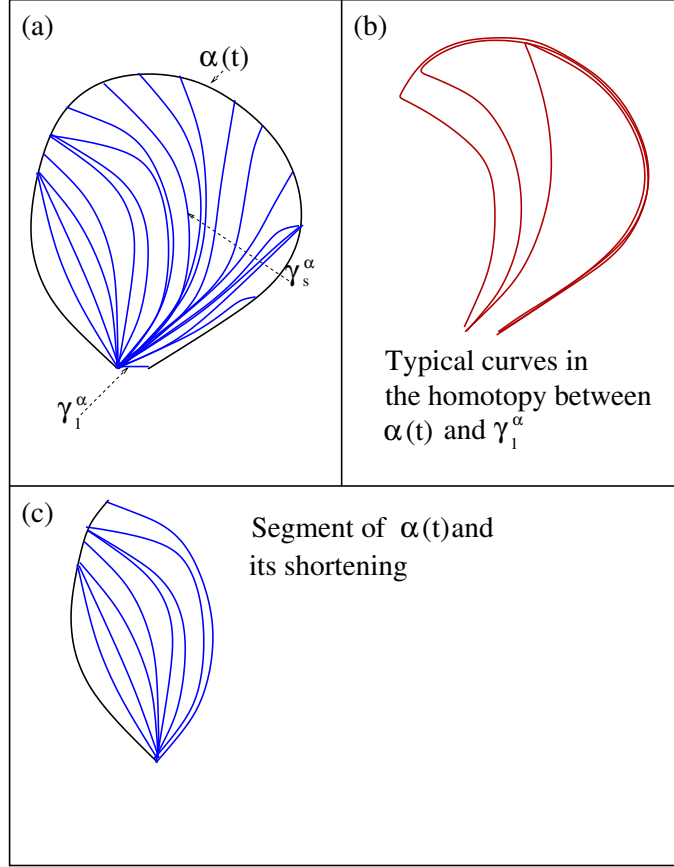

FIGURE 5. Typical curves of the homotopy between α and γ_1^α

Next we will prove the following theorem, which implies Theorem 2.1 in the case of $m = 1$ by taking $l = 2(k-1)a$ and $a = \pi$, which in turn implies Theorem 1.2 if we take $k = \frac{3}{2}$.

Theorem 3.4. *Let M^n be a closed Riemannian manifold of diameter $d \leq a$ for some positive real number a . Let $p \in M^n$. Assume that there exists a positive number l such that the length of every geodesic loop that provides a local minimum for the length functional on $\Omega_p M^n$ is not in the interval $(l, l + 2a + \delta]$ for any arbitrarily small δ . Consider a continuous map $f : [0, 1] \rightarrow \Omega_p M^n$, (see Fig. 6 (a)) such that the lengths of both $f(0)$ and $f(1)$ are at most $l + a$. Then f is path homotopic to $\tilde{f} : [0, 1] \rightarrow \Omega_p^{3l+5a+o(1)} M^n$. Moreover, assume that for some L the image of f is contained in $\Omega_p^L M^n$.*

Then one can choose a path homotopy between f and \tilde{f} so that its image is contained in $\Omega_p^{L+(5a+3l)+o(1)}M^n$.

Proof.

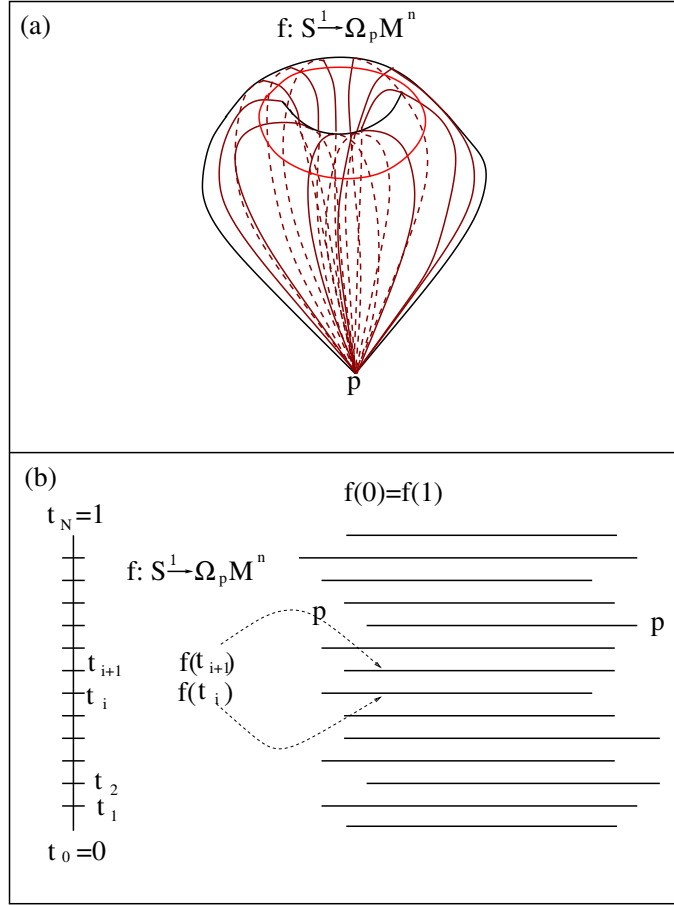

FIGURE 6. Partition of the map $f : S^1 \rightarrow \Omega_p M^n$ into small intervals

Without any loss of generality we can assume that f is Lipschitz. Otherwise, we can make it Lipschitz by an arbitrarily small perturbation. We will begin by "discretizing" this map in the following sense: Let $K = \{t_0 = 0 < t_1 < t_2 < \dots < t_N = 1\}$ be a partition of the interval $[0, 1]$, such that $\max_i \max_{\tau \in [0, 1]} \text{length}(f(t)|_{t \in [t_{i-1}, t_i]}(\tau)) \leq \varepsilon$ for a small $\varepsilon > 0$. We will eventually let ε go to 0. Figure 6 (b) depicts this discretized map $f : S^1 \rightarrow \Omega_p M^n$, where for simplicity of the picture, we draw S^1 and the loops $f(t_i)$ as the segments, keeping in mind that (1) $f(0) = f(1)$ and that $f(t_i)(0) = f(t_i)(1) = p$ for all $i = 0, \dots, N$.

We will now construct a new map $\tilde{f} : S^1 \rightarrow \Omega_p M^n$ and will show that it is homotopic to the original map $f : S^1 \rightarrow \Omega_p M^n$. We will do it as follows: first we will replace the loops $f(t_i)$ by the short loops that we obtain via the curve shortening proven in Theorem 3.3. Let us denote $f(t_i)$ by α_i and the "replacement" loops by β_i . We will "fill in" between β_i and β_{i+1} by contracting $\beta_i * \bar{\beta}_{i+1}$ to p over the loops based at p of length at most $2l + 4a + \delta + \varepsilon$, next we will apply Lemma 3.1 to get a path homotopy between β_i and β_{i+1} over the loops of length at most $3l + 5a + 2\delta + \varepsilon$. In the construction that follows we will use that the "vertical" curves $f(t)|_{t \in [t_i, t_{i+1}]}(\tau)$ that connect "horizontal" curves $f(t_i)$ are short.

Let us now consider the two loops β_i, β_{i+1} based at the point p . Despite the fact that α_i and α_{i+1} are loops based at p , β_i and β_{i+1} might not be the trivial loops, but their length will be at most l , (and not $l + a$ in the case of segments between distinct points p and q). Regardless, of whether or not both β_i , and β_{i+1} , or one of the above loops are trivial, we will consider a specific homotopy that is depicted on Fig. 7 that begins and ends with a constant curve based at p . Note that by Theorem 3.3 there exists two 1-parameter families that will be denoted here as γ_s^i and γ_s^{i+1} that continuously connect p with the points of α_i and α_{i+1} respectively. Recall that $\beta_i = \gamma_1^i$, and $\beta_{i+1} = \gamma_1^{i+1}$, (see Fig. 7 (a)). We will now consider the loop $\beta_i * \bar{\beta}_{i+1}$ (see Fig. 7 (b)), (in fact, this curve is a concatenation of two loops based at p). Note that because the distance between α_i and α_{i+1} is at most ε , they are continuously connected by the family of curves $f(t)|_{t \in [t_i, t_{i+1}]}(\tau)$, $\tau \in [0, 1]$.

Then there exists a path homotopy between $\beta_i * \bar{\beta}_{i+1}$ and p through the loops $\gamma_{s_1}^i * f(t)|_{t \in [t_{i-1}, t_i]}(\tau) * \bar{\gamma}_{s_2}^i$. For this path homotopy to be defined, the endpoints of $\gamma_{s_1}^i$ and $\gamma_{s_2}^{i+1}$ should be sufficiently ε -close to each other, and to move continuously along $\alpha_i(\tau)$ and $\alpha_{i+1}(\tau)$ respectively. Specifically, we want that $\gamma_{s_1}^i(1) = f(t_i)(\tau)$ and $\gamma_{s_2}^{i+1}(1) = f(t_{i+1})(\tau)$, or, equivalently, $\tau_i(s_1) = \tau_{i+1}(s_2) = \tau$. Here $\tau_i(s)$ and $\tau_{i+1}(s)$ denote the increasing functions from $[0, 1]$ to $[0, 1]$ for the curves α_i and α_{i+1} . Recall that for every z , the inverse image $\tau_j^{-1}(z)$ is either a point or a closed interval. The inverse image is an interval only when z is a boundary point for one of the partitions P^{α_i} or $P^{\alpha_{i+1}}$. Without loss of generality, we may assume that these partitions are disjoint, so that the loops of the form $\gamma_{s_1}^i * f(t)|_{t \in [t_i, t_{i+1}]}(\tau) * \bar{\gamma}_{s_2}^{i+1}$ form a 1-parametric family. This family is the desired homotopy.

Note also that, when $\tau_1(s_1)$ is not a boundary point of P^{α_i} , then the length of $\gamma_{s_1}^i \leq l + a + \delta$. Since P^{α_i} and $P^{\alpha_{i+1}}$ are disjoint, if $\tau_1(s_1) = \tau = \tau_2(s_2)$, then at least one of the curves $\gamma_{s_1}^i$ or $\gamma_{s_2}^{i+1}$ is short. That is either the length of $\gamma_{s_1}^i$ is at most $l + a + \delta$ and/or the length of $\gamma_{s_2}^{i+1} \leq l + a + \delta$. Therefore, each curve in the homotopy consists of a curve of length at most $(l + a + \delta) + (l + 3a + \delta) + (\varepsilon)$. The first summand here is the length of

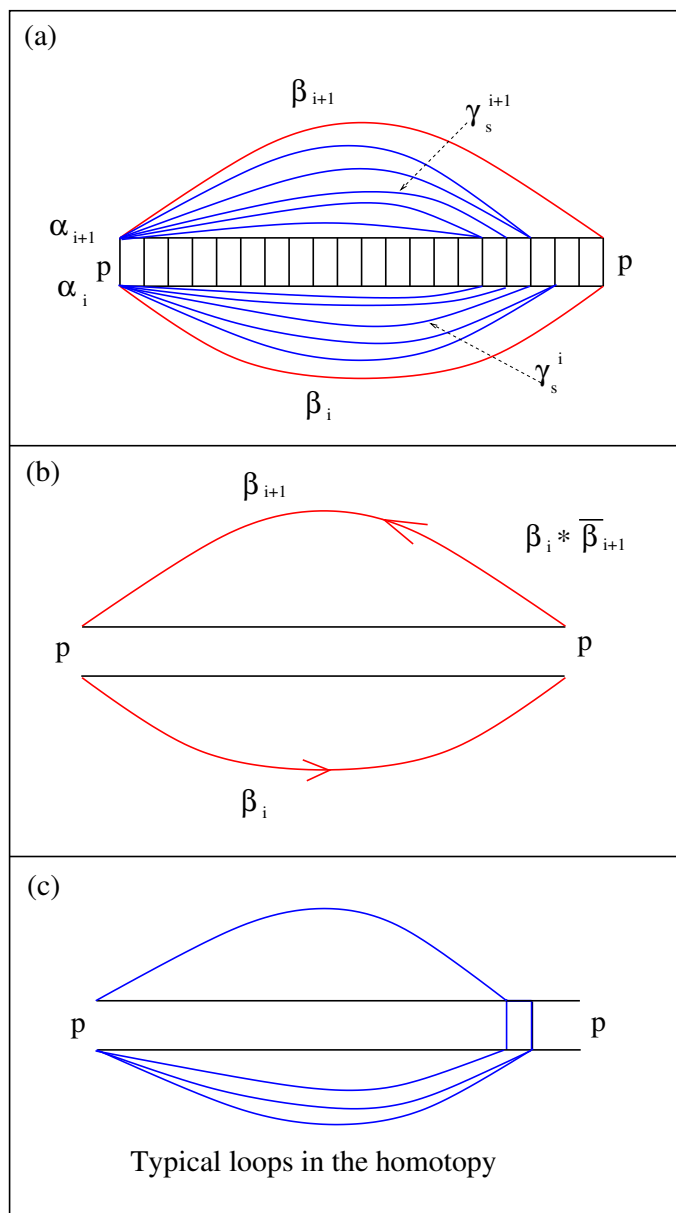
FIGURE 7. Contracting $\beta_i * \bar{\beta}_{i+1}$

a shorter curve, the second summand is the length of a potentially longer curve, and ε is the length of the vertical curve connecting the points on the two original loops. Thus the total length of the loops in the homotopy is at most $2l + 4a + o(1)$. Here and thereafter, $o(1)$ will denote the terms that are bounded by a linear function of δ and ε that can be made arbitrarily small. The typical loops in this homotopy are depicted on Fig. 7(c).

It remains to prove that the constructed path \tilde{f} in $\Omega_p M^n$ is path homotopic to f .

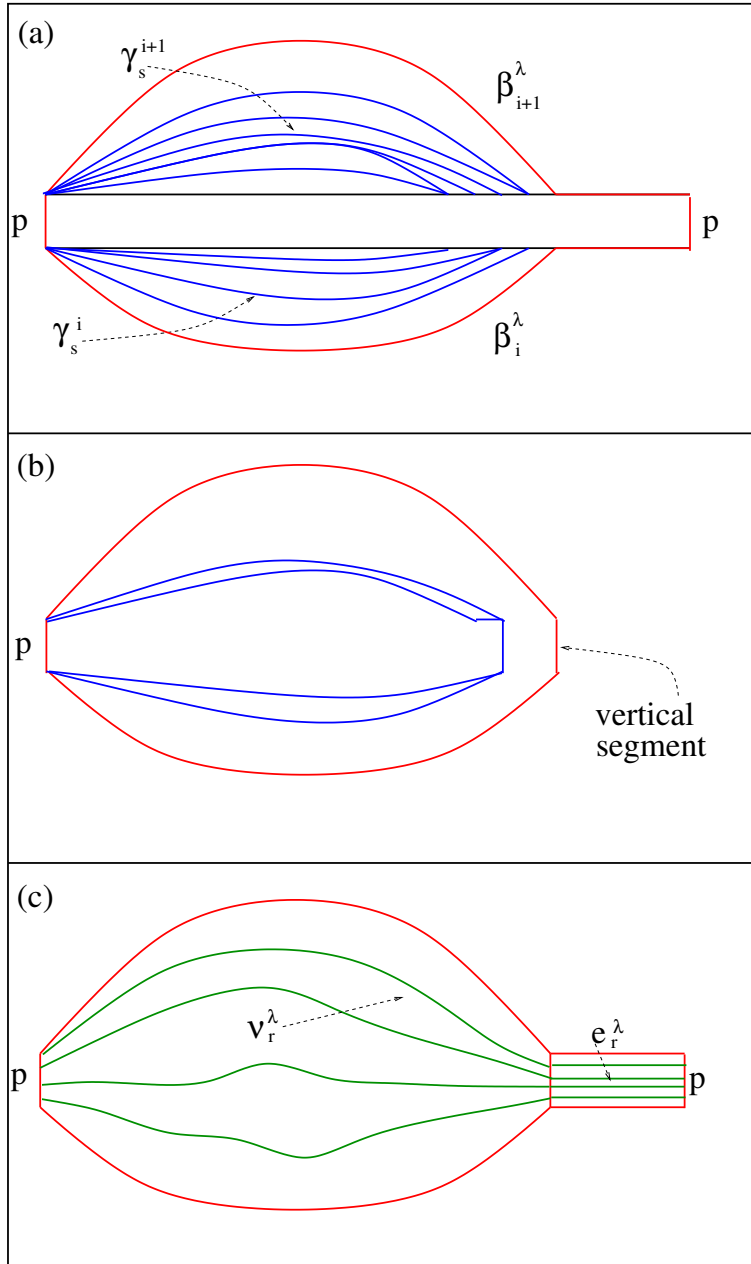

FIGURE 8. Homotopy between f and \tilde{f}

Here is the construction of a path homotopy G between \tilde{f} and f : $G(1) = \tilde{f}$, $G(0) = f$. The main idea to define $G(\lambda)$ at $\lambda \in (0, 1)$ is to not shorten

$f(t_i)$ (for all i) all the way using the construction in the proof of Theorem 3.3, as we did above, but to use the partial shortenings discussed in the proof of Theorem 3.3 instead. We then define β_i^λ , which will consist of two arcs. One arc will be γ_λ^i that connects p with $\alpha_i(\tau(\lambda))$ and the second arc is the arc of α_i that starts at $\alpha_i(\tau(\lambda))$ and ends at $\alpha_i(1)$ (see Fig. 8 (a)). To construct the desired path homotopy G between f and \tilde{f} in $\Omega_p M^n$ at the moment λ we replace all long curves α_i not by β_i but by β_i^λ . In other words, $G(\lambda)(t_i) = \beta_i^\lambda$. Let us consider the two curves β_i^λ and β_{i+1}^λ . We will construct path homotopy between them that satisfies the following properties:

- (a) It varies continuously with λ ;
- (b) When $\lambda = 0$ we get the original homotopy between $f(t_i)$ and $f(t_{i+1})$;
- (c) When $\lambda = 1$, we get our homotopy between β_i and β_{i+1} constructed above.

To construct this homotopy we will assume that both α_i and α_{i+1} are parametrized by a function $\tau(s)$ in such a way that the points $\gamma_s^i(1)$ and $\gamma_s^{i+1}(1)$ are ε -close to each other. The existence of such a synchronized parametrization for all the curves in the original homotopy $f(t)$ was discussed in Section 3.4 of [NR7]. We will now join the corresponding points of α_i and α_{i+1} by a short vertical segment, (see Fig. 8). $f(t)|_{t \in [t_i, t_{i+1}]}(\tau(s))$. Now we can form loops $\gamma_s^i * f(t)|_{t \in [t_i, t_{i+1}]}(\tau(s)) * \bar{\gamma}_s^{i+1}$ for all $s \leq \lambda$, as before. These loops will be the loops in a homotopy that contracts the loop $\gamma_\lambda^i * f(t)|_{t \in [t_{i-1}, t_i]}(\tau(\lambda)) * \bar{\gamma}_\lambda^{i+1}$ to a point.

The typical curves of this homotopy are depicted on Fig. 8(b).

Let us denote the vertical segment that connects the endpoints of γ_s^i and γ_s^{i+1} as $g_{\tau(s)}(r)$. We can now construct the curves $G(\lambda)(t)$ for $t \in [t_i, t_{i+1}]$ in the following way. Note that by Lemma 3.1 there exists a path homotopy between γ_λ^i and $\gamma_\lambda^{i+1} * g_{\tau(\lambda)}(r)$ over the curves of length at most $6a + 3l + o(1)$. This is not quite the homotopy we need. Instead, we need the existence of a homotopy between γ_λ^i and γ_λ^{i+1} over the curves ν_r^λ of length at most $6a + 3l + o(1)$ such that $\nu_r^\lambda(0) = p$ and $\nu_r^\lambda(1) = g_{\tau(\lambda)}(r)$. The existence proof of such a homotopy is a small modification of the proof of Lemma 3.1. Thus, it will not be included here. We can now extend each such segment ν_r^λ by a segment e_r^λ , which is a tail of the curve from the original homotopy $f(t)$. Thus, when $\lambda = 0$, we can see that the curves f_i and f_{i+1} will be unchanged, and so will be the curves interpolating between $f(t)$ and $f(t_{i+1})$. Those, will simply be the curves $f(t)$, whereas, when $\lambda = 1$, we are replacing the whole curves by β_i, β_{i+1} respectively, and the curves ν_r^1 are the curves \tilde{f} . Now, as far as the length bound goes, each time we add the tails e_r^λ to ν_r^λ we lengthen the curves by at most $L - l - a$ (up to the terms of order $o(1)$). Thus the lengths of curves in the homotopy is bounded by $5a + 3l + L + o(1)$.

□

We will next demonstrate that the above proof generalizes to the maps of spheres of arbitrary dimensions to $\Omega_p M^n$. That is, if there exist real positive numbers a and l such that $d \leq a$ and there exist no geodesic loop based at p of index zero, such that its length is in the interval $(0, l + 2a + \delta]$ for some $\delta > 0$ then every homotopy class of $\Omega_p M^n$ can be represented by a sphere that passes through short loops (thus proving Theorem 1.1). We are going to prove that f is homotopic to a map \tilde{f} with the image in $\Omega_p^{\tilde{L}+o(1)} M^n$, where $\tilde{L} = ((4k + 2)m + (2k - 3))a$, and the homotopy can be chosen so that it has its image in $\Omega_p^{\tilde{L}+o(1)}$, where $\tilde{L} = L + \tilde{L} - (2k - 1)a$. We can then take $k = \frac{3}{2}$ and $a = \pi$

This theorem is proven by recursion with respect to m . The case $m = 1$ was established in Theorem 3.4. Before summarizing the proof of the general case, we will demonstrate it in the case when $m = 2$ and $f : S^2 \rightarrow M^n$. The case of $m = 2$ has a straightforward generalization to higher dimensions, yet this dimension is still small enough as to allow a pictorial description.

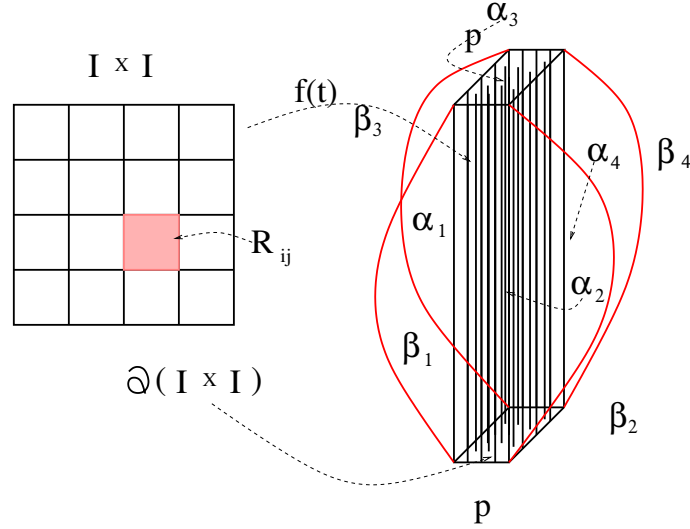
 FIGURE 9. Image of a small square in $\Omega_p M^n$

Let $I = [0, 1]$. Consider a map $f : I \times I \rightarrow \Omega_p M^n$, where $\partial(I \times I)$ is mapped to p . Without any loss of generality we can assume that all paths in the image of f are parametrized proportionally to their arclengths. Let us subdivide $I \times I$ into squares of a very small size. We would like the subdivision be sufficiently small so as to ensure that the diameter of the image of each small square under f contributes $o(1)$. Denote these squares

by R_{ij} , and their vertices by $(x_{i-1}, y_{j-1}), (x_{i-1}, y_j), (x_i, y_{j-1}), (x_i, y_j)$. We can consider the subdivision of $I \times I$ into squares R_{ij} as a cell subdivision. The vertices (x_i, y_j) will be 0-cells, edges of squares R_{ij} will be 1-cells, and their interiors will be 2-cells. Note that f maps each of 0-cells to a loop in $\Omega_p M^n$. Replace each of those loops that have length greater than $l + a + \delta$ by a shorter one as in Theorem 3.3 via a path homotopy described in the proof of Theorem 3.3 (see 9). This yields the desired map \tilde{f} on the 0-skeleton of the cell subdivision.

Now we perform the synchronization (as in section 3.4 of [NR7]) of all families $\gamma_s^{f(v)}$, where v runs over the set of all vertices of all squares R_{ij} . This is done in order to find simultaneous parametrizations of all these families by a parameter $s \in [0, 1]$ so that for each s and v the endpoint $\gamma_s^{f(v)}$ coincides with $f(v)(\tau(s))$, where $\tau(s) \in [0, 1]$ does not depend on v .

Next, whenever we apply Lemma 2.1 to a pair of paths that begin at p and end at some common point naturally associated with some two vertices of R_{ij} , we will refer to those arcs as α_1 and α_2 . Note that this choice leads to asymmetry. To achieve the consistency, let us first enumerate all 0-cells by numbers $1, 2, \dots$. We will then denote the path associated with the vertex with a smaller number as α_1 , and the path associated with the vertex with a larger number as α_2 .

Our next step will be to define \tilde{f} on all of the edges that connect these vertices as in the proof of Theorem 3.4 in the previous section. This will result in extending \tilde{f} to the 1-skeleton of the cell subdivision to $\Omega_p M^n$. All loops in the image of \tilde{f} have the length of at most $(6k - 1)a + o(1)$. What remains now is to define \tilde{f} on the 2-skeleton of our cell subdivision. Which will be accomplished by extending \tilde{f} on the interior of each square R_{ij} , from ∂R_{ij} for all i, j . After this step is accomplished it would remain to verify that \tilde{f} and f are homotopic and that this homotopy can be chosen so that all loops in its range are not very long.

Let us denote the restriction of \tilde{f} to the boundary of a small square R_{ij} by \tilde{F} . It induces a map from $\partial R_{ij} \rightarrow M^n$. ∂R_{ij} is a 2-sphere with a natural cell subdivision of the boundary of a parallelepiped. Two opposite faces of this parallelepiped are mapped to p . In our figures below those will be the left and the right faces (see Fig. 10 (a)).

On Fig. 10 the two copies of p are depicted as two different points to simplify the diagram.

Let us consider R_{ij} for some fixed integers i and j . Denote its vertices as v_1, v_2, v_3, v_4 . Let $f(v_k) = \alpha_k$ for $k \in \{1, 2, 3, 4\}$, (see Fig. 10). Denote its edges connecting v_k and v_l as $[v_k, v_l]$. Those edges correspond to the top, bottom, front and back edges of the sphere depicted on Fig. 10 (a). Let us consider how those are mapped to M^n by \tilde{F} .

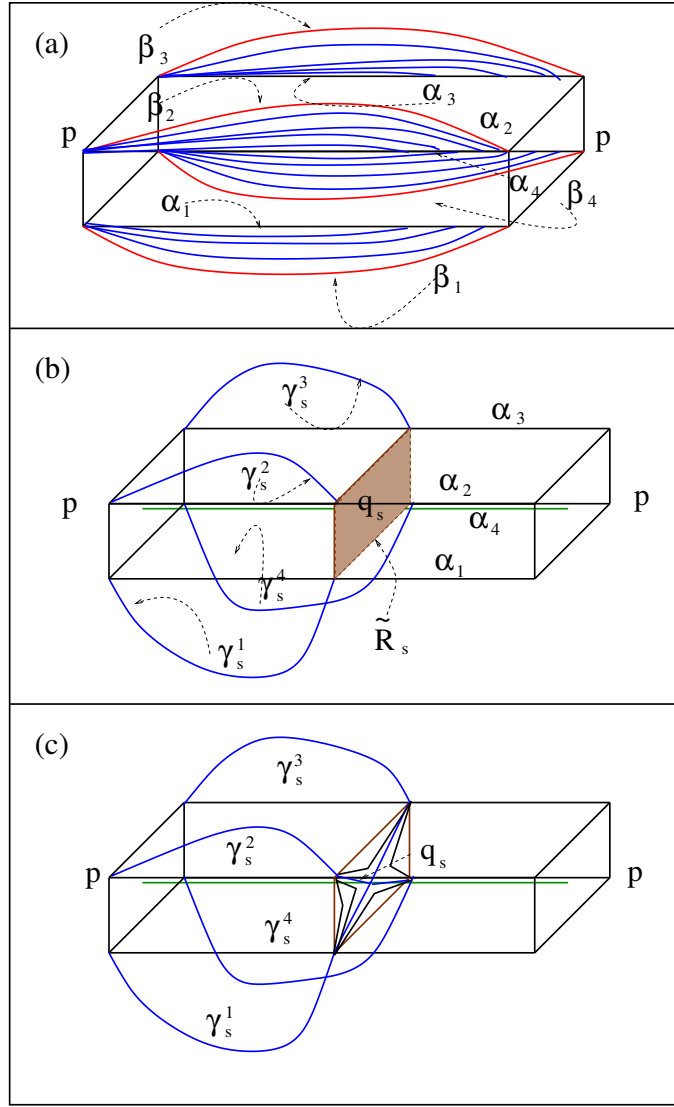
 FIGURE 10. Contracting \tilde{S}^2 to p

Without the loss of generality, consider the face that corresponds to the edge $e = [v_1, v_2]$. Let us recall that \tilde{F} was constructed by first replacing α_1 and α_2 by the curves β_1, β_2 respectively. We next considered the loop $\beta_1 * \bar{\beta}_2$ based at p and contracted it to p over the loops of the form $\gamma_s^1 * f(t)|_{t \in e}(\tau(s)) * \bar{\gamma}_s^2, s \in [0, 1]$, where $\tau(s)$ is the synchronization function. Here γ_s^1, γ_s^2 are the curves that connect p with the corresponding points on $\alpha_1(\tau(s)), \alpha_2(\tau(s))$ respectively, the existence of which were proven in Theorem 3.3.

The length of these loops is at most $2l + 4a + o(1)$. Substituting into this formula $l = 2(k-1)a$, we obtain that the length of this loops can be at most $4ka + o(1)$.

Lemma 3.1 implies the existence of a 1-parameter family of short paths interpolating between β_1 and β_2 . Similarly we have constructed the map on each edge of ∂R_{ij} .

We will now extend the map to the interior of R_{ij} by first constructing a 1-parameter family of 2-spheres, \tilde{S}_s^2 that begins with our sphere and ends with a point.

This will be done in three steps.

Step 1. For each s consider a 1-parameter family of "rectangles": \tilde{R}_s that are transversal to the curves $f(t)$. One such rectangle is depicted on Fig. 10 (b). Thus, \tilde{R}_s is a 1-parameter family of rectangles that consist of points $f(t)(\tau(s))$ for a fixed s and for all $t \in R_{ij}$.

Next let us consider a 1-parameter family of 2-spheres S_s^2 , which start with a 2 sphere induced by the map $f : \partial R_{ij} \rightarrow \Omega_p M^n$, and end with $S_1^2 = \{p\}$. S_s^2 then can be described by restricting all of the curves $f(t)$, $t \in \partial R_{ij}$ to the interval $[0, \tau(s)]$. That is, on Fig. 10 (b), the left part of the boundary of the parallelepiped, together with the shaded "rectangle" \tilde{R}_s represents S_s^2 . In order to construct \tilde{S}_s^2 we will replace the curves by shorter curves as we have done so in the case of S_0^2 . This construction will continuously depend on the parameter s .

Let us partition each R_s continuously with s into families of short curves in the following way. First, let q_s be a 1-parameter set of centers of these squares. It is represented by a middle line on Fig. 10 (b). For each $s \in [0, 1]$ connect the middle of R_s with each vertex of R_s . By choosing R_{ij} sufficiently small we can ensure that each connecting edge has length of $o(1)$ and so that the curves vary continuously with s . Let us denote the edges that we obtain by σ_s^i for $i = 1, 2, 3, 4$ depending on the order of the vertex. We can now consider the for wedges of curves: $\sigma_s^1 * \bar{\sigma}_s^2, \sigma_s^2 * \bar{\sigma}_s^3, \sigma_s^3 * \bar{\sigma}_s^4, \sigma_s^4 * \bar{\sigma}_s^1$. Finally, for each of the wedge and each parameter s we continuously deform it to the corresponding edge via path-homotopy over the curves of small length, so that they also continuously vary with s , (see Fig. 10 (c)).

We will construct \tilde{S}_s^2 as follows. First we will replace each segment of α_i up to $\tau(s)$ by a corresponding segment γ_s^i . We will refer to $\gamma_s^i * \sigma_s^i$ as β_s^i . That is, we extend each segment γ_s^i by a short segment in such a way that the resulting segment connects p with q_s . It is possible for the same segment to be continuously replaced by different curves depending on s , since $\tau(s)$ is not a one-to-one function. Next, we consider the pairs $\gamma_s^j, \gamma_s^{j+1 \pmod 4}$, where $j = 1, 2, 3, 4$. In general those curves do not form

a loop. However, they will form a loop after we extend them by segments σ_s^j . For example, consider γ_s^1, γ_s^2 , then the following curve is a loop based at p : $\gamma_s^1 * \sigma_s^1 * \bar{\sigma}_s^2 * \bar{\gamma}_s^2$. Moreover, each of these loops can be contracted to p over the loops of length at most $4ka + o(1)$, (the first step would be to contract $\sigma_s^1 * \bar{\sigma}_s^2$ to the corresponding edge $f([v_1, v_2])$, while keeping γ_s^1 and $\bar{\gamma}_s^2$ fixed). Now, we can apply Lemma 3.1 to obtain a system of curves interpolating between β_s^j and β_s^{j+1} . Those curves will all connect the point p with the point q_s , they will be of length at most $(6k + 1)a + o(1)$. Thus, we obtain a one parameter family of 2-spheres in M^n that is endowed with a sweep-out by short curves connecting p with q_s .

Step 2. Now choose a path among these curves and attach it to each of these curves connecting p and q_s so that we will have a family of loops. We will choose this path by first fixing a vertex v of R_{ij} , and letting this path be its image under the map that we have constructed in Step 1. Its length is bounded above by $(2k + 1)a + o(1)$. We can thus obtain a sweep-out of each sphere S_s^2 by loops of length $\leq (8k + 2)a + o(1)$ based at p . Finally, define F as $F(x, y, t) = f(x, y)(t)$ for all $(x, y) \in R_{ij}, t \in I$. The image of v under F_t^2 is the join of $\gamma_s^{f(v)}$ (from the proof of Theorem 3.3) with the short straight line segment $\sigma^{F(v)}$. This segment has length of $o(1)$. Vertex v has to be chosen consistently for the sake of continuity with respect to s .

To accomplish this consistency we will always choose v to be the vertex of R_{ij} with the smallest index in the chosen enumeration of all of the vertices of all of the squares R_{ij} . As the result we obtain a continuous 1-parametric family of \tilde{S}_t^2 from $S^1 = r_s$ to $\Omega_p^{(8k+2)d+o(1)} M^n$ (parametrized by t). Note that all loops corresponding to a fixed value of s pass through q_s .

Step 3. Let us apply Lemma 3.2 to obtain a 3-disc filling the original 2-sphere, S_1^2 . At the same time we will obtain a sweep-out of this disk by loops of length at most $(8k + 2)a + (2k - 1)a + o(1) = (10k + 1)a + o(1)$. In other words, this lemma will produce an extension of S_1^2 to a map of a 2-disc to $\Omega_p^{(10k+1)a+o(1)} M^n$ (that can be also regarded as a map \tilde{F} of a 3-disc into M^n).

This allows us to extend \tilde{f} from ∂R_{ij} to R_{ij} . Combining these fillings for all values of i, j we obtain a desired map $\tilde{f} : S^2 \rightarrow \Omega_p M^n$ with the image in $\Omega_p^{(10k+1)a+o(1)} M^n$.

After the completion of these three steps we will need to prove that the constructed map \tilde{f} is homotopic to f .

A description of two typical loops in the image of \tilde{f} . Let us now describe a typical loop in the image of \tilde{f} . We will consider a loop that corresponds to $t \in R_{ij}$. To understand how a typical $\tilde{f}(t)$ will "look", we should recall how the map is constructed.

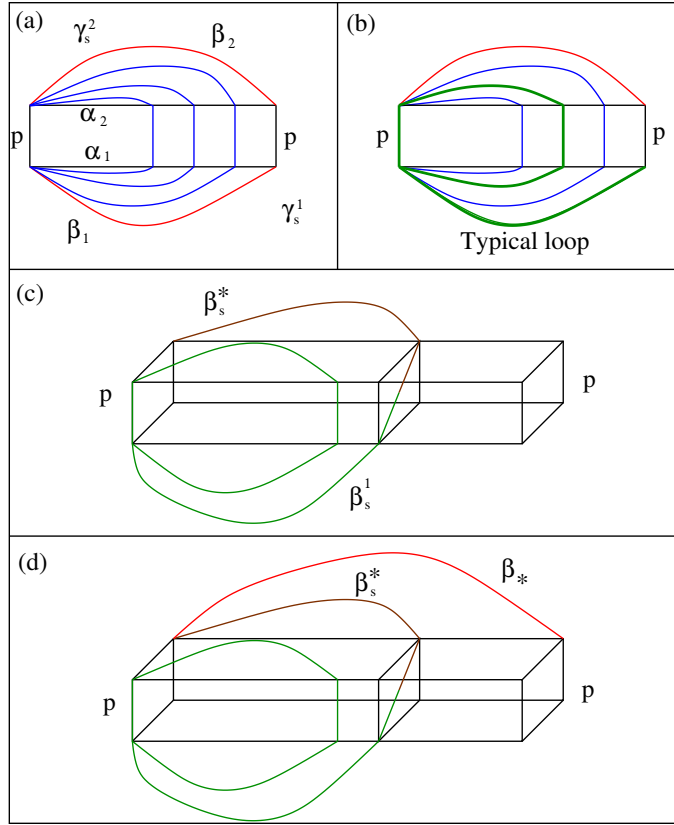

FIGURE 11. Typical Loops

Recall that the first step was to change all the curves $\alpha_i = f(v_i)$ for $i = 1, 2, 3, 4$ to the shorter curves β_i . Here v_i are the vertices of R_{ij} .

At the same step we have constructed families of curves γ_s^i that connect p with the corresponding points on α_i . The same point can be connected with p by more than one curve (see Fig. 11 (a)).

Next we considered a one parameter family of spheres, S_s^2 . Corresponding to each of these spheres, we have constructed a new one parameter family of spheres \tilde{S}_s^2 that consisted of continuously changing with s one-parameter family of "horizontal" curves that connect the points p and c_s . Contract the loop $\beta_s^i * \bar{\beta}_s^{(i+1) \bmod 4}$ to p and next attach to each such loop a curve $\beta_s^{v_1}$ that connects p with c_s . Those horizontal curves are depicted on Fig. 11 (c). They are depicted in green and consist of the loop followed by a bottom segment. Next we take those curves, and make loops out of them by attaching a segment $\beta_s^{v^*}$. This is a top brown curve on Fig. 11 (c). Thus, the typical loop here would be a loop that consists of a concatenation of loops

$\gamma_s^i * vert * \bar{\gamma}_s^{(i+1) \bmod 4}$ and $\beta_s^{v^*} * \bar{\beta}_s^{v_1}$. Note that v^* should be chosen canonically, so that the curve changes continuously with respect to s . Next we use Lemma 3.2 to construct the loop that fills the square. It will consist of adding a canonical segment to the loop that we described above (see Fig. 11 (c)).

Remark: In order to finish the construction in this particular case, we still need to demonstrate that f and \tilde{f} are two homotopic maps. Denote the desired homotopy by G and its parameter by λ . We construct G at λ as follows: Let us first subdivide $I \times I$ into the small rectangles R_{ij} as during the previous construction. We can view this as a cell subdivision of $I \times I$, and thus our construction will be inductive with respect to the skeleta of this subdivision. We will first consider the vertices and the edges. In this case $G(\lambda)$ will be constructed exactly as in the case of $m = 1$. Recall, that we have done this by changing only the "first" parts of the curves $\alpha_i s$ and using their partial shortenings. Now it remains to extend G from the boundary of each square R_{ij} to its interior (or, more precisely, from $\partial R_{ij} \times [0, 1]$ to $R_{ij} \times [0, 1]$). We are going to assume that i, j are fixed, and will describe $G(\lambda)|_{R_{ij}} : R_{ij} \rightarrow \Omega_p M^n$ for each value of λ .

We will only present an informal idea of this construction. One can consult [NR7] for the details of this proof. The informal idea of our construction is that at each moment of time λ we would like to define a map \tilde{F}_λ on $R_{ij} \times [0, s(\lambda)]$ the previously defined map \tilde{F} of $R_{ij} \times I$ restricted to $R_{ij} \times [0, s(\lambda)]$, whereas, \tilde{F} on $R_{ij} \times [s(\lambda), 1]$ should be the original map F restricted to $R_{ij} \times [s(\lambda), 1]$. Recall that \tilde{F} coincides with \tilde{f} when it is regarded as a map from $R_{ij} \times I$ into M^n , i.e. $\tilde{F}(x, y, t) = \tilde{f}(x, y)(t)$. In particular, we want \tilde{F}_1 to coincide with \tilde{F} . On the other hand, we would like the restriction of \tilde{F}_λ on $R_{ij} \times [s(\lambda), 1]$ to coincide with F .

The map $G(\lambda)$ will then coincide with \tilde{F}_λ , when \tilde{F}_λ is regarded as a map from R_{ij} to $\Omega_p M^n$.

The lengths of the loops in the image of this homotopy can be bounded by $L + (10k + 3)a + o(1) - (2k - 1)a$. We have subtracted $(2k - 1)a$, because one of the segments of curves γ_s^i shortens a segment whose length is counted as a part of the term L

Proof of the general case: Construction of \tilde{f} .

Proof.

We will only present the summary of the proof. One should consult [NR7] for the whole proof, substituting a positive constant a for the diameter d

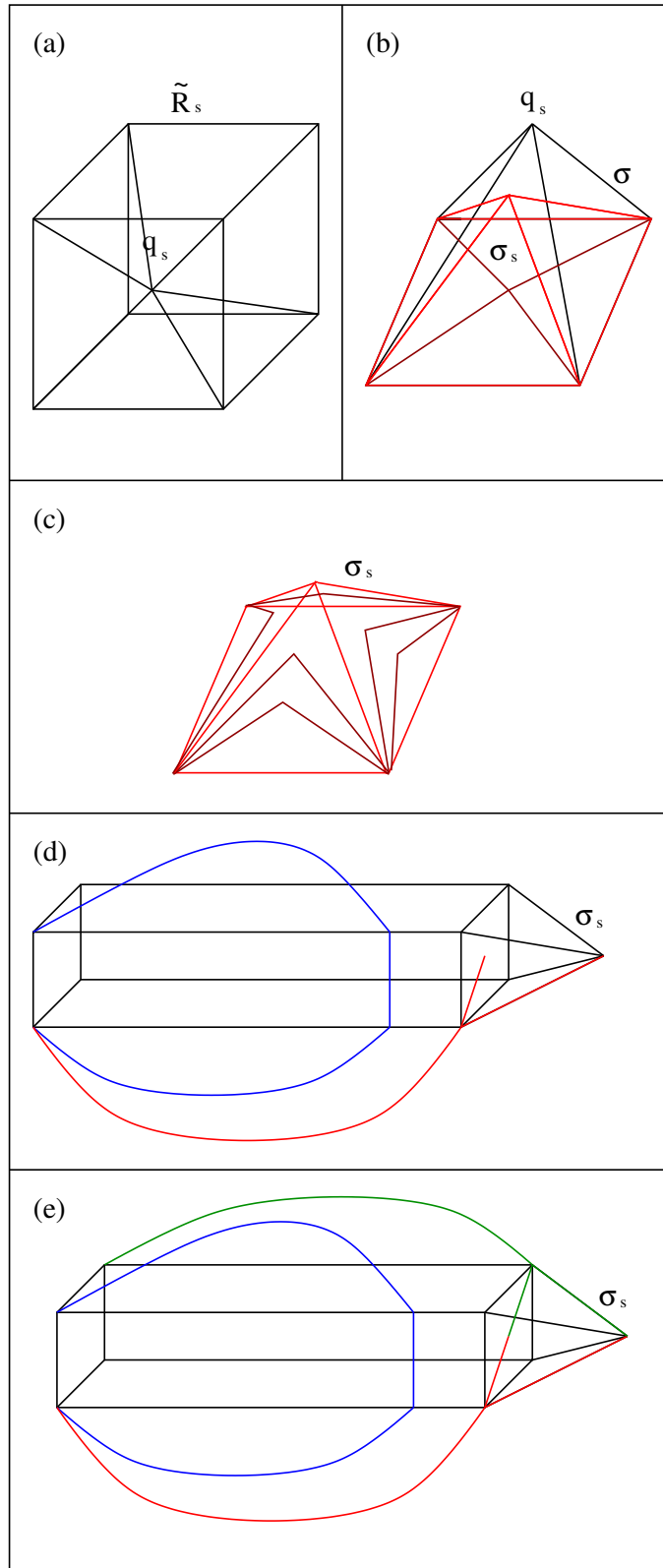

FIGURE 12. General Case

Let $f : I^m \rightarrow \Omega_p M^n$ be a continuous map such that ∂I^m is mapped to p . We will summarize how to construct $\tilde{f} : I^m \rightarrow \Omega_p^{((4k+2)m+(2k-3))a+o(1)} M^n$.

Let us first consider a map $F : I^{m+1} \rightarrow M^n$, induced by f . It is defined as $f(u)(t)$ for each $u = (x_1, \dots, x_m) \in I^m$, where I^m corresponds to the first m coordinates of I^{m+1} . Next let us partition I^m into "small" m -cubes R_{i_1, \dots, i_m} . Let $\tilde{R}_s = F(R_{i_1, \dots, i_m}, s)$ for a fixed $s \in I$ that for each s the image of each straight line in $R_{i_1, \dots, i_m} \times \{s\}$. We want the subdivision of I^m be sufficiently to insure that the diameter of \tilde{R}_s is smaller than some arbitrarily small δ . Fig. 12 (a) depicts such \tilde{R}_s .

The partition of I^m into small cubes can be viewed as a cell subdivision. Thus, \tilde{f} will be constructed by induction on the order of skeleta. By induction assumption, we can construct \tilde{f} on each face of rectangle R_{i_1, \dots, i_m} . In order to extend this map to R_{i_1, \dots, i_m} we will construct a 1-parameter family of $(m-1)$ -dimensional spheres, \tilde{S}_s^{m-1} interpolating between $\tilde{S}_0^{m-1} = \{p\}$ and $\tilde{f}(\partial R_{i_1, \dots, i_m})$. So let us fix $s \in I$. Consider the faces of a m -dimensional sphere, which is obtained as follows. We consider $F(R_{i_1, \dots, i_m}, t)$, slice it by rectangle \tilde{R}_s , take the "left" half, and then consider its boundary (see Fig. 12 (c)). It comes with a natural cellular decomposition, and to construct the new sphere \tilde{S}_s^{m-1} we change the map on each of the cells. By induction assumption we know how to change the map on each of the cells, except for \tilde{R}_s .

In order to extend \tilde{f} to \tilde{R}_s , first partition \tilde{R}_s into "rectangular pyramids" of dimension $m-1$ that has as its base, one of the faces of \tilde{R}_s and as its vertex, the center of the cube q_s (see Fig. 12 (a), (b), (c)).

Note that the boundary of the pyramide without the base can be continuously deformed to the base, keeping the common sphere fixed as it is depicted on Fig. 12 (b). Let us fix the face of the cube. Let σ be the corresponding boundary of the pyramide without the base. Consider a deformation of σ to the base along σ_r . On the prior step of the induction, we have obtained a system of short curves connecting p and the center of the base, we can continuously repeat this construction by deforming the base to σ along σ_r . We can next make the newly constructed segments that correspond to all of the faces of \tilde{R}_s into loops and apply Lemma 3.2 (see Fig. 12 (d), (c)).

□

Acknowledgments. This paper was partially written during the author's visit of the Max-Planck Institute at Bonn in the Summer 2021. The author would like to thank the Max-Planck Institute for its kind hospitality. The

author gratefully acknowledges partial support by her NSERC Discovery Grant, RGPIN 220571, during her work on the present paper.

REFERENCES

- [AVP] I. ADELSTEIN, F. VARGAS PALLETE, The length of the shortest closed geodesic on positively curved 2-spheres, preprint, arXiv:2006.04849.
- [B] F. BALACHEFF, Sur des problemes de la géométrie systolique, Séminaire de Théorie Spectrale et Géométrie. Vol. 22. Année 2003-2004, 71-82, Sémin. Théor. Spectr. Géom., 22, Univ. Grenoble I, Saint-Martin-d'Hères, 2004, MR2136136.
- [B1] F. BALACHEFF, A local optimal diastolic inequality on the two-sphere, Journal of Topology and Analysis, vol. 02, no. 01, (2010), 109-121.
- [Ba] C. BAVARD, Inegalite isosystolique pour la bouteille de Klein", Math. Ann. 274 (3) (1984), 439-441.
- [BCK] F. BALACHEFF, C.B. CROKE, M. KATZ A Zoll counterexample to a geodesic length conjecture, Geom. Funct. Anal. 19(2009), 1-10.
- [BITZI] W. BALLMANN, G. THORBERGSSON, W. ZILLER, Existence of closed geodesics on positively curved manifolds, Journal of Diff. Geom. 18 (1993), 221-252.
- [BrZ] JU. BURAGO, V. ZALGALLER, Geometric Inequalities, Berlin: Springer-Verlag, 1988, MR0936419, Zbl 0633.53002.
- [Ch] H. Y. CHENG, Curvature-free linear length bounds on geodesics in closed Riemannian surfaces, preprint, 21 pages, to appear in Tran. Amer. Math. Soc.
- [Cr] C. B. CROKE, Area and the length of the shortest closed geodesic, J. Diff. Geom. 27 (1988), 1-21.
- [CrK] C. B. CROKE, M. KATZ, Universal volume bounds in Riemannian manifolds, Surveys in differential geometry, **VIII** (2002), 109-137.
- [DC] M. DO CARMO, Riemannian Geometry, Springer, 1992.
- [FHT] Y. FELIX, S. HALPERIN, J.-C. THOMAS, Rational Homotopy Theory, Springer-Verlag, NY, 2001.
- [FrK] S. FRANKEL, M. KATZ, The Morse landscape of a Riemannian disc, Ann. Inst. Fourier (Grenoble) 43(2)(1993), 503-507.
- [G] M. GROMOV, Filling Riemannian manifolds, J. Diff. Geom. 18 (1983), 1-147, MR0697984, Zbl 0515.53037.
- [H] J. HEBDA, Some lower bounds for the area of surfaces, Invent. Math. 65(3), 485-490.
- [K] M. KATZ, Systolic geometry and topology, Mathematical Surveys and Monographs, vol. 137, American Mathematical Society, Providence, RI, 2007. With an appendix by Jake P. Solomon. MR 2292367
- [KS1] M. KATZ, S. SABOURAU, Entropy of systolically extremal surfaces and asymptotic bounds, Ergo. Th. Dynam. Sys. 25 (4), 1209-1220.
- [KS2] M. KATZ, S. SABOURAU, Hyperelliptic surfaces are Loewner, Proc. Amer. Math. Soc. 134 (4), 1189-1195.
- [M] M. MAEDA, The length of a closed geodesic on a compact surface, Kyushu J. Math. 48 (1994), no. 1, 9-18, MR1269063, Zbl 0818.53064.
- [L] Y. LIKUMOVICH, "Spheres of small diameter with long sweep-outs", Proc. Amer. Math. Soc. 141(2013), 309-312.
- [N] A. NABUTOVSKY, Linear bounds for constants in Gromov's systolic inequality and related results, preprint, arXiv:1909.12225.

- [NR1] A. NABUTOVSKY, R. ROTMAN, The length of a shortest closed geodesic on a 2-dimensional sphere, *IMRN*, 2002 (2002), no. 39, 2121-2129.
- [NR2] A. NABUTOVSKY, R. ROTMAN, Upper bounds on the length of a shortest closed geodesic and quantitative Hurewicz theorem, *J. Eur. Math. Soc. (JEMS)* 5(3)(2003), 203-244.
- [NR3] A. NABUTOVSKY, R. ROTMAN, Volume, diameter and the minimal mass of a stationary 1-cycle, *Geom. Funct. Anal. (GAFA)*, 14 (2004), 4, 748-790.
- [NR4] A. NABUTOVSKY, R. ROTMAN, The minimal length of a non-trivial net on a closed Riemannian manifold with a non-trivial second homology group, *Geom. Dedicata* 113 (1) (2005), 243-254.
- [NR5] A. NABUTOVSKY, R. ROTMAN, "Linear bounds for lengths of geodesic loops on Riemannian 2-spheres", *J. of Differential Geom.* 89(2011), 217-232.
- [NR6] A. NABUTOVSKY, R. ROTMAN, "Linear bounds for lengths of geodesics between a pair of points on Riemannian 2-spheres",
- [NR7] A. NABUTOVSKY, R. ROTMAN, Length of geodesics and quantitative Morse theory on loop spaces, *Geom. Funct. Anal. (GAFA)*, 23 (2013), 367-414.
- [R1] R. ROTMAN, The length of a shortest closed geodesic and the area of a 2-dimensional sphere, *Proc. Amer. Math. Soc.* 134 (2006), no. 10, 3041-3047, MR2231630, Zbl 1098.53035.
- [R2] R. ROTMAN, The length of a shortest geodesic net on a closed Riemannian manifold, *Topology*, 46:4 (2007), 343-356.
- [R3] R. ROTMAN, Geodesic loops and periodic geodesics on a Riemannian manifold diffeomorphic to S^3 , *Math. Z.* 257(2) (2007), 427-437.
- [R4] R. ROTMAN, The length of a shortest geodesic loop at a point, *Journal of Diff. Geom.*, 78:3 (2008), 543-554.
- [R5] R. ROTMAN, Flowers on Riemannian manifolds, *Mathematische Zeitschrift*, 269 (2011), 543-554.
- [S1] S. SABOURAU, Filling radius and short closed geodesics of the 2-sphere, *Bull. Soc. Math. France* 132 (2004), no. 1, 105-136, MR2075918, Zbl 1064.53020.
- [S2] S. SABOURAU, Global and local volume bounds and the shortest geodesic loops, *Commun. Anal. Geom.* 12 (2004), 1039-1053.
- [Sc] A.S. SCHWARTZ, Geodesic arcs on Riemannian manifolds, *Uspekhi Math. Nauk* (translated in *Russian Math. Surveys*) 13(6) (1958), 181-184.
- [Se] J.-P. SERRE, Homologie singulière des espaces fibrés. Applications. *Ann. of Math.* 54(1951), 425-505.
- [T] A. TREIBERGS, Estimates of volume by the length of shortest closed geodesic on a convex hypersurface, *Invent. Math.* 80 (1985), no. 3, 481-488.
- [WuZ] N. WU, Z. ZHU, Length of a shortest closed geodesic in manifolds of dimension four, arXiv:1702.07033, to appear in the *Journal of Diff. Geom.*

R. Rotman
 Department of Mathematics
 40 St. George st.
 University of Toronto
 Toronto, Ontario M5S 2E4
 Canada
 e-mail: rina@math.toronto.edu