

# New Radio Beam-based Access to Unlicensed Spectrum: Design Challenges and Solutions

Sandra Lagen<sup>+</sup>, Lorenza Giupponi<sup>+</sup>, Sanjay Goyal<sup>\*</sup>, Natale Patriciello<sup>+</sup>, Biljana Bojovic<sup>+</sup>,  
Alpaslan Demir<sup>\*</sup>, Mihaela Beluri<sup>\*</sup>

(<sup>+</sup>) Centre Tecnològic de Telecomunicacions de Catalunya (CTTC/CERCA), Barcelona, Spain

(<sup>\*</sup>) InterDigital Communications, Inc., Melville, New York, USA

corresponding e-mail: sandra.lagen@cttc.es

**Abstract**—This paper elaborates on the design challenges, opportunities, and solutions for New Radio-based access to Unlicensed spectrum (NR-U) by taking into account the beam-based transmissions and the worldwide regulatory requirements. NR-U intends to expand the applicability of 5th generation New Radio access technology to support operation in unlicensed bands by adhering to Listen-Before-Talk (LBT) requirements for accessing the channel. LBT was already adopted by different variants of 4th generation Long Term Evolution (LTE) in unlicensed spectrum, i.e., Licensed-Assisted Access and MulteFire, to guarantee fair coexistence among different radio access technologies. In the case of beam-based transmissions, the NR-U coexistence framework is significantly different as compared to LTE in unlicensed spectrum due to the use of directional antennas, which enhance the spatial reuse but also complicate the interference management. In particular, beam-based transmissions are needed in the unlicensed spectrum at millimeter-wave (mmWave) bands, which is an attractive candidate for NR-U due to its large amount of allocated spectrum. As a consequence, some major design principles need to be revisited to address coexistence for beam-based NR-U. In this paper, different problems and the potential solutions related to channel access procedures, frame structure, initial access procedures, re-transmission procedures, and scheduling schemes are discussed. A simulation evaluation of different LBT-based channel access procedures for NR-U/Wi-Fi indoor mmWave coexistence scenarios is also provided.

**Index Terms**—NR-U, unlicensed spectrum, beam-based transmissions, coexistence, spectrum sharing, mmWave, LBT.

## I. INTRODUCTION

To address the rapid increase of wireless data traffic demand in the upcoming years, the wireless industry has turned its attention to the unlicensed spectrum bands as a way to aggregate additional bands and improve the capacity of future cellular systems [1]–[3]. The unlicensed spectrum that has global worldwide availability includes the 2.4 GHz, 5 GHz, and 60 GHz bands. In the unlicensed 60 GHz band, there has been a release of 9 GHz of spectrum in Europe and of 14 GHz in the USA [4], which provides 10× times (in Europe) and 16× times (in the USA) as much unlicensed spectrum as is available in sub 6 GHz bands. Due to the large amount of spectrum available, the design of a system able to work in millimeter-wave (mmWave) carrier frequencies (30–300 GHz) is inevitable in order to achieve multi-Gigabit/s data rates for a large number of devices [5], [6].

The 3rd Generation Partnership Project (3GPP) is currently in a full standardization process of New Radio (NR)<sup>1</sup>, the Radio Access Technology (RAT) for 5th Generation (5G) systems [7], [8], which has inherent support for operation at high carrier frequencies within the mmWave spectrum region with wide-bandwidth [9], [10]. One of the options which is being considered is to allow NR to operate in unlicensed bands through NR-based access to Unlicensed spectrum (NR-U). It is similar to what was previously proposed in the case of Long Term Evolution (LTE) in unlicensed spectrum for the 5 GHz band, through its different variants [3], namely Licensed-Assisted Access (LAA) [11], [12], LTE Unlicensed (LTE-U) [2], [13], and MulteFire [14], [15].

The design of NR-U started in a study item of NR Rel-16 in 2018 [16], [17], and it is currently being developed as one of the NR Rel-16 work items, which will enable its inclusion in future NR specification [18]. The primary objective of NR-U is to extend the applicability of NR to unlicensed spectrum bands as a general purpose technology that works across different bands and uses a design that allows fair coexistence across different RATs. Differently from LAA and LTE-U that were based on carrier aggregation using the unlicensed 5 GHz band, and from MulteFire that used standalone operation in the 5 GHz band so far, NR-U considers multiple bands and various deployment modes. The frequency bands discussed for NR-U include 2.4 GHz, 5 GHz, 6 GHz, and 60 GHz unlicensed bands<sup>2</sup>, as well as 3.5 GHz and 37 GHz bands, which are devoted to shared access in the USA. As confirmed by 3GPP, the 60 GHz band is an attractive candidate for NR-U, since it is currently not very crowded and can offer a large amount of contiguous bandwidth [19]. Regarding the deployment modes, NR-U supports carrier aggregation, dual connectivity, and standalone operation in unlicensed. All in all, NR-U is a milestone for 3GPP, which will allow, among others,

<sup>1</sup>The first version of NR specification was published as a part of NR Rel-15 in June 2018, while the remaining part of the specification is planned to be published as a part of NR Rel-16 (in early 2020) as well as a part of subsequent releases.

<sup>2</sup>The NR-U work item in NR Rel-16 has started while focusing on sub 7 GHz bands [18], but the extension to unlicensed mmWave bands will probably be included in later releases, i.e., NR Rel-17 and beyond. References to sub 7 GHz are intended to include the unlicensed bands in the 6 GHz region that have some region exceeding 7 GHz (e.g., 7.125 GHz). This differs from the classification of spectrum in NR that considers sub 6 GHz bands and mmWave frequency ranges.

standalone operation of NR in unlicensed spectrum including the mmWave bands with beam-based transmissions.

One of the most critical issues of allowing cellular networks to operate in unlicensed spectrum is to ensure a fair and harmonious coexistence with other unlicensed systems, such as Wi-Fi in the 5 GHz band (IEEE 802.11a/n/ac/ax) and directional multi-Gigabit Wi-Fi in the 60 GHz band (IEEE 802.11ad/ay, also known as Wireless Gigabit (WiGig)) [20]–[22]. Fairness for NR-U operation in the unlicensed bands is defined as the ability that NR-U devices do not impact already deployed Wi-Fi services more than an additional Wi-Fi network would do on the same carrier [16]. For a fair coexistence, any RAT that wants to operate in the unlicensed spectrum (e.g., NR-U) has to be designed in accordance with the regulatory requirements of the corresponding bands. In the case of the 5 GHz and 60 GHz bands, the regulation mandates the use of Listen-Before-Talk (LBT) in Europe and Japan [23]. LBT is a spectrum sharing mechanism by which a device senses the channel using a Clear Channel Assessment (CCA) check before accessing to it. LBT works across different RATs, and it is adopted by LAA, MulteFire, Wi-Fi, and WiGig to comply with the regulation (known as Carrier Sense Multiple Access with Collision Avoidance (CSMA/CA) in the IEEE 802.11 context). However, even with omnidirectional communications, LBT suffers from the hidden node and exposed node problems due to the differences in the sensing, transmission, and reception ranges<sup>3</sup>.

Coexistence in the 5 GHz band has been well studied in recent years to let LTE in unlicensed spectrum gracefully coexist with Wi-Fi [1]–[3], [24]. Since LTE was initially designed to work in licensed bands on the basis of uninterrupted and synchronous operations, it was required to be later adapted to work with asynchronous protocols for operation in the unlicensed 5 GHz band. Differently, due to the on-going NR standardization, NR-U can be designed from the start with a great amount of flexibility for efficient operation in unlicensed spectrum bands. Nevertheless, there is a major difference between NR-U coexistence with other RATs as compared to LTE/Wi-Fi coexistence in the 5 GHz band because of the use of beam-based (or directional) transmissions in NR. NR has standardized beam management procedures for next-Generation Node B (gNB)s and User Equipment (UE)s in all operational bands [8, Sec. 8.2.1.6.1]. In particular, directional communications are needed in mmWave bands due to its characteristic propagation conditions, which require the use of beamforming to overcome propagation limits like severe pathloss, blocking, and oxygen absorption in case of the 60 GHz band [5], [25]. Similarly, WiGig (IEEE 802.11ad/ay) has been particularly designed to deal with these impairments by making directionality mandatory at either the transmitter or receiver [20].

<sup>3</sup>A hidden node problem arises when a node cannot hear an on-going transmission in the channel and declares the channel free to transmit but, if that node does any transmission, it collides with the on-going transmission. An exposed node problem, instead, appears when a node senses the channel as busy because it can listen to an on-going transmission but it could have transmitted simultaneously with that on-going transmission without creating any collision.

The beam-based transmissions envisioned in NR potentially may cause less interference and enable spatial reuse. However, the different interference layout due to the directional transmissions also changes the coexistence framework in the unlicensed spectrum. In particular, the directionality may aggravate the hidden node and exposed node problems in the unlicensed bands [26]. As such, the beam-based transmissions make the NR-U coexistence framework more challenging as compared to coexistence with omnidirectional transmissions/receptions in Wi-Fi and LTE in unlicensed spectrum.

#### A. Objective and Contribution

The objective of this paper is to give the reader a complete overview of the major design principles and solutions for NR-U operation in unlicensed bands, with an emphasis on mmWave bands, by taking into account the beam-based transmissions and the worldwide regulatory requirements. NR-U technology is currently under development, and hence we focus our discussions to a set of key features and functionalities that are likely to be included in the final specification. For that, we go through the main NR features defined in Rel-15 and discuss the challenges in adapting them to meet the regulation for use in unlicensed spectrum and to coexist with other RATs. We mainly focus our discussions on the design of Physical (PHY) and Medium Access Control (MAC) layers.

The main contributions of this paper are summarized as follows:

- We review the spectrum allocation and regulatory requirements for the unlicensed bands that have the most potential for NR-U, i.e., 5 GHz, 6 GHz, and 60 GHz bands.
- We outline the NR-U scenarios and LBT procedures under discussion in 3GPP and highlight the NR features that need to be revisited for NR-U.
- By considering the regulatory requirements and the impact of narrow beam transmissions, we elaborate on a variety of critical challenges that are encountered in different NR-U scenarios, related to the following areas:
  - the redefinition and implementation of LBT-based **channel access procedures**,
  - the selection of the **frame structure** in Time Division Duplexing (TDD) systems,
  - the adaptation of NR **initial access procedures**,
  - the redesign of NR **re-transmission procedures** based on Hybrid Automatic Repeat and reQuest (HARQ) and **scheduling schemes**.

For each one of the identified challenges, we review the available literature and interesting standard contributions, and suggest innovative design solutions that can be further elaborated in future works.

- Finally, we evaluate and compare different LBT-compliant channel access procedures with the aid of simulations in different NR-U/WiGig coexistence scenarios at the 60 GHz band.

To the best of our knowledge, this is the first work that provides a detailed discussion on the design considerations and development process of beam-based NR-U. Apart from

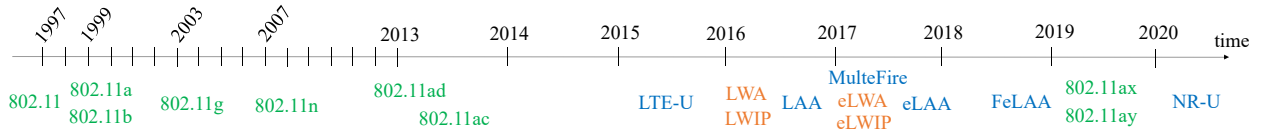

Fig. 1: Standardization timeline of technologies that use unlicensed spectrum.

the channel access procedures, no other work discusses other design challenges and solutions for NR-U<sup>4</sup>. Besides, regarding the channel access procedures, we analyze, compare, and evaluate different procedures in this paper.

Let us remark that in this paper we focus on NR-U, assuming some basic knowledge from the reader about NR. An overall description of NR can be found in [7], and key papers are [9], [27], [28]. Throughout this paper we refer the reader to specific sections of 3GPP NR technical specification and reports when needed. In line with 3GPP terminology, we refer to an NR terminal as UE and an NR base station as gNB<sup>5</sup>. Similarly, according to IEEE 802.11 standards, Wi-Fi/WiGig terminal and base station are referred to as Station (STA) and Access Point (AP), respectively.

### B. Organization

The remainder of the paper is organized as follows. We start in Section II by giving a review of the related work (in the areas of LTE in unlicensed spectrum (including LAA, LTE-U, and MulteFire), unlicensed IEEE-based technologies, beam-based NR and NR-U). Then, Section III reviews the spectrum allocation and regulatory requirements for the unlicensed spectrum at 5 GHz, 6 GHz, and 60 GHz bands. Section IV presents the NR-U scenarios and LBT specifications, based on 3GPP discussions. Next, Section V introduces the different areas of the NR system design that need to be rethought for NR-U, which will be reviewed in Sections VI-X. In Section VI, we highlight the problems and analyze potential channel access procedures for NR-U to provide support for different LBT-related problems that arise due to the beam-based transmissions and which were not present in LAA and MulteFire technologies. In Section VII, we highlight the trade-offs in the selection of the frame structure. Section VIII reviews the problems and solutions for the initial access procedure, including synchronization signal block design, random access procedure, and paging. In Section IX, we illustrate two negative impacts of LBT on the HARQ mechanism and show how to overcome them. Section X elaborates on the problems related to the scheduler operation, and highlights new scheduling schemes that are suitable for beam-based NR-U. After that, in Section XI, we evaluate different LBT-based channel access procedures in NR-U/WiGig indoor mmWave coexistence scenarios. Finally, Section XII summarizes the lessons learned from the discussions given in this paper,

<sup>4</sup>Although we focus on beam-based transmissions, some of the discussions in this paper regarding frame structure, initial access, HARQ, and scheduling, also apply to NR-U with omnidirectional transmissions.

<sup>5</sup>The NR architecture supports multiple Transmission Reception Point (TRP)s that act as dumb antennas and are coordinated by a gNB. Throughout this paper, we make the distinction only when needed but, in general, we refer to the NR access point as gNB.

Section XIII highlights future perspectives, and Section XIV concludes the paper.

## II. BACKGROUND REVIEW

In Fig. 1, we illustrate the timeline of different RATs that have been standardized for use in unlicensed spectrum (or are in the process of being standardized) so far. The timeline includes widely-deployed IEEE 802.11 standards (Wireless Local Area Networks (WLANs), commonly-known as Wi-Fi) with their different amendments, and the 3GPP based standards that follow different releases of LTE and NR. In 3GPP, two main groups have been created depending on the RAT that is used to access the unlicensed spectrum:

- 1) technologies that are based on the integration of LTE and Wi-Fi radio links and that use Wi-Fi to access the unlicensed spectrum (i.e., LTE-WLAN Aggregation (LWA) and enhanced LWA (eLWA), LTE-WLAN Radio Level Integration with IPsec Tunnel (LWIP) and enhanced LWIP (eLWIP)), and
- 2) technologies that use modified versions of LTE or NR to access and operate in the unlicensed spectrum (i.e., LTE-U, LAA and its various enhancements, namely enhanced LAA (eLAA) and further eLAA (FeLAA), MulteFire, and NR-U).

In Table I, we present a taxonomy of the different RATs that use unlicensed spectrum, including the standardization body, the underline technology, the operational unlicensed spectrum bands (sub 7 GHz and/or above 7 GHz bands), the supported deployment capabilities, the RAT that is used to access the unlicensed spectrum, and the supported key features in terms of frequency bands, maximum supported bandwidth (including aggregation), Multiple-Input Multiple-Output (MIMO) support, Multi-User MIMO (MU-MIMO) support, maximum supported modulation, HARQ support for combining transmissions, and the channel access scheme that is used in the unlicensed spectrum.

From Fig. 1 and Table I, it can be observed that IEEE 802.11 based technologies have been designed to access the unlicensed spectrum since 1997 and with the support of large bandwidth; on the other hand, 3GPP based technologies in unlicensed spectrum are more recent, and are characterized by a more sophisticated and efficient design, because they have been designed, since the very beginning, to operate in limited and expensive licensed spectrum. Nevertheless, with the latest amendments and versions (e.g., IEEE 802.11ax and NR-U), it is possible to observe that both the technologies are converging to use large bandwidth in a very efficient manner, through the support of key features such as HARQ, high-order modulations, and high-order MIMO.

	Standardization body	Underline Technology	Operational bands	Deployment capabilities	RAT in unlicensed	Key features
802.11n	IEEE	802.11a/g	sub 7 GHz	standalone (unlicensed)	Wi-Fi	Unlicensed bands: 2.4, 5 GHz Aggregated bandwidth: 40 MHz MIMO: up to 4 streams, MU-MIMO: no Modulation: up to 64-QAM HARQ: no channel access scheme: CSMA/CA
802.11ad	IEEE	802.11	above 7 GHz	standalone (unlicensed)	WiGig	Unlicensed bands: 60 GHz Aggregated bandwidth: 2.16 GHz MIMO: up to 8 streams, MU-MIMO: no Modulation: up to 64-QAM HARQ: no channel access scheme: CSMA/CA
802.11ac	IEEE	802.11n	sub 7 GHz	standalone (unlicensed)	Wi-Fi	Unlicensed bands: 5 GHz Aggregated bandwidth: 160 MHz MIMO: up to 8 streams, MU-MIMO: up to 4 Modulation: up to 256-QAM HARQ: no channel access scheme: CSMA/CA
LTE-U	LTE-U Forum	LTE Rel-12	sub 7 GHz	carrier aggregation (licensed + unlicensed)	LTE	Unlicensed bands: 5 GHz Aggregated bandwidth: 60 MHz MIMO: up to 8 streams, MU-MIMO: up to 4 Modulation: up to 256-QAM HARQ: yes channel access scheme: duty-cycle
LWA	3GPP	LTE Rel-13	sub 7 GHz	LTE + Wi-Fi integration at PDCP level	Wi-Fi	LTE Rel-13 + Wi-Fi
LWIP	3GPP	LTE Rel-13	sub 7 GHz	LTE + Wi-Fi integration at IP level	Wi-Fi	LTE Rel-13 + Wi-Fi
LAA	3GPP	LTE Rel-13	sub 7 GHz	carrier aggregation (licensed + unlicensed)	LTE	Unlicensed bands: 5 GHz Aggregated bandwidth: 80 MHz MIMO: up to 8 streams, MU-MIMO: up to 8 Modulation: up to 256-QAM HARQ: yes channel access scheme: LBT
MulteFire	MulteFire Alliance	LTE Rel-14	sub 7 GHz	standalone (unlicensed)	LTE	Unlicensed bands: 1.9, 2.4, 5 GHz Aggregated bandwidth: 80 MHz MIMO: up to 8 streams, MU-MIMO: up to 8 Modulation: up to 256-QAM HARQ: yes channel access scheme: LBT
eLWA	3GPP	LTE Rel-14	sub 7 GHz and above 7 GHz	LTE + Wi-Fi/WiGig integration at PDCP level	Wi-Fi/WiGig	LTE Rel-14 + Wi-Fi/WiGig
eLWIP	3GPP	LTE Rel-14	sub 7 GHz and above 7 GHz	LTE + Wi-Fi/WiGig integration at PDCP level	Wi-Fi/WiGig	LTE Rel-14 + Wi-Fi/WiGig
eLAA	3GPP	LTE Rel-14	sub 7 GHz	carrier aggregation (licensed + unlicensed), dual connectivity (licensed + unlicensed)	LTE	Unlicensed bands: 5 GHz Aggregated bandwidth: 80 MHz MIMO: up to 8 streams, MU-MIMO: up to 8 Modulation: up to 256-QAM HARQ: yes channel access scheme: LBT
FeLAA	3GPP	LTE Rel-15	sub 7 GHz	carrier aggregation (licensed + unlicensed), dual connectivity (licensed + unlicensed)	LTE	Unlicensed bands: 5 GHz Aggregated bandwidth: 100 MHz MIMO: up to 8 streams, MU-MIMO: up to 8 Modulation: up to 256-QAM HARQ: yes channel access scheme: LBT
802.11ax	IEEE	802.11ac	sub 7 GHz	standalone (unlicensed)	Wi-Fi	Unlicensed bands: 1 to 6 GHz Aggregated bandwidth: 160 MHz MIMO: up to 8 streams, MU-MIMO: up to 8 Modulation: up to 1024-QAM HARQ: yes channel access scheme: CSMA/CA
802.11ay	IEEE	802.11ad	above 7 GHz	standalone (unlicensed)	WiGig	Unlicensed bands: 60 GHz Aggregated bandwidth: 8.64 GHz MIMO: up to 8 streams, MU-MIMO: up to 8 Modulation: up to 64-QAM HARQ: no channel access scheme: CSMA/CA
NR-U	3GPP	NR Rel-17	sub 7 GHz and above 7 GHz	carrier aggregation (licensed + unlicensed), dual connectivity (licensed + unlicensed), standalone (unlicensed)	NR	Unlicensed bands: 2.4, 3.5, 5, 6, 37, 60 GHz Aggregated bandwidth: 800 MHz MIMO: up to 8 streams, MU-MIMO: up to 12 Modulation: up to 1024-QAM HARQ: yes channel access scheme: LBT

TABLE I: Taxonomy of technologies that use unlicensed spectrum.

In this paper, we focus on the operation of cellular networks in unlicensed spectrum, i.e., the second group of 3GPP based technologies listed before, with special emphasis on the unlicensed mmWave bands. As a result, in what follows we review only the state of the art related to the objective of this paper. Specifically, we first focus on the standardization and literature of the different variants of LTE in unlicensed spectrum. Then, we review the literature related to technologies that use directional transmissions for operation in unlicensed mmWave bands.

#### A. LTE in unlicensed spectrum (5 GHz band)

To let LTE gracefully coexist with Wi-Fi in the 5 GHz band with omnidirectional transmissions and receptions, different variants of LTE in unlicensed spectrum have been proposed, widely studied in the research literature, and standardized based on modifications over LTE. The different variants are: LAA [12], LTE-U [13], and MulteFire [15].

3GPP established work items on LAA in LTE Rel-13 [12] and on eLAA in LTE Rel-14 [29] to evaluate and specify DownLink (DL) and UpLink (UL) operations in the 5 GHz unlicensed band [30], respectively. Also, in LTE Rel-15, a work item on further enhancements to LTE operation in unlicensed spectrum (FeLAA) was concluded in 2018 [31]. LAA technologies (LAA/eLAA/FeLAA) operate as supplementary DL/UL carriers in unlicensed bands with anchor carriers in the licensed bands. As mentioned earlier, to meet worldwide regulation, a LBT-based channel access scheme was introduced in LAA technologies to access to the unlicensed band, which is similar to the CCA procedure used in IEEE 802.11-based technologies. An overview of LAA technology is presented in [11]. Interested readers can also look at the comprehensive survey about LAA/Wi-Fi coexistence in the 5 GHz band in [32], and references therein. In [33], an analytical framework based on Markov chain is developed to study the downlink throughput of LAA/Wi-Fi coexistence, for a simple LBT with fixed contention window size and simple scenarios composed of one AP and one LAA node. For 3GPP-based scenarios, the impact of several parameters related to the LAA LBT mechanism on the channel access opportunities of LAA and its coexistence performance, has been assessed through system-level simulations in [34].

In regions where the regulation does not require LBT, as in the USA, access schemes, other than the ones standardized by 3GPP, have been designed and produced. In particular, the industrial consortium LTE-U Forum specified a proprietary solution [13], known as LTE-U. As for LAA, LTE-U technology uses carrier aggregation of the unlicensed band with an anchor carrier in a licensed band. However, instead of relying on LBT for accessing the channel, it basically allows coexistence by duty-cycling the LTE continuous transmission. A comprehensive overview of the LTE-U technology, including implementation regulations, principles, and typical deployment scenarios, is presented in [2]. A highly performing access scheme for LTE-U (known as Carrier Sense Adaptive Transmission (CSAT)) is proposed in [35], in which the duty cycle is adapted based on the activity observed on the channel.

In [36], stochastic geometry is used to analyze LTE-U/Wi-Fi coexistence in terms of coverage probability and throughput, as well as to perform asymptotic analysis. Resource allocation for LTE-U is studied in [37], which also proposes a joint optimization of MAC and PHY layer parameters of the LTE-U network.

Multiple works have focused also on modeling, analyzing, and comparing LAA and LTE-U. Authors in [38] derive throughput and interference models for inter-technology coexistence analysis in the 5 GHz band, considering LBT-based as well as duty cycle-based access schemes. Through Monte Carlo simulations, they show that duty cycle (i.e., LTE-U) outperforms LAA LBT for low interference scenarios, while in high interference scenarios LBT outperforms duty cycle mechanisms. Comparisons are done also through simulations in [39] for various indoor and outdoor setups. In [40], a throughput model is presented to analyze LTE/Wi-Fi coexistence by focusing on the comparison of LBT versus CSAT. They conclude that, when optimally configured, both LAA and LTE-U approaches are capable of providing the same level of fairness to Wi-Fi. Authors in [41] model, analyze, and compare different coexistence mechanisms including plain LTE, LTE with discontinuous transmission (LTE-U), and LTE with LBT (LAA). Therein, by leveraging on stochastic geometry, authors analytically derive and numerically evaluate the medium access probability, the Signal to Interference-plus-Noise Ratio (SINR) coverage probability, density of successful transmission, and the rate coverage probability.

In general, for the 5 GHz band, it is generally considered that LAA is fairer to Wi-Fi than LTE-U, because it uses the LBT mechanism and so it abides similar rules as Wi-Fi. Recently, authors in [42], have presented a detailed coexistence study and comparison of LAA and LTE-U technologies through network simulations, and evaluated how the channel access procedures, besides other important aspects like the traffic patterns, simulation setup, and proprietary implementation choices, impact on the coexistence results.

Finally, the MulteFire Alliance launched the development of a new LTE-based technology capable of operating standalone in unlicensed or shared spectrum bands, also known as MulteFire [15], [43], [44], without using any licensed carrier as an anchor. An overview of MulteFire is presented in [14], including the main challenges due to LBT and the standalone operation, as well as the solutions adopted in MulteFire to overcome such challenges and the attained performance benefits. The standalone operation in unlicensed bands may open a new class of wireless private networks, e.g., for Industry 4.0 scenarios [45]. However, it also becomes difficult to operate without any support from licensed carriers. For example, in standalone operation, latency may be increased because of the LBT requirement for each new transmission [46].

A comparative analysis of the three LTE variants (LAA, LTE-U, and MulteFire) is provided in [3], including technical details of each RAT and their operational features and coexistence capabilities.

Research on the different variants of LTE in unlicensed spectrum for 5G is still on-going to improve the coexistence with Wi-Fi in sub 7 GHz bands. For example, authors

in [47] propose channel selection algorithms for 5G eLAA. Recently, authors in [48] presented the massive MIMO unlicensed (mMIMO-U) technology for sub 7 GHz bands. The mMIMO-U enhances LBT by placing radiation nulls toward neighboring Wi-Fi nodes, provided that Wi-Fi nodes can be detected by the gNBs. Authors in [49] present a cooperative LBT scheme with omnidirectional transmissions/receptions, whereby neighboring gNBs are allowed to cooperate in the sensing and transmission phases to improve the Quality of Service (QoS). Let us remark that some features of LAA-based technologies and MulteFire can be reused for NR-U, specially for what regards initial access from LAA and regarding HARQ procedures and scheduling from MulteFire standalone operation, but they need to be adapted and/or improved for beam-based transmissions in NR-U (as we will review later).

### B. Technologies in unlicensed mmWave bands

One of the key features of NR, as compared to LTE, is the wide-band support for operation at mmWave carrier frequencies [9]. For that, multiple procedures for beam-related operations have been defined in the NR standard, including beam sweeping, beam measurement, beam determination, and beam reporting [10]. In terms of NR to make it operate in shared/unlicensed mmWave bands, related works include [50]–[54]. Authors in [50], [51] present beam scheduling solutions that are based on iterative coordination of the concurrent transmissions of different base stations by means of properly selecting their transmit beams. Also, multiple solutions based on spectrum sharing [52], [53] and spectrum pooling [54] have been recently proposed, which exploit coordination among different cellular network operators to improve the spatial reuse. However, these solutions cannot ensure fair coexistence of NR-U with other RATs in the unlicensed bands because they do not employ mechanisms to avoid continuous use of the spectrum (as it is the case of LBT or duty-cycling).

IEEE 802.11 WLANs standards have started technology development to use the unlicensed spectrum at mmWave bands few years ago through 802.11ad specification [21], and its recent enhancement in 802.11ay specification [22] (see Fig. 1). In this regard, both IEEE 802.11ad and 802.11ay have standardized specific beam training processes for directional transmissions [55]. However, in these specifications, CCA within CSMA/CA is still defined with omnidirectional sensing. In [56], an enhanced distributed MAC protocol is proposed for CSMA-based mesh networks employing directional transmissions at 60 GHz. The proposed solution uses memory at the nodes to achieve approximate TDMA schedules without explicit coordination.

In the area of IEEE 802.15 Wireless Personal Area Networks (WPANs) standards (including the well-known Bluetooth and ZigBee), technology development to use the unlicensed mmWave bands has also been considered since few years ago in 802.15.3c specification. To enhance IEEE 802.15 WPANs, multiple solutions have been proposed for beam management and time-domain coordination in mmWave bands [57]–[59]. A time division multiple access (TDMA)

based channel allocation scheme for directional transmissions is proposed in [57]. An enhanced MAC with frame aggregation, unequal error protection, and block acknowledgment is defined in [58]. Authors in [59] introduced the concept of an exclusive region to enable concurrent transmission with significant interference reduction in mmWave WPANs, by considering all kinds of directional and omnidirectional transmission/reception antenna patterns.

The coordination of the transmit beams (as proposed in [50], [51], [59]) and the coordination of the channel access in time domain (as analyzed in [57], [58]) solve hidden node problems that arise in the unlicensed spectrum. However, since these kinds of solutions require coordination between Wi-Fi/WiGig and cellular devices, they are not adequate for multi-RAT coexistence scenarios. Instead, distributed uncoordinated approaches are needed. For that reason, and also due to regulation mandate, LBT was adopted to control the channel accesses in LAA/eLAA/FeLAA and MulteFire.

### C. Towards NR-U

In case of directional transmissions, LBT might not work well because of the increased hidden and exposed node problems [26], [60]. For example, when the carrier sense is done omnidirectionally, i.e., Omnidirectional LBT (omniLBT), while the intended transmission is beam-based, there is a higher chance of exposed node problems (as it happens in WiGig). If the direction of the intended communication is known, directional carrier sense, i.e., Directional LBT (dirLBT), may help to improve the spatial reuse but it may lead to hidden node problems [61]. This phenomenon is the so-called omniLBT/dirLBT trade-off. It is shown in [62] that, for low network densities, dirLBT performs significantly better than omniLBT, while for high network densities, omniLBT is a better technique. Therefore, new regulatory-friendly and distributed channel access schemes are needed to address coexistence for NR-U under beam-based transmissions.

From the 3GPP standardization point of view, NR-U for sub 7 GHz is currently being standardized by 3GPP, and NR-U in mmWave bands is planned to be addressed in future releases of 3GPP (i.e., NR Rel-17 and beyond). In the literature, NR-U with beam-based transmissions has not been discussed sufficiently. There have only been some work on the channel access procedures [60], [62]–[65]. To address the omniLBT/dirLBT trade-off, two distributed LBT-based channel access procedures have been proposed by the same authors for beam-based NR-U, namely Paired LBT (pairLBT) [62] and LBT switching (LBTswitch) [60], which we will further review, discuss, and compare throughout this paper. Even though, in the case of beam-based transmissions, there are interference situations that cannot be detected at the transmitter due to the significant difference in the interference dynamics at the transmitter and receiver sides. Remarkably, in some cases, it is only the receiver that can be aware of potential interference situations [63]. Therefore, LBT at the transmitter may not be useful to detect such interference. In this line, a technique called Listen-After-Talk (LAT) is introduced in [66, Sec. 8.2.2]. This approach is certainly of

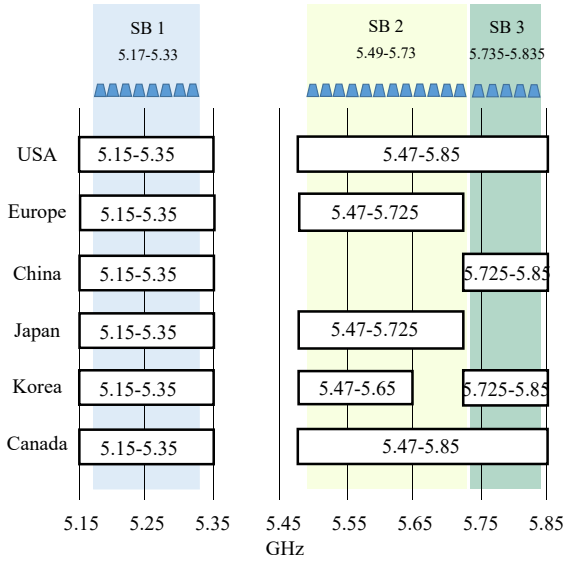

Fig. 2: 5 GHz unlicensed spectrum allocation in different areas of the world.

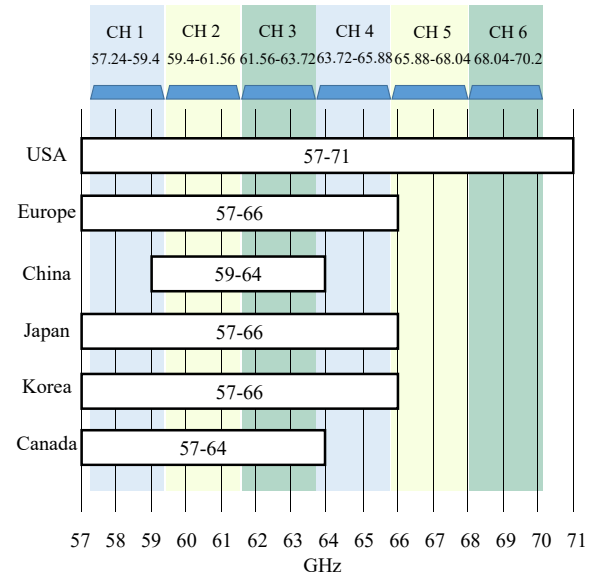

Fig. 3: 60 GHz unlicensed spectrum allocation in different areas of the world.

interest but it is not compliant with regulations regarding LBT requirement. This can be solved by employing receiver-assisted LBT procedures [64, Sec. 7.6.4], or Listen-Before-Receive (LBR) [63], wherein the transmitter triggers a carrier sense at the receiver that is used to complement LBT. Recently, going deeper into this issue, authors in [65] proposed a joint directional LBT-LBR and beam training for NR-U in mmWave bands.

### III. SPECTRUM ALLOCATION AND REGULATORY REQUIREMENTS

Operation in unlicensed spectrum is subject to different regulatory limitations and restrictions that are region- and band-specific. In this section, we review the spectrum allocation and the regulatory requirements for the 5 GHz and 60 GHz bands, which have common global availability and for which most major geographical areas worldwide have authorized wide unlicensed spectrum bandwidth. Also, we review the spectrum allocation for the 6 GHz band, which has been recently allocated for unlicensed use in Europe and the USA.

#### A. Spectrum Allocation

In Fig. 2 and Fig. 3, we show the unlicensed spectrum allocation of major geographic areas of the world for the 5 GHz band and the 60 GHz band, respectively, including IEEE 802.11ac channelization in Fig. 2 and IEEE 802.11ad channelization in Fig. 3. Three subbands are available in the 5 GHz band and, according to IEEE 802.11ac channelization [67], each subband is further divided into multiple non-overlapping channels of 20 MHz bandwidth each. On the other hand, IEEE 802.11ad channelization in the 60 GHz band supports up to six non-overlapping channels of 2.16 GHz bandwidth each, thus having a lower number of channels but much wider channel bandwidths than Wi-Fi in the 5 GHz band.

At the time of writing, the USA and Europe are analyzing the potential of the 6 GHz band for unlicensed use. The spectrum considered in the USA (5.925-7.125 GHz) and

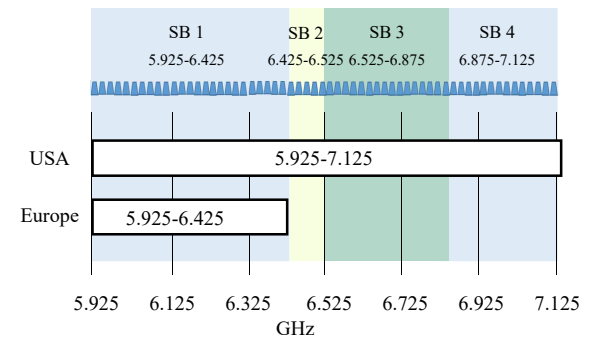

Fig. 4: 6 GHz potential unlicensed spectrum allocation in the USA and Europe.

Europe (5.925-6.425 GHz) is illustrated in Fig. 4, alongside IEEE 802.11ax 20 MHz channelization.

#### B. Regulatory Requirements

European Telecommunications Standards Institute (ETSI) regulation has harmonized the requirements for the 5 GHz band (5.15-5.35 GHz and 5.47-5.725 GHz) and the 60 GHz band (57-66 GHz), as included in [68] and [23], respectively. To enable worldwide regulation-compliant access and satisfy a fair coexistence with the unlicensed systems (Wi-Fi, WiGig, radar) and intra-RAT services, any technology that attempts accessing to the unlicensed spectrum (like NR-U) should fulfill the following regulatory requirements:

- **Listen-Before-Talk (LBT):** The LBT procedure is a mechanism by which a device should apply a CCA check (i.e., spectrum sensing for a certain period, called the CCA period) before using the channel and which imposes certain rules after determining the channel to be busy. CCA uses Energy Detection (ED) to detect the presence (i.e., channel is busy) or absence (i.e., channel is idle) of other signals on the channel. If the detected energy during an initial CCA period is lower than a certain threshold (the ED threshold), the device can access the

channel for a period called Channel Occupancy Time (COT). Otherwise, an extended CCA period starts, in which the detected energy is again compared against the ED threshold until channel access is granted. LBT is a mandatory procedure in Europe and Japan for the 5 GHz and 60 GHz bands but it is not required in other regions like the USA and China. The LBT mechanism and its parameters are specified in [68] and [23]. Briefly, for each band, the regulation specifies the CCA slot duration (9  $\mu$ s in the 5 GHz band, and 5  $\mu$ s in the 60 GHz band), the initial and extended CCA check times (e.g., a multiple of 5  $\mu$ s for initial CCA and  $8+m \times 5$   $\mu$ s for extended CCA in the 60 GHz band, where  $m$  controls the backoff), and the ED threshold ( $-72$  dBm for a 20 MHz channel bandwidth in the 5 GHz band, and  $-47$  dBm for 40 dBm of radiated power in the 60 GHz band).

- **Maximum Channel Occupancy Time (MCOT):** Certain regions such as Europe and Japan prohibit continuous transmission in the unlicensed spectrum and impose limits on the COT, i.e., the maximum continuous time a device can use the channel. The MCOT in the 5 GHz band is limited to 2 ms, 4 ms, or 6 ms depending on the channel access priority class, and it may be increased up to 8-10 ms in some cases [68]. The MCOT in the 60 GHz band is 9 ms [23]. Besides, for the 5 GHz and 60 GHz bands, it is allowed to share the COT with the associated devices (e.g., gNB and UEs), and thus enable a contiguous combination of DL and UL transmissions within the COT. Sharing the COT means that once the initiating device (gNB) gets access to the channel through LBT and transmits, the responding devices (UEs) are allowed to skip the CCA check and immediately transmit in response to the received frames [23].
- **Equivalent Isotropically Radiated Power (EIRP) and Power Spectral Density (PSD):** Operation in the unlicensed spectrum is subject to power limits in all regions and bands, in terms of EIRP and PSD, to constrain the generated inter-RAT and intra-RAT interference levels. According to ETSI regulation [68], in the 5 GHz band, the maximum mean EIRP and PSD with transmit power control for 5.15-5.35 GHz range are limited to 23 dBm and 10 dBm/MHz, respectively, and for 5.47-5.725 GHz range, are limited to 30 dBm and 17 dBm/MHz, respectively. In the 60 GHz band, the maximum mean EIRP and PSD are limited to 40 dBm and 13 dBm/MHz, respectively [23]. Besides the ETSI power limits, more restrictive power limits are imposed in some regions [19]. For example, the USA differentiates among indoor and outdoor devices with different power limits [4], [69].
- **Occupied Channel Bandwidth (OCB):** The OCB is defined as the bandwidth containing 99% of the signal power and, in certain regions, it should be larger than a percentage of the Nominal Channel Bandwidth (NCB) (i.e., the channel width). This enforces the unlicensed technologies to use major part of the channel bandwidth when they access the channel. According to ETSI, for the 5 GHz band, the OCB shall be between 70% and 100%

of the NCB [68]. In the 60 GHz band, the OCB shall be in between 80% and 100% of the NCB [23].

- **Frequency Reuse (FR):** The FR process allows reusing the same channel at the same time by different devices of the same RAT. In general, if a device is accessing the channel, then other devices in its coverage area should be muted in this channel so that it cannot be reused at the same time. This reduces the number of devices that access simultaneously (i.e., the FR factor). The FR mechanism is designed to allow devices of the same operator to access the channel simultaneously, and hence increase the FR factor and improve the spectral efficiency. This is done by using different ED thresholds for intra-RAT and inter-RAT signals, provided that the devices can distinguish between these two types of signals<sup>6</sup>.
- **Dynamic Frequency Selection (DFS):** DFS functionality is used to avoid interfering with 5 GHz and 60 GHz radar systems, as well as to uniformly spread the traffic load across the different channels in each band. The regulation states that whenever radar signals are detected, a device must switch to another channel to avoid interference.

#### IV. NR-U SCENARIOS AND LBT SPECIFICATIONS

##### A. NR-U Scenarios

LAA, LTE-U, and MulteFire technologies were specifically designed to operate in the 5 GHz band. Differently, NR-U considers multiple bands: 2.4 GHz (unlicensed worldwide), 3.5 GHz (shared in the USA), 5 GHz (unlicensed worldwide), 6 GHz (unlicensed in the USA and Europe), 37 GHz (shared in the USA), and 60 GHz (unlicensed worldwide). The 3GPP classifies these bands for NR-U as sub 7 GHz and mmWave bands. Sub 7 GHz bands include the 2.4, 3.5, 5, and 6 GHz bands; meanwhile mmWave bands encompass the 37 and 60 GHz bands. First efforts in the NR-U standardization focus on sub 7 GHz bands [17] and mmWave bands will be addressed later. Therefore, four *layout scenarios* can be defined for NR-U based on the deployment and propagation environment conditions:

- indoor sub 7 GHz,
- indoor mmWave,
- outdoor sub 7 GHz,
- outdoor mmWave.

The NR-U layout scenarios are shown in Fig. 5. According to standard terminology, operator A and operator B in the figure are used to denoting two different RATs (and thus address, e.g., Wi-Fi and NR-U coexistence) or two operators of the same RAT, e.g., to evaluate either Wi-Fi/Wi-Fi or NR-U/NR-U coexistence. The more details on the simulation methodology and parameters for indoor and outdoor sub 7 GHz can be found in the 3GPP report TR 38.889 [17, Sec. 8.1].

<sup>6</sup>For example, LAA supports FR with an ED threshold of  $-52$  dBm for intra-RAT signals (i.e., LAA signals), as compared to  $-72$  dBm of ED threshold used for inter-RAT signals (e.g., Wi-Fi signals). On the other hand, Wi-Fi is designed to avoid FR, especially among Wi-Fi nodes. For that, Wi-Fi supports preamble detection to identify intra-RAT signals, and it uses  $-82$  dBm of preamble detection threshold for Wi-Fi signals while a  $-62$  dBm of ED threshold for non-Wi-Fi signals in the 5 GHz band.



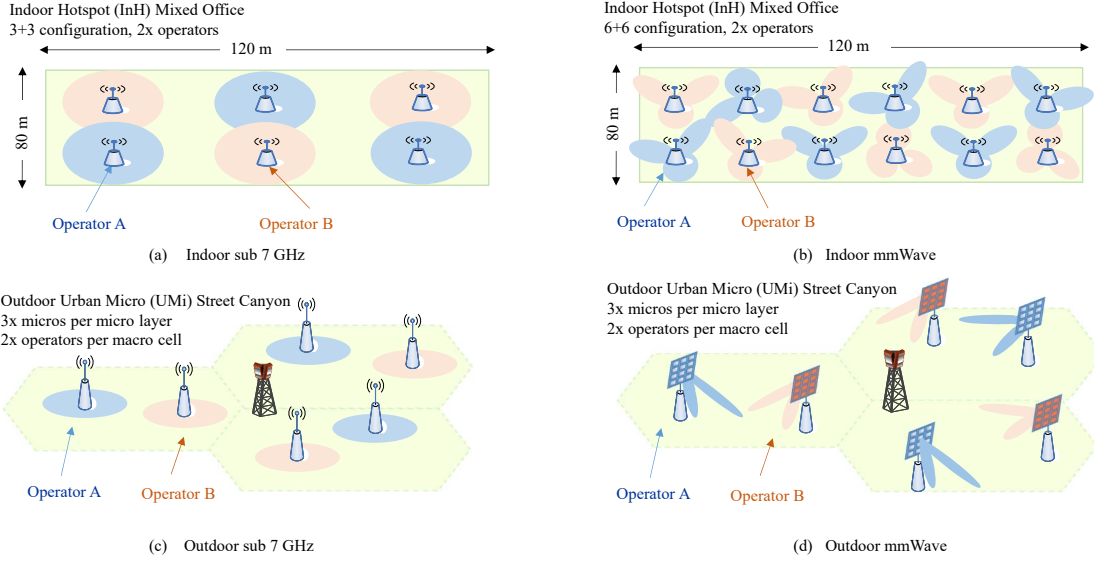

Fig. 5: NR-U layout scenarios.

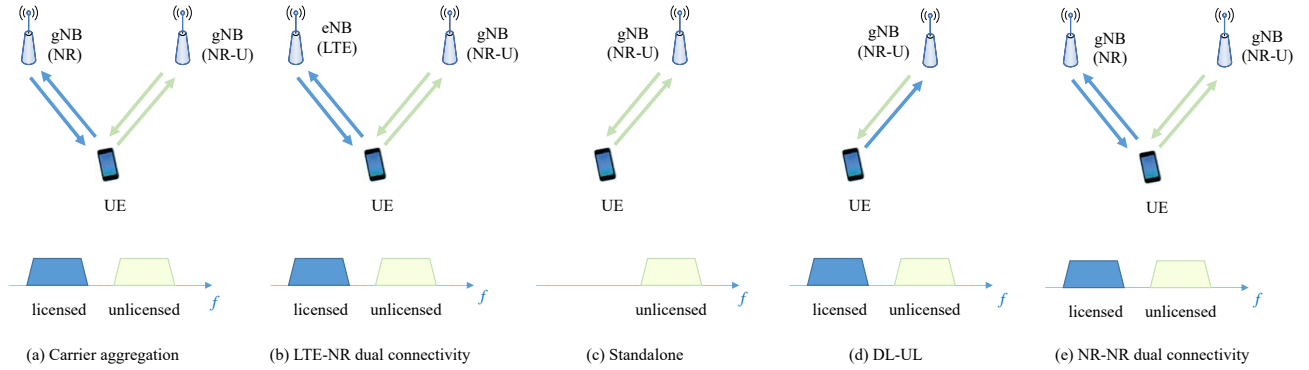

Fig. 6: NR-U deployment scenarios.

To assess the coexistence, five different *deployment scenarios* are defined for NR-U in 3GPP [17, Sec. 6]:

- Carrier aggregation between licensed band NR and unlicensed band NR-U,
- Dual connectivity between licensed band LTE and unlicensed band NR-U,
- Standalone unlicensed band NR-U,
- NR with DL in unlicensed band and UL in licensed band,
- Dual connectivity between licensed band NR and unlicensed band NR-U.

The NR-U deployment scenarios are illustrated in Fig. 6. All of them can be applied to each of the NR-U layout scenarios shown in Fig. 5. The carrier aggregation scenario follows the approach in LAA technologies, with the possibility of NR-U for both supplementary DL and UL. The standalone scenario resembles the MulteFire approach. Note that the NR-U design is further complicated in the standalone deployment scenario because all the signals must use the unlicensed band, thus significantly affecting the initial access and scheduling procedures.

The performance metrics for NR-U coexistence evaluation are the same as in LAA [12]. These include, user packet throughput and delay (mean value and value at the 5th,

50th, and 95th percentiles) for low, medium and high loads, measured separately for DL and UL, thus leading to 48 metrics. Also, buffer occupancy is measured for NR-U and Wi-Fi, separately. The coexistence evaluation scenarios include Wi-Fi/Wi-Fi, Wi-Fi/NR-U, and NR-U/NR-U [17].

The coexistence requirement for NR-U (i.e., the fairness definition) remains the same as in LAA, in which NR-U devices should not impact deployed Wi-Fi/WiGig services (data, video, and voice services) more than an additional Wi-Fi/WiGig network would do on the same carrier [16]. Therefore, the standard way to evaluate the fairness is to first consider a Wi-Fi/Wi-Fi deployment (operator A/operator B) in any of the layout scenarios in Fig. 5, and then replace one Wi-Fi network by an NR-U network to assess the Wi-Fi/NR-U coexistence and determine the impact of NR-U on the Wi-Fi system as compared to the Wi-Fi/Wi-Fi deployment.

## B. LBT Specifications

3GPP has specified four LBT categories for NR-U [17]:

- Category 1 (Cat 1 LBT): Immediate transmission after a short switching gap of 16  $\mu$ s.

- Category 2 (Cat 2 LBT): LBT without random back-off, in which the CCA period is deterministic (e.g., fixed to 25  $\mu$ s).
- Category 3 (Cat 3 LBT): LBT with random back-off with a contention window of fixed size, in which the extended CCA period is drawn by a random number within a fixed contention window.
- Category 4 (Cat 4 LBT): LBT with random back-off with a contention window of variable size, in which the extended CCA period is drawn by a random number within a contention window, whose size can vary based on channel dynamics.

For different transmissions in a COT and various channels/signals to be transmitted, different categories can be used. In brief, as in LAA, Cat 4 LBT is used for gNB or UE to initiate a COT for data transmissions, while gNB can use Cat 2 LBT for specific signaling like discovery reference signals (see details in [17]).

The rules for shared COT have also been defined for NR-U in [17]. For a gNB initiated COT, the responding devices are allowed to transmit without performing a CCA check (i.e., Cat 1 LBT) if there is a gap in between DL and UL transmissions of less than 16  $\mu$ s. For a gap of more than 16  $\mu$ s but less than 25  $\mu$ s, within the COT, only a short sensing (i.e., Cat 2 LBT) is needed at the responding devices. Otherwise, if the gap is longer than 25  $\mu$ s, regular LBT (i.e., Cat 4 LBT for data) has to be done at responding devices. Besides, differently to LAA that supported a single DL/UL switching point within the COT, NR-U supports multiple DL/UL switching points within the COT [70, Sec. 7.6.2].

## V. FROM NR TO NR-U

The NR-U system should be flexible enough not only to support the different layout and deployment scenarios shown in Fig. 5 and Fig. 6 but also to follow region- and band-specific regulatory requirements (e.g., LBT, see Section III.B) to gracefully coexist with other users of the unlicensed spectrum (Wi-Fi, WiGig, radar). NR has already paved the way for a fully flexible and configurable technology [7]. In particular, NR design is highly flexible to:

- support a wide range of use cases (e.g., enhanced Mobile BroadBand (eMBB), massive Machine Type Communications (mMTC), Ultra-Reliable and Low-Latency Communications (URLLC), and enhanced Vehicle to anything communications (eV2X)) [71],
- operate in a wide range of carrier frequencies (sub 6 GHz and mmWave bands<sup>7</sup>) with different channel bandwidths,
- enable different deployment options (in terms of inter-site distance, number of antennas, beamforming structures), and
- address a variety of architectures (non-centralized, centralized, co-sited with E-UTRA, and shared Radio Access Network (RAN)).

<sup>7</sup>NR in Rel-15 has been designed for up to 52.6 GHz frequencies. The frequencies above 52.6 GHz, including the unlicensed spectrum in the 60 GHz band, are expected to be part of future releases.

Some of the key NR features that enable such a flexible and configurable RAT are:

- a flexible Orthogonal Frequency Division Multiplexing (OFDM) system with multiple numerologies support [7, Sec. 5.1], [27], [72],
- configurable frame and slot structures that allow fast DL-UL switch for bidirectional transmissions [73, Sec. 4.3.2], [74],
- a mini-slot-based transmission which, for the unlicensed bands, may also provide an efficient way to reduce the latency from CCA end to the start of the NR-U transmission [75], [76],
- the definition of bandwidth parts and bandwidth adaptation for energy-saving purposes as well as to multiplex services with different QoS requirements [7, Sec. 6.10], [77], [78],
- support for beam management procedures (including beam determination, measurement, reporting, and sweeping) at both sub 6 GHz and mmWave bands [8, Sec. 8.2.1.6.1], [10], [79], [80],
- new dynamic NR scheduling timing parameters [81], [82] to flexibly govern the communication timings between gNBs and UEs, and which notably reduce the high processing delays in LTE.

In terms of NR operation in unlicensed bands, we compare it with the different variants of LTE in unlicensed spectrum, i.e., LAA, LTE-U, and MulteFire, in Table II. Thanks to the flexibility inherited from NR, the NR-U system has great potential to perform well in coexistence scenarios. As compared to LTE in unlicensed spectrum, in NR-U, we may expect: 1) a lower interference generation owing to the beam-based transmissions that allow exploiting the spatial domain, and 2) a lower latency thanks to the reduced processing times as well as the better scheduling time-resource granularity provided by the NR numerologies.

The designs of LAA and MulteFire technologies have considered the worldwide regulatory requirements of the 5 GHz band through enhancements over LTE. For NR-U, further flexibility is needed to meet the worldwide regulatory requirements of multiple operational bands, as well as to provide support for them under beam-based transmissions. Some of the design principles that need to be rethought in beam-based NR-U are [64]:

- the channel access procedure,
- the COT structure,
- the initial access procedure,
- the HARQ procedure, and
- the MAC scheduling scheme.

As previously highlighted, traditional LBT might be insufficient under beam-based transmissions. As such, new regulation-compliant and distributed channel access procedures are needed. As far as the COT structure is considered, NR inherently includes a very flexible design due to the multiple numerologies support, but it still can be optimized for unlicensed-based access in TDD systems to meet the MCOT limit while reducing the access delay and enabling fast DL-UL responses when needed. The initial access and

	NR-U	LAA	LTE-U	MulteFire
Deployment scenario	carrier aggregation, dual connectivity (NR-NR, LTE-NR), standalone, DL-UL	carrier aggregation	carrier aggregation	standalone
Operational bands	2.4, 3.5, 5, 6, 37, 60 GHz	5 GHz	5 GHz	5 GHz
Duplexing mode	FDD, semi-static TDD, dynamic TDD	FDD (LAA), semi-static TDD (eLAA)	FDD	semi-static TDD
Channel access scheme	LBT	LBT	duty-cycle	LBT
Type of carrier sense	omni/dir	omni	-	omni
Dimensions for carrier sense	time, frequency (channel and bandwidth part), space	time, frequency (channel)	-	time, frequency (channel)
Scheduling dimensions	time, frequency, space	time, frequency	time, frequency	time, frequency
Processing delays (described in Section X)	1 slot: 1, 0.5, 0.25, 0.125 ms (numerology-dependent)	1 subframe: 1 ms	1 subframe: 1 ms	1 subframe: 1 ms
Time-domain resource allocation granularity	1 OFDM symbol: 0.066, 0.033, 0.017, 0.008 ms	1 subframe: 1 ms	1 subframe: 1 ms	1 subframe: 1 ms
Frequency-domain resource allocation granularity	1 Resource Block (RB): 180, 260, 720, 1440 kHz (numerology-dependent)	1 RB: 180 kHz	1 RB: 180 kHz	1 RB: 180 kHz

TABLE II: Comparison of NR-U and the different variants of LTE in unlicensed spectrum.

HARQ procedures that have been adopted in NR can be reused for NR-U. However, some initial access principles need to be rethought to meet the regulatory requirements (e.g., OCB). Moreover, in case of standalone operation in unlicensed spectrum, the HARQ and initial access procedures need to be improved to mitigate the negative impact that LBT could have on the latency performance.

In the next sections, we highlight the problems, review the available solutions, and propose new potential solutions, for each of these NR-U procedures. We would like to recall that all the procedures are susceptible to be standardized.

## VI. CHANNEL ACCESS PROCEDURES FOR NR-U

NR-U is required to ensure fair coexistence with other incumbent RATs according to the regulatory requirements in the corresponding bands. An appropriate channel access design, including LBT, is the key to allow a fair coexistence in all the NR-U deployment scenarios shown in Fig. 6 (carrier aggregation, dual connectivity, and standalone), even when not mandated by the regulation [70, Sec. 7.6.4], [64, Sec. 7.6.4]. The LBT aspects that need to be designed and/or improved for beam-based NR-U beyond LBT mechanisms in LAA and MulteFire, are:

- *LBT for beam-based transmissions*: LBT is a spectrum sharing mechanism that works across different RATs. As explained in Section II, it suffers from the hidden node and exposed node problems, which become even more likely and accentuated in case of beam-based transmissions. When an omnidirectional antenna pattern is used for carrier sense while a directional antenna pattern is used for (beam-based) transmission (as it happens in WiGig), there is a higher chance of a node being exposed. If the direction of the communication is known, directional carrier sense may help in certain situations but it may also lead to hidden node problems. In this line, as highlighted by 3GPP, effects of the directivity of the carrier sense, for beam-based NR-U, should be

studied thoroughly and improved to maximize the system performance [83], [84].

- *Receiver-assisted LBT for beam-based transmissions*: LBT has been widely adopted in LAA and MulteFire. However, as introduced in Section II, in case of beam-based transmissions, there are interference situations that can no longer be detected with carrier sense at the transmitting node (gNB) because listening to the channel at the transmitter may not detect activity near to the receivers. The receivers are in a better position to assess potential interference, and thus the assistance from the UE to gNB can help to better manage interference. Therefore, as agreed among 3GPP members, interference mitigation schemes that utilize information from the UE need to be considered for beam-based NR-U [83], [85].
- *Intra-RAT tight frequency reuse*: Modern cellular networks in licensed spectrum employ full frequency reuse along with interference management techniques to mitigate inter-cell interference. NR-U channel access procedures could adopt similar principles within the same RAT, or at least within nodes of the same RAT that are deployed by the same operator. However, as LBT operation based solely on ED is uncoordinated inherently, it results in unnecessary blocking among different nodes of the same RAT, and thus it reduces the spatial reuse and efficiency as compared to full frequency reuse. Accordingly, new frequency reuse methods are needed to avoid LBT blocking within NR-U devices of the same operator, or among devices of different operators if coordination among them is permitted, as highlighted by 3GPP [84], [86].
- *Congestion Window Size (CWS) adjustment for beam-based transmissions*: The CWS is an LBT parameter that controls the backoff period after collisions for Cat 4 LBT, i.e., the LBT category used for data transmissions (see Section IV.B). LAA-based technologies update the maximum CWS based on HARQ feedback, and in particular based on the percentage of Negative Acknowledgement (NACK)s received. This procedure has some drawbacks,

as NACKs do not necessarily reflect collisions and introduce delays into the CWS update procedure. Moreover, under beam-based transmission, the directionality also makes that some collisions may not be related to the transmit beam for which the CWS is being updated, e.g., collisions due to interference coming from other directions. As such, from the authors' point of view, new procedures for CWS adjustment under beam-based transmissions should be defined for NR-U.

Further in this section, we review the above challenges in more detail and discuss solutions to each of them.

#### A. LBT for Beam-based Transmissions

Two LBT sensing approaches are envisioned for NR-U to ensure a fair multi-RAT coexistence in unlicensed bands with beam-based transmissions: **omniLBT** and **dirLBT** [61]. omniLBT senses omnidirectionally, while dirLBT senses in a directional manner within the transmit beam towards the intended receiver. Wi-Fi and WiGig use omniLBT.

Under directional transmissions, omniLBT causes overprotection because a transmission is prevented even if a signal is detected from a direction that may not create harmful interference for the intended receiver. It is an exposed node problem, as shown in Fig. 7.(a)-middle, for gNB-UE, which could have reused the spectrum but have been prevented by omniLBT at gNB. omniLBT is only correct when transmissions are aligned in space, see Fig. 7.(a)-top. In contrast, dirLBT does not create overprotection because it only senses the spatial direction in which the transmission will be carried out (see Fig. 7.(b)-middle). However, in dirLBT, on-going nearby transmissions might not be detected, and directional hidden node problems may cause interference as shown in Fig. 7.(b)-top, because the transmission of AP lies within the antenna boresight of the UE. The above results in an omniLBT that is overprotective and prevents spatial reuse, and a dirLBT that enables spatial reuse with some hidden node problems.

To properly address the omniLBT/dirLBT trade-off, in [62] a distributed solution is proposed, called **pairLBT**. The key idea of pairLBT is to perform directional sensing in paired directions, i.e., in the transmitting direction (which is equivalent to perform legacy dirLBT) and its opposite direction(s). The opposite directions can denote a single direction or a set of directions depending on whether the beams for carrier sense are either reconfigurable or predefined based on a set of previously configured beams, respectively. In this line, in [62], analytic expressions are derived to optimize the parameters (beam shape and ED threshold) for LBT in the opposite direction(s) with the objective of reducing hidden node problems. Additional extensions to the pairLBT are also proposed, which use the sensed power during the sensing phase in the opposite direction(s) to properly adjust the transmit/receive strategy. Fig. 7.(c) shows how the omniLBT/dirLBT trade-offs are addressed by pairLBT. It is shown in [62] through simulations that the pairLBT solution allows improving the ability to perform carrier sense by avoiding hidden node problems, which appear under dirLBT, and by stimulating spatial reuse, which is prevented under omniLBT (see Fig. 7).

All in all, pairLBT is a simple and fully distributed technique that ensures a fair indoor coexistence of different RATs in unlicensed spectrum, and which can be properly adjusted to the network density and beamwidth configurations by optimizing the LBT parameters. Note, however, that the procedure, as defined in [62], applies only to indoor scenarios (i.e., indoor mmWave shown in Fig. 5.(b)), since for outdoor scenarios a new dimension (the height) should be added to the definition and optimization.

Results in [62] also demonstrate the trade-off between omniLBT and dirLBT. It is shown that for low network densities, dirLBT performs significantly better than omniLBT, while for high network density, omniLBT is a good technique. The trade-off is also observed based on the beamwidth configuration (narrow versus wide beams). Based on that, another solution to deal with the omniLBT/dirLBT trade-off is to implement an **LBTswitch** scheme [60]. This scheme basically switches the type of carrier sense between omnidirectional and directional, based on the beamwidth configuration and density of neighboring nodes. Moreover, a dynamic switching method can also be implemented, where switching from dirLBT to omniLBT could be done based on indications like HARQ feedback, UE measurements, etc., to detect an excess of hidden node situations. To switch from omniLBT to dirLBT, a new procedure to measure the overprotective level of omniLBT (i.e., an excess of exposed node situations) should be introduced, as detailed in [60].

The omniLBT-dirLBT trade-off, as well as how the pairLBT and LBTswitch procedures address the trade-off, is shown in Fig. 7 for three different deployment configurations in a DL scenario with two pairs (gNB-UE and AP-STA):

- *top*: fully-aligned (i.e., AP, gNB, STA, and UE are aligned in the same spatial line),
- *middle*: aligned transmitters (i.e., gNB is in the coverage area of AP),
- *bottom*: aligned receivers (i.e., UE is in the coverage area of AP).

For each configuration, we illustrate the behavior with different gNB channel access procedures and what happens when the sensing strategy fails (e.g., interference occurs or transmission is unnecessarily prevented). In the case of LBTswitch technique, we depict the sensing strategy (dirLBT, omniLBT) that the gNB would use on each of the deployment configurations. The correct gNB behavior in each deployment configuration is: *transmission prevented* for the fully-aligned configuration (which occurs with omniLBT, pairLBT, LBTswitch), *transmission allowed* for aligned transmitters configuration (which occurs with dirLBT, pairLBT, LBTswitch), and *transmission prevented* for aligned receivers configuration (which is not achieved with any of the methods).

In Table III, we provide a summary of the requirements of each LBT-based strategy to illustrate the differences in the implementation complexity. Note that omniLBT, dirLBT, pairLBT are distributed procedures that can be implemented without UE's assistance, while LBTswitch is also distributed but requires information from the UE to properly adapt the type of carrier sense based on the UE's observation (see

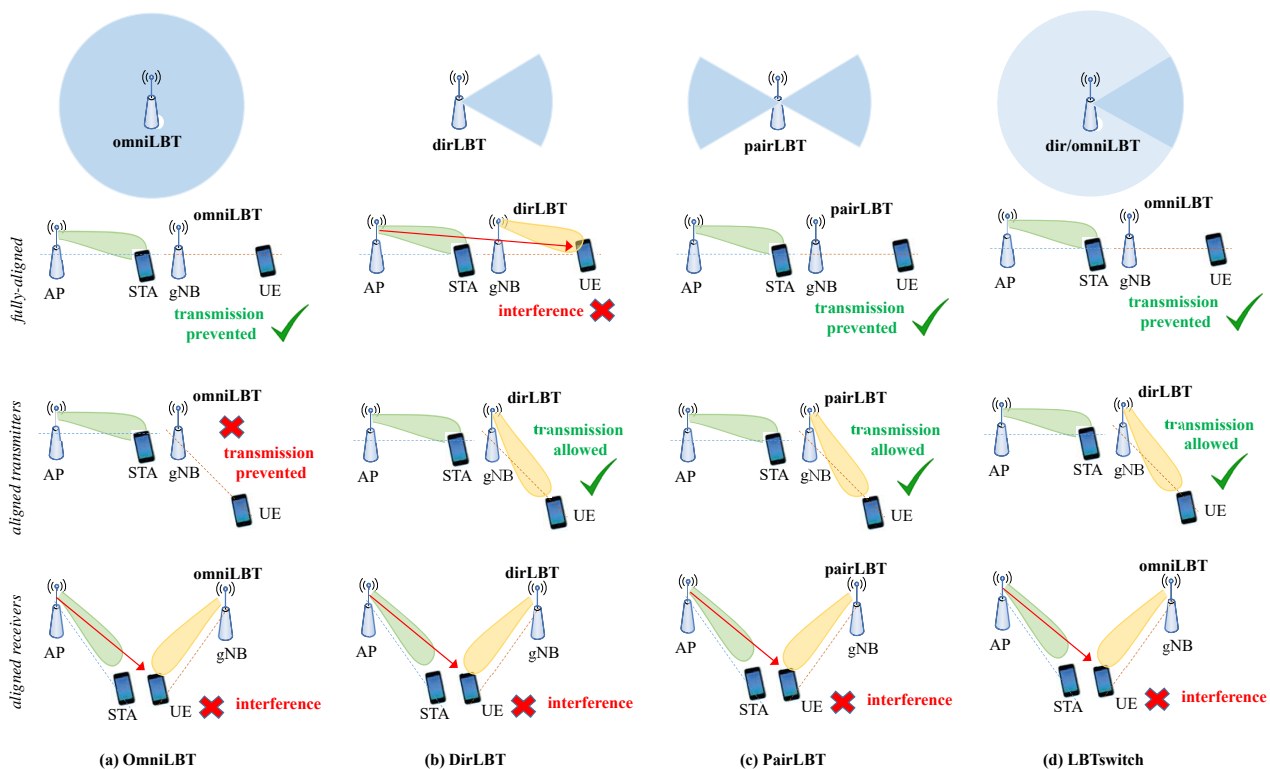

Fig. 7: Behavior of (a) omniLBT, (b) dirLBT, (c) pairLBT, and (d) LBTswitch techniques, assuming beam-based transmissions and that LBT is implemented at gNB during an on-going AP-to-STA transmission, for fully-aligned (top), aligned transmitters (middle), and aligned receivers (bottom) deployment configurations.

	omniLBT	dirLBT	pairLBT	LBTswitch
Type of carrier sense	omnidirectional	directional	directional	omni/directional
Fixed or dynamic type of carrier sense	fixed	fixed	fixed	dynamic
UE-dependent carrier sense	no	yes	yes	yes
Number of carrier sense stages	1	1	2 or more	1
Information from UE	-	-	optional at sync, to optimize pairLBT parameters	on-line, to switch from omniLBT to dirLBT, and reverse

TABLE III: Comparison of channel access procedures that use carrier sense at gNB side.

Fig. 7.(d)). DirLBT, pairLBT, and LBTswitch require knowledge of the intended beam's direction (towards UE) to perform the carrier sense, while omniLBT does not. Indeed, pairLBT needs at least two sensing stages before every channel access, which could increase the overhead for the sensing in case that a single radio-frequency chain could be used at a time.

Any of the LBT schemes discussed so far cannot properly address the case of aligned receivers configuration (see Fig. 7-bottom). In this configuration, if the AP is transmitting towards the STA with its transmit beam (green beam) and, then, the gNB wants to access the channel to serve UE by performing LBT (either dirLBT, omniLBT, pairLBT, or LBTswitch), the gNB will sense the channel as idle. This enables the gNB to proceed with directional data transmission towards UE (yellow beam), which will generate interference onto the STA, as well as UE will receive interference from the AP. In the next section, we discuss the receiver-assisted LBT, which can help to prevent the transmission in this configuration.

### B. Receiver-Assisted LBT for Beam-based Transmissions

As shown before, there are situations (e.g., aligned receivers) in which on-going nearby beam-based transmissions cannot be detected at the gNB through any of the LBT-based schemes, thus causing hidden node problems (see Fig. 7-bottom). In these cases, it is the receiver (UE) which has useful information that can be properly exploited for a successful, fair, and friendly channel access in unlicensed bands with beam-based transmissions.

To address these situations, in [66, Sec. 8.2.2], a Listen-After-Talk (**LAT**) technique based on message exchange was proposed. LAT adopts the opposite logic as compared to LBT, in which the default mode for a transmitter is 'to send data' and data is not sent only when it is confirmed that the channel is occupied by interfering transmissions. That is, the transmitter transmits when data packets arrive and then, in case that a collision is detected by the receiver, coordination signaling is used to avoid future collisions. Therefore, LAT considers involving the receiver to sense the channel directly. However, LAT does not use LBT, and so it is not compliant with the

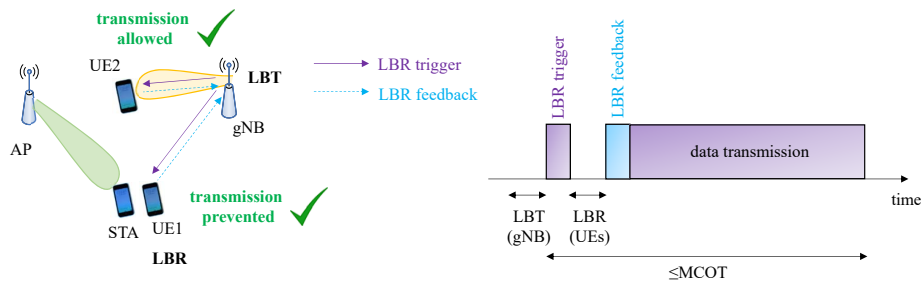

Fig. 8: Receiver-assisted LBT procedure to solve the incorrectness of sensing at gNB side under beam-based transmissions, through triggering carrier sense at the receivers (UE1 and UE2). The LBR trigger and LBR feedback messages can be sent over a licensed (carrier aggregation and dual connectivity scenarios) or unlicensed carrier (standalone scenario), while carrier sense (LBR) is performed in the unlicensed band.

regulatory requirements in the unlicensed spectrum at 5 GHz and 60 GHz bands in some regions [23], [68]. Accordingly, it is a potential approach for the USA and China, as well as for the shared bands without the LBT requirement, but not for Europe and Japan in 5 GHz and 60 GHz bands.

Wi-Fi and WiGig use an optional **RTS/CTS** mechanism to reduce intra-RAT collisions caused by hidden node problems. This mechanism involves physical carrier sense and virtual carrier sense but only solves intra-RAT interference problems, as IEEE 802.11 messages are not decodable by NR devices. Note that RTS/CTS protocol is not currently adopted in LAA and MulteFire technologies. However, from the authors' point of view, it may be worth reconsidering it for NR-U to deal with intra-RAT problems since the hidden node and exposed node problems become more severe under beam-based transmissions.

Other potential solution, which is only based on the physical carrier sense of RTS/CTS, is the Listen-Before-Receive (**LBR**) [63]. According to this mechanism, the gNB triggers the UE to perform carrier sense, and only if the UE responds, the gNB can initiate the transmission. Carrier sense is used before sending the trigger and feedback messages over the unlicensed carrier, thus addressing the NR-U standalone scenario. The solution is illustrated in Fig. 8, where the messages are referred to as LBR trigger and LBR feedback. In [63], it is also shown how to implement LBR to complement LBT in NR by exploiting the NR flexible slot structure. Depending on the omnidirectional/directional sensing that is performed at the gNB (dirLBT/omniLBT) and at the UE (dirLBR/omniLBR), different LBT-LBR combinations may arise. Among all of them, it is found that dirLBT-dirLBR is the best technique and provides significant enhancements in interference management as compared to transmitter-only based sensing approaches [63].

In line with the LBR proposal, some solutions suggest sending the LBR trigger and LBR feedback (see Fig. 8) over the licensed carrier. This is the case of the so-called **closed-loop LBT**, introduced in [87], which is useful for the carrier aggregation and dual connectivity scenarios. This way, by utilizing the licensed carrier, closed-loop LBT procedure can become more robust to channel availability uncertainties of the unlicensed spectrum, thus resulting in lower latency.

RTS/CTS, LBR, and closed-loop LBT solutions are generally referred to as **receiver-assisted LBT**, as illustrated in

Fig. 8. It was agreed by 3GPP to analyze whether receiver-assisted LBT approaches, as well as on-demand receiver-assisted LBT, enable enhancing NR-U performance beyond the baseline LBT mechanism [64, Sec. 7.6.4]. The sensing stages for receiver-assisted LBT procedure (i.e., LBT at gNB and LBR at UE) can use any of the sensing strategies that we discussed in Section VI-A (directional, omnidirectional, paired, or switching), so that multiple LBT-LBR combinations can be formed. In Section XI, we evaluate and compare different LBT-LBR techniques.

The efficiency of receiver-assisted LBT is achieved at the cost of additional message exchange between gNB and UE before every channel access (see Fig. 8). For different NR numerologies<sup>8</sup>, the overhead to implement receiver-assisted LBT can be quantified in terms of percentage of the MCOT (9 ms as per ETSI for the 60 GHz band [23]) that is used to perform the message exchange and sensing at UE side before every channel access. If we assume that one slot is required to perform a complete message handshake, which includes LBR trigger transmission, sensing at UE side, and LBR feedback transmission, the percentage of the MCOT used for the handshake will be 11.11% (SCS=15 kHz), 5.55% (SCS=30 kHz), 2.77% (SCS=60 kHz), 1.38% (SCS=120 kHz), 0.69% (SCS=240 kHz). This reflects the penalty in the spectral efficiency of the NR-U system. It is observed that for high numerologies, (SCS=60, 120, 240 kHz), i.e., the ones that are used at mmWave bands, the overhead is below 3%.

### C. Intra-RAT tight Frequency Reuse

Apart from the LBT sensing strategies analyzed in the previous sections, another problem that may arise due to the uncoordinated LBT among different nodes of the same RAT is unnecessary blocking of transmissions, which leads to degradation in spatial reuse. As previously described, cellular networks have been appropriately designed to allow full frequency reuse since they have effective interference management techniques (e.g., adaptive rate control, power control, coordinated multi-point (CoMP), enhanced inter-cell interference coordination (eICIC)) to mitigate inter-cell interference within the nodes of a single RAT (e.g., NR from a specific operator). Let us note that the transmit coordination

<sup>8</sup>Each numerology in NR specifies a Subcarrier Spacing (SCS) and a slot length, therefore, it influences the DL-UL handshake timings, see [7, Sec. 5.1].

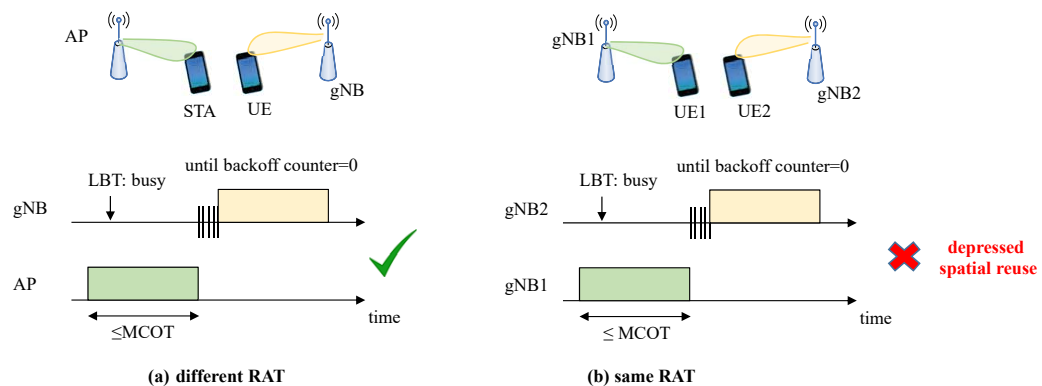

Fig. 9: LBT blocking for (a) nodes of different RATs and (b) nodes of the same RAT.

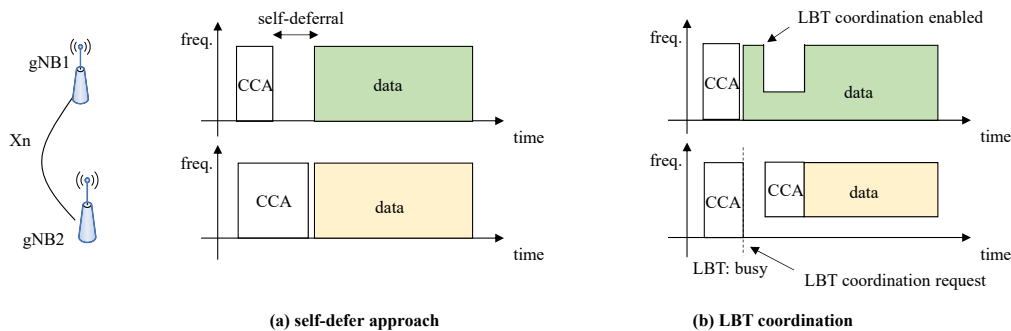

Fig. 10: Solutions to avoid LBT blocking among nodes of the same RAT/operator, through (a) self-defer approach or (b) LBT coordination in frequency-domain.

methods, e.g., CoMP and eICIC, basically coordinate the data transmissions, which in case of NR-U occur in the unlicensed band once the channel access is obtained. Therefore, there is no need to block a transmission through LBT among devices of the same RAT that can be coordinated for transmission in the unlicensed spectrum.

An example of the LBT blocking is shown in Fig. 9, for (a) nodes of different RATs and (b) nodes of the same RAT. In Fig. 9.(a), the AP has accessed the channel and then blocks transmission of the gNB, since the gNB senses the channel as busy with LBT. In this case, the gNB has to wait for the transmission of the AP to finish and its own backoff procedure to access the channel. This behavior is correct. However, in Fig. 9.(b), gNB1 has accessed the channel and is blocking the transmission of gNB2 (a node of the same RAT and operator), which detects the channel as busy. In this case, gNB2 must defer the transmission, due to unnecessary LBT blocking. Therefore, improvements can be done for NR-U.

An alternative solution is presented in [84], [88], where a method for joint channel access using **self-defer** within a group of neighboring gNBs/TRPs of the same operator has been proposed. The group will self-defer its transmission simultaneously after successful LBT for joint channel access so that nodes among the group do not block each other. The self-defer solution is shown in Fig. 10.(a). Therein, once gNB1 gets a clear channel, it communicates with the neighboring gNBs through the Xn interface<sup>9</sup>, and if they are performing the CCA procedure, gNB1 would self-defer itself to avoid blocking

<sup>9</sup>Xn is an NR interface through which the gNBs may communicate with one another, similar to the X2 interface in LTE.

gNB2. gNB1 would self-defer until gNB2 has completed the CCA check and backoff procedure. This solution addresses simultaneous accesses. However, it does not resolve the case in which a node has already accessed the channel, and may block neighbor transmissions of the same RAT and/or operator that have not already started the CCA check. Also, during the self-deferral period, there is a risk that nodes of other RATs and/or operators do occupy the channel.

Another option that we hereby propose is to use **LBT coordination** procedures among neighboring gNBs/TRPs of the same operator. LBT coordination consists on coordinating the LBT processes before starting the data transmission. We foresee that LBT coordination to finalize the backoff procedure can be either in time- or frequency-domain. A possible procedure for LBT coordination in frequency-domain is illustrated in Fig. 10.(b). If a gNB (gNB2 in the figure) is able to detect that the node occupying the channel is a node from its own RAT and operator (gNB1 in the figure), it could send a message over the Xn interface to request LBT coordination to gNB1. After receiving such request, the gNB1 could release part of the channel bandwidth (frequency-domain LBT coordination) and/or some slots (time-domain LBT coordination), for the gNB2 to complete the backoff procedure. The part of the channel bandwidth and/or the slots which will be released, as well as the starting point for transmit coordination, could be communicated through Xn so that both gNBs, after the backoff procedure is completed, could start with transmit coordination, thus improving the spatial reuse.

Note that, in case of time-domain LBT coordination, the same problems as in the self-defer approach arise. That is,

other nodes may occupy the channel during the request-enabled LBT coordination process. Nevertheless, this does not happen in case of frequency-domain LBT coordination, since gNB1 does not release the full spectrum bandwidth and other RATs would still detect the channel as busy. In this case, **bandwidth part-based LBT** is needed, i.e., gNB2 should implement CCA only in the released bandwidth part (as illustrated in Fig. 10.(b), second CCA block for gNB2), and then transmit in such bandwidth part. To further improve the proposal and facilitate the job of detecting that channel is busy due to a gNB of the same RAT/operator, once a gNB gets access to the channel, it could inform nearby gNBs over the Xn interface.

#### D. CWS Adjustment for Beam-based Transmissions

In LAA Cat 4 LBT, the CWS is updated based on HARQ feedbacks. If 80% or more of HARQ feedbacks of one reference subframe are NACK, the maximum CWS is increased [12]. Otherwise, it is reset. Note that this collision detection technique has some drawbacks. First, it is affected by the scheduler policies, e.g., collisions from different UEs may affect the corrective actions of LBT differently since they will depend on how many and which UEs are simultaneously allocated in the reference subframe. Second, HARQ does not necessarily reflect collisions, e.g., NACK may also occur due to a sudden signal blocking. Third, since HARQ is based on soft combining techniques (i.e., incremental redundancy or chase combining), an unsuccessful transmission, due to a collision, may not result in a NACK in case of successful decoding thanks to the combination of multiple transmissions. And the last, it introduces delays in the CWS update. Since LAA uses HARQ feedback corresponding to the starting subframe of the most recent transmission burst, it may detect collision after at least 4 ms, whereas, Wi-Fi detects collisions after 16  $\mu$ s.

We would like to remark that, at the time of writing, the problems that we highlight next in this section have not been detected so far in the literature and, consequently, no solutions are available. Also, the CWS adjustment criterion for Cat 4 LBT in NR-U has not been defined yet.

For NR-U, the same issues listed before for LAA will also appear if HARQ feedback is used for the CWS update, except that the HARQ feedback delay may be reduced due to the flexible NR slot structure. Moreover, for beam-based NR-U, the reported collision by HARQ feedbacks may not be linked to the transmit beam correctly. As already mentioned in previous section, LBT (and the extended CCA procedure) only makes sense if the beams of neighboring gNBs are aligned. If the gNBs/APs saw each other (as shown in Fig. 11.(b)), they would backoff to each other and so randomize their accesses, taking advantage of the CWS increase. However, if beams of neighboring nodes are not aligned (see Fig. 11.(a)), the LBT is not effective, even if the CWS is increased. The gNBs/APs never enter in the backoff phase, so the access randomization effect is not produced. In particular, in case of Fig. 11.(a) scenario, both the gNB and AP listen to the channel and find it free, thus, they both access the channel and collide. Then,

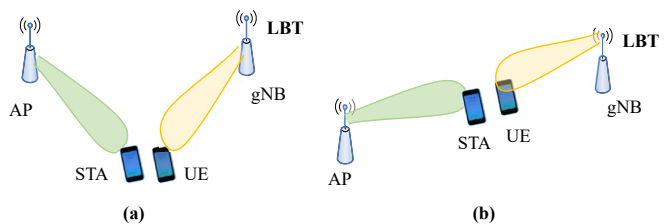

Fig. 11: Situations in which LBT and the CWS update based on HARQ feedback: (a) do not make sense, (b) make sense.

they increase the CWS, they listen again, find the channel free and they collide again. Therefore, in those cases where LBT does not work properly, it is furthermore counterproductive to increase the CWS based on HARQ procedure.

To summarize, we have detected two problems that arise in beam-based transmissions when the CWS update is based on HARQ feedback:

- *The lack of correlation between a collision indicated by a NACK and the transmit beam:* HARQ feedbacks may refer to collisions due to interference coming from another direction, while only collisions generated on the transmit direction line are of interest for the CWS update.
- *The inability to enter the backoff phase due to an incorrect sensing phase:* transmitters that do not see each other would never enter the backoff phase to randomize their accesses, although they increase the CWS based on HARQ feedback.

Therefore, for transmitters that do not see each other, it would be beneficial that the UE triggers the backoff procedure at its gNB to randomize its gNB's access to the channel since the UE is the only one that has the knowledge about interfering nodes. In addition, it would be good to isolate the CWS update procedure from the HARQ feedback because it does not properly capture the directional (and non-directional) collisions.

To solve these problems, we propose using a CWS update at the gNB that is assisted by the UE, i.e., **receiver-assisted CWS adjustment**. In particular, by a paired sensing at the UE. That is, the UE could carry out a paired sensing over the gNB transmit beam line (receive direction and opposite direction(s)) and, if the channel is sensed as busy during some period, it could:

- Trigger backoff at the gNB if it is not aligned to the source of interference.
- Suggest the most appropriate CWS over the gNB transmit beam line, based on, e.g., the percentage of slots sensed as busy during the paired sensing phase.

Hence, we suggest updating the CWS associated to the transmit beam based on statistical paired sensing at the UE within the direction of the gNB transmit beam.

## VII. COT STRUCTURE FOR NR-U

After a successful LBT, a device can access the channel at most for the duration of the MCOT (9 ms in the 60 GHz band). The NR frame structure inherently allows NR-U to transmit and receive in a more efficient manner compared to LTE in



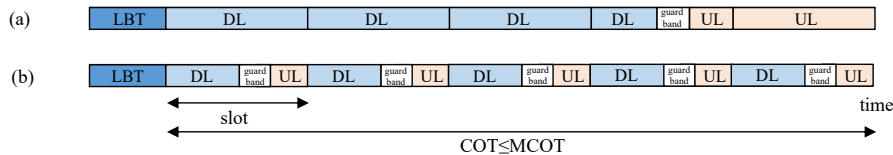

Fig. 12: COT structure with (a) single DL/UL switch, (b) multiple DL/UL switches.

unlicensed spectrum technologies, thanks to the numerologies, mini-slots, and flexible slot structure [89]. Indeed, the COT can be shared between a gNB and its UEs to achieve a higher spectral efficiency and faster responses under bidirectional transmissions (see details in Section IV.B). In this section, we review how to define the DL and UL transmission periods within the COT.

There are two options considered in 3GPP to define the structure of the COT (as illustrated in Fig. 12):

- COT with single DL/UL switch or
- COT with multiple DL/UL switches.

Note that the slot length in NR is much shorter than the MCOT. For example, with SCS=120 kHz, 72 slots fit within 9 ms, so that multiple DL/UL switches could be implemented. Recently, support for the multiple DL/UL switch option within the COT has been agreed for NR-U [17, Sec. 7.2.1.1]. Still, as highlighted by 3GPP, the number of switch points per COT should be further studied in NR-U [76].

Both aforementioned options have advantages and disadvantages. A **COT with a single DL/UL switch** has the advantages that: *i*) there is a low overhead due to only one guard band (shown in gray color in Fig. 12) and *ii*) avoids multiple LBTs for successive DL-UL periods (in case the gaps are larger than  $16 \mu\text{s}$  and so a new LBT has to be done at each gap<sup>10</sup>). The disadvantages are that: *i*) it increases delays to get the HARQ feedback, and *ii*) the gNB would schedule UL far away in time, for which the channel may no longer be available in the UL direction (in case a new LBT has to be performed). Accordingly, this COT configuration is suitable for high throughput situations with relaxed latency constraints, e.g., eMBB traffic.

On the other hand, a **COT with multiple DL/UL switches**: *i*) simplifies the HARQ timings related to HARQ feedback and *ii*) ensures channel availability in UL (in case a new LBT has to be done), but *i*) has a high overhead due to multiple guard bands (see Fig. 12) and *ii*) involves multiple LBTs for successive DL-UL periods at every direction switch (in case the gaps are larger than  $16 \mu\text{s}$ ). This configuration is then suitable for delay-sensitive traffic, such as URLLC and eV2X, as well as for low-load traffic categories, like mMTC. However, it may not be suitable for applications with high throughput requirements (like eMBB) as it provides a lower spectral efficiency due to the existence of multiple guard bands and the potential need for multiple LBTs.

Based on the above advantages/disadvantages of each option, from the authors' point of view, it would be appropriate to optimize UL/DL structure within the COT based

on knowledge of the traffic status and patterns (e.g., Buffer Status Report (BSR) and future BSR pattern predictions), the throughput/latency requirements of the active data flows, their category type (or 5G QoS Indicator, 5QI), and the channel status at the UEs (percentage of busy and idle slots). The gNB could consider the information from all the active flows for the COT period. In addition to the intrinsic trade-offs, it would be beneficial that the gNB notifies the UEs the selected COT structure preferably at the beginning of the COT. This would help the UEs to prepare for performing LBT ahead of time, as well as to anticipate the preparation of any potential transmission in a Physical Uplink Control Channel (PUCCH) or Physical Uplink Shared Channel (PUSCH) resource.

## VIII. INITIAL ACCESS PROCEDURES FOR NR-U

The basic structure of NR initial access is similar to the corresponding functionality of LTE [9]: 1) there is a pair of DL signals, the Primary Synchronization Signal (PSS) and Secondary Synchronization Signal (SSS), which are used by the UE to find, synchronize, and identify a network, 2) there is a DL Physical Broadcast Channel (PBCH) that carries a minimum amount of system information, which is transmitted together with the PSS/SSS, and 3) there is a four-stage Random Access Channel (RACH) procedure that starts with the UL transmission of a random access preamble [28]. In NR, the combination of PSS/SSS and PBCH is referred to as a Synchronization Signal (SS) block, and such signals are always sent together with the same periodicity. This section reviews the problems and solutions for the key features of the NR-U initial access, which include SS block design<sup>11</sup>, RACH procedure, and paging.

### A. SS Block Design

SS blocks are used in NR to enable radio resource management measurements, synchronization, and initial access. Therefore, for NR-U operation, SS blocks should always be transmitted in all the deployment scenarios, i.e., carrier aggregation, dual connectivity, or standalone mode (see Section IV.A). An SS block spans over 240 contiguous subcarriers and 4 contiguous OFDM symbols (as shown in Fig. 13). The frequency location is typically not at the center of the NR carrier (as in LTE) but shifted according to a global synchronization raster that depends on the frequency band [90, Sec. 5.4.3]. The time locations of the SS blocks are determined by SCS and frequency range [81, Sec. 4.1]. The maximum transmission bandwidth of an SS block has been defined to be

<sup>10</sup>Whether LBT before an UL transmission that follows a DL transmission is needed or not, depends on the gap length, as detailed in Section IV.B.

<sup>11</sup>In the NR-U standardization, the SS block is referred to as NR-U discovery reference signal [17].

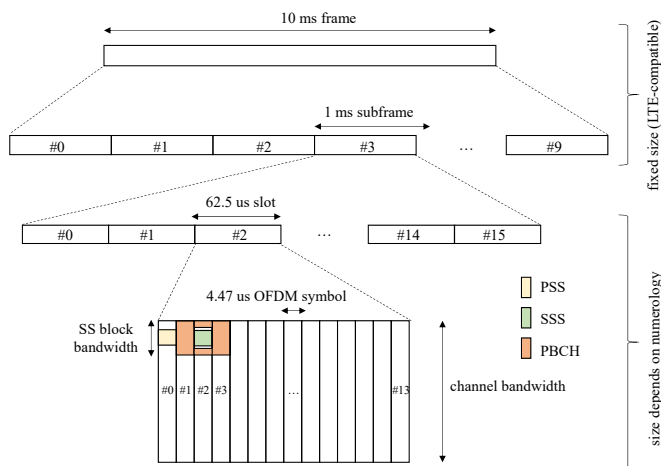

Fig. 13: Location of SS block in an NR frame for SCS=240 kHz.

[5, 10, 40, 80] MHz with [15, 30, 120, 240] kHz SCS, respectively. To support beam sweeping and SS block repetitions, multiple SS blocks from the same gNB are organized in time into a burst (called SS burst), and multiple SS bursts further comprise an SS burst set. The periodicity of an SS burst set is configurable from the set of {5, 10, 20, 40, 80, 160} ms (default at 20 ms), and each SS burst set can contain up to 64 SS blocks. For more details on the PSS, SSS, and PBCH signals, see [73]. The synchronization procedure for cell search is detailed in [81, Sec. 4.1], and the time-frequency structure of the SS block is shown in [7, Sec. 5.2.4].

In the following we discuss different challenges that arise in the SS block design and transmission principles for NR-U. Note that SS blocks must be sent by the gNB even if there is no data, to enable the UEs to detect and search cells, be synchronized to the gNB, perform beam measurements, implement handover if required, and decode broadcast messages.

The first problem is related to the transmission of the SS blocks and LBT requirement. Since SS block may be interrupted due to channel occupancy, periodical SS block transmission may not be possible [70, Sec. 7.6.4.2]. This can be solved by using a solution adopted in LAA discovery reference signals, which are transmitted within a periodically occurring time window, and thus increase the chance for signal transmission [11]. Additional occasions for SS block transmissions, over the legacy periodic SS block transmissions, are proposed in [91]. Also, it is shown therein how to enable multiple occasions by reusing the NR SS block patterns. In addition, SS block patterns may need to be redefined to include the LBT resource overhead and enable SS block transmissions through multiple beams, as discussed in [83]. The technical contribution in [92] describes solutions to reuse the NR SS block patterns while leaving enough space for LBT as well as for switching antenna weights for beam sweeping in between the different blocks.

The second problem is related to the SS block design in 60 GHz band, which occurs due to the OCB requirement and the large channel bandwidth (see Section III.B). The main problem is that SS blocks occupy only a part of the NCB, as shown in Fig. 13. For illustrative purposes, in Fig. 13, the

SS block starts at the first OFDM symbol and is located at the upper-left corner, although its exact location is defined in [81, Sec. 4.1]. If SS blocks are multiplexed with data, then the OCB requirement may be met. However, if SS blocks are not multiplexed with data, then the OCB requirement is not met with the current SS block design in NR. Accordingly, to meet the OCB requirement defined by ETSI, a new design of SS blocks in frequency domain is required for NR-U operation at the 60 GHz band.

In case SS blocks are not multiplexed with data, or they are sent with data but do not fulfill the OCB requirement, a basic solution is to send dummy non-useful data in frequency-domain to meet the OCB requirement. However, this solution is energy-inefficient and does not add any benefit from the UE perspective. Other solutions that we envision to meet the OCB requirement are:

- Perform **frequency-domain SS block repetitions**, by repeating the SS block in multiple frequency locations within the channel bandwidth. This solution uses additional power but enhances the UE performance, as it enables receiving the SS block with a higher signal-to-noise ratio.
- Redesign the **time-frequency structure** of the PSS/SSS/PBCH signals in the SS block, by restructuring the signals placement. An example is to use a frequency-domain interlaced mapping for PSS/SSS/PBCH signals so that they span over the required channel bandwidth. This solution allows meeting the OCB requirement without incurring additional power consumption.

## B. RACH Procedure

The contention-based RACH procedure in NR has four steps [81, Sec. 8], [28], *step 1*: UE transmits a Physical Random Access Channel (PRACH) preamble to gNB, *step 2*: gNB transmits the Random Access Response (RAR) to UE with the PUSCH resource allocation to send message 3, *step 3*: UE transmits message 3 over the allocated PUSCH resource, and *step 4*: gNB transmits message 4 for contention resolution. In NR-U, RACH procedures are needed and must be improved at least for dual connectivity and standalone deployment scenarios. Carrier sense must be performed at each step of RACH procedure, which may delay the procedure to complete if the channel is busy at any step. Therefore, high-priority channel access with Cat 2 LBT could be preferred for RACH. Indeed, the use of two-step RACH procedures would also be of high interest to reduce the initial access delay, as proposed in [92], [93], and also identified by 3GPP [70, Sec. 7.6.4.2]. Particularly, two-step RACH procedures will require fewer LBTs than the four-step RACH procedure. Other enhancements may include the increasing transmit opportunities for each message [94], which is also discussed in the case of SSB transmissions.

In addition to that, the PRACH preamble format needs to fulfill the regulatory requirement of OCB, which will exclude some of the agreed NR PRACH formats. In Rel-14 eLAA [30], several types of PRACH waveforms were studied, such as frequency-domain repetition of a licensed band preamble,

Demodulation Reference Signals (DMRS) repetition in time domain with frequency-domain interlacing, and frequency-domain interlaced mapping of a licensed band preamble. This study in eLAA may provide a baseline for the design of NR-U PRACH interlace waveforms.

### C. Paging

Paging is a Radio Resource Control (RRC) procedure to activate a UE that is in idle mode. In the unlicensed context, it is needed at least for dual connectivity and standalone deployment scenarios. A paging cycle is defined to allow UEs to wake up and listen at predefined time slots to receive possible paging messages. The paging message is scheduled through Downlink Control Information (DCI) and is transmitted in the associated Physical Downlink Shared Channel (PDSCH).

The uncertainty of channel availability in the unlicensed bands due to LBT makes paging DCI hard to be sent out at predefined time slots. To solve that, a time interval composed of multiple slots for potential paging message transmission has been proposed in [95], [96]. It provides a gNB multiple opportunities (multiple slots) to send the paging DCI as soon as LBT allows. On the other side, UE needs to listen for all the possible opportunities. In such solution, the probability of blocking due to channel occupancy is reduced at the cost of a higher energy consumption at UE.

Current NR specification already supports a paging occasion consisting of multiple slots [7, Sec. 9.2.5], to improve the reliability of the system. Also, NR permits the network to transmit a paging message using a different set of transmit beams or repetitions. Thus, the reliability and channel availability issues of paging for NR-U can be assessed by using the already supported time- and spatial- domains for paging in NR.

## IX. HARQ PROCEDURES FOR NR-U

In NR, similar to LTE, after reception of data, a device has to respond with a HARQ feedback to indicate whether the data transmission was successful or not. The time duration between the initial data transmission, HARQ feedback, and re-transmission, as well as the way the transmitted and re-transmitted data are combined at the receiver for decoding, define the basics of the HARQ procedure. HARQ in NR supports asynchronous incremental redundancy both for DL and UL. In DL, the gNB provides the HARQ feedback timing configuration to UE either dynamically using DCI or semi-statically using RRC. In UL, upon reception of the Scheduling Request (SR) or BSR from UE, the gNB schedules each UL transmission and re-transmission using DCI.

In NR, the following terminologies<sup>12</sup> are defined in terms of scheduling and HARQ time-line [81], [82], [97], [98]:

- K0: Delay between DL allocation (Physical Downlink Control Channel (PDCCH)) and corresponding DL data (PDSCH) reception, [82, Sec. 5.1.2.1],

<sup>12</sup>Let us note that, at the time of writing, only K0, K1, and K2 are included in 3GPP technical specification [97]. K3 and K4 are not included, although they were mentioned in 3GPP technical discussions [98], and are included in this paper to illustrate the whole HARQ time-line.

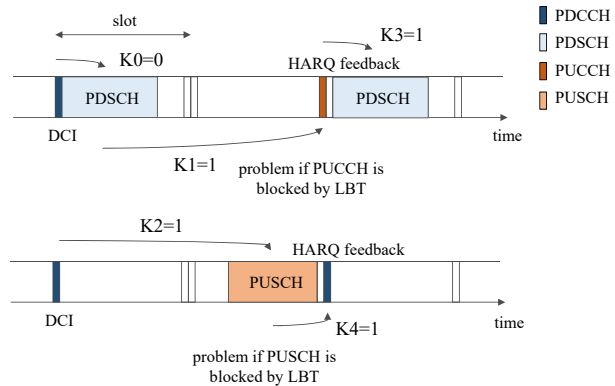

Fig. 14: Problems related to scheduling and HARQ due to LBT.

- K1: Delay between DL data (PDSCH) reception and corresponding HARQ feedback transmission on UL (PUCCH), [81, Sec. 9.2.3],
- K2: Delay between UL grant reception in DL (PDCCH) and UL data (PUSCH) transmission, [82, Sec. 6.1.2.1],
- K3: Delay between HARQ feedback reception in UL (PUCCH) and corresponding re-transmission of data (PDSCH) on DL,
- K4: Delay between UL data (PUSCH) reception and corresponding HARQ feedback transmission on DL (PDCCH).

Fig. 14 shows an example of DL and UL data transmissions along with the associated HARQ feedback allocation for  $K0=0$ ,  $K1=1$ ,  $K2=1$ ,  $K3=1$ ,  $K4=1$  slots. If PDSCH is sent in slot  $n$ , PUCCH with HARQ feedback would be sent in slot  $n+k$ , where  $k$  is indicated by the field *PDSCH-to-HARQ-timing-indicator* (provides the value of K1) in the DCI in PDCCH. Moreover, PUCCH resources, i.e., physical RBs to be used for HARQ feedback are also indicated by DCI in PDCCH [81, Sec. 9.2.3]. Similarly, in UL transmissions, PUSCH resources for UL data transmissions and re-transmissions are configured by DCI in PDCCH, where the slot timing offset K2 is part of the *Time-domain resource assignment* field in DCI [82, Sec. 6.1.2.1].

Note that K3 and K4 need to consider the processing times at the gNB side, while K1 and K2 have to take into account the UE processing times. In NR, the UE processing time is expressed in terms of symbols, instead of slots (unlike the K parameters), for which the following terminologies are defined:

- N1: the number of OFDM symbols required for UE processing from the end of PDSCH reception to the earliest possible start of the corresponding HARQ feedback transmission,
- N2: the number of OFDM symbols required for UE processing from the end of PDCCH containing the UL grant reception to the earliest possible start of the corresponding PUSCH transmission.

More details and specific values of N1 and N2 for different configurations and numerologies can be found in [98], [99].

From the HARQ procedure point of view, two NR features are important: the flexible slot structure and the mini-slot-

based transmissions. The flexible slot structure may reduce the HARQ delay by allowing the transmission of HARQ feedback in the same slot in which PDSCH was received (**self-contained HARQ feedback**) [100], and may enable re-transmissions in the subsequent slot, provided that the processing delays at UE and gNB are short enough to permit it. The mini-slot-based transmissions provide scheduling support with flexible transmission durations. It also reduces the delay between the time instant when the channel is found idle and the time instant when the transmission can be started. This way it reduces the need of using reservation signals to reserve the channel until the next allowed transmission time instant boundary, which was used in LAA to protect the channel until the next subframe boundary (see [12, Sec. 7.2.1.1]).

However, in case of standalone NR-U, there are two important problems associated with the HARQ operation and LBT requirement (see Fig. 14):

- *UL data blocking of an UL HARQ process*: It may happen that UL grant is transmitted through PDCCH but the corresponding UL data in PUSCH is blocked by channel occupancy (even in case of Cat 2 LBT within a shared COT). In such a case, the gNB would assume it as an incorrect reception (even if there was no transmission) and so would proceed to reallocate resources for the UE to "re-transmit". The problem is further aggravated in case of multi-slot scheduling, for which multiple slots are assigned for the UE to transmit, through a single UL grant.
- *HARQ feedback blocking of a DL HARQ process*: It may happen that PDCCH and PDSCH are transmitted but HARQ feedback in PUCCH is blocked by channel occupancy (even in case of Cat 2 LBT). Due to the blocking of HARQ feedback transmissions, gNB would assume it is a NACK and additional re-transmissions would occur at gNB. The problem is further aggravated in case of multi-slot aggregation, for which multiple HARQ feedbacks of different transport blocks are multiplexed together in a single PUCCH transmission.

The problem of UL data blocking of an UL HARQ process has already been addressed in eLAA using triggered grant [30]. The key idea is to use two step grant process instead of one. For an UL grant, first a subset of the configuration parameters, for example, Modulation and Coding Scheme (MCS), Transport Block Size (TBS), and assigned RBs are sent, then, at a later point, a short triggered grant is sent on PDCCH to trigger the corresponding UL transmission. The delay to process the triggered grant and to send the UL transmission would be minimal at UE side, because most of the processing has already been finished based on the configuration parameters sent earlier before the triggered grant. This allows the UE to immediately transmit after the triggered grant without LBT, given that the UE transmission can be done within  $16 \mu\text{s}$  from the transmission of triggered grant, within the shared COT. This solution can be reused for NR-U.

The problem of HARQ feedback blocking of a DL HARQ process was not present in LAA technologies, because PUCCH was always sent over the licensed carrier [30, Sec. 10]. In Mul-

teFire, this problem was partially solved using new PUCCH formats, i.e., an extended PUCCH format (MF-ePUCCH) and a short PUCCH format (MF-sPUCCH). MF-ePUCCH is sent with PUSCH using interlaced configuration, while MF-sPUCCH is sent in the LTE special subframe [15]. Based on that, in MulteFire, the transmission opportunity to send HARQ feedback is defined according to the availability of either MF-sPUCCH, MF-ePUCCH (PUSCH resources) for the UE. In addition, in case of MF-sPUCCH (if available) transmission after DL data transmission, the LBT for it could be avoided according to the shared COT rule. However, LBT blocking of HARQ feedback still can arise when the MF-sPUCCH cannot be placed immediately after its DL transmission.

One of the solutions to solve the HARQ feedback blocking of a DL HARQ process in NR-U is postponing the HARQ feedback transmission to the next available slot/symbols which are not blocked. Such a solution of postponing the HARQ feedback has also been considered in NR for multi-slot aggregation and DL semi-persistent scheduling. It occurs when there is a direction conflict due to DL-UL semi-static configuration or dynamic subframe indicator (SFI). However, in these cases, both gNB and UE know that there is a direction conflict, thus the gNB postpones the reception and the UE postpones the transmission of the HARQ feedback. In NR-U, HARQ feedback can be postponed but the gNB would not know that it was blocked in UL and it would assume NACK instead. So, postponing the HARQ feedback is not sufficient in NR-U.

A potential solution to solve the above problem can be the allocation of multiple PUCCH resources for sending HARQ feedback corresponding to a PDSCH transmission within the COT (**opportunistic HARQ feedback**). This solution has been highlighted in [100] as a potential enhancement for NR-U. The configuration of multiple PUCCH resources can be given in the DCI, which requires definition of a new DCI format for NR-U. The multiple PUCCH resource configuration for HARQ feedback may include multiple time resources as well as various beams/TRPs. Once UE receives PDSCH in slot  $n$ , the UE will check whether the activated PUCCH resources for HARQ feedback are valid. If any PUCCH resource after  $n+K-1$  slots is not blocked, the HARQ feedback is transmitted. If all PUCCH resources are blocked, then HARQ feedback is discarded. The gNB must wait and check whether HARQ feedback can be decoded in any of the allocated multiple PUCCH resources. As soon as the gNB decodes the HARQ feedback, it can proceed with either re-transmissions or new data transmissions without monitoring of the remaining allocated PUCCH resources.

Another option to solve the problem is to use a **triggered HARQ feedback** [100]. That is, to use a DL triggered grant to trigger the transmission of HARQ feedback. This is similar to the solution adopted in eLAA that is used to resolve the UL data blocking problem.

## X. SCHEDULING METHODS FOR NR-U

In NR, like in LTE, dynamic scheduled access is used for both DL and UL, for which the scheduling decisions are made at the gNB. Each UE monitors multiple PDCCHs,

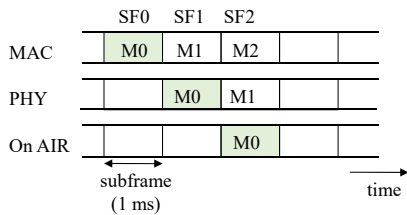

Fig. 15: Processing delays in LTE.

which, upon the detection of a valid DCI, follows the given scheduling decision and receives (transmits) its DL (UL) data. In NR-U, the dynamic scheduler design has some challenging issues to solve because of the regulatory requirements for accessing the unlicensed bands. One of such issues arises due to MAC & PHY processing delays and the requirement of LBT, which we discuss in detail in Section X-A. In addition to that, the scheduler needs to take the OCB and MCOT requirements into account as well. At each transmission time interval, the gNB needs to schedule the UEs such that the OCB requirement is full-filled. For example, multiple UEs may be multiplexed in frequency domain in such a way that the OCB requirement is satisfied, e.g., by scheduling UEs that are associated to the same beam in a slot. Also, the gNB should take MCOT limitation into account while scheduling different data flows because the channel availability after MCOT cannot be ensured.

Due to LBT requirements, scheduling schemes other than the dynamic scheduled access might be more suitable for NR-U, and particularly for UL access. For example, autonomous UL introduced in FeLAA [101, Sec. 4.2], grant-less UL in MulteFire [15], or configured grant defined in NR for UL transmissions [102, Sec. 5.8.2], might be good candidates for NR-U UL access. We discuss them in detail in Section X-B.

#### A. Impact of Processing Delays and LBT on the Scheduler

As inherited in LTE, in LAA and MulteFire technologies there is 1 ms (one LTE subframe) of MAC processing delay and 1 ms of PHY processing delay for each transmission. For example, as shown in Fig. 15, data scheduled in subframe number 0 (SF0) can be transmitted over the air after 2 ms in subframe number 2 (SF2). This allows two ways to perform LBT, which are also shown in Fig. 16: (a) LBT before MAC processing, (b) LBT after MAC processing<sup>13</sup>.

In the **LBT before MAC processing** option, the delay to access the channel, given that the channel is clear, is larger than two subframes (see Fig. 16.(a)). In this solution, the MAC/PHY configuration of the current transmission can be modified based on the LBT outcome (e.g., adjust the MCS based on the sensed power during LBT). In the **LBT after MAC processing** option, if the channel is clear, then the delay to access the channel is lower than one subframe (see Fig. 16.(b)). If the channel is not clear within the duration of the PHY processing, then the MAC Packet Data Unit (PDU)

<sup>13</sup>Note that the selection of LBT scheme out of these two options is implementation-specific and, therefore, it is not defined either in LAA-releases or MulteFire, but one of the options has to be implemented in chipsets.

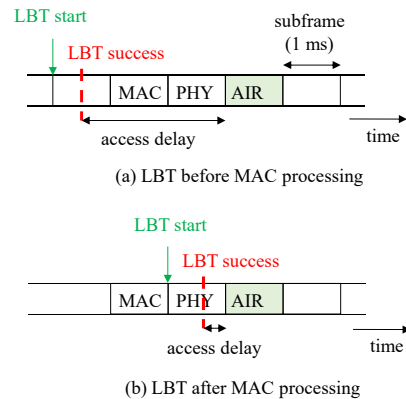

Fig. 16: Options to perform LBT in LAA. For NR, the same options apply but the subframe would correspond to a slot or symbol (depending on the device processing capabilities) that has a numerology-dependent length.

needs to be rescheduled, which will incur an access delay of more than three subframes to reschedule at Radio Link Control (RLC), and then reprocess at MAC and PHY. In addition, in this case, when the channel is clear, the MAC/PHY configuration of the current transmission cannot be modified based on the LBT outcome. In both the options, when the channel is clear, reservation signals may be needed to reserve the channel until the subframe boundary corresponding to the data transmission starts. In line with the above, LBT before or after MAC processing solutions have clear trade-offs. The LBT before MAC processing provides more flexibility at the scheduler but it requires the use of reservation signals during MAC and PHY processing for a long duration. On the other hand, the LBT after MAC processing reduces the duration of use of reservation signals but requires handling rescheduling if LBT fails which complicates the scheduler operation.

In NR, MAC/PHY processing delays are of the order of OFDM symbol length, for which the specific values can be derived based on the device capability and the numerology [99]. Although the processing delays are reduced in NR, the same trade-offs of LBT before and after MAC processing options described above will still exist for NR-U. However, for LBT after MAC processing, due to small delay in accessing the channel, i.e., less than one OFDM symbol, which can be for example  $8.93 \mu\text{s}$  for  $\text{SCS}=120 \text{ kHz}$ , there may not be any need for using reservation signals. This is an important aspect, since there are some suggestions in 3GPP to eliminate the use of reservation signals, which may also be prevented by the ETSI regulation in the future [103].

In case of scheduled UL transmissions, LBT after MAC processing is a better solution because the scheduling decision has already been made by the gNB and it becomes important to not lose the allocated resource for UL access. Losing the transmission opportunity in UL may delay successful transmission. It may also affect the DL performance for example in the case of Transmission Control Protocol (TCP), which requires transmission of timely TCP Positive Acknowledgement (ACK)s in the opposite direction.

One of the solutions that we propose here to increase the probability of channel access while performing LBT for the

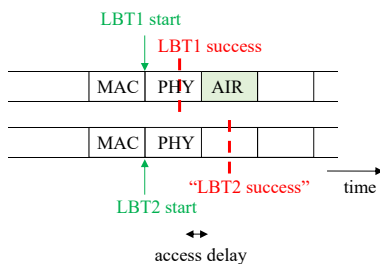

Fig. 17: LBT after MAC processing with two spatial MAC PDU replicas and two parallel LBT processes.

beam-based transmissions is to use **multiple spatial replicas** of the same transmission. This is more suitable for the DL transmissions, where multiple TRPs or multiple beams of the same TRP can be used to generate multiple spatial replicas for the same UE. However, it also applies to the UL in case the UE has connectivity with multiple TRPs/beams. In this solution, we propose:

- preparing multiple replicas of the same MAC PDU scheduled for a certain slot/symbol of a specific UE with different beam-pairs or TRPs for that UE,
- performing simultaneous LBT processes on different TRPs/beams after MAC processing, and
- then proceeding with the best beam/TRP for which LBT is successful (i.e., that finds the channel available on time). In case of multiple TRPs/beams get a successful LBT, the final selection can be based on the channel conditions on the selected TRPs/beams.

This is illustrated in Fig. 17 for two spatial replicas. The proposed solution requires a process of selecting multiple beams/TRPs for each transmission link, as well as the capability of performing LBT simultaneously on multiple beams/TRPs. In case different TRPs are used, the sensing for LBT can be either directional or omnidirectional. If multiple beams of the same TRP are used, then this solution is only applied in case the gNB uses directional LBT. In any case, it also requires the UE to listen simultaneously on the multiple configured beams for data reception. This method would increase the reliability and reduce the impact of LBT failure on latency. It would also reduce the access delay and improve performance in case that MAC/PHY processing delays are of the slot length order and/or the use of reservation signals is not allowed.

In FeLAA [30], a similar kind of solution was adopted by allowing multiple starting positions in the DL and UL special subframes, which is basically using multiple replicas of MAC PDU in the temporal domain. Similarly, in [104]–[106], it was proposed that multiple PDCCHs were used to indicate different starting positions for the special subframes, whereas in [107], it was suggested adjusting the MCS according to the remaining time available for transmission which will depend on time instant at which the channel is found available by LBT. For LBT after MAC, these solutions involve preparing multiple replicas related to different starting temporal points [104]–[106] and MCSs [107].

## B. Non-dynamic Scheduling Schemes

In the case of UL dynamic scheduling, first, a UE has to send a SR/BSR to request an UL grant (DCI in PDCCH) from its gNB. Then, after receiving the UL grant, the UE performs the data transmission in PUSCH. In unlicensed spectrum, this process will need multiple LBTs (in particular, 3 LBTs for NR-U standalone scenario). This means that, if channel is occupied at any step, it will incur long delays to UL data transmissions. Alternative (non-dynamic) scheduling schemes may be more suitable for UL NR-U to reduce the message exchange overhead of dynamic scheduled UL.

In Rel-14 eLAA, it was found that scheduled UL transmission has disadvantages in terms of throughput and latency, compared to contention-based transmissions used in other co-existing RATs, such as Wi-Fi. To compensate for that, Rel-15 FeLAA introduced the **autonomous UL** transmissions [101, Sec. 4.2] and MulteFire defined **grant-less UL** [15], which have a high resemblance. Both in autonomous UL and grant-less UL, there is a predefined set of radio resources, which are configured on a per-cell basis and are for contention-based access. A UE is allowed, after a successful LBT, to transmit its PUSCH on such resources without an UL grant. Therefore, autonomous UL and grant-less UL eliminate the handshake of SR, BSR, and dynamic UL grant for UL access [108]. However, losses due to collisions and blocking owing to channel occupancy may occur in autonomous UL and grant-less UL. To solve that, if a similar approach is followed for NR-U, then the multi-TRP deployment and multi-beam operation could be exploited to configure UL transmissions to multiple TRPs by following the same approach as in the spatial replicas based solution that we described in Section X-A.

Non-dynamic scheduling schemes have also been introduced in NR to reduce the latency of dynamic scheduled UL. NR defines a new non-dynamic scheduling for UL data transmission [102, Sec. 5.8.2], called **configured grant**. In configured grant, the UL data transmissions follow a semi-statically configured resource allocation corresponding to a UE-specific configured grant. The configured grant may either be provided by RRC (Type 1) or via DCI (Type 2). Due to the semi-static and periodic configuration of resources, configured scheduling requires less control signaling as compared to dynamic scheduling. This is convenient for NR-U UL to simplify the SR/BSR/UL grant handshake and reduce the number of required LBTs that are needed before a UE can successfully access the unlicensed channel [17]. Therefore, it is a potential scheme to reduce the access delay in NR-U UL, provided that its parameters: size  $\gamma$  (i.e., amount of data, in bits, which is given by the number of assigned resources and MCS) and periodicity  $p$  (in number of slots) are properly configured for the available traffic pattern. For example, consider a UE which needs to download some data from a remote host, in that case, configured grant can be used to reserve space for TCP ACKs every  $p$  slots for an amount of data  $\gamma$ . Moreover, to avoid blocking of UL transmissions on configured resources due to LBT, the gNB can also use the triggered grants (described in Section IX) to enable the UE transmit immediately after the triggered grant.

## XI. EVALUATION

In this section, by using simulation of an **NR-U/WiGig coexistence** scenario, we evaluate the performance of different LBT-based channel access procedures discussed in Section VI. The evaluation of other open design improvements (like COT structure, initial access, HARQ, and scheduler analyzed in Sections VII, VIII, IX, X, respectively) is left for future works. The details of the deployment scenario and the simulation results are given in the following sections.

### A. Deployment Scenario

A dense indoor network deployment, composed of  $K$  pairs that are randomly deployed in a  $25 \times 25$  m<sup>2</sup> area is considered. We consider an NR-U/WiGig coexistence scenario, for which half of the pairs ( $K/2$ ) are NR-U pairs (gNB-UE) and the other half of the pairs ( $K/2$ ) are WiGig pairs (AP-STA). The minimum distance among gNBs/APs is set to 1 meter, and UEs/STAs are deployed in a random distance between 3 and 8 meters from the serving gNB/AP. Performance of the downlink transmission is assessed, assuming that gNBs/APs operate at carrier frequency 60 GHz with 1 GHz channel bandwidth and transmit power of 10 dBm. The channel models of IEEE 802.11ad are used. The noise power spectral density and the noise figure are set to  $-174$  dBm/Hz and 7 dB, respectively.

According to WiGig specification, we assume that APs perform omniLBT. For NR-U gNBs, different channel access procedures described in Section VI-A, i.e., omniLBT, dirLBT, pairLBT, and LBTswitch are considered. We also combine each of these strategies with LBR (i.e., receiver-assisted LBT, as detailed in Section VI-B), which are denoted by omniLBT+LBR, dirLBT+LBR, pairLBT+LBR, and LBTswitch+LBR, respectively. In addition to these schemes, we introduce a dummy design in which gNBs do not perform any LBT before a transmission, denoted as no-LBT. The no-LBT option is not compliant with ETSI regulation [23] but it is just included as a benchmark in the simulations. For the LBR-based options, the additional time required to perform LBR handshake given in Section VI-B is taken into account. For NR-U, we consider SCS=120 kHz, since it is a common numerology in mmWave bands.

Directional transmissions are assumed at gNBs/APs. The transmit beam gain at gNBs/APs is fixed to 10 dB with a transmit main lobe beamwidth of  $30^\circ$ , and ideal antenna radiation efficiency is assumed. For data reception, two configurations for the UEs/STAs' antennas are considered:

- **Omnidirectional reception:** UEs/STAs receive data omnidirectionally. In this case, for the LBR scheme, sensing at UE side will also be performed omnidirectionally.
- **Quasi-omnidirectional reception:** the receive beam gain at UEs/STAs is fixed to 7 dB with a receive main lobe beamwidth of  $90^\circ$  while assuming ideal antenna radiation efficiency. In this case, LBR will be implemented through directional sensing (in the receive beam) at UE side.

The ED threshold for LBT, normalized by the maximum antenna gain for sensing, is set to  $-74$  dBm<sup>14</sup>. We do not emulate backoff processes for both WiGig CCA and NR-U LBT, and simply consider how many pairs (connections) can reuse the spectrum according to the different channel access procedures. Simulation results are averaged among 1000 random deployments.

For the performance metrics, we collect sum-rate and mean-rate during channel access. The sum-rate is the sum of data rates of all the pairs that can simultaneously access the channel. On the other hand, the mean-rate corresponds to the average of the rates over the connections that get access to the channel. This may be a useful metric to measure the QoS obtained by the different RATs. In addition, to account for fairness, we also evaluate the average number of connections that get access to the channel for both NR-U and WiGig systems.

### B. Results and Comparison

We categorize the results based on the reception type implemented at the UEs and STAs sides. For the omnidirectional reception at UEs/STAs, the collected results are shown in Fig. 18, and for the quasi-omnidirectional reception, the results are shown in Fig. 19. Within the figures, subfigures (a) and (b) show the sum-rate and mean-rate with different number of total pairs ( $K$ ), respectively. Subfigures (c) and (d) depict the number of pairs that get access to the channel and their attained mean-rate in each of the systems, i.e., NR-U and WiGig, respectively, with  $K=40$ .

For omnidirectional reception, we observe that:

- No-LBT provides the lowest mean-rate for all  $K$ . It is worse than omniLBT for coexistence since it reduces the number of WiGig connections and their attained rate (see Fig. 18.(c)-(d)). Also, as  $K$  increases, the sum-rate gets saturated due to the interference (see Fig. 18.(a)).
- LBT strategies at gNB side (omniLBT, dirLBT, pairLBT, LBTswitch):
  - The omniLBT-dirLBT trade-off is observed. OmniLBT is overprotective (low number of NR-U connections access), so that it obtains a lower sum-rate but a higher mean-rate than dirLBT (see Fig. 18.(a)-(b)). DirLBT enables spatial reuse at gNBs (high number of NR-U connections) but hidden nodes arise, which also impacts WiGig performance negatively since more NR-U nodes access and interfere (see Fig. 18.(d)).
  - PairLBT performs similar to dirLBT for omnidirectional reception. It is not effective for an omnidirectional reception configuration because the LBT in

<sup>14</sup>Note that directional transmissions are considered but the sensing stage can be performed either directionally or omnidirectionally. Thus, a normalized ED threshold of  $-74$  dBm is considered by taking into account the receive gain used for sensing, which corresponds to an ED threshold of  $-74$  dBm for omniLBT and  $-64$  dBm for dirLBT. Similarly, in case of LBR, it depends on the data reception configuration; for omnidirectional reception, the ED threshold is  $-74$  dBm, while it is  $-67$  dBm for quasi-omnidirectional reception. Recall that the noise power for  $W=1$  GHz with noise power spectral density of  $-174$  dBm/Hz results in  $-84$  dBm, and thus we consider  $-74$  dBm as the ED in omniLBT to account for the noise figure.

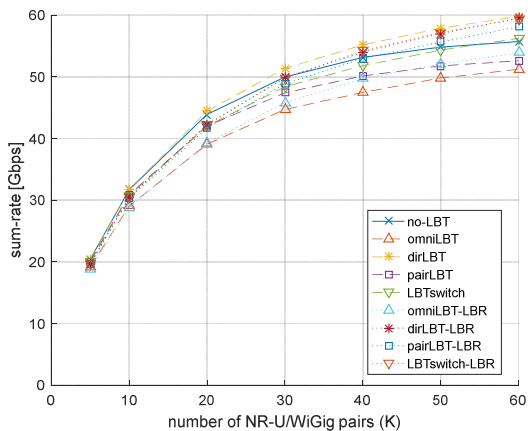

(a) Global sum-rate

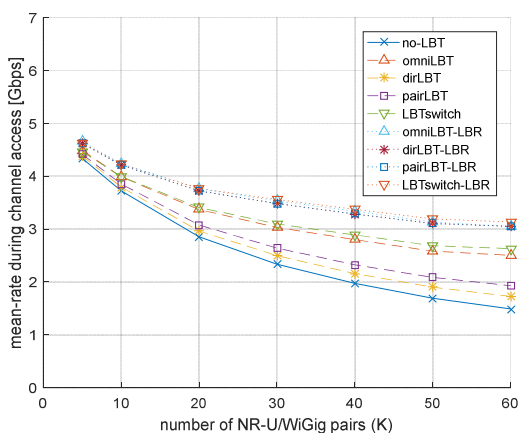

(b) Global mean-rate

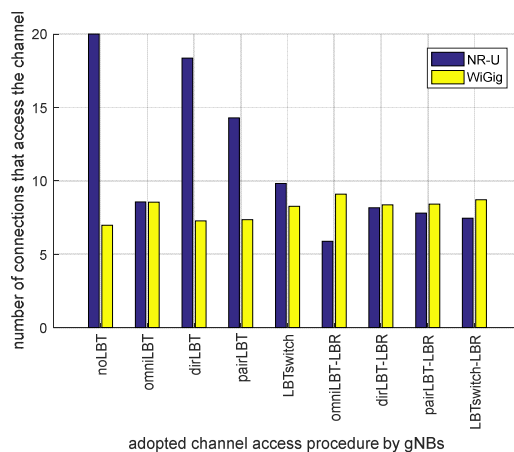

(c) Number of pairs that access the channel

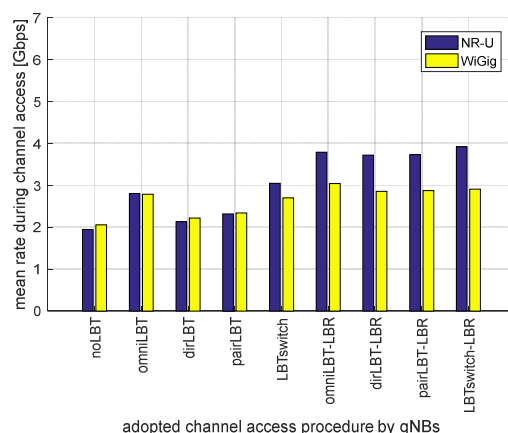

(d) Mean-rate for NR-U and WiGig

Fig. 18: Performance evaluation of different NR-U channel access procedures, for omnidirectional reception at UEs/STAs. The WiGig channel access is kept as per IEEE 802.11ad standard, i.e., omniLBT. (a) Sum-rate (Gbps) vs.  $K$ . (b) Mean-rate during channel access (Gbps) vs.  $K$ . (c) Number of pairs that get access to the channel when  $K=40$ , for NR-U and WiGig, separately. (d) Mean-rate during channel access (Gbps) when  $K=40$ , for NR-U and WiGig, separately.

the opposite direction cannot properly detect all the hidden nodes that are interfering the UE.

- LBTswitch improves the mean-rate compared to dirLBT, omniLBT, and pairLBT, as shown in Fig. 18.(d). It is able to enhance the fairness of NR-U pairs as compared to omniLBT, since more NR-U connections get access to the channel while not affecting negatively the number of WiGig accesses and their average rate. In addition, compared to dirLBT and pairLBT, since LBTswitch is able to properly adapt the type of carrier sense at every gNB as a function of the observed neighboring gNBs/APs density and activity, it provides better performance in such coexistence scenario.
- Receiver-assisted LBT strategies with sensing at gNB and UE side (omniLBT-LBR, dirLBT-LBR, pairLBT-LBR, LBTswitch-LBR): In general, sensing at the UE side provides large benefits at unlicensed bands since it overcomes the deficiencies of LBT under beam-based transmissions. This can be observed in the number of connections accessing the channel, their attained mean-

rate, and the system sum-rate. We observe that, however, omniLBT-LBR is too much conservative and cannot provide the spatial reuse and sum-rate as of dirLBT-LBR, pairLBT-LBR, and LBTswitch-LBR. In general, LBR acts as good neighbor for WiGig nodes as it does not impact the number of WiGig nodes that access the channel and their attained rate, while at the same time NR-U pairs achieve a much larger rate during channel access. Recall that LBR-based techniques get the same access probability than omniLBT but, since only the properly selected gNBs access, it provides a higher mean-rate (see Fig. 18.(c)-(d)).

For quasi-omnidirectional reception, as shown in Fig. 19, similar trends are observed but with: 1) lower relative differences in the performance among the different schemes, and 2) larger rates because of the reduced interference levels due to directional reception. However, few differences are observed for this configuration:



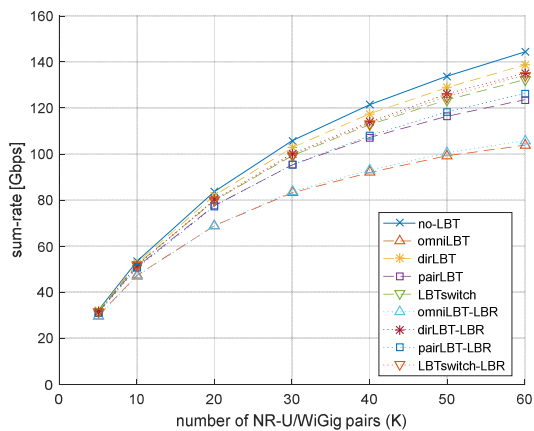

(a) Global sum-rate

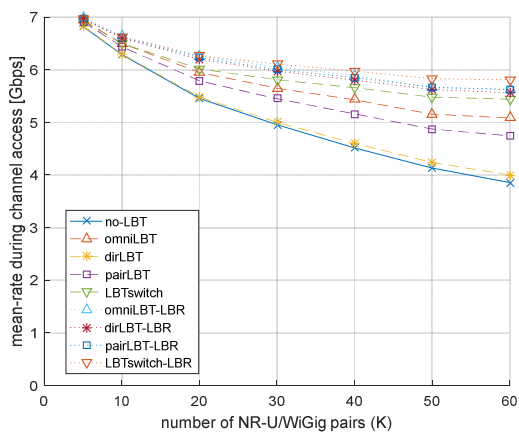

(b) Global mean-rate

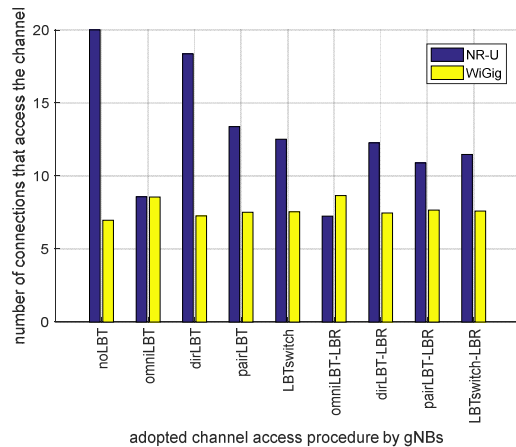

(c) Number of pairs that access the channel

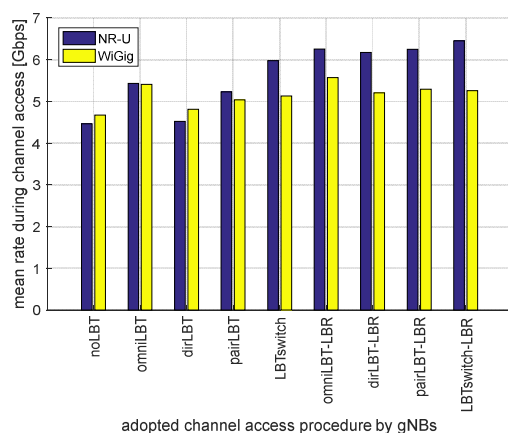

(d) Mean-rate for NR-U and WiGig

Fig. 19: Performance evaluation of different NR-U channel access procedures, for quasi-omnidirectional reception at UEs/STAs. The WiGig channel access is kept as per IEEE 802.11ad standard, i.e., omniLBT. (a) Sum-rate (Gbps) vs  $K$ . (b) Mean-rate during channel access (Gbps) vs  $K$ . (c) Number of pairs that get access to the channel when  $K=40$ , for NR-U and WiGig, separately. (d) Mean-rate during channel access (Gbps) when  $K=40$ , for NR-U and WiGig, separately.

- PairLBT with directional reception is able to address the omniLBT-dirLBT trade-off, since the sensing beam for the opposite direction can be properly adjusted.
- Although LBR-based procedures obtain the largest QoS (mean-rate), the largest system capacity is given by the no-LBT scheme because excessive interference does not arise due to directional receptions and, thus, the larger the spatial reuse is, the larger the system capacity is.
- LBTswitch gets a mean-rate similar to LBR-based approaches.

We would like to remark that information from UE side is shown to be significantly beneficial to improve the coexistence in unlicensed bands with beam-based transmissions, particularly in the case of omnidirectional reception. This is observed in the performance of LBTswitch-LBR. LBTswitch-LBR performs better than the other strategies because it includes sensing at the UE as well as recommendation from UE side regarding the type of carrier sense to be performed at the gNB for LBT. On the other hand, for quasi-omnidirectional reception, one type of UE feedback (either to switch the LBT strategy or to allow/prevent the access through LBR)

is sufficient to improve simultaneously the spatial reuse and the QoS.

## XII. LESSONS LEARNED

The lessons that we have learned and discussed throughout this article are summarized as follows.

- **The usage of pairLBT and LBTswitch in NR-U help in reducing exposed node and hidden node problems, as compared to omniLBT and dirLBT:** Multiple solutions are available to implement carrier sense at the transmitter side for LBT under beam-based transmissions. The two trivial solutions, i.e., omniLBT and dirLBT have different trade-offs in terms of system performance, fairness, and complexity. It is due to the different types of sensing that accentuate exposed nodes in omniLBT and hidden nodes in dirLBT. These trade-offs can be addressed by using paired directional sensing at the transmitter side (pairLBT), or switching the type of carrier sense at the transmitter as a function of density and activity of neighboring nodes observed from the receiver side (LBTswitch).

- **The efficiency of pairLBT and LBTswitch is demonstrated in NR-U/WiGig coexistence scenarios:** Results have shown that pairLBT is useful for scenarios in which data reception is directional. Otherwise, for omnidirectional data reception, there are hidden node problems that cannot be detected at the transmitter, even with multiple paired sensings. On the other hand, results have shown that LBTswitch performs better than omniLBT, dirLBT, and pairLBT because it includes recommendation from the UE side regarding the type of carrier sense (omni or dir) to be performed at gNBs based on the observed potential interferers. So, information from the UE side is beneficial to improve coexistence in beam-based NR-U.
- **Receiver-assisted LBT solutions help in overcoming the deficiencies of sensing only at the transmitter side:** For beam-based communications in the unlicensed band, due to the use of directional antenna arrays, the observed channel status at the transmitter may be different from the perceived interference at the receiver side. Therefore, performing carrier sense at the transmitter side (i.e., LBT) may not be sufficient. This can be fixed by using receiver-assisted LBT solutions, which provide the receiver (UE) an opportunity to sense the shared channel using LBR and assist the transmitter for channel access using a feedback. Indeed, LBR can be combined with different types of sensing at the transmitter side.
- **The effectiveness of receiver-assisted LBT over LBT-based strategies is demonstrated in NR-U/WiGig coexistence scenarios:** Results have shown that sensing at the UE side (LBR) provides large fairness and QoS benefits in NR-U/WiGig coexistence scenarios at mmWave bands. Results confirm that RTS/CTS-like mechanisms are beneficial to NR-U. Moreover, among the LBT-LBR combinations, it is observed that LBTswitch-LBR performs better than omniLBT-LBR, dirLBT-LBR, and pairLBT-LBR. This is due to the fact that, in LBTswitch-LBR, the feedback from the UE after performing LBR includes also a recommendation for the type of LBT to be used at the transmitter side.
- **Coordination of LBT processes improves NR-U channel reuse:** Mechanisms to enable frequency reuse among NR-U devices of the same operator are needed to improve the system performance and avoid LBT blocking between devices of the same operator. The potential mechanisms to support intra-RAT tight frequency reuse are: multi-ED strategies, self-defer schemes, and a new mechanism proposed in this paper, i.e., LBT coordination, which enables time/frequency coordination of the resource allocation as well as coordination among the LBT procedures of different nodes.
- **Sensing at the receiver node is useful to properly update the LBT CWS in beam-based NR-U:** Multiple issues arise when using HARQ feedback to update the CWS (as done in LAA) for the case of beam-based transmissions. It is because of the lack of correlation between a collision indicated by a NACK and the transmit beam, as well as due to the inability to enter in the backoff phase after an incorrect sensing phase. We have proposed a solution to fix these problems by using a receiver-assisted CWS adjustment that considers paired sensing at the receiver (UE) for the CWS update. It does not use HARQ feedback.
- **Multiple DL/UL switches within the COT is beneficial for NR-U:** Two options are considered for the COT structure in NR-U, i.e., a single DL/UL switch and multiple DL/UL switches, each with their pros and cons, as considered in the current discussions for NR-U specification. To reduce the end-to-end latency, a COT with multiple DL/UL switches is preferred. It is identified that the number of switching points should be further optimized based on the traffic patterns and flow requirements.
- **SS block design improvements are needed for initial access in NR-U:** Multiple challenges of the SS block design in the unlicensed context arise due to the LBT and OCB requirements. To reduce the LBT impact, multiple occasions for SS block transmissions can be used to improve channel access probability. Some NR SS block patterns need to be redesigned to leave enough time for the sensing phase in between two SS block transmissions. To meet the OCB requirement in the 60 GHz band, new design solutions for SS blocks resource mapping are proposed. It includes frequency-domain SS block repetitions, split and/or reordering of the the SS block time-frequency structure, and frequency-domain interlaced mapping of the signals that compose the SS block.
- **NR and eLAA enhancements regarding RACH procedure can be reused for NR-U:** Enhancements to the current four step RACH procedure are needed to reduce the delay associated with it. This can be fixed by increasing the transmit opportunities for each message of the RACH procedure, simplifying the overall RACH procedure (as already contemplated in NR), and/or enhancing the LBT design for random access. Also, to meet the OCB requirements, adaptation in NR PRACH preamble formats is needed, as it was done in eLAA.
- **Paging solutions already defined in NR are useful for NR-U:** The uncertainty of channel availability in the unlicensed context complicates the paging procedure in NR-U with standalone and dual-connectivity operations. Multiple opportunities for the paging procedures, for example, using paging message repetitions through the time and/or space domains, have been identified as beneficial for NR-U. Some of such solutions are already being supported in NR specification.
- **HARQ procedures defined in eLAA could be reused for NR-U:** Two problems related to the HARQ procedure in NR-U with standalone operation, caused by the usage of the LBT requirement, have been identified: HARQ feedback blocking of a DL HARQ process and UL data blocking of an UL HARQ process. To solve the former, the concept of a triggered grant, as per eLAA, can be used. To fix the latter, solutions based on opportunistic and triggered HARQ feedback could be beneficial.
- **There are pros and cons regarding the LBT placement in real implementations (LBT after or before**

**MAC):** Two implementation-specific solutions for what regards the LBT placement versus the scheduling operation are: LBT before MAC processing and LBT after MAC processing. For the DL access, pros and cons of each solution are apparent. LBT before MAC processing provides more flexibility at the scheduler, reduces complexity of the scheduler implementation, but it increases the access delay and may require the use of reservation signals. On the other hand, LBT after MAC processing reduces/avoids the need for reservation signals, reduces the access delay if LBT success, but requires handling of rescheduling if LBT fails. Although this is not discussed in the standardization, and the impact in NR may be lower than in LTE in unlicensed spectrum due to the lower NR processing timings, the authors believe that practical implementations should carefully analyze these aspects.

- **A possible scheduling solution including a specific LBT placement is to use spatial replicas:** To address the issues in the DL access mentioned in the previous bullet, in this paper we have proposed a new scheduling solution that uses multiple spatial replicas and LBT after MAC processing for NR-U DL access. The proposed solution exploits the multi-beam and multi-TRP deployment in NR, while meeting the LBT requirement in DL, as a way to increase the reliability, to reduce the impact of LBT failure on latency, and to reduce the access delay.
- **Alternative UL scheduling methods defined in NR, FeLAA, and MulteFire are beneficial for NR-U:** UL dynamic scheduling in the unlicensed context may incur long delays to UL data transmissions. Scheduling schemes with less dynamic nature, like autonomous UL (defined in FeLAA), grant-less UL (used in MulteFire), or configured grant (standardized in NR), can be more favorable for NR-U UL transmissions in reducing the message exchange overhead and the access delay.

### XIII. FUTURE PERSPECTIVES

The future perspectives and opportunities for NR-U related research that we envision are:

- **Integration of mmWave and sub 7 GHz licensed/unlicensed bands:** Integration of mmWave and sub 7 GHz bands has been studied in the NR context with licensed bands [109], [110], as well as in the WiGig context with unlicensed bands [111]. How to potentially reuse and extend them for NR-U by combining licensed/unlicensed/shared paradigms under different operational modes (i.e., carrier aggregation and standalone) is an interesting area for further research [112]. Also, multi-band and multi-channel selection algorithms in this context could be investigated.
- **NR-U for ultra-reliable and low-latency communications:** The impact of LBT on the latency performance of MulteFire has been assessed in [46], both analytically and through simulations. Extension of the analytic framework and system-level simulations for NR-U are of high interest to understand if NR-U can meet strict low-latency and high-reliability requirements [71]. If not, then what

modifications are required (if any) to support the URLLC use case.

- **NR-U for future smart factories:** Industry 4.0 has emerged as an important application for NR-U since it requires wireless-connected and privately-owned networks [45], [113]. A future research line is to develop theoretical foundations for licensed, unlicensed and shared spectrum paradigms to use NR-U as the RAT for future smart factories. For example, to accommodate multiple devices with diverse requirements such as extended reality applications, URLLC devices, sensors, mobile robots, etc. simultaneously.
- **Improved beam-training for unlicensed-based access:** The impact of LBT on the beam training processes needs to be investigated. Recently, authors in [65] proposed a joint directional received-assisted LBT (i.e., dirLBT/dirLBR) and beam training. It identifies the best beam pair for NR-U communication by taking both channel blocking and channel quality into account. Further research in this line, and the impact on the overall network efficiency should be studied.
- **Beam reciprocity in unlicensed:** Even if TDD is used and DL and UL transmissions are performed within the coherence time interval, it may happen that the best beam for DL reception is not the best beam for UL transmissions. This is due to LBT blocking effects and the differences in the received interference at transmitter and receiver sides, which are accentuated at mmWave bands. Therefore, the study of best beam-pair selection, independently for DL and UL, jointly with the unlicensed band access constraints, could be further investigated.
- **Grant-less UL in the unlicensed mmWave bands:** Grant-less UL is useful to reduce the scheduling delays and get fast access to the channel at the cost of increased collisions. Therefore, pros and cons of grant-based and grant-free access schemes should be properly evaluated for NR-U beam-based access to unlicensed spectrum. Also, optimization of the access scheme and the number of repetitions for grant-less UL to guarantee successful access and decoding while minimizing energy consumption at UEs could be investigated.

### XIV. CONCLUSIONS

In this paper, we highlight the challenges and analyze the potential solutions for NR-based access to unlicensed spectrum with beam-based transmissions. We discuss different topics such as channel access, frame structure, initial access, HARQ, and scheduling in the context of NR-U. For the channel access procedures, we review the solutions to support *i)* LBT under beam-based transmissions, *ii)* receiver-assisted LBT in beam-based transmissions, *iii)* intra-RAT frequency reuse improvement, and *iv)* CWS adjustment in beam-based transmissions. With the help of simulations, we show that feedback from the receiver significantly improves the performance of coexistence in terms of QoS and fairness. In terms of COT structures, slots with multiple DL/UL switching points within the COT are shown to be more suitable for NR-U. For NR-U initial access,

we discuss the design consideration for SS block design, RACH procedure, and paging procedure to take LBT and OCB requirements into account. At the MAC level, two problems related to the HARQ procedures are identified, for which, we describe the solutions based on self-contained, triggered, and opportunistic HARQ feedbacks. We also discuss the issues related to the dynamic scheduling in NR-U, where, we propose a multiple spatial replicas based solution, and also indicate that the existing scheduling schemes such as grant-less UL and configured grant that have less control signaling for UL access may be suitable for NR-U. Finally, we provide a summary of all of our main findings as well as future research perspectives for NR-U beam-based transmissions.

## XV. ACKNOWLEDGMENTS

This work was partially funded by Spanish MINECO grant TEC2017-88373-R (5G-REFINE) and Generalitat de Catalunya grant 2017 SGR 1195. Also, it was supported by InterDigital Communications, Inc.

## REFERENCES

- [1] H. Zhang, "Coexistence of Wi-Fi and heterogeneous small cell networks sharing unlicensed spectrum," *IEEE Communications Magazine*, vol. 53, pp. 158–164, Mar. 2015.
- [2] R. Zhang, M. Wang, L. X. Cai, Z. Zheng, X. Shen, and L. Xie, "Lte-unlicensed: the future of spectrum aggregation for cellular networks," *IEEE Wireless Communications*, vol. 22, pp. 150–159, June 2015.
- [3] M. Labib, "Extending LTE into the unlicensed spectrum: technical analysis of the proposed variants," *IEEE Communications Standards Magazine*, vol. 1, pp. 31–39, Dec. 2017.
- [4] 5G Americas, *5G Spectrum Recommendations*, Apr. 2017.
- [5] Z. Pi and F. Khan, "An introduction to millimeter-wave mobile broadband systems," *IEEE Communications Magazine*, vol. 49, pp. 101–107, June 2011.
- [6] V. Wong, R. Schober, D. Wing, and L.-C. Wang, *Key Technologies for 5G Wireless Systems*. Cambridge University Press, 2017.
- [7] 3GPP TS 38.300, *TSG RAN; NR; Overall description; Stage 2*, Release 15, v15.3.1, Oct. 2018.
- [8] 3GPP TR 38.912, *Study on New Radio (NR) access technology (Release 14)*, V14.1.0, Aug. 2017.
- [9] S. Parkvall, E. Dahlman, A. Furuskar, and M. Frenne, "Nr: The new 5g radio access technology," *IEEE Communications Standards Magazine*, vol. 1, pp. 24–30, Dec 2017.
- [10] M. Giordani, M. Polese, A. Roy, D. Castor, and M. Zorzi, "A tutorial on beam management for 3gpp nr at mmwave frequencies," *IEEE Communications Surveys Tutorials*, vol. 21, pp. 173–196, Firstquarter 2019.
- [11] H. Kwon, J. Jeon, A. Bhorkar, Q. Ye, H. Harada, Y. Jiang, L. Liu, S. Nagata, B. L. Ng, T. Novlan, J. Oh, and W. Yi, "Licensed-assisted access to unlicensed spectrum in lte release 13," *IEEE Communications Magazine*, vol. 55, pp. 201–207, February 2017.
- [12] 3GPP TR 36.889, *Study on Licensed Assisted Access to Unlicensed Spectrum (Release 13)*, V13.0.0, June 2015.
- [13] LTE-U Forum, LTE-U Technical Report, *Coexistence study for LTE-U SDL V1.0*, Feb. 2015.
- [14] C. Rosa, M. Kuusela, F. Frederiksen, and K. I. Pedersen, "Standalone lte in unlicensed spectrum: Radio challenges, solutions, and performance of multfire," *IEEE Communications Magazine*, vol. 56, pp. 170–177, OCTOBER 2018.
- [15] *MultFire*. Available at: <https://www.multifire.org/>.
- [16] RP-170828, 3GPP TSG RAN 75 Meeting, *Study on NR-based Access to Unlicensed Spectrum*, Mar. 2017.
- [17] 3GPP TR 38.889, *Study on NR-based access to unlicensed spectrum (Release 15)*, v16.0.0, Dec. 2018.
- [18] RP-190706, 3GPP TSG RAN 83 Meeting, *Revised WID on NR-based Access to Unlicensed Spectrum*, Mar. 2019.
- [19] 3GPP TR 38.805, *Study on New Radio access technology; 60 GHz unlicensed spectrum (Release 14)*, V14.0.0, Mar. 2017.
- [20] *IEEE 802.11ad Specific requirements*. Part 11: Wireless LAN Medium Access Control. Available at: <http://standards.ieee.org/findstds/standard/802.11ad-2012.html>.
- [21] T. Nitsche, C. Cordeiro, A. B. Flores, E. W. Knightly, E. Perahia, and J. C. Widmer, "Ieee 802.11ad: directional 60 ghz communication for multi-gigabit-per-second wi-fi [invited paper]," *IEEE Communications Magazine*, vol. 52, pp. 132–141, December 2014.
- [22] Y. Ghasempour, C. R. C. M. da Silva, C. Cordeiro, and E. W. Knightly, "Ieee 802.11ay: Next-generation 60 ghz communication for 100 gb/s wi-fi," *IEEE Communications Magazine*, vol. 55, pp. 186–192, Dec 2017.
- [23] ETSI 302 567, *Harmonised European Standard; Multiple-Gigabit/s radio equipment operating in the 60 GHz band; Harmonised Standard covering the essential requirements of article 3.2 of Directive 2014/53/EU*, v.2.1.1 ed., July 2017.
- [24] L. Giupponi, T. Henderson, B. Bojovic, and M. Miozzo, "Simulating LTE and Wi-Fi Coexistence in Unlicensed Spectrum with ns-3," *eprint arXiv:1604.06826*, July 2016.
- [25] J. G. Andrews, T. Bai, M. N. Kulkarni, A. Alkhatieb, A. K. Gupta, and R. W. Heath, "Modeling and analyzing millimeter wave cellular systems," *IEEE Transactions on Communications*, vol. 65, pp. 403–430, Jan 2017.
- [26] A. P. Subramanian and S. R. Das, "Addressing deafness and hidden terminal problem in directional antenna based wireless multi-hop networks," *Springer Journal Wireless Networks*, vol. 16, pp. 1557–1567, Sep. 2008.
- [27] A. A. Zaidi, R. Baldemair, H. Tullberg, H. Bjurek, L. Sundstrom, J. Medbo, C. Kilinc, and I. Da Silva, "Waveform and numerology to support 5g services and requirements," *IEEE Communications Magazine*, vol. 54, pp. 90–98, November 2016.
- [28] J. Liu, K. Au, A. Maaref, J. Luo, H. Baligh, H. Tong, A. Chassaing, and J. Lorca, "Initial access, mobility, and user-centric multi-beam operation in 5g new radio," *IEEE Communications Magazine*, vol. 56, pp. 35–41, March 2018.
- [29] RP-152272, 3GPP TSG RAN 70 Meeting, *New Work Item on enhanced LAA for LTE (Release 14)*, May 2015.
- [30] 3GPP TS 36.213, *LTE; E-UTRA; Physical layer procedures (Release 14)*, v15.3.0, Sep. 2018.
- [31] RP-170848, 3GPP TSG RAN 75 Meeting, *New Work Item on enhancements to LTE operation in unlicensed spectrum (Release 15)*, Mar. 2017.
- [32] B. Chen, J. Chen, Y. Gao, and J. Zhang, "Coexistence of lte-laa and wi-fi on 5 ghz with corresponding deployment scenarios: A survey," *IEEE Communications Surveys Tutorials*, vol. 19, pp. 7–32, Firstquarter 2017.
- [33] C. Chen, R. Ratasuk, and A. Ghosh, "Downlink performance analysis of lte and wifi coexistence in unlicensed bands with a simple listen-before-talk scheme," in *2015 IEEE 81st Vehicular Technology Conference (VTC Spring)*, pp. 1–5, May 2015.
- [34] L. Falconetti, D. H. Kang, R. Karaki, E. Obregon, J. Cheng, H. Koorapaty, A. Mukherjee, S. Falahati, and D. Larsson, "Design and evaluation of licensed assisted access lte in unlicensed spectrum," *IEEE Wireless Communications*, vol. 23, pp. 24–30, December 2016.
- [35] Qualcomm Technologies Inc., "LTE-U Technology and Coexistence." LTE-U Forum Workshop, May 2015. [Accessed May 27, 2019].
- [36] X. Wang, T. Q. S. Quek, M. Sheng, and J. Li, "Throughput and fairness analysis of wi-fi and lte-u in unlicensed band," *IEEE Journal on Selected Areas in Communications*, vol. 35, pp. 63–78, Jan 2017.
- [37] H. He, H. Shan, A. Huang, L. X. Cai, and T. Q. S. Quek, "Proportional fairness-based resource allocation for lte-u coexisting with wi-fi," *IEEE Access*, vol. 5, pp. 4720–4731, 2017.
- [38] A. M. Voicu, L. Simic, and M. Petrova, "Inter-technology coexistence in a spectrum commons: A case study of wi-fi and lte in the 5-ghz unlicensed band," *IEEE Journal on Selected Areas in Communications*, vol. 34, pp. 3062–3077, Nov 2016.
- [39] J. Jeon, H. Niu, Q. C. Li, A. Papatthassiou, and G. Wu, "Lte in the unlicensed spectrum: Evaluating coexistence mechanisms," in *2014 IEEE Globecom Workshops (GC Wkshps)*, pp. 740–745, Dec 2014.
- [40] C. Cano and D. J. Leith, "Unlicensed lte/wifi coexistence: Is lbt inherently fairer than csat?," in *2016 IEEE International Conference on Communications (ICC)*, pp. 1–6, May 2016.
- [41] Y. Li, F. Baccelli, J. G. Andrews, T. D. Novlan, and J. C. Zhang, "Modeling and analyzing the coexistence of wi-fi and lte in unlicensed spectrum," *IEEE Transactions on Wireless Communications*, vol. 15, pp. 6310–6326, Sep. 2016.

- [42] B. Bojovic, L. Giupponi, Z. Ali, and M. Miozzo, "Evaluating unlicensed lte technologies: Laa vs lte-u," *IEEE Access*, vol. 7, pp. 89714–89751, 2019.
- [43] Qualcomm News, *Introducing MulteFire: LTE-like performance with Wi-Fi-like simplicity*, June 2015.
- [44] Nokia Executive Summary, *The MulteFire opportunity for unlicensed spectrum*, 2015.
- [45] B. Chen, J. Wan, L. Shu, P. Li, M. Mukherjee, and B. Yin, "Smart factory of industry 4.0: Key technologies, application case, and challenges," *IEEE Access*, vol. 6, pp. 6505–6519, Dec. 2018.
- [46] R. M. Cuevas, C. Rosa, F. Frederiksen, and K. I. Pedersen, "On the impact of listen-before-talk on ultra-reliable low-latency communications," in *2018 IEEE Global Communications Conference (GLOBECOM)*, pp. 1–6, Dec 2018.
- [47] Y. Zeng, T. Zhou, H. Hu, Y. Yang, J. Tian, and Z. Li, "Weight based channel selection towards 5g in the unlicensed spectrum," *China Communications*, vol. 15, pp. 54–66, Aug 2018.
- [48] A. Garcia-Rodriguez, G. Geraci, L. G. Giordano, A. Bonfante, M. Ding, and D. Lopez-Perez, "Massive mimo unlicensed: A new approach to dynamic spectrum access," *IEEE Communications Magazine*, vol. 56, pp. 186–192, June 2018.
- [49] H. Song, Q. Cui, Y. Gu, G. L. Stuber, Y. Li, Z. Fei, and C. Guo, "Cooperative lbt design and effective capacity analysis for 5g nr ultra dense networks in unlicensed spectrum," *IEEE Access*, vol. 7, pp. 50265–50279, 2019.
- [50] M. Nekovee, Y. Qi, and Y. Wang, "Distributed beam scheduling for multi-rat coexistence in mm-wave 5g networks," in *2016 IEEE 27th Annual International Symposium on Personal, Indoor, and Mobile Radio Communications (PIMRC)*, pp. 1–6, Sep. 2016.
- [51] M. Nekovee, Y. Qi, and Y. Wang, "Self-organized beam scheduling as an enabler for coexistence in 5G unlicensed bands," *IEICE Transactions on Communications*, vol. E100B, pp. 1181–1189, Aug. 2017.
- [52] L. Zhang, M. Xiao, G. Wu, M. Alam, Y. Liang, and S. Li, "A survey of advanced techniques for spectrum sharing in 5g networks," *IEEE Wireless Communications*, vol. 24, pp. 44–51, October 2017.
- [53] H. Seo, J. Park, M. Bennis, and W. Choi, "Consensus-before-talk: Distributed dynamic spectrum access via distributed spectrum ledger technology," in *2018 IEEE International Symposium on Dynamic Spectrum Access Networks (DySPAN)*, pp. 1–7, Oct 2018.
- [54] F. Boccardi, H. Shokri-Ghadikolaei, G. Fodor, E. Erkip, C. Fischione, M. Kountouris, P. Popovski, and M. Zorzi, "Spectrum pooling in mmwave networks: Opportunities, challenges, and enablers," *IEEE Communications Magazine*, vol. 54, pp. 33–39, November 2016.
- [55] P. Zhou, K. Cheng, X. Han, X. Fang, Y. Fang, R. He, Y. Long, and Y. Liu, "Ieee 802.11ay-based mmwave w lans: Design challenges and solutions," *IEEE Communications Surveys Tutorials*, vol. 20, pp. 1654–1681, thirdquarter 2018.
- [56] S. Singh, R. Mudumbai, and U. Madhow, "Distributed coordination with deaf neighbors: Efficient medium access for 60 ghz mesh networks," in *2010 Proceedings IEEE INFOCOM*, pp. 1–9, March 2010.
- [57] X. An and R. Hekmat, "Directional mac protocol for millimeter wave based wireless personal area networks," in *VTC Spring 2008 - IEEE Vehicular Technology Conference*, pp. 1636–1640, May 2008.
- [58] C. W. Pyo, F. Kojima, J. Wang, H. Harada, and S. Kato, "MAC enhancement for high speed communications in the 802.15.3c mmWave WPAN," *Springer Wireless Personal Communications*, vol. 51, pp. 825–841, July 2009.
- [59] L. X. Cai, L. Cai, X. Shen, and J. W. Mark, "Rex: A randomized exclusive region based scheduling scheme for mmwave wpans with directional antenna," *IEEE Transactions on Wireless Communications*, vol. 9, pp. 113–121, January 2010.
- [60] S. Lagen, L. Giupponi, and N. Patriciello, "Lbt switching procedures for new radio-based access to unlicensed spectrum," in *2018 IEEE Globecom Workshops (GC Wkshps)*, pp. 1–6, Dec 2018.
- [61] Huawei, HiSilicon, 3GPP R1-1713785, 3GPP TSG RAN WG1 90 Meeting, *Coexistence and channel access for NR unlicensed band operation*, Aug. 2017.
- [62] S. Lagen, L. Giupponi, B. Bojovic, A. Demir, and M. Beluri, "Paired listen before talk for multi-rat coexistence in unlicensed mmwave bands," in *2018 IEEE International Conference on Communications Workshops (ICC Workshops)*, pp. 1–6, May 2018.
- [63] S. Lagen and L. Giupponi, "Listen before receive for coexistence in unlicensed mmwave bands," in *2018 IEEE Wireless Communications and Networking Conference (WCNC)*, pp. 1–6, April 2018.
- [64] 3GPP R1-180xxxx, 3GPP TSG RAN WG1 92bis Meeting, *Draft report, Chairman notes*, Apr. 2018.
- [65] P. Li, D. Liu, and F. Yu, "Joint directional lbt and beam training for channel access in unlicensed 60ghz mmwave," in *2018 IEEE Globecom Workshops (GC Wkshps)*, pp. 1–6, Dec 2018.
- [66] mmMAGIC project - Deliverable D4.1, *Preliminary radio interface concepts for mmwave mobile communications*, June 2016.
- [67] E. Perahia and M. X. Gong, "Gigabit wireless LANs: an overview of IEEE 802.11ac and 802.11ad," *ACM SIGMOBILE Mobile Computing and Communications Review*, vol. 15, pp. 23–33, July 2011.
- [68] ETSI 301 893, *Harmonised European Standard; 5 GHz RLAN; Harmonised Standard covering the essential requirements of article 3.2 of Directive 2014/53/EU*, v.2.1.1 ed., May 2017.
- [69] FCC Title 47 15.255, FCC. Available at: <http://www.gpo.gov/fdsys/pkg/CFR-2013-title47-vol1/pdf/CFR-2013-title47-vol1-sec15-255.pdf>.
- [70] 3GPP R1-180xxxx, 3GPP TSG RAN WG1 93 Meeting, *Draft report, Chairman notes*, May 2018.
- [71] 3GPP TR 38.913, *Study on scenarios and requirements for next generation access technologies (Release 14)*, v14.3.0, Aug. 2017.
- [72] N. Patriciello, S. Lagen, B. Bojovic, and L. Giupponi, "An E2E simulator for 5G NR networks," *Elsevier Simulation Modelling Practice and Theory*, vol. 96, p. 101933, Nov. 2019.
- [73] 3GPP TS 38.211, *TSG RAN; NR; Physical channels and modulation*, Release 15, v15.3.0, Sep. 2018.
- [74] Qualcomm, "The 5G unified air interface," Nov. 2015.
- [75] Huawei, HiSilicon, 3GPP R1-1708121, 3GPP TSG RAN WG1 89 Meeting, *Unified design for slot and mini-slot*, May 2017.
- [76] Huawei, HiSilicon, 3GPP R1-1803678, 3GPP TSG RAN WG1 92bis Meeting, *NR frame structure and scheduling on unlicensed bands*, Apr. 2018.
- [77] S. Lagen, B. Bojovic, S. Goyal, L. Giupponi, and J. Mangues-Bafalluy, "Subband configuration optimization for multiplexing of numerologies in 5g tdd new radio," in *2018 IEEE 29th Annual International Symposium on Personal, Indoor and Mobile Radio Communications (PIMRC)*, pp. 1–7, Sep. 2018.
- [78] B. Bojovic, S. Lagen, and L. Giupponi, "Implementation and evaluation of frequency division multiplexing of numerologies for 5G New Radio in ns-3," *Workshop on ns-3*, June 2018.
- [79] Ericsson, R1-1612345, 3GPP TSG RAN WG1 87 Meeting, *Beam management overview*, Nov. 2016.
- [80] Ericsson, R1-1702604, 3GPP TSG RAN WG1 88 Meeting, *Beam management for NR*, Feb. 2017.
- [81] 3GPP TS 38.213, *TSG RAN; NR; Physical layer procedures for control*, Release 15, v15.3.0, Sep. 2018.
- [82] 3GPP TS 38.214, *TSG RAN; NR; Physical layer procedures for data*, Release 15, v15.3.0, Sep. 2018.
- [83] Samsung, 3GPP R1-1806761, 3GPP TSG RAN WG1 93 Meeting, *Channel access procedures for NR-U*, May 2018.
- [84] Huawei, HiSilicon, 3GPP R1-1719841, 3GPP TSG RAN WG1 91 Meeting, *Coexistence and channel access for NR-based unlicensed band operation*, Dec. 2017.
- [85] InterDigital Inc., 3GPP R1-1804870, 3GPP TSG RAN WG1 92bis Meeting, *On Physical Layer Procedures for NR-U*, Apr. 2018.
- [86] Intel Corporation, 3GPP R1-1806548, 3GPP TSG RAN WG1 93 Meeting, *Potential designs to support spatial reuse for NR-unlicensed*, May 2018.
- [87] AT&T, 3GPP R1-1802611, 3GPP TSG RAN WG1 92 Meeting, *Closed Loop LBT for License Assisted NR in Unlicensed Bands*, Mar. 2018.
- [88] Huawei, HiSilicon, 3GPP R1-1803679, 3GPP TSG RAN WG1 92bis Meeting, *Coexistence and channel access for NR unlicensed band operations*, Apr. 2018.
- [89] Nokia, 3GPP R1-1804275, 3GPP TSG RAN WG1 92bis Meeting, *Frame structure for NR-U operation*, Apr. 2018.
- [90] 3GPP TS 38.101-2, *TSG RAN; NR; User Equipment (UE) radio transmission and reception; Part 2: Range 2 Standalone*, Release 15, v15.3.0, Sep. 2018.
- [91] Oppo, 3GPP R1-1803977, 3GPP TSG RAN WG1 92bis Meeting, *SS/PBCH block transmission on NR-U*, Apr. 2018.
- [92] Vivo, 3GPP R1-1803856, 3GPP TSG RAN WG1 92bis Meeting, *Discussion on physical layer channel design in NR unlicensed spectrum*, Apr. 2018.
- [93] Samsung, 3GPP R1-1806762, 3GPP TSG RAN WG1 93 Meeting, *Initial access and mobility procedure for NR-U*, May 2018.
- [94] Samsung, 3GPP R1-1804405, 3GPP TSG RAN WG1 92bis Meeting, *Potential physical layer procedures for NR-U*, Apr. 2018.
- [95] *Methods and apparatus for paging in unlicensed communication channels*, 2017. US20170230933, Qualcomm.
- [96] *Paging in unlicensed spectrum*, 2017. WO/2017/145120, Ericsson.

- [97] 3GPP TS 38.331, *TSG RAN; NR; Radio Resource Control (RRC) protocol specification*, Release 15, v15.3.0, Sep. 2018.
- [98] Huawei, HiSilicon, 3GPP R1-1719401, 3GPP TSG RAN WG1 89 Meeting, *Remaining issues on HARQ*, Dec. 2017.
- [99] Qualcomm, 3GPP R1-1721515, 3GPP TSG RAN WG1 91 Meeting, *Summary of DL/UL scheduling and HARQ management*, Dec. 2017.
- [100] NEC, 3GPP R1-1806671, 3GPP TSG RAN WG1 93 Meeting, *Discussion on HARQ enhancements for NR-U*, May 2018.
- [101] 3GPP TS 37.213, *TSG RAN; Physical layer procedures for shared spectrum channel access*, Release 15, v15.2.0, Mar. 2019.
- [102] 3GPP TS 38.321, *TSG RAN; NR; Medium Access Control (MAC) protocol specification*, Release 15, v15.5.0, Mar. 2019.
- [103] 3GPP R1-1714479, TSG RAN WG1 90 Meeting, Broadcom, *Discussion on additional starting positions for DL in LAA*, Aug. 2017.
- [104] *Design and transmission of (E)PDCCH within partial subframe in licensed assisted access (LAA)*, 2017. WO 2017/074498 A1, Intel.
- [105] *LAA (Licensed-Assisted Access) burst control information*, 2016. WO 2016/122786 A1, Intel.
- [106] *Partial subframe transmission in licensed assisted access*, 2017. WO 2017/078796 A1, Intel.
- [107] *Modulation order adaptation for partial subframes*, 2017. EP 3 131 225 A1, Panasonic.
- [108] Nokia, 3GPP R1-1804313, 3GPP TSG RAN WG1 92bis Meeting, *Channel access and co-existence for NR-U operation*, Apr. 2018.
- [109] O. Semiari, W. Saad, and M. Bennis, "Joint millimeter wave and microwave resources allocation in cellular networks with dual-mode base stations," *IEEE Transactions on Wireless Communications*, vol. 16, pp. 4802–4816, July 2017.
- [110] O. Semiari, W. Saad, M. Bennis, and M. Debbah, "Integrated millimeter wave and sub-6 ghz wireless networks: A roadmap for joint mobile broadband and ultra-reliable low-latency communications," *IEEE Wireless Communications*, vol. 26, pp. 109–115, April 2019.
- [111] T. Nitsche, A. B. Flores, E. W. Knightly, and J. Widmer, "Steering with eyes closed: Mm-wave beam steering without in-band measurement," in *2015 IEEE Conference on Computer Communications (INFOCOM)*, pp. 2416–2424, April 2015.
- [112] X. Lu, E. Sopin, V. Petrov, O. Galinina, D. Moltchanov, K. Ageev, S. Andreev, Y. Koucheryavy, K. Samouylov, and M. Dohler, "Integrated use of licensed- and unlicensed-band mmwave radio technology in 5g and beyond," *IEEE Access*, vol. 7, pp. 24376–24391, 2019.
- [113] 3GPP TR 22.804, *Study on Communication for Automation in Vertical domains (CAV) (Release 15)*, v16.1.0, Sep. 2018.