

LOCAL CONNECTIVITY OF THE MANDELBROT SET AT SOME SATELLITE PARAMETERS OF BOUNDED TYPE

DZMITRY DUDKO AND MIKHAIL LYUBICH

ABSTRACT. We explore geometric properties of the Mandelbrot set \mathcal{M} , and the corresponding Julia sets \tilde{J}_c , near the main cardioid. Namely, we establish that: a) \mathcal{M} is locally connected at certain infinitely renormalizable parameters c of *bounded satellite* type, providing first examples of this kind; b) The Julia sets \tilde{J}_c are also locally connected and have positive area; c) \mathcal{M} is self-similar near Siegel parameters of periodic type. We approach these problems by analyzing the unstable manifold of the pacman renormalization operator constructed in [DLS] as a global transcendental family. It is the first occasion when external rays and puzzles of limiting transcendental maps are applied to study the Polynomial dynamics.

CONTENTS

1. Introduction	1
2. Sector renormalization	9
3. Background on the pacman renormalization	24
4. Dynamics of maximal prepacmen	38
5. External structure of \mathbf{F}_*	47
6. Holomorphic motion of the escaping set	74
7. Parabolic bifurcation and small \mathcal{M} -copies	82
8. The Valuable Flower Theorem	98
9. Proof of the main results	106
Conventions and Notations	120
References	122

1. INTRODUCTION

1.1. Main themes. This paper touches upon several central themes of Holomorphic Dynamics: Rigidity and MLC, local connectivity and area of Julia sets, in their interplay with Renormalization Theory. Developing further the *Pacman Renormalization Theory* designed in [DLS] (jointly with Nikita Selinger), we demonstrate that near-neutral dynamics can be studied as transcendental dynamics on renormalization unstable manifolds. As an application, we produce parameters of new kind, previously unaccessible, where the Mandelbrot set is locally connected and whose Julia sets are locally connected and have positive area.

The MLC problem (of local connectivity of the Mandelbrot set) goes back to the classical work of Douady and Hubbard from the 1980s. The original motivation was to produce a precise topological model for the Mandelbrot set \mathcal{M} . Soon afterwards

a deep connection to the Mostow Rigidity phenomenon was revealed, due to insights by Thurston and Sullivan. Around 1990s, due to the work of Yoccoz, the problem was closely linked to the Quadratic-like Renormalization, by reducing it to the case of *infinitely renormalizable parameters*.

Quadratic-like Renormalization appears in two flavors: *primitive* and *satellite*. The former generates stronger expansion allowing for a better control, which has led to substantial progress in the past 20 years. In particular, MLC was established by Jeremy Kahn and the second author [L2, KL1, KL2] under the *molecule condition* when all the renormalizations stay uniformly away from the satellite type. This covers, in particular, all parameters of *bounded primitive type* [K].

The satellite renormalization is delicately related to the non-expanding rotation regime near the main cardioid of \mathcal{M} , and progress in understanding of this kind of phenomenon has been slower. Recently, Cheraghi and Shishikura [CS], using the Inou-Shishikura *Almost Parabolic Renormalization* [IS], have constructed a certain set of parameters of *unbounded satellite type* where MLC holds. In this paper we construct, by completely different methods, first examples of parameters of *bounded satellite type* where MLC holds. Moreover, Julia sets are also locally connected at these parameters (“JLC”).

Problem of area of Julia sets is intimately related to the MLC and JLC problems, and progress in these three problem has been made in parallel. First examples of Julia sets of positive area were constructed by Buff and Cheritat around 2006 [BC]. Their machinery has produced examples of three types: *Cremer*, *Siegel*, and *infinitely renormalizable of unbounded type* (probably, all *non-locally-connected*). In a more recent work by Artur Avila and the second author [AL2], *infinitely renormalizable* examples of *bounded primitive type* were constructed (all *locally connected*). The machinery developed there applies to maps constructed in this paper giving first examples of Julia sets of positive area for *infinitely renormalizable* maps of *bounded satellite type* (also locally connected).

Our main tool is *Pacman Renormalization* developed in [DLS]. It combines features of two classical Renormalization Theories: *Quadratic-like* and *Siegel*. The latter originated in the 1980s in physics literature, which yielded a long-standing renormalization conjecture. In the 1990s McMullen constructed a Siegel renormalization periodic point and described its maximal analytic extension for any rotation number of periodic type [McM2]. It was proven in [DLS] that this point is hyperbolic with one-dimensional unstable manifold \mathcal{W}^u . (Let us note that in the mid 2000’s Inou and Shishikura proved the existence and hyperbolicity of Siegel renormalization fixed points of sufficiently high combinatorial type using a completely different approach, based upon the parabolic perturbation theory [IS]. On the other hand, Gaidashev and Yampolsky gave a computer assistant proof of hyperbolicity for the golden mean rotation number [GY].)

In this paper we study the above unstable manifold \mathcal{W}^u as a one-parameter transcendental family.

It was shown in [DLS] that every map in \mathcal{W}^u admits a maximal analytic extension to a σ -proper map onto \mathbb{C} . Using ideas of Transcendental Dynamics (compare [DK, EL, Er, SZ, RRRS, Re, BL, BR]), we construct “external rays” and describe the associated “puzzle structure” for this family (§§5–6). This allows us to construct an appropriate quadratic-like family inside \mathcal{W}^u (§7). Using hyperbolicity of the pacman renormalization established in [DLS], we transfer this family

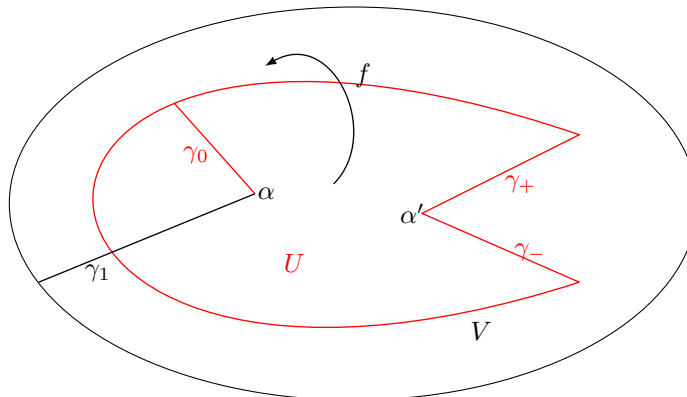

FIGURE 1. A (full) pacman is a $2 : 1$ map $f : U \rightarrow V$ such that the critical arc γ_1 has 3 preimages: γ_0 , γ_+ and γ_- .

along the associated *hybrid lamination* in the space of pacmen, from \mathcal{W}^u to the quadratic family, yielding desired parameters (§9). Let us note that even though similarity between neutral and transcendental dynamics has long been observed (see [Ep, S, SY, CS]), to the best of our knowledge, the external and puzzle structure of the associated transcendental families has never before been explored and applied to the polynomial dynamics; see §1.4 for a further discussion.

We remark in conclusion that the unstable manifold of a quadratic-like renormalization operator can be described in a similar way as it is done in this paper for a pacman renormalization operator. In fact, some steps are simpler for quadratic-like maps thanks to their nice external structure and a simpler algebraic structure of the associated cascade.

1.2. Statement of the results. Let us pass to a more technical description. Let $c(\theta), \theta \in \mathbb{R}/\mathbb{Z}$, be the parameterization of the main cardioid $\partial\Delta$ by the rotation number θ . Consider the molecule map $\mathbf{R}_{\text{prm}} : \mathcal{M} \dashrightarrow \mathcal{M}$ (see [DLS, Appendix C]); its action on $\partial\Delta$ is given by

$$(1.1) \quad \theta \longrightarrow \frac{\theta}{1-\theta} \quad \text{if } 0 \leq \theta \leq \frac{1}{2}; \quad \theta \longrightarrow \frac{2\theta-1}{\theta} \quad \text{if } \frac{1}{2} \leq \theta \leq 1.$$

Let us fix an \mathbf{R}_{prm} -periodic point $c(\theta) \in \partial\Delta$ with period m . Note that $z^2 + c(\theta)$ is a Siegel polynomial.

Let \mathcal{M}_0 be a small copy of the Mandelbrot set centered at the main molecule such that \mathcal{M}_0 is close to $c(\theta)$. By the Yoccoz inequality, \mathcal{M}_0 is contained in a small neighborhood of $c(\theta)$. Define inductively \mathcal{M}_{n-1} to be the unique preimage of \mathcal{M}_n under $\mathbf{R}_{\text{prm}}^m$ so that \mathcal{M}_{n-1} is also in a small neighborhood of $c(\theta)$; i.e. the

\mathcal{M}_n shrink to $c(\theta)$. For $n \leq 0$ denote by $\mathbf{R}_n: \mathcal{M}_n \rightarrow \mathcal{M}$ the Douady-Hubbard straightening map.

A map $g: \mathbb{C} \dashrightarrow \mathbb{C}$ is $1 + \varepsilon$ -conformal at $z_0 \in \text{Dom } g$ if g has the derivative $g'(z_0)$ at z_0 such that the corresponding linear map approximates g with an error term:

$$g(z_0 + z) = g(z_0) + g'(z_0)z + O(|z|^{1+\varepsilon}), \quad z + z_0 \in \text{Dom } g.$$

Theorem 1.1. *There is a small copy \mathcal{M}_0 of the Mandelbrot set close to $c(\theta)$ and centered at the main molecule such that the preimages \mathcal{M}_n of \mathcal{M}_0 as above scale linearly at $c(\theta)$: the map*

$$(1.2) \quad \mathbf{R}_{\text{prm}}^m: \{c(\theta)\} \cup \bigcup_{n < 0} \mathcal{M}_n \rightarrow \{c(\theta)\} \cup \bigcup_{n \leq 0} \mathcal{M}_n$$

is $1 + \varepsilon$ -conformal at $c(\theta)$. Moreover, for every $n \leq 0$ we have

- **rigidity:** the set $\bigcap_{i \geq 0} \text{Dom}(\mathbf{R}_n^i) = \{c_n\}$ is a singleton;
- **JLC:** the Julia set of $z^2 + c_n$ is locally connected;
- **positive measure:** the Julia set of $z^2 + c_n$ has positive measure.

In fact, we construct a horseshoe of parameters where local connectivity holds. We also show that $p_n(z) := z^2 + c_n$ has a forward invariant *valuable flower* X_n containing the postcritical set of p_n such that X_n is in a small neighborhood of the closed Siegel disk of $z^2 + c(\theta)$. This is a partial case of the conjecture on the upper semi-continuity of the mother hedgehog, see [DLS, Appendix C].

There are examples of infinitely renormalizable polynomials with non-locally connected Julia sets [Mi]. The examples are based on near-parabolic effects when small Julia sets are forced not to shrink. This may actually be the only mechanism for non-locally connectivity of the Julia sets in the infinitely renormalizable case. See [H, Mi, J, McM1, L2, KL1, KL2] for classes of locally connected Julia sets. Our results demonstrate that the Julia sets behave nicely near Siegel parameters of bounded type. There is also substantial progress in understanding near-parabolic Julia sets in the Inou-Shishikura class, see [CS, SY, Ch].

It was shown in [Y] that the Julia set of an infinitely renormalizable polynomial p has measure 0 if the renormalizations of p stay “sufficiently far away” from the main molecule. Our results indicate that if the renormalizations of p are close to the Siegel maps, then the Julia set of p inherits a positive mass from Siegel filled-in Julia sets. Thus, one may expect a certain monotonicity of the measure depending on how far the renormalizations of p are away from the main hyperbolic component. This is also consistent with the Hubbard conjecture stating that the measure of the filled-in Julia set of every parameter in the main hyperbolic component is at least some universal $\varepsilon > 0$. It is recently shown in [DS] that the classical Feigenbaum polynomial has Hausdorff dimension less than 2, and consequently it has measure 0.

1.3. Outline of the paper. Section 2 reviews combinatorial aspects of the pacman and maximal prepacman renormalizations. It starts by discussing the model case of disk rotations $\mathbb{L}_\theta := [z \mapsto \mathbf{e}(\theta)z]: \mathbb{D} \curvearrowright$ and the associated commuting pairs

$$(T_{\mathbf{v}-}, T_{\mathbf{w}}) = (T_{-\mathbf{v}}, T_{\mathbf{w}}) := [z \mapsto z - \mathbf{v}, \quad z \mapsto z + \mathbf{w}]: \overline{\mathbb{H}}_- \curvearrowright,$$

where \mathbb{L}_θ is the quotient of $(T_{\mathbf{v}-}, T_{\mathbf{w}})$ under $z \mapsto z + \mathbf{v} + \mathbf{w}$. We define the *sector renormalization* acting on rotations of \mathbb{D} and the renormalization on commuting

pairs, see §2.1.1; the latter is a rescaled iteration of a given pair. Lemma 2.2 summarizes basic properties of arising antirenormalization matrices.

In §2.3, we extend the discussion to the cases of self-homeomorphisms and partial self-homeomorphisms of the disk $\bar{\mathbb{D}}$. Propositions 2.9 and 2.10 relate the dynamical planes of (partial) self-homeomorphisms of \mathbb{D} to the dynamical planes of associated commuting pairs.

In **Section 3**, we collect the background information on the pacman renormalization from [DLS]. A *pacman* is an almost $2 : 1$ map with a covering structure illustrated on Figure 1, while a *prepacman* (Figure 11) is a commuting pair obtained by cutting a pacman along its “critical arc γ_1 ”. For every rotational number of periodic type $\theta = \mathbf{R}_{\text{prm}}^m(\theta)$, there is an associated analytic pacman renormalization operator $\mathcal{R} : \mathcal{B} \dashrightarrow \mathcal{B}$ in a suitable Banach space \mathcal{B} with a hyperbolic fixed point $f_\star = \mathcal{R}(f_\star)$, where f_\star is a pacman that has a Siegel disk with rotation number θ . We denote by \mathcal{W}^s and \mathcal{W}^u the stable and unstable manifolds of f_\star respectively.

Maximal prepacmen. A key fact is that every $f \in \mathcal{W}^u$ has a *maximal prepacman* (see (3.6)): a prepacman of f with an embedding into \mathbb{C} such that both prepacman maps admit maximal extensions

$$\mathbf{F} = (\mathbf{f}_- : \mathbf{X}_- \rightarrow \mathbb{C}, \quad \mathbf{f}_+ : \mathbf{X}_+ \rightarrow \mathbb{C}),$$

as σ -proper coverings of \mathbb{C} , i.e. $\mathbf{f}_\pm \mid \mathbf{X}_\pm$ is an increasing union of proper maps. The construction of a maximal prepacman goes as follows. Every $f \in \mathcal{W}^u$ can be antirenormalized infinitely many times

$$f = f_0, \quad f_{-1}, \quad f_{-2}, \dots, \quad \mathcal{R}f_{n-1} = f_n.$$

As Figure 13 illustrates, we cut $f_0 : U_0 \rightarrow V_0$ along its critical arc γ_1 and then embed the sector $S_0 := V_0 \setminus \gamma_0$ into the dynamical plane of $f_{-1} : U_{-1} \rightarrow V_{-1}$. Then we cut $f_{-1} : U_{-1} \rightarrow V_{-1}$ along γ_1 and embed $S_{-1} := V_{-1} \setminus \gamma_1$ into the dynamical plane of f_{-2} . Continuing (and linearizing) this process, we construct $\mathbf{F} = \mathbf{F}_0$ as a “direct union” of $f_n : U_n \rightarrow V_n$, $n \leq 0$, cut along γ_1 .

In the course of the construction of \mathbf{F} , the α -fixed point of f “goes to infinity”. To better relate the dynamical planes of \mathbf{F} and f , we formally add the fixed point α to the dynamical plane of \mathbf{F} and introduce an appropriate “wall topology” for $\mathbb{C} \cup \{\alpha\}$ so that small neighborhoods of $\alpha(\mathbf{F})$ are “full lifts (lifts followed by spreading around)” of small neighborhoods of $\alpha(f)$, see §4.7. We also introduce a “renormalization triangulation” for \mathbf{F} to control its dynamics near α (see §4.3) and to project dynamical objects from the \mathbf{F} -plane to the f -plane, see Theorem 4.7 (which is an application of Proposition 2.10).

Global unstable manifold. Let $\mathcal{W}_{\text{loc}}^u = \{\mathbf{F} : f \in \mathcal{W}^u\} \simeq \mathcal{W}^u$ be the space of maximal prepacmen. The operator \mathcal{R} acts on $\mathcal{W}_{\text{loc}}^u$ as the multiplication by λ_\star , where $\lambda_\star > 1$. In the dynamical planes, $\mathcal{R}(\mathbf{F})$ is a rescaled iteration of \mathbf{F} (see (3.11)). Therefore, we can globalize $\mathcal{W}_{\text{loc}}^u \subset \mathcal{W}^u \simeq \mathbb{C}$. We can also view \mathcal{W}^u as the space of rescaled limits of quadratic polynomials, see §4.1. Therefore, a zoomed picture of the Mandelbrot set near $c(\theta)$ gives a good approximation to \mathcal{W}^u , see Figure 16.

We follow up with a discussion of basic dynamical properties of maximal prepacmen in **Section 4**.

Cascade. Consider a maximal prepacman $\mathbf{F} \in \mathcal{W}^u$, and set $\mathbf{F}_n := \mathcal{R}^n(\mathbf{F})$. For $n \leq 0$ we denote by $\mathbf{F}_n^\# = (\mathbf{f}_{n,\pm}^\#)$ the rescaled version of \mathbf{F}_n so that $\mathbf{f}_\pm = \mathbf{f}_{0,\pm}$ are

iterates of $\mathbf{f}_{n,\pm}^\#$. The cascade

$$\mathbf{F}^{\geq 0} := \langle \text{id}, \mathbf{f}_{n,\pm}^\# : n \leq 0 \rangle$$

is the semigroup generated by all $\mathbf{F}_n^\#$; see §4.2 for an equivalent definition. It turns out that every map in $\mathbf{F}^{\geq 0}$ can be written as \mathbf{F}^P with the usual power law $\mathbf{F}^P \circ \mathbf{F}^Q = \mathbf{F}^{P+Q}$, where P, Q belong to a dense semigroup \mathbb{T} of $\mathbb{R}_{\geq 0}$.

Fatou, Julia, and escaping sets. The *Fatou set* $\mathfrak{F}(\mathbf{F})$ of \mathbf{F} is the set where the family $\{\mathbf{F}^P\}$ is normal. The *Julia set* $\mathfrak{J}(\mathbf{F})$ is the complement of the Fatou set. The cascade $\mathbf{F}^{\geq 0}$ has a single critical orbit: the set of critical values of \mathbf{F}^P is exactly $\bigcup_{Q < P} \mathbf{F}^Q\{0\}$. The postcritical set of \mathbf{F}^P is $\mathfrak{P}(\mathbf{F}) = \bigcup_{Q \in \mathbb{T}} \mathbf{F}^Q\{0\}$. The dynamics of $\mathbf{F}^{\geq 0}$ is proper discontinuous in an appropriate sense; in particular, for every $P \in \mathbb{T}$ and every $x \in \mathbb{C}$ the set $\bigcup_{Q < P} \mathbf{F}^Q\{x\}$ is discrete, see Lemma 4.4.

Given $P \in \mathbb{T}_{>0}$, the *P-th escaping set* is

$$\mathbf{Esc}_P(\mathbf{F}) := \mathbb{C} \setminus \text{Dom}(\mathbf{F}^P).$$

The *escaping set* is $\mathbf{Esc}(\mathbf{F}) := \bigcup_{P > 0} \mathbf{Esc}_P(\mathbf{F})$. We have $\overline{\mathbf{Esc}(\mathbf{F})} = \mathfrak{J}(\mathbf{F})$, see Corollary 6.9.

In **Section 5**, we study the dynamical plane of the renormalization fixed point \mathbf{F}_* . Since $\mathcal{R}\mathbf{F}_* = \mathbf{F}_*$, the dynamical self-similarity $A_*: z \mapsto \mu_* z$ conjugates \mathbf{F}_*^P to $\mathbf{F}_*^{P\mathfrak{t}}$, where $P \in \mathbb{T}$ and $\mathfrak{t} > 1$, see §4.2. This allows us to give an explicit description of the dynamical plane of \mathbf{F}_* . It has an invariant unbounded Siegel disk \mathbf{Z}_* – the rescaled limit of Z_* , see Figure 16. Every Fatou component \mathbf{Z}_i of \mathbf{F}_* is either \mathbf{Z}_* or its preimage under a certain iterate \mathbf{F}_*^T with $T \in \mathbb{T}_{>0}$. We prove in §5.5 that each \mathbf{Z}_i is a bounded subset of \mathbb{C} . Moreover, if T is minimal, then $\overline{\mathbf{Z}_i} \cap \mathbf{Esc}_T(\mathbf{F}_*) = \{\alpha_i\}$ is a singleton, and $\mathbf{F}_*^T: \mathbf{Z}_i \rightarrow \mathbf{Z}_*$ extends continuously to $\mathbf{F}_*^T: \overline{\mathbf{Z}_i} \rightarrow \overline{\mathbf{Z}_*} \cup \{\alpha\}$ so that $\mathbf{F}_*^T(\alpha_i) = \alpha$. We say that α_i is an *alpha-point of generation* $|\alpha_i| := T$.

Alpha-points are cut points of $\mathbf{Esc}(\mathbf{F}_*)$: each set $\mathbf{Esc}(\mathbf{F}_*) \setminus \{\alpha_i\}$ has two bounded components and one unbounded, see Figure 25. Moreover, there is a unique curve in $\mathbf{Esc}(\mathbf{F}_*)$ connecting any two alpha-points. We write $\alpha_i \succ \alpha_j$ if α_i is in one of the bounded components of $\mathbf{Esc}(\mathbf{F}_*) \setminus \{\alpha_j\}$. It follows that $|\alpha_i| > |\alpha_j|$ and, moreover, there is a unique simple arc $[\alpha_i, \alpha_j] \subset \mathbf{Esc}(\mathbf{F}_*)$ connecting α_i and α_j . We say that $[\alpha_i, \alpha_j]$ is a *ray segment*. An *external ray* is a maximal concatenation of ray segments, see §5.9. We show that external rays have a tree structure: every two external rays eventually meet.

In **Section 6**, applying the Fatou and Riesz Theorems, we show that the escaping set $\mathbf{Esc}_P(\mathbf{F})$ is the set of accumulation points of $\mathbf{F}^{-P}(x)$ for all $x \in \mathbb{C}$. Then we deduce that $\mathbf{Esc}(\mathbf{F})$ moves locally holomorphically unless it hits an iterated preimage of 0. Therefore, \mathbf{F} has the same external structure as \mathbf{F}_* with appropriate adjustments when $0 \in \mathbf{Esc}(\mathbf{F})$.

In **Section 7**, we show that \mathcal{W}^u contains certain ternary satellite small copies of the Mandelbrot set. The argument is illustrated on Figure 40 and goes as follows. The renormalization Siegel fixed point \mathbf{F}_* belongs to the boundary of the main hyperbolic component $\Delta \subset \mathcal{W}^u$. Let $\mathbf{F}_\tau \in \partial\Delta$ be a parabolic prepacman close to \mathbf{F}_* . Then there is a satellite hyperbolic component $\Delta_\tau \subset \mathcal{W}^u$ attached at \mathbf{F}_τ . In a small neighborhood of \mathbf{F}_τ , there is another parabolic prepacman $\mathbf{F}_{\tau,s}$; let $\Delta_{\tau,s} \subset \mathcal{W}^u$ be the secondary satellite hyperbolic component attached at $\mathbf{F}_{\tau,s}$.

For every $\mathbf{G} \in \partial\Delta_{\tau,s} \setminus \{\mathbf{F}_{\tau,s}\}$, appropriate periodic rays in $\mathbf{Esc}(\mathbf{G})$ land together and form a quadratic-like domain (after a thickening) for the partial small copy $\mathcal{M}(\Delta_{\tau,s})$ centered at $\Delta_{\tau,s}$. We **do not know** whether $\mathcal{M}(\Delta_{\tau,s})$ is bounded or even complete – this is related to the realization of parameter rays, see §6.5. However, there is a locally continuous straightening map $\chi: \mathcal{M}(\Delta_{\tau,s}) \rightarrow \mathcal{M}$; using the Yoccoz inequality for \mathcal{M} and then χ^{-1} , we can find a parabolic prepacman $\mathbf{F}_{\tau,s,t} \in \partial\Delta_{\tau,s}$ in a small neighborhood of $\mathbf{F}_{\tau,s}$ together with a ternary small copy of the Mandelbrot set $\mathcal{M}_0 = \mathcal{M}_{\tau,s,t} \subset \mathcal{W}^u$ attached to $\mathbf{F}_{\tau,s,t}$.

We set $\mathcal{M}_n := \mathcal{R}^n(\mathcal{M}_0) \subset \mathcal{W}^u$, $n \in \mathbb{Z}$, to be the renormalization orbit of \mathcal{M}_0 .

In **Section 8**, we prove the Valuable Flower Theorem: for $n \ll 0$, if $\mathbf{G} \in \mathcal{M}_n$, then the associated pacman $g \in \mathcal{W}^u$ has a *valuable flower* $X(g)$ around $\alpha(g)$ in a small neighborhood of $\overline{Z}(f_*)$ defined as the “combinatorial connected hull” of the cycle of secondary small filled-in Julia sets, see §8.2 and Figure 42. In particular, $X(g)$ contains the postcritical set of g . We construct first the valuable flower $\mathbf{X}(\mathbf{G})$ in the dynamical plane of \mathbf{G} (where external rays of \mathbf{G} help to control the location of $\mathbf{X}(\mathbf{G})$) and then project to the g -plane using Theorem 4.7. We denote by $\mathcal{M}_n \subset \mathcal{W}^u$ the set of pacmen g with $\mathbf{G} \in \mathcal{M}_n$.

The valuable flower $X(g)$ labels the hybrid class of g : there is a unique quadratic polynomial $p \in \mathcal{M}$ such that p has a valuable flower $X(p)$ and g and p are hybrid conjugate in neighborhoods of their valuable flowers $X(g)$ and $X(p)$. It provides us with the straightening map from \mathcal{M}_n to the associated small copy $\mathcal{M}_n \subset \mathcal{M}$ containing all $p = p(g)$ with $g \in \mathcal{M}_n$.

The proofs of the main results are collected in **Section 9**. We first construct a *stable lamination* in the space of pacmen as follows. For $\mathbf{n} \ll 0$, there is a local complex codimension-one lamination $\mathcal{F}_{\mathbf{n}}$ in a small neighborhood of $\mathcal{M}_{\mathbf{n}}$ characterized by the property that pacmen in the same leaf are hybrid conjugate in neighborhoods of their valuable flowers, see §9.1. For $m \leq \mathbf{n}$ we define \mathcal{F}_m to be the pullback of $\mathcal{F}_{\mathbf{n}}$ under $\mathcal{R}^{\mathbf{n}-m}$. By hyperbolicity of \mathcal{R} ,

$$\mathcal{F} := \bigcup_{m \leq \mathbf{n}} \mathcal{F}_m \cup \{\mathcal{W}^s\}$$

forms a codimension-one lamination.

Proof of the main results (rough outline). Theorem 1.1 essentially follows from the hyperbolicity of \mathcal{R} combined with the holonomy along \mathcal{F} . The stable manifold \mathcal{W}^s intersects the slice of quadratic polynomials \mathcal{Q} at $c(\theta)$. For $n \ll 0$, the intersection of \mathcal{F}_n with the (renormalized) slice \mathcal{Q} is the ternary copy \mathcal{M}_n of the Mandelbrot set. The map $\mathbf{R} := \mathbf{R}_{\text{prm}}^m$ from (1.2) factorizes as $\mathcal{R} \mid \mathcal{Q}$ postcomposed with the holonomy along \mathcal{F} bringing $\mathcal{R}(\mathcal{Q}) \cap \mathcal{F}$ back to \mathcal{Q} . Since the holonomy is asymptotically conformal, the hyperbolicity of \mathcal{R} implies the scaling theorem.

For $k < n$, we have $\mathbf{R}_k = \mathbf{R}_n \circ \mathbf{R}^{n-k}$. Since

$$\mathbf{R}^{n-k}(c(\theta) + z) \approx c(\theta) + \lambda_*^{n-k} z, \quad \lambda_* > 1$$

is expanding, the composition $\mathbf{R}_n \circ \mathbf{R}^{n-k} = \mathbf{R}_k$ is expanding for fixed $n < 0$ and a sufficiently big $n - k \gg 0$. Therefore, the non-escaping set of $\mathbf{R}_n: \mathcal{M}_n \rightarrow \mathcal{M}$ consists of a single parameter c_n . This implies the rigidity part of Theorem 1.1.

Let $g_n: U_n \rightarrow V_n$ be the quadratic-like renormalization fixed point associated with $\mathbf{R}_n: (\mathcal{M}_n, c_n) \rightarrow (\mathcal{M}, c_n)$, where g_n is hybrid conjugate to $p_n(z) = z^2 + c_n$. Consequently, g_n has a quadratic-like restriction $g_n^{m(n)}: U'_n \rightarrow V'_n$ affinely conjugate to $g_n \mid U_n$. Such a structure already implies the JLC. In fact, a priori bounds for

the g_n are controlled by a quadratic-like domain of the copy $\mathcal{M}_0 \subset \mathcal{W}^u$ discussed above; i.e. the a priori bounds for g_n are uniform over n .

As $n \rightarrow -\infty$, the map $g_n: U_n \rightarrow V_n$ tends to a Siegel quadratic-like map $g_\star: U_\star \rightarrow V_\star$ so that the valuable flower $X(g_n)$ approximates the Siegel disk $\overline{Z}(g_\star)$. For such an approximation, the Koebe-type estimates of [AL2, §§6.6–6.8] imply that for $n \ll 0$ the probability of the g_n -orbit of $z \in \overline{Z}(g_\star)$ to enter U'_n is much higher than the probability of escaping U_n . By [AL1] the Julia set of g_n (and hence of p_n) has positive area. Since our notations are different, we will recap the argument in §9.3 – see its beginning for a short outline and comparison with [AL2].

1.4. Remarks about Transcendental and Neutral Dynamics. It has been long observed that the dynamics near indifferent periodic points is strikingly similar to the transcendental dynamics. For instance, the Julia sets at Cremer points look similar to “Cantor bouquets” – the Julia sets of certain exponential maps [DG]. This was a guiding idea for Shishikura’s seminal work [S]. The similarity between Neutral and Transcendental dynamics was broadly advertised in numerous talks by Shishikura, Epstein, Rempe, and others. It has become clear over time that the Cremer and Siegel phenomena are not as mysterious as they once were viewed. However, only recently they were rigorously explained in the Inou-Shishikura class [SY, Ch].

A substantial difficulty in the neutral renormalization theory is that arising maps (such as pacmen, see Figure 1) are **not** genuine branched covering. It appears that some arising issues can be resolved by considering transcendental extensions on the unstable manifolds. In the 1990s, McMullen observed that renormalization periodic points (in both, quadratic-like and Siegel cases) admit maximal extensions as σ -proper branched coverings of the complex plane.¹ In [DLS] we extended this result to every map on the unstable manifold \mathcal{W}^u of a Siegel renormalization periodic point. This was a key ingredient in our proof that $\dim \mathcal{W}^u = 1$. Roughly: since maximal prepacmen have a single critical orbit, they naturally form a one-dimensional space.

In the current paper, we construct external rays and develop the puzzle theory for the limiting transcendental family \mathcal{W}^u . We also introduce a machinery to transfer results from \mathcal{W}^u to the dynamical planes of rational maps. We believe that with further advancements in the Transcendental Dynamics (the theory of parameter rays, see §6.5) and the Neutral Renormalization Theory (the full hyperbolicity over all combinatorics), the understanding of the near-Neutral Dynamics could be brought to an essentially complete form. For illustration, let us discuss below two central ideas from Sections 8 and 9.

Valuable flowers. An essential ingredient in the constructions of positive area Julia sets in [BC, AL2] is the Buff-Cheritat lemma asserting that certain perturbations of a Siegel map f have the postcritical sets in a small neighborhood of the Siegel disk $Z(f)$. The Buff-Cheritat lemma allows Koebe-type area estimates (see §9.3) and is an application of the Almost Parabolic Renormalization Theory [IS].

A valuable flower is roughly the “combinatorial connected hull” of the postcritical set and is a near-neutral analogy of the filled Julia set of a polynomial. Just like filled Julia sets of polynomials depend upper semicontinuously on the parameter, we conjectured in [DLS, Appendix C.4] that Siegel disks/hedgehogs/valuable flowers

¹The domain of analyticity for the Feigenbaum renormalization fixed point was first studied by H. Epstein [E1, E2].

depend upper semicontinuously on the parameter in (at least) the main molecule of the Mandelbrot set. In Section 8, we designed a soft argument for the upper-semicontinuity: once a valuable flower $\mathbf{X}(\mathbf{G})$ is recognized in the dynamical plane of a maximal prepacman \mathbf{G} , the flowers $\mathbf{X}(\mathbf{G}_n)$, $\mathbf{G}_0 = \mathbf{G}$, $n \leq 0$, converge to the Siegel disk $\overline{\mathbf{Z}}(\mathbf{F}_*)$ under the antirenormalization. The argument is based on the convergence in $\widehat{\mathbb{C}} \setminus \mathbf{Z}_*$ of wakes of \mathbf{G}_n to the wakes of \mathbf{F}_* , see Lemma 8.6.

We emphasize that the positive area property is almost automatic, once a valuable flower is constructed and sufficiently many antirenormalizations are taken, see Remark 9.7.

Hybrid lamination. It was shown in [L3] that hybrid classes foliate the connectedness locus of the complex space of all quadratic-like maps. The argument can not be adopted to the space of pacmen – they are not branched coverings.

To construct hybrid lamination in the space of pacmen, we employ the renormalization. We first recognize maps on the unstable manifold labeled by their valuable flowers. This leads to a local lamination in a small neighborhood of recognized parameters. Pulling back the local lamination using the renormalization, we obtain a fairly dense hybrid lamination in a neighborhood of the stable manifold.

If the full hyperbolic renormalization horseshoe is constructed for neutral renormalization, then the renormalization will be much more efficient in creating hybrid lamination – it can be pulled back along various branches. Combined with Conjecture 6.14, this may lead a compete theory, see Remark 9.1.

Acknowledgments. The first author was partially supported by Simons Foundation grant of the IMS, the ERC grant “HOLOGRAM”, and the NSF grant DMS 2055532. The second author has been partly supported by the NSF, the Hagler and Clay Fellowships, the Institute for Theoretical Studies at ETH (Zurich), and MSRI (Berkeley).

We also thank Artur Avila for stimulating the discussion of the area problem.

Results of this paper were first announced at the conference in memory of Yoccoz, May 2017, Collège de France (Paris).

A number of our pictures are made with W. Jung’s program *Mandel*.

We thank the referee for carefully reading the paper and making many useful comments.

2. SECTOR RENORMALIZATION

In this section we refine the discussion of the sector renormalization from [DLS, Appendices A and B].

2.1. Sector renormalization of rotations. Consider the rotation of the unit disk

$$(2.1) \quad \mathbb{L}_\theta: \overline{\mathbb{D}} \rightarrow \overline{\mathbb{D}}, \quad z \rightarrow \mathbf{e}(\theta)z$$

by an angle $\theta \in \mathbb{R}/\mathbb{Z}$. Choose a closed internal ray \mathbb{I} of $\overline{\mathbb{D}}$, and let $\mathbb{Y} \subset \overline{\mathbb{D}}$ be the smallest closed sector between \mathbb{I} and $\mathbb{L}_\theta(\mathbb{I})$, see the left side of Figure 2. Consider

$$\mathbb{X}_- := \mathbb{L}_\theta^{-1}(\mathbb{Y}) \quad \text{and} \quad \mathbb{X}_+ := \overline{\mathbb{D} \setminus (\mathbb{Y} \cup \mathbb{X}_-)}.$$

Then

$$(2.2) \quad (\mathbb{L}_\theta \mid \mathbb{X}_+, \quad \mathbb{L}_\theta^2 \mid \mathbb{X}_-)$$

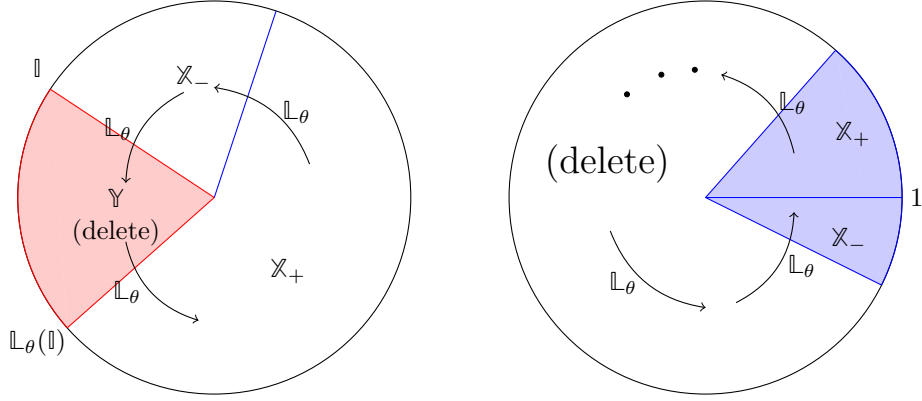

FIGURE 2. Left: the prime renormalization deletes the smallest sector \mathbb{Y} between 1 and $\mathbb{L}_\theta(1)$ and projects $(\mathbb{L}_\theta^2 | \mathbb{X}_-, \mathbb{L}_\theta | \mathbb{Y}_+)$ to a new rotation. Right: more generally, a sector renormalization realizes the first return map to a sector $\mathbb{X}_- \cup \mathbb{X}_+$

is the first return of points in $\mathbb{X}_- \cup \mathbb{X}_+$ back to $\mathbb{X}_- \cup \mathbb{X}_+$. Let $\omega \in [0, 1/2]$ be the angle of \mathbb{Y} at the vertex 0 . Assuming $1 \notin \mathbb{Y}$, the map $z \rightarrow z^{1/(1-\omega)}$ projects (2.2) to a new rotation $\mathbb{L}_{R_{\text{prm}}(\theta)}: \overline{\mathbb{D}} \rightarrow \overline{\mathbb{D}}$, called the *prime renormalization* of \mathbb{L}_θ . Direct calculations (see [DLS, Lemma A.1]) show that

$$(2.3) \quad R_{\text{prm}}(\theta) = \begin{cases} \frac{\theta}{1-\theta} & \text{if } 0 \leq \theta \leq \frac{1}{2}, \\ \frac{2\theta-1}{\theta} & \text{if } \frac{1}{2} \leq \theta \leq 1. \end{cases}$$

More generally, a *sector renormalization* \mathcal{R} of \mathbb{L}_θ is (see Figure 2)

- a *renormalization* sector \mathbb{X} presented as a union of two subsectors $\mathbb{X}_- \cup \mathbb{X}_+$ normalized so that $1 \in \mathbb{X}_- \cap \mathbb{X}_+$;
- a pair of iterates, called a sector *pre-renormalization*,

$$(2.4) \quad (\mathbb{L}_\theta^{\mathbf{a}} | \mathbb{X}_-, \quad \mathbb{L}_\theta^{\mathbf{b}} | \mathbb{X}_+)$$

realizing the first return of points in $\mathbb{X}_- \cup \mathbb{X}_+$ back to \mathbb{X} ; and

- the gluing map

$$\psi: \mathbb{X}_- \cup \mathbb{X}_+ \rightarrow \overline{\mathbb{D}}, \quad z \rightarrow z^{1/\omega},$$

projecting (2.4) to a new rotation \mathbb{L}_μ , where ω is the angle of \mathbb{X} at 0 .

A sector renormalization is an iteration of the prime renormalization (see [DLS, Lemma A.2]); in particular, $\mu = R_{\text{prm}}^m(\theta)$ for some $m \geq 1$.

2.1.1. *Renormalization of pairs of translations.* Let us now lift these renormalizations of rotations to the universal cover of $\overline{\mathbb{D}}^* := \overline{\mathbb{D}} \setminus \{0\}$. Write

$$\mathbb{H}_- := \{z \mid \text{Im}(z) < 0\}.$$

Writing $\mathbf{v}^- = -\mathbf{v}$, the translations

$$T_{\mathbf{v}^-} = T_{-\mathbf{v}} := T_{-\theta}: z \mapsto z - \theta, \quad T_{\mathbf{v}} := T_{1-\theta}: z \mapsto z + 1 - \theta$$

are two lifts of $\mathbb{L}_\theta: \overline{\mathbb{D}}^* \rightarrow \overline{\mathbb{D}}^*$ under

$$(2.5) \quad \mathbf{e}_-: z \mapsto e^{-2\pi iz}: \overline{\mathbb{H}}_- \rightarrow \overline{\mathbb{D}}^*.$$

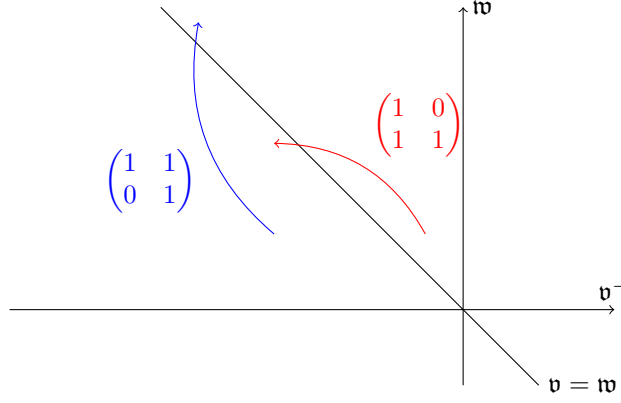

FIGURE 3. The map R_{prm} is 2-to-1 on $\mathbb{R}_{\leq 0} \times \mathbb{R}_{\geq 0}$; it maps two $1/8$ -subsectors to $\mathbb{R}_{\leq 0} \times \mathbb{R}_{\geq 0}$.

Since $\chi := T_{\mathbf{w}} \circ T_{\mathbf{v}^-}^{-1}$ is a deck transformation of (2.5), we have $\mathbb{L}_\theta \simeq T_{-\mathbf{v}}/\langle \chi \rangle$ as a map on $\overline{\mathbb{D}}^*$.

For a non-zero vector $\begin{pmatrix} \mathbf{v}^- \\ \mathbf{w} \end{pmatrix} = \begin{pmatrix} -\mathbf{v} \\ \mathbf{w} \end{pmatrix}$ in $\mathbb{R}_{\leq 0} \times \mathbb{R}_{\geq 0}$ write, (see Figure 3)

$$(2.6) \quad \begin{pmatrix} -\mathbf{v}_1 \\ \mathbf{w}_1 \end{pmatrix} = \begin{pmatrix} \mathbf{v}_1^- \\ \mathbf{w}_1 \end{pmatrix} = R_{\text{prm}} \begin{pmatrix} \mathbf{v}^- \\ \mathbf{w} \end{pmatrix} := \begin{cases} \begin{pmatrix} \mathbf{v}^- + \mathbf{w} \\ \mathbf{w} \end{pmatrix} & \text{if } \mathbf{v} \geq \mathbf{w}, \\ \begin{pmatrix} \mathbf{v}^- \\ \mathbf{w} + \mathbf{v}^- \end{pmatrix} & \text{if } \mathbf{w} > \mathbf{v}. \end{cases}$$

and observe that (2.3) is the *projectivization* of (2.6) via

$$(2.7) \quad \begin{pmatrix} -\mathbf{v} \\ \mathbf{w} \end{pmatrix} \rightarrow \frac{\mathbf{v}}{\mathbf{v} + \mathbf{w}} =: \theta \in \mathbb{R}/\mathbb{Z}.$$

The *prime pre-normalization* of the commuting pair $T_{\mathbf{v}^-}$, $T_{\mathbf{w}}$ with $\mathbf{v}^-, \mathbf{w} \in \mathbb{R}_{\leq 0} \times \mathbb{R}_{\geq 0}$ is the commuting pair

$$(T_{\mathbf{v}_1^-}, T_{\mathbf{w}_1}) = \mathcal{R}_{\text{prm}}(T_{\mathbf{v}^-}, T_{\mathbf{w}});$$

it is obtained (see Figure 4) by replacing $T_{\mathbf{v}^-}$ with $T_{\mathbf{v}^-} \circ T_{\mathbf{w}}$ if $\mathbf{v} \geq \mathbf{w}$, and by replacing $T_{\mathbf{w}}$ with $T_{\mathbf{v}^-} \circ T_{\mathbf{w}}$ otherwise. We denote by $\chi_1 := T_{\mathbf{w}_1} \circ T_{\mathbf{v}_1^-}^{-1}$ the new deck transformation. If $\mathbb{L}_\theta \simeq T_{\mathbf{v}^-}/\langle \chi \rangle$ (i.e. (2.7) holds), then $\mathbb{L}_{R_{\text{prm}}(\theta)} \simeq T_{\mathbf{v}_1^-}/\langle \chi_1 \rangle$ as a map on $\overline{\mathbb{D}}^*$.

Let us now consider an iteration of (2.6). Recall that matrices $\begin{pmatrix} 1 & 1 \\ 0 & 1 \end{pmatrix}$ and $\begin{pmatrix} 1 & 0 \\ 1 & 1 \end{pmatrix}$ generate the modular group $\text{SL}_2(\mathbb{Z})$. We write

$$\text{SL}_2^{(\text{m})}(\mathbb{Z}) := \left\{ I_1 I_2, \dots, I_m \mid I_i \in \left\{ \begin{pmatrix} 1 & 1 \\ 0 & 1 \end{pmatrix}, \begin{pmatrix} 1 & 0 \\ 1 & 1 \end{pmatrix} \right\} \right\},$$

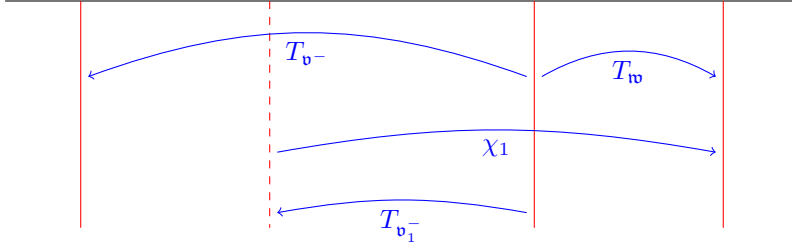

FIGURE 4. The prime pre-renormalization of a pair of translations T_{v^-} , T_w replaces T_{v^-} with $T_{v_1^-} := T_{v^-} \circ T_w$ if $v \geq w$; in this case the new deck transformation is $\chi_1 = T_{v^-} = T_{w_1} \circ T_{v_1^-}$.

and we denote by $SL_2^+(\mathbb{Z}) = \bigcup_{m \geq 0} SL_2^{(m)}(\mathbb{Z})$ the “positive” sub-semigroup of $SL_2(\mathbb{Z})$.

The quadrant $\mathbb{R}_{\leq 0} \times \mathbb{R}_{\geq 0}$ splits into 2^m equal closed sectors so that on each sector S the map R_{prm}^m is equal to

$$(2.8) \quad x \mapsto \mathbb{M}x: \quad S \rightarrow \mathbb{R}_{\leq 0} \times \mathbb{R}_{\geq 0}$$

for a certain $\mathbb{M} \in SL_2^{(m)}(\mathbb{Z})$. (As a consequence, $SL_2^+(\mathbb{Z})$ is a free semigroup.)

Since S is a proper subsector of $\mathbb{R}_{\leq 0} \times \mathbb{R}_{\geq 0}$, the operator (2.8) has an eigenvector $\begin{pmatrix} v^- \\ w \end{pmatrix} \in S$, unique up to scaling. Note that $v = -v^-$, $w > 0$ unless S is a boundary sector containing either $\begin{pmatrix} -1 \\ 0 \end{pmatrix}$ or $\begin{pmatrix} 0 \\ 1 \end{pmatrix}$; in that case $\mathbb{M} \in \left\{ \begin{pmatrix} 1 & n \\ 0 & 1 \end{pmatrix}, \begin{pmatrix} 1 & 0 \\ n & 1 \end{pmatrix} \right\}$.

We assume that S is not a boundary sector. Then all the entries of \mathbb{M} are positive and \mathbb{M} has two eigenvalues $t > 1$ and $1/t < 1$ so that

$$(2.9) \quad \begin{pmatrix} v_1^- \\ w_1 \end{pmatrix} := 1/t \begin{pmatrix} v^- \\ w \end{pmatrix} = \mathbb{M} \begin{pmatrix} v^- \\ w \end{pmatrix}.$$

Writing $\theta = \frac{v}{v+w}$, we see that $\theta = R_{\text{prm}}^m(\theta)$, and we say that \mathbb{M} is the *antirenormalization matrix* associated with $\theta = R_{\text{prm}}^m(\theta)$. It is easy to see that all periodic points of R_{prm}^m arise from the above construction.

Lemma 2.1. *For θ and t as above, we have*

$$(R_{\text{prm}}^m)'(\theta) = t^2.$$

Proof. We can view θ as a fixed point of the Möbius transformation induced by \mathbb{M} ; its derivative $(R_{\text{prm}}^m)'(\theta)$ is equal to t^2 .

Equivalently, direct calculations show that if $\begin{pmatrix} v_1^- \\ w_1 \end{pmatrix} = R_{\text{prm}} \begin{pmatrix} v^- \\ w \end{pmatrix}$, then

$$R'_{\text{prm}} \left(\frac{v}{v+w} \right) = \left(\frac{v+w}{v_1+w_1} \right)^2.$$

If (2.9) holds, then $\frac{v+w}{v_1+w_1} = t$ and the claim follows. \square

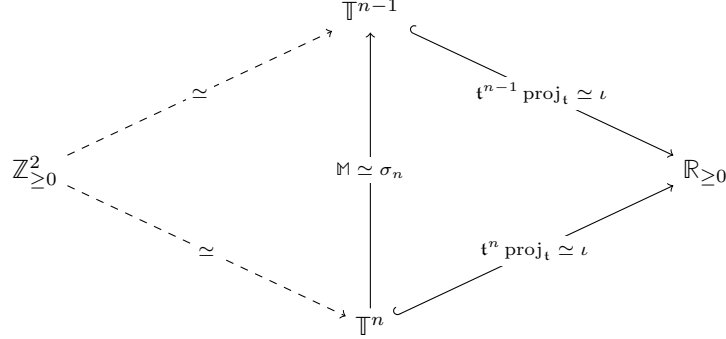

FIGURE 5. Every \mathbb{T}^n is a copy of $\mathbb{Z}_{\geq 0}^2$ and can be consistently embedded into $\mathbb{R}_{\geq 0}$. This induces the embedding ι of $\mathbb{T} := \varinjlim \mathbb{T}^n$ into $\mathbb{R}_{\geq 0}$. Note that dashed arrows do not commute with solid arrows.

2.1.2. *Cascade* $(T^P)_{P \in \mathbb{T}}$. Let us fix $\mathfrak{v}, \mathfrak{w}, \theta, \mathfrak{m}, \mathfrak{t}, \mathbb{M}$ as above so that, in particular, (2.9) holds. Observe that $\mathfrak{t} \notin \mathbb{Q}$, because $\mathfrak{t} > 1$, $\det \mathbb{M} = 1$, but the entries of \mathbb{M} are positive integers. We set $R := R_{\text{prim}}^{\mathfrak{m}}$. For $n \in \mathbb{Z}$, write

$$\mathfrak{v}_n := \mathfrak{t}^{-n} \mathfrak{v}, \quad \mathfrak{w}_n := \mathfrak{t}^{-n} \mathfrak{w};$$

then $(T_{\mathfrak{v}_n^-}, T_{\mathfrak{w}_n})_{n \in \mathbb{Z}}$ is the full pre-renormalization tower:

$$(2.10) \quad \mathcal{R} \left(T_{\mathfrak{v}_n^-}, T_{\mathfrak{w}_n} \right) = \left(T_{\mathfrak{v}_{n+1}^-}, T_{\mathfrak{w}_{n+1}} \right),$$

where $\mathcal{R} = \mathcal{R}_{\text{prim}}^{\mathfrak{m}}$.

For an abelian semigroup

$$\mathbb{T}^n := \{(n, a, b) \mid a, b \in \mathbb{Z}_{\geq 0}\} \simeq \mathbb{Z}_{\geq 0}^2$$

we define the monomorphism

$$\sigma_n : \mathbb{T}^n \hookrightarrow \mathbb{T}^{n-1} : (n, (a, b)) \mapsto (n-1, (a, b)\mathbb{M}).$$

For a *power-triple* $(n, a, b) \in \mathbb{Z} \times \mathbb{Z}_{\geq 0} \times \mathbb{Z}_{\geq 0}$ we write

$$(2.11) \quad T^{(n, a, b)} := T_{\mathfrak{v}_n^-}^a \circ T_{\mathfrak{w}_n}^b = T_{\mathfrak{t}^{-n}(b\mathfrak{w} - a\mathfrak{v})},$$

(Later on the non-invertible maximal prepacman $(\mathfrak{f}_{n,-}^{\#}, \mathfrak{f}_{n,+}^{\#})$ will play the role of $(T_{\mathfrak{v}_n^-}, T_{\mathfrak{w}_n})$.)

Observe that

$$(2.12) \quad T^{(n, a, b)} = T^{\sigma_n(n, a, b)}.$$

Indeed, $T^{(n, a, b)}$ is the translation by

$$(a, b) \begin{pmatrix} \mathfrak{v}_n^- \\ \mathfrak{w}_n \end{pmatrix} = (a, b) \left(\mathbb{M} \begin{pmatrix} \mathfrak{v}_{n-1}^- \\ \mathfrak{w}_{n-1} \end{pmatrix} \right) = ((a, b)\mathbb{M}) \begin{pmatrix} \mathfrak{v}_{n-1}^- \\ \mathfrak{w}_{n-1} \end{pmatrix};$$

thus $T^{(n, a, b)} = T^{(n-1, (a, b)\mathbb{M})}$.

We define the *semi-group of power-triples* as the direct limit

$$(2.13) \quad \mathbb{T} := \varinjlim \mathbb{T}^n = \{(x_i)_{i \leq k} \mid k \in \mathbb{Z}, \sigma_i(x_i) = x_{i-1}\}.$$

We also write $\mathbb{T} = \bigcup_{n \in \mathbb{Z}} \mathbb{T}^n = \{(n, a, b) \in \mathbb{Z} \times \mathbb{Z}_{\geq 0}^2\} / \sim$. By (2.12), \mathbb{T} acts naturally on \mathbb{R} by translations; i.e. $(T^P)_{P \in \mathbb{T}}$ is a *cascade*.

Lemma 2.2. *The action of \mathbb{T} on \mathbb{R} is free: $T^{(n,a,b)} = T^{(m,c,d)}$ if and only if*

$$(2.14) \quad (a, b)\mathbb{M}^n = (c, d)\mathbb{M}^m.$$

Let $e_{\mathfrak{t}} \in \mathbb{R}_{>0}^2, e_{1/\mathfrak{t}} \in \mathbb{R}_{<0} \times \mathbb{R}_{>0}$ be the eigen-covectors (viewed as rows) of the eigenvalues \mathfrak{t} and $1/\mathfrak{t}$ of \mathbb{M} :

$$e_{\mathfrak{t}}\mathbb{M} = \mathfrak{t}e_{\mathfrak{t}}, \quad e_{1/\mathfrak{t}}\mathbb{M} = (1/\mathfrak{t})e_{1/\mathfrak{t}}.$$

Decompose every covector $\omega \in \mathbb{R}_{\geq 0}^2$ as

$$\omega = \text{proj}_{\mathfrak{t}}(\omega)e_{\mathfrak{t}} + \text{proj}_{1/\mathfrak{t}}(\omega)e_{1/\mathfrak{t}}, \quad \text{proj}_{\mathfrak{t}}(\omega) \in \mathbb{R}_{\geq 0}, \quad \text{proj}_{1/\mathfrak{t}}(\omega) \in \mathbb{R}.$$

Then

$$\iota(n, a, b) := \mathfrak{t}^n \text{proj}_{\mathfrak{t}} \begin{pmatrix} a \\ b \end{pmatrix}$$

induces an embedding of \mathbb{T} into $\mathbb{R}_{\geq 0}$ (see also Figure 5) such that

$$\iota(n-1, a, b) = \iota(n, a, b)/\mathfrak{t}.$$

View now \mathbb{T} as a sub-semigroup of $\mathbb{R}_{\geq 0}$. This turns \mathbb{T} into a linearly ordered semi-group with subtraction:

$$\text{if } P \geq T, \quad \text{then } P - T \in \mathbb{T}, \quad P, T \in \mathbb{T} \subset \mathbb{R}_{\geq 0};$$

$P \mapsto \mathfrak{t}P: (n, a, b) \mapsto (n+1, a, b)$ is an automorphism of \mathbb{T} ; and:

$$(2.15) \quad T^P = A_{\mathfrak{t}^n} \circ (T^{\mathfrak{t}^n P}) \circ A_{\mathfrak{t}^{-n}},$$

where $A_{\mathfrak{t}^n}: z \mapsto \mathfrak{t}^n z$ is scaling.

Proof. If the action of \mathbb{T} on \mathbb{R} is not free, then there are $(n, a, b) \neq (n, c, d)$ such that $T^{(n,a,b)} = T^{(n,c,d)}$; this is equivalent to $(a-c)\mathfrak{v}^- + (b-d)\mathfrak{w} = 0$. Since $\mathfrak{t} \notin \mathbb{Q}$, the coordinates \mathfrak{v}^- and \mathfrak{w} are rationally independent. Therefore, $a = c$ and $b = d$.

Clearly, $\iota: \mathbb{T} \rightarrow \mathbb{R}_{\geq 0}$ is a homomorphism such that $\iota(n-1, a, b) = \iota(n, a, b)/\mathfrak{t}$. If ι was not an embedding, then there would be $(a, b) \neq (c, d) \in \mathbb{Z}_{\geq 0}^2$ with $\text{proj}_{\mathfrak{t}}(a, b) = \text{proj}_{\mathfrak{t}}(c, d)$; i.e. $(a-c, b-d)$ is a non-zero integer covector parallel to $e_{1/\mathfrak{t}}$. This is impossible because coordinates of $e_{1/\mathfrak{t}}$ are rationally independent.

If $\iota(n, a, b) > \iota(n, c, d)$, then for sufficiently big $m \gg 0$ the covector

$$\begin{aligned} (a_m, b_m) &:= (a-c, b-d)\mathbb{M}^m \\ &= \mathfrak{t}^m \text{proj}_{\mathfrak{t}}(a-c, b-d)e_{\mathfrak{t}} + \mathfrak{t}^{-m} \text{proj}_{1/\mathfrak{t}}(a-c, b-d)e_{1/\mathfrak{t}} \end{aligned}$$

has positive coordinates because $\mathfrak{t} > 1$ and $\text{proj}_{\mathfrak{t}}(a-c, b-d) = \iota(n, a, b) - \iota(n, c, d) > 0$. Therefore, $(n, a, b) - (n, c, d) \simeq (n-m, a_m, b_m) \in \mathbb{T}$. The remaining claims follow immediately from the definitions. \square

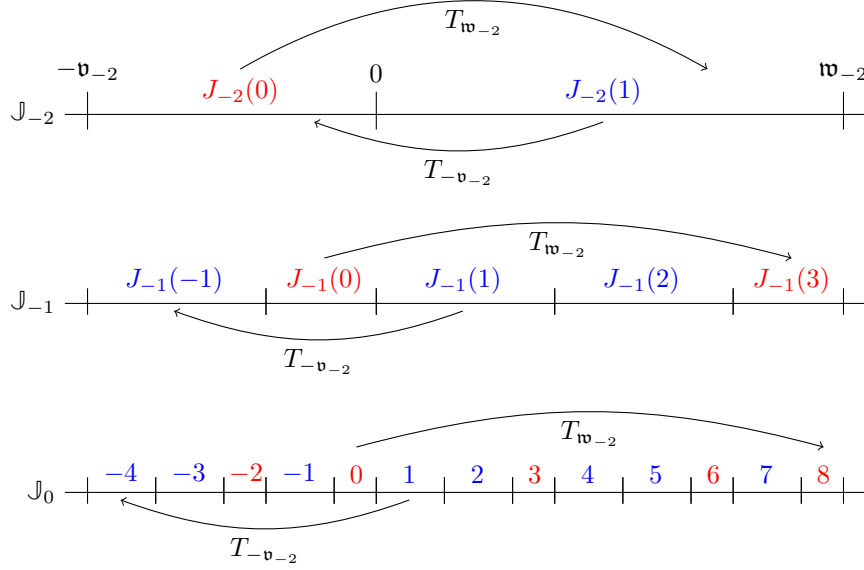

FIGURE 6. Renormalization tilings $\mathbb{J}_0, \mathbb{J}_{-1}, \mathbb{J}_{-2}$ for the golden mean combinatorics: $-\mathbf{v} \approx -0.382$ and $\mathbf{w} \approx 0.618$. The tiling $\mathbb{J}_0 \cap [-\mathbf{v}_2, \mathbf{w}_2]$ is obtained by spreading around $J_0(0)$ and $J_0(1)$ using $T_{-\mathbf{v}_2}$ and $T_{\mathbf{w}_2}$. Similarly, $\mathbb{J}_{-1} \cap [-\mathbf{v}_2, \mathbf{w}_2]$ is obtained by spreading around $J_{-1}(0)$ and $J_{-1}(1)$ using $T_{-\mathbf{v}_2}$ and $T_{\mathbf{w}_2}$. Note that \mathbb{J}_{n-1} is the rescaling of \mathbb{J}_n by ≈ 2.618 .

2.1.3. *Renormalization tilings.* Consider the following closed intervals

$$J_0(0) := [-\mathbf{v}, 0], \quad J_0(1) = [0, \mathbf{w}].$$

Note that $\tilde{J}_0 := J_0(0) \cup J_0(1)$ is a fundamental domain for the deck transformation χ and that

$$T_{-\mathbf{v}} : J_0(1) \rightarrow \tilde{J}_0, \quad T_{\mathbf{w}} : J_0(0) \rightarrow \tilde{J}_0$$

realizes the first return of points in \tilde{J}_0 back to \tilde{J}_0 under the cascade $T^{\geq 0} := (T^P)_{P \in \mathbb{T}}$.

The *renormalization tiling* \mathbb{J}_0 of level 0 (see Figure 6) consists of closed intervals

$$\{T^P(J_0(0)) \mid P < (0, 0, 1)\} \cup \{T^P(J_0(1)) \mid P < (0, 1, 0)\},$$

i.e. \mathbb{J}_0 consists of all the interval in the forward $T^{\geq 0}$ -orbits of $J_0(0), J_0(1)$ before they return back to \tilde{J}_0 . We say that \mathbb{J}_0 is *obtained by spreading* around $J_0(0)$ and $J_0(1)$ and we enumerate intervals in \mathbb{J}_0 by \mathbb{Z} from left-to-right.

Similarly, the *renormalization tiling* \mathbb{J}_n of level n is defined: it is obtained by spreading around the intervals $J_n(0) := [-\mathbf{v}_n, 0]$ and $J_n(1) = [0, \mathbf{w}_n]$. Note that \mathbb{J}_n is the rescaling of \mathbb{J}_0 by \mathbf{t}^{-n} .

Lemma 2.3 (Proper discontinuity). *If $P \in \mathbb{T}_{>0} \subset \mathbb{R}_{>0}$ is small, then $|T^P(0)|$ is large.*

Proof. For $n \ll 0$, consider $\tilde{J}_n := J_n(0) \cup J_n(1) = [-\mathbf{v}_n, \mathbf{w}_n]$. By construction, if $P < \min\{(n, 0, 1), (n, 1, 0)\}$, then $T^P(0) \notin \tilde{J}_n$. \square

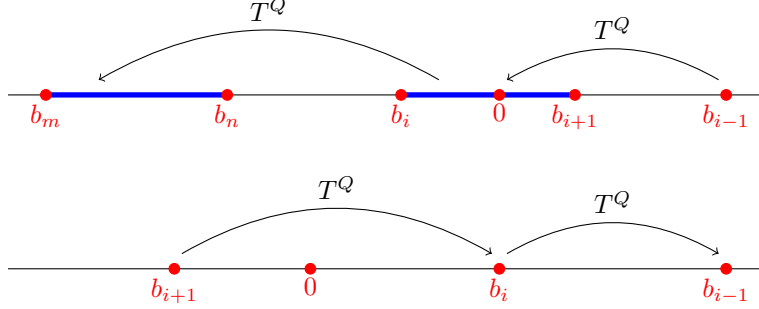

FIGURE 7. Illustration to the proof of Lemma 2.4. Above: the configuration $b_i < 0 < b_{i-1}$, then $b_{i+1} \in [b_i, b_{i-1}]$. Set $Q := P_{i-1}$. Since b_i dominates on $[b_i, b_{i-1})$, we see that b_m is dominant; similarly b_n is dominant. Below: the configuration $0 < b_i < b_{i-1}$, then $b_{i+1} < b_i$. For $Q := P_i - P_{i-1}$ we obtain $T^Q(b_{i+1}) = b_i$ because $T^{-Q}(b_i)$ dominates in $T^{-Q}[0, b_{i-1})$. Note that in both configurations the relative position of 0 and b_{i+1} is irrelevant.

2.2. Combinatorics of close returns. Consider the cascade $(T^P)_{P \in \mathbb{T}}$ from §2.1.2. By Lemma 2.2, we view \mathbb{T} as a sub-semigroup of $\mathbb{R}_{\geq 0}$.

For $P \in \mathbb{T}_{>0}$, let $b_P = \mathbb{T}^{-P}(0)$ be the unique preimage of 0 under T^P . Then P is the *generation* of b_P . We say that b_P is *dominant* if $[0, b_P]$ contains no b_Q with $Q < P$. By definition, if b_P and b_Q are dominant such that $P < Q$, then $b_Q, 0$ are on the same side of b_P .

Since every interval $[a, b] \subset \mathbb{R}$ contains at most finitely many b_P with $P \leq Q$ for every Q (see Lemma 2.3), dominant points can accumulate only at 0 and ∞ . Moreover, if b_P is close to 0, then P is big; while if b_P is close to ∞ , then P is small. Therefore, we can enumerate all dominant points as $(b_{P_n})_{n \in \mathbb{Z}}$ such that $P_n > P_{n-1}$ for all $n \in \mathbb{Z}$. Suppressing indices, we write $b_n = b_{P_n}$.

By (2.15), b_P is dominant if and only if $b_{\mathfrak{t}P} = A_{1/\mathfrak{t}}(b_P)$ is dominant. Since $\{b_n\}$ are enumerated by their escaping time, there is a $k > 0$ such that

$$\mathfrak{t}P_i = P_{i+k}.$$

Let us also note that if b_n, b_m are on the same side of 0, then b_n is closer to 0 than b_m if and only if $P_n > P_m$.

Lemma 2.4. *For every $[b_i, b_{i+1}]$ there is a $Q \in \mathbb{T}_{>0}$ and $[b_n, b_m]$ with $i \geq m > n$ such that T^Q maps $[b_i, b_{i+1}]$ to $[b_n, b_m]$.*

Proof. Suppose first that $0 \in [b_i, b_{i-1}]$, see Figure 7. Then $b_{i+1} \in [b_i, b_{i-1}]$. Set $Q := P_{i-1}$. Observe that $T^Q(b_i)$ is of smallest generation in

$$[T^Q(b_i), 0] = T^Q[b_i, b_{i-1}]$$

among the b_P , while $T^Q(b_{i+1})$ is of smallest generation in

$$[T^Q(b_{i+1}), 0] = T^Q[b_{i+1}, b_{i-1}].$$

Therefore, $T^Q(b_i)$ and $T^Q(b_{i+1})$ are dominant; i.e. $T^Q(b_i) = b_n$ and $T^Q(b_{i+1}) = b_m$ for some $n, m < i - 1$.

Suppose now that $b_i \in [0, b_{i-1}]$ and assume that $0 < b_i < b_{i-1}$; the opposite case is symmetric. Set $Q := P_i - P_{i-1}$. We claim that $T^{-Q}(b_i)$ is dominant and, moreover, $T^Q(b_{i+1}) = b_i$. Indeed, since b_i dominates (i.e. has the smallest generation) in $[0, b_{i-1})$, we obtain that $T^{-Q}(b_i)$ dominates in $T^{-Q}[0, b_{i-1}) = [T^{-Q}(0), b_i) \ni 0$. This implies that $T^{-Q}(b_i)$ is dominant, thus $T^{-Q}(b_i) = b_{i+a}$ for some $a \geq 1$.

Suppose $a > 1$. Since $P_{i+a} > P_{i+1}$, the image $T^Q(b_{i+1})$ has smaller generation than b_i . Since $T^Q(b_{i+1}) \in (b_{i+1}, b_{i-1})$, we obtain that $T^Q(b_{i+1})$ is dominant. This contradicts the enumeration of $(b_i)_{i \in \mathbb{Z}}$: the generation of $T^Q(b_{i+1})$ is between the generations of b_i and b_{i-1} . \square

2.3. Sector renormalization of homeomorphisms. Consider a homeomorphism $f: \overline{\mathbb{D}} \rightarrow \overline{\mathbb{D}}$ with $f(0) = 0$. We denote by θ the rotation angle of $f|_{\mathbb{S}^1}$. If $\theta \notin \mathbb{Q}$, then $f|_{\mathbb{S}^1}$ is semi-conjugate to the rotation $\mathbb{L}_\theta: \mathbb{S}^1 \rightarrow \mathbb{S}^1$, see (2.1). As we will show in this section, sector (anti- and pre-) renormalization can be defined for homeomorphisms of $\overline{\mathbb{D}}$ in the same way as for rotations. We will specify certain conditions ensuring the transfer of curves between different dynamical planes in the renormalization tower of f . The results also hold with necessary adjustments for partial homeomorphisms $f: \overline{\mathbb{D}} \dashrightarrow \overline{\mathbb{D}}$.

2.3.1. Dividing arcs. Let γ_0 be a simple arc connecting 0 to a point in $\partial\overline{\mathbb{D}}$. Then γ_0 is called *dividing* if $\gamma_0 \cap f(\gamma_0) = \{0\}$. Clearly, γ_0 is dividing if and only if $\gamma_i := f^i(\gamma_0)$ is dividing for all $i \in \mathbb{Z}$. Note that γ_i and γ_{i+j} can intersect away from 0 if $j \geq 2$.

The curves γ_0, γ_1 split $\overline{\mathbb{D}}$ into two closed sectors **A** and **B** denoted so that $\text{int } \mathbf{A}, \gamma_1, \text{int } \mathbf{B}, \gamma_0$ are clockwise oriented around 0, see the left-hand of Figure 8. We say that $\gamma_0 = \ell(\mathbf{A}) = \rho(\mathbf{B})$ is the *left boundary of A* and the *right boundary of B* and we say that $\gamma_1 = \rho(\mathbf{A}) = \ell(\mathbf{B})$ is the *right boundary of A* and the *left boundary of B*.

Let X, Y be topological spaces and let $g: X \dashrightarrow Y$ be a partially defined continuous map. We define

$$X \sqcup_g Y := X \sqcup Y / (\text{Dom } g \ni x \sim g(x) \in \text{Im } g).$$

Consider two sectors $S_0, S_1 \in \{\mathbf{A}, \mathbf{B}\}$; each S_i is a copy of either **A** or **B**. We define the map $g: \rho(S_0) \dashrightarrow \ell(S_1)$ by

$$(2.16) \quad g := \begin{cases} \text{id}: \gamma_1 \rightarrow \gamma_1 & \text{if } (S_0, S_1) \cong (\mathbf{A}, \mathbf{B}), \\ \text{id}: \gamma_0 \rightarrow \gamma_0 & \text{if } (S_0, S_1) \cong (\mathbf{B}, \mathbf{A}), \\ f^{-1}: \gamma_1 \rightarrow \gamma_0 & \text{if } (S_0, S_1) \cong (\mathbf{A}, \mathbf{A}), \\ f: \gamma_0 \rightarrow \gamma_1 & \text{if } (S_0, S_1) \cong (\mathbf{B}, \mathbf{B}). \end{cases}$$

The *dynamical gluing* of S_0, S_1 is $S_0 \sqcup_g S_1$. Similarly, the dynamical gluing is defined for any finite or infinite sequence $\mathbf{s} = (S_i)_i \in \{\mathbf{A}, \mathbf{B}\}^k$ with $k \leq \infty$. If \mathbf{s} is a finite sequence, then the result of the dynamical gluing is a closed sector. If, in addition, we glue the right boundary of the last sector of \mathbf{s} with the left boundary of the first sector of \mathbf{s} , then the result is a closed topological disk.

2.3.2. Prime antirenormalizations. The (clockwise) $1/3$ *antirenormalization* of f is a homeomorphism $f_{-1}: W \rightarrow W$ such that (see Figure 8)

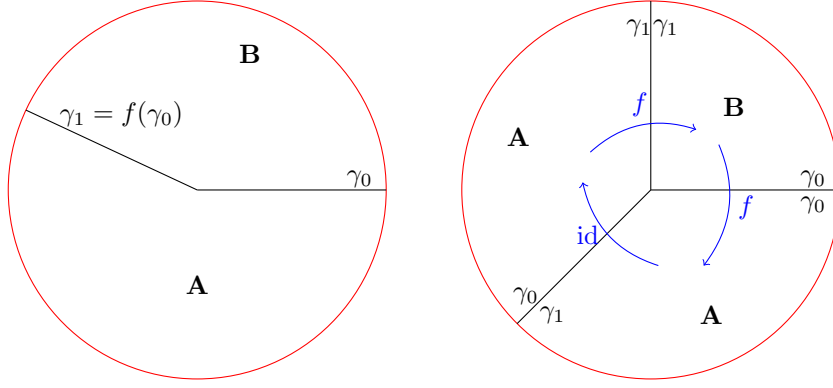

FIGURE 8. Left: a homeomorphism $f: W \rightarrow W$ and a diving pair γ_0, γ_1 . Right: the $1/3$ antirenormalization of f (with respect to the clockwise orientation).

- W is a closed topological disk that is the dynamical gluing of sectors $W[0]$, $W[1]$, $W[2]$, where $W[0]$ and $W[1]$ are copies of \mathbf{A} , while $W[2]$ is a copy of \mathbf{B} ;
- the map $f_{-1}: W[0] \rightarrow W[1]$ is the canonical isomorphism of copies of \mathbf{A} ;
- the map $f_{-1}: W[1, 2] \rightarrow W[0, 1]$ is identified with $f: W \setminus \gamma_0 \rightarrow W \setminus \gamma_1$.

Similarly, the p/q -antirenormalization is defined for any rational number p/q , see [DLS, § B.1.3]. The $1/3$ and $2/3$ antirenormalization are called *prime*. Any other antirenormalization is an iteration of prime antirenormalizations, see [DLS, Lemma B.3].

It follows from direct calculations that:

Lemma 2.5 (Inverse to (2.3)). *Let $f: \overline{\mathbb{D}} \rightarrow \overline{\mathbb{D}}$ be a homeomorphism and let $\mu \in (0, 1)$ be the rotation number of $f|_{\mathbb{S}^1}$.*

- *If $f_{-1}: \overline{\mathbb{D}} \rightarrow \overline{\mathbb{D}}$ is the (clockwise) $1/3$ antirenormalization of f , then the rotation number of $f_{-1}|_{\mathbb{S}^1}$ is*

$$\theta = \frac{\mu}{1 + \mu}.$$

- *If $f_{-1}: \overline{\mathbb{D}} \rightarrow \overline{\mathbb{D}}$ is the (clockwise) $2/3$ antirenormalization of f , then the rotation number of $f_{-1}|_{\mathbb{S}^1}$ is*

$$\theta = \frac{1}{2 - \mu}.$$

□

2.3.3. Pre-antirenormalizations. Recall from (2.5) that $e_-: \overline{\mathbb{H}}_- \rightarrow \overline{\mathbb{D}}^*$ denotes the universal covering map from the lower half plane to the punctured disk. We enumerate preimages of γ_0, γ_1 under e_- as $\tilde{\gamma}_i$ from left-to-right such that e_- maps $\tilde{\gamma}_i$ to $\gamma_{i \bmod 2}$. We specify the lifts f_- and f_+ of f such that

- f_- maps $\tilde{\gamma}_0$ to $\tilde{\gamma}_{-1}$; and
- f_+ maps $\tilde{\gamma}_0$ to $\tilde{\gamma}_1$.

Then $\chi := f_+ \circ f_-^{-1}$ is a deck transformation of \mathbf{e}_- . Note that f_- and f_+^{-1} move points to the left of $\overline{\mathbb{H}}_-$ while f_+ and f_-^{-1} move points to the right of $\overline{\mathbb{H}}_-$.

The 1/3 *pre-antirenormalization* of (f_-, f_+) is the commuting pair

$$(2.17) \quad (f_{-, -1} := f_- \circ f_+^{-1} = \chi^{-1}, \quad f_{+, -1} := f_+).$$

Setting $\chi_{-1} := f_{+, -1} \circ f_{-, -1}^{-1}$ and identifying $\overline{\mathbb{D}}^* \simeq \overline{\mathbb{H}}_- / \langle \chi_{-1} \rangle$, we recover the 1/3 antirenormalization of f :

$$f_{-1} := f_{-, -1} / \langle \chi_{-1} \rangle: \overline{\mathbb{D}} \rightarrow \overline{\mathbb{D}}, \quad f_{-1}(0) = 0,$$

see [DLS, Lemma B.4].

Similarly, the 2/3 *pre-antirenormalization* of (f_-, f_+) is the commuting pair

$$(2.18) \quad (f_{-, -1} := f_-, \quad f_{+, -1} := f_+ \circ f_-^{-1} = \chi).$$

Setting $\chi_{-1} := f_{+, -1} \circ f_{-, -1}^{-1}$ and identifying $\overline{\mathbb{D}}^* \simeq \overline{\mathbb{H}}_- / \langle \chi_{-1} \rangle$, we recover the 2/3 *antirenormalization*

$$f_{-1} := f_{-, -1} / \langle \chi_{-1} \rangle: \overline{\mathbb{D}} \rightarrow \overline{\mathbb{D}}, \quad f_{-1}(0) = 0,$$

see [DLS, Lemma B.6].

2.3.4. Tower of pre-antirenormalizations. Let us fix an irrational periodic point $\theta = R_{\text{prn}}^m(\theta)$ of (2.3). Then R_{prn}^m has an inverse branch R^- mapping $\mathbb{S}^1 \setminus \{0\}$ into a neighborhood of θ . Let us specify the antirenormalization operator associated with R^- . For $i \in \{1, \dots, m\}$, set \mathcal{R}_i^- to be

- the 1/3 pre-antirenormalization if $R_{\text{prn}}^i(\theta) \in (1/2, 1)$,
- the 2/3 pre-antirenormalization if $R_{\text{prn}}^i(\theta) \in (0, 1/2)$;

and set

$$(2.19) \quad \mathcal{R}^- := \mathcal{R}_1^- \circ \mathcal{R}_2^- \circ \dots \circ \mathcal{R}_m^-.$$

This operator is inverse to \mathcal{R} from (2.10). Since $\theta \notin \mathbb{Q}$, both 1/3 and 2/3 pre-antirenormalizations appear in (2.19).

We have the *pre-antirenormalization tower*:

$$F_n := (f_{n,-}, f_{n,+}) := (\mathcal{R}^-)^{-n}(f_-, f_+) \quad \text{for } n \leq 0.$$

Writing $\chi_n := f_{n,-}^{-1} \circ f_{n,+}$ and identifying $\overline{\mathbb{H}}_- / \langle \chi_n \rangle \simeq \overline{\mathbb{D}}^*$, we obtain the projection

$$(2.20) \quad \rho_n: \overline{\mathbb{H}}_- \rightarrow \overline{\mathbb{H}}_- / \langle \chi_n \rangle \subset \overline{\mathbb{D}}$$

semi-conjugating the pair F_n to a homeomorphism $f_n: \overline{\mathbb{D}} \rightarrow \overline{\mathbb{D}}$, where $f_n(0) := 0$. If μ is the rotation number of $f_0 | \mathbb{S}^1$, then $(R^-)^{-n}(\mu)$ is the rotation number of $f_n | \mathbb{S}^1$.

Lemma 2.6. *For $m \leq n \leq 0$, we have:*

- $f_{m,-}$ and $f_{m,+}^{-1}$ are compositions of $f_{n,-}$ and $f_{n,+}^{-1}$; and
- $f_{m,+}$ and $f_{m,-}^{-1}$ are compositions of $f_{n,+}$ and $f_{n,-}^{-1}$.

Proof. The operator \mathcal{R}^- is a composition of prime pre-antirenormalizations; the corresponding statement for a prime antirenormalization is immediate from the definition, see (2.17) and (2.18). \square

2.3.5. *Cascade* $F^{\geq 0} = (F^P)_{P \in \mathbb{T}}$. Similar to (2.11), we define

$$(2.21) \quad F^{(n,a,b)} := f_{n,-}^a \circ f_{n,+}^b,$$

where $(n, a, b) \in \mathbb{Z}_{\leq 0} \times \mathbb{Z}_{\geq 0}^2$. As in §2.1.2, F^T depends only on the image of (n, a, b) in the semi-group of power-triples \mathbb{T} , see (2.13).

Using Lemma 2.2, we view \mathbb{T} as a sub-semigroup of $\mathbb{R}_{\geq 0}$.

2.3.6. *Renormalization triangulations*. Let $\Delta_0(0)$ be the strip between $\tilde{\gamma}_{-1}$ and $\tilde{\gamma}_0$, and let $\Delta_0(1)$ be the strip between $\tilde{\gamma}_0$ and $\tilde{\gamma}_1$. We will refer to $\Delta_0(0)$ and $\Delta_0(1)$ as *triangles*.

As in §2.1.3 we define the *renormalization triangulation* Δ_0 of level 0 to be

$$\{F^P(\Delta_0(0)) \mid P < (0, 0, 1)\} \cup \{F^P(\Delta_0(1)) \mid P < (0, 1, 0)\},$$

i.e. Δ_0 consists of all the triangles in the forward F -orbits of $\Delta_0(0), \Delta_0(1)$ before they return back to $\Delta_0(0, 1)$. We say that Δ_0 is obtained by *spreading around* $\Delta_0(0)$ and $\Delta_0(1)$. We enumerate triangles of Δ_0 from left-to-right as $\Delta_0(i)$ with $i \in \mathbb{Z}$.

Similarly, we define the triangulation Δ_n for $n \leq 0$. The triangle $\Delta_n(0)$ is bounded by $f_{n,-}(\tilde{\gamma}_0) \cup \tilde{\gamma}_0$, and the triangle $\Delta_n(1)$ is bounded by $\tilde{\gamma}_0 \cup f_{n,+}(\tilde{\gamma}_0)$. The triangulation Δ_n is obtained by spreading around $\Delta_n(0)$ and $\Delta_n(1)$.

Note that $\Delta_n(0, 1)$ is a fundamental domain of χ_n , and we have a projection $\rho_n: \Delta_n(0, 1) \rightarrow \overline{\mathbb{D}}$ (see (2.20)) gluing the left and right boundaries of $\Delta_n(0, 1)$.

2.3.7. *Dynamics of triangles of Δ_0* . Consider the triangulation Δ_0 . For every $i \in \mathbb{Z}$, we write $\mathbf{s}[i] := \mathbf{B}$ if $\Delta_0(i)$ is in the forward orbit of $\Delta_0(0)$ before it returns to $\Delta_0(0, 1)$; and we write $\mathbf{s}[i] := \mathbf{A}$ if $\Delta_0(i)$ is in the forward orbit of $\Delta_0(1)$ before it returns to $\Delta_0(0, 1)$.

We can view $\Delta_0 \simeq \overline{\mathbb{H}}_-$ as the dynamical gluing of $(\mathbf{s}[i])_{i \in \mathbb{Z}}$ (see §2.3.1), where the left boundary of $\mathbf{s}[i+1]$ is glued with the right boundary of $\mathbf{s}[i]$. The dynamics of triangles of Δ_0 is described as follows. For every $i \in \mathbb{Z}$ there exists $P(i)$ such that

- if $\mathbf{s}[i] = \mathbf{B}$, then $P(i) < (0, 0, 1)$ and

$$(2.22) \quad F^{P(i)}: \Delta_0(0) \rightarrow \Delta_0(i)$$

is an isomorphism of copies of \mathbf{B} ;

- if $\mathbf{s}[i] = \mathbf{A}$, then $P(i) < (0, 1, 0)$ and

$$(2.23) \quad F^{P(i)}: \Delta_0(1) \rightarrow \Delta_0(i)$$

is an isomorphism of copies of \mathbf{A} .

Conversely, for every $P < (0, 0, 1)$ there exists i such that $\mathbf{s}[i] = \mathbf{B}$ and $P = P(i)$; and for every $P < (0, 1, 0)$ there exists i such that $\mathbf{s}[i] = \mathbf{A}$ and $P = P(i)$. On the other hand, for every $Q < \min\{(0, 0, 1), (0, 1, 0)\}$ there exists j with

$$(2.24) \quad \mathbf{s}[j] = \mathbf{B}, \quad \mathbf{s}[j+1] = \mathbf{A}, \quad P(j) = (0, 0, 1) - Q, \quad P(j+1) = (0, 1, 0) - Q$$

such that

$$(2.25) \quad F^Q: \Delta_0(j, j+1) \rightarrow \Delta_0(0, 1) \quad \text{is identified with} \quad f: \overline{\mathbb{D}} \setminus \gamma_0 \rightarrow \overline{\mathbb{D}} \setminus \gamma_1.$$

In other words, $\mathbf{F}^{-Q} \mid \Delta(0, 1)$ is identified with $f^{-1} \mid (\overline{\mathbb{D}} \setminus \gamma_1)$.

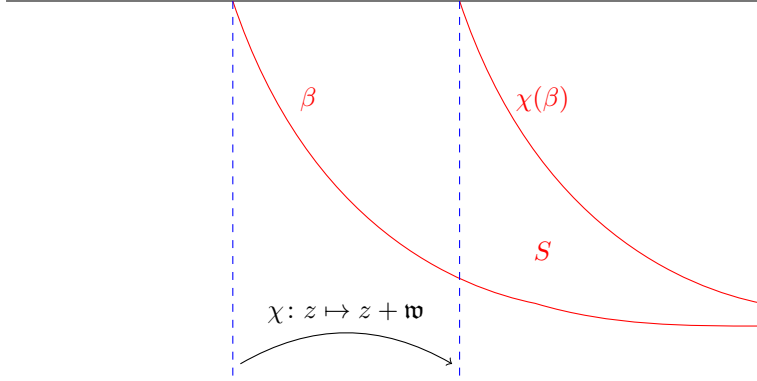

FIGURE 9. The sector S between β and $\chi(\beta)$ is not a fundamental domain of $\chi: z \mapsto z + \tau$ because not every orbit passes through S .

2.3.8. *Walls.* A wall around 0 respecting γ_0, γ_1 is either a closed annulus or a simple closed curve $\Pi \subset \overline{\mathbb{D}}$ such that

- (1) $\mathbb{C} \setminus \Pi$ has two connected components. Moreover, denoting by Ω the bounded component of $\mathbb{C} \setminus \Pi$, we have $0 \in \Omega$.
- (2) $\gamma_0 \cap \Pi$ and $\gamma_1 \cap \Pi$ are connected.
- (3) if $x \in \Omega$, then $f^{\pm 1}(x) \in \Pi \cup \Omega$.

In other words, points in $\overline{\mathbb{D}}$ do not jump over Π under one iteration of f . If Π is a simple closed curve, then f restricts to an actual homeomorphism $f: \overline{\Omega} \rightarrow \overline{\Omega}$.

We say that Π is an N -wall if it takes at least $N \geq 1$ iterates of $f^{\pm 1}$ for points in Ω to cross Π .

By definition, $\Pi \cap \mathbf{B}$ and $\Pi \cap \mathbf{A}$ are connected closed rectangles (possibly degenerate if Π is a curve). Let us denote by $\Pi(0)$ and $\Pi(1)$ the images of $\Pi \cap \mathbf{B}$ and $\Pi \cap \mathbf{A}$ under $\Delta_0(0) \simeq \mathbf{B}$ and $\Delta_0(1) \simeq \mathbf{A}$. The wall \mathbb{I} is obtained by spreading around $\Pi(0)$ and $\Pi(1)$

$$\mathbb{I} := \{F^P(\Pi(0)) \mid P < (0, 0, 1)\} \cup \{F^P(\Pi(1)) \mid P < (0, 1, 0)\},$$

i.e. \mathbb{I} consists of all the rectangles in the forward $F^{\geq 0}$ -orbits of $\Pi(0), \Pi(1)$ before they return back to $\Delta_0(0, 1)$. We enumerate rectangles of \mathbb{I} from left-to-right as $\Pi(i)$ with $i \in \mathbb{Z}$.

Every $\Pi(i)$ is a copy of either $\Pi \cap \mathbf{B}$ or $\Pi \cap \mathbf{A}$, and $\Pi(i)$ is glued to $\Pi(i+1)$ along id or $f^{\pm 1}$, see (2.16). Therefore, \mathbb{I} is connected, and, moreover, if Π is an N -wall, then \mathbb{I} is an $(N-1)$ -wall: it takes at least $N-1$ iterates of f_{\pm} for a point to cross \mathbb{I} .

2.3.9. *The boundary point α .* Let us add the boundary point α to $\overline{\mathbb{H}}_-$ which will be the preimage of 0 under $\rho_n: \Delta_n(0, 1) \sqcup \{\alpha\} \rightarrow \overline{\mathbb{D}}$.

We now introduce the wall topology Ξ on $\overline{\mathbb{H}}_- \sqcup \{\alpha\}$. For a wall $\mathbb{I} \subset \overline{\mathbb{H}}_-$, let $Q'_{\mathbb{I}} \subset \overline{\mathbb{H}}_-$ be the connected component of $\mathbb{C} \setminus \mathbb{I}$ below \mathbb{I} , i.e. $Q'_{\mathbb{I}} \not\ni 0$. We write $Q_{\mathbb{I}} := Q'_{\mathbb{I}} \sqcup \{\alpha\}$. In the topology Ξ of $\overline{\mathbb{H}}_- \sqcup \{\alpha\}$ open sets are generated by open sets of $\overline{\mathbb{H}}_-$ and $\{Q_{\mathbb{I}}: \mathbb{I} \text{ is a wall}\}$.

Remark 2.7. It can be shown that Ξ is independent of the choice of γ_0 .

2.3.10. *Fundamental domains.* A simple arc $\beta: [0, 1) \rightarrow \overline{\mathbb{H}}_-$ is *dividing* for n if

- (1) $\beta(0) \in \partial\mathbb{H}_-$ and $\beta(t) \in \mathbb{H}_-$ for $t > 0$;
- (2) β lands at α with respect to the wall topology Ξ ; and
- (3) β does not intersect $f_{n,-}(\beta)$ and $f_{n,+}(\beta)$.

For example, $\tilde{\gamma}_i$ are dividing arcs.

If β is dividing, then $\overline{\mathbb{H}}_- \setminus \beta$ has two connected components. (Indeed, (2) implies that $\lim_{t \rightarrow 1} \beta(t) = \infty$.) We denote the closures of the connected components of $\overline{\mathbb{H}}_- \setminus \beta$ by \mathfrak{L} and \mathfrak{R} enumerated so that \mathfrak{L} is on the left of β (i.e. $\mathfrak{L} \ni x$ for $x \ll 0$) while \mathfrak{R} is on the right of β (i.e. $\mathfrak{R} \ni x$ for $x \gg 0$).

Lemma 2.8. *For every $m \leq n$, the maps $f_{m,-}, f_{m,+}^{-1}$ move points to the left:*

$$f_{m,-}(\mathfrak{L}) \subset \mathfrak{L} \quad \text{and} \quad f_{m,+}^{-1}(\mathfrak{L}) \subset \mathfrak{L},$$

while $f_{m,+}, f_{m,-}^{-1}$ move points to the right:

$$f_{m,-}^{-1}(\mathfrak{R}) \subset \mathfrak{R} \quad \text{and} \quad f_{m,+}(\mathfrak{R}) \subset \mathfrak{R}$$

Proof. The case $m = n$ follows from the definition. The general case follows by induction because $f_{m,-}$ and $f_{m,+}^{-1}$ are compositions of $f_{n,-}$ and $f_{n,+}^{-1}$, while $f_{m,+}$ and $f_{m,-}^{-1}$ are compositions of $f_{n,+}$ and $f_{n,-}^{-1}$, see Lemma 2.6. \square

Proposition 2.9. *If β is a dividing curve for n , then for all $m \leq n$ the closed sector $S_m \subset \overline{\mathbb{H}}_-$ bounded by $f_{m,-}(\beta) \cup f_{m,+}(\beta)$ and containing β is a fundamental domain for χ_m .*

Conversely, if $\beta_0 \subset \overline{\mathbb{D}}$ is a dividing curve of f_n (see §2.3.1), then a lift $\beta \subset \overline{\mathbb{H}}_-$ of β_0 is a dividing arc for n .

As a corollary,

$$\overline{\mathbb{D}} \simeq \overline{\mathbb{H}}_- / \langle \chi_m \rangle \simeq S_m / f_{m,-}(\beta) \ni x \sim \chi_m(x) \in f_{m,+}(\beta).$$

To prove Proposition 2.9 we need to verify that every χ_m -orbit passes through S_m . Figure 2 illustrates that Condition (2) can not be relaxed to the condition “ β goes to infinity.”

Proof of Proposition 2.9. Since $f_{m,-}(\beta)$ is on the left of $f_{n,-}(\beta)$ (by Lemmas 2.6 and 2.8), the arcs $f_{m,-}(\beta)$ and β are disjoint. Similarly, $f_{m,+}(\beta)$ and β are disjoint. We need to show that for every $z \in \overline{\mathbb{H}}_-$ there is a $k \in \mathbb{Z}$ such that $\chi_m^k(z) \in S_m$.

Suppose converse, there is a $z \in \overline{\mathbb{H}}_-$ such that $\chi_m^k(z) \notin S_m$ for all $k \in \mathbb{Z}$. Since point can not jump over S_m under the iteration of χ_m , the orbit of z is either on the left of S_m or on the right of S_m .

Let us assume that there is a $z \in \overline{\mathbb{H}}_-$ whose orbit is on the left of S_m ; the opposite case is analogous. We will show that $F^P(z)$ is on the right from S_m for some $P \in \mathbb{T}$. Then for some $a, b \geq 0$ and $k \in \mathbb{Z}$, we would have

$$f_{n,+}^a \circ f_{n,-}^{-b} \circ F^P(z) = \chi_m^k(z).$$

This will be a contradiction, because $\chi_m^k(z)$ is still on the right of S_m for all $k \in \mathbb{Z}$ by Lemma 2.8.

Let us choose a 1-wall \mathbb{A} separating z from α . We denote by Q the connected component of $\overline{\mathbb{H}}_- \setminus \mathbb{A}$ attached to α . Since $f_{m,-}(\beta)$ and $f_{m,+}(\beta)$ land at α , the sector S_m intersects at most finitely many truncated triangles $\Delta(i) \setminus Q$. This means that $\Delta(j) \setminus Q$ is on the right of S_m for $j \gg 0$.

Write $z \in \Delta(i)$. There is a small $P \in \mathbb{T}$ and a big $j \gg 0$ such that $F^P: \Delta(i) \rightarrow \Delta(j)$ is a homeomorphism. Then $F^P(z) \subset \Delta(j) \setminus Q$ is on the right from S_m . This proves that S_m is a fundamental domain.

The converse statement is immediate. \square

2.3.11. Partial homeomorphisms. Let us show that Proposition 2.9 with necessary adjustments holds for partial homeomorphisms.

Consider a partial homeomorphism $f: \bar{\mathbb{D}} \dashrightarrow \bar{\mathbb{D}}$ with $f(0) = 0$ such that $\text{Dom } f$ and $\text{Im } f$ are closed topological disks containing 0 in their interiors.

As in §2.3.1, let γ_0, γ_1 be two simple arcs connecting 0 to points in $\partial\mathbb{D}$ such that γ_0 and γ_1 are disjoint except for 0 and such that γ_1 is the image of γ_0 in the following sense: $\gamma'_0 := \gamma_0 \cap \text{Dom } f$ and $\gamma'_1 := \gamma_1 \cap \text{Im } f$ are simple closed curves such that f maps γ'_0 to γ'_1 . We call γ_0, γ_1 a *dividing pair*. Then $\gamma_0 \cup \gamma_1$ splits $\bar{\mathbb{D}}$ into two closed sectors \mathbf{A} and \mathbf{B} denoted so that $\text{int } \mathbf{A}, \gamma_1, \text{int } \mathbf{B}, \gamma_0$ are clockwise oriented around 0.

Similar to (2.16), given two sectors $S_i, S_{i+1} \in \{\mathbf{A}, \mathbf{B}\}$, we naturally have a partial map $g: \rho(S_0) \dashrightarrow \ell(S_1)$ defined by

$$(2.26) \quad g := \begin{cases} \text{id}: \gamma_1 \rightarrow \gamma_1 & \text{if } (S_i, S_{i+1}) \cong (\mathbf{A}, \mathbf{B}), \\ \text{id}: \gamma_0 \rightarrow \gamma_0 & \text{if } (S_i, S_{i+1}) \cong (\mathbf{B}, \mathbf{A}), \\ f^{-1}: \gamma'_1 \rightarrow \gamma'_0 & \text{if } (S_i, S_{i+1}) \cong (\mathbf{A}, \mathbf{A}), \\ f: \gamma'_0 \rightarrow \gamma'_1 & \text{if } (S_i, S_{i+1}) \cong (\mathbf{B}, \mathbf{B}), \end{cases}$$

The *dynamical gluing* of a sequence of sectors $(S_i)_i \in \{\mathbf{A}, \mathbf{B}\}^k$ with $k \leq \infty$ is defined in the same way as in §2.3.1; i.e. the left boundary of S_i is glued with the right boundary of S_{i-1} along (2.26).

Let $\mathbf{s} \in \{\mathbf{A}, \mathbf{B}\}^{\mathbb{Z}}$ be the sequence from §2.3.7 (where f is assumed to be a homeomorphism), and let Δ_0 be corresponding dynamical gluing. Then Δ_0 is a triangulation *associated* with γ_0, γ_1 , we enumerate triangles of Δ_0 from left-to-right as $\Delta_0(i) \simeq \mathbf{s}[i]$, with $i \in \mathbb{Z}$.

For every $Q < \min\{(0, 1, 0), (0, 0, 1)\}$, we define the partial homeomorphism $\mathbf{F}^Q: \Delta_0 \dashrightarrow \Delta_0$ trianglewise using (2.22), (2.23), and (2.25). Taking iterates, we obtain the cascade of partial homeomorphisms

$$F^{\geq 0} := \{F^P: \Delta_0 \dashrightarrow \Delta_0 \mid P \in \mathbb{T}\}.$$

In particular, $f_- = F^{(0,1,0)}$ and $f_+ = F^{(0,0,1)}$ are well defined. The commuting pair

$$(2.27) \quad f_+: \Delta_0(0) \rightarrow \Delta_0(0,1) \quad \text{and} \quad f_-: \Delta_0(1) \rightarrow \Delta_0(0,1)$$

realizes the first return of points in $\Delta_0(0,1)$ back to $\Delta_0(0,1)$. The pair (2.27) is obtained by cutting $f: \bar{\mathbb{D}} \dashrightarrow \bar{\mathbb{D}}$ along γ_1 . Conversely, there is a projection

$$\rho: \Delta_0(0,1) \rightarrow \bar{\mathbb{D}}$$

semi-conjugating $F = (f_-, f_+)$ to f such that ρ glues the left boundary λ of $\Delta_0(0,1)$ with its right boundary ρ . The gluing map $\chi: \lambda \rightarrow \rho$ coincides with $f_+ \circ f_-^{-1}: \lambda \dashrightarrow \rho$ in $\text{Dom}(f_+ \circ f_-^{-1})$.

A *wall* $\Pi \subset \text{Dom } f \cap \text{Im } f$ around 0 respecting γ_0, γ_1 for $f: \bar{\mathbb{D}} \dashrightarrow \bar{\mathbb{D}}$ is defined in the same way as in the case of homeomorphisms, see §2.3.8. Lifting Π under ρ and spreading Π around, we obtain the connected strip $\mathbb{I} \subset \Delta$. As in §2.3.9, we add the boundary point α to Δ_0 , and we endow $\Delta_0 \sqcup \{\alpha\}$ with the *wall topology*.

Fix a wall Π and its full lift $\mathbb{P} \subset \mathbb{A}$. Let us denote by Q the connected component of $\mathbb{A} \setminus \mathbb{P}$ attached to α . Note that $Q \subset \text{Dom}(f_-) \cap \text{Dom}(f_+)$.

A *fundamental domain* for f is a sector S^{new} with distinguished sides λ^{new} and ρ^{new} such that

- (1) $S^{\text{new}} \setminus Q = \Delta(0, 1) \setminus Q$, and $\lambda^{\text{new}} \setminus Q = \lambda \setminus Q$, and $\rho^{\text{new}} \setminus Q = \rho \setminus Q$,
- (2) $f_+ \circ f_-^{-1}(\lambda^{\text{new}} \cap (\mathbb{P} \cup Q)) \subset \rho^{\text{new}}$ and $f_-^{-1}(\lambda^{\text{new}} \cap (\mathbb{P} \cup Q)) \subset \text{int}(S^{\text{new}})$;
- (3) λ^{new} and ρ^{new} land at α .

We define the gluing map

$$\chi^{\text{new}}: \lambda \rightarrow \rho$$

to be

- χ on $\lambda \setminus Q$; and
- $F^{(0,0,1)-(0,1,0)} = f_+ \circ f_-^{-1}$ on $\lambda \cap Q$.

Gluing the left and right boundaries of S^{new} along χ^{new} , we obtain a closed topological disk W . We realize W as a subset of \mathbb{C} , and we denote by

$$\rho^{\text{new}}: S^{\text{new}} \rightarrow W, \quad \rho^{\text{new}}(\alpha) = 0$$

the induced projection. Then $F = (f_-, f_+)$ projects to

$$f^{\text{new}}: W \dashrightarrow W.$$

Write $\Omega = \rho(Q \cap S) \subset \overline{\mathbb{D}}$ and $\Omega^{\text{new}} = \rho^{\text{new}}(Q \cap S^{\text{new}}) \subset W$.

Proposition 2.10. *Let S^{new} be a fundamental domain for f as above. Then the quotient map $f^{\text{new}}: W \dashrightarrow W$ is canonically conjugate to $f: \overline{\mathbb{D}} \dashrightarrow \overline{\mathbb{D}}$.*

Conversely, suppose $\gamma_0^{\text{new}}, \gamma_1^{\text{new}}$ is a dividing pair such that $\gamma_0^{\text{new}} \setminus \Omega = \gamma_0 \setminus \Omega$ and $\gamma_1^{\text{new}} \setminus \Omega = \gamma_1 \setminus \Omega$. Let Δ_0^{new} be the triangulation associated with $\gamma_0^{\text{new}}, \gamma_1^{\text{new}}$. Then the cascades $F \mid \Delta_0$ and $F \mid \Delta_0^{\text{new}}$ are canonically conjugate.

The canonical homeomorphism $h: \overline{\mathbb{D}} \rightarrow W$ has the following characterization:

- $h: \overline{\mathbb{D}} \setminus \Omega \rightarrow W \setminus \Omega^{\text{new}}$ is the canonical identification using Condition (1);
- if $h \circ \rho(x) = \rho^{\text{new}}(y) \in \Omega^{\text{new}}$ for some $x, y \in \mathbb{A}$, then x and y are related by the action of the deck transformation $\chi \mid Q$: for some $n \in \mathbb{Z}$ we have $x \in \text{Dom}(\chi \mid Q)^n$ and $\chi^n(x) = y$.

Equivalently, the canonical homeomorphism $h: \overline{\mathbb{D}} \rightarrow W$ can be characterized using unique extension along curves as in [DLS, Theorem B.8]. A similar characterization has a canonical homeomorphism between Δ_0 and Δ_0^{new} .

Proof of Proposition 2.10. Denote by Ω and Ω^{new} the images of $Q \sqcup \{\alpha\}$ under ρ and ρ^{new} respectively. Condition (1) implies that $\overline{\mathbb{D}} \setminus \Omega$ is canonically identified with $W \setminus \Omega^{\text{new}}$ by an equivariant homeomorphism.

We can now modify $f: \overline{\mathbb{D}} \dashrightarrow \overline{\mathbb{D}}$ away from $\Omega \cup f(\Omega) \cup f^{-1}(\Omega)$ to obtain a self-homeomorphism $f: \overline{\mathbb{D}} \rightarrow \overline{\mathbb{D}}$ mapping γ_0 to γ_1 . Since the modification does not affect $f \mid \Omega$, we obtain a reformulation of Proposition 2.9. \square

3. BACKGROUND ON THE PACMAN RENORMALIZATION

3.1. Quadratic-like renormalization. Recall that copies of the Mandelbrot set are canonically homeomorphic via the straightening map, see [DH2]. See also [DH1, L4] for the background on the Mandelbrot set. Given a small copy \mathcal{M}_s of the Mandelbrot set, we denote by $\mathbf{R}_s: \mathcal{M}_s \rightarrow \mathcal{M}$ the canonical homeomorphism between \mathcal{M}_s and \mathcal{M} .

A quadratic polynomial $p_c = z^2 + c$, $c \in \mathcal{M}$, is *renormalizable* if c belongs to a small copy of the Mandelbrot set. Let \mathcal{M}_s be the biggest small copy of \mathcal{M} containing c . We set $\mathbf{R}_{\text{QL}}(c) := \mathbf{R}_s(c)$. This way we obtain the partial map $\mathbf{R}_{\text{QL}}: \mathcal{M} \dashrightarrow \mathcal{M}$. A map p_c is *infinitely renormalizable* if c is within the non-escaping set

$$\text{NE}(\mathbf{R}_{\text{QL}}) := \bigcap_{i \geq 0} \text{Dom } \mathbf{R}_{\text{QL}}^i$$

of \mathbf{R}_{QL} . If the connected component of $\text{NE}(\mathbf{R}_{\text{QL}})$ containing c is a singleton, then \mathcal{M} is locally connected at c . The global MLC conjecture is equivalent to the assertion that every connected component of $\text{NE}(\mathbf{R}_{\text{QL}})$ is a singleton.

An infinitely renormalizable parameter c has *bounded type* if its orbit $\mathbf{R}_{\text{QL}}^n(c)$ belongs to finitely many maximal small copies of \mathcal{M} . If, moreover, the maximal copies of \mathcal{M} containing $\mathbf{R}_{\text{QL}}^n(c)$ are satellite, then c has *bounded satellite type*.

3.1.1. Analytic renormalization operator. (See [L3] for details.) Let us write a quadratic-like map as $f: U \rightarrow V$, and let us denote by $[f: U \rightarrow V]$ the quadratic-like germ of f considered up to affine equivalence. The modulus of the fundamental annulus $V \setminus \bar{U}$ is the *modulus of f* , denoted by $\text{mod } f$. We denote by $\mathfrak{R}(f)$ and $\mathfrak{P}(f)$ the non-escaping and postcritical sets of f .

In [L3] the space \mathcal{QL} of *quadratic-like germs* is supplied with complex analytic structure. Let $\mathfrak{M} \subset \mathcal{QL}$ be the connectedness locus; i.e. the set of germs with a non-escaping critical point.

The hybrid classes form a codimension-one lamination \mathcal{F}_{QL} of \mathfrak{M} with complex codimension-one analytic leaves. Every leaf of $\mathcal{F}_i \in \mathcal{F}_{\text{QL}}$ contains a unique parameter c_i in the actual Mandelbrot set. By collapsing every $\mathcal{F}_i \in \mathcal{F}_{\text{QL}}$ to c_i , we obtain the projection $\chi: \mathfrak{M} \rightarrow \mathcal{M}$.

Consider a small copy $\mathcal{M}_s \subsetneq \mathcal{M}$ of period $n > 1$. There is an analytic operator $\mathcal{R}_s: \mathcal{QL} \dashrightarrow \mathcal{QL}$ associated with \mathcal{M}_s such that

$$\mathcal{R}_s[f: U \rightarrow V] = [f^n: U_i \rightarrow V_i].$$

We assume that V_i contains the critical value of f . The operator \mathcal{R}_s satisfies $\chi \circ \mathcal{R}_s = \mathbf{R}_s \circ \chi$. If \mathcal{M}_s is satellite, then \mathcal{R}_s is defined on a neighborhood of $\chi^{-1}(\mathcal{M}_s \setminus \{\text{cusp}\})$; and if \mathcal{M}_s is primitive, then \mathcal{R}_s is defined on a neighborhood of $\chi^{-1}(\mathcal{M}_s)$.

Combining all \mathcal{R}_s over all the maximal copies $\mathcal{M}_s \subsetneq \mathcal{M}$, we obtain an analytic operator $\mathcal{R}_{\text{QL}}: \mathcal{QL} \dashrightarrow \mathcal{QL}$ such that (with appropriate choices of branches)

$$\chi \circ \mathcal{R}_{\text{QL}} = \mathbf{R}_{\text{QL}} \circ \chi.$$

3.1.2. Satellite copies. Consider a rational number $\tau \in \mathbb{Q}$ between 0 and 1. We denote by $\mathcal{M}_\tau \subset \mathcal{M}$ the primary satellite copy of \mathcal{M} with rotation number τ . In other words, \mathcal{M}_τ is the unique copy of the Mandelbrot set attached to the parabolic parameter $p_{c(\tau)} \in \partial\Delta$ with rotation number τ . We have the canonical homeomorphism $\mathbf{R}_\tau: \mathcal{M}_\tau \rightarrow \mathcal{M}$.

For $\tau, \mathfrak{s} \in \mathbb{Q} \cap (0, 1)$, we write $\mathcal{M}_{\tau, \mathfrak{s}} := \mathcal{R}_\tau^{-1}(\mathcal{M}_\mathfrak{s})$ and we denote by $\mathbf{R}_{\tau, \mathfrak{s}}: \mathcal{M}_{\tau, \mathfrak{s}} \rightarrow \mathcal{M}$ the canonical homeomorphism. The construction continues by induction. In particular, $\mathcal{M}_{\tau, \mathfrak{s}, \mathfrak{t}} := \mathbf{R}_{\tau, \mathfrak{s}}^{-1}(\mathcal{M}_\mathfrak{t})$.

3.1.3. *Local connectivity of the Julia set.* An infinitely renormalizable quadratic-like map $f: U \rightarrow V$ is said to satisfy an *unbranched a priori bounds* (see [McM1]) if there is an $\varepsilon > 0$ such that for infinitely many n the renormalization $f_n := \mathcal{R}_{\text{QL}}^n(f)$ can be written as $f_n: U_n \rightarrow V_n$ so that

$$(3.1) \quad V_n \cap \mathfrak{P}(f) \subset \mathfrak{K}(f_n)$$

and the modulus of $V_n \setminus U_n$ is at least ε . We will refer to (3.1) as the *unbranched condition*. It is known that any infinitely renormalizable quadratic-like map with unbranched *a priori* bounds has locally connected Julia set; see [J],[McM1], [L2, Theorem VI] for the reference.

3.1.4. *Renormalization periodic points and horseshoes.* A quadratic-like map $f: U \rightarrow V$ is a *renormalization periodic point* if it is conformally conjugate to its proper quadratic-like renormalization: there is an iteration

$$f_\bullet = f^m: U_\bullet \rightarrow V_\bullet, \quad U_\bullet \subset U$$

and a conformal conjugacy (renormalization change of variables) $\phi: V_\bullet \rightarrow V$ between $f_\bullet|_{U_\bullet}$ and $f|_U$. The projection $\chi(f) \in \mathcal{M}$ is a periodic point of \mathbf{R}_{QL} , see §3.1.1. We usually assume that $c_1(f) = c_1(f_\bullet)$ i.e., c_1 is a fixed point of ϕ . Since $U_\bullet \subsetneq U$, we have $|\phi'(c_1)| > 1$ by the Schwarz lemma.

Linearizing ϕ one can assume that it is affine: if L is the linearizer for ϕ , then replacing ϕ, f, f_\bullet with their conjugacies by L we obtain that the new f_\bullet is affinely conjugate to f .

By a *renormalization horseshoe* \mathcal{H} we mean a precompact family of quadratic-like maps $f: U_f \rightarrow V_f$ such that every $f \in \mathcal{H}$ has a quadratic-like renormalization $f_1 = f^{m(f)}: U_{f_1} \rightarrow V_{f_1}$ conformally conjugate to a map \hat{f}_1 in \mathcal{H} and such that the renormalization $f \mapsto \hat{f}_1: \mathcal{H} \rightarrow \mathcal{H}$ is injective. A horseshoe \mathcal{H} is *hyperbolic* if it is a hyperbolic set of a renormalization operator defined on a neighborhood of \mathcal{H} .

Since the renormalization change of variables in a horseshoe \mathcal{H} is conformal, unbranched a priori bounds descends from the top to all deep scales: if

$$\text{mod}(V_f \setminus U_f) \geq \varepsilon \quad \text{and} \quad V_{f_1} \cap \mathfrak{P}(f) \subset \mathfrak{K}(f_1) \quad \text{for all } f \in \mathcal{H}$$

then $\text{mod}(V_{f_n} \setminus U_{f_n}) \geq \varepsilon$ and $V_{f_n} \cap \mathfrak{P}(f) \subset \mathfrak{K}(f_n)$ for all n .

3.2. **Pacmen.** In this subsection we collect the background information on the pacman renormalization from [DLS]. A *full pacman* is a map

$$f: \bar{U} \rightarrow \bar{V}$$

such that (see Figure 1 and [DLS, Definition 2.1])

- $f(\alpha) = \alpha$;
- \bar{U} is a closed topological disk with $\bar{U} \subset V$;
- the critical arc γ_1 has exactly 3 lifts $\gamma_0 \subset U$ and $\gamma_-, \gamma_+ \subset \partial U$ such that γ_0 starts at the fixed point α while γ_-, γ_+ start at the pre-fixed point α' ; we assume that γ_1 does not intersect $\gamma_0, \gamma_-, \gamma_+$ away from α ;
- $f: U \rightarrow V$ is analytic and $f: U \setminus \gamma_0 \rightarrow V \setminus \gamma_1$ is a two-to-one branched covering;
- f admits a locally conformal extension through $\partial U \setminus \{\alpha'\}$.

A pacman is obtained from a full pacman by removing a small neighborhood of α' , see Figure 10. More precisely, a *pacman* is an analytic map

$$(3.2) \quad f: (U, O_0) \rightarrow (V, O)$$

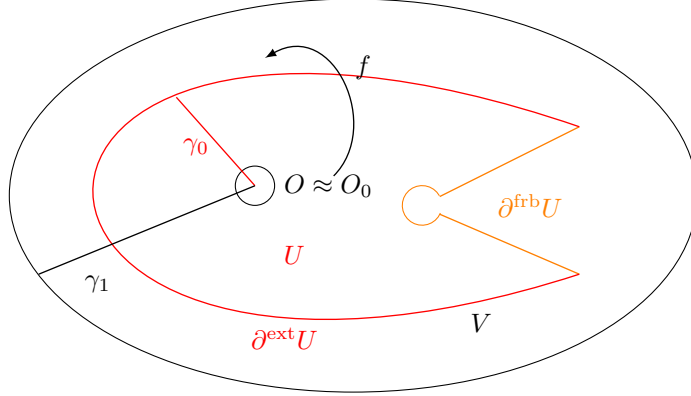

FIGURE 10. A pacman is a truncated version of a full pacman, see Figure 1; it is an almost 2 : 1 map $f : (U, O_0) \rightarrow (V, O)$ with $f(\partial U) \subset \partial V \cup \gamma_1 \cup \partial O$.

with $f(\partial U) \subset \partial V \cup \gamma_1 \cup \partial O$ such that

- O_0 and O are disk neighborhoods of α and f maps O_0 conformally to O ;
- f admits a locally conformal extension through ∂U ;
- every point in $V \setminus O$ has two preimages in U as for a full pacman while every point in O has a single preimage in O_0 (in other words, f can be topologically extended to a full topological pacman by adding topologically the second preimage of $O \setminus \gamma_1$).

We recognize the following two subsets of the boundary of U : the *external boundary* $\partial^{\text{ext}} U := f^{-1}(\partial V)$ and the *forbidden part of the boundary* $\partial^{\text{frb}} U := \overline{\partial U} \setminus \overline{\partial^{\text{ext}} U}$.

Given a pacman $f : U \rightarrow V$, its *non-escaping set* is

$$\mathfrak{K}_f := \bigcap_{n \geq 0} f^{-n}(\overline{U}),$$

it is sensitive to a small deformation of ∂U . The *escaping set* of f is $V \setminus \mathfrak{K}_f$.

Let us embed a topological rectangle \mathfrak{R} in $\overline{V} \setminus U$ so that the bottom horizontal side is equal to $\partial^{\text{ext}} U$ and the top horizontal side is a subset of ∂V . The images of the vertical lines within \mathfrak{R} form a lamination of $\overline{V} \setminus U$. We pull back this lamination to all iterated preimages $f^{-n}(\mathfrak{R})$. Leaves of this lamination that start at ∂V are called *external ray segments* of f ; infinite external ray segments are called *external rays* of f . Note that if γ is an external ray, then $f(\gamma) := f(\gamma \cap U)$ is also an external ray. Every external ray γ has a well defined external angle ϕ such that the angle of $f(\gamma)$ is 2ϕ , see [DLS, §2.1].

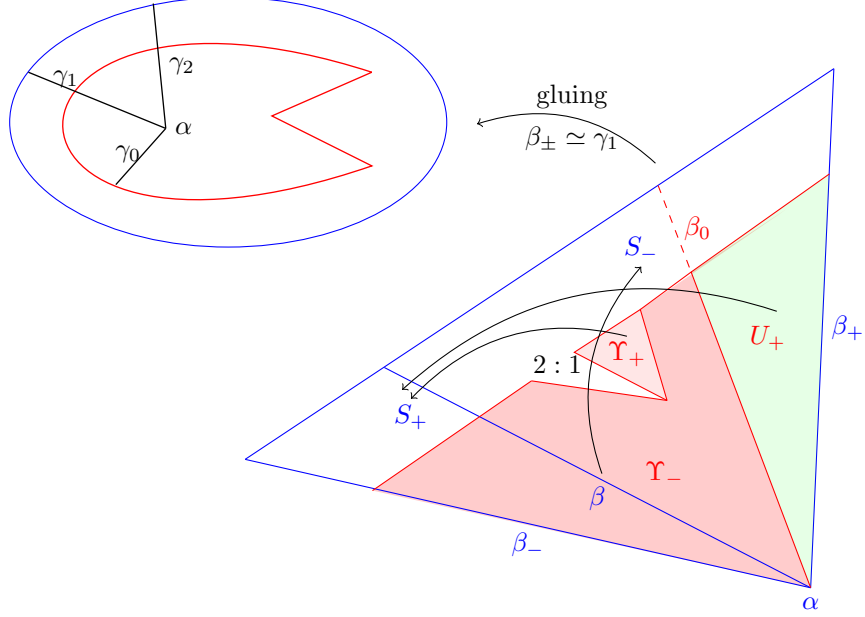

FIGURE 11. A (full) prepacman ($f_- : U_- \rightarrow S$, $f_+ : U_+ \rightarrow S$). We have $U_- = \Upsilon_- \cup \Upsilon_+$ and f_- maps Υ_- two-to-one to S_- and Υ_+ to S_+ . The map f_+ maps U_+ univalently onto S_+ . After gluing dynamically β_- and β_+ we obtain a full pacman: the arcs β_- and β_+ project to γ_1 , the arc β_0 projects to γ_0 , and the arc β projects to γ_2 .

3.2.1. *Prepacmen.* (See Figure 11 and [DLS, Definition 2.2].) A prepacman is a pair of commuting maps that can be glued into a pacman. More precisely, consider a sector S with boundary rays $\beta_-, \beta_+ \subset \partial S$ and with an interior ray β_0 that divides S into two subsectors T_-, T_+ . Let $f_- : U_- \rightarrow S$, $f_+ : U_+ \rightarrow S$ be a pair of holomorphic maps, defined on $U_- \subset T_-$ and $U_+ \subset T_+$. We say that $F = (f_\pm : U_\pm \rightarrow S)$ is a *prepacman* if there exists a gluing ψ of S which projects (f_-, f_+) onto a pacman $f : U \rightarrow V$ where $\psi|_{\text{int } S}$ is conformal, β_-, β_+ are mapped to the critical arc $\gamma_1 = \psi(\beta_\pm)$, and β_0 is mapped to γ_0 .

The definition implies that f_- and f_+ commute in a neighborhood of β_0 . Note that every pacman $f : U \rightarrow V$ has a prepacman obtained by cutting V along the critical arc γ_1 . Dynamical objects (such as the non-escaping set) of a prepacman F are preimages of the corresponding dynamical objects of f under ψ .

3.2.2. *Pacman renormalization.* (See Figure 12 and [DLS, Definition 2.3].) We say that a holomorphic map $f : (U, \alpha) \rightarrow (V, \alpha)$ with a distinguished α -fixed point is *pacman renormalizable* if there exists a prepacman

$$G = (g_- = f^a : U_- \rightarrow S, \quad g_+ = f^b : U_+ \rightarrow S)$$

defined on a sector $S \subset V$ with vertex at α such that g_-, g_+ are iterates of f realizing the first return map to S and such that the f -orbits of U_-, U_+ before

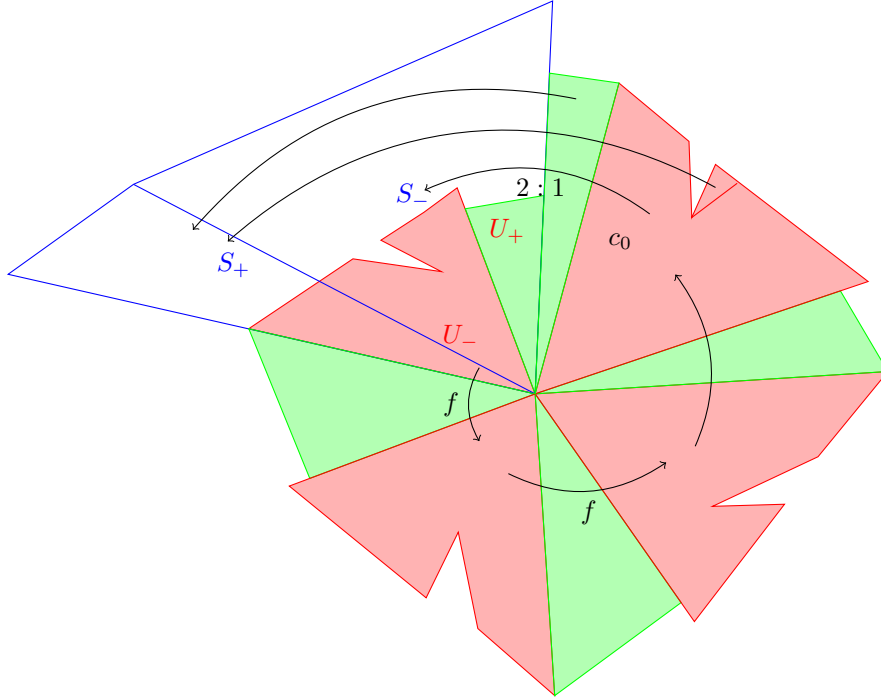

FIGURE 12. Pacman renormalization of f : the first return map of points in $U_- \cup U_+$ back to $S = S_- \cup S_+$ is a prepacman. Spreading around U_{\pm} : the orbits of U_- and U_+ before returning back to S triangulate a neighborhood Δ of α ; we obtain $f: \Delta \rightarrow \Delta \cup S$, and we require that Δ is compactly contained in $\text{Dom } f$.

they return to S cover a neighborhood of α compactly contained in U . We call G the *pre-renormalization* of f and the pacman $g: \widehat{U} \rightarrow \widehat{V}$ is the *renormalization* of f . By default, we assume that S contains the critical value of f .

The numbers \mathbf{a}, \mathbf{b} are the *renormalization return times*. The renormalization of f is called *prime* if $\mathbf{a} + \mathbf{b} = 3$. Combinatorially, a pacman renormalization is an iteration of prime renormalizations, see §2.

We define $\Delta = \Delta_G$ to be the union of points in the f -orbits of $\overline{U}_-, \overline{U}_+$ before they return to S . Naturally, Δ is a triangulated neighborhood of α , see Figure 12. We call Δ a *renormalization triangulation* and we will often say that Δ is obtained by *spreading around* U_-, U_+ . We require $\Delta_G \in \text{Dom } f$ and $\Delta_G \cup S \in \text{Im } f$.

An *indifferent pacman* is a pacman with indifferent α -fixed point. The *rotation number* of an indifferent pacman f is $\theta \in \mathbb{R}/\mathbb{Z}$ so that $e(\theta)$ is the multiplier at $\alpha(f)$. If, in addition, $\theta \in \mathbb{Q}$, then f is *parabolic*. A pacman renormalization of an indifferent pacman is again an indifferent pacman.

3.2.3. *Banach neighborhoods.* (See [DLS, §2.4].) Consider a pacman $f: (U_f, O_0, \gamma_0) \rightarrow (V, O, \gamma_1)$ with a non-empty truncation disk O . We assume that there is a topological disk $\tilde{U} \ni U_f$ with a piecewise smooth boundary such that f extends analytically to \tilde{U} and continuously to its closure. Choose a small $\varepsilon > 0$ and define $N_{\tilde{U}}(f, \varepsilon)$ to

be the set of analytic maps $g : \tilde{U} \rightarrow \mathbb{C}$ with continuous extensions to $\partial\tilde{U}$ such that

$$\sup_{z \in \tilde{U}} |f(z) - g(z)| < \varepsilon.$$

Then $N_{\tilde{U}}(f, \varepsilon)$ is a Banach ball; it is the ε neighborhood of f in the Banach space of maps defined on \tilde{U} . [DLS, Lemma 2.5] asserts that if γ_0, γ_1 land at α at distinct well-defined angles and ε is sufficiently small, then every $g \in N_{\tilde{U}}(f, \varepsilon)$ has a domain $U_g \subset \tilde{U}$ such that $g : U_g \rightarrow V$ is a pacman with the same V, γ_1, O (up to translation).

3.2.4. Pacman analytic operator. (Summary of [DLS, §2.5].) Suppose that a pacman $\hat{f} : \hat{U} \rightarrow \hat{V}$ is a renormalization of a holomorphic map $f : (U, \alpha) \rightarrow (V, \alpha)$ via a quotient map $\psi_f : S_f \rightarrow \hat{V}$. Assume that the curves $\beta_0, \beta_-, \beta_+$ (see Figures 11 and 12) land at α at pairwise distinct well-defined angles. [DLS, Theorem 2.7] asserts that for every sufficiently small neighborhood $N_{\tilde{U}}(f, \varepsilon)$, there exists a compact analytic pacman renormalization operator $\mathcal{R} : g \mapsto \hat{g}$ defined on $N_{\tilde{U}}(f, \varepsilon)$ such that $\mathcal{R}(f) = \hat{f}$. Moreover, the gluing map ψ_g , used in this renormalization, also depends analytically on g . Note that the operator \mathcal{R} is non-dynamical: it goes from a small Banach neighborhood of f (where f needs not be a pacman) to a certain small Banach neighborhood of the pacman \hat{f} . If $\hat{f} = f$ as germs and $\hat{U} \supset \tilde{U}$, i.e., there is an “improvement of the domain”, then $\mathcal{R} : N_{\tilde{U}}(f, \varepsilon) \rightarrow N_{\tilde{U}}(f, \delta)$, $\mathcal{R}f = f$ is a dynamical operator for sufficiently small ε and δ .

3.2.5. Siegel pacmen. (See [DLS, §3]) A holomorphic map $f : U \rightarrow V$ is *Siegel* if it has a fixed point α , a Siegel quasidisk $\bar{Z}_f \ni \alpha$ compactly contained in U , and a unique critical point $c_0 \in U$ that is on the boundary of Z_f . Note that in [AL2] a Siegel map is assumed to satisfy additional technical requirements; these requirements are satisfied by restricting f to an appropriate small neighborhood of \bar{Z}_f .

It follows from [AL2, Theorem 3.19, Proposition 4.3] that any two Siegel maps with the same rotation number of bounded type are hybrid conjugate on neighborhoods of their closed Siegel disks.

A pacman $f : U \rightarrow V$ is *Siegel* if

- f is a Siegel map with Siegel disk Z_f centered at α ;
- the critical arc γ_1 is the concatenation of an external ray R_1 followed by an inner ray I_1 of Z_f such that the unique point in the intersection $\gamma_1 \cap \partial Z_f$ is not precritical; and
- writing $f : (U, O_0) \rightarrow (V, O)$ as in (3.2), the disk O is a subset of Z_f bounded by its equipotential.

The *rotation number* of a Siegel pacman (or a Siegel map) is $\theta \in \mathbb{R}/\mathbb{Z}$ so that $\mathbf{e}(\theta)$ is the multiplier at α . It follows that the rotation number of Siegel map is in Θ_{bnd} – the set of combinatorially bounded rotation numbers (i.e., rotation numbers with continued fraction expansion where all its coefficients are bounded).

If f is a Siegel pacman, then all external rays of f land. Moreover, ∂Z_f is in the closure of repelling periodic points, and every neighborhood of ∂Z_f contains a repelling periodic cycle. Moreover, the non-escaping set of f is locally connected.

A Siegel pacman is *standard* if γ_0 passes through the critical value; equivalently if γ_1 passes through the image of the critical value. By [DLS, Corollary 3.7 and Lemma 3.4] every Siegel map can be renormalized to a standard Siegel pacman.

3.2.6. *Hyperbolic pacman renormalization self-operator.* Let us now fix a rotation number θ_* periodic under R_{prm} , see (2.3). By [DLS, Theorems 3.16 and 7.7], there is a pacman renormalization operator $\mathcal{R}: N_{\bar{U}}(f_*, \varepsilon) \rightarrow N_{\bar{U}}(f_*, \delta)$ with a fixed standard Siegel pacman $\mathcal{R}f_* = f_*$ such that the rotation angle of f_* is θ_* . Moreover, \mathcal{R} is compact, analytic, and hyperbolic. We write this operator as $\mathcal{R}: \mathcal{B} \dashrightarrow \mathcal{B}$, where $\mathcal{B} = N_{\bar{U}}(f_*, \delta)$.

The renormalization operator $\mathcal{R}: \mathcal{B} \dashrightarrow \mathcal{B}$ is hyperbolic at f_* with one-dimensional unstable manifold \mathcal{W}^u and codimension-one stable manifold \mathcal{W}^s . In a small neighborhood of f_* the stable manifold \mathcal{W}^s coincide with the set of pacmen in \mathcal{B} that have the same multiplier at the α -fixed point as f_* . Moreover, every pacman in \mathcal{W}^s is Siegel. In a small neighborhood of f_* the unstable manifold \mathcal{W}^u is parametrized by the multipliers of the α -fixed points of $f \in \mathcal{W}^u$.

Our convention is that the renormalization change of variables $\psi_f: S_f \rightarrow V$ associated with $\mathcal{R}f$ is defined near the critical value; i.e. $S_f \ni c_1(f)$ and $\psi_f(c_1(f)) = c_1(\mathcal{R}f)$. In other words, the renormalization zooms at the critical value.

By [DLS, Lemma 3.18], \mathcal{R} acts on the rotation numbers of indifferent pacmen as R_{prm}^m for some $m \geq 2$. Namely, if $f \in \mathcal{B}$ is an indifferent pacman with rotation number θ , then $\mathcal{R}f$ is again an indifferent pacman with rotation number $R_{\text{prm}}^m(\theta)$. In particular, $R_{\text{prm}}^m(\theta_*) = \theta_*$. We call m the *renormalization period* of \mathcal{R} . We will show in Proposition 5.41 that $\mathcal{R}: \mathcal{B} \dashrightarrow \mathcal{B}$ can be constructed so that m is the minimal period of θ_* under R_{prm} .

3.2.7. *Combinatorics of $\mathcal{R}: \mathcal{B} \dashrightarrow \mathcal{B}$.* Since the renormalization $\mathcal{R}f_* = f_*$ restricted to the Siegel quasidisk \bar{Z}_* is the m -th iterate of the prime renormalization, we have (see §2.1):

$$(3.3) \quad \theta_* = R_{\text{prm}}^m(\theta_*).$$

Lemma 3.1 ([DLS, Lemma 3.17]). *If $f \in \mathcal{B}$ is an indifferent pacman with a rotation number θ , then $\mathcal{R}f$ is again an indifferent pacman with rotation number $R_{\text{prm}}^m(\theta)$.*

Since the unstable manifold \mathcal{W}^u is parametrized by the multipliers of the α -fixed points, the unstable eigenvalue λ_* is equal to the derivative $(R_{\text{prm}}^m)'(\theta_*)$.

Let \mathbb{M} be the antirenormalization matrix associated with (3.3), see (2.8). Recall that \mathbb{M} has positive entries. As in §2.1.1, let \mathfrak{t} be the leading eigenvalue of \mathbb{M} . By Lemma 2.1,

$$(3.4) \quad \lambda_* = \mathfrak{t}^2.$$

3.2.8. *Operators on near Siegel maps.* Consider a Siegel map g with rotation angle θ_g . Suppose $R_{\text{prm}}^k(\theta_g) = \theta_*$ for some $k \geq 0$. Then g can be renormalized to a pacman on the stable manifold of f_* , see [DLS, Corollary 3.7 and Lemma 7.8]. This allows us to define a compact analytic renormalization operator $\mathcal{R}_{\text{Sieg}}: \mathcal{A} \rightarrow \mathcal{B}$ with $\mathcal{R}_{\text{Sieg}}(g) \in \mathcal{W}^s$, where \mathcal{A} is a small Banach neighborhood of g .

3.2.9. *Maximal prepacmen.* (Summary of [DLS, §5].) Every pacman $f \in \mathcal{W}^u$, can be anti-renormalized infinitely many times. For $n \leq 0$, we write $f_n := \mathcal{R}^n f$ and we denote by F_n the associated prepacman (obtained by cutting f_n along its critical arc γ_1). Let $\psi_n: S_n \rightarrow V$ be the renormalization change of variables realizing the

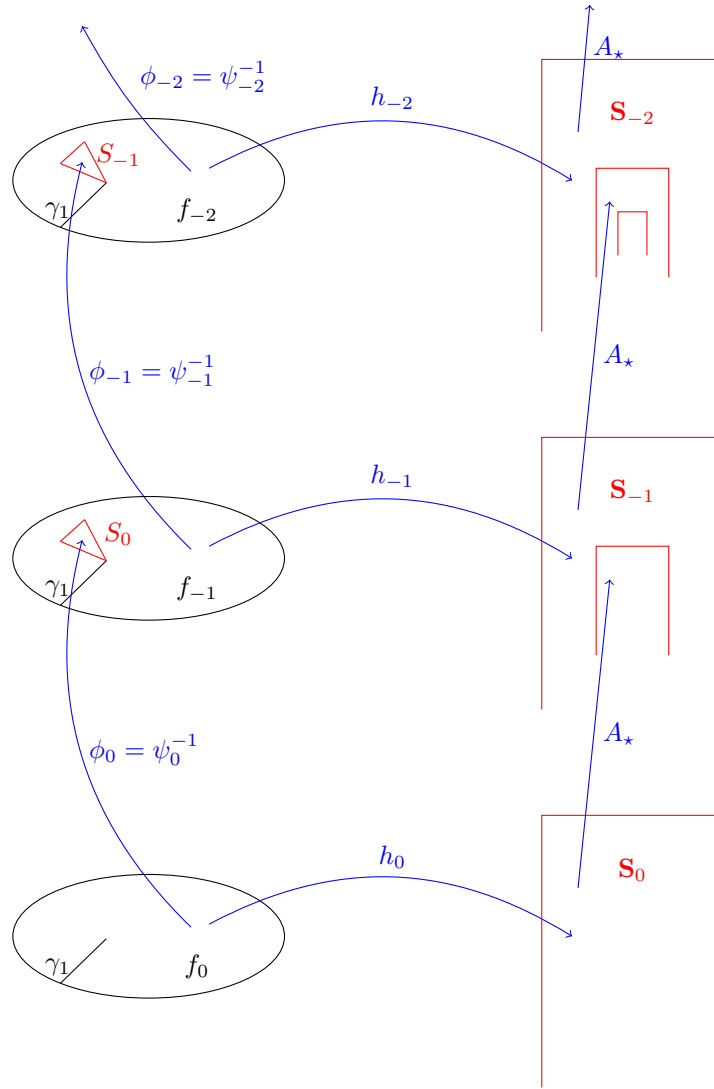

FIGURE 13. Tower of antirenormalizations.

renormalization of f_{n-1} . This means that there is a prepacman

$$\begin{aligned} F_n^{(n-1)} &= \left(f_{n,\pm}^{(n-1)} : U_{n,\pm}^{(n-1)} \rightarrow S^{(n-1)} \right) \\ &= \left(f_{n-1}^{\mathbf{a}} : U_{n,-}^{(n-1)} \rightarrow S^{(n)}, \quad f_{n-1}^{\mathbf{b}} : U_{n,+}^{(n-1)} \rightarrow S^{(n)} \right), \end{aligned}$$

in the dynamical plane of f_n such that ψ_n projects $F_n^{(n-1)}$ to f_n . We also say that ψ_n^{-1} embeds F_n to the dynamical plane of f_n , and we call $F_n^{(n-1)}$ the *embedding*.

Write

$$\begin{aligned} \psi_\star &= \psi_{f_\star}, \\ \mu_\star &:= (\psi_\star^{-1})'(c_1), \\ A_\star &: z \mapsto \mu_\star z, \\ T_n &: z \mapsto z - c_1(f_n). \end{aligned}$$

Then the limit

$$(3.5) \quad h_0(z) := \lim_{n \rightarrow -\infty} A_\star^n \circ T_{n+1} \circ (\psi_{n+1}^{-1} \circ \cdots \circ \psi_{-1}^{-1} \circ \psi_0^{-1}(z))$$

exists for all $z \in V \setminus \gamma_1$ with an extension through $\gamma_1 \setminus \{\alpha\}$. The α -fixed point is not in the domain of h_0 : as z approaches α , its image $h_0(z)$ approaches ∞ . Similarly h_n are defined for $n \leq 0$. The maps h_n linearize ψ -coordinates (see Figure 13): let

$$(3.6) \quad \mathbf{F} = (\mathbf{f}_\pm : \mathbf{U}_\pm \rightarrow \mathbf{S})$$

be the image of $F = F_0 = (f_\pm : U_\pm \rightarrow S)$ via h_0 (i.e. \mathbf{S} is the closure of $h_0(V \setminus \gamma_1)$, and $\mathbf{f}_\pm := h_0 \circ f_\pm \circ h_0^{-1}$), then $\mathbf{f}_{0,\pm}$ are iterations of $\mathbf{f}_{n,\pm}$ rescaled by A_\star^n (see (3.11) below). The map (3.6) is a prepacman (Figure 11) in $\widehat{\mathbb{C}}$ with $\alpha = \infty$.

Let $g : X \rightarrow Y$ be a holomorphic map between Riemann surfaces. Recall that g is:

- proper, if $g^{-1}(K)$ is compact for each compact $K \subset Y$;
- σ -proper (see [McM2, §8]) if each component of $g^{-1}(K)$ is compact for each compact $K \subset Y$; or equivalently if X and Y can be expressed as increasing unions of subsurfaces X_i, Y_i such that $g : X_i \rightarrow Y_i$ is proper.

A proper map is clearly σ -proper.

[DLS, Theorem 5.5] asserts that \mathbf{f}_\pm admit maximal analytic extensions to σ -proper maps of the complex plane; we call the pair of extensions

$$(3.7) \quad \mathbf{F} = (\mathbf{f}_- : \mathbf{X}_- \rightarrow \mathbb{C}, \quad \mathbf{f}_+ : \mathbf{X}_+ \rightarrow \mathbb{C}),$$

a *maximal prepacman*. The maximal extension (3.7) is obtained by iterating a certain number of times in the dynamical plane of f_k , $k \leq 0$. Namely, a big open topological disk \mathbf{D}^k around 0 in the dynamical plane of \mathbf{F} is identified via $(A_\star^k \circ h_k)^{-1}$ with a fixed disk D in the dynamical plane of f_k around the critical value $c_1(f_k)$, see Figure 14. Moreover, D also contains $f_k^{\mathbf{a}_k}(c_1)$ and $f_k^{\mathbf{b}_k}(c_1)$ for certain $\mathbf{a}_k, \mathbf{b}_k$. Let $W_-^{(k)}$ and $W_+^{(k)}$ be the pullbacks of D along the orbits $c_1, f_k(c_1), \dots, f_k^{\mathbf{a}_k}(c_1)$ and $c_1, f_k(c_1), \dots, f_k^{\mathbf{b}_k}(c_1)$ respectively. This way we obtain a pair of branched coverings (see [DLS, (5.9)])

$$(3.8) \quad (f_k^{\mathbf{a}_k} : W_-^{(k)} \rightarrow D, \quad f_k^{\mathbf{b}_k} : W_+^{(k)} \rightarrow D).$$

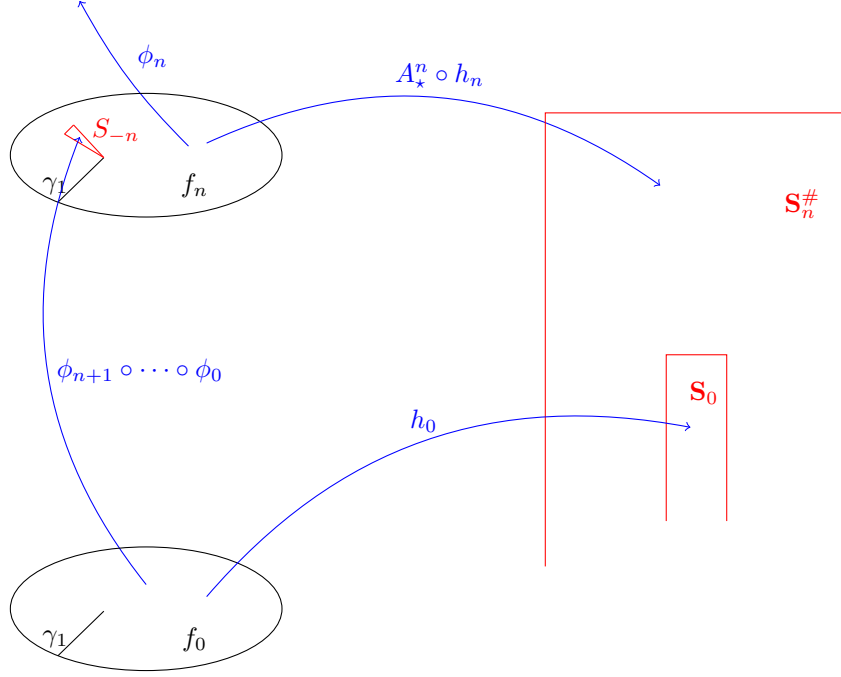

FIGURE 14. $\mathbf{S}_n^\# = A_\star^n \mathbf{S}_n$ and $\bigcup_{n \leq 0} \mathbf{S}_n^\# = \mathbb{C}$, compare with Figure 13.

(The main step is to show that the backward orbits of D in these pullbacks do not hit $\partial^{\text{frb}} U_k$, see Figure 10; this is [DLS, Key Lemma 4.8] stated as Lemma 6.2 later in the paper.) Then $A_\star^k \circ h_k$ conjugates (3.8) to the pair

$$(3.9) \quad (\mathbf{f}_- : \mathbf{W}_-^{(k)} \rightarrow \mathbf{D}^k, \quad \mathbf{f}_+ : \mathbf{W}_+^{(k)} \rightarrow \mathbf{D}^k)$$

so that $\bigcup_{k \ll 0} \mathbf{D}^k = \mathbb{C}$ and

$$\text{Dom } \mathbf{f}_- = \bigcup_{k \ll 0} \mathbf{W}_-^{(k)}, \quad \text{Dom } \mathbf{f}_+ = \bigcup_{k \ll 0} \mathbf{W}_+^{(k)}.$$

It follows from the construction that $\text{Dom } \mathbf{f}_-$ and $\text{Dom } \mathbf{f}_+$ are simply connected.

Let

$$\mathbf{F}_n^\# = (\mathbf{f}_{n,-}^\#, \mathbf{f}_{n,+}^\#) := A_\star^n \circ \mathbf{F}_n \circ A_\star^{-n}$$

be the rescaled version of \mathbf{F}_n , see Figure 14. Then $\mathbf{F}_n^\#$ is an iteration of $\mathbf{F}_{n-1}^\#$: writing the antirenormalization matrix as

$$(3.10) \quad \mathbb{M} := \begin{pmatrix} m_{1,1} & m_{1,2} \\ m_{2,1} & m_{2,2} \end{pmatrix}$$

we obtain

$$(3.11) \quad \begin{cases} \mathbf{f}_{n,-}^\# = \left(\mathbf{f}_{n-1,-}^\# \right)^{m_{1,1}} \circ \left(\mathbf{f}_{n-1,+}^\# \right)^{m_{1,2}} \\ \mathbf{f}_{n,+}^\# = \left(\mathbf{f}_{n-1,-}^\# \right)^{m_{2,1}} \circ \left(\mathbf{f}_{n-1,+}^\# \right)^{m_{2,2}} \end{cases} .$$

In particular, $\mathbf{F} = \mathbf{F}_0^\#$ is an iteration of $\mathbf{F}_n^\#$.

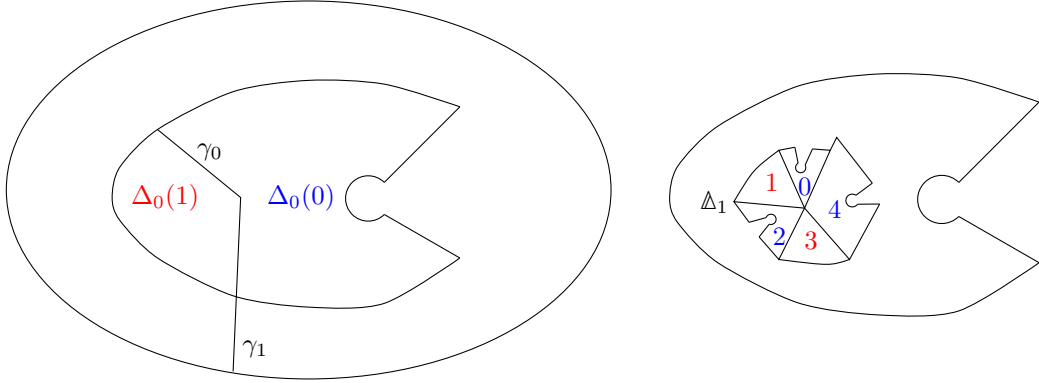

FIGURE 15. Left: the triangulation $\Delta_0 = \Delta_0(0) \cup \Delta_0(1)$. The closed triangles $\Delta_0(0)$ and $\Delta_0(1)$ are the closures of the connected components of $U \setminus (\gamma_0 \cup \gamma_1)$. Right: the triangulation $\Delta_1(f_0)$ is obtained by spreading around $\Delta_1(0, f_0)$ and $\Delta_1(1, f_0)$ – the embeddings of $\Delta_0(0, f_1)$ and $\Delta_0(1, f_1)$ into the dynamical plane of f_0 .

3.2.10. *Renormalization triangulation.* (See [DLS, §4.1] and Figure 15.) For a pac-man $f_0 \in \mathcal{B}$ its 0 th renormalization triangulation $\Delta_0(f_0)$ consists of two closed triangles $\Delta_0(0, f_0)$ and $\Delta_0(1, f_0)$ that are the closures of the connected components of $U_0 \setminus (\gamma_0 \cup \gamma_1)$. For $n > 0$, the n th renormalization triangulation $\Delta_n(f_0)$ consists of all the triangles obtained by spreading around $\Delta_n(0, f_0)$ and $\Delta_n(1, f_0)$ (compare with Figure 12), where the latter triangles are the embeddings of $\Delta_0(0, f_n)$ and $\Delta_0(1, f_n)$ to the dynamical plane of f_0 . We also say that $\Delta_n(f_0)$ is the *full lift* of $\Delta_0(f_n)$. [DLS, Theorem 4.6] asserts that $\Delta_m(f)$ approximates \overline{Z}_* dynamically and geometrically.

More precisely, suppose $f_0 \in \mathcal{B}$ is renormalizable $m \geq 1$ times. We write

$$\phi_k := \psi_k^{-1}.$$

The map

$$\Phi_m := \phi_1 \circ \phi_2 \circ \cdots \circ \phi_m$$

admits a conformal extension from a neighborhood of $c_1(f_m)$ (where Φ_m is defined canonically) to $V \setminus \gamma_1$. The map $\Phi_m: V \setminus \gamma_1 \rightarrow V$ embeds the prepacman F_m to the dynamical plane of f_0 ; we denote the embedding by

$$\begin{aligned} F_m^{(0)} &= \left(f_{m,\pm}^{(0)}: U_{m,\pm}^{(0)} \rightarrow S_m^{(0)} \right) \\ &= \left(f_0^{\mathbf{a}_m}: U_{m,-}^{(0)} \rightarrow S_m^{(0)}, \quad f_0^{\mathbf{b}_m}: U_{m,+}^{(0)} \rightarrow S_m^{(0)} \right), \end{aligned}$$

where the numbers $\mathbf{a}_m, \mathbf{b}_m$ are the renormalization return times satisfying

$$(3.12) \quad (\mathbf{a}_m, \mathbf{b}_m) = (\mathbf{a}, \mathbf{b}) \mathbb{M}^{m-1} = (1, 1) \mathbb{M}^m, \quad \mathbf{a} = \mathbf{a}_1, \quad \mathbf{b} = \mathbf{b}_1.$$

Write $\Delta_m(0, f_0) := \overline{U_{m,+}^{(0)}}$ and $\Delta_m(1, f_0) := \overline{U_{m,-}^{(0)}}$. Then Δ_m consists of triangles $\{f_0^i(\Delta_m(0, f_0)) \mid i \in \{0, 1, \dots, \mathbf{a}_m - 1\}\} \cup \{f_0^i(\Delta_m(1, f_0)) \mid i \in \{0, 1, \dots, \mathbf{b}_m - 1\}\}$. We enumerate counterclockwise these triangles as $\Delta_m(i)$ with $i \in \{0, 1, \dots, \mathbf{q}_m - 1\}$. By construction, $\Delta_m(0, 1) := \Delta_m(0) \cup \Delta_m(1)$ contains the critical value c_1 , while

$\Delta_m(-\mathbf{p}_m, -\mathbf{p}_m + 1)$ contains the critical point, where $\mathbf{p}_m/\mathbf{q}_m$ is the *combinatorial rotation number* of $f \mid \Delta_m$.

We have:

$$(3.13) \quad \Delta_n(f) \Subset \Delta_{n-1}(f) \Subset \cdots \Subset \Delta_1(f) \Subset \Delta_1(f) \cup S_f \Subset \Delta_0(f),$$

and renormalization sector S_f is disjoint from γ_1 away from a small neighborhood of α .

3.2.11. *Walls \mathbb{P}_n of Δ_n .* Consider the dynamical plane of a pacman f . By a *univalent N -wall* we mean a closed annulus A surrounding an open disk O containing α , such that $f \mid O \cup A$ is univalent, and for every $z \in O$, we have $(f \mid A \cup O)^{\pm k}(z) \in A \cup O$ for $k \in \{0, 1, \dots, N\}$. In other words, it takes at least N iterates for a point in O to cross A . An *N -wall* is an annulus A surrounding an open disk O containing α such that A contains a univalent N -wall. A wall A *respects* γ_0, γ_1 if $A \cap \gamma_0$ and $A \cap \gamma_1$ are two arcs.

Let us define the wall $\mathbb{P}_n(f)$ of Δ_n ; the wall approximates ∂Z_\star just like $\Delta_n(f)$ approximates \bar{Z}_\star . In the dynamical plane of f_\star consider its Siegel disk Z_\star . It is foliated by equipotentials parametrized by their heights ranging from 0 (the height of α) to 1 (the height of ∂Z_\star). Fix an $r \in (0, 1)$ and consider the open subdisk Z^r of Z_\star bounded by the equipotential at height r . Consider next $f \in \mathcal{W}^u$ close to f_\star . Then $\gamma_0(f)$ and $\gamma_1(f)$ still intersect ∂Z^r at single points. The *wall $\mathbb{P}_0(f)$ of $\Delta_0(f)$* is the closed annulus $\Delta_0(f) \setminus Z^r$ consisting of rectangles

$$\Pi_0(0) = \mathbb{P}_0 \cap \Delta_0(0) \text{ and } \Pi_0(1) = \mathbb{P}_0 \cap \Delta_0(1).$$

Suppose that f_n with $n > 0$ is sufficiently close to f_\star so that $\mathbb{P}_0(f_n)$ is defined. Let $\Pi_n(0, f_0)$ and $\Pi_n(1, f_0)$ be the embedding of the rectangles $\Pi_0(0, f_n)$ and $\Pi_0(1, f_n)$ into the dynamical plane of f_0 , see [DLS, Lemma 4.2, (2)]. The *wall $\mathbb{P}_n = \mathbb{P}_n(f)$ of $\Delta_n(f)$* is obtained by spreading around $\Pi_n(0, f_0)$ and $\Pi_n(1, f_0)$. The wall \mathbb{P}_n consists of rectangles $\Pi_n(i) = \mathbb{P}_n \cap \Delta_n(i)$. We have $\mathbb{P}_n(f_0) \Subset \mathbb{P}_{n-1}(f_0)$ is an annulus approximating ∂Z_\star and, moreover, the dynamics $f \mid (\Delta_n \setminus \mathbb{P}_n)$ is univalent.

3.2.12. *Siegel triangulation.* Consider a pacman f close to f_\star and let $\gamma_1^{\text{new}}, \gamma_0^{\text{new}}$ be a new “dividing” pair (similar to §2.3.11) that is coincide with γ_0, γ_1 on \mathbb{P}_0 ; i.e.:

$$\gamma_0^{\text{new}} = f(\gamma_1^{\text{new}}), \quad \gamma_0^{\text{new}} \cap \gamma_1^{\text{new}} = \{\alpha\}, \quad \gamma_i^{\text{new}} \cap \mathbb{P}_0 = \gamma_i.$$

Let Δ_0^{new} be the associated new triangulation consisting of the closures of $U_f \setminus (\gamma_0^{\text{new}} \cup \gamma_1^{\text{new}})$. Such Δ_0^{new} will appear in Theorem 4.7 as the projection of a fundamental domain and will be used in Theorem 8.2 to select $\gamma_0^{\text{new}} \setminus \{\alpha\}, \gamma_1^{\text{new}} \setminus \{\alpha\}$ away from a valuable flower. Lemma 4.3 from [DLS] (see also Proposition 2.10) asserts that if $f = \mathcal{R}^n(f_{-n})$, then $\Delta_0^{\text{new}}(f)$ has the full lift $\Delta_n^{\text{new}}(f_{-n})$ with $\mathbb{P}_n^{\text{new}}(f_{-n}) = \mathbb{P}_n(f_{-n})$ just like Δ_n is the full lift of Δ_0 . Moreover, the assumption “ $\gamma_i^{\text{new}} \cap \mathbb{P}_0 = \gamma_i$ ” can be relaxed into “ $\gamma_i^{\text{new}} \cap \mathbb{P}_0$ is sufficiently close to γ_i .”

We will also consider triangulations that are small perturbations of Δ_n^{new} . A *Siegel triangulation Δ* is a triangulated neighborhood of α consisting of closed triangles, each has a vertex at α , such that

- triangles of Δ are $\{\Delta(i)\}_{i \in \{0, \dots, q-1\}}$ enumerated counterclockwise around α so that $\Delta(i)$ intersects only $\Delta(i-1)$ (on the right) and $\Delta(i+1)$ (on the left); $\Delta(i)$ and $\Delta(i+j)$ are disjoint away from α for $j \notin \{-1, 0, 1\}$;
- there is a $\mathbf{p} > 0$ such that f maps $\Delta(i)$ to $\Delta(i+\mathbf{p})$ for all $i \notin \{-\mathbf{p}, -\mathbf{p}+1\}$;

- Δ has a distinguished 2-wall \mathbb{I} enclosing α and containing $\partial\Delta$ such that each $\Pi(i) := \mathbb{I} \cap \Delta(i)$ is connected and f maps $\Pi(i)$ to $\Pi(i + \mathbf{p})$ for all $i \notin \{-\mathbf{p}, -\mathbf{p} + 1\}$; and
- \mathbb{I} contains a univalent 2-wall Q such that each $Q(i) := Q \cap \Pi(i)$ is connected and f maps $Q(i)$ to $Q(i + \mathbf{p})$ for all $i \notin \{-\mathbf{p}, -\mathbf{p} + 1\}$.

We say that \mathbb{I} *approximates* ∂Z_\star if ∂Z_\star is a concatenation of short arcs $J_0 J_1 \dots J_{q-1}$ such that $\Pi(i)$ and J_i are close in the Hausdorff topology.

Lemma 3.2 ([DLS, Lemma 4.4]). *Let $f \in \mathcal{B}$ be a pacman such that all $f, \mathcal{R}f, \dots, \mathcal{R}^n f$ are in a small neighborhood of f_\star . Let $\Delta(\mathcal{R}^n f)$ be a Siegel triangulation in the dynamical plane of $\mathcal{R}^n f$ such that $\mathbb{I}(\mathcal{R}^n f)$ approximates ∂Z_\star . Then $\Delta(\mathcal{R}^n f)$ has a full lift $\Delta(f)$ which is again a Siegel triangulation. Moreover, $\mathbb{I}(f)$ also approximates ∂Z_\star .*

More generally, $\Delta(f)$ can be lifted under a renormalization $\mathcal{R}_{\text{Siegel}}: \mathcal{A} \rightarrow \mathcal{B}$ defined on near-Siegel maps (see §3.2.8) assuming that $\mathbb{I}(f)$ sufficiently approximates ∂Z_\star . In the proof, we first lift \mathbb{I} (it has a lift because \mathbb{I} approximates ∂Z_{f_\star}), and then extend the lift into $\Delta \setminus \mathbb{I}$ (see Proposition 2.10). If $f_0 \in \mathcal{W}^u$ has a Siegel triangulation $\Delta(f_0)$, then $\Delta(f_0)$ has a full lift $\Delta(f_n)$ converging to \bar{Z}_\star as $n \rightarrow -\infty$.

3.2.13. *Renormalization change of variables near c_0 .* We will consider in §9.3 the renormalization change of variables ψ_0 defined on a neighborhood of the critical point c_0 ; i.e. $\psi_0(c_0(f)) = c_0(f_1)$ and ψ_0 projects the first return of f to $f_1 = \mathcal{R}f$. If $\psi: S \rightarrow V$ is the renormalization change of variables near the critical value as above, then ψ_0 is uniquely characterized by

$$\psi \circ f = f_1 \circ \psi_0.$$

We have $\text{Dom } \psi_0 = f^{-1}(S)$ and $\text{Im } \psi_0 = \text{Dom } f_1$.

3.2.14. *Parabolic pacmen.* (See [DLS, §6]) In a small neighborhood of f_\star consider a parabolic pacman $f_\tau \in \mathcal{W}^u$ with rotation number $\tau = \mathbf{p}/\mathbf{q}$ close to θ_\star . We denote by H_0 a small attracting parabolic flower around α . Petals in H_0 are enumerated counterclockwise as H_0^i with $i \in \{0, 1, \dots, \mathbf{q} - 1\}$

We assume that H_0 is small enough so that $H_0 \subset V \setminus \gamma_1$, possibly up to a slight rotation of γ_1 . Therefore, the flower H_0 lifts to the dynamical plane of \mathbf{F}_τ via the identification $V \setminus \gamma_1 \simeq \text{int } \mathbf{S}$; we denote by \mathbf{H}_0 the lift. The *global attracting basin* \mathbf{H} of \mathbf{F}_τ is the full orbit of \mathbf{H}_0 . There are Fatou coordinates in \mathbf{H}_0 ; globalizing the Fatou coordinates we obtain that $0 \in \mathbf{H}$. [DLS, Proposition 6.5] parametrizes periodic components of \mathbf{H} as \mathbf{H}^i from left-to-right with $0 \in \mathbf{H}^0$, see Figure 33. Every petal \mathbf{H}^i is an open topological disk in $\widehat{\mathbf{C}}$. By re-enumerating, we assume that the lift \mathbf{H}_0^0 of H_0^0 is contained in \mathbf{H}^0 . Note that \mathbf{H}_0^0 is disjoint from $\partial\mathbf{H}^0$. The actions of $\mathbf{f}_{n,\pm}^\#$ on $(\mathbf{H}^i)_{i \in \mathbb{Z}}$ are given by (see [DLS, (6.7)])

$$(3.14) \quad \mathbf{f}_{n,-}^\#(\mathbf{H}^i) = \mathbf{H}^{i-\mathbf{p}n} \quad \text{and} \quad \mathbf{f}_{n,+}^\#(\mathbf{H}^i) = \mathbf{H}^{i+\mathbf{q}n-\mathbf{p}n},$$

where $\mathbf{p}_n/\mathbf{q}_n$ is the rotation number of f_n .

3.2.15. *The molecule map.* (See [DLS, Appendix C].) Consider a primary \mathbf{p}/\mathbf{q} -limb $\mathcal{L}_{\mathbf{p}/\mathbf{q}}$ of the Mandelbrot set. In the dynamical plane of $p \in \mathcal{L}_{\mathbf{p}/\mathbf{q}}$ there are exactly \mathbf{q} external rays landing at the α -fixed point; these rays are permuted as \mathbf{p}/\mathbf{q} . We can apply the Branner–Douady surgery [BD] and delete the smallest sector between external rays $\gamma, p(\gamma)$ landing at α (as with the prime renormalization of a rotation);

the result is a map $\mathbf{R}_{\text{prm}}(p) \in \mathcal{L}_{R_{\text{prm}}(\mathfrak{p}/\mathfrak{q})}$, where $R_{\text{prm}}(\mathfrak{p}/\mathfrak{q})$ is defined in (2.3). This defines a partial continuous map $\mathbf{R}_{\text{prm}}: \mathcal{L}_{\mathfrak{p}/\mathfrak{q}} \dashrightarrow \mathcal{L}_{R_{\text{prm}}(\mathfrak{p}/\mathfrak{q})}$ whose inverse is an embedding of $\mathcal{L}_{R_{\text{prm}}(\mathfrak{p}/\mathfrak{q})}$ into $\mathcal{L}_{\mathfrak{p}/\mathfrak{q}}$. If $\mathfrak{p}/\mathfrak{q} = 1/2$, then $\mathbf{R}_{\text{prm}}: \mathcal{L}_{1/2} \dashrightarrow \mathcal{L}_{0/1} = \mathcal{M}$ is the canonical homeomorphism between $\mathcal{M}_{1/2}$ and \mathcal{M} .

The *molecule map* is obtained by taking all $\mathbf{R}_{\text{prm}}: \mathcal{L}_{\mathfrak{p}/\mathfrak{q}} \dashrightarrow \mathcal{L}_{R_{\text{prm}}(\mathfrak{p}/\mathfrak{q})}$ and extending continuously \mathbf{R}_{prm} to the boundary of the main hyperbolic component $\partial\Delta$. The molecule map is a 3-to-1 partial map $\mathbf{R}_{\text{prm}}: \mathcal{M} \dashrightarrow \mathcal{M}$; its domain depends on the choices of the rays γ . However, on the boundary of main molecule, \mathbf{R}_c is defined canonically and is semiconjugate to $q(z) = z(z+1)^2$ restricted to its Julia set, see the figure. The *Molecule Conjecture* asserts that this is in fact a conjugacy and, moreover, there is a hyperbolic renormalization operator associated with the molecule map.

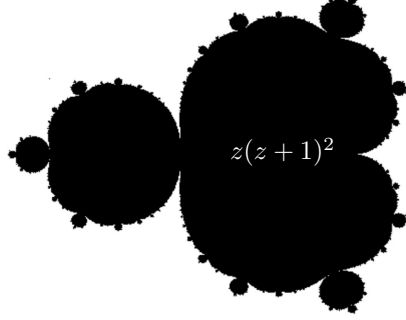

4. DYNAMICS OF MAXIMAL PREPACMEN

Recall from §3.2.9 that every pacman $f \in \mathcal{W}^u$ has the associated maximal prepacmen $\mathbf{F} = (\mathbf{f}_-, \mathbf{f}_+)$ consisting of two σ -proper maps. We define $\mathcal{W}_{\text{loc}}^u \simeq \mathcal{W}^u$ to be the space of maximal prepacmen arising this way.

The renormalization operator on $\mathcal{W}_{\text{loc}}^u$ is an iteration and rescaling by A_\star : there are $m_{1,1}, m_{1,2}, m_{2,1}, m_{2,2} \geq 1$ such that (see (3.11))

$$(4.1) \quad \begin{cases} \mathbf{f}_{n,-}^\# = \left(\mathbf{f}_{n-1,-}^\# \right)^{m_{1,1}} \circ \left(\mathbf{f}_{n-1,+}^\# \right)^{m_{1,2}} \\ \mathbf{f}_{n,+}^\# = \left(\mathbf{f}_{n-1,-}^\# \right)^{m_{2,1}} \circ \left(\mathbf{f}_{n-1,+}^\# \right)^{m_{2,2}} \end{cases} .$$

In particular, $\mathbf{F} = \mathbf{F}_0^\#$ is an iteration of $\mathbf{F}_n^\#$. Recall from (3.10) that the antirenormalization matrix is defined by

$$(4.2) \quad \mathbb{M} := \begin{pmatrix} m_{1,1} & m_{1,2} \\ m_{2,1} & m_{2,2} \end{pmatrix} .$$

Clearly, if

$$(4.3) \quad (c, d) = (a, b) \mathbb{M},$$

then

$$(4.4) \quad \left(\mathbf{f}_{n,-}^\# \right)^a \circ \left(\mathbf{f}_{n,+}^\# \right)^b = \left(\mathbf{f}_{n-1,-}^\# \right)^c \circ \left(\mathbf{f}_{n-1,+}^\# \right)^d .$$

We denote by \mathfrak{F} the tower $(\mathbf{F}_n)_{n \leq 0}$ and we denote by $\mathfrak{F}^\#$ the rescaled tower $(\mathbf{F}_n^\#)_{n \leq 0}$.

We can now globalize $\mathcal{W}_{\text{loc}}^u$ as follows. The operator $\mathcal{R}: \mathcal{W}_{\text{loc}}^u \dashrightarrow \mathcal{W}_{\text{loc}}^u$ is conjugate, say via \mathbf{h} , to $v \mapsto \lambda_\star v$ in a neighborhood of \mathbf{F}_\star so that $\mathbf{h}(\mathbf{F}_\star) = 0$. Using (4.4), we inductively define $\mathbf{F}_n^\#$ for all $n \geq 0$ and all \mathbf{F}_0 in a neighborhood of \mathbf{F}_\star . Note that the domain of $\mathbf{F}_n^\#$ needs not be connected. Define $\mathbf{F}_n = \mathcal{R}^n \mathbf{F}$ to be $A_\star^{-n} \circ \mathbf{F}_n^\# \circ A_\star^n$ and set $\mathbf{h}(\mathbf{F}_n) := \lambda_\star^n \mathbf{h}(\mathbf{F}_0)$. We enlarge $\mathcal{W}_{\text{loc}}^u$ by adding all new maximal prepacmen $\{\mathbf{F}_n\}$. Then \mathbf{h} parameterizes \mathcal{W}^u by \mathbb{C} ; i.e. the new operator $\mathcal{R}: \mathcal{W}^u \rightarrow \mathcal{W}^u$ is globally conjugate to $v \mapsto \lambda_\star v: \mathbb{C} \rightarrow \mathbb{C}$.

4.1. **\mathcal{W}^u as a geometric limit of the quadratic slice.** The space \mathcal{W}^u naturally arises as the set of limits of rescaled iterations of quadratic polynomials. Let us write $c_\star := c(\theta_\star)$ and let us change the normalization of $p_c(z) := z^2 + c$ by putting the critical value and the parameter c_\star at 0:

$$g_c := T_{c+c_\star}^{-1} \circ p_{c+c_\star} \circ T_{c+c_\star}.$$

Using the hyperbolicity of \mathcal{R} , it is possible to show that the limit

$$\mathbf{F}_c = \lim_{n \rightarrow +\infty} A_\star^{-n} \circ \left(g_{c\lambda_\star^{-n}}, g_{c\lambda_\star^{-n}}^{\mathbf{b}_n} \right) \circ A_\star^n$$

exists and defines the parameterization of \mathcal{W}^u by c such that $\mathcal{R}\mathbf{F}_c = \mathbf{F}_{c\lambda_\star}$. The existence of the limit for $c = 0$ is shown in [McM1, Theorem 8.1, Claim 7].

Therefore, a zoomed picture of the Mandelbrot set near f_{c_\star} gives a good approximation of \mathcal{W}^u , see Figure 16. Similarly, a zoomed picture of $f_{c_\star + \lambda_\star^{-n}c}$ near the critical value gives a good approximation of \mathbf{F}_c . This will help us to illustrate by pictures different constructions in the parameter and dynamical planes.

Let us denote by Δ the *main hyperbolic component* of \mathcal{W}^u : the set of maximal prepacmen $\mathbf{F} \in \mathcal{W}^u$ such that the α -fixed point of f_n is attracting for $n \ll 0$. Then Δ is the rescaled limit of the main hyperbolic component of the Mandelbrot set and $\partial\Delta$ is a straight line passing through 0.

4.2. **Power-triples.** (Compare with §2.1.2.) A *power-triple* is a triple $(n, a, b) \in \mathbb{Z} \times \mathbb{Z}_{\geq 0}^2$. Given a power-triple $P = (n, a, b)$, we write

$$\mathbf{F}^P := \left(\mathbf{f}_{n,-}^\# \right)^a \circ \left(\mathbf{f}_{n,+}^\# \right)^b;$$

\mathbf{F}^P is a σ -proper map; however its domain needs not be connected.

If a, b, c, d satisfy (4.3), then we say that (n, a, b) and $(n-1, c, d)$ are *equivalent power-triples*. This generates the equivalence relation “ \simeq ” on the set of power-triples; we will usually consider power-triples up to this natural equivalence relation. By construction, \mathbf{F}^P depends only on the equivalence class of P .

Let P, Q be two power-triples. For every $n \ll 0$, there are a, b, c, d such that $P \simeq (n, a, b)$ and $Q \simeq (n, c, d)$. We set

$$P + Q \simeq (n, a + c, b + d).$$

Then

$$\mathbf{F}^{P+Q} = \mathbf{F}^P \circ \mathbf{F}^Q.$$

We denote by \mathbb{T} the commutative semigroup consisting of the equivalence classes of power-triples with the operation “+.” We denote by $0 \simeq (n, 0, 0)$ the *zero power-triple*: $\mathbf{F}^0 = \text{id}$.

For $P, Q \in \mathbb{T}$ we say that $P \geq Q$ if for every sufficiently big $n \ll 0$ the following holds. Write $P \simeq (n, a, b)$ and $Q \simeq (n, c, d)$. Then $a \geq c$ and $b \geq d$. Clearly, \geq is a well defined order on \mathbb{T} . The next lemma is a consequence of Lemma 2.2:

Lemma 4.1. *For every $P, Q \in \mathbb{T}$ either $P \geq Q$ or $P \leq Q$ holds. There is an order-preserving embedding*

$$\iota: (\mathbb{T}, +, \geq) \hookrightarrow (\mathbb{R}_{\geq 0}, +, \geq)$$

and there is a $t > 1$ such that

$$\iota(n-1, a, b) = \iota(n, a, b)/t$$

for all $a, b \geq 0$. □

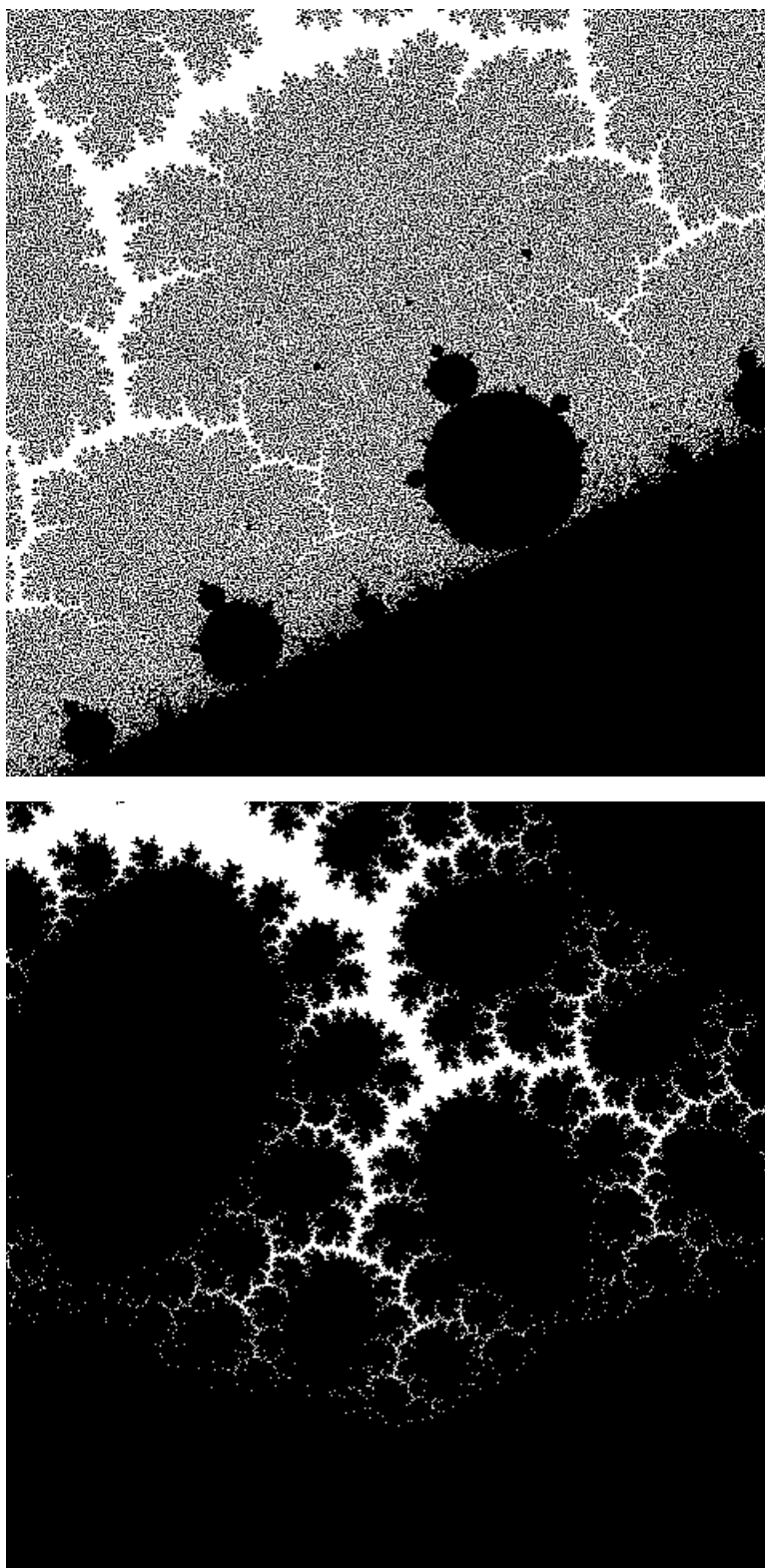

FIGURE 16. Approximations of \mathcal{W}^u (top) and of the maximal prepacmen \mathbf{F}_* (bottom), see §4.1. Note that the white set between limbs disappears in the limit.

From now on, we fix the order-preserving embedding $\mathbb{T} \subset \mathbb{R}_{\geq 0}$ as in Lemma 4.1 and we write $(n, a, b)/\mathfrak{t} := (n-1, a, b)$.

We denote by $\mathbf{F}^{\geq 0}$ the *cascade* $(\mathbf{F}^P)_{P \in \mathbb{T}}$. It follows from (4.1) that

$$(4.5) \quad \mathbf{F}_0^P = \left(\mathbf{F}_{-n}^\# \right)^{\iota^n P}.$$

If $\mathbf{F} = \mathbf{F}_\star$, then (4.5) takes form

$$(4.6) \quad \mathbf{F}_\star^P = A_\star^{-n} \circ \left(\mathbf{F}_\star^{\iota^n P} \right) \circ A_\star^n.$$

4.3. Renormalization triangulations. Recall from §3.2.10 that the triangulation $\Delta_{-n}(f_n)$ is the full lift of $\Delta_0(f_0)$. For \mathbf{F} close to \mathbf{F}_\star we define the renormalization triangulation $\Delta_0(\mathbf{F})$ to be the full lift of $\Delta_0(f_0)$ to the dynamical plane of \mathbf{F}_\star . More precisely, consider

$$(4.7) \quad \mathbf{f}_- : \mathbf{U}_- \rightarrow \mathbf{S}, \quad \mathbf{f}_+ : \mathbf{U}_+ \rightarrow \mathbf{S},$$

see (3.6), and note that this realizes the first return map of points in $\overline{\mathbf{U}}_\pm$ back to \mathbf{S} under the cascade $\mathbf{F}^{\geq 0}$ because (4.7) is the first return map under $\mathbf{f}_{n,\pm}^\# : \mathbf{U}_{n,\pm}^\# \rightarrow \mathbf{S}_n^\#$ for all $n \leq 0$. Then $\Delta = \Delta_0(\mathbf{F})$ is obtained by spreading around $\Delta_0(0) := \overline{\mathbf{U}}_+$ and $\Delta_0(1) := \overline{\mathbf{U}}_-$; i.e. Δ_0 consists of triangles

$$\{ \mathbf{F}^P(\Delta_0(0)) \mid P < (0, 0, 1) \} \cup \{ \mathbf{F}^P(\Delta_0(1)) \mid P < (0, 1, 0) \}.$$

We enumerate triangles in $\Delta_0(\mathbf{F})$ as $(\Delta_0(i, \mathbf{F}))_{i \in \mathbb{Z}}$ from left-to-right so that

$$\Delta_0(0, \mathbf{F}) = \overline{\mathbf{U}}_+ \quad \text{and} \quad \Delta_0(1, \mathbf{F}) = \overline{\mathbf{U}}_-,$$

see Figure 17. The triangulation $\Delta_0(\mathbf{F})$ depends holomorphically on \mathbf{F} .

Lemma 4.2. *Every $\Delta_0(i)$ is a triangle in $\widehat{\mathbb{C}}$ with a vertex at ∞ . For every compact subset $X \subset \mathbb{C}$, there are at most finitely many triangles in Δ_0 intersecting X .*

Proof. Since $\Delta_0(\mathbf{F})$ depends holomorphically on \mathbf{F} in a small neighborhood of \mathbf{F}_\star , it is sufficient to prove the lemma for \mathbf{F}_\star .

For f_\star , the map $h_\star := h_0$ (see (3.5)) is the linearizer of ψ_\star (the renormalization change of variables associated with $f_\star = \mathcal{R}f_\star$). This implies that $\mathbf{S}_\star, \mathbf{U}_{\star,\pm}$, and all $\Delta(i, \mathbf{F}_\star)$ are triangles of $\widehat{\mathbb{C}}$ with a vertex at ∞ , see Figure 13.

Since triangles of $\Delta_n(f_\star)$ intersect Z_\star along its internal rays, we can slightly rotate γ_1 so that the new γ_1^{new} intersects $\Delta_n(f_\star)$ along the boundary of a certain triangle in $\Delta_n(f_\star)$. Let us cut $\Delta_n(f_\star)$ along γ_1^{new} and embed using $A_\star^{-n} \circ h_\star$ the obtained triangulation to the dynamical plane of \mathbf{F}_\star ; we denote by $\Delta_0^{(n)}(\mathbf{F}_\star)$ the embedding. Let us also denote by $\mathbf{S}_{\text{new},-n}^\#$ the closure of $A_\star^{-n} \circ h_\star(V \setminus \gamma_1^{\text{new}})$, compare with Figure 14.

Then $\Delta_0^{(n)}(\mathbf{F}_\star) \subset \Delta_0^{(n+1)}(\mathbf{F}_\star)$, and the union of $\Delta_0^{(n)}(\mathbf{F}_\star)$ is $\Delta_0(\mathbf{F}_\star)$. Moreover,

$$\Delta_0^{(n)} = \mathbf{S}_{\text{new},-n}^\# \cap \Delta_0.$$

Since $\mathbf{S}_{\text{new},-n}^\#$ contains a disk around 0 with a big radius for $n \ll 0$, we have $X \subset \mathbf{S}_{\text{new},-n}^\#$ for $n \ll 0$. \square

The n th renormalization triangulation $\Delta_n(\mathbf{F})$ is $\Delta_0(\mathbf{F}_n^\#) = A_\star^n(\Delta_0(\mathbf{F}_n))$.

From now on we assume that \mathcal{W}^u is chosen in a sufficiently small neighborhood of f_\star so that every $f \in \mathcal{R}^{-n}(\mathcal{W}^u)$ has a renormalization triangulation $\Delta_n(f)$ and every $\mathbf{F} \in \mathcal{R}^{-n}(\mathcal{W}_{\text{loc}}^u)$ has a renormalization triangulation $\Delta_n(\mathbf{F})$ for $n \geq 0$.

For $\mathbf{F} \in \mathcal{W}^u$, the triangulation $\Delta_n(\mathbf{F})$ is defined for all sufficiently big $n \ll 0$. We have

$$(4.8) \quad \bigcup_{m \ll 0} \Delta_m(j, \mathbf{F}) = \mathbb{C} \quad \text{if } \Delta_0(j, \mathbf{F}_*) \ni 0.$$

Moreover,

$$(4.9) \quad \mathbf{S} \setminus \Delta_0(0, 1) \subset \Delta_{-1}(0, 1).$$

because $S_f \setminus \Delta_1(f) \Subset V \setminus \gamma_1$, see (3.13).

Given a set $K \subset U_f$ in the dynamical plane of $f \in \mathcal{W}^u$, the *full lift* \mathbf{K} of K to the dynamical plane of \mathbf{F} is defined as follows. Write

$$K_0 := K \cap \Delta_0(0, f), \quad \text{and } K_1 := K \cap \Delta_0(1, f).$$

(Recall that the triangles of $\Delta_0(f)$ are closed thus $K = K_- \cup K_+$). Let \mathbf{K}_0 and \mathbf{K}_1 be the embeddings of K_0 and K_1 to the dynamical plane of \mathbf{F} via $\mathbf{S} \simeq V \setminus \gamma_1$. Then

$$\mathbf{K} := \bigcup_{0 \leq P < (0,0,1)} \mathbf{F}^P(\mathbf{K}_0) \quad \bigcup_{0 \leq P < (0,1,0)} \mathbf{F}^P(\mathbf{K}_1).$$

In the dynamical plane of \mathbf{F}_* , we define its *Siegel disk* \mathbf{Z}_* to be the full lift of Z_* (the Siegel disk of f_*). Then \mathbf{Z}_* is a forward invariant unbounded open disk.

For every $N > 1$, if $f \in \mathcal{W}^u$ is sufficiently close f_* , then the wall $\mathbb{I}_0(f)$ contains a univalent N -wall A (see §3.2.11) respecting γ_0, γ_1 . The full lift of a univalent N -wall of $\mathbb{I}_0(f_n)$ is a univalent $N - 1$ wall in $\mathbb{I}_0(f_0)$.

4.4. Rational and critical points. A point x is *periodic* if $\mathbf{F}^P(x) = x$ for a power-triple $P > 0$. It will follow from Lemma 4.4 that every periodic point has a unique minimal *period* $P \in \mathbb{T}$. If P is the minimal period of x , then the *multiplier* of x is $(\mathbf{F}^P)'(x)$. Periodic and preperiodic points are called *rational*.

A *critical point* of a cascade $\mathbf{F}^{\geq 0}$ is a critical point of some \mathbf{F}^P for $P \in \mathbb{T}$. The following lemma describes basic properties of critical points.

Lemma 4.3. *Consider $\mathbf{F} \in \mathcal{W}^u$. Then x is a critical point of $\mathbf{F}^{\geq 0}$ if and only if there is a $P > 0$ such that $\mathbf{F}^P(x) = 0$. The set of critical points $\text{CP}(\mathbf{F}^P)$ of \mathbf{F}^P is $\bigcup_{0 < S \leq P} \mathbf{F}^{-S}(0)$. The set of critical values $\text{CV}(\mathbf{F}^P)$ of \mathbf{F}^P is $\{\mathbf{F}^S(0) \mid S < P\}$. The postcritical set $\mathfrak{P}(\mathbf{F})$ of \mathbf{F}^P is the forward orbit of 0.*

Write $K := \min\{(0, 1, 0), (0, 0, 1)\}$. Then

$$(4.10) \quad \text{CV}(\mathbf{G}^P) \setminus \{0\} \subset \Delta_0(\mathbf{G}) \setminus \mathbf{S} \quad \text{for } P < K \quad \text{and } \mathbf{G} \in \mathcal{W}_{\text{loc}}^u.$$

For every $P < K$, the set $\text{CV}(\mathbf{G}^P)$ moves holomorphically with $\mathbf{G} \in \mathcal{W}_{\text{loc}}^u$, and every critical point of \mathbf{G}^P has degree 2 for $\mathbf{G} \in \mathcal{W}_{\text{loc}}^u$.

For every $\mathbf{F} \in \mathcal{W}^u$, there is a $K_{\mathbf{F}} > 0$ such that every critical point of \mathbf{G}^P has degree 2 for $P < K_{\mathbf{F}}$.

For every $\mathbf{F} \in \mathcal{W}^u$ and every $P \in \mathbb{T}$, there exists $k \in \mathbb{N}$ such that the degree of every critical point of \mathbf{F}^P is at most k . If 0 is not periodic, then the degree of every critical point of \mathbf{F}^P is 2.

The first claim is essentially [DLS, Lemma 6.1].

Proof. Let $\mathbf{W} \Subset \mathbb{C}$ be an open topological disk, and let \mathbf{W}_1 be a connected component of $\mathbf{F}^{-P}(\mathbf{W})$. For $n \ll 0$, the map $\mathbf{F}^P: \mathbf{W}_1 \rightarrow \mathbf{W}$ is identified via $A_*^k \circ h_k: V \setminus \gamma_1 \rightarrow \mathbf{S}_k^\#$ with $f_n^{\mathfrak{s}(k)}: W_1 \rightarrow W$ for some $\mathfrak{s}(k) \geq 0$ because $A_*^k \circ h_k$ conjugates (3.8) and (3.9), see §3.2.9. Therefore, $z \in \mathbf{W}_1$ is a critical point of \mathbf{F}^P

if and only if the f_k -orbit of $(A_*^k \circ h_k)^{-1}(z)$ passes through 0 during the first $s(k)$ iterates. This is equivalent to $\mathbf{F}^S(z) = 0$ for some positive $S \leq P$. The degree of \mathbf{F}^P at z is 2^t , where t is the number of positive $S \leq P$ with $\mathbf{F}^S(z) = 0$.

The claims about $\text{CP}(\mathbf{F}^P)$, $\text{CV}(\mathbf{F}^P)$ and $\mathfrak{P}(\mathbf{F})$ are immediate.

For $\mathbf{G} \in \mathcal{W}_{\text{loc}}^u$ and $P \leq K$, the point $\mathbf{G}^S(0)$ belongs to a certain triangle $\Delta_0(i, \mathbf{G})$ that is disjoint from $\mathbf{S}(\mathbf{G})$. This implies that $\mathbf{G}^S(0)$ is well defined, depends holomorphically on \mathbf{G} , and does not collide with 0. Since points $\mathbf{G}^S(0), \mathbf{G}^Q(0)$ with $0 < S < Q < T$ belong to different triangles of $\Delta_0(\mathbf{G}) \setminus \mathbf{S}$, we obtain a holomorphic motion of $\text{CV}(\mathbf{G}^T) = \{\mathbf{G}^S(0) \mid S < T\}$ with $\mathbf{G} \in \mathcal{W}_{\text{loc}}^u$. We also proved (4.10). Since every critical point of \mathbf{G}^P with $P \leq K$ passes exactly once through 0, the degree of every such critical point is 2.

For $\mathbf{F} \in \mathcal{W}^u$, choose $n \in \mathbb{Z}$ so that $\mathcal{R}^n(\mathbf{F}) \in \mathcal{W}_{\text{loc}}^u$. Then $K_{\mathbf{F}}$ can be taken to be $t^n K$.

The last claim follows from the observation that every critical point of \mathbf{F}^P passes through 0 at most $(P/K_{\mathbf{F}}) + 1$ times. \square

4.5. Proper discontinuity of $\mathbf{F}^{\geq 0}$. The action of the cascade $\mathbf{F}^{\geq 0}$ is proper discontinuous in the following sense

Lemma 4.4. *For every bounded open set $W \subset \mathbb{C}$ there is a $Q > 0$ in \mathbb{T} such that for all \mathbf{G} close to \mathbf{F} the following holds:*

- $W \in \text{Dom } \mathbf{G}^P$ for all $P \leq Q$;
- $\mathbf{G}^P \mid W$ is univalent for all $P \leq Q$; and
- $\mathbf{G}^P(W) \cap \mathbf{G}^T(W) = \emptyset$ for all $P < T \leq Q$.

For every $x \in \mathbb{C}$ and $T \in \mathbb{T}$, the set

$$\bigcup_{P \leq T} \mathbf{F}^P \{x\}$$

is discrete in \mathbb{C} . In particular, the set of critical values $\text{CV}(\mathbf{F}^T)$ of \mathbf{F}^T is discrete in \mathbb{C} for all $T \in \mathbb{T}$.

Proof. By (4.8) there is an $m \leq 0$ such that $W \subset \Delta_m(j, \mathbf{G})$ for all \mathbf{G} close to \mathbf{F} . Let us take $Q = \min\{(0, 0, 1), (0, 1, 0)\}t^m$. For $P \leq Q$ the map \mathbf{G}^P maps $\Delta_m(j, \mathbf{G})$ to a different triangle of $\Delta_m(\mathbf{G})$; this show the first claim.

Suppose that $\bigcup_{P \leq T} \mathbf{F}^P \{x\}$ accumulates on y . Choose a small neighborhood W of y . Then there is a $Q > 0$ such that $\mathbf{F}^P(W)$ is disjoint from W for all $P < Q$. Since $T < kQ$ for some $k \gg 1$, the intersection $W \cap \bigcup_{P \leq T} \mathbf{F}^P \{x\}$ consists of at most k points.

The set of critical values of \mathbf{F}^T is discrete because it is equal to $\bigcup_{P < T} \mathbf{F}^P \{0\}$, see

Lemma 4.3. \square

Corollary 4.5. *Let \mathbf{Y} be a compact set such that $\mathbf{Y} \in \text{Dom } \mathbf{F}^P$. Then for every $\mathbf{X} \in \mathbb{C}$ there are at most finitely many $T \leq P$ such that $\mathbf{F}^T(\mathbf{Y})$ intersects \mathbf{X} .*

Proof. For every $y \in \mathbf{Y}$, the orbit $\text{orb}_z^P := \{\mathbf{F}^S(z) \mid S \leq P\}$ is discrete and depends continuously on z in a small neighborhood of y because $y \in \text{Dom } \mathbf{F}^P$. (In fact, if $x \notin \text{Dom } \mathbf{F}^P$, then orb_z^P does not depends continuously on z in a small neighborhood of x). The corollary now follows from a compactness argument. \square

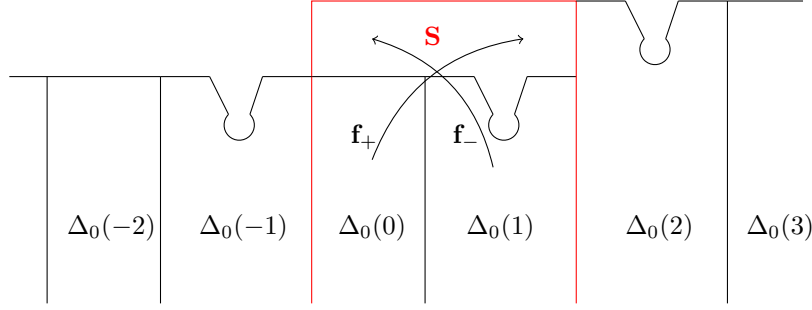

FIGURE 17. The triangulation $\Delta_0(\mathbf{F})$ is obtained by spreading around the triangles $\Delta_0(0, \mathbf{F})$ and $\Delta_0(1, \mathbf{F})$ – the embeddings of $\Delta_0(1, f)$ and $\Delta_0(0, f)$, see Figure 15. The triangulation has the same combinatorics as the renormalization tiling of \mathbb{R} , see Figure 6

Corollary 4.6. *Every periodic point has a minimal period.*

For every critical point x of $\mathbf{F}^{\geq 0}$, there is a minimal $P > 0$, called the generation of x , such that $\mathbf{F}^P(x) = 0$.

Proof. Let x be a periodic point of \mathbf{F} , and let

$$\mathbb{T}_x := \{P \in \mathbb{T} \mid \mathbf{F}^P(x) = x\}$$

be the semigroup of all the periods of x . By Lemma 4.4, there is a neighborhood W of x and a small $Q > 0$ such that $\mathbf{F}^T(W) \cap W = \emptyset$ for all $T \leq Q$; in particular, $\mathbf{F}^T(x) \neq x$. Therefore, \mathbb{T}_x is of the form $\{nS \mid n \geq 1\}$, where $S > 0$ is the minimal period.

By Lemma 4.3, if x is a critical point of $\mathbf{F}^{\geq 0}$, then $\mathbf{F}^P(x) = 0$ for some $P \in \mathbb{T}$. Since $\{\mathbf{F}^S(x) \mid S \leq P\}$ does not accumulate on 0, there is a minimal $S > 0$ such that $\mathbf{F}^S(x) = 0$. \square

4.6. Walls $\mathbb{P}_0(\mathbf{F})$. Recall from §3.2.11 that a triangulation $\Delta_n(f)$ has a wall $\mathbb{P}_n(f)$ for $f \in \mathcal{W}^u$. Let $\mathbb{P}_0(0, \mathbf{F})$ and $\mathbb{P}_0(1, \mathbf{F})$ be the embeddings of the rectangles $\mathbb{P}_0(0, f)$ and $\mathbb{P}_0(1, f)$ to the dynamical plane of \mathbf{F} via $\mathbf{S} \simeq V \setminus \gamma_1$. The wall $\mathbb{P}_0(\mathbf{F})$ of $\Delta_0(\mathbf{F})$ is obtained by spreading around $\mathbb{P}_n(0, \mathbf{F})$ and $\mathbb{P}_n(1, \mathbf{F})$.

The wall $\mathbb{P}_n(\mathbf{F})$ is $A_\star^{-n}(\mathbb{P}_0(\mathcal{R}^n f))$. We define $\mathbf{Q}_n(\mathbf{F}) := \Delta_n \setminus \mathbb{P}_n(\mathbf{F})$. This is the interior of the full lift of $Q_n(f) := \Delta_n(f) \setminus \mathbb{P}_n(f)$.

4.7. The boundary point α . As in §2.3.9, we add a boundary point α at “ $-i\infty$ ” to the dynamical space of a prepacman. The boundary point $\alpha(\mathbf{F})$ corresponds to $\alpha(f)$. Let us introduce the *wall topology* for $\mathbb{C} \sqcup \alpha(\mathbf{F})$, compare with §2.3.9.

Consider a univalent wall A respecting γ_0, γ_1 in a small neighborhood of $\alpha(f)$. Then the full lift $\mathbb{A}(\mathbf{F})$ of $A(f)$ is a closed strip in \mathbb{C} such that $\mathbb{C} \setminus \mathbb{A}(\mathbf{F})$ has two connected components. We denote by $\Omega = \Omega(A)$ the component of $\mathbb{C} \setminus \mathbb{A}(\mathbf{F})$ not containing 0. Equivalently, Ω is the interior of the full lift of the component of $\mathbb{C} \setminus A$ containing α . We say that Ω is *below* \mathbb{A} . The open sets of $\mathbb{C} \sqcup \{\alpha(\mathbf{F})\}$ are generated by open sets in \mathbb{C} and by $\Omega(A) \sqcup \{\alpha(\mathbf{F})\}$ for all univalent walls as above.

A curve $\ell: [0, 1) \rightarrow \mathbb{C}$ *lands* at α if $\lim_{t \rightarrow 1} \ell(t) = \alpha$.

4.8. A fundamental domain for \mathbf{F} . Recall that for $\mathbf{F} \in \mathcal{W}_{\text{loc}}^u$, the sector \mathbf{S} has distinguished sides $\lambda(\mathbf{S})$ and $\rho(\mathbf{S})$. Moreover V is a quotient of \mathbf{S} under $\mathbf{F}^{(0,0,1)-(0,1,0)} = \mathbf{f}_-^{-1} \circ \mathbf{f}_+$: $\lambda(\mathbf{S}) \rightarrow \rho(\mathbf{S})$, and $\lambda(\mathbf{S}), \rho(\mathbf{S})$ project to γ_1 .

Suppose $\mathbf{F} \in \mathcal{R}^{-n}(\mathcal{W}_{\text{loc}}^u)$ for $n \geq 0$. Recall §4.6 that $\mathbf{Q}_n(\mathbf{F}) = \Delta_n(\mathbf{F}) \setminus \mathbb{P}_n(\mathbf{F})$. A *fundamental domain* in the dynamical plane of \mathbf{F} is a sector \mathbf{S}^{new} with distinguished sides $\lambda(\mathbf{S}^{\text{new}})$ and $\rho(\mathbf{S}^{\text{new}})$ such that

- (1) $\mathbf{S} \setminus \mathbf{Q}_n = \mathbf{S}^{\text{new}} \setminus \mathbf{Q}_n$ and $\lambda(\mathbf{S}) \setminus \mathbf{Q}_n = \lambda(\mathbf{S}^{\text{new}}) \setminus \mathbf{Q}_n$ and $\rho(\mathbf{S}) \setminus \mathbf{Q}_n = \rho(\mathbf{S}^{\text{new}}) \setminus \mathbf{Q}_n$,
- (2) $\lambda(\mathbf{S}^{\text{new}})$ and $\rho(\mathbf{S}^{\text{new}})$ land at α ; and
- (3) $\text{int}(\mathbf{S}^{\text{new}})$ contains an arc ℓ such that $\mathbf{f}_-(\ell) = \lambda(\mathbf{S}^{\text{new}})$ and $\mathbf{f}_+(\ell) = \rho(\mathbf{S}^{\text{new}})$.

Similar to §2.3.11, we say that $\beta_0, \beta_1 = f(\beta_0)$ is a diving pair of arcs in the dynamical plane of a pacman $f: U \rightarrow V$ if

- β_0 is a simple arc connecting α and point on ∂U ;
- β_1 is a simple arc connecting α and a point on ∂V ;
- β_0, β_1 are disjoint away from α .

Theorem 4.7. *Suppose \mathbf{S}^{new} is a fundamental domain in the dynamical plane of $\mathbf{F} \in \mathcal{R}^{-n}(\mathcal{W}_{\text{loc}}^u)$ as above. Then the quotient of \mathbf{S}^{new} under*

$$\mathbf{F}^{(n,0,1)-(n,1,0)}: \lambda(\mathbf{S}^{\text{new}}) \rightarrow \rho(\mathbf{S}^{\text{new}})$$

is canonically conformally homeomorphic to V . Under this homeomorphism \mathbf{F} projects to f .

Conversely, if $\gamma_0^{\text{new}}, \gamma_1^{\text{new}}$ is a dividing pair of arcs such that $\gamma_0^{\text{new}} \setminus \mathbf{Q}_n = \gamma_0$ and $\gamma_1^{\text{new}} \setminus \mathbf{Q}_n = \gamma_1$ (see §4.6), then h extends from a neighborhood of c_1 to a conformal map defined on $V \setminus \gamma_1^{\text{new}}$ so that the closure of $h(V \setminus \gamma_1^{\text{new}})$ is a fundamental domain.

Proof. Choose in $\mathbb{P}_n(f)$ a univalent wall A respecting γ_0, γ_1 and surrounding $\Omega \ni \alpha$. Let $\mathbb{A} \subset \mathbb{P}_n(\mathbf{F})$ and Ω be the full lifts of A and Ω to the dynamical plane of \mathbf{F} . The theorem now follows from Proposition 2.10 applied to $f|_{\Omega \cup A}$ and $\mathbf{F}|_{\Omega \cup \mathbb{A}}$. \square

The image of \mathbf{S}^{new} is of the form $\Delta_0^{\text{new}}(f)$ as in §3.2.12; it has the full lift to $\Delta_{n-m}^{\text{new}}(f_m)$ for all $m \leq 0$. Condition (1) can be related into “ \mathbf{S} and \mathbf{S}^{new} are sufficiently close in $\mathbb{P}_n(\mathbf{F})$.”

4.9. Fatou, Julia, and escaping sets. Consider $x \in \mathbb{C}$. If there is an open set U such that $U \subset \text{Dom } \mathbf{F}^P$ for all $P \geq 0$ and, moreover, $\{\mathbf{F}^P|_U\}_{P \geq 0}$ forms a normal family, then x is a *regular point of \mathbf{F}* . The *Fatou set* $\mathfrak{F}(\mathbf{F})$ of \mathbf{F} is the set of regular points of \mathbf{F} . By construction, all $\mathbf{F}_n^\#$ have the same Fatou sets.

The *Julia set* $\mathfrak{J}(\mathbf{F})$ of \mathbf{F} is $\mathbb{C} \setminus \mathfrak{F}(\mathbf{F})$. Clearly, all repelling periodic points are within the Julia set of \mathbf{F} .

The cascade $\mathbf{F}^{\geq 0}$ acts on the set of components of $\mathfrak{F}(\mathbf{F})$. A component X of $\mathfrak{F}(\mathbf{F})$ is *periodic* if there is a power-triple P such that $\mathbf{F}^P(X) = X$. We call P a *period* of X .

A Fatou component X is *invariant* if $\mathbf{F}^P(X) = X$ for every $P \in \mathbb{T}$. By Corollary 4.6, if a Fatou component X has an attracting point in \mathbb{C} , then X has a minimal period; in particular, X is not invariant. (Note that $\alpha(\mathbf{F})$ is an attracting point of an invariant Fatou component if $\alpha(f)$ is attracting.)

Two Fatou components X, Y are *dynamically related* if they are in the same grand orbit: there are $P, Q \in \mathbb{T}$ such that a certain branch of $\mathbf{F}^{-P} \circ \mathbf{F}^Q$ maps X to Y . Dynamically related periodic components have the same periods.

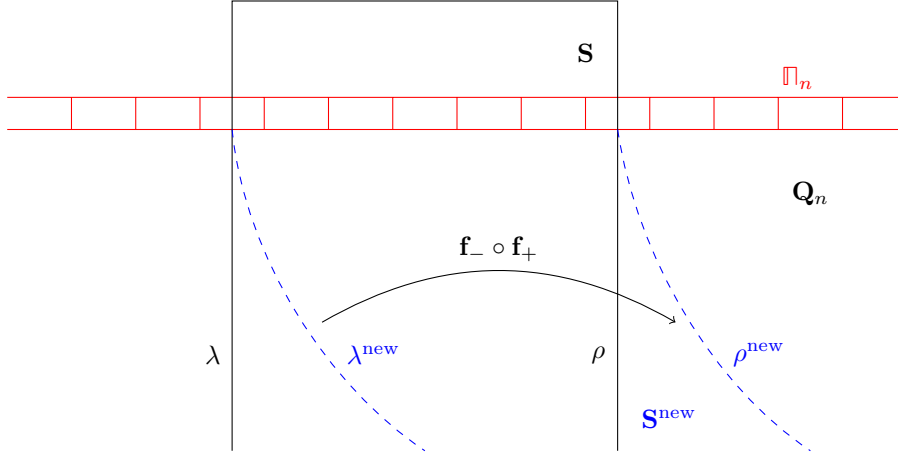

FIGURE 18. A fundamental domain \mathbf{S}^{new} is a sector in $\mathbb{C} \sqcup \{\alpha\}$ such that $\mathbf{S}^{\text{new}} \setminus \mathbf{Q}_n$ coincide (or close) to $\mathbf{S} \setminus \mathbf{Q}_n$ and such that the “deck transformation” $\mathbf{f}_-^{-1} \circ \mathbf{f}_+$ maps the left boundary λ^{new} of \mathbf{S}^{new} to its right boundary ρ^{new} .

A Fatou component X is *preperiodic* if there is a power-triple Q such that $\mathbf{F}^Q(X)$ is a periodic Fatou component. In this case, Q is the *preperiod*.

Given $P \in \mathbb{T}$, we define the P -th *escaping set* as

$$\mathbf{Esc}_P(\mathbf{F}) := \mathbb{C} \setminus \text{Dom}(\mathbf{F}^P).$$

The *escaping set* is

$$\mathbf{Esc}(\mathbf{F}) := \bigcup_{P \geq 0} \mathbf{Esc}_P(\mathbf{F}).$$

Since the domains of \mathbf{f}_{\pm} are simply connected (see §3.2.9) for $\mathbf{F} \in \mathcal{W}_{\text{loc}}^u$, every connected component of $\text{Dom} \mathbf{F}^P$ is simply connected. Therefore, every connected component of $\mathbf{Esc}_P(\mathbf{F})$ is unbounded. Since $\mathbf{Esc}_P(\mathbf{F})$ is a rescaling of $\mathbf{Esc}_{t^n P}(\mathbf{F}_{-n})$, every connected component of $\mathbf{Esc}_P(\mathbf{G})$ is unbounded for every $\mathbf{G} \in \mathcal{W}^u$.

By definition, $\overline{\mathbf{Esc}(\mathbf{F})} \subset \mathfrak{J}(\mathbf{F})$. We will show in Corollary 6.9 that $\overline{\mathbf{Esc}(\mathbf{F})} \neq \emptyset$, hence $\overline{\mathbf{Esc}(\mathbf{F})} = \mathfrak{J}(\mathbf{F})$.

4.10. QC deformation of maximal prepacmen. Suppose that \mathbb{C} has a Beltrami form μ such that μ is invariant under the cascade $\mathbf{F}^{\geq 0}$, where $\mathbf{F} \in \mathcal{W}^u$. Integrating μ , we obtain a path $\mathbf{F}_t^{\geq 0}$ with $t \geq 0$ of cascades emerging from $\mathbf{F}_0^{\geq 0} = \mathbf{F}^{\geq 0}$. We claim that \mathbf{F}_t is, up to scaling, a path on the unstable manifold \mathcal{W}^u . We will use the argument from [DLS, §8.1.2] to find a correct scaling.

Applying antirenormalization, we can assume that \mathbf{F} is in a small neighborhood of \mathbf{F}_* . In particular, $\mathbf{F} \in \mathcal{W}_{\text{loc}}^u$. Projecting μ to the dynamical plane of f_n for $n \leq 0$, we obtain the Beltrami form μ_n invariant under f_n . Integrating μ_n , we obtain a path $f_{n,t} \in \mathcal{B}$ emerging from $f_{n,0} = f_n$. Set $f_t^{(n)} := \mathcal{R}^{-n} f_{n,t}$, and observe that for small t all $f_t^{(n)}$ are qc conjugate with bounded dilatation uniformly in n . Therefore, we can take a limit and construct a path $f_t^{(\infty)}$ in \mathcal{B} of infinitely anti-renormalizable pacmen. Therefore, $f_t := f_t^{(\infty)}$ is a path in \mathcal{W}^u .

The qc deformation of maximal prepacmen allows us to modify multipliers of attracting periodic cycles.

5. EXTERNAL STRUCTURE OF \mathbf{F}_\star

In this section we set $\mathbf{F} = \mathbf{F}_\star$ and we let $\mathbf{Z} = \mathbf{Z}_\star$ to be its Siegel disk which is defined to be the full lift of Z_\star , see §4.3. We also write the fixed pacman $f_\star: U_\star \rightarrow V$ as $f: U \rightarrow V$.

5.1. Chess-board rule. Let us say that a simply connected open set $U \subset \mathbb{D}$ has a *single access to infinity* if $\partial\mathbb{D} \cap \partial U \neq \emptyset$ and $\mathbb{D} \setminus U$ is connected. Similarly, a simply connected open set $U \subset \mathbb{C}$ has a *single access to infinity* if U is unbounded and $\mathbb{C} \setminus U$ is connected.

We need the following fact.

Lemma 5.1. *Let $g: \text{Dom } g \rightarrow \mathbb{C}$ be a σ -proper map, where $\text{Dom } g$ is either \mathbb{D} or \mathbb{C} . Suppose that the set of critical values $\text{CV}(g)$ of g is discrete and assume that $\ell: \mathbb{R} \rightarrow \mathbb{C}$ is a simple properly embedded arc such that*

- 1) $\ell(\mathbb{R}) \supset \text{CV}(g)$, and
- 2) ℓ splits \mathbb{C} into two open half-planes V and W .

Then

- $g^{-1}(\ell)$ is a tree in $\text{Dom } g$; in particular, if U is a connected component of $\text{Dom } g \setminus g^{-1}(\ell)$, then U has a single access to infinity; and
- there is a “chess-board rule”: if U_1 and U_2 are two different components of $g^{-1}(V)$, then $\partial U_1 \cap \partial U_2 \cap \text{Dom } g$ is either empty or a single critical point of g .

Note that since g is σ -proper, $g^{-1}(\text{CV}(g))$ is in discrete $\text{Dom } g$.

Proof. We will verify the case when $\text{Dom } g = \mathbb{D}$; the case $\text{Dom } g = \mathbb{C}$ is completely analogous.

Consider a connected component U of $\mathbb{D} \setminus g^{-1}(\ell)$. Recall that a σ -proper map has no asymptotic values. Since $\text{CV}(g) \subset \ell$, the map

$$g: U \rightarrow g(U) \in \{V, W\}$$

is a covering. Since V and W are simply connected, so is U ; i.e. $g: U \rightarrow g(U)$ is univalent. And since V and W are unbounded, U is not properly contained in \mathbb{D} . This implies that $g^{-1}(\ell)$ is a forest.

Since ℓ is a properly embedded arc in \mathbb{C} , we can express \mathbb{C} as an increasing union of open topological disks Y_i such that $Y_i \cap \ell$ is an arc. Defining the X_i to be lifts of the Y_i with $X_{i+1} \supset X_i$, we express \mathbb{D} as an increasing union of open disks X_i such that $g: X_i \rightarrow Y_i$ is proper. Then $(g|X_i)^{-1}(Y_i \cap \ell) = g^{-1}(\ell) \cap X_i$ is a finite tree. Therefore, $g^{-1}(\ell)$ is a tree in \mathbb{D} .

Let U_1 and U_2 be two different components of $g^{-1}(V)$. Then $\partial U_1 \cap \partial U_2 \cap \text{Dom } g$ is a discrete set of critical points. If $\partial U_1 \cap \partial U_2 \cap \text{Dom } g$ has at least two points, then $\overline{U}_1 \cup \overline{U}_2$ surround a component of $g^{-1}(W)$; this is a contradiction. \square

5.2. Bubbles of \mathbf{F} . Recall from §4.3 that $\mathbf{Z} = \mathbf{Z}_\star$ is the full lift of $Z = Z_\star$. Alternatively, $\overline{\mathbf{Z}}_\star$ can be viewed as a rescaled limit of \overline{Z}_\star , [McM1]. Then $\mathbf{f}_\pm | \overline{\mathbf{Z}}$ is a pair of homeomorphisms, and $\mathbf{f}_+ \circ \mathbf{f}_-^{-1}$ is a deck transformation of $\overline{\mathbf{Z}}$: the quotient $\overline{\mathbf{Z}} / \langle \mathbf{f}_-^{-1} \circ \mathbf{f}_+ \rangle$ is identified with \overline{Z}_\star ; i.e. $\overline{\mathbf{Z}}$ is the universal cover of $\overline{Z}_\star \setminus \{\alpha\}$ and $\mathbf{f}_\pm | \overline{\mathbf{Z}}$ are lifts of $f | Z_\star$.

Lemma 5.2 (Compare with [McM1, Theorem 8.1]). *The disk \mathbf{Z} is an invariant Fatou component of \mathbf{F} . Let $\mathbf{h}: \mathbf{Z} \rightarrow \{\operatorname{Im} z < 0\}$ be a conformal map. Then \mathbf{h} extends to a quasimetric map $\mathbf{h}: \overline{\mathbf{Z}} \rightarrow \{\operatorname{Im} z \leq 0\}$.*

Let us normalize $\mathbf{h}: \mathbf{Z} \rightarrow \{\operatorname{Im} z < 0\}$ to be the unique conformal map so that $\mathbf{h}(0) = 0$ and $|\mathbf{h}'(0)| = 1$. Then \mathbf{h} conjugates $\mathbf{f}_-, \mathbf{f}_+$ to a pair of translations $z \mapsto z - \mathbf{v}$ and $z \mapsto z + \mathbf{w}$ with $\mathbf{v}, \mathbf{w} \geq 0$ such that $\theta_ = \mathbf{v}/(\mathbf{v} + \mathbf{w})$. Moreover, \mathbf{h} conjugates the cascade $(\mathbf{F}^P | \overline{\mathbf{Z}})_{P \in \mathbb{T}}$ with the cascade of translations $(T^P)_{P \in \mathbb{T}}$ from §2.1.1.*

Proof. Recall from §4.3 that the support of the renormalization triangulation $\Delta_0(\mathbf{F})$ is a neighborhood of $\overline{\mathbf{Z}}$ and $\Delta_0(\mathbf{F})$ is the full lift of $\Delta_0(f)$. As a consequence, $\partial\mathbf{Z}$ is locally a quasiarc; $\partial\mathbf{Z}$ is globally a quasiarc because it is invariant under the scaling A_* .

In the dynamical plane of f , the boundary ∂Z_* is contained in the closure of repelling periodic points (see §3.2.5). Lifting these periodic points to the dynamical plane of \mathbf{F} we obtain that $\partial\mathbf{Z}$ is also in the closure of repelling periodic points; thus $\partial\mathbf{Z} \subset \mathfrak{J}(\mathbf{F})$.

Since $\mathbf{f}_\pm | \overline{\mathbf{Z}}$ are lifts of $f | \overline{Z}_*$, the pair $\mathbf{f}_\pm | \overline{\mathbf{Z}}$ is conjugate to a pair of translations $z \mapsto z - \mathbf{v}$ and $z \mapsto z + \mathbf{w}$ as required (see also §2.1.1); thus \mathbf{Z} is a Fatou component of \mathbf{F} . \square

Observe that $\partial\mathbf{Z} \supset \mathfrak{P}(\mathbf{F}) \supset \operatorname{CV}(\mathbf{F})$ because $0 \in \partial\mathbf{Z}$ and $\partial\mathbf{Z}$ is invariant. We have the following corollary of Lemma 5.1:

Corollary 5.3. *For every $P \in \mathbb{T}_{>0}$ the preimage $\mathbf{F}^{-P}(\partial\mathbf{Z})$ is a tree in $\operatorname{Dom} \mathbf{F}^P$. \square*

Since $\mathbf{F}^P | \partial\mathbf{Z}$ is a homeomorphism, for every $P > 0$, there is a unique critical point $c_P \in \partial\mathbf{Z}$ of $\mathbf{F}^{\geq 0}$ of generation P , see Lemma 4.3. Since \mathbf{F}^P is two-to-one around c_P , there is a preperiodic Fatou component \mathbf{Z}_P attached to c_P such that $\mathbf{F}^P(\mathbf{Z}_P) = \mathbf{Z}$.

Lemma 5.4. *For c_P and \mathbf{Z}_P as above, $\overline{\mathbf{Z}} \cap \overline{\mathbf{Z}}_P = \{c_P\}$. Set*

$$\widehat{\mathbf{Z}}_P := \overline{\mathbf{Z}}_P \cap \operatorname{Dom} \mathbf{F}^P.$$

Then $\mathbf{F}^P: \widehat{\mathbf{Z}}_P \rightarrow \overline{\mathbf{Z}}$ is a homeomorphism.

The point c_P is called the *root* of \mathbf{Z}_P . We will show in Lemma 5.11 that

$$\tilde{\alpha}_P := \overline{\mathbf{Z}}_P \setminus \widehat{\mathbf{Z}}_P$$

consists of a single point, called the *top* of \mathbf{Z}_P . We set

$$\partial^c \mathbf{Z}_P := \partial\mathbf{Z}_P \cap \operatorname{Dom}(\mathbf{F}^P) = \widehat{\mathbf{Z}}_P \setminus \mathbf{Z}_P.$$

Proof. By Corollary 5.3, $\mathbf{F}^{-P}(\partial\mathbf{Z})$ is a tree in $\operatorname{Dom}(\mathbf{F}^P)$. Therefore, \mathbf{Z}_P is a connected component of $\operatorname{Dom}(\mathbf{F}^P) \setminus \mathbf{F}^{-P}(\partial\mathbf{Z})$ specified so that $\overline{\mathbf{Z}} \cap \overline{\mathbf{Z}}_P = \{c_P\}$. Moreover, $\partial^c \mathbf{Z}_P = \partial\mathbf{Z}_P \cap \operatorname{Dom}(\mathbf{F}^P)$ is a simple arc.

Since $\mathbf{F}^Q(\partial^c \mathbf{Z}_P)$ is disjoint from 0 for all $Q < P$ (because $\mathbf{F}^Q(\partial^c \mathbf{Z}_P) \subset \partial^c \mathbf{Z}_{P-Q}$), the curve $\partial^c \mathbf{Z}_P$ contains a single critical point c_P of \mathbf{F}^P . Therefore, $\mathbf{F}^P: \partial^c \mathbf{Z}_P \rightarrow \partial\mathbf{Z}$ is a homeomorphism; this proves the second claim. \square

For every $Q \in \mathbb{T}$, there is a unique critical point $c_{P,Q} \in \partial\mathbf{Z}_P$ of $\mathbf{F}^{\geq 0}$ of generation $P + Q$. If $Q > 0$, then there is a unique Fatou component $\mathbf{Z}_{P,Q}$ attached to

\mathbf{Z}_P at $c_{(P,Q)}$ such that $\mathbf{F}^{P+Q}(\mathbf{Z}_P) = \mathbf{Z}$. As above, we have a homeomorphism $\mathbf{F}^{P+Q}: \widehat{\mathbf{Z}}_{P,Q} \rightarrow \overline{\mathbf{Z}}$.

Continuing this process, we define c_{P_1, \dots, P_m} and the *bubble* $\mathbf{Z}_{P_1, \dots, P_m}$ for every finite sequence in $s = (P_1, \dots, P_n) \in \mathbb{T}_{>0}^n$. We call $|s| = P_1 + \dots + P_n$ the *generation* of $\mathbf{Z}_s = \mathbf{Z}_{P_1, \dots, P_m}$. Lemma 5.4 implies:

Lemma 5.5. *For every bubble \mathbf{Z}_s with $|s| > 0$, there is a unique bubble \mathbf{Z}_v with $|v| \leq |s|$ (possibly $\mathbf{Z}_v = \mathbf{Z}$) and $v \neq s$ such that $\partial^c \mathbf{Z}_s \cap \partial^c \mathbf{Z}_v \neq \emptyset$. Moreover, $\partial^c \mathbf{Z}_s \cap \partial^c \mathbf{Z}_v = \{c_s\}$. \square*

We define the corresponding *finite bubble chain* as

$$B_s = (\widehat{\mathbf{Z}}_{P_1}, \widehat{\mathbf{Z}}_{P_1, P_2}, \dots, \widehat{\mathbf{Z}}_{P_1, P_2, \dots, P_n}).$$

The *primary limb* rooted at c_{P_1} is

$$\mathbf{L}_{P_1} := \bigcup_{n \geq 1} \bigcup_{(P_1, \dots, P_n)} \widehat{\mathbf{Z}}_{P_1, \dots, P_n},$$

where the union is taken over all finite sequences in $\mathbb{T}_{>0}$ starting with P_1^2 . Similarly, the *secondary limbs* \mathbf{L}_{P_1, P_2} of \mathbf{Z}_{P_1} are defined.

We also consider *infinite bubble chains*: given

$$s = (P_1, P_2, \dots) \in \mathbb{T}_{>0}^{\mathbb{N}},$$

we set $B_s = (\widehat{\mathbf{Z}}_{P_1}, \widehat{\mathbf{Z}}_{P_1, P_2}, \dots)$. The *generation* of B_s is

$$|s| = P_1 + P_2 + \dots \leq \infty$$

(recall that we view \mathbb{T} as a sub-semigroup of $\mathbb{R}_{>0}$); it is the supremum of generations of all the bubbles in the chain.

Given a finite or infinite bubble chain B_s with $s = (P_1, P_2, \dots)$, we write its geometric realization as

$$\mathbb{B}_s = \widehat{\mathbf{Z}}_{P_1} \cup \widehat{\mathbf{Z}}_{P_1, P_2} \cup \dots$$

and call it a *bubble chain* as well.

Suppose s is an infinite sequence. The *accumulating set* of B_s (and of \mathbb{B}_s) is the accumulating set of $\widehat{\mathbf{Z}}_{P_1}, \widehat{\mathbf{Z}}_{P_1, P_2}, \dots$. If the accumulating set is a singleton $\{x\}$, then we say that B_s *lands* at x . (It will follow from Lemma 5.34 that every infinite bubble chain lands.)

If s is a finite sequence, then the *accumulating set* of B_s is

$$(5.1) \quad \overline{\mathbf{Z}}_s \setminus \widehat{\mathbf{Z}}_s \subset \mathbf{Esc}_P.$$

Proposition 5.6. *Every strictly preperiodic preimage of \mathbf{Z} is contained in some limb \mathbf{L}_x .*

Proof. Let $\mathbf{Z}' \neq \mathbf{Z}$ be a component of $\mathbf{F}^{-P}(\mathbf{Z})$. By Lemma 5.1, \mathbf{Z}' is a component of $\text{Dom } \mathbf{F}^P \setminus \mathbf{F}^{-P}(\partial \mathbf{Z})$, where $\mathbf{F}^{-P}(\partial \mathbf{Z})$ is a tree in $\text{Dom } \mathbf{F}^P$. Let $\gamma \subset \mathbf{F}^{-P}(\partial \mathbf{Z})$ be the tree-geodesic connecting $\partial \mathbf{Z}$ to $\partial^c \mathbf{Z}'$. There are finitely many critical points

$$c_{P_1}, c_{P_1, P_2}, \dots, c_{P_1, \dots, P_n}$$

of \mathbf{F}^P in γ . We have $\mathbf{Z}' = \mathbf{Z}_{P_1, \dots, P_n}$. \square

²This is not a standard definition of a limb because \mathbf{L}_{P_1} is not closed.

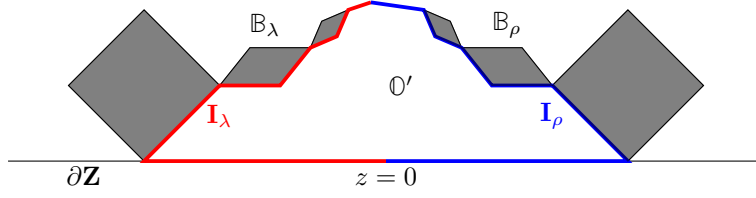

FIGURE 19. The case $z = 0$: the bubble chains \mathbb{B}_λ and \mathbb{B}_ρ of the lake \mathcal{O}' contain $\mathbf{I}_\lambda \setminus \partial\mathbf{Z}$ and $\mathbf{I}_\rho \setminus \partial\mathbf{Z}$ – the left and right sides of $\partial^c\mathcal{O}'$.

For a limb \mathbf{L}_s we write

$$\partial^c\mathbf{L}_s = \bigcup_{\mathbf{z}_v \subset \mathbf{L}_s} \partial^c\mathbf{z}_v$$

and, similarly, for a bubble chain \mathbb{B}_s :

$$\partial^c\mathbb{B}_s = \bigcup_{\mathbf{z}_v \subset \mathbb{B}_s} \partial^c\mathbf{z}_v.$$

5.3. Lakes. We call $\mathcal{O} := \mathbb{C} \setminus \overline{\mathbf{Z}}$ the *lake of generation 0* or the *ocean*. A *lake of generation* $P \in \mathbb{T}_{>0}$ is a connected component of $\mathbf{F}^{-P}(\mathcal{O})$. In particular, lakes of generation P are pairwise disjoint. If \mathcal{O}_1 is a lake of generation $P \in \mathbb{T}$, then its *coast* is

$$\partial^c\mathcal{O}_1 := \partial\mathcal{O}_1 \cap \text{Dom } \mathbf{F}^P.$$

By Lemma 5.1:

- \mathcal{O}_1 has a single access to $\mathbf{Esc}_P(\mathbf{F})$ (i.e. after identifying $\mathbb{C} \setminus \mathbf{Esc}_P(\mathbf{F}) \simeq \mathbb{D}$);
- $\mathbf{F}^P: \mathcal{O}_1 \rightarrow \mathcal{O}$ is conformal;
- $\partial^c\mathcal{O}_1$ is a properly embedded simple arc in the tree $\mathbf{F}^{-P}(\partial\mathbf{Z})$;
- $\mathbf{F}^P: \partial^c\mathcal{O}_1 \rightarrow \partial^c\mathcal{O} = \partial\mathbf{Z}$ is a homeomorphism.

We will call lakes of positive generation *proper*.

Lakes form a “puzzle partition” (by open sets): since $\mathbf{Z} = \mathbf{F}^S(\mathbf{Z})$ is invariant, lakes of generation R are inside lakes of generations P for $R > P \geq 0$. The map \mathbf{F}^{R-P} maps every lake of generation R univalently to a lake of generation P . Informally speaking, when P grows there are less water and more land, and the “drought” occurs in a self-similar fashion. We will use lakes to study $\mathbf{Esc}(\mathbf{F})$; lakes will not be used beyond the current section.

Consider a lake \mathcal{O}' of generation P . Let $z \in \partial^c\mathcal{O}'$ be the closest point to 0 in the tree $\mathbf{F}^{-P}(\partial\mathbf{Z})$. Then z splits $\partial^c\mathcal{O}'$ into two arcs I_λ and I_ρ . We assume that $I_\lambda, [z, 0], I_\rho$ has a counterclockwise orientation at z ; if $z = 0$, then we assume that I_λ is on the left of 0 relative $\partial\mathbf{Z}$ while I_ρ is on the right of 0, see Figure 19.

There are unique bubble chains \mathbb{B}_λ and \mathbb{B}_ρ containing $I_\lambda \setminus \partial\mathbf{Z}$ and $I_\rho \setminus \partial\mathbf{Z}$ respectively. (If $I_\lambda \subset \mathbf{Z}$,³ then set $\mathbb{B}_\lambda = \emptyset$, and similarly with I_ρ .) If $\partial\mathbf{Z} \cap \partial\mathcal{O}' = \emptyset$, then $\partial^c\mathcal{O}' \subset \partial^c\mathbb{B}_\lambda \cup \partial^c\mathbb{B}_\rho$. We now view $\lambda = \lambda(\mathcal{O}')$ and $\rho = \rho(\mathcal{O}')$ as sequences of positive power-triples parameterizing bubble chains as above, and we say that \mathbb{B}_λ and \mathbb{B}_ρ are the *left and the right* bubble chains of \mathcal{O}' .

³this is in fact impossible by Lemma 5.7

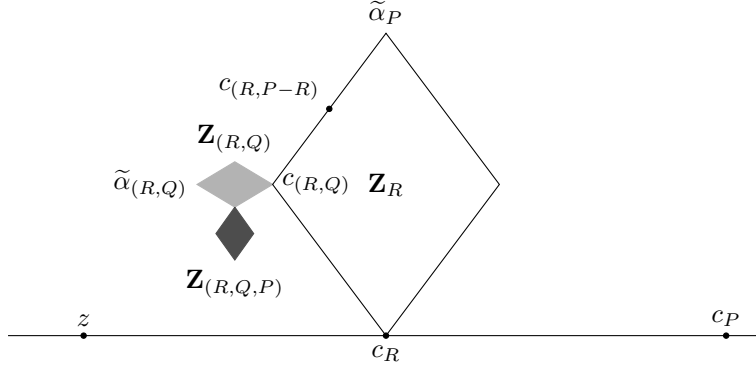

FIGURE 20. Suppose a lake \mathcal{O}' touches $\partial\mathbf{Z}$; say $z \in \overline{\mathcal{O}'} \cap \partial\mathbf{Z}$. If c_P is on the right from z , then $\mathbb{B}_\rho(\mathcal{O}')$ is finite. Indeed, let c_R be the critical point of generation $\leq P$ such that c_R is the closest to z on the right. Assume $R < P$. Then, as shown on the figure, $c_{(R,P-R)} \in \partial^c \mathbf{Z}_R$ is on the left of c_R . Let $c_{(P,Q)}$ be the critical point of generation $\leq P - R$ closest to $c_R \in \partial^c \mathbf{Z}_R$ on the left. Assume $Q < P - R$. Then $c_{(R,Q,P-R-Q)} \in \partial^c \mathbf{Z}_{(R,Q)}$ is on the left of $c_{(R,Q)}$. Assume now that $c_{(R,Q,P-R-Q)}$ is the closest to $c_{(R,Q)} \in \partial^c \mathbf{Z}_{(R,Q)}$ on the left. Then $\mathbb{B}_\rho(\mathcal{O}') = \mathbb{B}_{(R,Q,P-R-Q)} = \mathbf{Z}_R \cup \mathbf{Z}_{(R,Q)} \cup \mathbf{Z}_{(R,Q,P-R-Q)}$.

Lemma 5.7. *Consider a lake \mathcal{O}' of generation P and let \mathbb{B}_λ and \mathbb{B}_ρ be the left and right bubble chains of \mathcal{O}' . Then \mathbb{B}_λ and \mathbb{B}_ρ have generation P as well. Moreover, one of the λ, ρ is a finite sequence while another is an infinite sequence.*

Lemma 5.7 is illustrated in Figure 20.

Proof. Claim. If $J := \mathcal{O}' \cap \mathbf{Z} \neq \emptyset$, then \mathbb{B}_λ and \mathbb{B}_ρ are non-empty.

Proof. By Corollary 5.3, J is an arc; choose $x \in J$. Both connected components of $\partial\mathbf{Z} \setminus \{x\}$ contain infinitely many critical points of generation $\leq P$ and these points are branch points of the tree $\mathbf{F}^{-P}(\partial\mathbf{Z})$. Since J does not cross such branch points, \mathbb{B}_λ and \mathbb{B}_ρ are non-empty. \square

Suppose now that the generation R of \mathbb{B}_λ is less than P . Choose S with $R < S < P$ such that $\overline{\mathbf{F}^S(\mathcal{O}')} \cap \partial\mathbf{Z} \neq \emptyset$. The left bubble chain of $\mathbf{F}^S(\mathcal{O}')$ is $\mathbf{F}^S(\mathbb{B}_\lambda)$ which is empty; this is impossible by the above *Claim*. Since \mathcal{O}' is bounded by $\mathbf{F}^{-P}(\partial\mathbf{Z})$, the generation of \mathbb{B}_λ can not be bigger than P . This shows that \mathbb{B}_λ (and similarly \mathbb{B}_ρ) has generation P .

Suppose now that λ and ρ are finite; write $\lambda = (P_1, P_2, \dots, P_n)$ and $\rho = (Q_1, Q_2, \dots, Q_m)$. Then $P_1 + \dots + P_n = Q_1 + \dots + Q_m = P$. Choose $H \in \mathbb{T}$ so that

$$P > H > \max\{P_1 + \dots + P_{n-1}, Q_1 + \dots + Q_{m-1}\}.$$

On the one hand, $\mathbf{F}^H(\widehat{\mathbf{Z}}_\lambda) = \widehat{\mathbf{Z}}_{P-H}$ (the unique bubble of generation $P - H$ attached to $\partial\mathbf{Z}$) is the left bubble chain of the lake $\mathbf{F}^H(\mathcal{O}')$; and on the other hand $\mathbf{F}^H(\widehat{\mathbf{Z}}_\rho) = \widehat{\mathbf{Z}}_{P-H}$ is the right bubble chain of $\mathbf{F}^H(\mathcal{O}')$ – this is impossible.

Let us now prove that either λ or ρ is a finite sequence.

Case 1: assume $J = \overline{\mathcal{O}'} \cap \overline{\mathbf{Z}} \neq \emptyset$ and there is $y \in J$ such that the subarc $[y, c_P]$ of $\partial\mathbf{Z}$ contains no critical points of generation $< P$. Since $[y, c_P]$ and $\partial^c\mathbf{Z}_P \setminus \{c_P\}$ contain no branch points of the tree $\mathbf{F}^{-P}(\partial\mathbf{Z})$, we obtain that $\widehat{\mathbf{Z}}_P$ is either \mathbb{B}_λ or \mathbb{B}_ρ .

Case 2: assume, more generally, $J = \overline{\mathcal{O}'} \cap \overline{\mathbf{Z}} \neq \emptyset$. Choose $y \in J$. There are at most finitely many critical points in $[y, c_P]$ of generation $< P$. Then the generation of these critical points is less than some $R < P$. Then $[\mathbf{F}^R(y), c_{P-R}]$ contains no critical points of generation $< P - R$; i.e. $\mathbf{F}^R(\mathcal{O}')$ satisfies Case 1. Therefore, either $\mathbf{F}^R(\mathbb{B}_\lambda)$ or $\mathbf{F}^R(\mathbb{B}_\rho)$ is a finite chain; this implies that either \mathbb{B}_λ or \mathbb{B}_ρ is a finite chain.

For a general lake \mathcal{O}' consider $R < P$ such that $\overline{\mathbf{F}^R(\mathcal{O}')}$ intersects $\partial\mathbf{Z}$. By Case 2, either $\mathbf{F}^R(\mathbb{B}_\lambda)$ or $\mathbf{F}^R(\mathbb{B}_\rho)$ is a finite chain, implying the desired. \square

Consider a bubble \mathbf{Z}_s where $s = (P_1, P_2, \dots, P_n) \in \mathbb{T}_{>0}^n$. Write $P = P_1 + \dots + P_n$. Let $\gamma \subset \mathbf{F}^{-P}(\partial\mathbf{Z})$ be the unique tree-geodesic connecting \emptyset to c_s which is the root of \mathbf{Z}_s . Denote by $\partial_-^c\mathbf{Z}_s$ and $\partial_+^c\mathbf{Z}_s$ two connected components of $\partial^c\mathbf{Z}_s \setminus \{c_s\}$ enumerated so that the triple $\partial_-^c\mathbf{Z}_s, \gamma, \partial_+^c\mathbf{Z}_s$ has counterclockwise orientation at c_s .

There are unique lakes $\mathcal{O}_-(s)$ and $\mathcal{O}_+(s)$ of generation P such that

$$\partial^c\mathcal{O}_-(s) \supset \partial_-^c\mathbf{Z}_s \quad \text{and} \quad \partial^c\mathcal{O}_+(s) \supset \partial_+^c\mathbf{Z}_s$$

because $\partial_-^c\mathbf{Z}_s$ and $\partial_+^c\mathbf{Z}_s$ have no critical points of generation $\leq P$. We define $\mathbb{B}_{\lambda(s)}$ to be the left bubble chain of $\mathcal{O}_-(s)$ and we define $\mathbb{B}_{\rho(s)}$ to be the right bubble chain of $\mathcal{O}_+(s)$, see Figure 21.

We call $\mathcal{O}_-(s)$ the *left lake* of \mathbf{Z}_s and we call $\mathcal{O}_+(s)$ the *right lake* of \mathbf{Z}_s . By construction, $\mathbb{B}_{\lambda(s)}$ and $\mathbb{B}_{\rho(s)}$ are the closest to \mathbb{B}_s bubble chains of generation at most P . The next lemma implies that every lake is of the form $\mathcal{O}_\pm(s)$ for a unique s .

Lemma 5.8. *For every \mathbf{Z}_s the bubble chains $\mathbb{B}_{\lambda(s)}$ and $\mathbb{B}_{\rho(s)}$ are infinite chains of generation $|s| = P_1 + P_2 + \dots + P_n$.*

For every proper lake \mathcal{O}' there is a unique \mathbf{Z}_s , $s = (P_1, \dots, P_n)$, $n \geq 1$ such that either $\mathcal{O}' = \mathcal{O}_-(s)$ or $\mathcal{O}' = \mathcal{O}_+(s)$.

Proof. The first claim follows immediately from Lemma 5.7.

By Lemma 5.7, either the left bubble chain \mathbb{B}_λ of \mathcal{O}' or its right bubble chain \mathbb{B}_ρ is a finite chain. In the former case, $\mathcal{O}' = \mathcal{O}_+(\lambda)$; in the latter case, $\mathcal{O}' = \mathcal{O}_-(\rho)$. \square

For a finite or infinite sequence $s = (P_1, P_2, \dots)$ let us write $\mathbf{t}s := (\mathbf{t}P_1, \mathbf{t}P_2, \dots)$

Lemma 5.9. *The self-similarity A_\star preserves the Fatou and Julia sets of the fixed maximal prepacman \mathbf{F} ; moreover for every finite sequence s we have:*

- $A_\star(c_s) = c_{\mathbf{t}s}$;
- $A_\star(\mathbf{Z}_s) = \mathbf{Z}_{\mathbf{t}s}$;
- $A_\star(\mathbb{B}_s) = \mathbb{B}_{\mathbf{t}s}$, here s is either a finite or an infinite sequence;
- $A_\star(\mathbf{L}_s) = \mathbf{L}_{\mathbf{t}s}$;
- $A_\star(\tilde{\alpha}_s) = \tilde{\alpha}_{\mathbf{t}s}$.

Proof. Recall that A_\star conjugates \mathbf{F}^P to $\mathbf{F}^{\mathbf{t}P}$; hence A_\star preserves the Fatou and Julia sets. Since $A_\star(\partial\mathbf{Z}) = \partial\mathbf{Z}$, we have $A_\star(c_P) = c_{\mathbf{t}P}$. As a consequence, $A_\star(\mathbf{Z}_P) = \mathbf{Z}_{\mathbf{t}P}$ and $A_\star(\tilde{\alpha}_P) = \tilde{\alpha}_{\mathbf{t}P}$. Since $A_\star(\partial^c\mathbf{Z}_P) = \partial^c\mathbf{Z}_{\mathbf{t}P}$, we also have $A_\star(c_{(P,Q)}) = c_{(\mathbf{t}P, \mathbf{t}Q)}$ and we can proceed by induction on $|s|$. \square

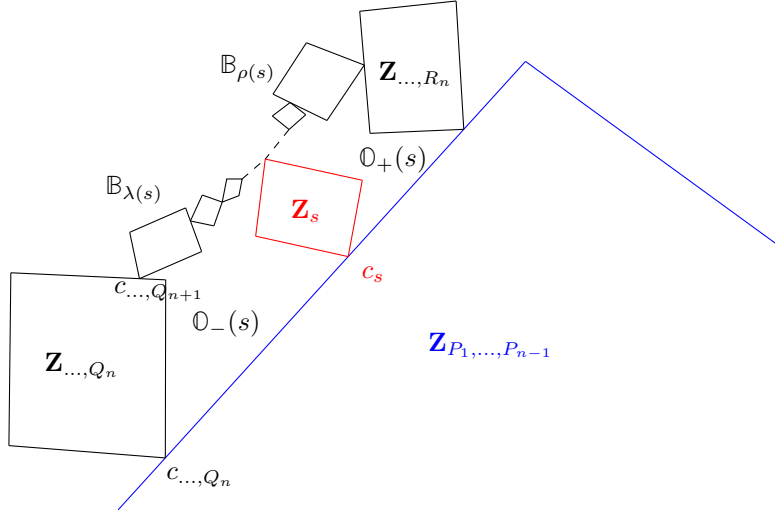

FIGURE 21. The bubble chains \mathbb{B}_λ and \mathbb{B}_ρ are the closest to \mathbf{Z}_s of generation $\leq P$ (see also Figure 25). By Lemma 5.11, \mathbb{B}_λ and \mathbb{B}_ρ actually land at the top of \mathbf{Z}_s .

5.4. Boundedness of limbs.

Lemma 5.10. *The closure of every limb is compact.*

Proof. The idea of the proof is illustrated in Figure 22. We will show that there is an $R \in \mathbb{T}_{>0}$ such that $\mathbf{F}^R(\mathbf{S}_0^\# \setminus \mathbf{Z}) \supset \mathbf{S}_{-1}^\# \setminus \mathbf{Z}$. By self-similarity, $\mathbf{F}^{R/t}(\mathbf{S}_{-1}^\# \setminus \mathbf{Z}) \supset \mathbf{S}_{-2}^\# \setminus \mathbf{Z}$. Therefore, if $Q \geq R + R/t + R/t^2 + \dots$, then $\mathbf{F}^Q(\mathbf{S}_0^\# \setminus \mathbf{Z}) = \mathbb{C}$. This implies that some limbs are bounded. Therefore, all the limbs are bounded because they are dynamically related. Let us provide more details.

Consider the dynamical plane of $f: U \rightarrow V$. For every n , there is a gluing map $\rho_n: \mathbf{S}_n^\# \rightarrow V \setminus \{\alpha\}$ projecting $\mathbf{F}_n^\#$ to f . The map ρ_n glues two distinguished sides of $\mathbf{S}_n^\#$ to γ_1 ; the preimage of α is at infinity. Since \mathbf{F} is a renormalization fixed point, $\mathbf{S}_{n-1}^\#$ is a rescaling of $\mathbf{S}_n^\#$; we also recall that:

- $\mathbf{S}_n^\# \subset \mathbf{S}_{n-1}^\#$; and
- $\bigcup_n \mathbf{S}_n^\# = \mathbb{C}$.

Choose a big $n \ll 0$ and let X and Y be the open sectors in the dynamical plane of f obtained by projecting $\mathbf{S}_0^\#$ and $\mathbf{S}_{-1}^\#$ via $\rho_n: \mathbf{S}_n^\# \rightarrow V$, see Figure 23. Write $W := Y \setminus \overline{Z}_*$ and $I := X \cap \partial Z_*$ (depicted in blue bold in Figure 23); and let J be a slightly shrunk version of I .

Claim 1. *There is an $M > 0$ such that the following property holds. If $m \geq M$, $x \in J$, and $f^m(x) \in \partial W$, then W has a conformal pullback W_{-m} along the orbit $x, f(x), \dots, f^m(x) \in W$ such that $W_{-m} \subset X$.*

We remark that if x is a critical point, then there are two choices for W_{-m} : on the left and on the right of c_0 .

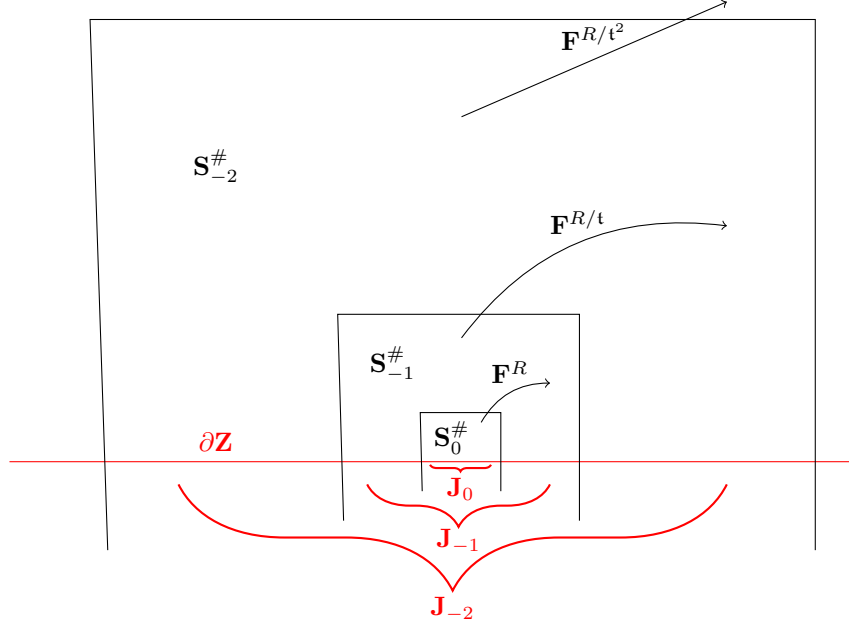

FIGURE 22. Illustration to the proof of Lemma 5.10: it takes R/t^n iterates to cover $\mathbf{S}_{-n-1}^\# \setminus \mathbf{Z}$ from a domain in $\mathbf{S}_{-n}^\# \setminus \mathbf{Z}$.

Proof. Let W_{-k} be the pullback of W along the orbit of $f^{-k}(x), \dots, f^m(x)$. Let us show that W_{-k} does not intersect the forbidden boundary $\partial^{\text{frb}}U$ for all $k \in \{m-1, \dots, 0\}$; this will imply that W_{-m} is a conformal pullback.

Recall from §3.2.5 that f has a lamination by external rays. Choose two rays R_- and R_+ landing at \bar{Z}_* such that R_- is slightly on the left of W and R_+ is slightly on the right of W . Since $n \ll 0$, the difference δ between the external angles of R_- and R_+ is small.

Let $R_{-k,-}$ and $R_{-k,+}$ be the preimages of R_- and R_+ under f^{m-k} such that $R_{-k,-}$ is slightly on the left of W_{-k} and $R_{-k,+}$ is slightly on the right of W_{-k} . Then the difference between the external angles of $R_{-k,-}$ and $R_{-k,+}$ is $\delta/2^k$; i.e. W_{-k} has a small angular size. Recall that $\gamma_- \cup \gamma_+ \setminus \bar{Z}'_*$ are external rays that are disjoint from \bar{Z}_* , see §3.2.5. Since ∂W_{-k} intersects ∂Z_* , we obtain that ∂W_{-k} is disjoint from $\partial^{\text{frb}}U$. This shows that $f^m: W_{-m} \rightarrow W$ is conformal.

If m is big, then W_{-m} is contained in a small neighborhood of the non-escaping set K between $R_{-m,-}$ and $R_{-m,+}$. Since K is locally connected and the difference between the external angles of $R_{-m,-}$ and $R_{-m,+}$ is small, the set W_{-m} is contained in a small neighborhood of J ; hence $W_{-m} \subset X$. \square

Suppose \mathbf{J}_n corresponds to J under the identification $\mathbf{S}_n^\# \simeq X$, see Figure 22. As a corollary of Claim 1 we have:

Claim 2. *There is power-triple $R > 0$ with $\mathbf{F}^R(\mathbf{J}_0) \subset \mathbf{J}_{-1}$ such that the following property holds. If $x \in \mathbf{J}_0$ and $\mathbf{F}^P(x) \in \mathbf{S}_{-1}^\#$ for some $P \geq R$, then there is an open set $W_P \subset \mathbf{S}_0$ with $x \in \partial W_P$ such that \mathbf{F}^P maps W_P conformally onto $\text{int}(\mathbf{S}_{-1}^\# \setminus \mathbf{Z})$.*

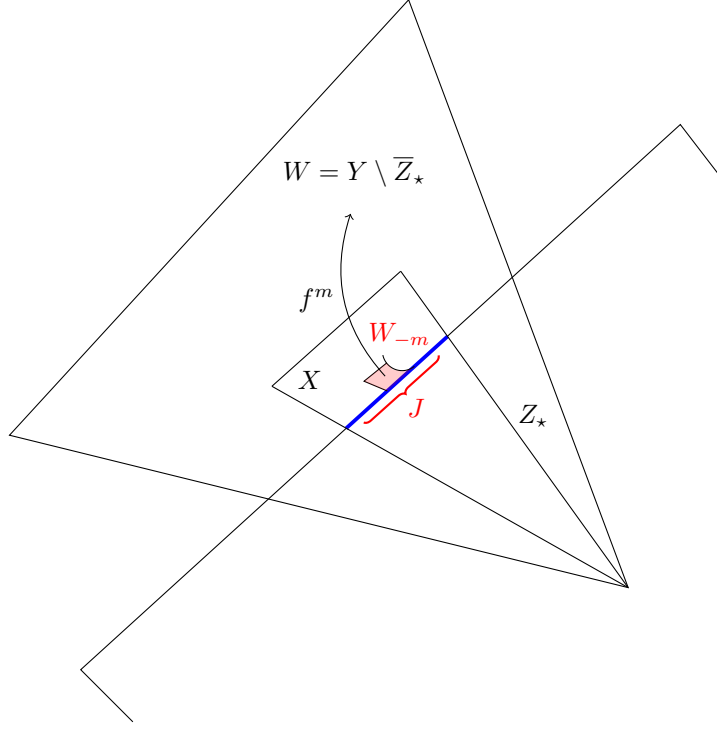

FIGURE 23. Illustration to Claim 1: the disk $W = Y \setminus \bar{Z}_*$ pullbacks along the orbit of x to the disk $W_{-m} \subset X$.

Proof. By Lemma 5.2, the cascade $(\mathbf{F}^P \mid \partial \mathbf{Z})_{P \in \mathbb{T}}$ is conjugate to the cascade of translations $(T^P \mid \mathbb{R})_{P \in \mathbb{T}}$. Therefore, we can choose a sufficiently big R with $\mathbf{F}^R(\mathbf{J}_0) \subset \mathbf{J}_{-1}$.

Since $\mathbf{F}^P(x) \in \mathbf{S}_{-1}^\#$, we can write

$$\mathbf{F}^P = \mathbf{f}_{-1, \iota(1)}^\# \circ \mathbf{f}_{-1, \iota(2)}^\# \circ \cdots \circ \mathbf{f}_{-1, \iota(m)}^\#, \quad \iota(j) \in \{-, +\}$$

because the prepacmap $\mathbf{f}_{-1, \pm}^\#: \mathbf{U}_\pm^\# \rightarrow \mathbf{S}_{-1}^\#$ realizes the first return of the cascade $\mathbf{F}^{\geq 0}$. If R is sufficiently big, then $m \geq M$, where M is the constant from Claim 1. The statement now follows from Claim 1. \square

By self-similarity, we can shift indices in Claim 2: we can replace $\mathbf{J}_0, \mathbf{J}_{-1}, \mathbf{S}_{-1}^\#$ by $\mathbf{J}_n, \mathbf{J}_{n-1}, \mathbf{S}_{n-1}^\#$ and replace R by R/t^{-n} . Inductively applying Claim 2, we obtain:

Claim 3. *There is power-triple $Q > 0$ such that for every $n < 0$ the following property holds. Let $x \in \mathbf{J}_0$ be a point such that $\mathbf{F}^P(x) \in \mathbf{S}_n^\#$ with $P \geq Q$. Then there is an open set $W \subset \mathbf{S}_0$ with $x \in \partial W$ such that \mathbf{F}^P maps W conformally to $\text{int}(\mathbf{S}_n^\# \setminus \mathbf{Z})$.*

Proof. Let R be a power-triple from Claim 2. Choose a power-triple Q with

$$Q > R + R/t + R/t^2 + \dots,$$

see Lemma 4.1. Write $x_0 = x$ and for $j \in \{0, -1, \dots, n+2\}$ inductively set $P_j := R/t^{-j}$ and $x_{j-1} := \mathbf{F}^{P_j}(x_j)$. Finally set

$$P_{n+1} := P - P_0 - P_1 - \dots - P_{n+2} \geq R/t^{n+1}.$$

and $x_n = \mathbf{F}^{P_{n+1}}(x_{n+1})$. Since $P_{n+1} \geq R/t^{-n-1}$, we can apply Claim 2 and construct $W_{n+1} \subset \mathbf{S}_{n+1}^\# \setminus \mathbf{Z}$ so that $x_{n+1} \in \partial W_{n+1}$ and $\mathbf{F}^{P_{n+1}}$ maps W_{n+1} conformally to $\mathbf{S}_n^\# \setminus \mathbf{Z}$. Applying induction from upper levels to deeper ones, we construct $W_j \subset \mathbf{S}_j^\# \setminus \mathbf{Z}$ such that $x_j \in \partial W_j$ and \mathbf{F}^{P_j} maps W_j conformally to W_{j-1} . Therefore, \mathbf{F}^P maps W_0 conformally to $\mathbf{S}_n^\# \setminus \mathbf{Z}$. \square

Consider a limb \mathbf{L}_M ; recall that its root is denoted by c_M . Choose a big $T \geq Q+M$ such that the critical point c_T is in \mathbf{J}_0 . Then c_T is the root of \mathbf{L}_T and \mathbf{F}^{T-M} maps \mathbf{L}_T to \mathbf{L}_M .

By Claim 3, for all $n \ll 0$ the connected component of $\mathbf{S}_n^\# \cap \mathbf{L}_M$ containing c_M can be pulled back along $\mathbf{F}^{T-M}: c_T \mapsto c_M$ and, moreover, the pullback is within \mathbf{S}_0 . Since $n \ll 0$ is arbitrary, the pullbacks of $\mathbf{S}_n^\# \cap \mathbf{L}_M$ exhaust \mathbf{L}_T , and we obtain that $\mathbf{L}_T \subset \mathbf{S}_0$.

By self-similarity, the limb \mathbf{L}_{T/t^m} is within $\mathbf{S}_{-m}^\#$ for all $m \geq 0$. For every $H > 0$ choose an $m \geq 0$ with $H \geq T/t^m$. Then \mathbf{F}^{H-T/t^m} maps \mathbf{L}_H conformally to \mathbf{L}_{T/t^m} . Since \mathbf{L}_{T/t^m} is bounded, so is \mathbf{L}_H by σ -properness. \square

5.5. Alpha-points. Consider a finite sequence $s = (P_1, P_2, \dots, P_n)$ in $\mathbb{T}_{>0}$ and the corresponding bubble \mathbf{Z}_s . Write $P = |s| = P_1 + \dots + P_n$. Recall from (5.1) that $\tilde{\alpha}_s$ denotes the accumulating set of \mathbb{B}_s . By Lemma 5.10, $\tilde{\alpha}_s$ is a compact subset of $\mathbf{Esc}_P(\mathbf{F})$, which is disjoint from $\partial\mathbf{Z}$.

Lemma 5.11. *The set $\tilde{\alpha}_s = \{\alpha_s\}$ is a singleton. Moreover, α_s is the landing point of $\mathbb{B}_s, \mathbb{B}_{\lambda(s)}, \mathbb{B}_{\rho(s)}$. We have:*

$$\partial\mathbb{O}_-(s) = \partial^c\mathbb{O}_-(s) \cup \tilde{\alpha}_s \quad \text{and} \quad \partial\mathbb{O}_+(s) = \partial^c\mathbb{O}_+(s) \cup \tilde{\alpha}_s,$$

$\mathbb{O}_-(s)$ and $\mathbb{O}_+(s)$ are bounded sets, and $\bar{\mathbf{Z}}_s, \bar{\mathbb{O}}_-(s), \bar{\mathbb{O}}_+(s)$ are closed topological disks.

Proof. Consider a critical point $c_P \in \partial\mathbf{Z}$ of generation P . Since all $(\mathbb{O}_-(s), \mathbf{Z}_s, (\mathbb{O}_+(s)))$ are dynamically related it is sufficient to verify the statement for $(\mathbb{O}_-(P), \mathbf{Z}_P, (\mathbb{O}_+(P)))$.

By Lemma 5.9, $c_{tP} = A_\star(c_P)$, and

$$(5.2) \quad A_\star \text{ maps } (\mathbb{O}_-(P), \mathbf{Z}_P, \mathbb{O}_+(P)) \text{ to } (\mathbb{O}_-(tP), \mathbf{Z}_{tP}, \mathbb{O}_+(tP)).$$

On the other hand (see Figure 24), by the classification of bubbles attached to \mathbf{Z} :

$$(5.3) \quad \mathbf{F}^{(t-1)P} \text{ maps } (\mathbb{O}_-(tP), \mathbf{Z}_{tP}, \mathbb{O}_+(tP)) \text{ to } (\mathbb{O}_-(P), \mathbf{Z}_P, \mathbb{O}_+(P)).$$

Let \mathbb{O}_1 be the lake of generation $(t-1)P/t$ containing $\mathbb{O}_-(P) \cup \mathbf{Z}_P \cup \mathbb{O}_+(P)$. Then the lake $A_\star(\mathbb{O}_1) \supset \mathbb{O}_-(tP) \cup \mathbf{Z}_{tP} \cup \mathbb{O}_+(tP)$ has generation $(t-1)P$. By the Schwarz lemma,

$$(5.4) \quad \mathbf{F}^{(t-1)P} \circ A_\star: \mathbb{O}_1 \rightarrow \mathbb{O} \quad (\text{where } \mathbb{O} = \mathbb{C} \setminus \mathbf{Z} \text{ is an ocean})$$

expands the hyperbolic metric of \mathbb{O} . Since $\tilde{\alpha}_P$ is a set compactly contained in \mathbb{O} (because $\tilde{\alpha}_P$ is a compact subset of $\mathbf{Esc}_P(\mathbf{F})$, which is disjoint from $\partial\mathbf{Z}$) and since $\tilde{\alpha}_P$ is invariant under (5.4), we see that $\tilde{\alpha}_P = \{\alpha_P\}$ is a singleton and α_P is a repelling fixed point of (5.4).

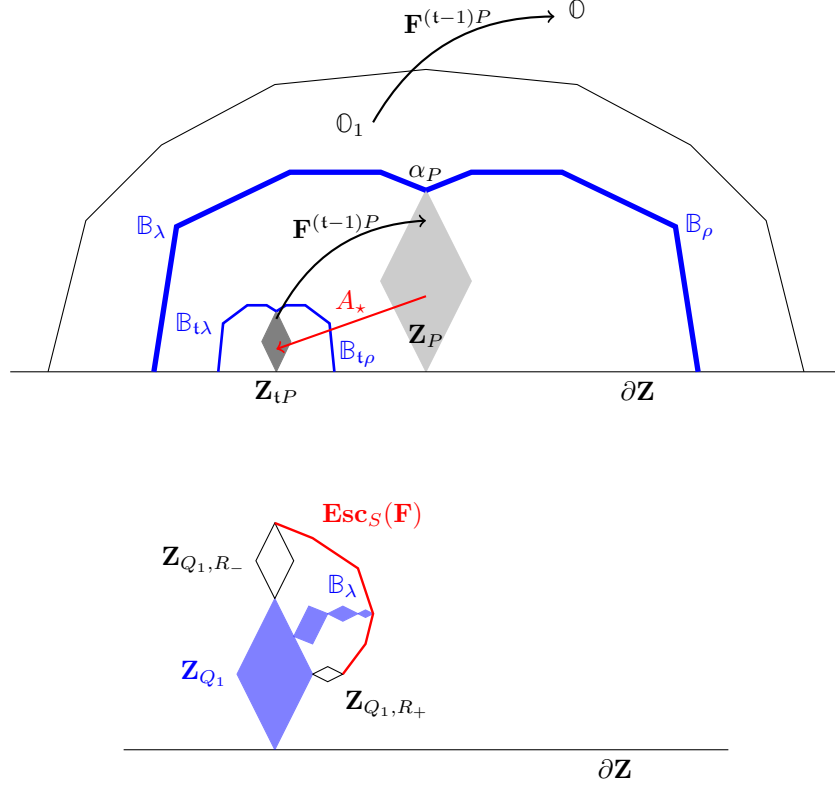

FIGURE 24. Illustration to the proof of Lemma 5.11 (see also Figure 25): the accumulating set of $\mathbf{Z}_P, \mathbb{B}_\lambda, \mathbb{B}_\rho$ is invariant under the expanding map $\mathbf{F}^{(t-1)P} \circ A_*: \mathbb{O}_1 \rightarrow \mathbb{O}$; thus $\mathbf{Z}_P, \mathbb{B}_\lambda$, and \mathbb{B}_ρ land at α_P . Bottom: $\mathbf{Esc}_S(\mathbf{F}) \cup \mathbf{Z}_{Q_1, R_-} \cup \mathbf{Z}_{Q_1} \cup \mathbf{Z}_{Q_1, R_+}$ separates the accumulating set of \mathbb{B}_λ from $\partial\mathbf{Z}$.

Let $\tilde{\alpha}_P^-$ be the accumulating set of $\mathbb{B}_{\lambda(s)}$. Let us argue that $\tilde{\alpha}_P^- \in \mathbb{O}$. By Lemma 5.10, $\tilde{\alpha}_P^-$ is a compact subset of \mathbb{C} . Write $\lambda(s) = (Q_1, Q_2, \dots)$ and choose two R_- and R_+ such that \mathbf{Z}_{Q_1, R_-} is on the left of \mathbf{Z}_{Q_1, Q_2} while \mathbf{Z}_{Q_1, R_+} is on the right of \mathbf{Z}_{Q_1, Q_2} , see Figure 24 (bottom). Set $S = \max\{Q_1 + R_-, Q_2 + R_+\}$. Since every connected component of $\mathbf{Esc}_P(\mathbf{F})$ is unbounded (see §4.9),

$$\mathbf{Esc}_S(\mathbf{F}) \cup \hat{\mathbf{Z}}_{Q_1} \cup \hat{\mathbf{Z}}_{Q_1, R_-} \cup \hat{\mathbf{Z}}_{Q_1, R_+}$$

separates $\tilde{\alpha}_P^- \setminus \mathbf{Esc}_S(\mathbf{F})$ from \mathbf{Z} .

Since $\tilde{\alpha}_P^-$ is also invariant under (5.4) (because of (5.2) and (5.3)), we obtain that $\tilde{\alpha}_P^- = \tilde{\alpha}_P = \{\alpha_P\}$; i.e. $\mathbb{B}_{\lambda(s)}$ lands at α_P . Similarly, $\mathbb{B}_{\rho(s)}$ lands at α_P . As a consequence, $\bar{\mathbb{Z}}_s, \bar{\mathbb{O}}_-(s), \bar{\mathbb{O}}_+(s)$ are closed topological disks. \square

We say that $\{\alpha_s\}$ are *alpha-points*. They are viewed as preimages of α :

Lemma 5.12. *Suppose $\gamma: [0, 1) \rightarrow \mathbf{Z}$ is a curve that goes to ∞ . Let $\Gamma = \{\gamma_i\}$ be the set of lifts of γ under \mathbf{F}^T , where $T \in \mathbb{T}_{>0}$. There is a unique lift $\gamma_0 \in \Gamma$ such that $\gamma_0 \subset \mathbf{Z}$. Every remaining $\gamma_i \in \Gamma \setminus \{\gamma_0\}$ is within \mathbf{Z}_s with $0 < |s| \leq T$ and,*

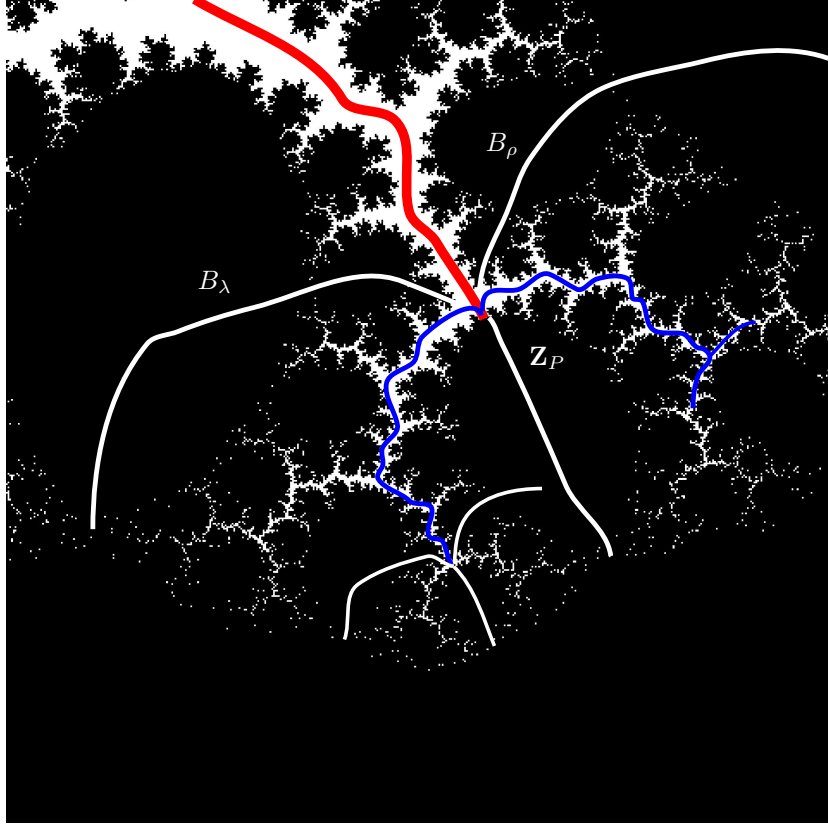

FIGURE 25. Illustration to the proof of Lemma 5.11 (compare with Figure 16): $\mathbf{Z}_P, B_\lambda, B_\rho$ land at α_P that belongs to $\mathbf{Esc}_P(\mathbf{F})$ (partially marked red). There are two branches of $\mathbf{Esc}_{tP}(\mathbf{F}) \setminus \mathbf{Esc}_P(\mathbf{F})$ (partially marked blue) at α_P . One of the ends of the left branch is α_{tP} ; this point is the landing point of $\mathbf{Z}_{tP}, B_{t\lambda}, B_{t\rho}$.

moreover, γ_i lands at α_s . Conversely, for every α_s with $|s| \leq T$ there is a unique $\gamma_i \in \Gamma$ such that γ_i lands at α_i .

Proof. Since \mathbf{Z}_s with $|s| \leq T$ are univalent preimages of \mathbf{Z} , every γ_i is contained in a certain \mathbf{Z}_s . Moreover, γ_i accumulates at $\tilde{\alpha}_s = \{\alpha_s\}$ which is a singleton by Lemma 5.11; i.e. γ_i lands at α_s . \square

Lemma 5.13. *If $\alpha_s = \alpha_v$, then $s = v$.*

Proof. If α_s and α_v have different generations, then $\alpha_v \neq \alpha_s$. Suppose that $|s| = |v|$ and write $s = (P_1, P_2, \dots, P_n)$ and $v = (Q_1, Q_2, \dots, Q_n)$. Choose $R < |s|$ such that $R > \max\{P_1 + \dots + P_{n-1}, Q_1 + \dots + Q_{n-1}\}$. Then $\mathbf{F}^R(\mathbf{Z}_s) = \mathbf{F}^R(\mathbf{Z}_v) = \mathbf{Z}_{|s|-R}$. Since $\bar{\mathbf{Z}}_{|s|-R}$ does not contain a critical value of \mathbf{F}^R , we obtain that \mathbf{Z}_s and \mathbf{Z}_v are different degree one preimages of $\mathbf{Z}_{|s|-R}$. \square

Corollary 5.14 (The tree structure of $\{\bar{\mathbf{Z}}_s\}$). *Suppose that $\bar{\mathbf{Z}}_v \cap \bar{\mathbf{Z}}_w \neq \emptyset$ for $|w| \geq |v|$ and $w \neq v$. Then $c_w \in \partial\mathbf{Z}_v$ and $\bar{\mathbf{Z}}_v \cap \bar{\mathbf{Z}}_w = \{c_w\}$.*

For every two closed bubbles $\bar{\mathbf{Z}}_v \neq \bar{\mathbf{Z}}_w$, there is a unique sequence of pairwise different closed bubbles $\bar{\mathbf{Z}}_{s(1)}, \bar{\mathbf{Z}}_{s(2)}, \dots, \bar{\mathbf{Z}}_{s(n)}$ such that

- $\bar{\mathbf{Z}}_{s(i)}$ intersects $\bar{\mathbf{Z}}_{s(i+1)}$;
- $s(1) = v$ and $s(n) = w$.

Proof. By Lemma 5.13, $\bar{\mathbf{Z}}_v$ and $\bar{\mathbf{Z}}_w$ do not intersect at their alpha-points. By Lemma 5.5, $\bar{\mathbf{Z}}_v$ and $\bar{\mathbf{Z}}_w$ can only intersect when $\bar{\mathbf{Z}}_v$ contains the root of $\bar{\mathbf{Z}}_w$.

The second claim follows from Lemma 5.5. \square

Since every lake \mathcal{O}' is either $\mathcal{O}_-(s)$ or $\mathcal{O}_+(s)$ for a certain sequence s (Lemma 5.8), we have:

Corollary 5.15. *The closure of every proper lake is a compact subset of \mathbb{C} . For a proper lake \mathcal{O}' , we have $\partial\mathcal{O}' = \partial^c\mathcal{O}' \cup \{\alpha'\}$, where α' is an alpha-point of the same generation as \mathcal{O}' .* \square

5.6. Lakes exhaust the ocean. Choose $P \in \mathbb{T}_{>0}$ and let $\mathcal{O}(P)$ be the lake of generation P such that $\partial\mathcal{O}(P) \ni 0$. Then $\partial\mathcal{O}(P)$ also contains an arc $J \ni 0$ of $\partial\mathbf{Z}$ such that 0 is not an endpoint of J . It follows that $\mathcal{O}(t^n P) = A_{\mathbf{x}}^n(\mathcal{O}(P))$ also contains 0 on its boundary, and we have (see Figure 26)

$$(5.5) \quad \bigcup_{n < 0} \mathcal{O}(t^n P) = \mathcal{O}.$$

Let us denote by $\alpha(t^n P)$ the unique alpha-point in $\partial\mathcal{O}(t^n P)$, see Corollary 5.15.

Lemma 5.16. *Let I be a connected component of $\mathbf{Esc}_P(\mathbf{F})$. Then I contains $\alpha(t^n P)$ for all sufficiently big $n \ll 0$.*

If J is a connected subset of $\mathbf{Esc}_P(\mathbf{F})$ such that $J \cap \mathcal{O}(t^n P) \neq \emptyset$ but $J \not\ni \alpha(t^n P)$, then $J \subset \mathcal{O}(t^n P)$; in particular, J is bounded.

Proof. Recall from §4.9 that every connected component I of $\mathbf{Esc}_Q(\mathbf{F})$ is unbounded. Thus if I intersects $\overline{\mathcal{O}(t^n P)}$, then $I \ni \alpha_{t^n P}$ (otherwise $\partial\mathcal{O}(t^n P)$ encloses I by Corollary 5.15). By (5.5) I intersects $\mathcal{O}(t^n P)$ for $n \ll 0$. Therefore, I contains all $\alpha(t^m P)$ for $m \geq n$.

In the second claim, J is surrounded by $\partial\mathcal{O}(t^n P)$; thus $J \subset \mathcal{O}(t^n P)$. \square

Corollary 5.17. *The escaping set $\mathbf{Esc}_Q(\mathbf{F})$ is connected. For every $R > Q$, every connected component of $\mathbf{Esc}_R(\mathbf{F}) \setminus \mathbf{Esc}_Q(\mathbf{F})$ is bounded.* \square

Proof. By Lemma 5.16, every two connected components contain $\alpha(t^n P)$ for $n \ll 0$; thus $\mathbf{Esc}_Q(\mathbf{F})$ has a single connected component.

If J is a connected component of $\mathbf{Esc}_R(\mathbf{F}) \setminus \mathbf{Esc}_Q(\mathbf{F})$, then J intersects $\mathcal{O}(t^n P)$ for $n \ll 0$ but does not contain $\alpha(t^n P)$ for $n \ll 0$; thus J is bounded. \square

Similarly to Lemma 5.12, we have:

Lemma 5.18. *Let $\gamma: [0, 1) \rightarrow \mathcal{O}$ is a curve that goes to ∞ . Let $\{\gamma_i\}$ be the set of lifts of γ under \mathbf{F}^T with $T \in \mathbb{T}_{>0}$. Then every γ_i is contained in a unique $\mathcal{O}_\iota(s)$ with $\iota \in \{-, +\}$ and $|s| = T$. Moreover, γ_i lands at α_s . Conversely, every $\mathcal{O}_\iota(s)$ with $|s| = T$ contains a unique γ_i which lands at α_s .*

For $R > T$ every connected component \mathbf{L} of $\mathbf{Esc}_R(\mathbf{F}) \setminus \mathbf{Esc}_T(\mathbf{F})$ is contained in a unique $\mathcal{O}_\iota(s)$ with $\iota \in \{-, +\}$ and $|s| = T$. Moreover, \mathbf{L} is a lift

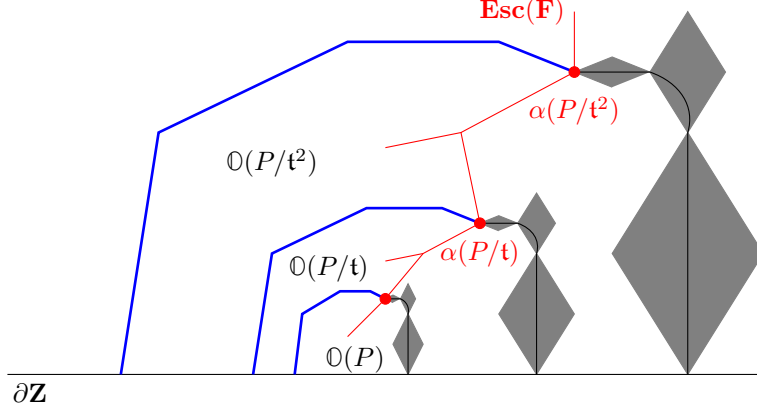

FIGURE 26. Lakes $\mathbb{O}(t^n P)$ cover \mathbb{C} . The boundary $\partial\mathbb{O}(t^n P)$ contains a unique point $\alpha(t^n P)$ in $\mathbf{Esc}(\mathbf{F})$. Therefore, every connected component of $\mathbf{Esc}_P(\mathbf{F})$ intersecting $\mathbb{O}(t^n P)$ also contains $\alpha(t^n P)$. Each bubble chain contains a skeleton (black), see §5.7

of $\mathbf{Esc}_{R-T}(\mathbf{F})$ under \mathbf{F}^T and \mathbf{L} is attached to α_s : $\mathbf{L} \cup \{\alpha_s\}$ is compact and connected. Conversely, for every α_s with $|s| = T$ there are two connected components of $\mathbf{Esc}_R(\mathbf{F}) \setminus \mathbf{Esc}_T(\mathbf{F})$ attached to α_s .

Proof. Every γ_i is contained in a unique lake which is of the form $\mathbb{O}_l(s)$ by Lemma 5.8. By Lemma 5.11, γ_i lands at α_s .

Similarly, connected components of $\mathbf{Esc}_R(\mathbf{F}) \setminus \mathbf{Esc}_T(\mathbf{F})$ are in bijection with lifts of $\mathbf{Esc}_{R-T}(\mathbf{F})$ under \mathbf{F}^T and are in certain $\mathbb{O}_l(s)$ with $|s| = T$. By Lemma 5.11, every component of $\mathbf{Esc}_R(\mathbf{F}) \setminus \mathbf{Esc}_T(\mathbf{F})$ is attached to a certain α_s with $|s| = T$. \square

5.7. The tree-like structure of $\mathbf{Esc}(\mathbf{F})$. In this subsection, we will first discuss the combinatorics of alpha-points and then use these cut points to define external chains in $\mathbf{Esc}(\mathbf{F})$. We will introduce two orders on alpha-points: the tree order “ \succeq ” and the ambient order “ \leq ”. Informally, $\alpha_v \prec \alpha_w$ if α_v is closer to ∞ in $\mathbf{Esc}(\mathbf{F})$, and $\alpha_v < \alpha_w$ if α_v is on the “left” of α_w with respect to $\mathbb{C} \setminus \mathbf{Esc}(\mathbf{F})$. Proposition 5.20 relates these two orders: the separation in “ \prec ” is equivalent to the separation in “ $<$ ”.

Consider two sequences $v = (P_1, P_2, \dots)$ and $w = (Q_1, Q_2, \dots)$; each sequence can be finite or infinite. Let

$$v \Delta w = (P_1, \dots, P_m)$$

be the largest common prefix of v and w ; i.e. $P_i = Q_i$ for $i \leq m$ but $P_{m+1} \neq Q_{m+1}$. If $v = w$, then $v \Delta w = v = w$.

We write $\alpha_v \succeq \alpha_w$ if

$$\alpha_v \in \overline{\mathbb{O}_-(w) \cup \mathbb{O}_+(w)}.$$

We call “ \succeq ” the *tree order*. If $\alpha_s \in \mathbb{O}_-(w)$ and $\alpha_v \in \mathbb{O}_+(w)$, then we say that α_s and α_v are \succ -separated by α_w . In other words, a_w is the biggest element with respect to the tree order such that $a_v \not\succeq a_w$ and $a_s \not\succeq a_w$.

Given a bubble \mathbf{Z}_s and two different points $x, y \in \partial\mathbf{Z}_s$, let us write by $(x, y)_{\mathfrak{F}} \subset \mathbf{Z}_s$ the unique hyperbolic geodesic joining x and y within the Fatou component \mathbf{Z}_s

(recall that $\overline{\mathbf{Z}}_s$ is a closed topological disk by Lemma 5.11). Similarly, for $x, y \in \partial\mathbf{Z}$, the arc $(x, y)_{\mathfrak{F}}$ is the hyperbolic geodesic of \mathbf{Z} connecting x and y . We also denote by $(0, \infty)_{\mathfrak{F}}$ the hyperbolic geodesic of \mathbf{Z} connecting 0 and ∞ .

Given a finite chain $s = (P_1, P_2, \dots, P_n)$, we define the *skeleton* of \mathbb{B}_s as

$$\mathfrak{T}_s := [0, c_{P_1}]_{\mathfrak{F}} \cup [c_{P_1}, c_{P_2}]_{\mathfrak{F}} \cup \dots \cup [c_{P_{n-1}}, c_{P_n}]_{\mathfrak{F}} \cup [c_{P_n}, \alpha_{P_n}]_{\mathfrak{F}},$$

see Figure 26. If $s = (P_1, P_2, \dots)$ is an infinite sequence, then the *skeleton* of \mathbb{B}_s is

$$\mathfrak{T}_s := [0, c_{P_1}]_{\mathfrak{F}} \cup [c_{P_1}, c_{P_2}]_{\mathfrak{F}} \cup [c_{P_2}, c_{P_3}]_{\mathfrak{F}} \cup \dots$$

We view each skeleton as an arc starting at 0. For $v \neq w$, we denote by $c_{v\Delta w}$ the last common point of $\mathfrak{T}_v \cap \mathfrak{T}_w$. By construction, $c_{v\Delta w}$ is either 0 or a critical point. Note also that the union of any number of skeletons is uniquely geodesic. Let us say that \mathfrak{T}_v is on the *left* of \mathfrak{T}_w and *write* $\mathfrak{T}_v < \mathfrak{T}_w$, if $[0, \infty)_{\mathfrak{F}}, \mathfrak{T}_w, \mathfrak{T}_v$ have a counterclockwise orientation around $\mathfrak{T}_w \cap \mathfrak{T}_v$. We say that \mathfrak{T}_w and \mathfrak{T}_v are *<-separated* by \mathfrak{T}_s if either

$$\mathfrak{T}_v < \mathfrak{T}_s < \mathfrak{T}_w \quad \text{or} \quad \mathfrak{T}_v > \mathfrak{T}_s > \mathfrak{T}_w$$

holds.

For an infinite sequence $s = (P_1, P_2, \dots)$, we say that $s(n) := (P_1, P_2, \dots, P_n)$ is the *n*th *truncation* of s . Clearly, $\mathfrak{T}_v, \mathfrak{T}_w$ are *<-separated* by \mathfrak{T}_s if and only if $\mathfrak{T}_v, \mathfrak{T}_w$ are *<-separated* by $\mathfrak{T}_{s(n)}$ for all sufficiently big n .

We also define the order “ $<$ ” on alpha-points: $\alpha_v < \alpha_w$ if and only if $\mathfrak{T}_v < \mathfrak{T}_w$. We call “ $<$ ” the *ambient order*.

Lemma 5.19. *Consider finite distinct skeletons \mathfrak{T}_v and \mathfrak{T}_w .*

- *If $|v| = |w|$, then there is a finite skeleton \mathfrak{T}_s with $|s| < |v|$ such that \mathfrak{T}_v and \mathfrak{T}_w are *<-separated* by \mathfrak{T}_s .*
- *If \mathfrak{T}_v and \mathfrak{T}_w are separated by a finite bubble skeleton of generation $\leq \min\{|v|, |w|\}$, then there is a unique finite skeleton \mathfrak{T}_s with the following properties. The skeletons \mathfrak{T}_v and \mathfrak{T}_w are *<-separated* by \mathfrak{T}_s and $|s| < \min\{|v|, |w|\}$. And if \mathfrak{T}_v and \mathfrak{T}_w are *<-separated* by $\mathfrak{T}_{s'}$, then either $|s'| > |s|$ or $s' = s$.*

Proof. Suppose \mathfrak{T}_v is on the left of \mathfrak{T}_w . Recall (see §5.3) that the infinite bubble chain $\mathbb{B}_{\rho(v)}$ is the closest bubble chain on the right of \mathbb{B}_v of generation $\leq |v|$. Therefore, \mathfrak{T}_v and \mathfrak{T}_w are *<-separated* by $\mathfrak{T}_{\rho(v)}$. For $m \gg 0$, let s be the *m*th truncation of $\rho(v)$. Then \mathfrak{T}_s separates \mathfrak{T}_v and \mathfrak{T}_w and $|s| < |\rho(v)| = |v|$.

For the second claim, set $\tau \in \mathbb{R}_{\geq 0}$ be the infimum over all $|x|$ such that \mathfrak{T}_x separates \mathfrak{T}_v and \mathfrak{T}_w .

Observe first that $\tau < \min\{|v|, |w|\}$. Indeed, let \mathfrak{T}_y be a skeleton separating \mathfrak{T}_v and \mathfrak{T}_w with $|y| \leq \min\{|v|, |w|\}$. Then $|y| = \tau$ and y is finite (otherwise we can truncate y and construct a skeleton of smaller generation that still separates \mathfrak{T}_v and \mathfrak{T}_w). This contradicts to the first claim: there is a finite skeleton of smaller generation between \mathfrak{T}_y and one of $\mathfrak{T}_v, \mathfrak{T}_w$.

We claim that every realization of τ is a finite sequence x . Then it would follow from the first claim that x is unique.

Proof of the statement. Let $\overline{\mathbf{Z}}_{s(1)}, \overline{\mathbf{Z}}_{s(2)}, \dots, \overline{\mathbf{Z}}_{s(n)}$ be a finite sequence of neighboring closed bubbles from Lemma 5.14 connecting $\mathbf{Z}_v = \mathbf{Z}_{s(1)}$ and $\mathbf{Z}_w = \mathbf{Z}_{s(n)}$. For every $s(i)$ let τ_i be the infimum over all $|x|$ such that

- \mathfrak{T}_x separates \mathfrak{T}_v and \mathfrak{T}_w ,

- either $x\Delta v = s(i)$ or $x\Delta w = s(i)$ holds, and
- if $v\Delta w = s(i)$, then $x\Delta v = x\Delta w = s(i)$.

In other words, the infimum is taken over all \mathfrak{T}_x that coincide with one of $\mathfrak{T}_v, \mathfrak{T}_w$ up to $c_{s(i)}$ (if $\mathbf{Z}_{s(i)} = \mathbf{Z}_\emptyset = \mathbf{Z}$, then $c_{s(i)} = 0$). Observe that $\tau_1 \geq |v|$ and $\tau_k \geq |w|$ because every skeleton associated with either τ_1 or τ_2 travels through either c_v or c_w . Therefore, $\tau = \tau_k$ for some $k \in \{2, \dots, n-1\}$.

If \mathfrak{T}_v and \mathfrak{T}_w are $<$ -separated by $\mathfrak{T}_{s(k)}$, then $|s(k)| = \tau_k$ and the claim follows. Otherwise, let $J \subset \partial^c \mathbf{Z}_{s(k)}$ be an open arc between $\bar{\mathbf{Z}}_{s(k-1)}$ and $\bar{\mathbf{Z}}_{s(k+1)}$. By construction, every skeleton associated with τ_k travels through J . Since \bar{J} is disjoint from $\alpha_{s(k)}$, there is a unique point c_y of the smallest generation in J . Therefore, \mathfrak{T}_y is a required skeleton. \square

\square

Proposition 5.20. *Consider $\alpha_w \neq \alpha_v$ with $|v| \geq |w|$. Then the following are equivalent:*

- (1) $\alpha_v \succ \alpha_w$;
- (2) α_v and α_w are not $<$ -separated by α_s with $|s| < |w|$;
- (3) α_v and α_w are not \prec -separated;

Proof. Suppose that $\alpha_v < \alpha_w$; the opposite case is symmetric.

We have $\alpha_v \succ \alpha_w$ if and only if $\alpha_v \in \mathcal{O}_-(w)$. The latter is equivalent to the property that \mathfrak{T}_v and \mathfrak{T}_w are not $<$ -separated by $\mathfrak{T}_{\lambda(w)}$ (where $\mathbb{B}_{\lambda(w)}$ is defined in §5.3). For $m \gg 1$, let s be the m th truncation of $\lambda(w)$. Note that $|s| < |\lambda(w)| = |w|$. Then \mathfrak{T}_v and \mathfrak{T}_w are not $<$ -separated by $\mathfrak{T}_{\lambda(w)}$ if and only if \mathfrak{T}_v and \mathfrak{T}_w are not separated by \mathfrak{T}_s . This proves the equivalence between (1) and (2).

Let us prove that (3) is also equivalent to (1) and (2). If $\alpha_v \succ \alpha_w$, then clearly α_v and α_w are not \prec -separated. Suppose $\alpha_v \not\succeq \alpha_w$. By the first claim, \mathfrak{T}_v and \mathfrak{T}_w are $<$ -separated by a finite skeleton \mathfrak{T}_s with $|s| < |w|$. Using Lemma 5.19 we can assume that \mathfrak{T}_s has the smallest possible generation. Therefore, \mathfrak{T}_v is between $\mathfrak{T}_{\lambda(s)}$ and \mathfrak{T}_s while \mathfrak{T}_w is between $\mathfrak{T}_{\rho(s)}$ and \mathfrak{T}_s . By definition, α_v and α_w are \prec -separated by α_s . \square

Suppose $\alpha_v \succ \alpha_w$. The *external chain* $[\alpha_v, \alpha_w]$ is

$$\mathbf{Esc}_{|v|}(\mathbf{F}) \cap \overline{\mathcal{O}_-(w) \cup \mathcal{O}_+(w)} \setminus \bigcup_{\mathcal{O}_\iota(s) \not\prec \alpha_v} \mathcal{O}_\iota(s),$$

where the union is taken over all $\iota \in \{-, +\}$ and all the sequences s satisfying $\mathcal{O}_\iota(s) \not\prec \alpha_v$. In other words, $[\alpha_v, \alpha_w]$ is obtained from $\mathbf{Esc}(\mathbf{F})$ by chopping off all the lateral decorations at alpha-points.

Lemma 5.21. *We have*

$$[\alpha_v, \alpha_s] = [\alpha_v, \alpha_w] \cup [\alpha_w, \alpha_s] \quad \text{and} \quad [\alpha_v, \alpha_w] \cap [\alpha_w, \alpha_s] = \{\alpha_w\}$$

for all $\alpha_v \succ \alpha_w \succ \alpha_s$, and

$$A_\star[\alpha_w, \alpha_v] = [\alpha_{tw}, \alpha_{tv}]$$

for all $\alpha_v \succ \alpha_w$.

Proof. Since α_w is a cut point between α_v and α_s with respect to the tree order “ \prec ,” we have $[\alpha_v, \alpha_w] \cap [\alpha_w, \alpha_s] = \{\alpha_w\}$. Recall from Lemma 5.18 that components of $\mathbf{Esc}_P \setminus \mathbf{Esc}_{|v|}$ are attached to alpha-points of generation $|s|$. We also have

$$[\alpha_v, \alpha_w] = \mathbf{Esc}_P(\mathbf{F}) \cap \overline{\mathbb{O}_-(w) \cup \mathbb{O}_+(w)} \setminus \bigcup_{\mathbb{O}_\iota(s) \not\ni \alpha_v} \mathbb{O}_\iota(s)$$

for all $P \geq |s|$ (because every component $\mathbf{Esc}_P \setminus \mathbf{Esc}_{|v|}$ is deleted). As a consequence, $[\alpha_v, \alpha_s] = [\alpha_v, \alpha_w] \cup [\alpha_w, \alpha_s]$.

The second claim follows $A_\star(\alpha_w) = \alpha_{tw}$ and $A_\star(\alpha_v) = \alpha_{tv}$, see Lemma 5.9. \square

5.8. External chains are arcs. Recall that $\mathbf{F}^P \mid \bar{\mathbf{Z}}$ is conjugate by \mathbf{h} to the cascade of translations $(T^P)_{P \in \mathbb{T}}$, see Lemma 5.2. By construction, $\mathbf{h}(c_P) = b_P$, where b_P are defined in §2.2. As in §2.2, we say that a critical point c_P is *dominant* if the arc $[0, c_P]$ contains no critical point of generation less than P ; in this case \mathbf{Z}_P and α_P are also called *dominant*.

Let c_P and c_Q be two dominant critical points and assume that $P < Q$. Then $c_Q, 0 \in \partial \mathbf{Z}$ are on the same side of c_P .

As in §2.2, we enumerate dominant critical points as $(c_{P_n})_{n \in \mathbb{Z}}$ with $P_{n+1} > P_n$. Suppressing indices, we write $\alpha_i = \alpha_{P_i}$, $c_i = c_{P_i}$, and $\mathbf{Z}_i = \mathbf{Z}_{P_i}$.

Lemma 5.22. *We have*

$$\dots \succ \alpha_1 \succ \alpha_0 \succ \alpha_{-1} \succ \dots,$$

Proof. We claim that there is no α_s separating α_{i+1} and α_i with respect to the ambient order “ \prec ” such that the generation of α_s is less than P_i . Write $s = (R, \dots)$. Since $R < P_i$, the chain \mathbb{B}_s does not go through \mathbf{Z}_i and \mathbf{Z}_{i+1} ; hence \mathbf{Z}_R is attached to (c_{i+1}, c_i) . This is impossible, because c_R is not counted as dominant. By Proposition 5.20, $\alpha_{i+1} \succ \alpha_i$. \square

The *zero chain* (see Figure 27) is

$$(5.6) \quad \dots \cup [\alpha_1, \alpha_0] \cup [\alpha_0, \alpha_{-1}] \cup \dots$$

It follows from the definition that c_R is dominant if and only if $A_\star(c_R)$ is dominant. Therefore, there is a $k > 0$ such that $\mathfrak{t}P_i = P_{i+k}$ and (equivalently) $A_\star(\alpha_i) = \alpha_{i+k}$ for all $i \in \mathbb{Z}$. As a consequence,

$$(5.7) \quad A_\star[\alpha_{tk}, \alpha_{(t-1)k}] = [\alpha_{(t+1)k}, \alpha_{tk}],$$

thus the $[\alpha_{(t+1)k}, \alpha_{tk}]$ shrink to 0; i.e. 0 is the landing point of the zero chain.

Lemma 5.23. *For every $[\alpha_i, \alpha_{i+1}]$ there is a $Q \in \mathbb{T}_{>0}$ and $[\alpha_n, \alpha_m]$ with $i \geq m > n$ such that \mathbf{F}^Q maps $[\alpha_i, \alpha_{i+1}]$ homeomorphically to $[\alpha_n, \alpha_m]$.*

Proof. Follows from Lemma 2.4, which provides the corresponding property for $b_P = \mathbf{h}(c_P)$. \square

Given $M \in \mathbb{R}_{>0}$, we write $\mathbf{Esc}_M(\mathbf{F}) = \bigcap_{T > M} \mathbf{Esc}_T(\mathbf{F})$. Given $x \in \mathbf{Esc}(\mathbf{F})$, its *escaping time* is the minimal M such that $\mathbf{Esc}_M(\mathbf{F}) \ni x$.

Corollary 5.24. *The zero chain is an arc landing at 0. The points on this arc are parametrized by their escaping time ranging continuously from $+\infty$ (for points close to 0) to 0. Alpha-points are dense on the zero chain.*

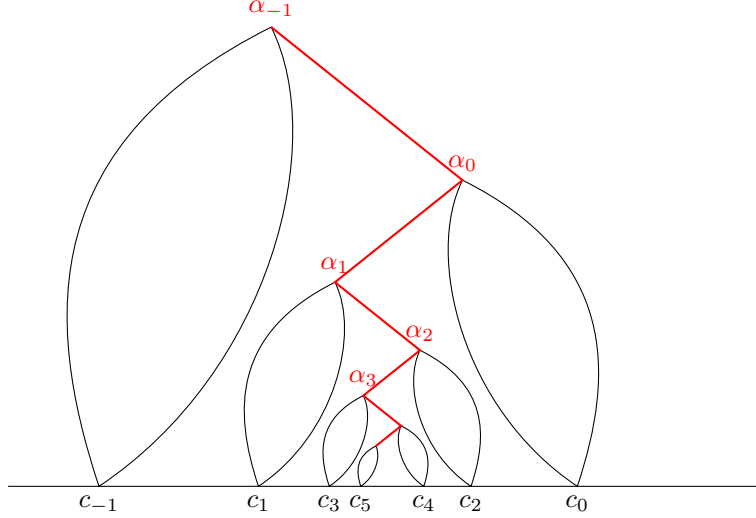

FIGURE 27. Fibonacci (golden mean rotation number) combinatorics: for every i the map $\mathbf{F}^{P_{i+1}}$ maps $[\alpha_i, \alpha_{i-1}]$ to $[\alpha_{i-1}, \alpha_{i-3}]$.

Proof. Consider $I := [\alpha_{tk}, \alpha_{(t+1)k}]$. Let us construct Markov partitions \mathfrak{J}_r of I for $r \geq 0$. For $i \in \{tk, \dots, (t+1)k - 1\}$, the chain $I_i := [\alpha_i, \alpha_{i+1}]$ is an element of the partition \mathfrak{J}_0 of level 0. By Lemma 5.23, $\mathbf{F}^Q(I_i) = [\alpha_n, \alpha_m]$ for some $Q > 0$ depending on i . For $j \in \{n, n+1, m-1\}$ we say that the preimage of $[\alpha_j, \alpha_{j+1}]$ under $\mathbf{F}^Q: I_i \rightarrow [\alpha_n, \alpha_m]$ is an element of the partition \mathfrak{J}_1 of level 1.

By construction, for every chain J of \mathfrak{J}_1 there is a chain \tilde{J} of \mathfrak{J}_0 and a homeomorphism

$$(5.8) \quad \chi_J = A_\star^m \circ \mathbf{F}^Q: J \rightarrow \tilde{J} \quad \text{with } Q > 0, m \geq 0.$$

The map (5.8) expands the hyperbolic metric of \mathbb{O} : if $\mathbb{O}' \supset J$ is the lake of generation Q , then $\chi_J: \mathbb{O}' \rightarrow \mathbb{O}$ is expanding.

Elements of the partition \mathfrak{J}_{r+1} are the preimages of the elements in \mathfrak{J}_r under all possible χ_J . Since χ_J are expanding, the diameters of elements in \mathfrak{J}_r are bounded by $C\lambda^{-r}$ for some $C > 0$ and $\lambda > 1$.

We can enumerate chains in \mathfrak{J}_r as I_i^r with $i \in \{1, \dots, a(r)\}$ such that I_i^r and I_j^r are disjoint if $i > j + 1$ (see Lemma 5.21). Since the diameters of chains in \mathfrak{J}_r tend to 0, we obtain that alpha-points are dense in I and I is an arc by a well-known characterization of arcs. More precisely, \prec is a total order on I compatible with topology: the sets $I_{\succeq v} := \{x \in I : x \succeq v\}$ and $I_{\preceq v} := \{x \in I : x \preceq v\}$ are closed in \mathbb{C} for all $v \in I$ (they are closed if v is an alpha-point (by Lemma 5.11) and we just showed that alpha-points are dense). By [Na, Theorems 6.16 and 6.17], I is an arc. The assertion that I is an arc also follows from the next paragraph justifying a continuous parametrization of I by an interval (a continuous bijection between compact sets is a homeomorphism).

By construction, I_i^r are arcs connecting two alpha-points. For every I_i^r write $\bar{\chi} = \chi_1 \circ \dots \circ \chi_r$ a composition of maps (5.8) mapping I_i^r to an element of \mathfrak{J}_0 . Using (4.6) we write $\bar{\chi} = A_\star^{m(r,i)} \circ \mathbf{F}^{Q(r,i)}$. Observe that $m(r,i) \rightarrow +\infty$ as $r \rightarrow +\infty$

uniformly in i . (Indeed, since $Q > 0$ in (5.8), there is a constant $M \geq 0$ such that $\bar{\chi}$ contains at most M consecutive χ_j that does not contain the scaling A_\star .) Then

$$\mathbf{F}^{Q(r,i)}(I_i^r) \in A_\star^{-m(r,i)}[\alpha_{tk}, \alpha_{(t+1)k}],$$

and the difference in the escaping times between the endpoints of I_i^r is less than $(|\alpha_{(t+1)k}| - |\alpha_{tk}|)/\mathfrak{t}^{m(r,i)}$. This proves that the escaping time parametrizes continuously points on I . \square

Remark 5.25. *In fact, the zero chain is a quasi-arc. In the proof of Corollary 5.24, we can extend χ_J to a conformal map defined on a neighborhood of J . The Koebe distortion theorem implies that the distance between any pair of points x, y in I is comparable to the diameter of the subarc $[x, y] \subset I$. This is one of the characterizations of a quasi-arc.*

For every α_s there is a sequence $\alpha_s \succ \alpha_{v_1} \succ \alpha_{v_2} \succ \dots$ with $|v_i|$ tending to 0. We define:

$$[\alpha_s, \infty) := [\alpha_s, \alpha_{v_1}] \cup [\alpha_{v_1}, \alpha_{v_2}] \cup [\alpha_{v_2}, \alpha_{v_3}] \cup \dots$$

Proposition 5.26. *The chain $[\alpha_s, \infty)$ is a simple arc for every alpha-point α_s with $|s| > 0$. Points in $[\alpha_s, \infty)$ are parametrized by their escaping time ranging continuously from $|s|$, the escaping time of α_s , to 0. Alpha-points are dense in $[\alpha_s, \infty)$.*

As a consequence, $[\alpha_s, \alpha_v]$ is a simple arc for every $\alpha_s \succ \alpha_v$. We call both $[\alpha_s, \alpha_v]$ and $[\alpha_s, \infty)$ *external ray segments*.

Proof. Suppose first $\alpha_s = \alpha_Q$. Choose a dominant α_P with $P \geq Q$. By Corollary 5.24, $[\alpha_P, \infty)$ is a simple arc. Let $x \in [\alpha_P, \infty)$ be the unique point of generation $P - Q$. Then $[\alpha_P, x]$ is a lift of $[\alpha_Q, \infty)$ under \mathbf{F}^{P-Q} ; therefore, $[\alpha_Q, \infty)$ is a simple arc.

Suppose now $s = (Q_1, Q_2, \dots, Q_n)$. Then $(\infty, \alpha_s]$ is $(\infty, \alpha_{Q_1}]$ followed by the lift of $(\infty, \alpha_{Q_2}]$ under \mathbf{F}^{Q_1} connecting α_{Q_1} and $\alpha_{(Q_1, Q_2)}$, followed by the lift of $(\infty, \alpha_{Q_3}]$ under $\mathbf{F}^{Q_1+Q_2}$ connecting $\alpha_{(Q_1, Q_2)}$ and $\alpha_{(Q_1, Q_2, Q_3)}$, and so on. By Lemma 5.18, $(\infty, \alpha_s]$ is a simple arc. The claims about the parameterization and alpha-points follow from Corollary 5.24. \square

5.9. External rays. An external ray \mathbf{R} is a simple arc

$$\dots \cup [\alpha_{i+1}, \alpha_i] \cup [\alpha_i, \alpha_{i-1}] \cup \dots$$

subject to the condition

$$\dots \succ \alpha_{i+1} \succ \alpha_i \succ \alpha_{i-1} \succ \dots$$

such that

- the generation of α_i tends to 0 as i tends $+\infty$, and
- there is no alpha-point α' such that $\alpha' \succ \alpha_i$ for all $i \in \mathbb{Z}$.

In other words, an external ray is a simple arc between ∞ and an end of the escaping set. The *generation* of \mathbf{R} is $\lim_{i \rightarrow +\infty} |\alpha_i| \in \mathbb{R}_{>0} \sqcup \{+\infty\}$. We say that

- \mathbf{R} has *type I* if the generation of \mathbf{R} is ∞ ; and
- \mathbf{R} has *type II* if the generation of \mathbf{R} is $< \infty$.

Given a ray \mathbf{R} , its *image* is

$$\mathbf{F}^P(\mathbf{R}) := \mathbf{F}^P(\mathbf{R} \cap \text{Dom } \mathbf{F}^P).$$

Then $\mathbf{R} \cap \text{Dom } \mathbf{F}^P$ is a subarc (possibly empty) of \mathbf{R} consisting of all the points with the escaping time in $(P, +\infty)$, see Proposition 5.26. If Q is the generation of \mathbf{R} , then the generation of $\mathbf{F}^P(\mathbf{R})$ is $Q - P$. Note that $\mathbf{F}^P(\mathbf{R})$ is empty if and only if $P \geq Q$.

The following is a corollary of Proposition 5.20:

Corollary 5.27. *Any two external rays $\mathbf{R}_1 \neq \mathbf{R}_2$ meet at a unique α_s ; i.e. $\mathbf{R}_1 \cap \mathbf{R}_2 = [\alpha_s, \infty)$. \square*

A ray \mathbf{R} is *periodic* if $\mathbf{F}^P(\mathbf{R}) = \mathbf{R}$ for some $P > 0$. In this case P is a *period* of \mathbf{R} . We will show in Corollary 5.35 that every periodic ray has a minimal period. Preperiodic rays are defined accordingly.

The zero chain (5.6) is a ray landing at 0; we will denote this ray as $\mathbf{R}^* = \mathbf{R}^0$. Writing $\mathbf{I}_t = [\alpha_{tk}, \alpha_{(t-1)k}]$ in (5.7), we obtain the decomposition

$$(5.9) \quad \mathbf{R}^* = \cdots \cup \mathbf{I}_1 \cup \mathbf{I}_0 \cup \mathbf{I}_{-1} \cup \cdots$$

where

$$(5.10) \quad \mathbf{I}_i \subset \overline{\text{Esc}_{P^i} \setminus \text{Esc}_{P^{i-1}}(\mathbf{F})}, \quad P := |\alpha_0|$$

is an external ray segment satisfying

$$(5.11) \quad \mathbf{I}_i = A_\star(\mathbf{I}_{i-1}).$$

5.10. Wakes. Since the zero ray \mathbf{R}^0 lands at 0, for every critical point c_s , there are two preimages $\mathbf{R}_{s,-}$ and $\mathbf{R}_{s,+}$ of \mathbf{R}^0 landing at c_s . We assume that $\mathbf{R}_{s,-}$ is on the left of c_s and $\mathbf{R}_{s,+}$ is on the right of c_s (relative the boundary of the bubble containing c_s). Let $\alpha_{s,-} \in \mathbf{R}_{s,-}$ and $\alpha_{s,+} \in \mathbf{R}_{s,+}$ be two alpha-points on the rays close to c_s . Observe that $\alpha_{s,+}$ and $\alpha_{s,-}$ are \prec -separated by α_s . We denote by $\mathbf{R}'_{s,-}$ and $\mathbf{R}'_{s,+}$ the closed subarcs of $\mathbf{R}_{s,-}$ and $\mathbf{R}_{s,+}$ between α_s and c_s , see Figure 28. By Corollary 5.27,

$$(5.12) \quad \{c_s\} \cup \mathbf{R}'_{s,-} \cup \mathbf{R}'_{s,+} =: \partial \mathbf{W}_s$$

encloses the closed topological disk \mathbf{W}_s containing \mathbf{L}_s . We call \mathbf{W}_s the (closed) *wake at c_s* , and we say that c_s is the *root* of \mathbf{W}_s . We will show in Corollary 5.36 that $\mathbf{W}_s = \overline{\mathbf{L}_s}$. If $s = (P_1, P_2, \dots, P_m)$, then m is called the *level* of \mathbf{W}_s . We say that α_s is the *top* point of \mathbf{W}_s . Wakes \mathbf{W}_P are called *primary*.

The dynamics of wakes follows the dynamics of their roots:

Lemma 5.28. *If $\mathbf{F}^Q(c_v) = c_s$, then $\mathbf{F}^Q: \mathbf{W}_v \rightarrow \mathbf{W}_s$ is a homeomorphism. For every wake \mathbf{W}_s , we have a conformal map*

$$\mathbf{F}^{|\mathbf{s}|}: \text{int } \mathbf{W}_s \rightarrow \mathbb{C} \setminus \overline{\mathbf{R}^0}.$$

Proof. By construction, \mathbf{F}^Q maps $\overline{\mathbf{R}_{v,-} \cup \mathbf{R}_{v,+}}$ homeomorphically to $\overline{\mathbf{R}_{s,-} \cup \mathbf{R}_{s,+}}$. Therefore, $\mathbf{F}^Q: \mathbf{W}_v \rightarrow \mathbf{W}_s$ is a homeomorphism.

Since $\mathbf{F}^{|\mathbf{s}|}$ maps each curve $\mathbf{R}_{v,-}, \mathbf{R}_{v,+}$ homeomorphically to \mathbf{R}^0 , we see that $\mathbf{F}^{|\mathbf{s}|}: \text{int } \mathbf{W}_s \rightarrow \mathbb{C} \setminus \overline{\mathbf{R}^0}$ is conformal. \square

As before, we write $\mathbf{J}_n := \partial \mathbf{Z} \cap \mathbf{S}_n^\#$ and $\mathbf{J} = \mathbf{J}_0$.

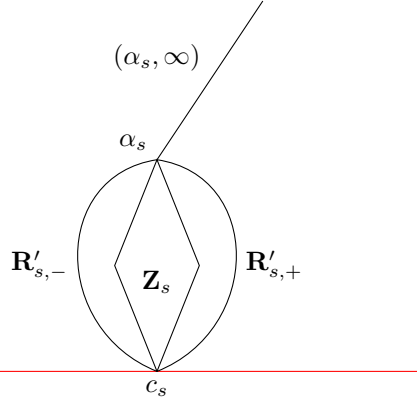

FIGURE 28. The wake \mathbf{W}_s is the closed topological disk containing \mathbf{Z}_s and enclosed by $\overline{\mathbf{R}_{s,-} \cup \mathbf{R}_{s,+}}$.

Lemma 5.29 (Primary wakes shrink). *For every $n \in \mathbb{Z}$ and every $\varepsilon > 0$ there are at most finitely many primary wakes \mathbf{W}_P with $c_P \in \mathbf{J}_n$ such that the diameter of \mathbf{W}_P is greater than ε .*

Proof. It is sufficient to prove the statement for $n = 0$. Write

$$\mathbf{J}_- := \mathbf{J} \cap \mathbf{U}_- \quad \text{and} \quad \mathbf{J}_+ := \mathbf{J} \cap \mathbf{U}_+$$

(see (3.6)); then $\mathbf{f}_\pm: \mathbf{J}_\pm \rightarrow \mathbf{J}$ realizes the first return of points in \mathbf{J} back to \mathbf{J} . Let \mathbf{W}_0 be the primary wake of smallest generation touching \mathbf{J} . Then all other primary wakes touching \mathbf{J} are iterated lifts of \mathbf{W}_0 under $\mathbf{f}_\pm: \mathbf{J}_\pm \rightarrow \mathbf{J}$; we enumerate these wakes as $(\mathbf{W}_i)_{i \leq 0}$ so that \mathbf{W}_{i-1} is a preimage of \mathbf{W}_i under \mathbf{f}_\pm . We will show that the diameter of \mathbf{W}_i tends to 0.

Let \mathcal{O}_λ be the union of all the lakes whose generation is $(0, 0, 1)$ and whose closure intersects \mathbf{J}_- . Similarly, \mathcal{O}_ρ is the union of all the lakes whose generation is $(0, 1, 0)$ and whose closure intersect \mathbf{J}_+ . If $\mathbf{W}_0 = \mathbf{W}_P$ intersects \mathbf{J}_- , then $\mathcal{O}_\lambda = \mathcal{O}_+(P) \cup \mathcal{O}_i(P)$ because \mathbf{J}_- contains a unique critical point c_P of generation $\leq P = (0, 0, 1)$; and \mathcal{O}_ρ consists of a single lake because \mathbf{J}_+ does not contain a critical point of generation $\leq P$. If \mathbf{W}_0 intersects \mathbf{J}_+ , then \mathcal{O}_ρ consists of two lakes and \mathcal{O}_λ consists of a single lake.

The maps

$$(5.13) \quad \mathbf{f}_-: \mathcal{O}_\lambda \rightarrow \mathcal{O} = \mathbb{C} \setminus \overline{\mathbf{Z}} \quad \text{and} \quad \mathbf{f}_+: \mathcal{O}_\rho \rightarrow \mathcal{O} = \mathbb{C} \setminus \overline{\mathbf{Z}}$$

expand the hyperbolic metric of \mathcal{O} .

Let us denote by c_n the root of \mathbf{W}_n . Let y_0 be an arbitrary point in \mathcal{O} and let ℓ_0 be a curve in $\overline{\mathcal{O}}$ connecting c_0 to y_0 such that $\ell_0 \setminus \{c_0\} \subset \mathcal{O}$. For $n \leq 0$, denote by ℓ_n the unique lift of ℓ (by an appropriate \mathbf{F}^{P_n}) starting at c_n and denote by y_n the endpoint of ℓ_n .

Claim. There is a sequence $\varepsilon_n > 0$ converging to 0 such that the following holds. If the diameter of ℓ_0 is less than ε_0 , then the Euclidean diameter of ℓ_n is less than ε_n .

Since the maps in (5.13) expand the hyperbolic metric, it follows from the Claim that the \mathbf{W}_n shrink in the Euclidean metric. Indeed, \mathbf{W}_0 minus a small neighborhood of c_0 is a compact subset of \mathcal{O} . Lifts of this compact subset either shrink

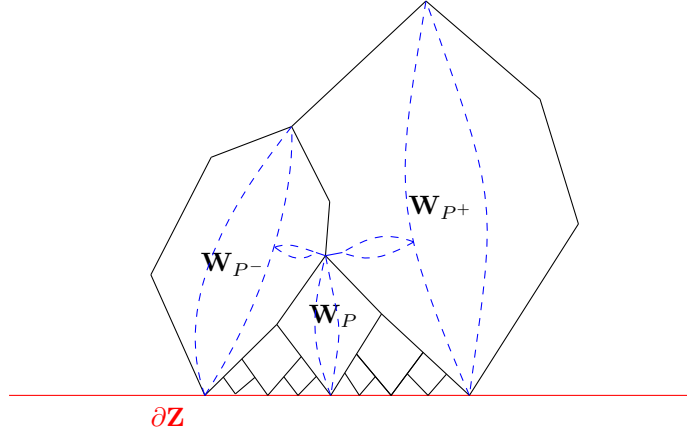

FIGURE 29. Combinatorics of primary wakes: $\partial W_P \setminus \{c_P\}$ is covered by neighboring wakes. The bubble chains $\mathbb{B}_{\lambda(P)}, \mathbb{B}_P = \mathbf{Z}_P, \mathbb{B}_{\rho(P)}$ landing at α_P are marked blue dashed.

in the hyperbolic metric or converge to ∂Z ; in the latter case, they shrink in the Euclidean metric.

Proof of the Claim. It is sufficient to verify the claim in the dynamical plane of the pacman f . Since Siegel maps with the same rotation number are conjugate in small neighborhoods of their Siegel disks (see §3.2.5), it is sufficient to prove the claim in the dynamical plane of the quadratic polynomial p that has a Siegel fixed point with the same rotation number as f .

Choose two points $a, b \in \partial Z_p$ such that a is slightly on the left of c_0 while b is slightly on the right of c_0 . Let R_a and R_b be two external rays landing at a and b . Let X be an open topological disk bounded by $\bar{Z}_p \cup R_a \cup R_b$ and truncated by some equipotential such that the boundary of X contains c_0 . Let X_n be the unique lift of X under p^n such that ∂X_n contains c_n – the unique preimage of c_0 under $p^n: \partial Z_p \rightarrow \partial Z_p$. Then X_n is bounded by $p^{-n}(\bar{Z}_p)$, two preimages $R_{a,n}, R_{b,n}$ of R_a, R_b , and an equipotential. If n is big, then the difference between the external angles of $R_{a,n}, R_{b,n}$ is small and the equipotential is close to the Julia set. Since the Julia set of p is locally connected [Pe], the diameter of X_n tends to 0. \square

\square

Lemma 5.30 (Combinatorics of primary wakes, Figure 29). *Consider a wake \mathbf{W}_P . Write*

$$\lambda(P) = (P^-, \dots) \quad \text{and} \quad \rho(P) = (P^+, \dots).$$

Then $\mathbf{W}_P, \mathbf{W}_{P-}, \mathbf{W}_{P+}$ are all the primary wakes containing α_P on the boundary.

As in (5.12), write $\partial \mathbf{W}_P = \{c_P\} \cup \mathbf{R}'_{P,-} \cup \mathbf{R}'_{P,+}$. Then $\mathbf{R}'_{P,-}$ splits as a concatenation

$$\mathbf{R}'_{P,-} = [\alpha_P, \alpha_{Q_1}] \cup [\alpha_{Q_1}, \alpha_{Q_2}] \cup \dots$$

such that

- $[\alpha_P, \alpha_{Q_1}] = \mathbf{W}_{P-} \cap \mathbf{W}_P$;
- $[\alpha_{Q_i}, \alpha_{Q_{i+1}}] = \mathbf{W}_{Q_i} \cap \mathbf{W}_P$ for $i \geq 1$;

- $Q_{i+1}^- = Q_i$, $Q_1^- = P^-$, and $Q_i^+ = P$;
- α_{Q_i} tends to c_P .

Similarly, $\mathbf{R}'_{P,+}$ splits as a concatenation

$$\mathbf{R}'_{P,+} = [\alpha_P, \alpha_{S_1}] \cup [\alpha_{S_1}, \alpha_{S_2}] \cup \dots$$

such that

- $[\alpha_P, \alpha_{S_1}] = \mathbf{W}_{P^+} \cap \mathbf{W}_P$;
- $[\alpha_{S_i}, \alpha_{S_{i+1}}] = \mathbf{W}_{S_i} \cap \mathbf{W}_P$ for $i \geq 1$;
- $S_{i+1}^+ = S_i$, $S_1^+ = P^+$, and $S_i^- = P$;
- α_{S_i} tends to c_P .

Proof. Recall that α_P is the landing point of $\mathbb{B}_P = \widehat{\mathbf{Z}}_P, \mathbb{B}_{\lambda(P)}, \mathbb{B}_{\rho(P)}$, see Lemma 5.11. Since $\mathbb{B}_{\lambda(P)}, \mathbb{B}_{\rho(P)}$ are in wakes $\mathbf{W}_{P^-}, \mathbf{W}_{P^+}$, the first claim follows.

We will verify the decomposition of $\mathbf{R}'_{P,-}$; the decomposition of $\mathbf{R}'_{P,+}$ can be verified similarly. It follows from Corollary 5.27 that the intersection $\mathbf{W}_{P^-} \cap \mathbf{W}_P$ is an arc of the form $[\alpha_v, \alpha_P]$ with $\alpha_v \succ \alpha_P$. Observe that all three bubble chains landing at α_v (see Lemma 5.11) belong to different prime wakes because α_v is a point where $\partial\mathbf{W}_P$ and $\partial\mathbf{W}_{P^-}$ split. This implies that $\alpha_v = \alpha_{Q_1}$ for some $Q_1 \in \mathbb{T}_{>0}$; by the first claim, $Q_1^- = P^-$, and $Q_1^+ = P$.

Similarly, the intersection $\mathbf{W}_{Q_1} \cap \mathbf{W}_P$ is of the form $[\alpha_{Q_1}, \alpha_{Q_2}]$, where $Q_2^- = Q_1$, and $Q_2^+ = P$. Applying induction, we construct Q_i for all $i \geq 1$. It remains to show that α_{Q_i} converges to c_P .

By Proposition 5.26, there is an alpha-point $\alpha_s \in \mathbf{R}'_{P,-}$ close to c_P . At least one of the rays $\mathbb{B}_s, \mathbb{B}_{\lambda(s)}, \mathbb{B}_{\rho(s)}$ is not in \mathbf{W}_P ; thus α_s is on the boundary of a primary wake $\mathbf{W}_T \neq \mathbf{W}_P$. As above, the intersection $\mathbf{W}_T \cap \mathbf{W}_P$ is of the form $[\alpha_T, \alpha_{T_2}]$, where $T_2^- = T$.

Since there are at most finitely many critical points in $[c_T, c_{P^-}]$ (a subarc of $\partial\mathbf{Z}$) of generation less than T , the arc $[\alpha_T, \alpha_P]$ intersects only finitely many primary wakes. This means that $T = Q_i$ for some $i \geq 1$. Since c_s can be chosen arbitrary close to c_P , α_{Q_i} converges to c_P . \square

Corollary 5.31 (Tiling). *The union of primary wakes $\bigcup_{P>0} \mathbf{W}_P$ contains \mathbb{O} . Similarly, for every wake \mathbf{W}_s with $s = (P_1, \dots, P_n)$ we have*

$$(5.14) \quad \mathbf{W}_s = \overline{\mathbf{Z}}_s \cup \bigcup_{P_{n+1}>0} \mathbf{W}_{(P_1, \dots, P_n, P_{n+1})}.$$

For every $z \in \mathbf{Esc}(\mathbf{F})$ and every $m \geq 1$ there are at most three wakes with disjoint interiors of level $\geq m$ containing z . The union of these wakes is a neighborhood of z .

Proof. There is a pair of primary wakes \mathbf{W}_P and \mathbf{W}_Q such that $\mathbf{W}_P \cup \mathbf{W}_Q \cup \overline{\mathbf{Z}}$ surrounds an open topological disk X with $0 \in \partial X$. Then for every $y \in \mathbb{O}$, there is an $n \ll 0$ such that $A_\star^n(\mathbf{W}_P \cup \mathbf{W}_Q \cup \overline{\mathbf{Z}})$ encloses y .

By Lemma 5.30, if $y \notin \overline{\mathbf{Z}}$ is not contained in any prime wake, then there is connected set $Y \ni y$ (a ‘‘ghost limb’’) such that $Y \subset \mathbb{O} \setminus \bigcup_P \mathbf{W}_P$ and \overline{Y} intersects

$\partial\mathbf{Z}$, say at x . We can choose sequences \mathbf{W}_{P_i} and \mathbf{W}_{Q_i} such that $\mathbf{W}_{P_i} \cup \mathbf{W}_{Q_i} \cup \overline{\mathbf{Z}}$ encloses Y and c_{P_i}, c_{Q_i} tend to x . By Lemma 5.29, the diameters of \mathbf{W}_{P_i} and \mathbf{W}_{Q_i} tend to 0. This is a contradiction.

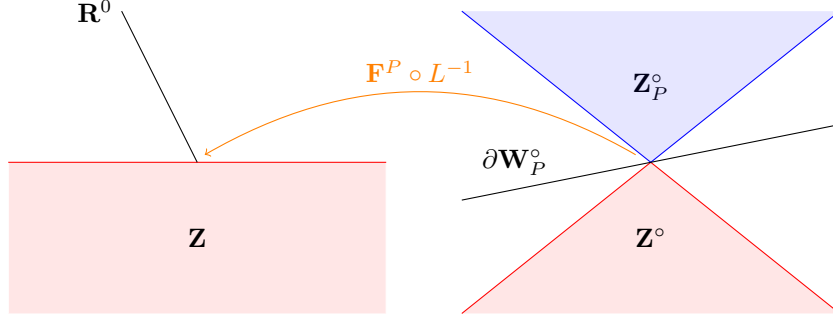

FIGURE 30. $\mathbf{Z}^\circ, \mathbf{Z}_P^\circ$ are the preimages of \mathbf{Z} under $\mathbf{F}^P \circ L^{-1}$.

By construction,

$$(5.15) \quad \mathbf{F}^{|\mathbf{s}|}: \text{int}(\mathbf{W}_s) \rightarrow \mathbb{C} \setminus \overline{\mathbf{R}}^0$$

is conformal. Then (5.14) follows from the first claim by applying the inverse of (5.15). \square

Corollary 5.32. *For every $\varepsilon > 0$ there is a $P \in \mathbb{T}_{>0}$ such that every connected component of*

$$(5.16) \quad \mathbb{C} \setminus \left(\overline{\mathbf{Z}}_\star \cup \bigcup_{S \leq P} \mathbf{W}_S \right)$$

is less than ε in the spherical metric.

Proof. Follows from Lemmas 5.29 and 5.30. \square

5.11. Rigidity of the escaping set. For an open topological disk U , we denote by diam_U and dist_U the diameter and distance with respect to the hyperbolic metric of U .

Lemma 5.33. *For every primary wake \mathbf{W}_P the following holds. The map*

$$(5.17) \quad \mathbf{F}^P: \mathbf{W}_P \setminus \overline{\mathbf{Z}}_P \rightarrow \mathbb{O}$$

is uniformly expanding with respect to the hyperbolic metric of \mathbb{O} . There is a $C > 0$ such that $\text{diam}_{\mathbb{O}}(\mathbf{W}_{(P,Q)}) \leq C = C_P$ for every secondary subwake $\mathbf{W}_{(P,Q)}$ of \mathbf{W}_P .

Since all wakes are dynamically related, one can show that (5.17) is uniformly expansion over all P .

Proof. Let us denote by μ the hyperbolic metric of \mathbb{O} and by μ' the hyperbolic metric of $\mathbb{O} \setminus \overline{\mathbf{Z}}_P$. We will show that

$$\iota := \text{id}: (\mathbf{W}_P \setminus \overline{\mathbf{Z}}_P, \mu) \rightarrow (\mathbf{W}_P \setminus \overline{\mathbf{Z}}_P, \mu')$$

is uniformly contracting; this will imply that (5.33) is uniformly expanding as it factors through ι^{-1} followed by a (non-uniformly) expanding map.

Since $\partial \mathbf{W}_P \cap \partial \mathbb{O} = \{c_P\}$, the map ι is uniformly contracting away from a small neighborhood of c_P (by compactness). In a small neighborhood of c_P the uniform contraction of ι follows from the self-similarity of $\mathbf{W}_P, \mathbf{Z}_P, \overline{\mathbf{Z}}$ at c_P ; it implies that points on $\partial \mathbf{W}$ have comparable distances to $\overline{\mathbf{Z}}$ and \mathbf{Z}_P . Let us provide details.

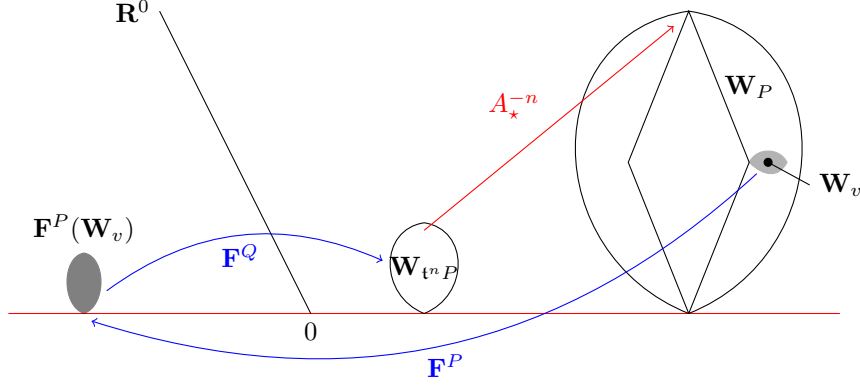

FIGURE 31. Construction of the first scaled return $\chi := A_\star^{-n} \circ \mathbf{F}^{P+Q}: \mathbf{W}_v \rightarrow \mathbf{W}_P$.

Let us lift the global self-similarity A_\star to a local self-similarity of \mathbf{W}_P near c_P . Let $U \ni A_\star(U)$ be a small open disk around 0 such that 0 is the only critical value of \mathbf{F}^P in U . Let $V \ni c_P$ be the lift of U along $\mathbf{F}^P: c_P \mapsto 0$. Then $A_\star|_U$ lifts to a conformal map ψ defined on V . By construction, c_P is an attracting fixed point of ψ . Let $L: (V, c_P) \rightarrow (\mathbb{C}, 0)$ with $L'(c_P) = 1$ be the linearizer conjugating ψ to the scaling A_ν . (We note that $\nu^2 = \mu_\star$ because \mathbf{F}^P is 2-to-1 near c_P .) Consider

$$(5.18) \quad L(\mathbf{W}_P), L(\mathbf{Z}), L(\mathbf{Z}_P), L(0);$$

these objects are forward invariant under A_ν . Using backward iterates of A_ν , we globalize (5.18); we denote the results by $\mathbf{W}_P^\circ, \mathbf{Z}^\circ, \mathbf{Z}_P^\circ, \mathbb{O}^\circ$; these new objects are completely invariant under A_ν , see Figure 30. Let μ° and μ'° be the hyperbolic metrics of $\mathbb{O}^\circ \cup \mathbf{Z}_P^\circ$ and \mathbb{O}° respectively. The invariance under A_ν implies that

$$\iota^\circ: (\mathbf{W}_P^\circ \setminus \mathbf{Z}_P^\circ, \mu^\circ) \rightarrow (\mathbf{W}_P^\circ \setminus \mathbf{Z}_P^\circ, \mu'^\circ)$$

is uniformly contracting. Since $L'(c_P) = 1$, the uniform contraction of ι° implies the uniform contraction of ι near c_P .

Consider a secondary wake $\mathbf{W}_{(P,S)}$ and observe that if $\mathbf{W}_{(P,S)}$ is close to c_P , then $\mathbf{W}_{(P,S)}$ is contained in a small neighborhood of c_P . Indeed, if $\mathbf{F}^P(\mathbf{W}_{(P,S)})$ is close to 0, then $\mathbf{F}^P(\mathbf{W}_{(P,S)})$ is small by Lemma 5.29 and Corollary 5.31. Therefore, the second claim of the lemma is obvious unless $\mathbf{W}_{(P,S)}$ is contained in a small neighborhood of c_P . At a small neighborhood of c_P , the second claim follows from the self-similarity at c_P by applying L . \square

Lemma 5.34 (Nested wakes shrink). *For an infinite sequence (P_1, P_2, \dots) write $s(n) := (P_1, \dots, P_n)$. Then*

$$\bigcap_{n \geq 1} \mathbf{W}_{s(n)}$$

is a singleton.

Proof. For a secondary wake $\mathbf{W}_v \subset \mathbf{W}_P$, we define its *first scaled return*

$$\chi := A_\star^{-n} \circ \mathbf{F}^{P+Q}: \mathbf{W}_v \rightarrow \mathbf{W}_P$$

as follows, see Figure 31. The map $\mathbf{F}^P: \text{int}(\mathbf{W}_P) \rightarrow \mathbb{C} \setminus \overline{\mathbf{R}^0}$ is univalent and $\mathbf{F}^P(\mathbf{W}_v)$ is a primary wake. Let $Q \in \mathbb{T}$ be the minimal such that $\mathbf{F}^{P+Q}(\mathbf{W}_v) = \mathbf{W}_{\iota^n P}$ for some $n \in \mathbb{Z}$. Then $A_{\star}^{-n} \circ \mathbf{F}^{P+Q}(\mathbf{W}_v) = \mathbf{W}_P$. By Lemma 5.33, $\chi = \mathbf{F}^{P+Q}$ is expanding uniformly over all the secondary subwakes of \mathbf{W}_P .

The first scaled return χ is defined for all $x \in \mathbf{W}_P \setminus \mathbf{Z}_P$ (with a natural interpretation of the ambiguity at common boundary points of secondary wakes). By (5.33),

$$\text{diam}_0 \chi^{k-2}(\mathbf{W}_{s(k)}) \leq C.$$

Since χ is uniformly expanding, we obtain that $\text{diam}_0(\mathbf{W}_{s(k)})$ tends to 0. \square

Corollary 5.35. *Every external ray lands. Every periodic external ray has a minimal period.*

Proof. Observe that the accumulating set Y of a ray does not transversally intersect the boundaries of wakes: either $Y \subset \mathbf{W}_s$ or $Y \subset \mathbb{C} \setminus \overline{\mathbf{W}_s}$ for every wake \mathbf{W}_s . If Y intersects $\partial \mathbf{Z}_s$ for some s , then $Y \subset \partial \mathbf{Z}_s$ by Corollary 5.31. Since the roots of wakes (i.e. critical points) are dense on $\partial \mathbf{Z}_s$, we obtain that Y is a singleton. If Y does not intersect any $\partial \mathbf{Z}_s$, then Y belongs to a nested sequence of closed wakes (by Corollary 5.31). By Lemma 5.34, Y is a singleton.

If \mathbf{R} is a periodic ray, then \mathbf{R} lands, say at x . By Corollary 4.6, x has a minimal period $P \in \mathbb{T}_{>0}$. Therefore, \mathbf{R} has a minimal period mP for some $m \geq 1$. \square

Lemma 5.34 implies that a limb is dense in the corresponding wake:

Corollary 5.36. *We have $\mathbf{W}_s = \overline{\mathbf{L}_s}$ for every s .* \square

Let us declare $x, y \in \mathbf{Esc}_P(\mathbf{F})$ to be *combinatorially equivalent* if there is no alpha-point α_s such that x, y are in different connected components of $\mathbf{Esc}_P(\mathbf{F}) \setminus \{\alpha_s\}$. This generates a combinatorial equivalence. A point $x \in \mathbf{Esc}(\mathbf{F})$ is an *endpoint* of $\mathbf{Esc}(\mathbf{F})$ if $x \notin [\alpha_1, \alpha_2]$ for alpha-points $\alpha_1 \succ \alpha_2$.

Proposition 5.37. *Every combinatorial equivalence class of $\mathbf{Esc}(\mathbf{F})$ is a singleton. For every $M \in \mathbb{R}_{>0}$ we have*

$$(5.19) \quad \mathbf{Esc}_M(\mathbf{F}) = \overline{\bigcup_{P < M} \mathbf{Esc}_P(\mathbf{F})}.$$

For every $P \in \mathbb{T}_{>0}$ the escaping set $\mathbf{Esc}_P(\mathbf{F})$ is uniquely geodesic.

Proof. Consider $x \in \mathbf{Esc}_P(\mathbf{F})$. If x is not an endpoint of $\mathbf{Esc}(\mathbf{F})$, then Proposition 5.26 implies that x can be separated by infinitely many alpha-points from any other point in the escaping set.

Suppose x is an endpoint of $\mathbf{Esc}(\mathbf{F})$. By Corollary 5.31, x belongs to a nested sequence of wakes. By Lemma 5.34, the combinatorial class of x is a singleton. Moreover, the external ray (x, ∞) lands at x ; i.e. \mathbf{Esc}_P is uniquely geodesic. Equation (5.19) is immediate. \square

Corollary 5.38. *Suppose $X \subset \mathbf{Esc}_P(\mathbf{F})$ is a discrete subset of \mathbb{C} . Then the connected hull of X*

$$\bigcup_{x, y \in X} [x, y]$$

is a tree.

Proof. Since $\mathbf{Esc}_P(\mathbf{F})$ is uniquely geodesic, the intersection of $\bigcup_{x,y \in X} [x,y]$ with any proper lake is a finite tree. Since lakes exhaust \mathbb{O} (see for example (5.5)), the claim follows. \square

Lemma 5.39. *The escaping set $\mathbf{Esc}(\mathbf{F})$ has empty interior and supports no invariant line field. Every Fatou component of \mathbf{F} is either \mathbf{Z} or its iterated preimage.*

Such a statement is referred to as the Hairiness Theorem.

Proof. We give the sketch of the proof because the argument is standard.

Since every combinatorial class of $\mathbf{Esc}(\mathbf{F})$ is trivial (Proposition 5.37), we have $\text{int}(\mathbf{Esc}(\mathbf{F})) = \emptyset$.

Suppose X is a Fatou component of \mathbf{F} such that X is not an iterated preimage of \mathbf{Z} . By Corollary 5.31, X belongs to a nested sequence of wakes; the wakes shrink to a point by Lemma 5.34. This is a contradiction.

Suppose $\mathbf{Esc}(\mathbf{F})$ supports an invariant line field L . There are two cases. If the integration along L as in §4.10 gives a non-trivial continuous path \mathbf{G}_t emerging from $\mathbf{F} = \mathbf{F}_*$, then \mathbf{G}_t is a path in \mathbf{W}^u contradicting the rigidity of \mathbf{F} .

In the second case, we would obtain a non-trivial qc map $h: \mathbb{C} \rightarrow \mathbb{C}$ commuting with \mathbf{F} . Since h is identity on $\overline{\mathbf{Z}}$, we obtain that h is identity on all \mathbf{Z}_s which are dense. This implies that h is identity everywhere. \square

Lemma 5.40. *The closure of the escaping set $\mathbf{Esc}_P(\mathbf{F}) \cup \{\infty\} \subset \widehat{\mathbb{C}}$ is locally connected for all $P \in \mathbb{T}_{>0}$.*

Proof. Local connectivity of $\mathbf{Esc}_P(\mathbf{F})$ at any its point z follows from Lemma 5.34. Indeed, if $\bigcup_i \mathbf{W}_i$ is a neighborhood of z consisting of at most 3 pairwise non-nested

wakes of level $\geq m$ (see Corollary 5.31), then $\left(\bigcup_i \mathbf{W}_i\right) \cap \mathbf{Esc}_P(\mathbf{F})$ is a neighborhood of z in $\mathbf{Esc}_P(\mathbf{F})$. By Lemma 5.34, $\bigcup_i \mathbf{W}_i$ shrinks as m increases.

Recall that there are nested lakes $\mathbb{O}(P) \subset \mathbb{O}(t^{-1}P) \subset \dots$ such that $\mathbb{C} = \bigcup_{n \leq 0} \mathbb{O}(t^n P)$, see (5.5). Then $(\mathbf{Esc}_P(\mathbf{F}) \cup \{\infty\}) \setminus \mathbb{O}(t^n P)$ is a small neighborhood of ∞ . \square

We can now replace $\mathcal{R}: \mathcal{B} \dashrightarrow \mathcal{B}$ with a new operator so that its renormalization period \mathfrak{m} is optimal:

Proposition 5.41. *The pacman renormalization operator $\mathcal{R}: \mathcal{B} \dashrightarrow \mathcal{B}$ from §3.2.6 can be constructed so that \mathfrak{m} is the minimal period of θ_* under R_{prm} .*

Proof. Let \mathfrak{m}_{\min} be the minimal period of θ_* , and let \mathfrak{t}_{\min} be the eigenvalue of the associated antirenormalization matrix, see Lemma 2.1. The cascades $\{\mathbf{F}_*^P\}_{P \in \mathbb{T}}$ and $\{\mathbf{F}_*^{\mathfrak{t}_{\min} P}\}_{P \in \mathbb{T}}$ are combinatorially equivalent. By the McMullen Rigidity Theorem (see [McM1, Theorem 8.1]), these cascades are conformally conjugate. Let us denote by

$$A_{*,\min}: z \mapsto \mu_{*,\min} z, \quad |\mu_{*,\min}| < 1$$

the scaling map conjugating \mathbf{F}_*^P to $\mathbf{F}_*^{\mathfrak{t}_{\min} P}$. Consider the renormalization sector \mathbf{S} from (3.6). A priori, $A_{*,\min}(\mathbf{S})$ does not have to be in \mathbf{S} . (In [DLS] we passed to

an iteration to obtain such a property.) Below we will use external rays of \mathbf{F}_\star to construct a new \mathbf{S}^{new} satisfying necessary inclusion properties.

Set $J = [x, y] := \partial\mathbf{Z} \cap \mathbf{S}$. Let $\mathbf{R}_x, \mathbf{R}_y$ be the external rays landing at x, y , and let $\mathbf{I}_x, \mathbf{I}_y$ the internal rays of \mathbf{Z}_\star landing at x, y . Define \mathbf{S}^{new} with $\mathbf{S}^{\text{new}} \cap \mathbf{Z}_\star = \mathbf{S} \cap \mathbf{Z}_\star$ to be the sector bounded by $\mathbf{I}_x \cup \mathbf{R}_x \cup \mathbf{R}_y \cup \mathbf{I}_y$. Set

$$\mathbf{R}_2 := \mathbf{f}_-(\mathbf{R}_y) = \mathbf{f}_+(\mathbf{R}_x) \quad \text{and} \quad \mathbf{I}_2 := \mathbf{f}_-(\mathbf{I}_y) = \mathbf{f}_+(\mathbf{I}_x).$$

Cutting \mathbf{S}^{new} along $\mathbf{I}_2 \cup \mathbf{R}_2$ and pulling back the resulting two sectors under $\mathbf{f}_{\star, \pm} = \mathbf{f}_\pm$, we obtain a full prepacman $\mathbf{F}^{\text{new}} = (\mathbf{f}_\pm: \mathbf{U}_\pm^{\text{new}} \rightarrow \mathbf{S}^{\text{new}})$; see Figure 11 for illustration (where β_-, β_+ are $\mathbf{I}_x \cup \mathbf{R}_x, \mathbf{I}_y \cup \mathbf{R}_y$ and β is $\mathbf{I}_2 \cup \mathbf{R}_2$). Conjugating \mathbf{F}^{new} by $A_{\star, \min}$, we obtain a full prepacman $\mathbf{F}_1^{\text{new}} = (\mathbf{f}_{1, \min, \pm}: \mathbf{U}_{1, \pm}^{\text{new}} \rightarrow \mathbf{S}_1^{\text{new}})$. Then $\mathbf{S}_1^{\text{new}} \subset \mathbf{S}^{\text{new}}$ and, moreover, the forward orbit of $\mathbf{U}_{1, \pm}^{\text{new}}$ under $\mathbf{f}_\pm | \mathbf{U}_\pm^{\text{new}}$ is within $\mathbf{U}_-^{\text{new}} \cup \mathbf{U}_+^{\text{new}}$.

Let α' be the preimage of α under $(\mathbf{f}_\pm: \mathbf{U}_\pm^{\text{new}} \rightarrow \mathbf{S}^{\text{new}})$; the α' is the point where \mathbf{R}_x and \mathbf{R}_y meet. Choose an equipotential $\mathbf{E} \subset \mathbf{Z}_\star$ close to α , and let O be the connected component of $\mathbf{S}^{\text{new}} \setminus \mathbf{E}$ attached to α . Then O has an \mathbf{F}^{new} lift O' attached to α' . We remove O' from $\mathbf{U}_-^{\text{new}} \cup \mathbf{U}_+^{\text{new}}$ and we glue dynamically the sides of \mathbf{S}^{new} to obtain a pacman $f_{\star, \text{new}}: U \rightarrow V$ out of \mathbf{F}^{new} . As with \mathbf{F}^{new} , we remove a lift of $A_{\star, \text{new}}(O)$ from $\mathbf{U}_{1, -}^{\text{new}} \cup \mathbf{U}_{1, +}^{\text{new}}$; then we project the new prepacman into the dynamical plane of $f_{\star, \text{new}}$; we denote by F_1 the resulting prepacman. By construction, F_1 is a prepacman for $f_{\star, \text{new}}$. Moreover, the associated renormalization triangulation Δ_{F_1} is compactly contained in U . By [DLS, Theorem 2.7], see §3.2.4, there is a pacman renormalization operator defined in a small Banach neighborhood of $f_{\star, \text{new}}$ realizing m_{\min} . By [DLS, Theorem 7.7] (see §3.2.6), \mathcal{R}_{new} is hyperbolic with one-dimensional unstable manifold. \square

6. HOLOMORPHIC MOTION OF THE ESCAPING SET

Consider a maximal prepacman $\mathbf{F} \in \mathcal{W}^u$. Recall that the escaping set $\mathbf{Esc}_S(\mathbf{F}) = \mathbb{C} \setminus \text{Dom}(\mathbf{F}^S)$ is defined for $S \in \mathbb{T} \subset \mathbb{R}_{\geq 0}$. For $M \in \mathbb{R}_{\geq 0}$ we define

$$\mathbf{Esc}_M(\mathbf{F}) := \bigcap_{S \geq M} \mathbf{Esc}_S(\mathbf{F}),$$

where the intersection is taken over all $S \in \mathbb{T}$ with $S \geq M$. For $x \in \mathbf{Esc}(\mathbf{F})$ its *escaping time* is the minimal M such that $\mathbf{Esc}_M(\mathbf{F}) \ni x$.

6.1. Stability of σ -branched structure. We need the following approximation of \mathbf{F} by finite degree branched coverings.

Lemma 6.1. *There is a neighborhood $\mathcal{U} \subset \mathcal{W}^u$ of \mathbf{F}_\star such that for every $\mathbf{F} \in \mathcal{U}$ there are sequences of disks $\mathbf{D}^{(-1)} \subset \mathbf{D}^{(-2)} \subset \dots$ and $\mathbf{W}_\pm^{(-1)} \subset \mathbf{W}_\pm^{(-2)} \subset \dots$ with $\bigcup_{k < 0} \mathbf{D}^{(k)} = \mathbb{C}$ and $\bigcup_{k < 0} \mathbf{W}_\pm^{(k)} = \text{Dom } \mathbf{f}_\pm$ such that*

$$(6.1) \quad (\mathbf{f}_{0, -}, \mathbf{f}_{0, +}): \mathbf{W}_-^{(k)}, \mathbf{W}_+^{(k)} \rightarrow \mathbf{D}^{(k)}$$

are proper branched coverings of finite degree depending continuously on \mathbf{F} when k is fixed. Moreover, all maps (6.1) are Hurwitz equivalent for a fixed k .

It follows, in particular, that the degree of $\mathbf{f}_{0, \pm} | \mathbf{W}_\pm^{(k)}$ is constant and critical points of $\mathbf{f}_{0, \pm}$ do not collide.

Proof. The proof follows the lines of [DLS, Theorem 5.5] asserting that a pacman on the unstable manifold extends to a maximal prepacman. Let us first review the proof of [DLS, Theorem 5.5]; see also §3.2.9.

For a pacman $f_0 \in \mathcal{W}^u$, let

$$\mathfrak{F}_0 = (f_{0,\pm} : \mathfrak{U}_{0,\pm} \rightarrow \mathfrak{S} := V \setminus (\gamma_1 \cup O))$$

be a commuting pair obtained from $F_0 = (f_{0,\pm} : U_{0,\pm} \rightarrow V \setminus \gamma_1)$ by removing a small neighborhood O of α from $V \setminus \gamma_1$ and by removing $f_{0,\pm}^{-1}(O)$ from $U_{0,\pm}$. The map $\phi_k \circ \cdots \circ \phi_{-1}$ embeds \mathfrak{F}_0 to the dynamical plane of f_k as a commuting pair denoted by

$$(6.2) \quad \mathfrak{F}_0^{(k)} = \left(f_k^{\mathbf{a}_k}, f_k^{\mathbf{b}_k} \right) : \mathfrak{U}_{0,-}^{(k)}, \mathfrak{U}_{0,+}^{(k)} \rightarrow \mathfrak{S}_0^{(k)}.$$

Since ϕ_k is contracting at the critical value the diameter of $U_{0,-}^{(k)} \cup U_{0,+}^{(k)} \cup \mathfrak{S}_0^{(k)} \ni c_1(f_n)$ tends to 0. Let us set $c_{1+k}(f_n) := f^k(c_1)$. The key step in verifying the maximal σ -proper extension is the following lemma:

Lemma 6.2 ([DLS, Key Lemma 4.8]). *There is a small open topological disk D around $c_1(f_*)$ and there is a small neighborhood $\mathcal{U} \subset \mathcal{W}^u$ of f_* such that the following property holds. For every sufficiently big $n \geq 1$, for each $\mathfrak{t} \in \{\mathbf{a}_n, \mathbf{b}_n\}$, and for all $f \in \mathcal{R}^{-n}(\mathcal{U})$, we have $c_{1+\mathfrak{t}} \in D$ and D pullbacks along the orbit $c_1(f), c_2(f), \dots, c_{1+\mathfrak{t}}(f) \in D$ to a disk D_0 such that $f^{\mathfrak{t}} : D_0 \rightarrow D$ is a branched covering; moreover, $D_0 \subset U_f \setminus \gamma_1$.*

Lemma 6.2 implies that for a sufficiently big $k < 0$ the pair (6.2) extends into a pair of commuting branched coverings

$$(6.3) \quad F_0^{(k)} = \left(f_k^{\mathbf{a}_k}, f_k^{\mathbf{b}_k} \right) : W_-^{(k)}, W_+^{(k)} \rightarrow D,$$

with $W_-^{(k)} \cup W_+^{(k)} \cup D \subset V \setminus \gamma_1$. Conjugating (6.3) by $A_*^k \circ h_k$ we obtain the commuting pair

$$(\mathbf{f}_{0,-}, \mathbf{f}_{0,+}) : \mathbf{W}_-^{(k)}, \mathbf{W}_+^{(k)} \rightarrow \mathbf{D}^{(k)}$$

such that $\bigcup_{k \ll 0} \mathbf{D}^{(k)} = \mathbb{C}$ (because the modulus of $\mathbf{D}^{(tm-t)} \setminus \mathbf{D}^{(tm)}$ is uniformly bounded away from 0 for $t \gg 0$ and all $m \leq 0$). This implies that

$$(\mathbf{f}_{0,-}, \mathbf{f}_{0,+}) : \bigcup_{k \ll 0} \mathbf{W}_-^{(k)}, \bigcup_{k \ll 0} \mathbf{W}_+^{(k)} \rightarrow \mathbb{C}$$

is a pair of σ -proper maps.

Let us argue that (6.3) can be slightly adjusted such that the new commuting pair depends continuously on f_0 as required. Recall that c_0 and c_1 denote the critical point and the critical value of a pacman f . For $i \geq 0$ we write $c_i = f^i(c_0)$.

By [DLS, Theorem 4.6], if f_0 is sufficiently close to f_* , then for every $k \ll 0$ the disk D can be slightly shrunk to the disk $D(f_0, k)$ (uniformly in k and f_0) such that the following property holds: for $i \leq \max\{\mathbf{a}(k), \mathbf{b}(k)\}$ we have

$$(6.4) \quad D(f_*, k) \ni c_i(f_*) \quad \text{if and only if} \quad D(f_0, k) \ni c_i(f_k)$$

(because points $c_i(f_k)$ are sufficiently close to $c_i(f_*)$). Pulling back $D(f_0, k)$ along the orbit of (6.3), we obtain the extension of (6.2) to the commuting pair

$$(6.5) \quad F_0^{(k)} = \left(f_k^{\mathbf{a}_k}, f_k^{\mathbf{b}_k} \right) : W_-^{\text{new},(k)}, W_+^{\text{new},(k)} \rightarrow D(f_0, k).$$

Note that $f_k: f_k^i(W_\iota^{\text{new},(k)}) \rightarrow f_k^{i+1}(W_\iota^{\text{new},(k)})$ for $\iota \in \{-, +\}$ has degree 2 if and only if $f_k^i(W_\iota^{\text{new},(k)})$ contains the critical point of f_k . By (6.4), the pair (6.5) depends continuously on f_0 as required. Conjugating (6.5) by $A_\star^k \circ h_k$ we obtain the required commuting pair (6.1). \square

Combining with the Implicit Function Theorem, we obtain:

Corollary 6.3. *Set*

$$T := \min\{(0, 1, 0), (0, 0, 1)\}.$$

There is a point $x \in \mathbb{C}$ and an open disk \mathcal{U} containing \mathbf{F}_\star such that $\bigcup_{S \leq T} \mathbf{F}^{-S}(x)$ moves holomorphically with $\mathbf{F} \in \mathcal{U}$.

Proof. By Lemma 4.3, $\text{CV}(\mathbf{F}^T)$ moves holomorphically within a small neighborhood of \mathbf{F}_\star . Therefore, we can shrink \mathcal{U} from Lemma 6.1 and choose a point $x \in \mathbf{U}_-(\mathbf{F}_\star)$ such that x belongs to the interior of $\mathbf{U}_-(\mathbf{F})$ and x does not hit $\text{CV}(\mathbf{F})$ for all $\mathbf{F} \in \mathcal{U}$. By Lemma 6.1, $\mathbf{F}^{-S}(x)$ moves holomorphically with $\mathbf{F} \in \mathcal{U}$ for all $S \leq T$. Since the points $\mathbf{F}^S(x)$ with $S \leq T$ belong to different triangles of $\Delta_0(\mathbf{F})$, the set $\mathbf{F}^{-S}(x)$ is disjoint from $\mathbf{F}^{-Q}(x)$ for $S < Q \leq T$. We obtain a holomorphic motion of $\bigcup_{S \leq T} \mathbf{F}^{-S}(x)$. \square

6.2. Holomorphic motion of the escaping set. We need the following facts.

Lemma 6.4. *Let $g: U \rightarrow V$ be a finite branched covering between open topological disks. If g has a unique critical value, then g also has a unique critical point.*

Proof. By assumption, $g: U \setminus \text{CP}(g) \rightarrow V \setminus \text{CV}(g)$ is a covering. Since $\pi_1(V \setminus \text{CV}(g))$ is an abelian group, so is $\pi_1(U \setminus \text{CP}(g))$. Therefore, $\text{CP}(g)$ is a singleton. \square

Lemma 6.5. *Let $g: \mathbb{D} \rightarrow \mathbb{C}$ be a σ -proper map. Fix an open disk $W \subset \mathbb{C}$. Let U be an open set intersecting $\partial\mathbb{D}$. Then $g^{-1}(W)$ intersects U .*

Proof. Suppose $g^{-1}(W) \cap U = \emptyset$. Choose an open topological disk $V \subset U \cap \mathbb{D}$ such that ∂V is a simple closed curve containing an arc $I \subset \partial\mathbb{D}$. Choosing a point w in W and postcomposing g with a Möbius transformation h moving w to ∞ , we obtain that the new function $s := h \circ g: \mathbb{D} \rightarrow \widehat{\mathbb{C}}$ is bounded on V . By the Fatou Theorem, $s|_V$ has a radial limit at almost every point in ∂V . By the Riesz Theorem, almost all of the radial limits are different from any fixed number, in particular from $h(\infty)$. Therefore, there is an $x \in I$ such that g has a finite radial limit y at x . This contradicts to the assertion that g is σ -proper: if Σ is a small open neighborhood of y , then every connected component of $g^{-1}(\Sigma)$ is disjoint from $\partial\mathbb{D} \ni x$ and the radial limit at x is not $y \in \Sigma$. (In fact, σ -proper maps have no asymptotic values.) Therefore, $g^{-1}(W) \cap U \neq \emptyset$. \square

Remark 6.6. *Lemma 6.5 also holds for every σ -proper map $g: U \rightarrow \mathbb{C}$ defined on a simply connected set $U \subsetneq \mathbb{C}$. In the proof, the angular metric of $\partial\mathbb{D}$ is replaced with the harmonic measure of $\partial U \subset \widehat{\mathbb{C}}$.*

Corollary 6.7. *Consider $\mathbf{F} \in \mathcal{W}^u$ and $P \in \mathbb{T}_{>0}$. Then for every $x \in \mathbb{C}$, the boundary $\partial \text{Dom}(\mathbf{F}^P)$ is the set of accumulating points of $\mathbf{F}^{-P}(x)$.*

Proof. Let U be a connected component of $\text{Dom}(\mathbf{F}^P)$. We claim that the preimages of x under $\mathbf{F}^P|_U$ accumulate at ∂U .

Since the set of critical values of \mathbf{F}^P is discrete (Lemma 4.4), we can choose small neighborhoods $W \ni \Omega \ni x$ so that $W \cap \text{CV}(\mathbf{F}^P) \subset \{x\}$. Thus W contains at most one critical value. By Lemma 6.4, every connected component W' of $\mathbf{F}^{-P}(W)$ contains at most one critical point. By Lemma 4.3, the degree of $\mathbf{F}^P: W' \rightarrow W$ is at most k , where k is independent of W' . Therefore, if Ω' is the connected component of $\mathbf{F}^{-P}(\Omega)$ within W' , then the modulus of $W' \setminus \Omega'$ is uniformly bounded from 0.

Let us precompose $\mathbf{F}^P: U \rightarrow \mathbb{C}$ with a Riemann map $\mathbb{D} \rightarrow \text{Dom}(\mathbf{F}^P)$; we obtain a σ -proper map $g: \mathbb{D} \rightarrow \mathbb{C}$. By Lemma 6.5 and Remark 6.6, for every $y \in \partial \mathbb{D}$, there is a connected component Ω' of $g^{-1}(\Omega)$ close to y . Denote by W' the connected component of $g^{-1}(W)$ containing Ω' . Since $W' \setminus \Omega' \subset \mathbb{D}$ and the modulus of $W' \setminus \Omega'$ is bounded from 0, the component Ω' is small. Since Ω' contains a preimage of x , the corollary is verified. \square

A *conformal motion* of a set $E \subset \mathbb{C}$ parametrized by a complex manifold is a holomorphic motion whose dilatation on E is 0. The following lemma follows from Corollaries 6.7 and 6.3 and is reminiscent to [Re, Theorem 1.1].

Lemma 6.8. *The set*

$$(6.6) \quad \mathcal{D}_P = \mathbb{C} \setminus \mathcal{E}_P := \{\mathbf{F} \in \mathcal{W}^u \mid 0 \notin \mathbf{Esc}_P(\mathbf{F})\}$$

is open. There is a unique equivariant conformal motion τ of $\mathbf{Esc}_P(\mathbf{F})$ along any curve in \mathcal{D}_P .

The escaping set $\mathbf{Esc}(\mathbf{F})$ has empty interior and supports no invariant line field for every $\mathbf{F} \in \mathcal{W}^u$.

We do not claim in this lemma that \mathcal{D}_P is connected. As in [Re], we will show that the motion of $\mathbf{Esc}_S(\mathbf{F})$ has small dilatation for small S (here (4.5) is used), and then dynamically extend the motion of $\mathbf{Esc}_S(\mathbf{F})$ to the motion of $\mathbf{Esc}_P(\mathbf{F})$ with the same dilatation.

Proof. Consider T, \mathcal{U} , and x from Corollary 6.3; i.e. $\bigcup_{S \leq T} \mathbf{F}^{-S}(x)$ moves holomorphically with $\mathbf{F} \in \mathcal{U}$, where \mathcal{U} is a neighborhood of \mathbf{F}_* . Applying the λ -lemma, we obtain the holomorphic motion τ of $\bigcup_{S \leq T} \mathbf{F}^{-S}(x)$. By Corollary 6.7,

$$(6.7) \quad \partial \mathbf{Esc}_T(\mathbf{F}) \subset \overline{\bigcup_{S \leq T} \mathbf{F}^{-S}(x)}$$

moves holomorphically with $\mathbf{F} \in \mathcal{U}$. Clearly, τ is an equivariant motion.

In particular, τ induces an equivariant qc map between $\mathbf{Esc}_T(\mathbf{F})$ and $\mathbf{Esc}_T(\mathbf{F}_*)$ for every $\mathbf{F} \in \mathcal{U}$. By Lemma 5.39, $\mathbf{Esc}_T(\mathbf{F}_*)$ has empty interior and supports no invariant line field. Therefore, $\mathbf{Esc}_T(\mathbf{F})$ has empty interior and supports no invariant line field and τ is a holomorphic motion of $\mathbf{Esc}_T(\mathbf{F}) = \partial \mathbf{Esc}_T(\mathbf{F})$. Observe that the dilatation of τ is small if \mathbf{F} is close to \mathbf{F}_* . Moreover, by Proposition 5.37, we have:

$$(6.8) \quad \mathbf{Esc}_M(\mathbf{F}) = \overline{\bigcup_{S \leq M} \mathbf{Esc}_S(\mathbf{F})}.$$

for all $M \leq T$.

Let us now show that the definition of τ is independent of x . Suppose that $y_{\mathbf{G}} \in \mathbb{C} \setminus \text{CV}(\mathbf{G})$ is a point that depends holomorphically on \mathbf{G} in a small neighborhood of $\mathbf{F} \in \mathcal{U}$. In a smaller neighborhood of \mathbf{F} , we can connect $x, y_{\mathbf{G}}$ by a simple arc $\ell_{\mathbf{G}} \subset \mathbb{C} \setminus \text{CV}(\mathbf{G})$ and surround $\ell_{\mathbf{G}}$ by an annulus $A_{\mathbf{G}} \subset \mathbb{C} \setminus \text{CV}(\mathbf{G})$ (we recall that $\text{CV}(\mathbf{G}^T)$ depends continuously on \mathbf{G} by Lemma 4.3). If ℓ_n is a sequence of preimages of $\ell_{\mathbf{G}}$ under \mathbf{G}^T accumulating at a point in $\mathbf{Esc}_T(\mathbf{G}) = \partial \mathbf{Esc}_T(\mathbf{G})$, then the diameter of ℓ_n tends to 0 because every ℓ_n is separated from $\mathbf{Esc}_T(\mathbf{G})$ by a conformal preimage of $A_{\mathbf{G}}$. Therefore, the motion τ coincides with the motion of

$$\mathbf{Esc}_T(\mathbf{G}) \subset \overline{\mathbf{G}^{-T}(y_{\mathbf{F}})}$$

in a small neighborhood of \mathbf{F} .

We claim that τ is the unique equivariant holomorphic motion of $\mathbf{Esc}_T(\mathbf{F})$. Suppose τ' is another equivariant holomorphic motion of $\mathbf{Esc}_T(\mathbf{G})$ defined in some neighborhood of \mathbf{F} . Choose a small $S \in \mathbb{T}$ and a point $y \in \mathbf{Esc}_S(\mathbf{G})$ and let $y_{\mathbf{F}}$ be the motion of y induced by τ' . Since τ' is equivariant, the motion of $\mathbf{F}^{S-T}(y_{\mathbf{F}})$ is τ' . Since

$$\mathbf{Esc}_{T-S}(\mathbf{F}) \subset \overline{\mathbf{F}^{S-T}(y_{\mathbf{F}})}$$

we see that τ' and τ coincide on $\mathbf{Esc}_{T-S}(\mathbf{F})$ for all $S \in \mathbb{T}_{>0}$ such that $S < T$. Therefore, the motions τ and τ' coincide on $\mathbf{Esc}_{T-S}(\mathbf{F})$ and, by (6.8), on $\mathbf{Esc}_T(\mathbf{F})$.

Let us show that the set

$$(6.9) \quad \mathcal{D}_P \cap \mathcal{U} = \{\mathbf{F} \in \mathcal{U} \mid 0 \notin \mathbf{Esc}_P(\mathbf{F})\}$$

is open for every $P \in \mathbb{T}$ and that the motion of $\mathbf{Esc}_T(\mathbf{F})$ can be dynamically extended (with the same dilatation) to a motion of $\mathbf{Esc}_P(\mathbf{F})$ with $\mathbf{F} \in \mathcal{D}_P$. If $P \leq T$, then $\mathcal{D}_P \supset \mathcal{U}$ and the claim is immediate. Assume that $T < P \leq 2T$. We have: $\mathbf{F} \in \mathcal{D}_P \cap \mathcal{U}$ if and only if $\mathbf{F}^T(0) \notin \mathbf{Esc}_{P-T}(\mathbf{F})$ because $0 \in \text{Dom}(\mathbf{F}^T)$; this is an open condition because $\mathbf{Esc}_{P-T}(\mathbf{F}) \subset \mathbf{Esc}_T(\mathbf{F})$ moves holomorphically with $\mathbf{F} \in \mathcal{U}$. Moreover, for every $\mathbf{F} \in \mathcal{D}_P \cap \mathcal{U}$, we can pull back the holomorphic motion of $\mathbf{Esc}_T(\mathbf{F})$ to the holomorphic motion of $\mathbf{Esc}_P(\mathbf{F}) \setminus \mathbf{Esc}_{P-T}(\mathbf{F})$ via a covering

$$\mathbf{F}^T : \mathbf{Esc}_P(\mathbf{F}) \setminus \mathbf{Esc}_{P-T}(\mathbf{F}) \rightarrow \mathbf{Esc}_T(\mathbf{F});$$

combining with the motion of $\mathbf{Esc}_{P-T}(\mathbf{F}) \subset \mathbf{Esc}_T(\mathbf{F})$, we obtain the motion of $\mathbf{Esc}_P(\mathbf{F})$ without changing dilatation. For $2^{n-1}T < P \leq 2^nT$, we apply an induction.

For every $\mathbf{F} \in \mathcal{W}^u$, there is a sufficiently big $n \ll 0$ such that \mathbf{F}_n is close to \mathbf{F}_* ; in particular, $\mathbf{F}_n \in \mathcal{U}$. Setting $L = P\mathfrak{t}^{-n}$, we obtain from (4.5) that $\mathbf{F} \in \mathcal{D}_P$ if and only if $\mathbf{F}_n \in \mathcal{D}_L$. This shows that (6.6) is open as a union of open sets. It also follows that $\mathbf{Esc}_P(\mathbf{F})$ moves holomorphically with $\mathbf{F} \in \mathcal{D}_P$. The dilatation of the motion of $\mathbf{Esc}_P(\mathbf{F})$ is equal to the dilatation of $\mathbf{Esc}_L(\mathbf{F}_n)$ and can be made arbitrary small by choosing \mathbf{F}_n close to \mathbf{F}_* . This shows that the holomorphic motion is conformal.

It was already proven that $\mathbf{Esc}_L(\mathbf{F})$ has empty interior and supports no invariant line field for sufficiently small L . Therefore, $\mathbf{Esc}_P(\mathbf{F})$ supports no invariant line field and has empty interior. \square

Corollary 6.9. *For every $\mathbf{F} \in \mathcal{W}^u$ we have $\mathbf{Esc}(\mathbf{F}) \neq \emptyset$ and $\mathfrak{J}(\mathbf{F}) = \overline{\mathbf{Esc}(\mathbf{F})}$.*

Proof. For a small $P \in \mathbb{T}_{>0}$, the escaping set $\mathbf{Esc}_P(\mathbf{F})$ is homeomorphic to $\mathbf{Esc}_P(\mathbf{F}_*) \neq \emptyset$. Since $\mathbf{Esc}_P(\mathbf{F})$ contains at least two points, applying the Montel theorem we

obtain that every neighborhood of $z \in \mathfrak{J}(\mathbf{F})$ contains a preimage of a point in $\mathbf{Esc}_P(\mathbf{F})$. \square

6.3. External rays and alpha-points of \mathbf{F} . Choose $S \in \mathbb{T}_{>0}$ and a sufficiently small $\varepsilon > 0$ such that the open ε -neighborhood \mathcal{U} of $\mathbf{F}_\star \in \mathcal{W}^u \simeq \mathbb{C}$ is contained in \mathcal{D}_S , see Lemma 6.8. For every pair of prepacmen \mathbf{F}, \mathbf{G} there is a sufficiently big $n \ll 0$ such that $\mathbf{F}_n, \mathbf{G}_n \in \mathcal{U}$. Since \mathcal{U} is a topological disk, there is a unique up to homotopy path ℓ in \mathcal{U} connecting \mathbf{F}_n and \mathbf{G}_n . The holomorphic motion τ (from Lemma 6.8) along ℓ produces an equivariant homeomorphism between $\mathbf{Esc}_S(\mathbf{F}_n)$ and $\mathbf{Esc}_S(\mathbf{G}_n)$; after rescaling we obtain an equivariant homeomorphism

$$h: \mathbf{Esc}_{t^n S}(\mathbf{F}) \rightarrow \mathbf{Esc}_{t^n S}(\mathbf{G}).$$

Taking the restriction, we obtain an equivariant homeomorphism

$$h: \mathbf{Esc}_Q(\mathbf{F}) \rightarrow \mathbf{Esc}_Q(\mathbf{G}).$$

for all $Q < t^n S$; clearly h is independent of n (because $\mathcal{R}^{-1}(\mathcal{U}) \subset \mathcal{U}$). We say that h is the *canonical identification* of $\mathbf{Esc}_Q(\mathbf{F})$ and $\mathbf{Esc}_Q(\mathbf{G})$.

Consider $\mathbf{G} \in \mathcal{W}^u$ and choose a sufficiently small $T \in \mathbb{T}_{>0}$ so that $\mathbf{Esc}_T(\mathbf{G})$ and $\mathbf{Esc}_T(\mathbf{F}_\star)$ are canonically identified. *Alpha-points of \mathbf{G} of generation $S \leq T$* are the images of the corresponding alpha-points of \mathbf{F}_\star under the canonical identification. Similarly, *ray segments in $\mathbf{Esc}_T(\mathbf{G})$* are the images of ray segments in $\mathbf{Esc}_T(\mathbf{F}_\star)$ under the canonical identification.

If $\alpha_i \in \mathbf{Esc}_T(\mathbf{G})$ is an alpha-point of generation S , then $\mathbf{F}^{-P}(\alpha_i)$ are *alpha-points of generation $S + P$* . Similarly, if $\gamma \subset \mathbf{Esc}_T(\mathbf{F})$ is a ray segment connecting two alpha-points and ℓ is a connected component of $\mathbf{F}^{-P}(\gamma)$ such that $\mathbf{F}^P: \gamma \rightarrow \ell$ is a homeomorphism, then ℓ is also a *ray segment*. Note that ℓ also connects two alpha-points.

External rays for \mathbf{G} are defined in the same way as for \mathbf{F}_\star , see §5.9. Namely, an external ray \mathbf{R} is a maximal concatenation of external ray segments provided that it does not hit an iterated preimage of 0. (An external ray “breaks” at a pre-critical point.)

Lemma 6.10. *Suppose $0 \notin \mathbf{Esc}_P(\mathbf{F})$ and $0 \notin \mathbf{Esc}_P(\mathbf{G})$. Then there is a unique equivariant bijection $h: \mathbf{Esc}_P(\mathbf{F}) \rightarrow \mathbf{Esc}_P(\mathbf{G})$ such that $h: \mathbf{Esc}_Q(\mathbf{F}) \rightarrow \mathbf{Esc}_Q(\mathbf{G})$ coincides with the homeomorphism induced by τ for all sufficiently small $Q \in \mathbb{T}_{>0}$.*

Let \mathbf{R} be an external ray of \mathbf{G} . Then \mathbf{R} has a unique counterpart $\mathbf{R}(\mathbf{F}_\star)$ in the dynamical plane of \mathbf{F}_\star such that for all sufficiently small Q the natural homeomorphism $h: \mathbf{Esc}_Q(\mathbf{G}) \rightarrow \mathbf{Esc}_Q(\mathbf{F}_\star)$ induced by τ extends to a homeomorphism

$$h: \mathbf{Esc}_Q(\mathbf{G}) \cup \mathbf{R}(\mathbf{G}) \rightarrow \mathbf{Esc}_Q(\mathbf{F}_\star) \cup \mathbf{R}(\mathbf{F}_\star)$$

that is equivariant in the following sense. For every $x \in \mathbf{R}(\mathbf{G})$ with $\mathbf{G}^T(x) \in \mathbf{Esc}_Q(\mathbf{G})$ we have $h \circ \mathbf{G}^T(x) = \mathbf{F}_\star^T \circ h(x)$.

Proof. Let P' be the minimal escaping time of 0 for \mathbf{F} and \mathbf{G} ; we have $P < P'$. Since \mathbb{T} is dense in $\mathbb{R}_{\geq 0}$, we can slightly increase P so that the new P is still less than P' , and $R := P/m \in \mathbb{T}$, and $R < Q/3$ for some $m \in \mathbb{Z}_{>0}$.

Let us say that a *decoration* is a connected component of $\mathbf{Esc}_{iR}(\mathbf{F}) \setminus \mathbf{Esc}_{(i-1)R}(\mathbf{F})$ for $i \in \{1, 2, \dots, m\}$; we say that i is the *generation* of the decoration. Note that $\mathbf{Esc}_R(\mathbf{F})$ is a decoration of generation 1. We will show that decorations for \mathbf{G} and \mathbf{F}_\star are arranged in the same way.

Claim. In the dynamical planes of $\mathbf{F} \in \{\mathbf{F}_*, \mathbf{G}\}$ consider a decoration X_j of generation $i > 1$. Then X_j is precompact and there is a unique alpha-point α_j of generation $(i-1)R$ such that $X_j \cup \alpha_j$ is compact. Moreover, X_j and $X_j \cup \alpha_j$ are filled-in (i.e., their complements are connected). The image $\mathbf{F}^R(X_j)$ is a decoration $X_{\mathbf{F}_*(j)}$ of generation $i-1$. If $i < m$, then for every $\alpha_s \in \mathbf{F}^{-R}(\alpha_j)$, there is a unique decoration X_s of generation $i+1$ such that $\overline{X}_s = X_s \cup \{\alpha_s\}$ and $\mathbf{F}^R(X_s) = X_j$.

Proof of the Claim. The case $\mathbf{F} = \mathbf{F}_*$ follows from the second part of Lemma 5.18. Since there is an equivariant homeomorphism between $\mathbf{Esc}_{3R}(\mathbf{G})$ and $\mathbf{Esc}_{3R}(\mathbf{F}_*)$ (recall that), the claim is also true if $\mathbf{F} = \mathbf{G}$ and $i \leq 3$.

Suppose that X_j is a decoration of generation $i > 3$ in the dynamical plane of \mathbf{G} . Choose $x \in X_j$ and let X_k be the decoration of generation 2 containing $\mathbf{F}^{(i-2)R}(x)$. Since the claim is already verified for X_k , we have $\overline{X}_k = X_k \cup \{\alpha_k\}$ is compact and filled-in. Since \overline{X}_k does not contain a critical value of $\mathbf{F}^{(i-2)R}$ and since the set of the critical values is discrete (see Lemma 4.4), there is an open topological disk $U_k \supset \overline{X}_k$ such that U_k does not contain any critical point of $\mathbf{F}^{(i-2)R}$. Pulling back U_k along the orbit of x and using σ -properness, we construct a univalent preimage $U_j \ni x$ of U_k under $\mathbf{F}^{(i-2)R}$. It now follows that $\overline{X}_j = X_j \cup \{\alpha_j\}$ is the preimage of $X_k \cup \{\alpha_k\}$ under $\mathbf{F}^{(i-2)R}$: $U_j \rightarrow U_k$.

If $\alpha_s \in \mathbf{G}^{-R}(\alpha_j)$, then pulling back U_j along $\mathbf{F}^R: \alpha_s \mapsto \alpha_j$ (and possibly shrinking U_j so that U_j does not contain a critical value of \mathbf{F}^R) we construct a univalent preimage $U_s \ni \alpha_s$ of U_j . Then X_s is the preimage of X_j under \mathbf{F}^R : $U_s \rightarrow U_j$. \square

Observe that all decorations of \mathbf{F}_* and \mathbf{G} are canonically homeomorphic by an equivariant homeomorphism: all decorations are univalent preimages of $\mathbf{Esc}_R(\mathbf{F}_*)$ and $\mathbf{Esc}_R(\mathbf{G})$ which are canonically identified. We proceed by induction: suppose that h has been already extended to an equivariant bijection

$$h: \mathbf{Esc}_{tR}(\mathbf{F}_*) \rightarrow \mathbf{Esc}_{tR}(\mathbf{G})$$

where $t < m$. Then h induces a bijection between alpha-points of generation tR . There is a decoration of generation $t+1$ attached to every alpha-point of generation tR ; since these decorations are canonically homeomorphic, we can uniquely extend h to the bijection

$$h: \mathbf{Esc}_{(t+1)R}(\mathbf{F}_*) \rightarrow \mathbf{Esc}_{(t+1)R}(\mathbf{G}).$$

To prove the second claim, fix $T < Q$ and decompose \mathbf{R} as a concatenation of arcs $\mathbf{R}_1 \cup \mathbf{R}_2 \cup \dots$ such that $\mathbf{R}_i \subset \mathbf{Esc}_{iT}(\mathbf{G}) \setminus \mathbf{Esc}_{(i-1)T}(\mathbf{G})$. Inductively define $\mathbf{R}_i(\mathbf{F}_*)$ to be the unique lift of $h \circ \mathbf{G}^{T(i-1)}(\mathbf{R}_i(\mathbf{G}))$ under $\mathbf{F}_*^{T(i-1)}$ starting where $\mathbf{R}_{i-1}(\mathbf{F}_*)$ ends. \square

By Lemmas 6.8 and 6.10, the combinatorics of external rays for $\mathbf{G} \in \mathcal{W}^u$ is the same as for \mathbf{F}_* .

Corollary 6.11 (τ has no holonomy). *If \mathbf{F}, \mathbf{G} are in the same connected component of \mathcal{D}_P , then the equivariant homeomorphism $h: \mathbf{Esc}_P(\mathbf{F}) \rightarrow \mathbf{Esc}_P(\mathbf{G})$ induced by τ (see Lemma 6.8) is independent of the curve connecting \mathbf{F} and \mathbf{G} .* \square

Corollary 6.12. *For every $K > 1$ and $\mathbf{F}, \mathbf{G} \in \mathcal{W}^u$, there exists a sufficiently small $T \in \mathbb{T}_{>0}$ such that the equivariant homeomorphism*

$$h: \mathbf{Esc}_T(\mathbf{F}) \rightarrow \mathbf{Esc}_T(\mathbf{G})$$

induced by the holomorphic motion from Lemma 6.8 extends to a qc map $\tilde{h}: \mathbb{C} \rightarrow \mathbb{C}$ with dilatation less than K .

Proof. For a sufficiently small T , the hyperbolic distance between \mathbf{F} and \mathbf{G} in \mathcal{D}_T is small. The λ -lemma extends h to a qc map with a small dilatation. \square

6.4. Puzzle pieces. Consider a dynamical plane of \mathbf{G} . Let us say a ray \mathbf{R} *lands* if either \mathbf{R} lands at a point $x \in \mathbb{C}$ in the classical sense, or \mathbf{R} lands at α , see §4.7. A *rational ray* is either a periodic or preperiodic ray.

Let $\tilde{\mathbf{R}} = \{\mathbf{R}^1, \mathbf{R}^2, \dots, \mathbf{R}^n\}$ be a finite set of rational rays. We assume that every \mathbf{R}^i lands. We define

$$\bar{\mathbf{R}} := \overline{\bigcup_i \bigcup_{P \geq 0} \mathbf{G}^P(\mathbf{R}^i)}$$

to be the forward orbit of rays in $\tilde{\mathbf{R}}$.

Lemma 6.13. *The set $\bar{\mathbf{R}}$ is a forward invariant connected graph.*

Proof. Recall from Corollary 5.27 that every two external rays eventually meet. Therefore, $\bar{\mathbf{R}}$ is connected.

Fix a compact subset $\mathbf{X} \Subset \mathbb{C}$. Let T_1 be a common period of rays in $\tilde{\mathbf{R}}$ and let T_2 be a common preperiod of rays in $\tilde{\mathbf{R}}$; write $T := T_1 + T_2$. We need to prove that there are at most finitely many $P < T$ such that $\mathbf{G}^P(\mathbf{R}^i)$ intersects \mathbf{X} for some i ; this would imply that $\bar{\mathbf{R}}$ is an increasing union of finite graphs as required, see List of Notations.

Choose a sufficiently small $Q > 0$ such that $\mathbf{Esc}_Q(\mathbf{G})$ is disjoint from \mathbf{X} . Let \mathfrak{x}' be the set of the landing points of rays in $\tilde{\mathbf{R}}$, and set $\mathfrak{x} = \bigcup_{P \in \mathbb{T}} \mathbf{F}^P(\mathfrak{x}') = \bigcup_{P \leq T} \mathbf{F}^P(\mathfrak{x}')$. By Lemma 4.4, $\mathbf{X} \cap \mathfrak{x}$ is a finite set. Note that \mathfrak{x} may contain α . Choose a small neighborhood \mathcal{O} of \mathfrak{x} .

We can choose finitely many external ray segments $\mathbf{R}_1, \dots, \mathbf{R}_m$ in $\bar{\mathbf{R}}$ such that

- $\bar{\mathbf{R}} \cap (\mathbf{X} \setminus \mathcal{O})$ is covered by the forward orbits of the \mathbf{R}_j ; and
- for every \mathbf{R}_j there exists P_j with $\mathbf{R}_j \Subset \text{Dom}(\mathbf{G}^{P_j})$ such that $\mathbf{G}^{P_j}(\mathbf{R}_j) \subset \mathbf{Esc}_Q(\mathbf{G})$.

By Corollary 4.5, there are at most finitely many $S < P_j$ such that $\mathbf{G}^S(\mathbf{R}_j)$ intersects $\mathbf{X} \setminus \mathcal{O}$. Therefore, at most finitely many rays in $\bar{\mathbf{R}}$ intersect $\mathbf{X} \setminus \mathcal{O}$. Since \mathcal{O} is a sufficiently small neighborhood of \mathfrak{x} , at most finitely many rays in $\bar{\mathbf{R}}$ can enter \mathcal{O} . \square

A *puzzle piece* \mathbf{X} is the closure of a connected component of $\mathbb{C} \setminus \bar{\mathbf{R}}$. Since the forward orbit of $\partial\mathbf{X}$ is disjoint from $\text{int } \mathbf{X}$, we have the following classical property. If \mathbf{Y} is the closure of a connected component of $\mathbf{F}^{-S}(\text{int } \mathbf{X})$, then either \mathbf{X} and \mathbf{Y} have disjoint interiors, or $\mathbf{Y} \subset \mathbf{X}$.

Let us note that a puzzle piece can be surrounded by a single external ray, see example in Lemma 7.3. This happens when a preperiodic ray lands at itself; a certain iterate of such ray eventually lands at α .

We say that a puzzle piece $\mathbf{X}(\mathbf{G})$ from the dynamical plane of \mathbf{G} *exists* in the dynamical plane of \mathbf{F} if \mathbf{F} has a puzzle piece $\mathbf{X}(\mathbf{F})$ such that $\partial\mathbf{X}(\mathbf{G})$ and $\partial\mathbf{X}(\mathbf{F})$ are combinatorially equivalent: there is a homeomorphism $h: \partial\mathbf{X}(\mathbf{G}) \rightarrow \partial\mathbf{X}(\mathbf{F})$ induced by the natural identification of external rays, see Lemma 6.10.

6.5. Parameter rays. Similar to many parameter spaces in complex dynamics, it is natural to expect:

Conjecture 6.14. *For every $x \in \mathbf{Esc}(\mathbf{F}_\star)$ there is a unique parameter $\mathbf{G} \in \mathcal{W}^u$ such that $0 = x(\mathbf{G})$; i.e. there is a path in \mathcal{W}^u connecting \mathbf{F}_\star and \mathbf{G} such that the geodesic ray segment $[x, \infty] \in \mathbf{Esc}(\mathbf{F}_\star)$ moves holomorphically along the path and such that 0 collides with x in the dynamical plane of \mathbf{G} .*

Conjecture 6.14 would imply that the *phase parameter relation*

$$(6.10) \quad \mathbf{Esc}(\mathbf{F}_\star) \longrightarrow \mathcal{W}^u, \quad x(\mathbf{F}_\star) \mapsto \mathbf{G} \quad \text{such that} \quad 0 = x(\mathbf{G})$$

is a well-defined homeomorphism onto the image. A *parameter ray* is the image of a dynamic ray under (6.10). Conjecture 6.14 would immediately imply that the parameter limbs are bounded (as pictures predict, see Figure 16) and it should significantly improve the results of our paper. Combined with the conjectural Full Hyperbolicity of neutral renormalization, this may give a complete understanding of geometry near the boundaries of hyperbolic components with a single bifurcating critical point, see Remark 9.1.

7. PARABOLIC BIFURCATION AND SMALL \mathcal{M} -COPIES

7.1. Parabolic prepacman \mathbf{F}_τ . In a small neighborhood of f_\star consider a parabolic pacman $f_\tau \in \mathcal{W}^u$ with rotation number $\tau = p/q$. Recall from §3.2.14 that \mathbf{H} denotes the global attracting basin; its periodic components are parametrized as $(\mathbf{H}^i)_{i \in \mathbb{Z}}$. We write the first return map to \mathbf{H}^0 as

$$(7.1) \quad \mathbf{F}_\tau^{Q(\tau)}: \mathbf{H}^0 \rightarrow \mathbf{H}^0.$$

Then (7.1) is a two-to-one map with a unique critical value at 0. Moreover, $\mathbf{F}_\tau^T: \mathbf{H}^0 \rightarrow \mathbf{F}_\tau^T(\mathbf{H}^0) = \mathbf{H}^{i(T)}$ is univalent for all $T < Q(\tau)$, where $i(T) \in \mathbb{Z} \setminus \{0\}$. For standard reasons, \mathbf{H}^i is a Fatou component.

Let $U \subsetneq \mathbb{C}$ be an open simply connected set.

We say that a univalent map $f: U \rightarrow U$ is a *local attracting parabolic petal* if it admits a *local Fatou coordinate*: a univalent map $h: U \rightarrow \mathbb{C}$ conjugating $f: U \rightarrow U$ to the translation $T_1: z \rightarrow z + 1$ such that $\text{Im } f \supset \{z \in \mathbb{C} \mid \text{Re } z \geq M\}$ for some $M \in \mathbb{R}$.

We say that a branched covering of finite degree $f: U \rightarrow U$ is a *full attracting parabolic petal* if f restricts to a local attracting parabolic petal $f: U' \rightarrow U'$ for some $U' \subset U$. For standard reasons, every point in U is eventually attracted by U' . Hence, a local Fatou coordinate system $h: U' \rightarrow \mathbb{C}$ extends to a branched covering $h: U \rightarrow \mathbb{C}$ semi-conjugating f to T_1 . We call $h: U \rightarrow \mathbb{C}$ a *global Fatou coordinate*.

We say that a full attracting parabolic petal $f: U \rightarrow U$ is *unicritical* if f has a unique critical value. By Lemma 6.4, f also has a unique critical point.

Lemma 7.1. *Let $f: U \rightarrow U, g: V \rightarrow V$ be two unicritical full attracting parabolic petals of the same degree. Then f and g are conformally conjugate.*

Proof. We normalize full Fatou coordinate systems $h_f: U \rightarrow \mathbb{C}$ and $h_g: V \rightarrow \mathbb{C}$ so that

$$0 = h_f(\text{critical value of } f) = h_g(\text{critical value of } g).$$

Choose next local attracting parabolic petals $f: U' \rightarrow U'$ and $g: V' \rightarrow V'$ so that $h := h_f \circ h_g^{-1}$ is a conjugacy between $f: U' \rightarrow U'$ and $g: V' \rightarrow V'$. We can also

assume that U' and V' contain the critical values of f and g . Since h respects the postcritical sets, we can apply the pullback argument and extend h to a global conjugacy $h: U \rightarrow V$ between f and g . \square

Recall that the quadratic polynomial $p_{1/4} = z^2 + 1/4$ has a parabolic fixed point at $\alpha(p_{1/4}) = 1/2$. We denote by \mathbb{P} the attracting basin of $\alpha(p_{1/4})$. Note that $p_{1/4}: \partial\mathbb{P} \rightarrow \partial\mathbb{P}$ is topologically conjugate to $z \mapsto z^2: \mathbb{S}^1 \rightarrow \mathbb{S}^1$. By Lemma 7.1, there is a conformal conjugacy

$$(7.2) \quad \mathbf{h}_i: \mathbf{H}^i \rightarrow \mathbb{P}$$

between $\mathbf{F}_\tau^{Q(\tau)}: \mathbf{H}^i \rightarrow \mathbf{H}^i$ and $p_{1/4}: \mathbb{P} \rightarrow \mathbb{P}$.

Recall that Δ denotes the main hyperbolic component of \mathcal{W}^u , see §4.1. Choose a curve $\ell \subset \overline{\Delta}$ connecting \mathbf{F}_\star to \mathbf{F}_τ . For every $T \in \mathbb{T}$ there is a small neighborhood of ℓ where the holomorphic motion τ of $\mathbf{Esc}_T(\mathbf{G})$ is defined, see Lemma 6.8. Then τ produces an equivariant homeomorphism

$$h: \mathbf{Esc}_T(\mathbf{F}_\star) \rightarrow \mathbf{Esc}_T(\mathbf{F}_\tau).$$

Therefore, $\mathbf{Esc}(\mathbf{F}_\tau)$ has the same properties as $\mathbf{Esc}(\mathbf{F}_\star)$; in particular, $\mathbf{Esc}(\mathbf{F}_\tau)$ is uniquely geodesic.

Theorem 7.2. *If $i \neq j$, then $\overline{\mathbf{H}}^i \cap \overline{\mathbf{H}}^j = \emptyset$. The conjugacy $\mathbf{h}_i: \mathbf{H}^i \rightarrow \mathbb{P}$ extends uniquely to a topological conjugacy*

$$(7.3) \quad \mathbf{h}_i: \overline{\mathbf{H}}^i \cup \{\alpha(\mathbf{F}_\tau)\} \rightarrow \overline{\mathbb{P}}$$

For every i there is a unique external ray \mathbf{R}^i landing at $\alpha(\mathbf{F}_\tau)$ such that \mathbf{R}^i is between \mathbf{H}^i and \mathbf{H}^{i+1} . The ray \mathbf{R}^i is $Q(\tau)$ -periodic. Moreover, \mathbf{R}^i and \mathbf{R}^{i-1} meet at $\alpha(1/2, \mathbf{H}^i)$ – the unique preimage of $\alpha(\mathbf{F}_\tau)$ in \mathbb{C} under $\mathbf{F}_\tau^{Q(\tau)}: \overline{\mathbf{H}}^0 \cup \{\alpha(\mathbf{F}_\tau)\} \rightarrow \overline{\mathbf{H}}^0 \cup \{\alpha(\mathbf{F}_\tau)\}$.

Let $\mathbf{W}(i)$ be the closed puzzle piece bounded by \mathbf{R}^{i-1} and \mathbf{R}^i and containing \mathbf{H}^i , and let \mathbf{W}^1 be the pullback of $\mathbf{W} := \mathbf{W}(0)$ along $\mathbf{F}_\tau^{Q(\tau)}: \mathbf{H}^0 \rightarrow \mathbf{H}^0$, see Figure 33. Then

$$(7.4) \quad \mathbf{F}_\tau^{Q(\tau)}: \mathbf{W}^1 \rightarrow \mathbf{W}.$$

is a 2-to-1 map.

We say that (7.4) is the *primary renormalization map*. It can be thickened to a “pinched quadratic-like map”. Before giving the proof of Theorem 7.2 let us introduce an expanding metric for \mathbf{F}_τ .

7.1.1. *Expanding metric for \mathbf{F}_τ .* Let $B \subset \mathbb{P}$ be a forward invariant open topological disk containing $[1/4, 1/2)$ such that \overline{B} is a closed topological disk with

$$\partial B \cap p_{1/4}(\overline{B}) = \alpha(p_{1/4}) = \overline{B} \cap \partial\mathbb{P}$$

(recall that $1/4$ is the critical value of $p_{1/4}$). We can take B to be an appropriate small neighborhood of $[1/4, 1/2)$.

Define $\mathbb{B}^0 := \mathbf{h}_0^{-1}(B)$ and observe that $\overline{\mathbb{B}}^0 \subset \mathbf{H}^0$. Spreading around $\overline{\mathbb{B}}^0$, we obtain

$$\mathbb{B} := \bigcup_{P \geq 0} \mathbf{F}_\tau^P(\overline{\mathbb{B}}^0) \subset \bigcup_{i \in \mathbb{Z}} \mathbf{H}^i.$$

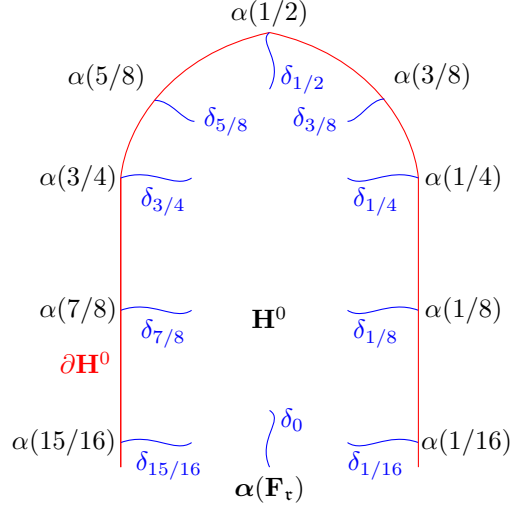

FIGURE 32. Alpha-points of $\partial\mathbf{H}^0$ are defined at the landing points of curves in \mathbf{H}^0 (compare with Figure 33).

By construction, \mathbb{B} contains the postcritical set $\mathfrak{P}(\mathbf{F}_\tau)$. Consider the hyperbolic surface $\mathbf{X} := \mathbb{C} \setminus \overline{\mathbb{B}}$. Then $\mathbf{F}_\tau^{-T}(\mathbf{X}) \subsetneq \mathbf{X}$ and

$$(7.5) \quad \mathbf{F}_\tau^T : \mathbf{F}_\tau^{-T}(\mathbf{X}) \rightarrow \mathbf{X}$$

is a covering for all T . By Schwartz's lemma, (7.5) expands the hyperbolic metric.

Proof of Theorem 7.2. Choose $\mu \in (1/4, 1/2)$. In the dynamical plane of $p_{1/4}$, define δ'_0 to be the interval $[\mu, 1/2) \subset \mathbb{P}$ landing at $1/2$. We view δ'_0 as a simple arc parametrized by $[0, 1)$. Set $\alpha(k/2^n, p_{1/4})$ to be the landing point of the external ray with angle $k/2^n$, where $k \in \{1, 3, 5, \dots, 2^n - 1\}$. Note that $\alpha(k/2^n, p_{1/4})$ is a preimage of α under $p_{1/4}^n$. We define $\delta'_{k/2^n}$ to be the lift of δ'_0 under $p_{1/4}^n$ landing at $\alpha(k/2^n, p_{1/4})$. Let $\delta_{k/2^n}$ be the lift of $\delta'_{k/2^n}$ under \mathbf{h}_0 .

Claim 1: δ_0 lands at $\alpha(\mathbf{F}_\tau)$ while $\delta_{k/2^n}$ with $k \in \{1, 3, 5, \dots, 2^n - 1\}$ land at pairwise different alpha-points of generation $nQ(\tau)$. We denote by $\alpha(k/2^n, \mathbf{H}^0)$ the landing point of $\delta_{k/2^n}$, see Figure 32.

Proof of the claim. Recall that $\mathcal{W}_{\text{loc}}^u$ denotes the set of maximal prepacmen close to \mathbf{F}_\star that have the associated pacmen on \mathcal{W}^u . By definition, $\mathbf{F}_\tau \in \mathcal{W}^u$. Applying the λ -lemma, we will first show that a certain version of Lemma 5.12 holds in the dynamical plane of $\mathbf{G} \in \mathcal{W}_{\text{loc}}^u$.

Since δ_0 is invariant under $\mathbf{F}_\tau^{Q(\tau)}$, by replacing δ_0 with its subcurve $\delta_0[t, 1)$, we can assume that δ_0 is contained in \mathbf{H}_0^0 (see §3.2.14). Thus $\delta_0(\mathbf{F}_\tau)$ projects to the dynamical plane of f_τ , and the projection, call it $\delta_0(f_\tau)$, is disjoint from the critical arc γ_1 , possibly up to a slight rotation of γ_1 as in §3.2.14.

For $g \in \mathcal{W}^u$, let T_g be the unique translation mapping $\alpha(f_\tau)$ to $\alpha(g)$. For every $\mathbf{G} \in \mathcal{W}_{\text{loc}}^u$, we define $\delta_0(\mathbf{G})$ to be the lift of $\delta_0(g) := T_g(\delta_0(f_\tau))$ to $\mathbf{S}(\mathbf{G}) \simeq V \setminus \gamma_1$. By construction, $\delta_0(\mathbf{G})$ depends holomorphically on \mathbf{G} .

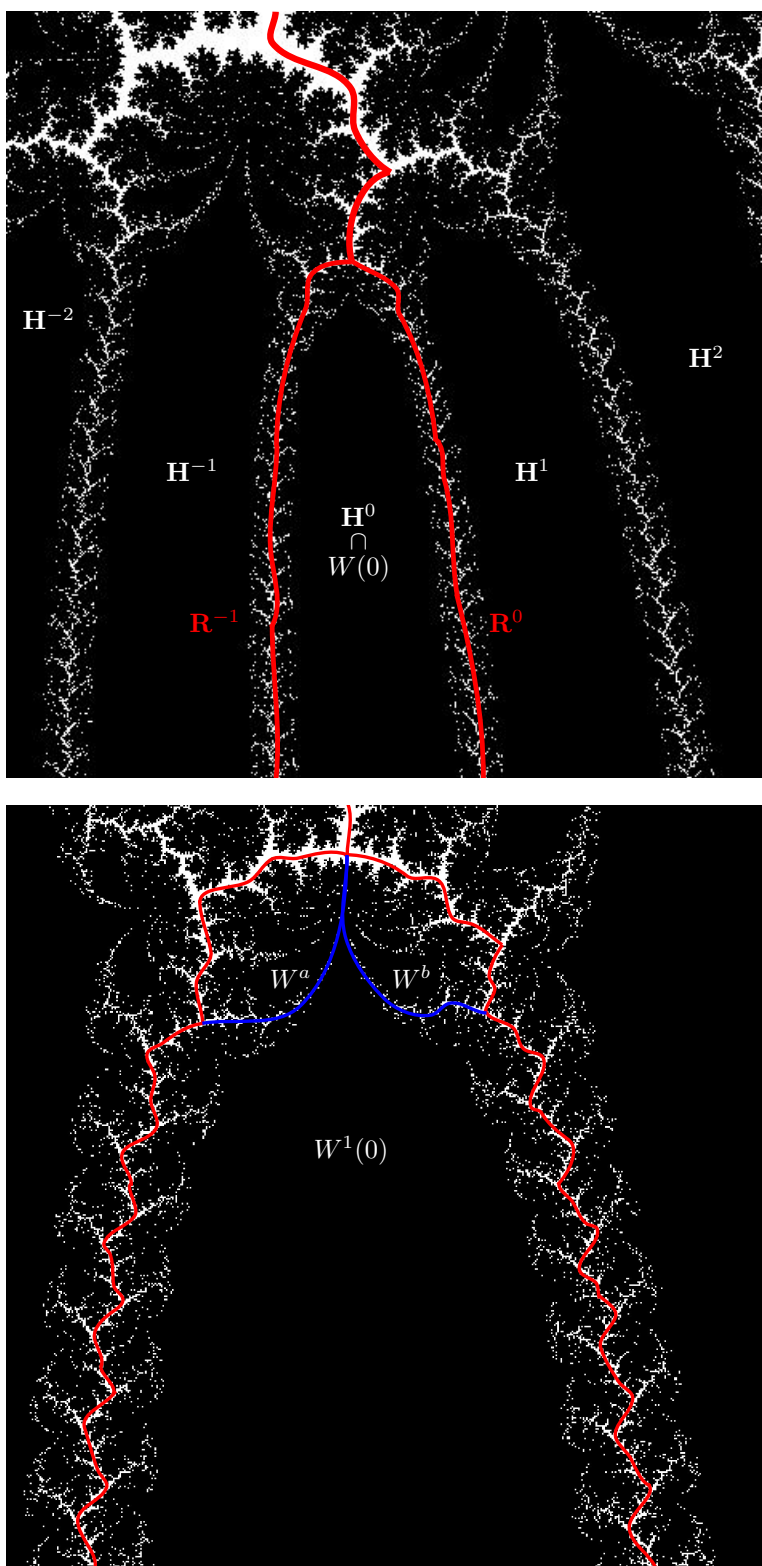

FIGURE 33. Parabolic maximal prepacmen: attracting petals H^i and puzzle pieces $W = W^1 \cup W^a \cup W^b$ (where W^1 is bounded by two red and two blue curves).

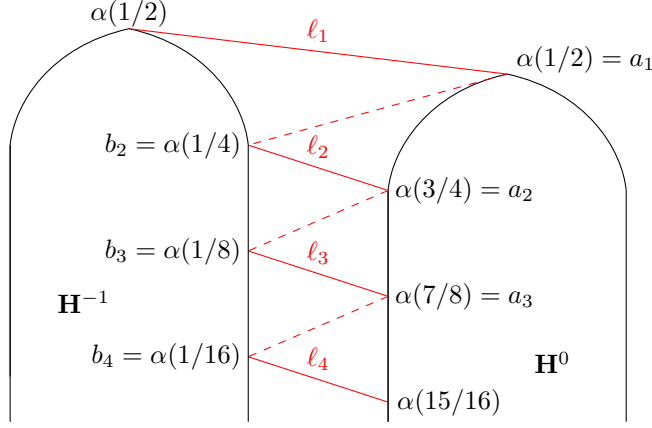

FIGURE 34. Curves ℓ_n and $[b_n, a_{n+1}]$ (dashed), see also Figure 33.

For a small $T \in \mathbb{T}_{>0}$ and $\mathbf{G} \in \mathcal{W}_{\text{loc}}^u$, the set of critical values $\text{CV}(\mathbf{G}^T)$ is disjoint from $\delta(\mathbf{G})$ because

$$\text{CV}(\mathbf{G}^T) \setminus \{0\} \subset \Delta_0(\mathbf{G}) \setminus \mathbf{S} \quad \text{and} \quad \delta(\mathbf{G}) \subset \mathbf{S},$$

see (4.10). Therefore, $\mathbf{G}^{-T}(\delta)$ moves holomorphically with $\mathbf{G} \in \mathcal{W}_{\text{loc}}^u$. Applying the λ -lemma, we obtain the holomorphic motion of $\overline{\mathbf{G}^{-T}(\delta)}$ with $\mathbf{G} \in \mathcal{W}_{\text{loc}}^u$. Since curves in $\overline{\mathbf{F}_\star^{-T}(\delta)}$ land at pairwise different alpha-point (Lemma 5.12), the same is true for $\overline{\mathbf{F}_\tau^{-T}(\delta)}$ in the dynamical plane of \mathbf{F}_τ .

Let \mathbf{H}^i be the unique (by (3.14)) periodic preimage of \mathbf{H}^0 under \mathbf{F}_τ^T . Since T is small, the map $\mathbf{F}_\tau^T: \mathbf{H}^i \rightarrow \mathbf{H}^0$ is two-to-one. There are two lifts δ_0^T and $\delta_{1/2}^T$ of δ under $\mathbf{F}_\tau^T: \mathbf{H}^i \rightarrow \mathbf{H}^0$. One of them lands at $\alpha(\mathbf{F}_\tau)$, while the other $\delta_{1/2}^T$ lands at the alpha-point $\alpha(1/2, \mathbf{H}^i)$ of generation T .

Observe that $\overline{\delta_{1/2}^T} = \delta_{1/2}^T \cup \alpha(1/2, \mathbf{H}^i)$ is contained in \mathbf{X} (see §7.1.1). Therefore, for all $P \in \mathbb{T}$ all the lifts of $\delta_{1/2}^T$ under \mathbf{F}_τ^P land at pairwise different preimages of $\alpha(1/2, \mathbf{H}^i)$. Since $\delta_{k/2^n}$ are lifts of $\delta_{1/2}^T$, the claim follows. \square

For \mathbf{H}^i we define $\alpha(k/2^n, \mathbf{H}^i)$ to be the images of $\alpha(k/2^n, \mathbf{H}^i)$ under the univalent map $\mathbf{F}_\tau^S: \mathbf{H}^0 \rightarrow \mathbf{H}^i$, where $S < Q(\mathfrak{r})$.

Let

$$\ell_n := [\alpha(1/2^n, \mathbf{H}^0), \alpha((2^n - 1)/2^n, \mathbf{H}^{-1})] \subset \mathbf{Esc}_{nQ(\mathfrak{r})}(\mathbf{F}_\tau)$$

be the unique geodesic (in $\mathbf{Esc}(\mathbf{F}_\tau)$) connecting the alpha-points, see Figure 34.

Claim 2: $\mathbf{F}_\tau^{Q(\mathfrak{r})}$ maps ℓ_{n+1} to ℓ_n . The curves ℓ_n converge to $\alpha(\mathbf{F}_\tau)$, and for $n \gg 0$ the curve ℓ_n is contained in a repelling petal between \mathbf{H}^{-1} and \mathbf{H}^0

Proof of the claim. Note that $(-1/4, 1/4) \subset \mathbb{R} \cap \mathbb{P}$ is $p_{1/4}$ -invariant and connects $\alpha(p_{1/4})$ and $\alpha(1/2, p_{1/4})$. Let $\beta'_{+,n}$ be the unique geodesic in $p_{1/4}^{-n+1}((-1/4, 1/4))$ connecting $\alpha((2^n - 1)/2^n, p_{1/4})$ and $\alpha(p_{1/4})$. Set $\beta_{+,n} := \mathbf{h}_0^{-1}(\beta'_{+,n})$. Similarly, let $\beta'_{-,n}$ be the unique geodesic in $p_{1/4}^{-n+1}((-1/4, 1/4))$ connecting $\alpha(1/2^n, p_{1/4})$ and $\alpha(p_{1/4})$; set $\beta_{-,n} := \mathbf{h}_{-1}^{-1}(\beta'_{-,n})$.

Define \mathcal{O}_n to be the open disk bounded by $\beta_{-,n} \cup \ell_n \cup \beta_{+,n}$ and containing a small repelling petal between \mathbf{H}^{-1} and \mathbf{H}^0 . Then $\mathcal{O}_{n+1} \subset \mathcal{O}_n$ and we claim that $\mathbf{F}_\tau^{Q(\tau)}$ maps \mathcal{O}_{n+1} univalently onto \mathcal{O}_n . Indeed, $\mathbf{F}_\tau^{Q(\tau)}$ maps $\beta_{-,n+1}$ and $\beta_{+,n+1}$ to $\beta_{-,n}$ and $\beta_{+,n}$. Since \mathcal{O}_n does not contain any critical values of $\mathbf{F}_\tau^{Q(\tau)}$, the lift of \mathcal{O}_n attached to $\beta_{-,n+1}$ and $\beta_{+,n+1}$ is attached to the unique lift $\tilde{\ell}_{n+1}$ of ℓ_n . Then $\tilde{\ell}_{n+1}$ connects $\alpha(\mathbf{H}^0, 1/2^n)$ and $\alpha(\mathbf{H}^{-1}, (2^n - 1)/2^n)$; since $\mathbf{Esc}_{(n+1)Q(\tau)}$ is uniquely geodesic, we obtain $\tilde{\ell}_{n+1} = \ell_{n+1}$.

Note that between \mathbf{H}_0^{-1} and \mathbf{H}_0^0 there is a repelling petal \mathbf{P}^{-1} emerging from α ; this repelling petal is obtained from lifting the repelling petal of $\alpha(f_\tau)$ between H^{-1} and H^0 . Let $(y_n)_{n \geq 0}$ with $\mathbf{F}_\tau^{Q(\tau)}(y_{n+1}) = y_n \in \mathbf{X} \cap \mathcal{O}_n$ be the orbit emerging from $\alpha(\mathbf{F}_\tau)$ in \mathbf{P}^{-1} . Connect ℓ_{n+1} and y_{n+1} by a curve in $\mathcal{O}_n \cap \mathbf{X}$; then the lift of this curve is a curve connecting ℓ_{n+2} and y_{n+2} . Since $\mathbf{F}_\tau^{Q(\tau)}$ expands the hyperbolic metric of \mathbf{X} (see (7.5)), and since $\ell_n \subset \mathbf{X}$, we obtain that ℓ_n shrinks to $\alpha(\mathbf{F}_\tau)$. \square

Since $\mathbf{Esc}(\mathbf{F}_\tau)$ is uniquely geodesic, there is a unique geodesic $[b_n, a_{n+1}] \subset \mathbf{Esc}(\mathbf{F}_\tau)$ connecting ℓ_n and ℓ_{n+1} . (In fact, $b_n = \alpha(2^n - 1)/2, \mathbf{H}^0$) and $a_n = \alpha(1/2^n, \mathbf{H}^{-1})$, see Figure 34.) Then $\mathbf{F}_\tau^{Q(\tau)}$ maps $[b_{n+1}, b_{n+2}]$ to $[b_n, b_{n+1}]$. Since $\mathbf{F}_\tau^{Q(\tau)}$ is expanding (see (7.5)), $[b_n, b_{n+1}]$ shrinks to $\alpha(\mathbf{F}_\tau)$. We obtain that

$$\mathbf{R}^{-1} := (\infty, b_1] \bigcup_{n \geq 0} [b_n, b_{n+1}]$$

is a periodic ray landing between \mathbf{H}^{-1} and \mathbf{H}^0 .

Similarly, there is a periodic ray \mathbf{R}^i landing at $\alpha(\mathbf{F}_\tau)$ between \mathbf{H}^i and \mathbf{H}^{i+1} . The rays $(\mathbf{R}^i)_i$ form a periodic cycle.

Let $\mathbf{W}(i) \supset \mathbf{H}^i$ be the puzzle piece bounded by $\mathbf{R}^i \cup \mathbf{R}^{i+1}$. Recall (3.14) that for every \mathbf{H}^i there is a unique $P \in \mathbb{T}$ such that $\mathbf{F}_\tau^P: \mathbf{H}^0 \rightarrow \mathbf{H}^i$ is a conformal map.

Claim 3: the conformal map $\mathbf{F}_\tau^P: \mathbf{H}^0 \rightarrow \mathbf{H}^i$ extends to a conformal map $\mathbf{F}_\tau^P: \mathbf{W}(0) \rightarrow \mathbf{W}(i)$. Moreover, \mathbf{R}^{-1} and \mathbf{R}^0 meet at $\alpha(\mathbf{H}^0, 1/2)$.

Proof of the Claim. The critical values of \mathbf{F}_τ^P are exactly

$$\{\mathbf{F}_\tau^Q(0) \mid Q < P\} \subset \bigcup_{Q < P} \mathbf{F}_\tau^Q(\mathbf{H}^0)$$

and this set is disjoint from $\mathbf{W}(i)$. Therefore, $\mathbf{W}(0)$ is the conformal pullback of $\mathbf{W}(i)$ along $\mathbf{F}_\tau^P: \mathbf{H}^0 \rightarrow \mathbf{H}^i$. This shows the first claim

For every $S < Q(\tau)$ there is an $i \in \mathbb{Z}$ such that $\mathbf{F}_\tau^S: \mathbf{W}(0) \rightarrow \mathbf{W}(i)$ is conformal. Therefore, $\alpha(\mathbf{H}^i) = \mathbf{F}_\tau^S(\alpha(\mathbf{H}^0, 1/2))$ and we see that the generation of $\alpha(\mathbf{H}^0, 1/2)$ is exactly $Q(\tau)$. This also implies that $\alpha(\mathbf{H}^0, 1/2)$ has the smallest generation among all the preimages of $\alpha(\mathbf{F}_\tau)$ in $\mathbf{W}(0)$. If α_- and α_+ are alpha-points in $\mathbf{R}^{-1} \setminus \mathbf{R}^0$ and $\mathbf{R}^0 \setminus \mathbf{R}^{-1}$ respectively, then α_- and α_+ are \prec -separated by $\alpha(\mathbf{H}^0, 1/2)$ (see §5.7). By Corollary 5.27, $\mathbf{R}^0 \cap \mathbf{R}^{-1} = [\alpha(\mathbf{H}^0, 1/2), \infty)$. \square

Since $\mathbf{W}(0)$ contains a unique critical value of $\mathbf{F}_\tau^{Q(\tau)}$, pulling back $\mathbf{W}(0)$ we obtain the two-to-one map (7.4).

By a standard puzzle argument, $\partial\mathbf{H}^i$ is a simple arc. Indeed, every alpha-point $\alpha(t, \mathbf{H}^i)$ is accessible from the interior and the exterior of \mathbf{H}^i . We can cover $\partial\mathbf{H}^i$ by closed topological disks $(D_j)_{j \in \mathbb{Z}}$ with disjoint interiors whose boundaries intersect $\partial\mathbf{H}^i$ at exactly two alpha-points: for $j < 0$ the disk D_j intersects $\partial\mathbf{H}^0$ at $\alpha(2^j)$ and $\alpha(2^{j-1})$, and for $j \geq 0$ the disk D_j intersects $\partial\mathbf{H}^0$ at $\alpha(1 - 1/2^{j+1})$ and

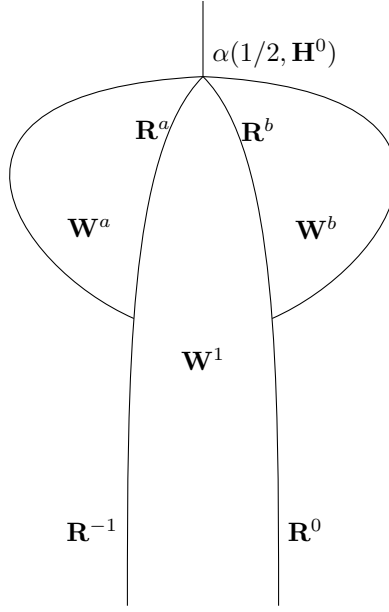

FIGURE 35. The decomposition of $\mathbf{W} = \mathbf{W}^1 \cup \mathbf{W}^a \cup \mathbf{W}^b$. The rays \mathbf{R}^a and \mathbf{R}^b land at $\alpha(1/2, \mathbf{H}^0)$ and bound puzzle pieces \mathbf{W}^a and \mathbf{W}^b . Compare with Figure 33.

$\alpha(1 - 1/2^{j+2})$. Moreover, we can assume that D_j is disjoint from the postcritical set. Taking preimages, we obtain a systems of disks $(D_\eta)_\eta$; every D_η still intersects $\partial\mathbf{H}^0$ at exactly two alpha-points. By expansion §7.1.1, for every $x \in \partial\mathbf{H}^i$ there is a sequence of disks $D_{i,x} \ni x$ as above shrinking to x . This implies that $\partial\mathbf{H}^0$ is a simple arc, [Na, Theorems 6.16 and 6.17].

Note that $\overline{\mathbf{H}}^0$ is the non-escaping set of $\mathbf{F}_\tau^{Q(\nu)}: \mathbf{W}^1 \rightarrow \mathbf{W}$. Therefore, the escaping set intersects $\partial\mathbf{H}^i$ at alpha-points. This implies that $\mathbf{H}^i \cap \mathbf{R}^k \cap \mathbf{H}^j = \emptyset$ for all $i \neq j$ and all k because the generation of alpha-point in $\partial\mathbf{H}^i$ is different from those in $\partial\mathbf{H}^j$. Since \mathbf{H}^i and \mathbf{H}^j are in different puzzle pieces, $\mathbf{H}^i \cap \mathbf{H}^j = \emptyset$ if $i \neq j$. \square

We will show in Lemma 8.8 that every $z \in \mathbb{C}$ is contained in some puzzle piece $\mathbf{W}(i)$.

7.2. Properties of $\mathbf{W}(i)$.

Lemma 7.3 (Decomposition $\mathbf{W} = \mathbf{W}^1 \cup \mathbf{W}^a \cup \mathbf{W}^b$). *The puzzle piece \mathbf{W}^1 is bounded by 4 external rays; two of them are \mathbf{R}^{-1} and \mathbf{R}^0 , we denote the other two by \mathbf{R}^a and \mathbf{R}^b , see Figure 35. The ray \mathbf{R}^a lands at $\alpha(1/2, \mathbf{H}^0) \in \mathbf{R}^a$ and surrounds a puzzle piece \mathbf{W}^a . Similarly, \mathbf{R}^b lands at $\alpha(1/2, \mathbf{H}^0) \in \mathbf{R}^b$ and surrounds a puzzle piece \mathbf{W}^b . The puzzle pieces $\mathbf{W}^1, \mathbf{W}^a, \mathbf{W}^b$ have pairwise disjoint interiors, and we have $\mathbf{W} = \mathbf{W}^1 \cup \mathbf{W}^a \cup \mathbf{W}^b$. The map $\mathbf{F}_\tau^{Q(\nu)}$ maps univalently $\text{int } \mathbf{W}^a$ and $\text{int } \mathbf{W}^b$ to two different connected components of $\mathbb{C} \setminus (\mathbf{W} \cup \mathbf{R}^0)$.*

Proof. Since $\mathbf{F}_\tau^{Q(\nu)}: \mathbf{W}^1 \rightarrow \mathbf{W}$ is two-to-one, the puzzle piece \mathbf{W}^1 is bounded by 4 rays $\mathbf{R}^{-1}, \mathbf{R}^a, \mathbf{R}^b, \mathbf{R}^0$, where $\mathbf{R}^{-1}, \mathbf{R}^b$ are preimages of \mathbf{R}^{-1} while $\mathbf{R}^a, \mathbf{R}^0$ are

preimages of \mathbf{R}^0 . Since $\mathbf{R}^{-1}, \mathbf{R}^0$ land at α , we obtain that \mathbf{R}^a and \mathbf{R}^b land at $\alpha(1/2, \mathbf{H}^0)$. As a consequence, \mathbf{R}^a and \mathbf{R}^b bound puzzle pieces \mathbf{W}^a and \mathbf{W}^b .

Observe that \mathbf{R}^{-1} and \mathbf{R}^a meet at $\alpha(1/4, \mathbf{H}^0)$ while \mathbf{R}^0 and \mathbf{R}^b meet at $\alpha(3/4, \mathbf{H}^0)$. This implies that $\mathbf{W} = \mathbf{W}^1 \cup \mathbf{W}^a \cup \mathbf{W}^b$ and $\mathbf{F}_\tau^{Q(\tau)}$ maps $\text{int } \mathbf{W}^a \cup \text{int } \mathbf{W}^b$ to $\mathbb{C} \setminus (\mathbf{W} \cup \mathbf{R}^0)$ as required. \square

Fix an open neighborhood $\mathcal{O} := \mathbb{D}(\eta)$ of \mathbf{F}_\star containing \mathbf{F}_τ . Recall from §5.2 that $c_S(\mathbf{F}_\star) \in \mathbf{F}_\star^{-S}(0)$ denotes the unique critical point in $\partial \mathbf{Z}_\star$ of generation S . By Lemma 4.4, $\mathbf{G}^P(0)$ does not collide with 0 for small P and for $\mathbf{G} \in \mathcal{O}$. Therefore, for small P the set $\bigcup_{S \leq P} \mathbf{G}^{-S}(0)$ moves holomorphically with $\mathbf{G} \in \mathcal{O}$. For $\mathbf{G} \in \mathcal{O}$, we denote by $c_S(\mathbf{G})$ the image of $c_S(\mathbf{F}_\star)$ under the holomorphic motion.

For every $S < Q(\tau)$, there is a unique $i = i(S)$ such that $\mathbf{F}_\tau^{Q(\tau)-S}$ maps univalently \mathbf{W} onto $\mathbf{W}(i)$. We set $\mathbf{W}^1(i) := \mathbf{F}_\tau^{Q(\tau)-S}(\mathbf{W}^1)$. Then

$$(7.6) \quad \mathbf{F}_\tau^S : \mathbf{W}^1(i(S)) \rightarrow \mathbf{W}$$

is a two-to-one map.

Lemma 7.4. *For a small $S > 0$, the point $c_S(\mathbf{F}_\tau)$ is the unique critical point of (7.6).*

Proof. The proof will be similar to the argument in Claim 1 of the proof of Theorem 7.2. Applying \mathcal{R} , we can assume that \mathbf{F}_τ is in a small neighborhood \mathcal{O} of \mathbf{F}_\star . For $\mathbf{G} \in \mathcal{O}$, denote by L_g the unique affine map mapping $\alpha(f_\star)$ and $c_1(f_\star)$ to $\alpha(g)$ and $c_1(g)$ respectively.

Let $J(f_\star) : (0, 1) \rightarrow \mathbf{Z}_\star$ be a simple arc connecting the critical value $c_1(f_\star)$ and α (i.e. J lands at c_1 and α) such that

- (1) $L_{f_\tau}(J(f_\star))$ intersected with a small neighborhood of $\alpha(f_\tau)$ is within H_0^0 ; and
- (2) $J(f_\star) \subset V \setminus \gamma_1$, possibly up to a slight rotation of γ_1 .

Let $\mathbf{J}_0(\mathbf{F}_\star)$ be the lift of $J(f_\star)$ via $\mathbf{S} \simeq V \setminus \gamma_1$. Then $\mathbf{J}_0(\mathbf{F}_\star)$ is an arc connecting from 0 and α such that $\mathbf{J}_0 \subset \mathbf{Z}_\star$. For g close to f_\star , we set $J(g) := L_g(J(f_\star))$. And we define $\mathbf{J}_0(\mathbf{G})$ to be the lift of $J(g)$ via $\mathbf{S} \simeq V \setminus \gamma_1$. We obtain a holomorphic motion of $\mathbf{J}_0(\mathbf{G})$ in \mathcal{O} . By (4.10), $\mathbf{J}_0(\mathbf{G})$ does not collide with $\text{CV}(\mathbf{G}^S)$ for a small S . Therefore, we also have a holomorphic motion of

$$\tilde{\mathbf{J}}(\mathbf{G}) := \bigcup_{S \leq P} \mathbf{G}^{-S}(\mathbf{J}_0(\mathbf{G})).$$

By Lemma 5.12, there is a unique lift $\mathbf{J}_S(\mathbf{F}_\star) \subset \tilde{\mathbf{J}}$ of $\mathbf{J}_0(\mathbf{F}_\star)$ under \mathbf{F}_\star^S such that \mathbf{J}_S ends at α , where S is small. Moreover, $\mathbf{J}_S(\mathbf{F}_\star) \subset \mathbf{Z}_\star$ and $\mathbf{J}_S(\mathbf{F}_\star)$ starts at c_S . Let $\mathbf{J}_S(\mathbf{F}_\tau)$ be the image of $\mathbf{J}_S(\mathbf{F}_\star)$ under the holomorphic motion. We need to show that $\mathbf{J}_S(\mathbf{F}_\tau)$ starts at the unique critical point of (7.6). This follows from the following claim (using the homotopy lifting property).

Claim. Let N be a small neighborhood of $\alpha \cup \{0\}$. For a small $S > 0$ the arc $\mathbf{J}_0(\mathbf{F}_\tau)$ is homotopic rel $N \cup \text{CV}(\mathbf{F}_\tau^S)$ to a curve within \mathbf{W} .

Proof of the Claim. It follows from Condition (1) that $\mathbf{J}_S(\mathbf{F}_\tau) \cap N \subset \mathbf{W}$ for a small neighborhood N of $\alpha \cup \{0\}$. Let \mathbf{J}'_S be a simple arc in \mathbf{W} such that $\mathbf{J}'_S \cap N = \mathbf{J}_S \cap N$. For a small S , the set $\text{CV}(\mathbf{F}_\tau^S) \setminus \{0\}$ is far from 0, thus \mathbf{J}_S is homotopic to \mathbf{J}'_S as required. \square

This completes the proof of Theorem 7.2. \square

7.3. Secondary parabolic prepacman $\mathbf{F}_{\tau, \mathfrak{s}}$. Since f_τ has q attracting petals at α , there is a small neighborhood \mathcal{U} of f_τ such that $\alpha(f_\tau)$ splits into the fixed point $\alpha(g)$ and a q -periodic cycle $\gamma(g)$ for $g \in \mathcal{U} \setminus \{f_\tau\}$. Moreover, we can assume that the multiplier of $\gamma(g)$ parametrizes \mathcal{U} , possibly by shrinking \mathcal{U} . We also denote by

$$\mathcal{U} := \{\mathbf{G} \mid g \in \mathcal{U}\} \subset \mathcal{W}^u$$

the corresponding neighborhood of \mathbf{F}_τ .

For $\mathbf{G} \in \mathcal{U}$ we denote by $\gamma(\mathbf{G})$ the full lift of $\gamma(g)$ to the dynamical plane of \mathbf{G} . More precisely, choose a point $\gamma_0(g)$ in $\gamma(g)$ and let $\gamma_0(\mathbf{G})$ be the lift of $\gamma_0(g)$ to $\mathbf{S} \simeq V \setminus \gamma_1$. Then $\gamma(\mathbf{G})$ is the full orbit of γ_0 . Every point in $\gamma(\mathbf{G})$ is $Q(\tau)$ -periodic.

Let us consider a path $g_t \in \mathcal{U}$ with $t \geq 0$ emerging from $f_\tau = g_0$ such that $\gamma(g_t)$ is attracting and $\alpha(g_t)$ is on the boundary of the immediate attracting basin of $\gamma(g_t)$ for $t > 0$. All \mathbf{G}_t with $t > 0$ are conjugate by qc maps that are conformal on the Julia sets. We denote by Δ_τ the set of $\mathbf{G} \in \mathcal{W}^u$ obtained by a qc deformation of \mathbf{G}_t changing the multiplier of γ , see §4.10. We say that Δ_τ is the *primary satellite hyperbolic component attached to \mathbf{F}_τ* .

The external rays \mathbf{R}^i (see Theorem 7.2) still land at α for all \mathbf{G}_t . Therefore, the first renormalization map (7.4) exists for all \mathbf{G}_t as well as for all $\mathbf{G} \in \Delta_\tau$.

By appropriately shrinking \mathcal{U} (and respectively \mathcal{U}) we can assume that the set of pacmen $g \in \mathcal{U}$ with non-repelling $\gamma(g)$ is connected. In particular, every $g \in \mathcal{U}$ with attracting $\gamma(g)$ is contained in Δ_τ .

Consider a rational number $\mathfrak{s} = p_s/q_s > 0$. If \mathfrak{s} is close to 0, then there is a unique parabolic prepacman $\mathbf{F}_{\tau, \mathfrak{s}} \in \mathcal{U} \cap \partial\Delta_\tau$ such that the multiplier of $\gamma(f_{\tau, \mathfrak{s}})$ is $e(\mathfrak{s})$.

Consider a point γ_0 in the periodic cycle $\gamma(\mathbf{F}_{\tau, \mathfrak{s}})$. An *attracting flower* at γ_0 is an open set Υ_0 such that

- $\Upsilon_0 \cup \{\gamma_0\}$ is connected;
- $\mathbf{F}_{\tau, \mathfrak{s}}^{Q(\tau)}(\Upsilon_0) \subset \Upsilon_0$; and
- all points in Υ_0 are attracted by γ_0 under the iterations of $\mathbf{F}_{\tau, \mathfrak{s}}^{Q(\tau)}$.

A connected component of Υ_0 is called a *petal*. Petals are permuted by $\mathbf{F}_{\tau, \mathfrak{s}}^{Q(\tau)}$ and every petal is $Q(\tau, \mathfrak{s}) := q_s Q(\tau)$ periodic. The flower Υ_0 contains $m q_s$ petals; we will show in Lemma 7.5 that $m = 1$.

We denote by \mathbf{H} the full orbit of Υ_0 . Clearly, every connected component of \mathbf{H} is a Fatou component, see Figure 36.

Lemma 7.5. *The set \mathbf{H} has a periodic component \mathbf{H}^0 containing 0. Moreover, \mathbf{H} has a unique cycle of periodic components.*

By re-enumerating points in γ , we assume that \mathbf{H}^0 is attached to $\gamma_0 \in \gamma$. There are q_s components $\mathbf{H}^0, \mathbf{H}^1, \dots, \mathbf{H}^{q_s-1}$ of \mathbf{H} such that \mathbf{H}^i are attached to γ_0 counting counterclockwise. The components \mathbf{H}^i are cyclically p_s/q_s -permuted under $\mathbf{F}_{\tau, \mathfrak{s}}^{Q(\tau)}$.

Proof. Follows from a classical argument. Let \mathbf{H}' be a periodic component of \mathbf{H} . If the forward orbit of \mathbf{H}' does not contain 0, then the local Fatou coordinates of \mathbf{H}' can be extended to a conformal map between \mathbf{H}' and \mathbb{C} . This contradicts to $\mathbf{H}' \subsetneq \mathbb{C}$.

As a consequence, \mathbf{H} has a unique cycle of periodic components. The second statement follows from the fact that $e(\mathfrak{s})$ is the multiplier of γ . \square

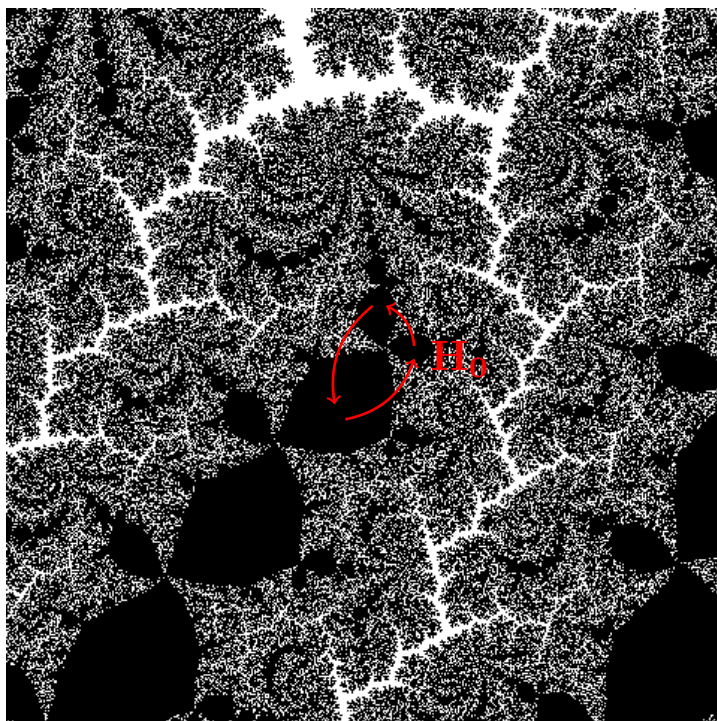
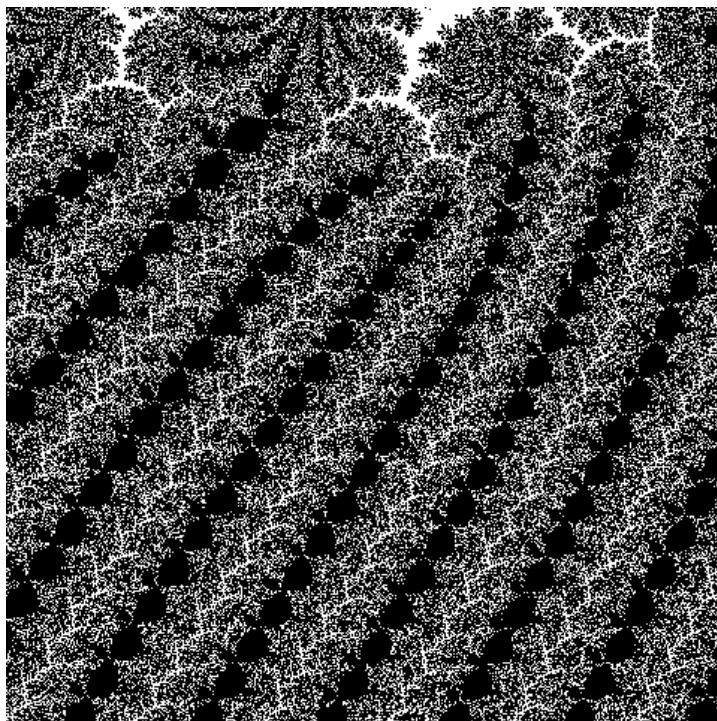

FIGURE 36. The Rabbit maximal prepacman. There are three Fatou components attached to γ_0 . These components are cyclically permuted under the first return map. Note that there is a “spiraling” at the $\alpha = “-\infty i”$ -fixed point.

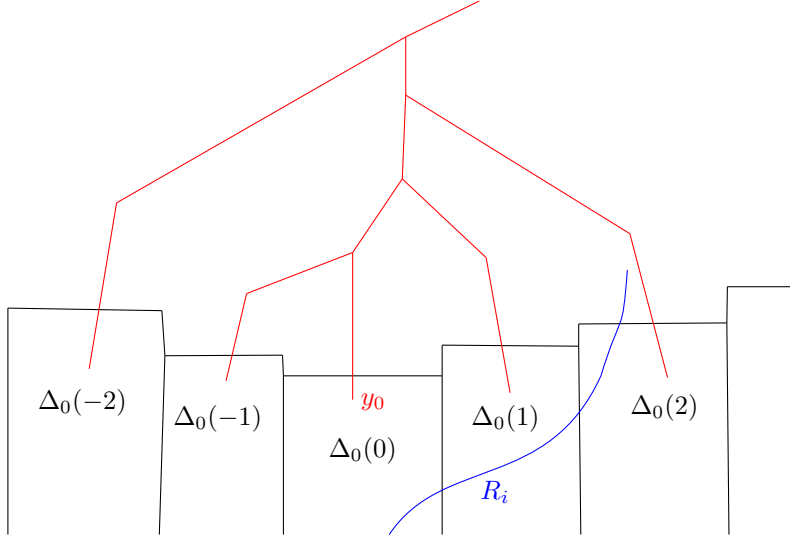

FIGURE 37. Illustration to the proof of Theorem 7.6. The cycle of periodic rays R_y (red) lands at a repelling periodic cycle y that is within the triangulation Δ_0 . The ray segment R_i (blue) does not intersect R_y . Either the hyperbolic diameter of R_i decreases, or R_i shrinks to the cycle y , or R_i tends to α .

7.4. Landing of dynamic rays.

Theorem 7.6. *Suppose $\mathbf{G} \in \mathcal{W}^u$ has a parabolic or attracting periodic point $x_0 \in \mathbb{C}$ and suppose that $\alpha(g)$ is repelling. Then every rational ray of \mathbf{G} lands.*

Proof. Consider a rational ray \mathbf{R} . Let us first give a sketch of the argument. If \mathbf{R} does not go to infinity, then \mathbf{R} lands by the expansion of \mathbf{G} . The infinity in $\mathbb{C} \setminus \Delta_0$ is blocked by another periodic ray cycle (the red cycle in Figure 37) that exists in a neighborhood of \mathbf{F}_* . Since $(\mathbf{g}_-, \mathbf{g}_+) \mid \Delta_0$ is a pair of almost translations, if \mathbf{R} goes to infinity in Δ_0 , then \mathbf{R} tends to α ; in this case \mathbf{R} lands at α .

We assume that x_0 is parabolic; the case when x_0 is attracting is similar. Denote by \varkappa the periodic cycle of x_0 . Let \mathbf{H} be the attracting basin of \varkappa . Since the Fatou coordinates in \mathbf{H} capture critical points of $\mathbf{G}^{\geq 0}$, there is a unique periodic component \mathbf{H}^0 of \mathbf{H} containing 0. By re-enumerating points in \varkappa , we can assume that \mathbf{H}^0 is attached to x_0 .

By Lemma 7.1, the first return map $\mathbf{G}: \mathbf{H}^0 \rightarrow \mathbf{H}^0$ is conformally conjugate to $p_{1/4}: \mathbb{P} \rightarrow \mathbb{P}$, say via $\mathbf{h}_0: \mathbf{H}^0 \rightarrow \mathbb{P}$, where $p_{1/4}(z) = z^2 + 1/4$ and \mathbb{P} is the attracting basin of $\alpha(p_{1/4})$. As in §7.1.1, let $B \subset \mathbb{P}$ be a forward invariant open topological disk containing $[1/4, 1/2)$ such that \bar{B} is a closed topological disk with

$$\partial B \cap p_c(\bar{B}) = \alpha(p_{1/4}) = \bar{B} \cap \partial \mathbb{P}.$$

Set $\mathbb{B}^0 := \mathbf{h}_0^{-1}(B)$; spreading around $\bar{\mathbb{B}}^0$, we obtain

$$\mathbb{B} := \bigcup_{P \geq 0} \mathbf{G}^P(\bar{\mathbb{B}}^0) \subset \mathbf{H} \cup \varkappa.$$

Consider the hyperbolic surface $\mathbf{X} := \mathbb{C} \setminus \mathbb{B}$. Since \mathbb{B} contains the postcritical set $\mathfrak{P}(\mathbf{G})$, we have $\mathbf{G}^{-T}(\mathbf{X}) \subsetneq \mathbf{X}$ and

$$\mathbf{G}^T : \mathbf{G}^{-T}(\mathbf{X}) \rightarrow \mathbf{X}$$

expands the hyperbolic metric of \mathbf{X} for all $T \in \mathbb{T}_{>0}$.

Let us assume that the rational ray \mathbf{R} is periodic with period $N \in \mathbb{T}$; the preperiodic case follows from the periodic case. Let us decompose \mathbf{R} as a concatenation of ray segments

$$\cdots \cup \mathbf{R}_2 \cup \mathbf{R}_1 \cup \mathbf{R}_0$$

such that \mathbf{G}^N maps \mathbf{R}_{i+1} to \mathbf{R}_i .

Consider a renormalization triangulation $\Delta_0(\mathbf{F}_\star)$ and choose a periodic repelling point $y_0 \in \Delta_0(0, 1)$ such that y_0 does not escape $\Delta_0(0, 1)$ under

$$\mathbf{F}_\star^{A_0} : \Delta_0(0) \rightarrow \mathbf{S}, \quad \mathbf{F}_\star^{B_0} : \Delta_0(1) \rightarrow \mathbf{S}.$$

(To existence of y_0 follows from the existence of a periodic point y'_0 in the dynamical plane of f_\star , see §3.2.5; then y_0 is the lift of y'_0 .) Let $\mathfrak{y}(\mathbf{F}_\star) := \bigcup_{P \geq 0} \mathbf{F}_\star^P \{y_0\}$ be the

periodic cycle of y_0 . By Corollary 5.35, there is a cycle of periodic rays $\mathbf{R}_\mathfrak{y}$ landing at $\mathfrak{y}(\mathbf{F}_\star)$, see Figure 37.

Since the landing of a periodic ray at a repelling periodic point is stable, there is a neighborhood \mathcal{Y} of \mathbf{F}_\star such that

- $\bar{\mathbf{R}}_\mathfrak{y}(\mathbf{G})$ exists and depends continuously on $\mathbf{G} \in \mathcal{Y}$; and
- $\mathfrak{y} \in \Delta_0(\mathbf{G})$ for all $\mathbf{G} \in \mathcal{Y}$.

By replacing \mathbf{G} with its antirenormalization, we can assume that $\mathbf{G} \in \mathcal{Y}$.

Choose a sufficiently big $n \gg 0$ such that \mathbf{R}_n is disjoint from $\mathbf{R}_\mathfrak{y}$. (If \mathbf{R}_n intersects $\mathbf{R}_\mathfrak{y}$ for all n , then $\mathbf{R} \subset \mathbf{R}_\mathfrak{y}$ and the claim is trivial.) Let \mathbf{R}'_n be a rectifiable curve in $\mathbf{X} \setminus \mathbf{R}_\mathfrak{y}$ connecting the endpoints of \mathbf{R}_n such that \mathbf{R}'_n is homotopic (in $\mathbf{X} \setminus \mathbf{R}_\mathfrak{y}$) to \mathbf{R}_n rel the endpoints. For $j \geq 0$ we define \mathbf{R}'_{n+j} to be the lift of \mathbf{R}'_n under \mathbf{G}^{jN} such that \mathbf{R}'_{n+j} connects the endpoints of \mathbf{R}_{n+j} . Clearly, $|\mathbf{R}'_i| \leq |\mathbf{R}'_{i-1}|$, where “ $|\cdot|$ ” denotes the hyperbolic length in \mathbf{X} .

Claim 1. *There is a neighborhood \mathcal{O} of α with the following property. If $\mathbf{R}'_n \subset \mathcal{O}$ for some n , then \mathbf{R} lands at α .*

Proof. Recall from §4.7 that $\mathbb{C} \sqcup \{\alpha\}$ is endowed with the wall topology, where a neighborhood \mathcal{O} of $\alpha(\mathbf{G})$ is the full lift of a neighborhood O of $\alpha(f)$. Since $\alpha(f)$ is repelling, we can choose a small open disk O around $\alpha(f)$ such that

- ∂O intersects the curves $\gamma_0 \cup \gamma_1$ at two points; and
- $O_2 := f(O) \ni O$ and O_2 also intersects $\gamma_0 \cup \gamma_1$ at two points,

see Figure 38. The pair $\gamma_0 \cup \gamma_1$ cuts O into two sectors. Lifting these sectors to the dynamical plane of \mathbf{G} and spreading the lifts around, we obtain a neighborhood \mathcal{O} of $\alpha(\mathbf{G})$ such that \mathcal{O} is backward invariant. If $\mathbf{R}'_n \subset \mathcal{O}$, then $\mathbf{R}'_{n+i} \subset \mathcal{O}$ for all i , and, moreover, \mathbf{R}'_m tends to α as $m \rightarrow +\infty$. \square

Claim 2. *Let \mathbf{M} be a sufficiently small neighborhood of $\mathfrak{x} \cup \{\alpha\}$. Then there is an $\varepsilon > 0$ such that the following holds. If \mathbf{R}'_i intersects $\Delta_0 \setminus \mathbf{M}$, then*

$$|\mathbf{R}'_i| \leq \max \left\{ |\mathbf{R}'_{i-1}| - \varepsilon, \frac{|\mathbf{R}'_{i-1}|}{1 + \varepsilon} \right\}.$$

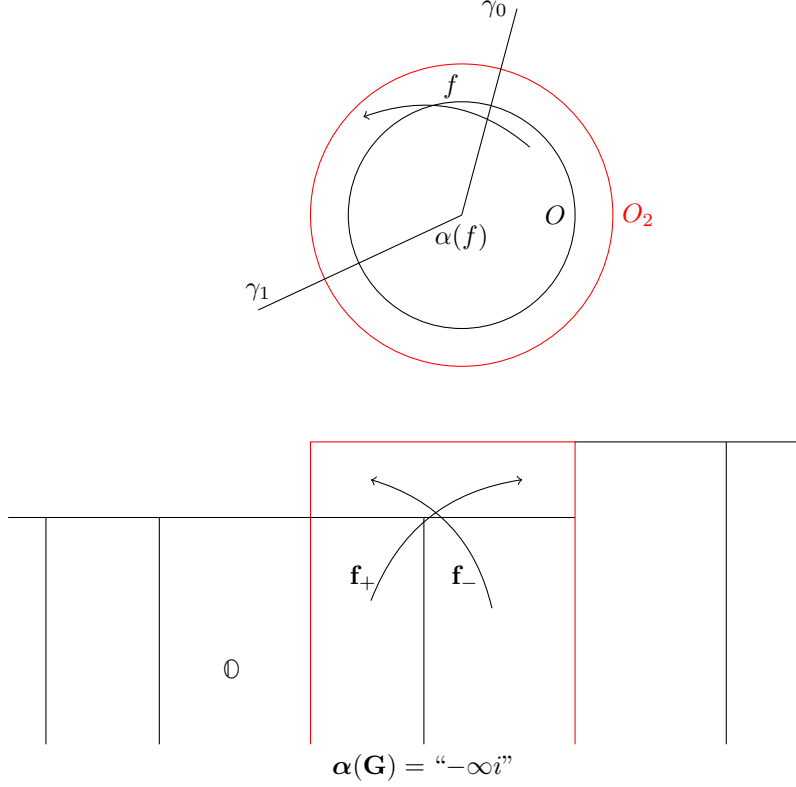

FIGURE 38. Top: a neighborhood O of $\alpha(f)$ and its image $O_2 := f(O)$. Bottom: the neighborhood \mathbb{O} of $\alpha(f)$ is obtained by lifting and spreading around $O(f)$. Note that the points in \mathbb{O} stay in \mathbb{O} under the backward iteration of the cascade $\mathbf{G}^{\geq 0}$.

Proof. By increasing N , we can assume that $N \geq 2 \max\{A_0, B_0\}$. Choose a point $z \in (\Delta_0 \setminus \mathbf{M}) \cap \mathbf{R}'_i$. Let $A \leq \max\{A_0, B_0\}$ be the first moment such that $\mathbf{G}^A(z) \in \mathbf{S}$. If $\mathbf{G}^A(z) \in \Delta_0(0, 1)$, then either

$$f_+ : \Delta_0(0) \rightarrow \mathbf{S} \quad \text{or} \quad f_- : \Delta_0(1) \rightarrow \mathbf{S}$$

expands the hyperbolic length of $\mathbf{G}^A(\mathbf{R}'_i)$.

If $\mathbf{G}^A(z) \in \mathbf{S} \setminus \Delta_0(0, 1)$, then $\mathbf{S} \setminus \Delta_0(0, 1) \subset \Delta_{-1}(0, 1)$ (see (4.9)), and either

$$f_{-1,+}^\# : \Delta_{-1}(0) \rightarrow \mathbf{S}_{-1}^\# \quad \text{or} \quad f_{-1,-}^\# : \Delta_{-1}(1) \rightarrow \mathbf{S}_{-1}^\#$$

expands the hyperbolic length of $\mathbf{G}^A(\mathbf{R}'_i)$. □

As a consequence of Claim 2, either the diameters of the \mathbf{R}'_i shrink, or the \mathbf{R}'_i are eventually in $\mathbb{C} \setminus (\Delta_0 \setminus \mathbf{M})$. Suppose $\mathbf{R}'_i \subset \mathbb{C} \setminus (\Delta_0 \setminus \mathbf{M})$ for all $i \geq n$. If \mathbf{R}'_n is in a small neighborhood of α , then \mathbf{R} lands at α by Claim 1. If \mathbf{R}'_n is in a small neighborhood of z , then \mathbf{R} lands at z . The remaining case is when all \mathbf{R}'_i are in some connected component of $\mathbb{C} \setminus (\Delta_0 \cup \mathbf{R}_\gamma)$ for all $i \gg 0$. Every connected component of $\mathbb{C} \setminus (\Delta_0 \cup \mathbf{R}_\gamma)$ is bounded; by hyperbolic contraction, the hyperbolic diameters of the \mathbf{R}'_i tend to 0. □

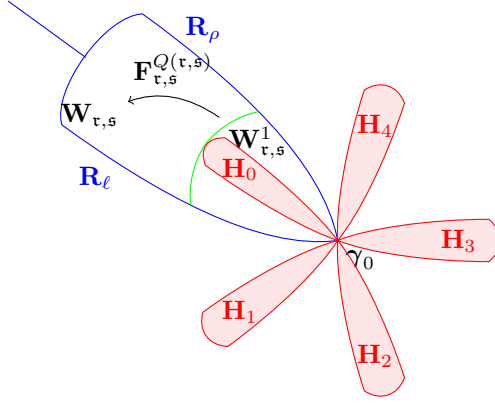

FIGURE 39. The secondary renormalization map $\mathbf{F}_{\tau, s}^{Q(\tau, s)}: \mathbf{W}_{\tau, s}^1 \rightarrow \mathbf{W}_{\tau, s}$ in the dynamical plane of $\mathbf{F} = \mathbf{F}_{\tau, s}$. Petals in the attracting flower (\mathbf{H}_i) around γ_0 are enumerated counterclockwise so that $\mathbf{H}_0 \ni 0$. The puzzle piece $\mathbf{W}_{\tau, s} \supset \mathbf{H}^0$ is bounded by the characteristic ray pair $\mathbf{R}_\ell, \mathbf{R}_\rho$. The puzzle piece $\mathbf{W}_{\tau, s}^1$ is bounded by $\mathbf{R}_\ell, \mathbf{R}_\rho$ and there preimages (marked green). When γ_0 becomes repelling (for example if $\mathbf{F} \in \Delta_{\tau, s}$), the secondary renormalization map can be thickened to a quadratic-like map.

Corollary 7.7. *The primary renormalization map (7.4)*

$$(7.7) \quad \mathbf{G}^{Q(\tau)}: \mathbf{W}^1 \rightarrow \mathbf{W}.$$

exists for all \mathbf{G} close to $\mathbf{F}_{\tau, s}$. In particular, $\mathbf{R}^{-1}(\mathbf{G})$ and $\mathbf{R}^0(\mathbf{G})$ land at α .

Proof. In the dynamical plane of $\mathbf{F}_{\tau, s}$, let us consider the cycle of rays from Theorem 7.2. By Theorem 7.6 the cycle (\mathbf{R}_i) lands at a periodic cycle of points δ . We need to show that $\delta = \alpha$.

Observe that $\delta \neq \gamma$ because the period $Q(\tau, s)$ of repelling petals at γ is greater than the period $Q(\tau)$ of $(\mathbf{R}_i)_{i \in \mathbb{Z}}$. Therefore, δ is repelling. Since the landing at a repelling periodic cycle is stable under a small perturbation, $(\mathbf{R}_i(\mathbf{G}))_{i \in \mathbb{Z}}$ lands at $\delta(\mathbf{G})$ for \mathbf{G} in a small neighborhood of $\mathbf{F}_{\tau, s}$. We obtain that $\delta(\mathbf{G}) = \alpha(\mathbf{G})$ for $\mathbf{G} \in \Delta_\tau$, see §7.3. Therefore, $\delta(\mathbf{G}) = \alpha(\mathbf{G})$ for all \mathbf{G} close to $\mathbf{F}_{\tau, s}$, and (7.4) exists for all \mathbf{G} close to $\mathbf{F}_{\tau, s}$. \square

Recall from Lemma 7.5 that \mathbf{H}^0 denotes the periodic Fatou component of $\mathbf{F}_{\tau, s}$ containing 0, and recall that \mathbf{H}^0 is attached to γ_0 , see Figure 39.

Lemma 7.8. *In the dynamical plane of $\mathbf{F}_{\tau, s}$ there is a characteristic pair $\mathbf{R}_\ell, \mathbf{R}_\rho$ of periodic rays landing at γ_0 : it is the unique ray pair such that $\overline{\mathbf{R}_\ell \cup \mathbf{R}_\rho}$ separates \mathbf{H}^0 from all \mathbf{H}^i with $i \neq 0$.*

Proof. The parabolic point γ_0 has exactly \mathfrak{q}_s local repelling petals, and we need to show that there is a periodic ray landing at every repelling petal of γ_0 . Recall from Corollary 7.7 that the first renormalization map

$$(7.8) \quad \mathbf{F}_{\tau, s}^{Q(\tau)}: \mathbf{W}^1 \rightarrow \mathbf{W}$$

exists.

Denote by \mathfrak{X} the non-escaping set of (7.8), and note that \mathfrak{X} contains γ_0 , \mathbf{H}^0 , and 0. Define inductively \mathbf{W}^{n+1} to be the unique degree two preimage of \mathbf{W}^n under (7.8). By induction (the case $n = 1$ is in Lemma 7.3), $\mathbf{W}^n \setminus \mathbf{W}^{n-1}$ consists of 2^n connected components, $\mathbf{W}^{n+1} \subset \mathbf{W}^n$, and $\bigcap_{n \geq 0} \mathbf{W}^n = \mathfrak{X}$. Note that the

components of $\mathbf{W} \setminus \mathbf{W}^1$ have bounded diameters with respect to the hyperbolic metric of $\mathbb{C} \setminus \overline{\mathfrak{P}}(\mathbf{F}_{\tau, s})$, see Figure 35. Since $\mathbf{F}_{\tau, s}^{Q(\tau)}$ expands the hyperbolic metric of $\mathbb{C} \setminus \overline{\mathfrak{P}}(\mathbf{F}_{\tau, s})$, the spherical diameter of the components of $\mathbf{W}^{n+1} \setminus \mathbf{W}^n$ tends to 0. Therefore, for every local repelling petal P of γ_0 , there is a sequence $\mathbf{T}_k \subset P$, $k \gg 0$ shrinking to γ_0 such that \mathbf{T}_k is a component of $\mathbf{W}^k \setminus \mathbf{W}^{k-1}$ and $\mathbf{F}_{\tau, s}^{Q(\tau, s)}$ maps \mathbf{T}_{k+1} to \mathbf{T}_k . This implies that there is a unique geodesic \mathbf{R} in the escaping set $\mathbf{Esc}(\mathbf{F}_{\tau, s})$ intersecting every \mathbf{T}_k ; thus \mathbf{R} is a periodic ray landing in P and $Q(\tau, s)$ is the minimal period of \mathbf{R} . \square

We denote by $\mathbf{W}_{\tau, s}$ the puzzle piece bounded by $\mathbf{R}_\ell \cup \mathbf{R}_\rho$ and containing \mathbf{H}^0 . Let $\mathbf{W}_{\tau, s}^1 \subset \mathbf{W}_{\tau, s}$ be the two-to-one pullback of $\mathbf{W}_{\tau, s}$ along $\mathbf{F}_{\tau, s}^{Q(\tau, s)}: \mathbf{H}^0 \rightarrow \mathbf{H}^0$. We call

$$(7.9) \quad \mathbf{F}_{\tau, s}^{Q(\tau, s)}: \mathbf{W}_{\tau, s}^1 \rightarrow \mathbf{W}_{\tau, s}$$

a *secondary renormalization map*.

7.5. Secondary parabolic bifurcation. Since $\mathbf{F}_{\tau, s}$ has q_s attracting petals at every point of γ (see §7.3), there is a small neighborhood \mathcal{V} of $\mathbf{F}_{\tau, s}$ such that $\gamma(\mathbf{F}_{\tau, s})$ splits into the $Q(\tau)$ -periodic cycle $\gamma(\mathbf{G})$ and a $Q(\tau, s)$ -periodic cycle $\delta(\mathbf{G})$ for $\mathbf{G} \in \mathcal{V} \setminus \{\mathbf{F}_{\tau, s}\}$. By shrinking \mathcal{V} , we can assume that

- the multiplier of $\delta(\mathbf{G})$ parametrizes \mathcal{V} ;
- the primary renormalization map (7.4) exists for all $\mathbf{G} \in \mathcal{V}$ (by Corollary 7.7).

Moreover, there is a small path \mathbf{G}_t , $t \in [0, 1]$ emerging from $\mathbf{F}_{\tau, s} = \mathbf{G}_0$ such that $\delta(\mathbf{G}_t)$ is attracting and $\gamma(\mathbf{G}_t)$ is on the boundary of the immediate attracting basin of $\delta(\mathbf{G}_t)$ for all $t \in (0, 1]$. Moreover, we can assume that the characteristic ray pair $\mathbf{R}_\ell(\mathbf{G}_t), \mathbf{R}_\rho(\mathbf{G}_t)$ lands at γ_0 for all $t > 0$.

Since the escaping set $\mathbf{Esc}(\mathbf{G})$ moves holomorphically for all \mathbf{G} in a small neighborhood of $\{\mathbf{G}_t \mid t > 0\}$, we obtain that all \mathbf{G}_t with $t > 0$ are qc conjugate. We denote by $\Delta_{\tau, s} \supset \{\mathbf{G}_t \mid t > 0\}$ the set of $\mathbf{G} \in \mathcal{V}$ obtained through a qc deformation changing the multiplier of δ , see §4.10. By appropriately shrinking \mathcal{V} , we can also assume that $\Delta_{\tau, s} \cap \mathcal{V}$ has a single connected component attached to $\mathbf{F}_{\tau, s}$, and:

$$(7.10) \quad \Delta_{\tau, s} \cap \mathcal{V} = \{\mathbf{G} \in \mathcal{V} : \delta(\mathbf{G}) \text{ is attracting}\}.$$

Since the rays \mathbf{R}_ℓ and \mathbf{R}_ρ land at γ_0 for all $\mathbf{G} \in \Delta_{\tau, s}$, the secondary renormalization (7.9)

$$(7.11) \quad \mathbf{G}^{Q(\tau, s)}: \mathbf{W}_{\tau, s}^1 \rightarrow \mathbf{W}_{\tau, s}$$

exists for $\mathbf{G} \in \Delta_{\tau, s}$.

7.6. A ternary small copy \mathcal{M}_0 . Choose a rational number $f = p_f/q_f$ close to 0 and let $\mathbf{F}_{\tau, s, f} \in \partial\Delta_{\tau, s}$ be a parabolic prepacman such that the multiplier of $\delta(\mathbf{F}_{\tau, s, f})$ is $e(p_f/q_f)$. By Theorem 7.6, rational rays land in the dynamical plane of $\mathbf{F}_{\tau, s, f}$. The same argument as in Corollary 7.7 shows that the secondary renormalization (7.11) exists in a small neighborhood \mathcal{W} of $\mathbf{F}_{\tau, s, f}$.

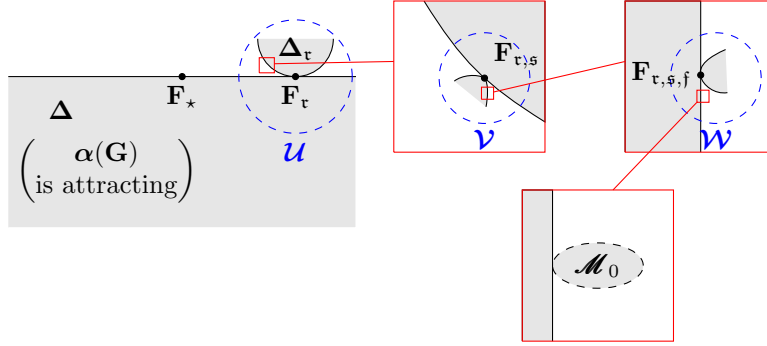

FIGURE 40. Recognizing a small copy on the unstable manifold. A parabolic prepacman \mathbf{F}_τ has a small neighborhood \mathcal{U} parametrized by the multiplier of γ . A secondary parabolic prepacman $\mathbf{F}_{\tau,s}$ has a small neighborhood $\mathcal{V} \subset \mathcal{U}$ where the primary renormalization map (7.7) exists. A ternary parabolic prepacman $\mathbf{F}_{\tau,s,f}$ has a neighborhood $\mathcal{W} \subset \mathcal{V}$ where the secondary renormalization map (7.11) exists. The set \mathcal{W} contains a ternary small copy \mathcal{M}_0 .

Observe that the secondary renormalization (7.11) can be slightly thickened to a quadratic-like map, compare with [DH2, Mi]. Indeed, since the rays $\mathbf{R}_\ell, \mathbf{R}_\rho$ forming $\partial\mathbf{W}_{\tau,s}^1$ land at a (regular) repelling periodic point $\gamma_0 \in \text{Dom}(\mathbf{G}^{Q(\tau,s)})$, see Figure 39, we thicken $\mathbf{W}_{\tau,s}^1$ in a small neighborhood of γ_0 respecting its linear coordinates, and then extend the thickening for finitely many iterations along $\mathbf{R}_\ell, \mathbf{R}_\rho$. Let ρ be the Douady-Hubbard straightening map associated with (7.11) (ρ is χ from §3.1.1 appropriately restricted). Then ρ is a homeomorphism in a small neighborhood of $\mathbf{F}_{\tau,s,f}$. Observe that $p_f := \rho(\mathbf{F}_{\tau,s,f})$ is the quadratic polynomial whose α -fixed point has multiplier $e(f)$. Choose $\mathfrak{k} \in \mathbb{Q}$ close to f . By the Yoccoz inequality in the quadratic family, the primary satellite small copy $\mathcal{M}_{\mathfrak{k}}$ (see notations in §3.1.2) is in a small neighborhood of p_f . We obtain that $\mathcal{M}_{\tau,s,\mathfrak{k}} := \rho^{-1}(\mathcal{M}_{\mathfrak{k}})$ is a full small copy of the Mandelbrot set (see Figure 40):

Theorem 7.9. *In a small neighborhood of $\mathbf{F}_{\tau,s,f}$ there is a ternary satellite copy $\mathcal{M}_0 = \mathcal{M}_{\tau,s,\mathfrak{k}}$ of the Mandelbrot set. \square*

We say that \mathbf{F}_τ is the root of the limb containing \mathcal{M}_0 .

Remark 7.10. *The fact that $\mathcal{M}_{\tau,s,\mathfrak{k}}$ is a bounded subset of \mathcal{W}^u follows from the Yoccoz inequality. Note that we use the Yoccoz inequality in the quadratic family after applying the straightening map associated with the second renormalization (7.11). By applying the Yoccoz inequality directly in \mathcal{W}^u (after slight thickening of external rays), it is possible to construct a secondary satellite copy $\mathcal{M}_{\tau,s'}$ of the Mandelbrot set in a small neighborhood of $\mathbf{F}_{\tau,s}$. This would imply the scaling law for secondary satellite copies as in (1.2).*

The case of primary copies of the Mandelbrot set is more delicate because the first renormalization map (7.7) is pinched and the pinching can not be resolved: (7.7) maps $\alpha(1/2) \in \partial\mathbf{W}^1$ to $\alpha \in \partial\mathbf{W}$ and $\alpha(1/2) \in \mathbf{Esc}_{Q(\tau)}$ is an essential singularity for $\mathbf{G}^{Q(\tau)}$ by Lemma 6.5; i.e. $\mathbf{G}^{Q(\tau)}$ has no extension through $\mathbf{Esc}_{Q(\tau)}$. Moreover, the map $\mathbf{R}_{\text{prm}}^{\text{m}}$ in (1.2) cannot be quasiconformal because $\mathcal{M}_{p/q}$ and $\mathcal{M}_{p'/q'}$ are

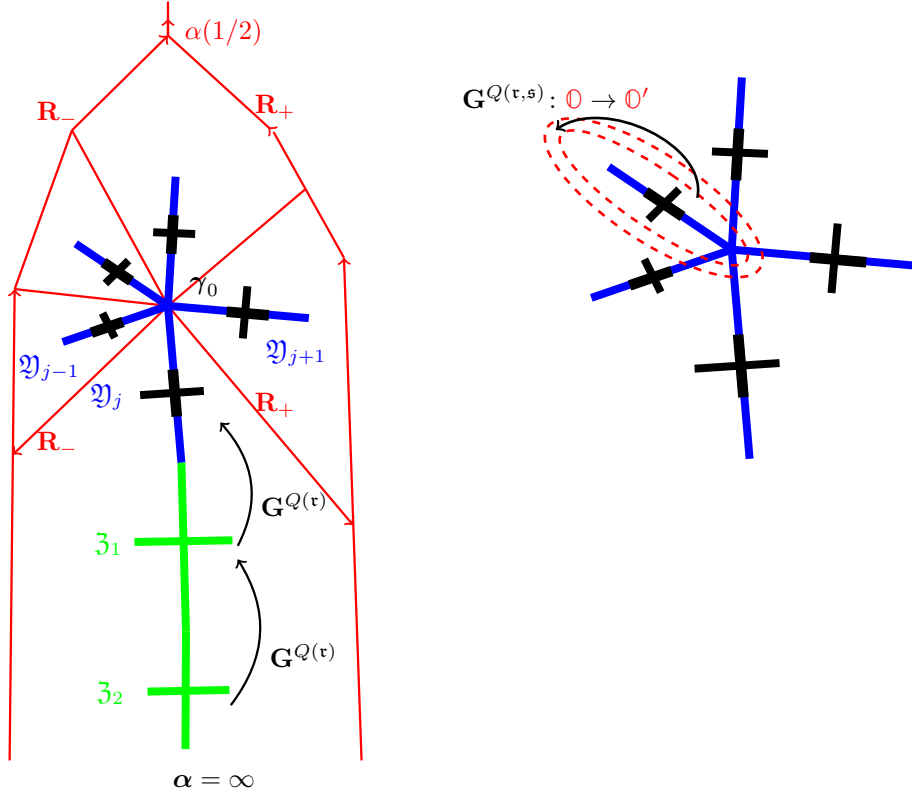

FIGURE 41. Left: the valuable petal $\mathbf{X}^0(\mathbf{G})$ consists of a periodic cycle of secondary small filled-in Julia sets \mathfrak{J}_i (blue) and secondary preperiodic small filled-in Julia sets \mathfrak{Z}_i (green) converging to α . The ternary Julia sets are marked black. External rays landing at γ_0 and α are marked red. Arrows indicate the direction of \mathbf{R}_- , \mathbf{R}_+ from γ_0 to ∞ . Right: the quadratic-like map (8.2) realizing the secondary renormalization.

not qc homeomorphic if $q \neq q'$ [LP]. However, the pictures suggest that the scaling law (1.2) for primary copies may still be valid.

8. THE VALUABLE FLOWER THEOREM

Let us fix a copy $\mathcal{M}_0 \subset \mathcal{W}^u$ from Theorem 7.9. We set $\mathcal{M}_n := \mathcal{R}^n(\mathcal{M}_0)$.

8.1. Valuable flowers of prepacmen. Consider a pacman $\mathbf{G} \in \mathcal{M}_0$. We denote by $\mathfrak{X}^0(\mathbf{G})$ the non-escaping set (the “little Julia set”) of the primary renormalization map (7.7). Similarly, let \mathfrak{J}_0 be the non-escaping set of the secondary renormalization map (7.11). We say that \mathfrak{J}_0 is a *secondary small filled-in Julia set* (recall that (7.11) can be thickened to a quadratic-like map). Applying $\mathbf{G}^{Q(\tau)}$ to \mathfrak{J}_0 , we obtain a periodic cycle $(\mathfrak{J}_i)_i$ of small filled-in Julia sets, see Figure 41. By construction, all \mathfrak{J}_i are attached to γ_0 (which is the β -fixed point of \mathfrak{J}_i); we enumerate \mathfrak{J}_i counterclockwise around γ_0 .

Choose an index j such that \mathfrak{Y}_j contains a unique critical point of the primary renormalization map (7.7). Since (7.7) is a branched covering of degree 2 (a pinched quadratic-like map), the following holds because the combinatorics of lifts for (7.7) is the same as for quadratic polynomials. There are external rays $\mathbf{R}_-, \mathbf{R}_+$ landing at γ_0 and separating \mathfrak{Y}_j from all remaining \mathfrak{Y}_i , see Figure 41. Then \mathfrak{Y}_j and α are on the same side of $\overline{\mathbf{R}_- \cup \mathbf{R}_+}$: the rays $\overline{\mathbf{R}_- \cup \mathbf{R}_+}$ bound a closed topological disk containing $\bigcup_{i \neq j} \mathfrak{Y}_i$. Let \mathfrak{Z}_1 be the unique preimage of \mathfrak{Y}_j under (7.7) intersecting \mathfrak{Y}_j ; and similarly, let \mathfrak{Z}_{i+1} be the unique $\mathbf{G}^{Q(\tau)}$ -preimage of \mathfrak{Z}_i intersecting \mathfrak{Z}_i .

Lemma 8.1. *The sets \mathfrak{Z}_i converge to α .*

Proof. Recall from Corollary 7.7 that the first renormalization map is written as $\mathbf{G}^{Q(\tau)}: \mathbf{W}^1 \rightarrow \mathbf{W}$. Let \mathbf{W}' be the closure of the connected component of $\mathbf{W} \setminus \overline{\mathbf{R}_- \cup \mathbf{R}_+}$ containing all \mathfrak{Z}_i . There is a unique connected component \mathbf{W}'' of $\mathbf{G}^{-Q(\tau)}(\mathbf{W}')$ such that $\mathbf{W}'' \subset \mathbf{W}'$. The map

$$(8.1) \quad \mathbf{G}^{Q(\tau)}: \mathbf{W}'' \rightarrow \mathbf{W}'$$

is univalent, and α is the only point in $\partial \mathbf{W}'$ that does not escape under the iterations of (8.1). Therefore, α is the Denjoy–Wolff fixed point of the inverse of (8.1): under the backward iterations of (8.1) every point in \mathbf{W}' converges to α ; the convergence is with respect to the wall topology because $\partial \mathbf{W} \subset \mathbf{R}^{-1} \cup \mathbf{R}^0$ and the rays $\mathbf{R}^{-1}, \mathbf{R}^0$ land at α , see Corollary 7.7. \square

The *valuable petal* $\mathbf{X}^0(\mathbf{G}) \subset \mathfrak{X}^0(\mathbf{G})$ is the union $\bigcup_i \mathfrak{Y}_i \cup \bigcup_{i \geq 1} \mathfrak{Z}_i$. The *upper part* of $\mathbf{X}^0(\mathbf{G})$ is $\mathbf{X}_{\text{up}}^0(\mathbf{G}) := \bigcup_i \mathfrak{Y}_i$. By construction, both $\mathbf{X}^0(\mathbf{G})$ and $\mathbf{X}_{\text{up}}^0(\mathbf{G})$ are $\mathbf{G}^{Q(\tau)}$ -invariant. Spreading around $\mathbf{X}^0(\mathbf{G})$, we obtain the *valuable flower*:

$$\mathbf{X}(\mathbf{G}) := \bigcup_{P < Q(\tau)} \mathbf{G}^P(\mathbf{X}^0(\mathbf{G})).$$

Similarly, $\mathbf{X}_{\text{up}} \subset \mathbf{X}(\mathbf{G})$ is obtained by spreading around \mathbf{X}_{up}^0 . We enumerate petals of $\mathbf{X}(\mathbf{G})$ from left-to-right as \mathbf{X}^i so that $\mathbf{X}^i \subset \mathbf{W}(i, \mathbf{G})$, where $\mathbf{W}(i)$ are puzzle pieces from Theorem 7.2.

Recall that the secondary renormalization (7.11) admits a thickening to a quadratic-like map. For every $\mathbf{G} \in \mathcal{M}_0$, the quadratic-like germ of (7.11) can be presented as a quadratic-like map

$$(8.2) \quad \mathbf{G}^{Q(\tau, s)}: \mathbb{O} \rightarrow \mathbb{O}'$$

such that

- $\mathbb{O}' \in \mathbf{W}$;
- $\overline{\mathbb{O}'} \setminus \text{int } \mathbf{W}_{\tau, s}$ is in a small neighborhood of γ_0 ,
- \mathbb{O}' depends continuously on $\mathbf{G} \in \mathcal{M}_0$; and
- the *unbranched condition* holds:

$$(8.3) \quad \mathfrak{P}(\mathbf{G}) \cap \mathbb{O}' \subset \mathfrak{Y}^0,$$

where \mathfrak{Y}^0 is the secondary small filled-in Julia set containing 0, see §8.1. (For the unbranched condition, observe that $\mathfrak{P}(\mathbf{F})$ is within the cycle of ternary filled-in Julia sets; these sets are disjoint from γ_0 .)

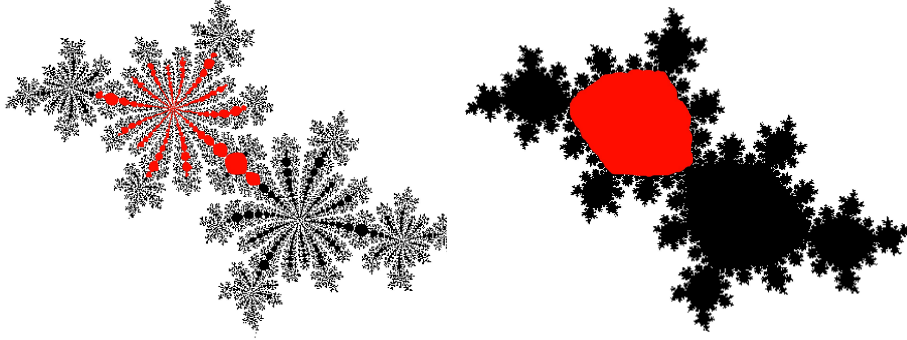

FIGURE 42. Illustration to Theorem 8.2: the valuable flower (red) of the 5/13 Rabbit tuned with the Basilica approximates the golden Siegel disk (also red).

The *enlarged valuable flower* is

$$\tilde{\mathbf{X}}(\mathbf{G}) := \mathbf{X}(\mathbf{G}) \cup \bigcup_{P \leq Q(\tau, s)} \mathbf{G}^P(0).$$

Since different sets in $(\mathbf{G}^P(0))_{P \leq Q(\tau, s)}$ intersect only in a small neighborhood of γ , different petals of $\mathbf{X}(\mathbf{G})$ are in different petals of $\tilde{\mathbf{X}}(\mathbf{G})$. Petals in $\tilde{\mathbf{X}}$ are enumerated as $\tilde{\mathbf{X}}^i$, $i \in \mathbb{Z}$, so that $\mathbf{X}^i \subset \tilde{\mathbf{X}}^i \subset \mathbf{W}(i)$. Similarly, we set

$$\tilde{\mathbf{X}}_{\text{up}} := \mathbf{X}_{\text{up}}(\mathbf{G}) \cup \bigcup_{P \leq Q(\tau, s)} \mathbf{G}^P(0) \quad \text{and} \quad \tilde{\mathbf{X}}_{\text{up}}^i := \tilde{\mathbf{X}}_{\text{up}} \cap \tilde{\mathbf{X}}^i.$$

For $\mathbf{G}_n := \mathcal{R}^n(\mathbf{G}) \in \mathcal{M}_n$ we define $\mathbf{X}(\mathbf{G}_n)$ and $\tilde{\mathbf{X}}(\mathbf{G}_n)$ to be the A_\star^{-n} -images of $\mathbf{X}(\mathbf{G})$ and $\tilde{\mathbf{X}}(\mathbf{G})$. Since $\mathcal{O}'(\mathbf{G}_n)$ and $\mathcal{O}(\mathbf{G}_n)$ are rescalings of $\mathcal{O}'(\mathbf{G})$ and $\mathcal{O}(\mathbf{G})$, there is an $\varepsilon > 0$ such that

$$\text{mod}(\mathcal{O}'(\mathbf{G}_n) \setminus \mathcal{O}(\mathbf{G}_n)) \geq \varepsilon > 0$$

for all n and $\mathbf{G}_n \in \mathcal{M}_n$. The upper parts $\mathbf{X}_{\text{up}}(\mathbf{F})$ and $\tilde{\mathbf{X}}_{\text{up}}(\mathbf{F})$ are defined accordingly.

8.2. Valuable flowers of pacmen. Consider a pacman $f \in \mathcal{B}$ from a Banach neighborhood of f_\star where the pacman renormalization $\mathcal{R}: \mathcal{B} \dashrightarrow \mathcal{B}$ is defined, see §3.2.6. By a *flower* we mean a connected set $T \ni \alpha$ such that $T \setminus \{\alpha\}$ has finitely many connected components, called *petals*. We say that the flower T is *nice* if f has a Siegel triangulation Δ (see §3.2.12) with a wall approximating ∂Z_{f_\star} such that different petals of T are in different triangles of Δ . As a consequence if $f = \mathcal{R}f_{-1}$ (or more generally, $f = \mathcal{R}_{\text{Sieg}}f_{-1}$ for an operator $\mathcal{R}_{\text{Sieg}}$ as in §3.2.8), then the flower T admits a full lift T_{-1} to the dynamical plane of f_{-1} , see Lemma 3.2.

Theorem 8.2. *Consider the dynamical plane of f_\star and fix a small open neighborhood N_\star of \bar{Z}_\star . For $n \ll 0$ and every $\mathbf{G}_n \in \mathcal{M}_n$ the flowers $\tilde{\mathbf{X}}(\mathbf{G}_n)$ and $\mathbf{X}(\mathbf{G}_n)$ projects to the dynamical plane of g_n . Moreover, these projections $\tilde{X}(g_n)$ and $X(g_n)$ are nice flowers within N_\star .*

More precisely, \mathbf{G}_n has a fundamental domain \mathbf{S}^{new} such that if a petal $\tilde{\mathbf{X}}^i$ intersects \mathbf{S}^{new} , then $\tilde{\mathbf{X}}^i \subset \mathbf{S}^{\text{new}}$. The projection \tilde{X} of $\tilde{\mathbf{X}} \cap \mathbf{S}^{\text{new}}$ is within the Siegel triangulation $\Delta(g_n)$ of g_n , and the projection \tilde{X}_{up} of $\tilde{\mathbf{X}}_{\text{up}}$ is within the wall $\Pi(g_n)$ of $\Delta(g_n)$. The triangulation $\Delta(g_n)$ has a full lift to $\Delta(g_m)$ for $m \leq n$; for big $m \ll n < 0$, the triangulation $\Delta(g_m)$ approximates \bar{Z}_* .

Remark 8.3. The valuable flower $X(g_n)$ is a forward invariant set containing the postcritical set of g_n . The purpose of $X(g_n)$ is to encode the hybrid class of g_n , i.e. the combinatorial rotation numbers of dividing periodic cycles, as well as hybrid classes of secondary small filled-in Julia sets.

Proof. Let us first give an outline of the proof. We also slightly simplify the notations in the outline. In the actual proof, \mathbf{Z}_* is replaced by the renormalization triangulation $\Delta_{-n}(\mathbf{G}_n)$.

In the dynamical plane of $\mathbf{G} \in \mathcal{M}_0$, we re-enumerate the puzzle pieces $\mathbf{W}(i, \mathbf{G}), i \in \mathbb{Z}$, from Theorem 7.2 by the “landing time.” Namely, for every $\mathbf{W}(i)$ there is a unique minimal $P(i) \in \mathbb{T}$ such that $\mathbf{G}^{P(i)}(\mathbf{W}(i)) \supset \mathbf{W}(0)$, see details in §8.2.2. We write

$$(8.4) \quad \mathbf{W}_{P(i)} := \mathbf{W}(i) \quad \text{and} \quad i(P(i)) := i.$$

For $n \in \mathbb{Z}$, we have $\mathbf{W}_P(\mathbf{G}_n) = A_*^{-n} \mathbf{W}_{\tau_P}(\mathbf{G})$ by (4.5). Recall from §5.10 that $\mathbf{W}_P(\mathbf{F}_*)$ denotes the primary wake of generation P . In Lemma 8.6, we will show that $\mathbf{W}_P(\mathbf{G}_n) \setminus \mathbf{Z}_*$ converges to $\mathbf{W}_P(\mathbf{F}_*)$ for every fixed $P > 0$. Combing with Lemma 5.29, we obtain that if P is sufficiently big, then $\mathbf{W}_P(\mathbf{G}_n) \setminus \mathbf{Z}_*$ is small in the spherical metric of $\hat{\mathbb{C}}$.

The main step is to show that $\tilde{\mathbf{X}}^i \setminus \mathbf{Z}_*$ is uniformly small. If $P(i)$ is big, then $\tilde{\mathbf{X}}^i \setminus \mathbf{Z}_*$ is small because $\mathbf{W}_{P(i)} \setminus \mathbf{Z}_*$ is small. If $P(i)$ is bounded but $\mathbf{W}_{P(i)}$ is far from 0 in \mathbb{C} , then $\tilde{\mathbf{X}}^i \subset \mathbf{W}_{P(i)}$ is small in the spherical metric of $\hat{\mathbb{C}}$ (in fact, this case can be ignored). There are finitely many i in the remaining case; i.e. when $P(i)$ is bounded and $\mathbf{W}_{P(i)}$ is not far from 0 in \mathbb{C} . Let us fix such i . For $n \ll 0$, we have $\tilde{\mathbf{X}}_{\text{up}}^i(\mathbf{G}_n) \ni c_{P(i)}(\mathbf{G}_n)$, where $c_{P(i)}(\mathbf{F}_*) \in \partial \mathbf{Z}_*$ is the unique critical point of $\mathbf{F}_*^{\geq 0}$ in $\partial \mathbf{Z}_*$ of generation $P(i)$. We have a map

$$\mathbf{G}_n^{P(i)} : \tilde{\mathbf{X}}_{\text{up}}^i \rightarrow \tilde{\mathbf{X}}_{\text{up}}^0 \ni 0.$$

Since $\tilde{\mathbf{X}}_{\text{up}}^0(\mathbf{G}_n) = A_*^{-n}(\tilde{\mathbf{X}}_{\text{up}}^0(\mathbf{G}_0))$ shrinks to 0 as $n \rightarrow -\infty$, we obtain that $\tilde{\mathbf{X}}_{\text{up}}^i(\mathbf{G}_n)$ shrinks to $c_{P(i)}$. This allows us to deduce that $\tilde{\mathbf{X}}^i \setminus \mathbf{Z}_*$ is small because the remaining part of $\tilde{\mathbf{X}}^i$ is “below” $\tilde{\mathbf{X}}_{\text{up}}^i$, compare with Figure 43.

Recall that the parabolic prepacman \mathbf{F}_τ is the root of the limb containing \mathcal{M}_0 , see Figure 40. For $n \leq 0$, the parabolic pacman

$$(8.5) \quad f_{\tau_n} := \mathcal{R}^n f_\tau$$

has rotation number $\tau_n = \mathfrak{p}_n/\mathfrak{q}_n \in \mathbb{Q}$ satisfying $R_{\text{prm}}^{-n\mathfrak{m}}(\tau_n) = \tau$, see Lemma 3.1. Then \mathbf{F}_{τ_n} is the root of the limb containing \mathcal{M}_n and τ_n is the combinatorial rotation number of g_n . Since $\tilde{\mathbf{X}}^i \setminus \mathbf{Z}_*$ is small for every i , we can adjust the fundamental domain $\mathbf{S}(\mathbf{G}_n)$ (see §4.8) so that the new $\mathbf{S}^{\text{new}}(\mathbf{G}_n)$ contains the petals $\tilde{\mathbf{X}}^i$ for $i \in \{-\mathfrak{p}_n + 1, \mathfrak{p}_n + 2, \dots, \mathfrak{q}_n - \mathfrak{p}_n\}$. By Theorem 4.7, $\tilde{\mathbf{X}}$ projects to the dynamical plane of g_n and \mathbf{S}^{new} projects into $\Delta_{\text{Sieg}} := \Delta_0^{\text{new}}(g_n)$; applying antirenormalizations, we can assume that Δ_{Sieg} approximates \bar{Z}_* .

Let us now provide the details.

8.2.1. *The escaping set.* Up to replacing \mathcal{M}_0 with its antirenormalization, we can assume that $\mathcal{M}_0 \subset \mathcal{W}_{\text{loc}}^u$. In particular, every $\mathbf{G} \in \mathcal{M}_0$ has a renormalization triangulation $\Delta_0(\mathbf{G})$ with the wall $\mathbb{P}_0(\mathbf{G})$ that bounds $\mathbf{Q}_0 = \Delta_0 \setminus \mathbb{P}_0$, see §4.6.

Fix a big $T \in \mathbb{T}$. For $n \ll 0$ sufficiently big, the holomorphic motion τ from Lemma 6.8 induces an equivariant map

$$(8.6) \quad h_n : \mathbf{Esc}_T(\mathbf{G}_n) \rightarrow \mathbf{Esc}_T(\mathbf{F}_\star).$$

Applying the λ -lemma, we obtain:

Lemma 8.4. *For $n \ll 0$ sufficiently big (depending on T), (8.6) is close to the identity with respect to the spherical distance. \square*

8.2.2. *Decomposition $\mathbf{W}_P = \mathbf{W}_P^a \cup \mathbf{W}_P^1 \cup \mathbf{W}_P^b$.* Recall from Theorem 7.2 that $\mathbf{W}(i, \mathbf{F}_\tau)$ denotes the puzzle piece bounded by \mathbf{R}^{i-1} and \mathbf{R}^i . Since $\mathcal{M}_0 \subset \mathcal{V}$ (see Figure 40), the puzzle pieces $\mathbf{W}(i, \mathbf{G})$ exist (in the sense of §6.4) in the dynamical plane of $\mathbf{G} \in \mathcal{M}_0$. Let us first discuss the combinatorics of $\mathbf{W}(i, \mathbf{G})$. For $i \neq 0$, the *generation of $\mathbf{W}(i, \mathbf{G}_0)$* is the unique “landing time” $P(i) < Q(\tau)$ such that

$$(8.7) \quad \mathbf{G}^{Q(\tau)-P(i)} : \mathbf{W}(0) \rightarrow \mathbf{W}(i)$$

is a univalent map. Let us re-label the puzzle pieces by their landing time:

$$\mathbf{W}_{P(i)}(\mathbf{G}) := \mathbf{W}(i, \mathbf{G}) \quad \text{and} \quad \mathbf{W}_0(\mathbf{G}) := \mathbf{W}(0, \mathbf{G}).$$

Then (8.7) takes the form

$$(8.8) \quad \mathbf{G}^{Q(\tau)-P} : \mathbf{W}_0 \rightarrow \mathbf{W}_P.$$

Recall from Lemma 7.3 that $\mathbf{W} = \mathbf{W}^1 \cup \mathbf{W}^a \cup \mathbf{W}^b$. Let \mathbf{W}_P^1 , \mathbf{W}_P^a , and \mathbf{W}_P^b be the images of \mathbf{W}^1 , \mathbf{W}^a , and \mathbf{W}^b under (8.8) respectively. We have a two-to-one map

$$(8.9) \quad \mathbf{G}^P : \mathbf{W}_P^1 \rightarrow \mathbf{W}_0,$$

while \mathbf{G}^P maps univalently into \mathbf{W}_P^a and into \mathbf{W}_P^b to two different components of $\mathbb{C} \setminus (\mathbf{W} \cup \mathbf{R}^0)$, see Figure 43.

8.2.3. *Decomposition $\mathbf{W}_P^1 = \mathbf{W}_P^+ \cup \mathbf{W}_P^\bullet \cup \mathbf{W}^-$.* We still consider the dynamical plane of $\mathbf{G} \in \mathcal{M}_0$. Choose an auxiliary univalent 2-wall $\mathbb{A} \subset \mathbf{Q}$, see §3.2.11 and §4.6. We denote by \mathbf{Q}' the connected component of $\mathbf{Q} \setminus \mathbb{A}$ attached to α . Let us fix a closed topological disk \mathbf{W}_0^\bullet in \mathbf{W}_0 such that

- (A) $\mathbf{W}_0 \setminus \mathbf{Q}' \subset \mathbf{W}_0^\bullet$;
- (B) $\mathbf{W}_0^\bullet \supset \mathbf{X}_{\text{up}}^0$ (recall that $\mathbf{X}_{\text{up}}^0 = \bigcup_i \mathfrak{Y}_i$).

We set $\mathbf{W}_0^- := \mathbf{W}_0 \setminus \mathbf{W}_0^\bullet$.

Since \mathbf{W}_0^\bullet contains the unique critical value of (8.9), the preimage of \mathbf{W}_0^\bullet under (8.9) consists of a single connected component, call it \mathbf{W}_P^\bullet . On the other hand, the preimage of \mathbf{W}_0^- under (8.9) consists of two connected components, we denote them by \mathbf{W}_P^- and \mathbf{W}_P^+ specified so that \mathbf{W}_P^- is attached to α , see Figure 43.

Finally, we define $\mathbf{W}_0^{\text{out}} := \mathbf{W}_0^\bullet$ and

$$\mathbf{W}_P^{\text{out}} := \mathbf{W}_P^\bullet \cup \mathbf{W}_P^+ \cup \mathbf{W}_P^a \cup \mathbf{W}_P^b \quad \text{for } P > 0.$$

For $n \in \mathbb{Z}$ and $P < Q(\tau)$, we define:

$$(8.10) \quad \mathbf{W}_P(\mathbf{G}_n) := \mathbf{W}_P(\mathbf{G}_n) := A_\star^{-n} \mathbf{W}_{\tau^n P}(\mathbf{G}).$$

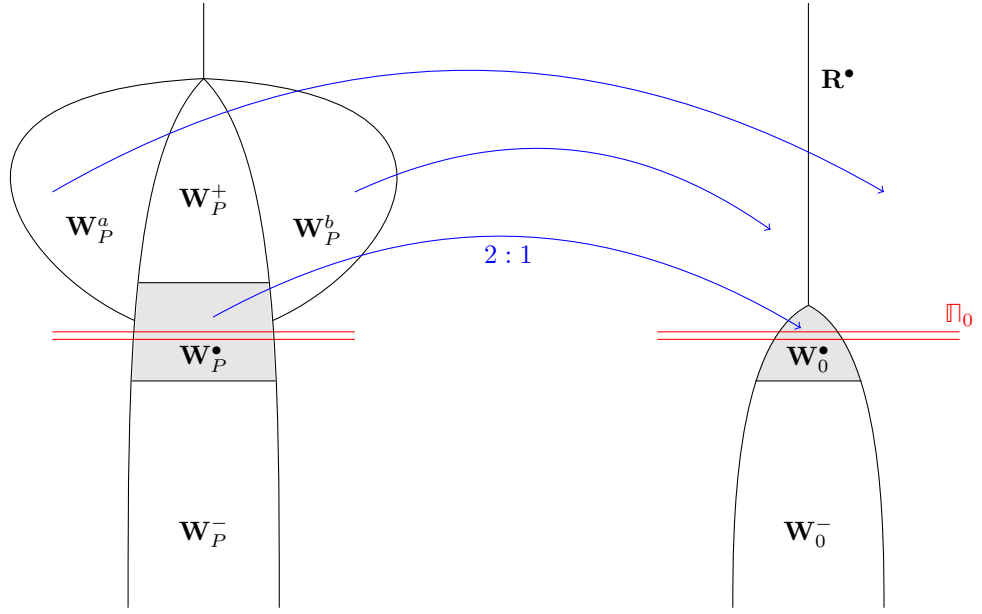

FIGURE 43. The decomposition of \mathbf{W}_P , see also Figure 35. The regions \mathbf{W}_P^\bullet and $\mathbf{W}_P^- \cup \mathbf{W}_P^+$ are the preimages of \mathbf{W}_0^\bullet and \mathbf{W}_0^- under $\mathbf{G}^P: \mathbf{W}_P \rightarrow \mathbf{W}_0$ respectively. The region $\text{int}(\mathbf{W}_P^a \cup \mathbf{W}_P^b)$ is the preimages of $\mathbb{C} \setminus (\mathbf{W}_0 \cup \mathbf{R}^\bullet)$ under $\mathbf{G}^P: \mathbf{W}_P \rightarrow \mathbb{C}$. We define $\mathbf{W}_P^{\text{out}} := \mathbf{W}_P^\bullet \cup \mathbf{W}_P^+ \cup \mathbf{W}_P^a \cup \mathbf{W}_P^b$.

The regions $\mathbf{W}_P^1(\mathbf{G}_n)$, $\mathbf{W}_P^\bullet(\mathbf{G}_n)$, $\mathbf{W}_P^a(\mathbf{G}_n)$, $\mathbf{W}_P^b(\mathbf{G}_n)$, $\mathbf{W}_P^-(\mathbf{G}_n)$, $\mathbf{W}_P^+(\mathbf{G}_n)$, $\mathbf{W}_P^{\text{out}}(\mathbf{G}_n)$ are defined accordingly using (8.10).

As in §4.6, $\mathbf{Q}'_{-n}(\mathbf{G}_n)$ is the rescaling of $\mathbf{Q}'(\mathbf{G})$. It follows from Condition (A) that

$$\mathbf{W}_P(\mathbf{G}_n) \setminus \mathbf{Q}'_{-n} \subset \mathbf{W}_P^{\text{out}}(\mathbf{G}_n) \quad \text{and} \quad \mathbf{W}_P^-(\mathbf{G}_n) \subset \mathbf{Q}'_{-n}(\mathbf{G}_n).$$

Condition (B) implies

$$(8.11) \quad \tilde{\mathbf{X}}^i(\mathbf{G}_n) \subset \mathbf{W}_{P(i)}^\bullet \cup \mathbf{W}_{P(i)}^-(\mathbf{G}_n) \quad \text{and} \quad \tilde{\mathbf{X}}_{\text{up}}^i(\mathbf{G}_n) \subset \mathbf{W}_{P(i)}^\bullet(\mathbf{G}_n).$$

8.2.4. $\mathbf{R}^\bullet(\mathbf{G}_n)$ converges to $\mathbf{R}^\bullet(\mathbf{F}_\star)$. We say that arcs $\beta, \gamma \subset \widehat{\mathbb{C}}$ are C^0 -close if, up to re-parameterization, the functions $\beta, \gamma: [0, 1] \rightarrow \mathbb{C}$ are close with respect to the spherical metric of $\widehat{\mathbb{C}}$. The C^0 -closeness for closed curves is defined in the same way.

Two topological closed disks $D_1, D_2 \subset \widehat{\mathbb{C}}$ are C^0 -close if $\partial D_1, \partial D_2$ are C^0 -close closed curves. Equivalently, viewing D_1, D_2 as injective functions $D_1, D_2: \overline{\mathbb{D}} \rightarrow \widehat{\mathbb{C}}$, the disks D_1, D_2 are C^0 -close if, up to re-parameterization, the corresponding functions are close with respect to the spherical metric of $\widehat{\mathbb{C}}$.

Let us write:

$$\mathbf{R}^\bullet(\mathbf{G}_0) := \mathbf{R}^{-1} \cap \mathbf{R}^0(\mathbf{G}_0) \quad \text{and} \quad \mathbf{R}^\bullet(\mathbf{G}_n) := A_\star^{-n} \mathbf{R}^\bullet(\mathbf{G}_0).$$

Recall that $\mathbf{R}^\bullet(\mathbf{F}_\star)$ is the ray landing at 0, see §5.9.

Lemma 8.5. *If $n \ll 0$ is sufficiently big, then $\mathbf{R}^\bullet(\mathbf{G}_n)$ is close to $\mathbf{R}^\bullet(\mathbf{F}_\star)$ with respect to the C^0 -distance.*

Proof. Fix a small $\varepsilon > 0$. We will show that $\mathbf{R}^\bullet(\mathbf{G}_n)$ is ε -close to $\mathbf{R}^\bullet(\mathbf{F}_\star)$ for $n \ll 0$.

Recall from (5.9) that $\mathbf{R}^\bullet(\mathbf{F}_\star)$ decomposes as a concatenation $\bigcup_{j \in \mathbb{Z}} \mathbf{I}_j$, where \mathbf{I}_j is a ray segment in the closure of $\mathbf{Esc}_{\ell_j P} \setminus \mathbf{Esc}_{\ell_{j-1} P}(\mathbf{F}_\star)$ such that $A_\star \mathbf{I}_j = \mathbf{I}_{j+1}$.

By Corollary 5.27, every two rays eventually meet at an alpha-point. Suppose that $\mathbf{R}^\bullet(\mathbf{G}_n)$ meets $\mathbf{R}^\bullet(\mathbf{G}_n)$ at α_n , where $\mathbf{R}^\bullet(\mathbf{G}_n)$ is the counterpart of $\mathbf{R}^\bullet(\mathbf{G}_n)$. Then $\alpha_n = A_\star \alpha_{n+1}$ and the α_n tends to 0 as $n \rightarrow -\infty$.

Choose first a big $k \gg 0$, then a sufficiently big $T > 0$. For a sufficiently big $n \ll 0$, we can decompose

$$\mathbf{R}^\bullet(\mathbf{G}_n) = \mathbf{L}^n \cup \bigcup_{j \leq k} \mathbf{I}_j(\mathbf{G}_n)$$

such that $\bigcup_{j \leq k} \mathbf{I}_k \subset \mathbf{Esc}_T(\mathbf{G}_n)$. By Lemma 8.4, $\mathbf{I}_j(\mathbf{G}_n)$ is ε -close to $\mathbf{I}_j(\mathbf{F}_\star)$ with respect to the spherical metric for all $j \leq k$.

Applying A_\star , we obtain the decomposition

$$\mathbf{R}^\bullet(\mathbf{G}_{n-1}) = \mathbf{L}^{n-1} \cup \bigcup_{j \leq k+1} \mathbf{I}_j(\mathbf{G}_{n-1})$$

where

$$\mathbf{L}^{n-1}(\mathbf{G}_{n-1}) = A_\star \mathbf{L}^n(\mathbf{G}_n) \quad \text{and} \quad \mathbf{I}_{k+1}(\mathbf{G}_{n-1}) = A_\star \mathbf{I}_k(\mathbf{G}_n).$$

By Lemma 8.4, for $j \leq k$ the ray segment $\mathbf{I}_j(\mathbf{G}_{n-1})$ is ε -close to $\mathbf{I}_j(\mathbf{F}_\star)$. Recall that $\mathbf{I}_k(\mathbf{G}_n)$ is ε -close to $\mathbf{I}_k(\mathbf{F}_\star)$ which is close to 0 because $k \gg 0$. Since A_\star contracts the spherical metric in a neighborhood of 0, we see that $\mathbf{I}_{k+1}(\mathbf{G}_{n-1})$ is ε -close to $\mathbf{I}_{k+1}(\mathbf{F}_\star)$.

Continuing the process, we obtain the decomposition

$$\mathbf{R}^\bullet(\mathbf{G}_m) = \mathbf{L}^m \cup \bigcup_{j \leq k+n-m} \mathbf{I}_j(\mathbf{G}_m)$$

for $m \leq n$, where $\bigcup_{j \leq k+n-m} \mathbf{I}_j(\mathbf{G}_m)$ is ε -close to $\bigcup_{j \leq k+n-m} \mathbf{I}_j(\mathbf{F}_\star)$. Since $\mathbf{L}^m(\mathbf{G}_m) = A_\star^{n-m} \mathbf{L}^n(\mathbf{G}_n)$, the chain $\mathbf{L}^m(\mathbf{G}_m)$ is eventually in a small neighborhood of 0, and the claim follows. \square

8.2.5. $\mathbf{W}_P^{\text{out}}(\mathbf{G}_n)$ approximates $\mathbf{W}_P(\mathbf{F}_\star)$. Clearly, $\mathbf{W}_0^\bullet(\mathbf{G}_n) = A_\star^{-n} \mathbf{W}_0^\bullet(\mathbf{G}_0)$ shrinks to 0 as $n \rightarrow -\infty$.

Lemma 8.6. *For every $\varepsilon > 0$ and $P \in \mathbb{T}$ the following holds. If $n \ll 0$ is sufficiently big, then $\mathbf{W}_S^{\text{out}}(\mathbf{G}_n)$ is ε -close to $\mathbf{W}_S(\mathbf{F}_\star)$ with respect to C^0 -metric for every $S \leq P$. Moreover, \mathbf{W}_S^\bullet is in the ε -neighborhood of $c_s(\mathbf{F}_\star)$.*

Proof. By Lemma 4.4, we can choose a sufficiently small disk $D_0 := \overline{\mathbb{D}}(\zeta)$ around 0 and a sufficiently small neighborhood \mathcal{O} of \mathbf{F}_\star such that D_0 is disjoint from $\text{CV}(\mathbf{G}^S) \cup \mathbf{G}^S(D_0)$ for all $S \leq P$. In particular,

$$\tilde{D}(\mathbf{G}) := \bigcup_{S \leq P} \mathbf{G}^{-S}(D_0)$$

depends holomorphically on $\mathbf{G} \in \mathcal{O}$ and every connected component of $\tilde{D}(\mathbf{G})$ is a degree two preimage of D_0 .

For $S \leq P$, let $D_S(\mathbf{F}_\star)$ be the lift of D along $\mathbf{F}_\star^S: c_S \mapsto 0$. For $\mathbf{F} \in \mathcal{O}$, we define $D_S(\mathbf{F})$ to be the lift of D_0 under \mathbf{F}^S such that $D_S(\mathbf{F})$ depends holomorphically on \mathbf{F} . Let $c_S(\mathbf{F})$ be the unique preimage of 0 under $\mathbf{F}^S: D_S \rightarrow D_0$. We claim that for a sufficiently big $n \ll 0$, the point $c_S(\mathbf{G}_n)$ is the unique critical point of $\mathbf{G}_n^S: \mathbf{W}_S^1 \rightarrow \mathbf{W}_0$ for all $S \leq P$. Indeed, Lemma 7.4 asserts such statement for \mathbf{F}_τ and for sufficiently small S ; perturbing \mathbf{F}_τ to $\mathbf{G} \in \mathcal{M}_0$ and passing to the antirenormalization, we obtain the required claim.

Choose a sufficiently big $T \gg P$ such that

$$\mathbf{R}^\bullet(\mathbf{G}_n) \setminus \mathbf{Esc}_{T-P}(\mathbf{G}_n) \subset D_0$$

for all $n \ll 0$.

Consider $\mathbf{W}_S^{\text{out}}(\mathbf{G}_n)$ for $S \leq P$. We can decompose $\partial \mathbf{W}_S^{\text{out}} = \beta_1 \cup \beta_2$, where β_1 and β_2 are simple arcs satisfying

$$\beta_2 := \partial \mathbf{W}_S^{\text{out}} \cap \mathbf{Esc}_T(\mathbf{G}_n) \quad \text{and} \quad \beta_1 \subset D_S(\mathbf{G}_n).$$

By Lemma 8.4, $\beta_2(\mathbf{G}_n)$ is close to

$$\beta_2(\mathbf{F}_\star) = h_n(\beta_2(\mathbf{G}_n)) \subset \mathbf{W}_S(\mathbf{F}_\star).$$

Since

$$\beta_1(\mathbf{F}_\star) := \partial \mathbf{W}_S(\mathbf{F}_\star) \setminus \beta_2(\mathbf{F}_\star) \subset D_S(\mathbf{F}_\star)$$

and since $D_S(\mathbf{G}_n)$ is close to $D_S(\mathbf{F}_\star)$, we obtain that $\mathbf{W}_S^{\text{out}}(\mathbf{G}_n)$ is close to $\mathbf{W}_S(\mathbf{F}_\star)$. \square

Combining with Corollary 5.32, we obtain:

Corollary 8.7. *Fix a small $\varepsilon > 0$ and then a sufficiently big $n \ll 0$. Then the set $\mathbf{W}_S^\bullet(\mathbf{G}_n) \setminus \mathbf{Q}'_{-n}(\mathbf{G}_n)$ is within the spherical ε -neighborhood of $c_S(\mathbf{F}_\star)$ for every $S \in \mathbb{T}$.*

Since $\tilde{\mathbf{X}}^i \setminus \mathbf{Q}'_{-n}(\mathbf{G}_n) \subset \mathbf{W}_S^\bullet(\mathbf{G}_n) \setminus \mathbf{Q}'_{-n}(\mathbf{G}_n)$ (see (8.11)), the set $\tilde{\mathbf{X}}^i \setminus \mathbf{Q}'_{-n}(\mathbf{G}_n)$ is also in a small neighborhood of $c_S(\mathbf{F}_\star)$.

Proof. Choose a sufficiently big $P \gg 0$. By Lemma 8.6, $\mathbf{W}_S^\bullet(\mathbf{G}_n) \setminus \mathbf{Q}'_{-n}(\mathbf{G}_n)$ is within a small neighborhood of $c_S(\mathbf{F}_\star)$ for every $S \leq P$ and every sufficiently big $n \ll 0$.

By Corollary 5.32 and Lemma 8.6, every connected component of

$$(8.12) \quad \mathbb{C} \setminus \left(\mathbf{Q}'_{-n}(\mathbf{G}_n) \cup \bigcup_{S \leq P} \mathbf{W}_S^{\text{out}}(\mathbf{G}_n) \right)$$

is ε -small. Note that for $S > P$ and $T_1, T_2 \leq S$, the puzzle $\mathbf{W}_S(\mathbf{G}_n)$ is between $\mathbf{W}_{T_1}(\mathbf{G}_n)$ and $\mathbf{W}_{T_2}(\mathbf{G}_n)$ with respect to the left-right order if and only if $c_S(\mathbf{F}_\star)$ is between c_{T_1} and c_{T_2} with respect to $\partial \mathbf{Z}_\star$. Therefore, for $S > P$, the sets $\mathbf{W}_S(\mathbf{G}_n) \setminus \mathbf{Q}'_{-n}$ and $\mathbf{W}_S(\mathbf{F}_\star)$ are in the closures of $\varepsilon/2$ -close components of (8.12) and (5.16) respectively. This proves the corollary for $S > P$. \square

As a byproduct, we also obtain:

Lemma 8.8. *For every $\mathbf{G} \in \mathcal{M}_0$, the puzzle pieces $(\mathbf{W}(i, \mathbf{G}))_{i \in \mathbb{Z}}$ form a partition of \mathbb{C} : every $z \in \mathbb{C}$ belongs to some $\mathbf{W}(i)$.*

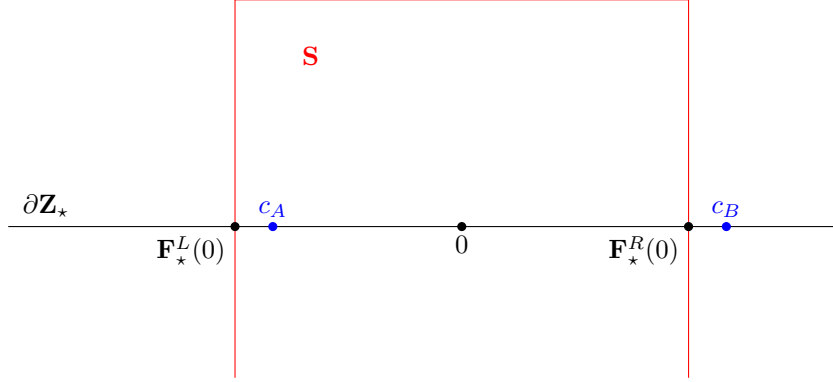

FIGURE 44. The critical points c_A and c_B are near $\mathbf{F}_\star^R(0)$ and $\mathbf{F}_\star^L(0)$ respectively.

Proof. Recall that the rays \mathbf{R}^i land at α , and the union $\bigcup_{i \in \mathbb{Z}} \mathbf{R}^i$ is a tree in \mathbb{C} (follows from Lemma 6.13 and Theorem 7.2). For $i < j$, let $\mathbf{W}_{i,j}$ be the unique component of $\mathbb{C} \setminus (\mathbf{R}^i \cup \mathbf{R}^j)$ attached to α in the following sense: $\mathbf{W}_{i,j}$ without a small neighborhood of α is precompact in \mathbb{C} . Since

$$\overline{\mathbf{W}_{i,j}} = \bigcup_{i < k \leq j} \mathbf{W}(k),$$

it is sufficient to show that $\bigcup_{i < j} \mathbf{W}_{i,j} = \mathbb{C}$.

The case $z \in \mathbf{Q}$ is straightforward. For $z \notin \mathbf{Q}$, we can surround $A_\star^{-n}z$ by $\mathbf{Q}'_{-n} \cup \mathbf{W}_S^{\text{out}} \cup \mathbf{W}_T^{\text{out}}(\mathbf{G}_n)$, where S, T are certain fixed power-triples and $n \ll 0$. \square

8.2.6. *Fundamental domain.* Using Corollary 8.7, we can now construct a fundamental domain \mathbf{S}^{new} as required. Write $L = (0, 1, 0)$, $R = (0, 0, 1)$, and note that $\mathbf{S}(\mathbf{F}_\star) \cap \partial \mathbf{Z}_\star$ is the arc $J := [\mathbf{F}_\star^L(0), \mathbf{F}_\star^R(0)] \subset \partial \mathbf{Z}_\star$. Choose c_A and c_B close to $\mathbf{F}_\star^L(0)$ and $\mathbf{F}_\star^R(0)$ respectively such that $A + R = B + L$, see Figure 44. We can assume that $c_A \in J$ while $c_B \notin J$.

Since $\tilde{\mathbf{X}}^i \setminus \mathbf{Q}'_{-n}(\mathbf{G}_n)$ is in a small neighborhood of $c_{P(i)}(\mathbf{F}_\star)$ (using notations from (8.4)), we can adjust $\mathbf{S}(\mathbf{G}_n)$ such that the new fundamental domain $\mathbf{S}^{\text{new}}(\mathbf{G}_n)$ (see §4.8) contains $\tilde{\mathbf{X}}^i$ for all $i \in \{i(A), i(A) + 1, \dots, i(B) - 1\} =: I$ and $\mathbf{S}^{\text{new}}(\mathbf{G}_n)$ is disjoint from $\tilde{\mathbf{X}}^i$ for all $i \notin I$. (To satisfy Conditions (2) and (3) in §4.8, we can assume that $\lambda(\mathbf{S}^{\text{new}})$ follows the ray $\mathbf{R}^{i(A)}$ and $\rho(\mathbf{S}^{\text{new}})$ follows the ray $\mathbf{R}^{i(B)-1}$.) We also have

$$\tilde{\mathbf{X}}_{\text{up}}^i(\mathbf{G}_n) \subset \bigcup_P \mathbf{W}_P^\bullet(\mathbf{G}_n) \subset \mathbb{P}_0(\mathbf{G}_n).$$

\square

9. PROOF OF THE MAIN RESULTS

By Theorem 7.9, the unstable manifold \mathcal{W}^u of \mathbf{F}_\star contains a sequence $(\mathcal{M}_n)_{n \leq 0}$ of copies of the Mandelbrot sets such that $\mathcal{R}\mathcal{M}_{n-1} = \mathcal{M}_n$. Every \mathcal{M}_n naturally

corresponds to a small copy $\mathcal{M}_n \subset \mathcal{M}$, see (9.4). We will show that $(\mathcal{M}_n)_{n \leq m}$ for $m \ll 0$ is a sequence satisfying Theorem 1.1.

9.1. Stable lamination. For $n \ll 0$, we define \mathcal{M}_n to be the set of pacmen $g_n \in \mathcal{W}^u$ with $\mathbf{G}_n \in \mathcal{M}_n$. By Theorem 8.2, every $g_n \in \mathcal{M}_n$ has a nice valuable flower $X(g_n)$ and a nice extended valuable flower $\tilde{X}(g_n)$ in a small neighborhood of \bar{Z}_* . Since the flowers are nice, $\tilde{X}(g_{n-1})$ is a full lift of $\tilde{X}(g_n)$.

For $g_n \in \mathcal{M}_n$, we denote by $\mathfrak{Y}^0(g_n)$ and $O(g_n)$ the projections of $\mathfrak{Y}^0(\mathbf{G}_n)$ and $O(\mathbf{G}_n)$, see §8.1. Then $\mathfrak{Y}^0(g_n)$ is the non-escaping set of the quadratic-like map

$$(9.1) \quad g_n^{\mathbf{a}_n} : O \rightarrow g_n^{\mathbf{a}_n}(O) = O',$$

where $\mathbf{r}_n = \mathbf{p}_n/\mathbf{q}_n$ is the combinatorial rotation number of $\alpha(g)$ and $\mathbf{a}_n := \mathbf{q}_n \mathbf{q}_s$. By construction, $g_n^i(O) \subset \tilde{X}(g)$ for $i \leq \mathbf{a}_n$. Since $\tilde{X}(g_n)$ is the projection of $\tilde{\mathbf{X}}(\mathbf{G}_n)$, the unbranched condition (8.3) implies the unbranched condition for (9.1):

$$(9.2) \quad \mathfrak{P}(g_n) \cap O' \subset \mathfrak{Y}^0(g_n).$$

By Lemma 3.1,

$$(9.3) \quad R_{\text{prm}}^m(\mathbf{r}_{n-1}) = \mathbf{r}_n.$$

Recall from §3.1.2 that $\mathcal{M}_{\mathbf{r}(n), \mathbf{s}, \mathbf{t}}$ denotes the ternary satellite copy of \mathcal{M} with rotation parameters $\mathbf{r}(n), \mathbf{s}, \mathbf{t}$. Let us consider the canonical homeomorphism

$$\chi_{\text{Pacm}} : \mathcal{M}_n \rightarrow \mathcal{M}_{\mathbf{r}(n), \mathbf{s}, \mathbf{t}} =: \mathcal{M}_n$$

between two copies of the Mandelbrot sets. Then

$$(9.4) \quad \mathbf{R}_{\text{prm}}^m \circ \chi_{\text{Pacm}}(g) = \chi_{\text{Pacm}} \circ \mathcal{R}(g), \quad g \in \bigcup_{n \ll 0} \mathcal{M}_n,$$

where \mathbf{R}_{prm} is the molecule map, see §3.2.15. We write $\mathbf{R} := \mathbf{R}_{\text{prm}}^m$; then χ_{Pacm} conjugates \mathcal{R} to \mathbf{R} .

Remark 9.1. *We believe that χ_{Pacm} on $\bigcup_{n \ll 0} \mathcal{M}_n$ can be extended to a “pacman straightening map” defined on the connectedness locus of the space of pacmen. Such a result is related to the Full Hyperbolicity of neutral renormalization and Conjecture 6.14.*

9.1.1. Lamination \mathcal{F}_n . Fix a big $\mathbf{n} \ll 0$ and consider $g \in \mathcal{M}_n$. For a pacman $f \in \mathcal{B}$ close to g , we set $O'(f) := O'(g)$ and we set $O(f)$ to be the lift of $O'(f)$ under $f^{\mathbf{a}_n}$ along the orbit of $f^{\mathbf{a}_n} : \mathfrak{Y}^0(f) \rightarrow \mathfrak{Y}^0(f)$; this is well defined because f is close to g . We obtain a quadratic-like map

$$(9.5) \quad \mathcal{R}_{\text{QL}}^{\bullet 2}(f) := f^{\mathbf{a}_n} : O(f) \rightarrow O'(f).$$

Let \mathcal{N}_n be a small Banach neighborhood of \mathcal{M}_n . Since \mathcal{M}_n is within a partial secondary copy of the Mandelbrot set (see Figure 40), (9.5) defines analytic operators into the space of quadratic-like germs \mathcal{QL} , see §3.1.1:

$$\mathcal{R}_{\text{QL}}^{\bullet 2} : \mathcal{N}_n \rightarrow \mathcal{QL} \quad \text{and} \quad \mathcal{R}_{\text{QL}}^{\bullet 3} := \mathcal{R}_{\text{QL}} \circ \mathcal{R}_{\text{QL}}^{\bullet 2} : \mathcal{N}_n \rightarrow \mathcal{QL},$$

where $\chi \circ \mathcal{R}_{\text{QL}}^{\bullet 3}(\mathcal{M}_n) = \mathcal{M}$ and $\chi \circ \mathcal{R}_{\text{QL}}^{\bullet 2}(\mathcal{M}_n) = \mathcal{M}_{\mathbf{t}} \subset \mathcal{M}$ – see Remark 9.2 below.

We denote by $\mathfrak{Y}^0(f)$ the non-escaping set of (9.5). Slightly shrinking $O'(f)$, if necessary, we can assume that the unbranched a priori bounds holds for (9.5):

$$\text{mod}(O'(f) \setminus O(f)) \geq \varepsilon_{\mathcal{M}_n} = \varepsilon_{\mathcal{M}_0}, \quad O(f) \cap \mathfrak{P}(f) \subset \mathfrak{K}(\mathcal{R}_{\text{QL}}^{\bullet 2}(f))$$

because they hold for (9.1).

Remark 9.2. *The operator $\mathcal{R}_{\text{QL}}^{\bullet 2}$ should be viewed as the composition $\mathcal{R}_{\text{QL}} \circ \mathcal{R}_{\text{QL}}^{\bullet}$, where $\mathcal{R}_{\text{QL}}^{\bullet} f$ is a degenerate quadratic-like map associated with the first renormalization map (7.7). It follows that*

$$(9.6) \quad \mathbf{R}_{\text{QL}}^2 \circ \chi_{\text{Pacm}}(g) = \chi \circ \mathcal{R}_{\text{QL}}^{\bullet 2}(g) \in \mathcal{M}_{\mathfrak{t}}, \quad g \in \mathcal{M}_{\mathbf{n}}$$

where χ is the quadratic-like straightening map, see §3.1.1.

Recall that we often identify a lamination with its support.

Lemma 9.3. *For $g \in \mathcal{M}_{\mathbf{n}}$ and $p := \chi_{\text{Pacm}}(g)$, define \mathcal{F}_p to be the set of f close to g such that (9.5) is hybrid equivalent to (9.1). The set*

$$\mathcal{F}_{\mathbf{n}} := \{\mathcal{F}_p\}_{p \in \mathcal{M}_{\mathbf{n}}}$$

forms a codimension-one lamination with complex-analytic leaves in a small neighborhood of $\mathcal{M}_{\mathbf{n}}$.

Proof. Recall from §3.1.1 that the hybrid classes form a codimension-one lamination \mathcal{F}_{QL} of the connectedness locus \mathfrak{M} with complex codimension-one analytic leaves. We need to show that the pullback $\mathcal{F}_{\mathbf{n}} = (\mathcal{R}_{\text{QL}}^{\bullet 2})^*(\mathcal{F}_{\text{QL}})$ is again a lamination of the same type. We will use an argument from [ALM, Theorem 4.9].

Consider a local leaf \mathcal{F}' of \mathcal{F}_{QL} intersecting $\mathcal{R}_{\text{QL}}^{\bullet 2}(\mathcal{M}_{\mathbf{n}})$. In a small neighborhood of $\mathcal{R}_{\text{QL}}^{\bullet 2}(\mathcal{M}_{\mathbf{n}})$, the leaf \mathcal{F}' is the zero set of some analytic function $\phi: \text{QL} \dashrightarrow \mathbb{C}$. Note that \mathcal{F}' intersects $\mathcal{R}_{\text{QL}}^{\bullet 2}(\mathcal{M}_{\mathbf{n}})$ at a single point. By the Inverse Function Theorem,

$$(\mathcal{R}_{\text{QL}}^{\bullet 2})^{-1}(\mathcal{F}') = (\phi \circ \mathcal{R}_{\text{QL}}^{\bullet 2})^{-1}(0)$$

is a codimension-one analytic manifold in a small neighborhood of $\mathcal{M}_{\mathbf{n}}$. Varying the \mathcal{F}' we obtain the pairwise disjoint closed leaves $(\mathcal{R}_{\text{QL}}^{\bullet 2})^{-1}(\mathcal{F}')$ that are transverse to $\mathcal{M}_{\mathbf{n}}$; these leaves form a lamination by the λ -lemma. \square

Since the local dynamics is structurally stable at $\alpha(g)$, by shrinking a neighborhood of $\mathcal{M}_{\mathbf{n}}$, we can assume that the flower $X(f)$ exists and depends holomorphically on $f \in \mathcal{F}_p$; i.e. certain preimages of $\mathfrak{Y}^0(f)$ assemble into the flower $X(f)$ in the same pattern as certain preimages of $\mathfrak{Y}^0(g)$ assemble into the flower $X(g)$. Indeed, by continuity, every preimage $\mathfrak{Z}' \subset X(g)$ of $\mathfrak{Y}^0(g)$ of bounded generation has the corresponding preimage $\mathfrak{Z}'(f)$ of $\mathfrak{Y}'(f)$ such that $\mathfrak{Z}'(f)$ is close to $\mathfrak{Z}'(g)$. Since the linear coordinate at α is structurally stable, every preimage of $\mathfrak{Z}' \subset X(g)$ of $\mathfrak{Y}^0(g)$ has a counterpart $\mathfrak{Z}'(f)$ if \mathfrak{Z}' is close to α .

The *extended flower* $\tilde{X}(f)$ is $X(f) \cup \bigcup_{i=0}^{\mathbf{n}} f^i(O)$. Since f is close to g , the flower $\tilde{X}(f)$ is also in a small neighborhood of \bar{Z}_{\star} .

9.1.2. *Lamination \mathcal{F} .* For a fixed $\mathbf{n} \ll 0$, we defined the lamination $\mathcal{F}_{\mathbf{n}}$ in Lemma 9.3. For $m \leq \mathbf{n}$ and $p \in \mathcal{M}_m$, we define

$$\mathcal{F}_p := \{f \in \mathcal{B} \mid \mathcal{R}^{\mathbf{n}-m}(f) \in \mathcal{F}_{\mathbf{R}^{\mathbf{n}-m}(p)}\},$$

Since \mathcal{R} is hyperbolic,

$$(9.7) \quad \mathcal{F}_m := \{\mathcal{F}_p \mid p \in \mathcal{M}_m\} \quad \text{and} \quad \mathcal{F} := \{\mathcal{W}^s\} \cup \bigcup_{m \leq \mathbf{n}} \mathcal{F}_m$$

form codimension-one stable laminations in a neighborhood of f_{\star} . A pacman $f \in \mathcal{F}_p$ with $p \in \mathcal{M}_m$ has nice flowers $X(f)$ and $\tilde{X}(f)$ that are the full lifts of $X(\mathcal{R}^{\mathbf{n}-m} f)$

and $\tilde{X}(\mathcal{R}^{n-m}f)$ respectively. The flowers $X(f)$ and $\tilde{X}(f)$ satisfy the same conditions as $X(\mathcal{R}^{n-m}f)$ and $\tilde{X}(\mathcal{R}^{n-m}f)$. In particular, $X(f)$ and $\tilde{X}(f)$ are in a small neighborhood of \bar{Z}_* ; and all pacmen in \mathcal{F}_p are hybrid conjugate in neighborhoods of their valuable flowers.

Let us write

$$p_* = p_{c(\theta_*)} =: \chi_{\text{Pacm}}(f_*) \quad \text{and} \quad \mathcal{F}_{p_*} = \mathcal{F}_* := \mathcal{W}^s,$$

where $p_* = p_{c(\theta_*)} \in \mathcal{M}$ is the unique quadratic polynomial on the boundary of the main hyperbolic component with rotation number θ_* . Since θ_* has bounded type, p_* is hybrid conjugate to f_* on neighborhoods of their closed Siegel disks, see §3.2.8. We obtain the parameterization of leaves of \mathcal{F} by

$$\mathcal{M}' := \{p_*\} \cup \bigcup_{m \leq n} \mathcal{M}_m$$

such that

$$(9.8) \quad \mathcal{R}(\mathcal{F}_p) \subset \mathcal{F}_{\mathbf{R}^m(p)}, \quad p \in \mathcal{M}'.$$

Proof of the scaling theorem (the first part of Theorem 1.1). Since p_* and f_* are hybrid conjugate in neighborhoods of their Siegel disks, there is a compact analytic renormalization operator $\mathcal{R}_2: \mathcal{U} \dashrightarrow \mathcal{B}$ from a small neighborhood of p_* in the space of quadratic polynomials to a small neighborhood of f_* , see §3.2.8. Since maps in a small neighborhood of p_* have different multipliers at their α -fixed points, the image of the slice \mathcal{U} is transverse to the lamination \mathcal{F} in a small neighborhood of f_* . (Otherwise, the multiplier map in \mathcal{U} will be a covering near the Siegel value.)

The operator \mathcal{R}_2 acts on the rotation angles of indifferent maps as R_{prm}^{km} for some $k \in \mathbb{N}$. Recall that \mathbf{R}_{prm} denotes the molecule map, §3.2.15. We claim that for every p , $\tilde{p} := \mathbf{R}_{\text{prm}}^{km}(p) \in \mathcal{M}'$, we have $\mathcal{R}_2(p) \in \mathcal{F}_{\tilde{p}}$. Indeed, let us define g_p to be the unique intersection of $\mathcal{F}_{\tilde{p}}$ with $\mathcal{R}_2(\mathcal{U})$. We define $\tilde{p} \in \mathcal{U}$ to be the preimage of g_p via \mathcal{R}_2 . The nice flower $\tilde{X}(g_p)$ lifts to the dynamical plane of \tilde{p} ; we denote the lift by $\tilde{X}(\tilde{p})$. Since \tilde{p} is a quadratic polynomial, the valuable flower $\tilde{X}(\tilde{p})$ uniquely determines \tilde{p} . Comparing the combinatorial rotation numbers at the α -fixed points, we obtain $\tilde{p} = \mathbf{R}_{\text{prm}}^{-km}(p)$.

Since the holonomy along \mathcal{F} is asymptotically conformal [L3, Appendix 2, The λ -lemma (quasi-conformality)], the hyperbolicity of \mathcal{R} and the holonomy along \mathcal{F} imply the scaling result. \square

9.2. Homoclinic configuration. Recall that the operator $\mathcal{R}_{\text{QL}}^{\bullet 2}: \mathcal{N}_n \rightarrow \text{QL}$ and $\mathcal{R}_{\text{QL}}^{\bullet 3}: \mathcal{N}_n \rightarrow \text{QL}$ on a neighborhood of \mathcal{F}_n are defined by (9.5). Set

- $\mathcal{R}_{\text{QL}}^{\bullet 2}(g) := \mathcal{R}_{\text{QL}}^{\bullet 2} \circ \mathcal{R}^{n-m}(g)$ for $g \in \mathcal{F}_m$ with $m \leq n$;
- $\mathfrak{R} = \mathcal{R}_{\text{QL}}^{\bullet 3} := \mathcal{R}_{\text{QL}} \circ \mathcal{R}_{\text{QL}}^{\bullet 2}$, and
- $\mathcal{M} \setminus \{\text{cusp}\} := \mathcal{R}_{\text{QL}}^{\bullet 3}(\mathcal{M}_n \setminus \{\text{cusp}\}) = \mathcal{R}_{\text{QL}}^{\bullet 3}(\mathcal{M}_m \setminus \{\text{cusp}\})$,

where \mathcal{R}_{QL} is the quadratic-like operator, see §3.1.1. By Theorem 7.9, \mathcal{M} is a copy of the Mandelbrot set, and $\chi: \mathcal{M} \rightarrow \mathcal{M}$ is the canonical straightening homeomorphism. Note that the renormalization change of variables of $\mathcal{R}_{\text{QL}}^{\bullet 3} | \mathcal{F}_n$ is linear, but the renormalization change of variables of $\mathcal{R}_{\text{QL}}^{\bullet 3} | \mathcal{F}_m$ is non-linear for $m < n$.

By construction and (9.6),

$$(9.9) \quad \chi \circ \mathcal{R}_{\text{QL}}^{\bullet 3}(g) = \mathbf{R}_{\text{QL}}^3 \circ \chi_{\text{Pacm}}(g), \quad g \in \mathcal{F}.$$

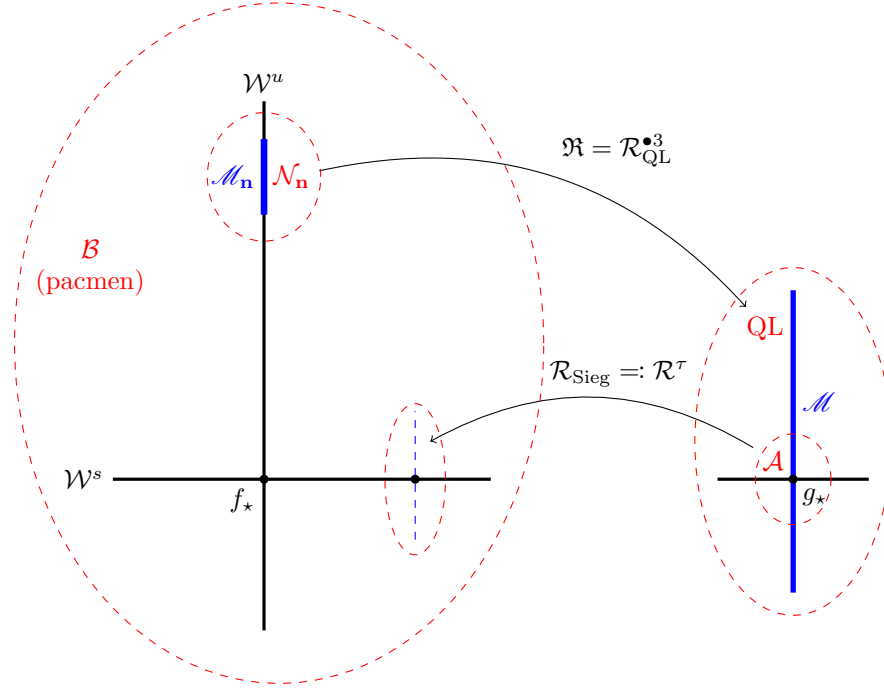

FIGURE 45. The space of pacmen \mathcal{B} , the quadratic-like renormalization operator $\mathcal{R}_{\text{QL}}^{\bullet 3}: \mathcal{N}_{\mathbf{n}} \rightarrow \text{QL}$ defined on a neighborhood of $\mathcal{M}_{\mathbf{n}} \setminus \{\text{cusp}\}$, and a Siegel renormalization operator $\mathcal{R}_{\text{Sieg}}: \mathcal{A} \rightarrow \mathcal{B}$ defined on a neighborhood \mathcal{A} of g_{\star} .

9.2.1. *Extension of \mathcal{F} .* Denote by $g_{\star} \in \mathcal{M}$ the unique Siegel map on the main hyperbolic component of \mathcal{M} such that g_{\star} is hybrid equivalent to f_{\star} . Equivalently, $\chi(g_{\star}) = p_{\star} = \chi_{\text{Pacm}}(f_{\star})$. By §3.2.8, there is a compact analytic renormalization operator $\mathcal{R}_{\text{Sieg}}: \mathcal{A} \rightarrow \mathcal{B}$, where \mathcal{A} is a Banach neighborhood of g_{\star} , see Figure 45.

Lemma 9.4. *The stable lamination \mathcal{F} admits a pullback via $\mathcal{R}_{\text{Sieg}}$. For all sufficiently big $m < 0$, all leaves of the lamination $\mathcal{R}_{\text{Sieg}}^*(\mathcal{F}_m)$ transversally intersect \mathcal{M} .*

Proof. By the same argument as in Lemma 9.3, $\mathcal{R}_{\text{Sieg}}^*(\mathcal{F})$ is a lamination with complex-analytic leaves.

Let W' be a small neighborhood of g_{\star} in $\mathcal{R}_{\text{QL}}^{\bullet 3}(W^u)$. Then W^s transversally intersects $\mathcal{R}_{\text{Sieg}}(W')$ at $\mathcal{R}_{\text{Sieg}}(g_{\star})$. Since \mathcal{F} forms a lamination, all the leaves of \mathcal{F}_m transversally intersect $\mathcal{R}_{\text{Sieg}}(W')$ for $m \ll \mathbf{n}$. Taking the pullback, we obtain that the leaves of $\mathcal{R}_{\text{Sieg}}^*(\mathcal{F}_m)$ transversally intersect W' . Clearly, all the points in the intersections are within the non-escaping set \mathcal{M} . \square

Let us extend the lamination \mathcal{F} by adding $\mathcal{R}_{\text{Sieg}}^*\mathcal{F}$ to \mathcal{F} . The operator $\mathcal{R}_{\text{Sieg}}$ acts on the rotation numbers of indifferent pacmen as $R_{\text{prm}}^{m\tau}$ for some $\tau \geq 1$. Let us view $\mathcal{R}_{\text{Sieg}}$ as \mathcal{R}^{τ} . We factorize $\mathcal{R}_{\text{Sieg}}$ as a composition of τ operators, each operator acts on the rotation numbers of indifferent maps as R_{prm}^m . With this convention, the lamination \mathcal{F} naturally extends to \mathcal{A} . Namely, for every \mathcal{F}_p in \mathcal{F}_m with $m \leq \mathbf{n} - \tau$,

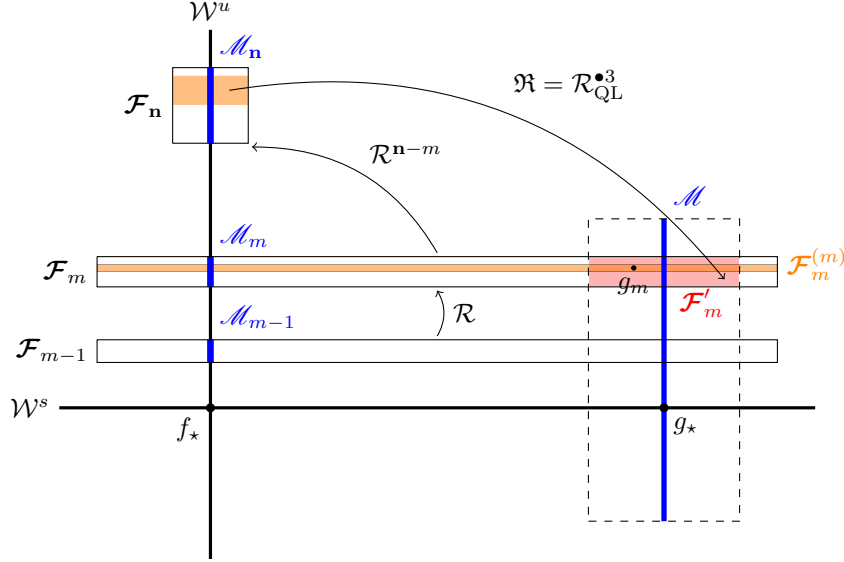

FIGURE 46. Homoclinic dynamics: the operator \mathfrak{R} has a unique hyperbolic fixed point $g_m \in \mathcal{F}_m$. (Note that we slightly simplified the picture and made leaves in \mathcal{F} connected, see (9.10).)

we define \mathcal{F}'_p to be the preimage of $\mathcal{F}_{\mathcal{R}_{\text{prim}}^{\tau}(p)}$ under $\mathcal{R}_{\text{Sieg}}$, and we set

$$(9.10) \quad \mathcal{F}_p := \mathcal{F}_p \cup \mathcal{F}'_p.$$

Similarly, \mathcal{F} is extended to $\mathcal{R}^i(\mathcal{A})$ for $i < \tau$. The new extended lamination \mathcal{F} is still \mathcal{R} -invariant.

9.2.2. *Hyperbolic horseshoe.* Let p be a hyperbolic fixed point of a C^2 -smooth diffeomorphism. If the stable and unstable manifolds W^s and W^u of p intersect, then any point $q \in W^s \cap W^u$ is called *homoclinic* to p . If the intersection is transversal, then there is a hyperbolic set in a neighborhood of the orbit of q union p , see [PT, Chapters 1, 2] for reference. We will now adopt this principle to show that there is a hyperbolic renormalization horseshoe of \mathfrak{R} near $g_* \in W^s \cap \mathfrak{R}(W^u)$, where $\mathfrak{R}(W^u)$ can be viewed as an extension of W^u .

Let \mathcal{F}'_m be \mathcal{F}_m intersected with a small neighborhood of \mathcal{M} , see Figure 46. We define $\mathcal{F}_n^{(m)}$ to be the preimage of \mathcal{F}'_m under $\mathfrak{R} | \mathcal{F}_n$, and we define $\mathcal{F}_k^{(m)} \subset \mathcal{F}_k$ to be the preimage of $\mathcal{F}_n^{(m)}$ under \mathcal{R}^{n-k} (extended to a neighborhood of g_* as above).

Lemma 9.5 (The second part of Theorem 1.1: **rigidity**). *For $k \ll n$ the operator*

$$(9.11) \quad \mathfrak{R}: \bigcup_{m,k \leq k} \mathcal{F}_m^{(k)} \rightarrow \bigcup_{m \leq k} \mathcal{F}'_m$$

is uniformly hyperbolic. More precisely, let \mathcal{H} be the non-escaping set of (9.11); i.e. the set of points with bi-infinite orbit. Then \mathcal{H} is a hyperbolic set. Let \mathbf{H} be the non-escaping set of

$$\mathcal{R}_{QL}^3: \bigcup_{t \leq k} \mathcal{M}_t \rightarrow \bigcup_{t \leq k} \mathcal{M}_t.$$

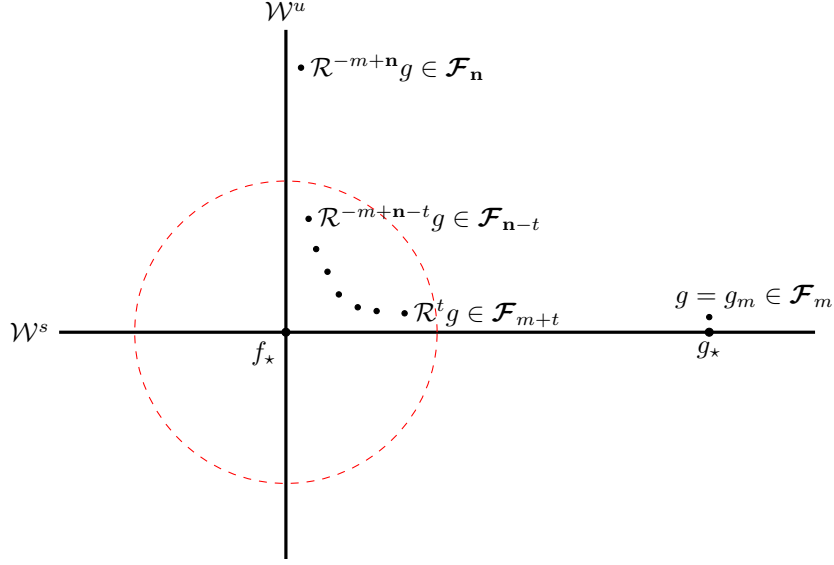

FIGURE 47. The orbit of $g \in \mathcal{F}_m$ stays within a small neighborhood of f_* for many iterates.

Then

- every connected component of \mathbf{H} is a singleton; and
- $\mathfrak{R}: \mathcal{H} \rightarrow \mathcal{H}$ is parametrized by the natural extension of $\mathbf{R}_{\text{QL}}^3: \mathbf{H} \rightarrow \mathbf{H}$ via χ_{Pacm} .

In particular, $\mathfrak{R}: \mathcal{F}_m^{(m)} \rightarrow \mathcal{F}'_m$ has a unique hyperbolic fixed point $g_m \in \mathcal{F}_m^{(m)} \cap \mathcal{F}'_m$, see Figure 46.

Proof. This is a homoclinic configuration for the operator \mathcal{R} combined with the “gluing” operators $\mathcal{R}_{\text{QL}}^3: \mathcal{N}_n \rightarrow \text{QL} \supset \mathcal{A}$ and $\mathcal{R}_{\text{Sieg}}: \mathcal{A} \rightarrow \mathcal{B}$, see Figure 45. A point g_* has a forward infinite orbit along \mathcal{W}^s towards f_* and it has a backward infinite orbit along \mathcal{W}^u towards f_* . Therefore, the non-escaping set in a small neighborhood of $\{f_*\} \cup \text{orb}(g_*)$ is hyperbolic, see [PT, Theorem 1 in §7, Chapter 2]. (In short, since the orbit of $\mathcal{F}_m^{(k)}$ stays in a small neighborhood of f_* for most of the iterations (Figure 47), the map $\mathcal{F}_m^{(k)} \rightarrow \mathcal{F}'_m$ has a big contraction in the horizontal direction and big expansion in the vertical direction.) Considering the first return map to a neighborhood of g_* , we obtain that (9.11) is hyperbolic.

We have a natural surjective semi-conjugacy π from $\mathfrak{R}: \mathcal{H} \rightarrow \mathcal{H}$ to the natural extension of $\mathbf{R}_{\text{QL}}^3: \mathbf{H} \rightarrow \mathbf{H}$. Since ε -close orbits for a hyperbolic map coincide, π is a homeomorphism and every connected component of \mathbf{H} is a singleton. \square

Theorem 1.1: proof of JLC. Local connectivity of every map in \mathcal{H} follows (see §3.1.3) from unbranched *a priori* bounds:

Lemma 9.6. *Every map in \mathcal{H} has unbranched a priori bounds.*

Proof. Recall that we constructed a homoclinic configuration under the renormalization illustrated in Figure 46, a certain neighborhood of g_* , and the hyperbolic

horseshoe $\mathfrak{R}: \mathcal{H} \curvearrowright$ for the first return map to this neighborhood of g_* . Every map $f \in \mathcal{H}$ before it returns to \mathcal{H} travels through a small neighborhood of \mathcal{M}_n unbranched a priori bounds holds for the associated quadratic-like map (9.5). Since the renormalization change of variables is conformal, unbranched a priori bounds descends to all deep scales, see §3.1.4; i.e. setting $f_{3n} := (\mathfrak{R})^n(f)$ we have unbranched a priori bounds for

$$(9.12) \quad \mathcal{R}_{\text{QL}}^{\bullet 2}(f_{3n}): O(f_{3n}) \rightarrow O'(f_{3n}).$$

□

□

9.2.3. *Upper semi-continuity of the valuable flower.* Along the lines, we also obtained a geometric control of the postcritical sets of maps in \mathcal{F} . Let us write $X(f) := \bar{Z}_f$ for a Siegel map $f \in \mathcal{W}^s$. Then $X(f)$ depends upper semi-continuously on $f \in \mathcal{F}$. Moreover, if a sequence $f_n \in \mathcal{F}_n$ tends to $f \in \mathcal{W}^s$ as $n \rightarrow -\infty$, then $\mathfrak{P}(f_n)$ and $\tilde{X}_{\text{up}}(f_n)$ tend to $\partial Z_f = \mathfrak{P}(f)$. Indeed, by Theorem 8.2, the valuable flower $\tilde{X}(f_n)$ is within a certain Siegel triangulation $\Delta(f_n)$. And the wall $\mathbb{P}(f_n)$ of $\Delta(f_n)$ contains $\tilde{X}_{\text{up}}(f_n)$ – the cycle of secondary small Julia sets. Since $\Delta(f_n)$ is a full lift of $\Delta(f_{n+1})$, Lemma 3.2 implies that $\Delta(f_n)$ tends to \bar{Z}_f while $\mathbb{P}(f_n)$ tends to ∂Z_f .

The upper semi-continuity can easily be transferred to a parameter neighborhood of any Siegel map. Indeed, if g is Siegel map, then there is a hyperbolic renormalization operator \mathcal{R} around a fixed pacman f_* as above such that a certain renormalization operator $\mathcal{R}_{\text{Siegel}}$ maps a neighborhood of g to a neighborhood of f_* . Pulling back the lamination \mathcal{F} under $\mathcal{R}_{\text{Siegel}}$, we obtain the upper semi-continuity of $X(f)$ for $f \in \mathcal{R}_{\text{Siegel}}^*(\mathcal{F})$. In [DLS, Appendix C] a much stronger conjecture was stated that \mathcal{F} can be extended to a lamination parametrized by a subset of the Mandelbrot set containing the main molecule of the Mandelbrot set.

9.3. **Positive measure.** In this section we will show that for $m \ll \mathbf{k} < 0$, the Julia set of $g := g_m: U \rightarrow V$ has positive measure. The result essentially follows from the Koebe-type estimates in [AL2, §§6.6–6.8], but we need to adjust them to our setting.

Let us give a **short outline**. By construction, $g_m = \mathfrak{R}(g_m)$ is a renormalization fixed point (see §3.1.4): it is conformally conjugate to its quadratic-like renormalization $g_\bullet = g^{t(m)}: U_\bullet \rightarrow V_\bullet$. As $m \rightarrow -\infty$, the map $g_m: U \rightarrow V$ tends to the Siegel map $g_*: U_* \rightarrow V_*$ so that the valuable flower $X(g_m)$ approximates the Siegel disk $\bar{Z}(g_*)$. This will allow us to construct in the dynamical plane of g_m “trapping disks” D_0, \dots, D_s with $s \rightarrow \infty$ as $m \rightarrow -\infty$ so that, see §9.3.3 and Figure 49:

- (I) if a point $z \in \bar{Z}(g_*)$ escapes U under iterations of g_m , then the orbit of z passes through all the D_i ;
- (II) a definite portion (independent of m, s) of D_i returns to $\bar{Z}(g_*)$;
- (III) a definite portion of D_0 maps to U_\bullet .

Namely, trapping disks satisfying (I) and (II) exist in the dynamical plane of f_* ; let us choose one such disk D close to Z_{f_*} . Since the renormalization orbit $\mathcal{R}^i g_m$ has many iterations in a small neighborhood of f_* (Figure 47), we can lift D from the dynamical plane of $\mathcal{R}^i g_m$ to the dynamical plane of g_m . Different lifts will be in different renormalization scales. Disk D_0 is the lift of D from the dynamical plane

of $\bar{g} := \mathcal{R}^{-m+n-t}g \in \mathcal{F}_{n-t}$. Since \mathcal{F}_{n-t} is independent of m , (III) holds for D in the dynamical plane of \bar{g} ; lifting D we obtain (III) for $D_0(g_m)$.

Consider now the g_m -orbit of $z \in \bar{Z}(g_*)$ that escapes U . Since $s \gg 1$, (I) and (II) imply that the orbit typically passes many times through D_0 before the orbit goes through all the D_i ; in each such visit to D_0 , the orbit has a definite chance to enter U_\bullet – by (III). Therefore, the probability of z to escape U is much lower than the probability to enter U_\bullet . By [AL1] the Julia set of g_m (and hence of p_m) has positive area.

Properties (II) and (III) are proven as Properties 9.8 and 9.9. With two more ingredients (Properties 9.10 and 9.11), the Koebe distortion arguments allow us to formally justify the probability viewpoint in the same way as it was done in [AL2].

Remark 9.7. *We can re-state the positive-area argument as follows. Once a full copy of the Mandelbrot set \mathcal{M}_0 is recognized on the unstable manifold, methods of [AL2] imply that the Julia set has positive measure for the parameter associated with a sufficiently big pacman antirenormalization of \mathcal{M}_0 . In [AL2], a full primitive copy is constructed by following a certain periodic point whose orbit is close to the Siegel disk. In this paper we use puzzle techniques to recognize a full satellite copy of the Mandelbrot set. (Potentially, puzzle techniques may allow one to recognize all the existing copies on the unstable manifold, see § 6.5.)*

9.3.1. *Notations.* By saying that a set K is *well inside* a domain $D \Subset \mathbb{C}$ we mean that $K \Subset D$ with a definite $\text{mod}(D \setminus K)$. The meaning of expressions *bounded*, *comparable*, etc. is similar.

Given a pointed domain (D, β) , we say that β lies in the *middle* of D , or equivalently, that D has a *bounded shape* around β if

$$\max_{\zeta \in \partial D} |\beta - \zeta| \leq C \min_{\zeta \in \partial D} |\beta - \zeta|.$$

We set

- $g := g_m : U \rightarrow V$;
- $\mathfrak{J} := \mathfrak{J}(g)$;
- $g_\bullet = g^{t(m)} : U_\bullet \rightarrow V_\bullet$ to be the $\mathcal{R}_{\text{QL}}^3$ -pre-renormalization of g normalized so that $g_\bullet : U_\bullet \rightarrow V_\bullet$ is conformally conjugate to $g : U \rightarrow V$ (this is possible because $g = \mathfrak{R}(g)$; note that the conjugacy is not affine);
- Z is the Siegel disk of g_* and Z' is prefixed Siegel disk of g_* ;
- $\mathfrak{J}_\bullet := \mathfrak{J}(g_\bullet) \subset \mathfrak{J}$;
- “diam” and “dist” denote the Euclidean diameter and distance.

By a *hyperbolic metric*, we mean the metric of $V \setminus \bar{\mathfrak{P}}(g)$, unless specified otherwise. Since

$$g : U \setminus g^{-1}(\bar{\mathfrak{P}}(g)) \rightarrow V \setminus \bar{\mathfrak{P}}(g)$$

is a covering map, while

$$U \setminus g^{-1}(\bar{\mathfrak{P}}(g)) \hookrightarrow V \setminus \bar{\mathfrak{P}}(g)$$

is an inclusion, g expands (non-uniformly) the hyperbolic metric.

9.3.2. *Parameters η and ξ .* Let us recall from [AL1] a condition ensuring that the Julia set \mathfrak{J} of $g = g_m$ has positive area. Define

- η to be the probability for an orbit starting in U (the domain of g) to enter U_\bullet (the domain of g_\bullet),

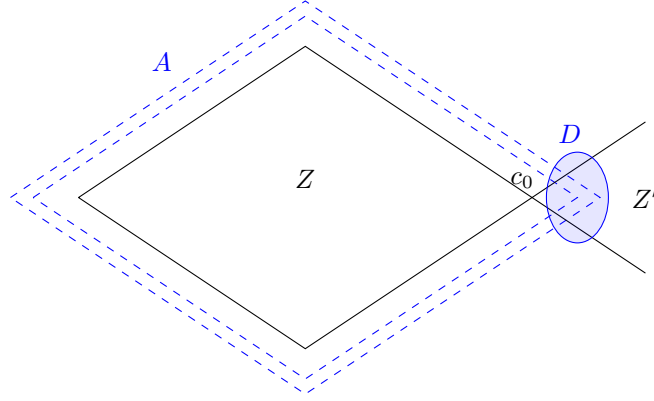

FIGURE 48. A trapping disk $D \subset \mathbb{C} \setminus \overline{Z}$: every orbit escaping from the domain surrounded by A passes through D . (The annulus A is close to ∂Z while D is close to the critical point c_0).

- ξ to be the probability that an orbit starting in $V_\bullet \setminus U_\bullet$ will never come back to U_\bullet .

There is a constant $C > 0$ independent of m such that if $\eta/\xi > C$, then the Julia set of $g = g_m$ has positive area. The constant C depends on geometric bounds (like $\text{mod}(V \setminus U)$, see [AL1, §2.7]) that are uniform over $m \ll \mathbf{k}$. We remark that the renormalization change of variables was assumed to be affine in [AL1]; but the criterion is easily relaxed for a conformal change of variables by linearizing it, see §3.1.4.

9.3.3. *Trapping disks.* Consider the dynamical plane of f_\star . Below we recall main properties of *trapping disks*; see [AL2, § 4.4.4.] for a detailed discussion. There is an annulus $A \subset \mathbb{C} \setminus \overline{Z}_\star$ in a small neighborhood of \overline{Z}_\star and a trapping disk $D \subset \mathbb{C} \setminus \overline{Z}_\star$ such that (see Figure 48)

- if z is in the bounded component O of $\mathbb{C} \setminus A$, then $f(z) \subset O \cup A$;
- if $z \in A$, then $f^i(z) \in D$ with $i \leq q$, where q depends on the renormalization scale of D (i.e., on how close D is to the critical point);
- a definite portion of D is in \overline{Z}'_\star .

Moreover, all the properties still hold under small shrinking of A and D . Therefore, by continuity, the trapping disk D exists in the dynamical plane of a nearby map.

Consider the orbit of g under the pacman renormalization \mathcal{R} and note that $\mathcal{R}^i g$ is close to f_\star if $i \in \{t, t+1, \dots, -m + \mathbf{n} - t\}$ with $-m + \mathbf{n} - t \gg t$, see Figure 47. For such i , consider the dynamical plane of $\bar{g} := \mathcal{R}^i g$. By continuity, D is a trapping disk for \bar{g} . Since $\tilde{X}(\bar{g})$ is in a small neighborhood of \overline{Z}_\star (by §9.2.3), A surrounds $\tilde{X}(\bar{g})$. Let ψ_0 be the renormalization change of variables from the dynamical plane of \bar{g} to the dynamical plane of g normalized so that $\psi_0(c_0(\bar{g})) = c_0(g)$, see §3.2.13. Then $D' := \psi_0(D)$ is a trapping disk for g with the property that every escaping orbit starting in $\tilde{X}(g)$ passes through D' . Since i can be chosen between t and $-m + \mathbf{n} - t$, we can construct pairwise disjoint trapping disks

$$D_0, D_1, \dots, D_s$$

in the dynamical plane of g , where \mathbf{s} is sufficiently big (if $m \leq \mathbf{k} \ll \mathbf{n}$ is sufficiently big), see Figure 49. We assume that D_0 is the lift of $D(\mathcal{R}^{-m+\mathbf{n}-t}g)$.

Property 9.8. *All trapping disks D_i are within $\mathbb{C} \setminus \mathfrak{P}$. For every $i \leq \mathbf{s}$, a definite portion of D_i maps to $\overline{Z}(g_*)$ under one iteration.* \square

Property 9.9. *There are degree two iterated preimages $U'_\bullet, V'_\bullet \subset D_0$ of U_\bullet and V_\bullet such that U'_\bullet and V'_\bullet occupy a definite portion (i.e. independent of m ,) of D_0 .*

Proof. Since $\bar{g} = \mathcal{R}^{-m+\mathbf{n}-t}(g) \in \mathcal{F}_{\mathbf{n}-t}$ where $\mathcal{F}_{\mathbf{n}-t}$ is independent of m , the property holds in the dynamical plane of \bar{g} for $D(\bar{g})$ and the associated quadratic-like renormalization of \bar{g} . Lifting $D(\bar{g})$ to $D_0(g)$, we obtain the property for g . \square

9.3.4. *Estimating η .* (Similar to [AL2, Proposition 6.22].) As a consequence of Property 9.9, for any point z whose orbit passes through the first trapping disk D_0 under the iterates of g , there exist quasidisks $U_\bullet(z) \subset V_\bullet(z)$ with bounded shape whose size is comparable with $\text{dist}(z, V(z))$, and such that

$$f^n(U_\bullet(z)) \subset U_\bullet \text{ and } f^n(V_\bullet(z)) \subset V_\bullet \text{ for some } n = n(z).$$

As a corollary, the landing probability η is bounded below uniformly in m . Indeed, it is known that almost every point in \mathfrak{J} lands in \mathfrak{J}_\bullet , [L1]. Since the Siegel disk $Z(g_*)$ occupies a certain area, it is sufficient to check that a definite portion of points $z \in Z(g_*) \setminus \mathfrak{J}$ land in U_\bullet . But any point $z \in Z(g_*) \setminus \mathfrak{J}$ on its way from $Z(g_*)$ to $V \setminus U$ must pass through the first trapping disk D_0 . Since $U_\bullet(z)$ occupies a definite portion of some neighborhood of z , the statement follows.

9.3.5. *Expansion of $g \mid (D_i \setminus g^{-1}(\mathfrak{P}))$.* In this subsection we will verify the following properties:

Property 9.10 (similar to [AL2, (6.9)]). *The hyperbolic diameter of D_i is uniformly (in i and m) bounded.*

Property 9.11 (similar to [AL2, §6.2.2.]). *The map $g \mid (D_i \setminus g^{-1}(\overline{\mathfrak{P}}))$ is uniformly expanding with respect to the hyperbolic metric of $V \setminus \overline{\mathfrak{P}}(g)$.*

Property 9.11 has the following explanation. Consider the dynamical plane of the Siegel map g_* . Let $x \notin \overline{Z} \cup \overline{Z}'$ be a point close to c_0 . It was shown by McMullen [McM2] that if

$$\text{dist}(x, \overline{Z}') \leq C \text{dist}(x, \overline{Z}),$$

then g_* expands the hyperbolic metric of $\mathbb{C} \setminus \overline{Z}$ by a factor $\lambda > 1$ depending only on the constant C . Recall from §9.2.3 that for a big $m \ll \mathbf{k}$, the postcritical set $\mathfrak{P}(g_m)$ approximates $\mathfrak{P}(g_*)$. Suppose x belongs to the self-similarity scale t ; i.e. $\text{dist}(x, c_0) \asymp \mu_\star^t$. One can show that if $-t-m \gg 0$ is sufficiently big, then $\mathfrak{P}(g_m)$ is sufficiently close to ∂Z (relative to μ_\star^t) and $g = g_m$ has a definite expansion at x . Let us now proceed with the proof of Property 9.11. We need the following fact:

Property 9.12. *There is a function $\tau: \mathbb{R}_{>2} \rightarrow \mathbb{R}_{>1}$ such that*

$$\tau(r) \rightarrow 1 \quad \text{as} \quad r \rightarrow +\infty,$$

and such that the following property holds. Let S_1, S_2 be two closed connected subsets of \mathbb{C} such that

- $1 \in S_1 \cap S_2$ but $0 \notin S_1 \cup S_2$; and

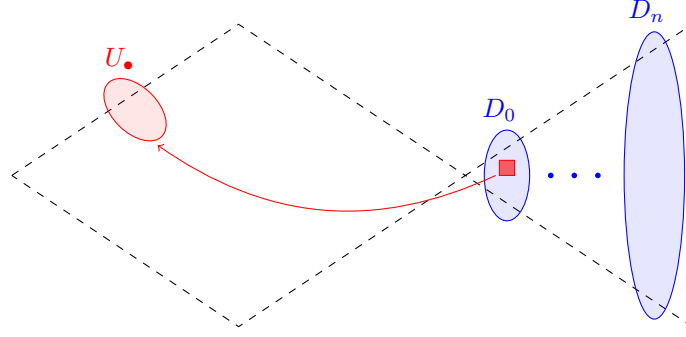

FIGURE 49. Trapping disks at different scales. A definite portion of the first trapping disk D_0 returns to U_\bullet .

- $S_1 \cap \overline{\mathbb{D}}(tr) = S_2 \cap \overline{\mathbb{D}}(tr)$ for some $t > 1$ and $r > 2$.

Let ρ_1 and ρ_2 be the hyperbolic densities of $\mathbb{C} \setminus S_1$ and $\mathbb{C} \setminus S_2$ with respect to the Euclidean metric. Then

$$\frac{1}{\tau(r)} \leq \frac{\rho_1(z)}{\rho_2(z)} \leq \tau(r) \quad \text{for } z \in \mathbb{D}(t).$$

□

Consider now a trapping disk D_i . Recall from §9.3.3 that $D_i = \psi_0(D)$, where D is the trapping disk in the dynamical plane of $\bar{g} := \mathcal{R}^{n(i)}g$ and ψ_0 is the renormalization change of variables specified so that $\psi_0(c_0(\bar{g})) = c_0(g)$.

Property 9.13. *Assuming that the trapping disk D from §9.3.3 is sufficiently close to $c_0(f_\star)$ and \bar{g} is sufficiently close to f_\star , we have:*

- (1) $\psi_0 \mid D$ is almost an isometry with respect to the hyperbolic metrics of $\mathbb{C} \setminus \overline{\mathfrak{P}}(\bar{g})$ and $V \setminus \overline{\mathfrak{P}}(g)$;
- (2) $\psi_0 \mid D$ is almost an isometry with respect to the hyperbolic metrics of $\mathbb{C} \setminus \bar{g}^{-1}(\overline{\mathfrak{P}}(\bar{g}))$ and $V \setminus g^{-1}(\overline{\mathfrak{P}}(g))$;
- (3) on D the hyperbolic metric of $\mathbb{C} \setminus \overline{\mathfrak{P}}(\bar{g})$ is almost the same as the hyperbolic metric of $\mathbb{C} \setminus \overline{\mathfrak{P}}(f_\star)$;
- (4) on D the hyperbolic metric of $\mathbb{C} \setminus \bar{g}^{-1}(\overline{\mathfrak{P}}(\bar{g}))$ is almost the same as (i.e., sufficiently close to) the hyperbolic metric of $\mathbb{C} \setminus f_\star^{-1}(\overline{\mathfrak{P}}(f_\star))$; and
- (5) on D the hyperbolic density of $\mathbb{C} \setminus f_\star^{-1}(\overline{\mathfrak{P}}(f_\star))$ is by $\lambda > 1$ smaller than the hyperbolic density of $\mathbb{C} \setminus \overline{\mathfrak{P}}(f_\star)$.

Proof. Claims 1 and 2 follow from Property 9.12: since D and $c_0 \in \overline{\mathfrak{P}}(\bar{g})$ are deep in $\text{Dom } \psi_0$ and since ψ_0 respects the postcritical sets, ψ_0 is almost an isometry.

Claims 3 and 4 follow from $\overline{\mathfrak{P}}(\bar{g}) \rightarrow \overline{\mathfrak{P}}(f_\star)$ as $\bar{g} \rightarrow f_\star$, see §9.2.3.

Claim 5 is equivalent to a strict expansion of $f_\star \mid D \setminus (f_\star^{-1}(\overline{\mathfrak{Z}'_\star}))$ with respect to the hyperbolic metric of $\mathbb{C} \setminus \overline{\mathfrak{P}}(f_\star)$. It can be proven in the same way as Lemma 5.33.

□

Proof of Properties 9.10 and 9.11 . Property 9.10 follows from Claim 1 of Property 9.13.

Applying Property 9.13, we obtain that the hyperbolic metric of $V \setminus g^{-1}(\overline{\mathfrak{P}}(g))$ is in $(\lambda - \varepsilon) > 1$ smaller than the hyperbolic metric of $V \setminus \overline{\mathfrak{P}}(g)$ uniformly in D_i . This implies Property 9.11. \square

9.3.6. *Porosity.* A gap of radius r in a set S is a round disk of radius r disjoint from S . The following lemma asserts that if a set S has density less than $1 - \epsilon$ in many scales, then it has small area.

Lemma 9.14 ([AL2, Lemma 6.23]). *For any $\rho \in (0, 1), C > 1$ and $\epsilon > 0$ there exist $\sigma \in (0, 1)$ and $C_1 > 0$ with the following property. Assume that a measurable set $S \in \overline{\mathbb{D}}(r)$ has the property that for any $z \in S$ there are n disks $\overline{\mathbb{D}}(z, r_k)$ with radii*

$$C^{-1}\rho^{\ell_k} \leq r_k/r \leq C\rho^{\ell_k}, \quad \ell_k \in \mathbb{N}, \quad \ell_1 < \ell_2 < \dots < \ell_n,$$

containing gaps in S of radii ϵr_k . Then $\text{area } S \leq C_1 \sigma^n r^2$.

9.3.7. *Estimating ξ : outline.* A point in $V_\bullet \setminus U_\bullet$ escaping U travels through each trapping disk D_i . Every D_i has a definite portion returning to Z (Property 9.8). Therefore, with high probability, a point in $V_\bullet \setminus U_\bullet$ escaping U travels through D_0 many times. Since a definite portion of D_0 returns to U_\bullet (Property 9.9), a point in $V_\bullet \setminus U_\bullet$ returns to U_\bullet with high probability.

We will use the following ingredients. Since almost every point in the Julia set is eventually in a small Julia set, it is sufficient to estimate ξ for points escaping U . By expansion, different passages through D_i create gaps in different scales (Lemma 9.17), thus Lemma 9.14 is applicable. Using area estimates, we obtain that points travel through D_0 many times with high probability (Lemma 9.20).

9.3.8. *Landing branches.* For any point z , let

$$0 \leq r_1(z) < r_2(z) < \dots < r_n(z) < \dots$$

be all the landing times of orb z at D_i , i.e. the moments at which $g^{r_n(z)}(z) \in D_i$.

Let $P^n(z)$ be the pullback of D_i along $g^{r(n)}: z \mapsto g^{r(n)}(z) \in D$. The map

$$T_{P^n(z)} = T^n := g^{r(n)}: P^n(z) \rightarrow D_i$$

is univalent. Let $\mathcal{P}(D_i)$ be the family of all domains $P = P^n(z)$. Combing the Koebe Distortion Theorem and Property 9.9, we obtain:

Property 9.15 ([AL2, Lemma 6.24]). *The following properties hold.*

- *Landing branches $T_P: P \rightarrow D_i$ with $P \in \mathcal{P}(D_i)$ have uniformly (in P and D_i) bounded distortion. The domains $P \in \mathcal{P}(D_i)$ have a bounded shape and are well inside $\mathbb{C} \setminus \overline{\mathfrak{P}}(g)$.*
- *Each domain $P \in \mathcal{P}(D_0)$ contains a pullback of V_\bullet of comparable size.*

Combining expansion with the fact that the hyperbolic density near D_i is bounded below, we obtain:

Property 9.16 ([AL2, Lemma 6.25]). *There is a constant C_0 such that the following holds. If $P \in \mathcal{P}(D_i)$ intersects D_j , then*

$$\text{diam } P \leq C_0 \text{diam } D_j.$$

The following lemma asserts that the intersecting pullbacks of $(D_i)_i$ belong to different scales. The lemma follows from the uniform expansion of $g \upharpoonright D_i$ (Property 9.11) combined with the uniform boundedness of D_i (Property 9.10) and the fact that the hyperbolic density near D_i is bounded below.

Lemma 9.17 ([AL2, Lemma 6.26]). *For any $\sigma \in (0, 1)$ there is a $\nu \in \mathbb{N}$ with the following property. Consider a point z landing at the $D_{i(t)}$ at moments r_t , where*

$$t \in \{0, 1, \dots, \nu\} \quad \text{and} \quad 0 \leq r_1 < r_2 < \dots < r_\nu,$$

and let $P^t \ni z$ be the corresponding pullback of the $D_{i(t)}$. Then

$$\text{diam } P^\nu < \sigma \text{diam } P^1.$$

9.3.9. *Truncated Poincaré series.* We need to understand how disks in $\mathcal{P}(D_0)$ intersect. Let \mathcal{P} be the set of $P \in \mathcal{P}(D_0)$ that intersect D_0 . And let \mathcal{P}^n be the set of domains $P \in \mathcal{P}(D_0)$ that can be written as $P = P^m(z)$ with $m \leq n$. In other words, the smallest landing time of P is less or equal than n .

The *truncated Poincaré series* is:

$$\phi_n(\xi) := \sum_{P \in \mathcal{P}^n} \frac{1}{|T'_P(\xi_P)|^2}, \quad \text{where } \xi_P \in P \text{ and } T_P(\xi_P) = P.$$

The following lemma follows from the Koebe Distortion Theorem, Property 9.16, and the observation that the family \mathcal{P}^n has the intersection multiplicity at most n ; the proof uses area estimates.

Lemma 9.18 ([AL2, Lemma 6.28]). *There is a constant $C > 0$ such that $\phi_n(\xi) \leq Cn$ for all $\xi \in D_0$.*

9.3.10. *Few returns to the base.* Let Σ be the set of points in $D_0 \setminus \mathfrak{J}$ that under the iterates of g never return back to D_0 .

Lemma 9.19 ([AL2, Lemma 6.30]). *For any $\sigma \in (0, 1)$ and for any natural $\tau \in \mathbb{N}$, if $m \ll \mathbf{k}$ is sufficiently big, then*

$$\text{area } \Sigma \leq C\sigma^\tau \text{area } D_0$$

Proof. Since the orbit of z escapes, it passes through all trapping disks $D_1, \dots, D_{\mathfrak{s}}$. Each D_i contains a disk W_i of bounded shape that maps to the Siegel disk $Z(g_*)$. The pullbacks of W_i create gaps of definite size (distortion theorem) and in different scales (Lemma 9.17). By Lemma 9.14, the area of Σ is small. \square

Set

$$\Sigma_n := \bigcup_{P \in \mathcal{P}^n} T_P^{-1}(\Sigma).$$

As a consequence of Lemmas 9.19 and 9.18, we have:

Lemma 9.20 ([AL2, Lemma 6.31]). *Under the assumption of Lemma 9.19, there is a constant $C > 0$ such that for any $n \in \mathbb{N}$ we have*

$$\text{area } \Sigma_n \leq Cn\sigma^\tau \text{area } D_0.$$

9.3.11. *Many returns to the base.* Set

$$\mathbb{S}^n := \bigcup_{P \in \mathcal{P} \setminus \mathcal{P}^n} P.$$

Lemma 9.21 ([AL2, Lemma 6.32]). *There exist $C > 0$ and $\sigma \in (0, 1)$ such that for any $n \in \mathbb{N}$ the area of the set of points of \mathbb{S}^n that never land in V_\bullet is at most $C\sigma^n \text{area } D_0$.*

Proof. Each time the orbit of z passes through D_0 , we have a gap of points of definite size that eventually maps to U_\bullet (Property 9.9). The gaps are in different scales (Lemma 9.17). By Lemma 9.14, the area of all such z is small. \square

9.3.12. *Estimating ξ .*

Proposition 9.22 ([AL2, Proposition 6.33]). *For any $\epsilon > 0$, if $m \ll \mathbf{k}$ is sufficiently big, then $\xi < \epsilon$.*

Proof. Let Y be the set of point in D_0 that never land at V_* . There are 3 cases:

- by [L1], $\text{area}(Y \cap \mathfrak{J}) = 0$ (because almost every point in \mathfrak{J} is eventually in small Julia sets);
- $\text{area}(Y \cap \mathbb{S}^n)$ is small by Lemma 9.21;
- the area of remaining points in Y is small by Lemma 9.20.

We can now transfer the escaping density estimate for D_0 to the escaping density estimate for $V_\bullet \setminus U_\bullet$, see the argument in [AL2, Proposition 6.33]. \square

CONVENTIONS AND NOTATIONS

Basic conventions. We set:

- $\overline{\mathbb{D}}(a, r)$ to be the closed disk around $a \in \mathbb{C}$ with radius r ;
- $\overline{\mathbb{D}}(r) := \overline{\mathbb{D}}(0, r)$ and $\overline{\mathbb{D}} := \overline{\mathbb{D}}(0, 1)$;
- $T_c: z \mapsto z + c$ is the translation by $c \in \mathbb{C}$;
- $A_c: z \mapsto cz$ is the scaling by $c \in \mathbb{C} \setminus \{0\}$.

A *simple arc* is an embedding of a closed interval. We often say that a simple arc $\ell: [0, 1] \rightarrow \mathbb{C}$ connects $\ell(0)$ and $\ell(1)$. A *simple closed curve* or a *Jordan curve* is an embedding of the unit circle. A *simple curve* is either a simple closed curve or a simple arc.

A *closed topological disk* is a subset of a plane homeomorphic to the closed unite disk. In particular, the boundary of a closed topological disk is a Jordan curve. A *quasidisk* is a closed topological disk qc homeomorphic to the closed unit disk.

Given a subset U of the plane, we denote by $\text{int } U$ the interior of U .

Let U be a closed topological disk. For simplicity we say that a homeomorphism $f: U \rightarrow \mathbb{C}$ is *conformal* if $f|_{\text{int } U}$ is conformal. Note that if U is a quasidisk, then such an f admits a qc extension through ∂U .

A *closed sector*, or *topological triangle* S is a closed topological disk with two distinguished simple arcs γ_-, γ_+ in ∂S meeting at the *vertex* v of S satisfying $\{v\} = \gamma_- \cap \gamma_+$. Suppose further that $\gamma_-, \text{int } S, \gamma_+$ have clockwise orientation at v . Then γ_- is called the *left boundary* of S while γ_+ is called the *right boundary* of S . A closed *topological rectangle* is a closed topological disk with four marked vertices.

Consider a continuous map $f: U \rightarrow \mathbb{C}$ and let $S \subset \mathbb{C}$ be a connected set. An *f -lift* is a connected component of $f^{-1}(S)$. Let

$$x_0, x_1, \dots, x_n, \quad x_{i+1} = f(x_i)$$

be an f -orbit with $x_n \in S$. The connected component of $f^{-n}(S)$ containing x_0 is called the *pullback of S along the orbit x_0, \dots, x_n* .

Consider two partial maps $f: X \dashrightarrow X$ and $g: Y \dashrightarrow Y$. A homeomorphism $h: X \rightarrow Y$ is *equivariant* if

$$(9.13) \quad h \circ f(x) = g \circ h(x)$$

for all x with $x \in \text{Dom } f$ and $h(x) \in \text{Dom } g$. If (9.13) holds for all $x \in T$, then we say that h is *equivariant on T* .

We often write a partial map as $f: W \dashrightarrow W$; this means that $\text{Dom } f \cup \text{Im } f \subset W$.

By a *tree* in an open set $U \subset \mathbb{C}$ we mean an increasing union of finite trees $T_1 \subset T_2 \subset \dots$ such that $T_i \setminus T_{i-1}$ does not intersect any given compact subset of U for $i \gg 0$. A *forest* and a *graph* are defined similarly.

To keep notations simple, we will often suppress indices. For example, we denote a pacman by $f: U_f \rightarrow V$, however a pacman indexed by i is denoted as $f_i: U_i \rightarrow V$ instead of $f_i: U_{f_i} \rightarrow V$.

Slightly abusing notations, we will often identify a lamination (or a triangulation) with its support. Given a triangulation Δ , we denote by $\Delta(i)$ its i -th triangle;

$\Delta(i, i+1, \dots, i+j)$ denotes the union $\bigcup_{k=0}^j \Delta(i+k)$.

Renormalizations. We will usually denote an analytic renormalization operator as “ \mathcal{R} ”, i.e. $\mathcal{R}f$ is a renormalization of f obtained by an analytic change of variables. A renormalization postcomposed with a straightening will be denoted by “ \mathbf{R} ”; for example, $\mathbf{R}_s: \mathcal{M}_s \rightarrow \mathcal{M}$ is the Douady-Hubbard straightening map from a small copy \mathcal{M}_s of \mathcal{M} to the Mandelbrot set. The action of the renormalization operator on the rotation numbers will be denoted by “ \mathcal{R} ”.

Rotations. Combinatorial aspects of rotations are discussed in Section 2. The main notations:

- $\mathbf{e}: z \mapsto e^{2\pi iz}$;
- $\mathbb{L}_\theta: \mathbb{D} \rightarrow \mathbb{D}$, $z \rightarrow \mathbf{e}(\theta)z$, (2.1);
- $R_{\text{prm}}: \mathbb{R}/\mathbb{Z} \hookrightarrow \mathbb{R}/\mathbb{Z}$ is the prime renormalization on rotation angles (2.3);
- \mathfrak{m} is the renormalization period: $\theta_\star = R_{\text{prm}}^{\mathfrak{m}}(\theta_\star)$, §2.1.1, (3.3);
- \mathfrak{M} is the antirenormalization matrix, (2.8), (4.2);
- \mathfrak{t} is the leading eigenvalue of \mathfrak{M} , §2.1.1; Lemma 2.1: $\lambda_\star = \mathfrak{t}^2 = (R_{\text{prm}}^{\mathfrak{m}})'(\theta_\star)$;
- \mathbf{a} , \mathbf{b} renormalization return times (2.4);
- \mathbb{T} is the semigroup of power-triples (2.13), §4.2.

Let $f: (W, \alpha) \rightarrow (\mathbb{C}, \alpha)$ be a holomorphic map with a distinguished α -fixed point. We will usually denote by λ the multiplier at the α -fixed point. If $\lambda = \mathbf{e}(\phi)$ with $\phi \in \mathbb{R}$, then ϕ is called the *rotation number of f* . If, moreover, $\phi = \mathfrak{p}/\mathfrak{q} \in \mathbb{Q}$, then $\mathfrak{p}/\mathfrak{q}$ is also the *combinatorial rotation number*: there are exactly \mathfrak{q} local attracting petals at α and f maps the i -th petal to $i + \mathfrak{p}$ counting counterclockwise.

Quadratic and quadratic-like families. (See §3.1.) We denote by

- \mathcal{M} is the Mandelbrot set, $\mathcal{M}_i \subset \mathcal{M}$ small copies in \mathcal{M} ;
- $\Delta \subset \mathcal{M}$ the main hyperbolic component;
- \mathcal{QL} the space of quadratic-like germs §3.1.1;
- $\mathfrak{M} \subset \mathcal{QL}$ the connectedness locus \mathcal{QL} ;
- $\mathcal{M}_i \subset \mathfrak{M}$ copies of \mathcal{M} in \mathfrak{M} , §3.1.1;
- $\mathcal{R}_{\text{QL}}: \mathcal{QL} \dashrightarrow \mathcal{QL}$ a quadratic-like analytic operator §3.1.1;
- $\chi: \mathfrak{M} \rightarrow \mathcal{M}$ the straightening;
- $\mathbf{R}_{\text{prm}}: \mathcal{M} \dashrightarrow \mathcal{M}$ the molecule map §3.2.15; acts as R_{prm} on $\partial\Delta$.

Pacmen. We denote a pacman by a lowercase letter (for example f or g), its bold capital version denotes the corresponding maximal prepacman (resp \mathbf{F} or \mathbf{G}). Objects in the dynamical planes of maximal prepacmen are often written in bold script. Objects in the parameter plane are usually written in calligraphic script.

For a pacman f we write $f_n = \mathcal{R}^n f$ if f is in the domain of \mathcal{R}^n ; in particular $f_0 = f$. If $f \in \mathcal{W}^u$, then f_n are well-defined for all $n \leq 0$. The corresponding maximal prepacmen are denoted by \mathbf{F}_n .

Renormalization fixed point and associated objects are indicated by “ \star ”, f.e. $f_\star: U_\star \rightarrow V$, \mathbf{F}_\star , \mathbf{Z}_\star . We will suppress “ \star ” in §5. For example, \mathbf{F} denotes the fixed maximal prepacman \mathbf{F}_\star in §5.

We denote by

- μ_\star and λ_\star the dynamical and parameter self-similarity constants with $|\lambda_\star| > 1$ and $|\mu_\star| < 1$;
- $A_\star = A_{\mu_\star}: z \mapsto \mu_\star z$ the dynamical scaling;
- $f_\star \in \mathcal{W}^u$ the fixed pacman: $f_\star = \mathcal{R}(f_\star)$;
- \mathbf{F}_\star is the fixed maximal prepacman; $\mathbf{F}_\star = \mathbf{F}$ in Section 5;
- c_0 and c_1 the critical point and the critical value of a pacman f ;
- Z_f is the Siegel disk of a Siegel map f ;
- $\mathcal{R}: \mathcal{B} \dashrightarrow \mathcal{B}$ is an analytic renormalization operator §3.2.6; it acts as R_{prm}^m on rotation numbers, see Lemma 3.1;
- $\mathcal{W}^s, \mathcal{W}^u \subset \mathcal{B}$ the stable and unstable manifolds of \mathcal{R} ;
- \mathcal{W}^u the space of maximal prepacmen;
- $F = (f_-, f_+)$, $\mathbf{F} = (\mathbf{f}_-, \mathbf{f}_+)$ a prepacman and a maximal prepacman §3.2.9;
- \mathbf{F}^P , $P \in \mathbb{T}$ is defined in §4.2;
- $\alpha = f(\alpha)$ is a fixed point of a pacman, Figure 1;
- $\alpha = \mathbf{F}^P(\alpha)$ is a fixed boundary point of a maximal prepacman §4.7;
- in §7 and §8, $\gamma(\mathbf{G})$ and $\delta(\mathbf{G})$ denote the periodic cycles characterizing the satellite and the secondary satellite hyperbolic components;
- Δ_n a renormalization triangulation with a wall \mathbb{T}_n §§3.2.10, 3.2.11, 4.3;
- $\text{CP}(\mathbf{F}^P)$, $\text{CV}(\mathbf{F}^P)$, $\mathfrak{P}(\mathbf{F})$ the set of critical values, critical points, the post-critical set
- $\mathfrak{F}(\mathbf{F}), \mathfrak{J}(\mathbf{F}), \text{Esc}(\mathbf{F})$ the Fatou, Julia, escaping sets §4.9;
- $\mathbf{Z} = \mathbf{Z}_\star$ the invariant Siegel disk (half-plane) of \mathbf{F}_\star ;
- $c_S(\mathbf{F}_\star)$ is the unique critical point on $\partial\mathbf{Z}_\star$ of generation $S \in \mathbb{T}$;
- \mathbf{Z}_s the lift of \mathbf{Z} along $\mathbf{F}_\star^S: c_s \mapsto 0$;
- \mathbf{L}_s and \mathbf{W}_s the limb and wake centered at \mathbf{Z}_s ;
- $\mathbf{G}^{Q(\tau)}: \mathbf{W}^1 \rightarrow \mathbf{W}$ a primary renormalization map (7.7);
- $\mathbf{W}(i, \mathbf{G})$ primary wakes; see Theorem 7.2 and §8.1;
- $\mathbf{F}_{\tau, s}^{Q(\tau, s)}: \mathbf{W}_{\tau, s}^1 \rightarrow \mathbf{W}_{\tau, s}$ a secondary renormalization map (7.9),
- $\mathfrak{J}_j, \mathfrak{J}_i$ periodic and certain preperiodic small Julia sets of the secondary renormalization, see Figure 41;
- $\mathcal{M}_0 = \mathcal{M}_{\tau, s, \ell} \subset \mathcal{W}^u$ a ternary satellite copy §7.6;
- $\mathcal{M}_n := \mathcal{R}^n(\mathcal{M}_0) \subset \mathcal{W}^u$ the renormalization orbit of \mathcal{M}_0 ;
- $\tilde{\mathbf{X}}(\mathbf{G}), \mathbf{X}(\mathbf{G})$, $\mathbf{G} \in \mathcal{W}^u$ the (enlarged) valuable flower of a maximal prepacman §8.1;
- $\tilde{X}(g), X(g)$ the (enlarged) valuable flower of a pacman $g \in \mathcal{M}_n \simeq \mathcal{M}_n$, $n \ll 0$, Theorem 8.2.

REFERENCES

- [AL1] A. Avila and M. Lyubich. Hausdorff dimension and conformal measures of Feigenbaum Julia sets. *J. of the AMS*, 21 (2008), 305–383.
- [AL2] A. Avila and M. Lyubich. Lebesgue measure of Feigenbaum Julia sets. *Annals Math.*, v. 176 (2022), 1–88.
- [ALM] A. Avila, M. Lyubich, and W. de Melo. Regular or stochastic dynamics in real analytic families of unimodal maps. *Invent. math.* v 154 (2003), 451–550.

- [BC] X. Buff and A. Cheritat. Quadratic Julia sets of positive area. *Annals Math.*, v. 176 (2012), 673–746.
- [BD] B. Branner and A. Douady. *Surgery on complex polynomials*. Holomorphic dynamics, Mexico, 1986.
- [BR] A. M. Benini and L. Rempe-Gillen. A landing theorem for entire functions with bounded post-singular sets. *GAGA*, v 30 (2020), 1465—1530.
- [BL] A. M. Benini and M. Lyubich. Repelling periodic points and landing of rays for post-singularly bounded exponential maps, *Annales de l’Institut Fourier* 64 (2014), no. 4, 1493–1520.
- [Ch] D. Cheraghi. Topology of irrationally indifferent attractors. arXiv:1706.02678.
- [CS] D. Cheraghi and M. Shishikura. Satellite renormalization of quadratic polynomials. arXiv:1509.07843.
- [DG] R. L. Devaney and L. R. Goldberg. Uniformization of attracting basins for exponential maps, *Duke Math. J.* 55 (1987), no. 2, 253–266.
- [DH1] A. Douady and J. H. Hubbard. Étude dynamique des polynômes complexes. *Publication Mathématiques d’Orsay*, 84-02 and 85-04.
- [DH2] A. Douady and J. H. Hubbard. On the dynamics of polynomial-like maps. *Ann. Sc. Éc. Norm. Sup.*, v. 18 (1985), 287 – 343.
- [DK] R. Devaney and M. Krych. Dynamics of $\exp(z)$. *Ergodic Theory Dynam. Systems* 4 (1984), no. 1, 35–52.
- [DLS] D. Dudko, M. Lyubich, and N. Selinger. Pacman renormalization and self-similarity of the Mandelbrot set near Siegel parameters. *Journal of the AMS*, 33 (2020), 653–733.
- [DS] A. Dudko and S. Sutherland. On the Lebesgue measure of the Feigenbaum Julia set. *Invent. math.*, v 221 (2020), 167—202.
- [EL] A. Eremenko and M. Lyubich. Dynamical properties of some classes of entire functions, *Ann. Inst. Fourier (Grenoble)* 42 (1992), no. 4, 989–1020.
- [Ep] A. Epstein. *Towers of Finite Type Complex Analytic Maps*. Ph.D. thesis, 1993.
- [E1] H. Epstein, Fixed points of composition operators II. *Nonlinearity*, vol. 2, (1989), 305-310.
- [E2] H. Epstein, Fixed points of the period-doubling operator, *Lecture notes*, Lausanne.
- [Er] A. Eremenko. On the iteration of entire functions. *Dynamical systems and ergodic theory (Warsaw, 1986)*, Banach Center Publ., vol. 23, PWN, Warsaw, 1989, pp. 339–345.
- [GY] D. Gaidashev and M. Yampolsky. Renormalization of almost commuting pairs. arXiv:1604.00719.
- [H] J. H. Hubbard. Local connectivity of Julia sets and bifurcation loci: three theorems of J.-C. Yoccoz. *Topological Methods in Modern Mathematics*, Proceedings of a Symposium in Honor of John Milnor’s Sixtieth Birthday, Publish or Perish, Houston, TX, 1993.
- [IS] H. Inou and M. Shishikura. The renormalization for parabolic fixed points and their perturbations. *Manuscript* 2008.
- [K] J. Kahn. A priori bounds for some infinitely renormalizable quadratics: I. Bounded primitive combinatorics. Preprint Stony Brook, # 5 (2006).
- [J] Y. Jiang. Infinitely renormalizable quadratic Julia sets. *Trans. of the AMS*, v 352 (2000), 5077–5091.
- [KL1] J. Kahn and M. Lyubich. A priori bounds for some infinitely renormalizable quadratics: II. Decorations. *Annals Sci. Ecole Norm. Sup.*, v. 41 (2008), 57–84.
- [KL2] J. Kahn and M. Lyubich. A priori bounds for some infinitely renormalizable quadratics, III. Molecules. In: “Complex Dynamics: Families and Friends”. Proceeding of the conference dedicated to Hubbard’s 60th birthday (ed.: D. Schleicher). Peters, A K, Limited, 2009.
- [L1] M. Lyubich. Typical behaviour of trajectories of a rational mapping of the sphere. *Dokl. Akad. Nauk SSSR*, v. 268 (1982), 29 - 32.
- [L2] M. Lyubich. Dynamics of quadratic polynomials, I-II. *Acta Math.*, v. 178 (1997), 185-297.
- [L3] M. Lyubich. Feigenbaum-Coulet-Tresser Universality and Milnor’s Hairiness Conjecture. *Ann. Math.*, v. 149 (1999), 319 - 420.
- [L4] M. Lyubich. *Conformal Geometry and Dynamics of Quadratic Polynomials*. Book in preparation, www.math.sunysb.edu/~mlyubich/book.pdf.
- [LP] L. Lomonaco and C. L. Petersen. On quasi-conformal (in-) compatibility of satellite copies of the Mandelbrot set: I. *Invent. math.* v 210 (2017), 615–644.
- [McM1] C. McMullen. *Renormalization and three manifolds which fiber over the circle*. Princeton University Press, 1996.

- [McM2] C. McMullen. Self-similarity of Siegel disks and Hausdorff dimension of Julia sets. *Acta Math.*, v. 180 (1998), 247–292.
- [Mi] J. Milnor. *John Local connectivity of Julia sets: expository lectures. The Mandelbrot set, theme and variations*, 67–116, London Math. Soc. Lecture Note Ser., 274, Cambridge Univ. Press, Cambridge, 2000.
- [Na] S. B. Nadler, Jr. *Continuum Theory. An introduction*. Monographs and Textbooks in Pure and Applied Mathematics, 158, Marcel Dekker, New York, 1992.
- [PT] J. Palis and F. Takens. *Hyperbolicity and sensitive chaotic dynamics at homoclinic bifurcations*. Cambridge Studies in Advanced Mathematics, Vol 35. Fractal dimensions and infinitely many attractors. 1993.
- [Pe] C. Petersen. Local connectivity of some Julia sets containing a circle with an irrational rotation, *Acta Math.*, 177, 1996, 163–224.
- [Re] L. Rempe. Rigidity of escaping dynamics for transcendental entire functions. *Acta Math.* 203 (2009), no 2, 235 –267.
- [RRRS] G. Rottenfusser, J. Rückert, L. Rempe, and D. Schleicher. Dynamic rays of bounded-type entire functions, *Ann. of Math. (2)* 173 (2011), no. 1, 77–125.
- [S] M. Shishikura. The Hausdorff dimension of the boundary of the Mandelbrot set and Julia sets. *Annals Math. (2)* 147 (1998), 225–267.
- [SZ] D. Schleicher and J. Zimmer. Escaping points of exponential maps, *J. London Math. Soc. (2)* 67 (2003), no. 2, 380–400.
- [SY] M. Shishikura and F. Yang. The high type quadratic Siegel disks are Jordan domains. arXiv:1608.04106.
- [Y] B. Yarrington. *Local connectivity and Lebesgue measure of polynomial Julia sets*. Thesis, Stony Brook, 1995.