

INTERSECTION OF QUADRICS IN \mathbb{C}^n , MOMENT-ANGLE MANIFOLDS, COMPLEX MANIFOLDS AND CONVEX POLYTOPES.

ALBERTO VERJOVSKY

ABSTRACT. These are notes for the *CIME school on Complex non-Kähler geometry* from July 9th to July 13th of 2018 in Cetraro, Italy. It is an overview of different properties of a class of non-Kähler compact complex manifolds called LVMB manifolds, obtained as the Hausdorff space of leaves of systems of commuting complex linear equations in an open set in complex projective space $\mathbb{P}_{\mathbb{C}}^{n-1}$.

CONTENTS

1. Introduction	2
2. Singular holomorphic foliations of \mathbb{C}^n and $\mathbb{P}_{\mathbb{C}}^{n-1}$ given by linear holomorphic actions of \mathbb{C}^m on \mathbb{C}^n ($n > 2m$)	6
3. Examples	11
3.1. Elliptic curves	11
3.2. Compact complex tori	12
3.3. Hopf manifolds	12
3.4. Calabi-Eckmann manifolds	13
3.5. Connected sums	13
3.6. Some examples of LVM.	15
4. For $m = 1$ and $n > 3$ the manifolds N are not symplectic.	17
4.1. Compact complex tori are the only Kähler LVM manifolds	18
5. Meromorphic functions on the manifold N_{Λ}	20
6. Deformation theory	21
6.1. Small deformations	21
6.2. Rigidity and Versality for $m = 1$.	22
6.3. Global deformation theory of LVM manifolds	24
7. LVM manifolds as equivariant compactifications	27
8. Toric varieties and Generalized Calabi-Eckmann fibrations	29
9. Idea of the proof of theorem 9	31
9.1. Toy example	31
9.2. Examples	35
10. From polytopes to quadrics	38
11. From quadrics to polytopes (Associated Polytope of LVM manifolds)	39
12. Moment-angle manifolds	42
13. Flips of simple polytopes and elementary surgeries on LVM manifolds	43

14. The homology of LVM manifolds	46
15. Wall-crossing	48
16. LVMB manifolds	49
16.1. Bosio manifolds	49
17. Moment-angle manifolds and intersection of quadrics	51
Part I. Open book structures.	53
I-1. Construction of the open books.	53
I-2. Homology of intersections of quadrics and their halves.	55
I-3. The space $\tilde{\mathcal{E}}_{p,q}^m$.	56
I-4 Topology of Z and Z_+ when $k = 2$	57
Part II. Some contact structures on moment-angle manifolds	61
Acknowledgements	63
References	63

1. INTRODUCTION

The origin of the so-called LVM manifolds is the paper [52] by Santiago López de Medrano and the author of these notes. There they define and study a new infinite family of compact complex manifolds (a finite number of diffeomorphism classes for each dimension) which, except for a series of cases corresponding to complex tori, are not symplectic. The construction is based on the following principle discovered by André Heaffliger:

If \mathcal{F} is a holomorphic foliation of complex codimension m on a complex manifold M with $m \leq n = \dim_{\mathbb{C}} M$ and Σ is a C^∞ manifold of real dimension $2m$ which is transversal to \mathcal{F} then Σ is a complex manifold. Indeed it suffices to provide Σ with a holomorphic atlas from transversals to the plaques of a foliation atlas of \mathcal{F} .

The essential point is that one can obtain *non-algebraic* complex manifolds as the space of leaves of holomorphic foliations of complex *algebraic* manifolds, as long as the space of leaves is Hausdorff. In particular the foliation could be given by a holomorphic action of a complex Lie group. In fact the construction in [52] uses an explicit linear action of \mathbb{C} in \mathbb{C}^n ($n \geq 3$) which descends to a projective linear action on complex projective space $\mathbb{P}_{\mathbb{C}}^{n-1}$ and there is an open set $\mathcal{V} \subset \mathbb{P}_{\mathbb{C}}^{n-1}$ which is invariant under the action and such that every leaf (orbit) of the action is an immersed copy of \mathbb{C} or \mathbb{C}^* ; furthermore, the space of leaves of the foliation by orbits of \mathcal{V} is compact and Hausdorff and therefore it is a compact complex manifold. In some sense the set \mathcal{V} is the union of “semi-stable orbits” (or Siegel leaves) of the action in the sense of *Geometric Invariant Theory* (GIT) and is the complement of a union of projective subspaces of different dimensions. In fact \mathcal{V} is the image under the canonical projection $\mathbb{C}^n \rightarrow \mathbb{P}_{\mathbb{C}}^{n-1}$ of the set of orbits in \mathbb{C}^n that do not accumulate to the origin (a sort of Kempf-Ness condition). In a very pretty paper [19] Stéphanie Cupit-Foutou and Dan Zaffran describe how to construct the generalized family of LVMB manifolds from certain Geometric Invariant Theory (GIT) quotients.

They show that Bosio's generalization parallels exactly the extension obtained by Mumford's GIT to the more general GIT developed by Białynicki-Birula and Świecicka.

The article [52] is a continuation of the foundational papers by J. Girbau, A. Haefliger et D. Sundararaman [31] about the deformations of foliations which are transversally holomorphic. In fact, André Haefliger used these results to study in [41] the deformations of Hopf manifolds which are realized as the space of leaves of a foliation.

Another continuation of that work was obtained by Jean-Jacques Loeb and Marcel Nicolau which uses the foliation in order to describe the deformations of the Calabi-Eckmann manifolds [53].

The initial construction in [52] can be extended to the case of projective linear actions of \mathbb{C}^m for any positive integer m on $\mathbb{P}_{\mathbb{C}}^n$ as long as $n > 2m$. Then, under two assumptions related to the $n \times m$ complex matrix $\mathbf{\Lambda}$ of eigenvalues of the linear flows which determine the action one obtains new compact manifolds. These assumptions are that $\mathbf{\Lambda}$ be admissible *i.e.*, it satisfies the *weak hyperbolicity and Siegel conditions*. This was achieved by Laurent Meersseman who studies in detail several aspects of the compact manifolds in [62]. These compact complex manifolds $N_{\mathbf{\Lambda}}$ are now known as LVM manifolds. A very interesting property of these manifolds when $m > 1$ is their very rich topology. For instance, any finite abelian group is a summand of the homology group of one of these manifolds. In particular some of the manifolds have arbitrarily large torsion in its homology groups. In [12], Frédéric Bosio gives a generalization of the construction of LVM manifolds. The idea is to relax the weak hyperbolicity and Siegel conditions $\mathbf{\Lambda}$ and to look for all the subsets \mathcal{S} of \mathbb{C}^n such that action (27) in section 2 is free and proper. The manifolds that are either LVM manifolds or the generalization by Frédéric Bosio are now known as LVMB manifolds. The manifolds $N_{\mathbf{\Lambda}}$ are obtained as the orbit space of a free action of the circle on an odd-dimensional manifold $M_1(\mathbf{\Lambda})$ contained in the sphere \mathbb{S}^{2n-1} which is the intersection of homogeneous quadratic equations and called *moment-angle manifold*. Santiago López de Medrano has studied deeply these intersection of quadrics in several papers by himself and some collaborators [35, 36, 37, 48, 49, 50, 51] in particular the paper [35] by Samuel Gitler and Santiago López de Medrano has been a great advance to understand the topology of moment-angle manifolds.

The LVM manifolds are not symplectic (except when $2m + 1 = n$ when the manifolds are compact complex tori) however under an arbitrarily small deformation of $\mathbf{\Lambda}$ the manifolds $N_{\mathbf{\Lambda}}$ fiber à la Seifert-Orlik over a toric manifold (or orbifold) with fiber a compact complex torus. This is due to the following fact:

The complex manifolds $N_{\mathbf{\Lambda}}$ of complex dimension $n - m - 1$ admit a locally-free holomorphic action of \mathbb{C}^m (recall that $n > 2m$); although $N_{\mathbf{\Lambda}}$ is not Kähler, the foliation $\mathcal{G}_{\mathbf{\Lambda}}$ on $N_{\mathbf{\Lambda}}$ by the leaves of the action is transversally Kähler, in particular $\mathcal{G}_{\mathbf{\Lambda}}$ is a Riemannian foliation and thus admits a transverse invariant volume form. In particular either has a Zariski open set of noncompact leaves or else all are compact complex tori.

If $\mathbf{\Lambda}$ satisfies a rationality condition called condition \mathbf{K} in definition 12 then all the leaves of $\mathcal{G}_{\mathbf{\Lambda}}$ are compact, in fact they are complex tori \mathbb{C}^m/Γ ($\Gamma \cong \mathbb{Z}^{2m}$) and the quotient is Hausdorff. Hence it is a compact complex manifold (or an orbifold).

Furthermore, the rationality conditions \mathbf{K} in definition 12 imply that the transversal Kähler form is “integral” (a sort of transversal Kodaira embedding condition) which makes this quotient an algebraic manifold or variety with quotient singularities of dimension $n-2m-1$. In fact this quotient admits an action of $(\mathbb{C}^*)^{n-2m-1}$ with a principal dense orbit so it is a toric manifold $X(\Delta)$ where $\Delta = \Delta_{\mathbf{\Lambda}}$ is the corresponding fan which depends on $\mathbf{\Lambda}$.

The reciprocal is true as shown by the author and Laurent Meersseman [68]: If $X(\Delta)$ is a toric variety with at most singularities which are quotients then there exists an admissible configuration $\mathbf{\Lambda}$ which satisfies conditions \mathbf{K} in definition 12 and therefore any toric variety with at most quotient singularities is obtained by the quotient of a LVM manifold by a holomorphic locally-free action of a compact complex torus. In this paper one uses Delzant construction over a rational simple convex polytope which is naturally associated to the convex hull $\mathcal{H}(\mathbf{\Lambda})$ of the configuration. When the leaves of $\mathcal{G}_{\mathbf{\Lambda}}$ are not compact the leaf space is not Hausdorff and one has a “noncommutative” complex manifold in the sense of Alain Connes [21, 22]. This happens when the convex polytope $\mathcal{H}_{\mathbf{\Lambda}}$ is not rational and a convex polytope associated to the foliation $\mathcal{G}_{\mathbf{\Lambda}}$ is non-rational. There are important reasons to consider *nonrational* polytopes. For instance, toric varieties corresponding to simple rational polytopes are rigid (*i.e.*, they cannot be deformed) whereas simple rational polytopes can be perturbed simply by moving the vertices to non-rational simple polytopes. The problem of associating to a non-rational polytope a geometric space of some kind is an old one and emerges in different subjects, including symplectic geometry, via the convexity theorem and the Delzant construction. In fact it also is connected with the combinatorics of convex polytopes see for instance Stanley [76] where a link between rational simplicial polytopes and the geometry and topology of toric varieties is explained following earlier work of Peter McMullen [60] and Richard P. Stanley [77]. There are important reasons to consider *nonrational* simple polytopes and its and give them an interpretation in relation to toric geometry. In this respect the article by Elisa Prato [72] is the first work that addresses this problem via symplectic geometry and she defines the notion of *quasifolds*, which is a generalization of the notion of orbifolds and associates to a non-rational simple polytope a quasifold. In a joint paper [17] Elisa Prato and Fiammetta Battaglia generalize the notion of toric variety and associate to each non-rational simplicial polytope a Kähler quasifold and compute the Betti numbers (see also [17]). The paper by Fiammetta Battaglia and Dan Zaffran [4] uses also the leaf space of the foliation $\mathcal{G}_{\mathbf{\Lambda}}$ of the manifolds $N_{\mathbf{\Lambda}}$ to have either toric orbifolds in the rational case or quasifolds in the non-rational case. Thus the papers [4, 16, 17, 72] are foundational papers in the theory of non-rational polytopes.

In [46] a different interpretation as *non-commutative toric varieties* is given of the pair $(N_{\mathbf{\Lambda}}, \mathcal{G}_{\mathbf{\Lambda}})$ in the case $\mathbf{\Lambda}$ does not satisfy the rational condition (\mathbf{K}). Non-commutative toric varieties are to toric varieties what non-commutative tori are to tori and, as such, they can be interpreted in multiple ways: As (noncommutative) topological spaces, they are C^* -algebras associated to dense foliations, that is to say, deformations of the commutative C^* -algebras associated to tori in the spirit of Alain Connes.

However, while non-commutative tori correspond to linear foliations (deformations) on classical tori, non-commutative toric varieties correspond to the holomorphic foliation \mathcal{G}_Λ on N_Λ .

The manifolds N_Λ are certain intersections of real quadrics in complex projective spaces of a very explicit nature. The homotopy type of LVM-manifolds is described by moment angle complexes.

The paper of Frédéric Bosio and Laurent Meerseman [11] is a beautiful paper with many ideas and interconnection of several branches of mathematics. In fact the title and subject of the present notes is very much inspired on this paper.

They do a deep study of the properties of LVM manifolds and also made significant advances in the study of the topology of the intersection of k homogeneous quadrics.

In particular, the question of whether they are always connected sums of sphere products was considered: they produced new examples for any k which are so, but also showed how to construct many more cases where they are not.

Independently in [24] Michael W. Davis and Janusz Januszkiewicz had introduced new constructions, part of which essentially coincide with those above, where the main objective was the study of some important quotients of them (different from the ones mentioned above) which they called *toric manifolds* (in contrast with toric *varieties* that are algebraic). These toric manifolds are topological analogues of toric varieties in algebraic geometry. They are even dimensional manifolds with an effective action of an n -dimensional compact torus $(\mathbb{S}^1)^n$, there is a kind of “moment map” and the orbit space is a simple convex polytope. One can do combinatorics on the quotient polytope to obtain information on the manifold above. For example one can compute the Euler characteristic and describe the cohomology ring of the manifold in terms of the polytope. The paper by Davis and Januszkiewicz originated an important development through the work of many authors, for which we refer the reader to the book of Victor M. Buchstaber and Taras E. Panov [14]. A line of research derived from [24] is the paper [5] where a far-reaching generalization is made and a general splitting formula is derived that provides a very good geometric tool for understanding the relations among the homology groups of different spaces.

There is a principal circle bundle $p : M_1(\Lambda) \rightarrow N_\Lambda$ over each manifold N_Λ . The manifold $M_1(\Lambda)$ is a smooth manifold of real odd dimension $2n - 2m - 1$ called *moment-angle manifold*. The manifold $M_1(\Lambda)$ admits an action of the torus $(\mathbb{S}^1)^n$. The orbit space of this action is a convex polytope of dimension $3n - 2m - 1$ thus there is a “moment map”. In addition $M_1(\Lambda)$ has a contact structure and in many cases is an open book with a very interesting structure [9].

In the present notes we present various results and properties of LVMB manifolds:

- I. Complex analytic properties
- II. The relation between these manifolds and toric manifolds and orbifolds with quotient singularities.
- III. Their topology and geometric structures

The main body of the results presented in these notes are in part contained in the papers [9, 11, 52, 62, 68, 69].

2. SINGULAR HOLOMORPHIC FOLIATIONS OF \mathbb{C}^n AND $\mathbb{P}_{\mathbb{C}}^{n-1}$ GIVEN BY LINEAR
HOLOMORPHIC ACTIONS OF \mathbb{C}^m ON \mathbb{C}^n ($n > 2m$)

Let M be a complex manifold of complex dimension n and $0 \leq p \leq n$.

Definition 1. A holomorphic foliation \mathcal{F} of complex dimension p (or complex codimension $n - p$) is given by a *foliated atlas* $(U_\alpha, \Phi_\alpha)_{\alpha \in \mathcal{I}}$ where U_α are open in M , $\{U_i\}_{i \in \mathcal{I}}$ is an open covering of M and $\Phi_i : U_i \rightarrow V_i \subset \mathbb{C}^{n-p} \times \mathbb{C}^p = \mathbb{C}^n$ are homeomorphisms such that for overlapping pairs U_i, U_j the transition functions $\Phi_{ij} = \Phi_j \Phi_i^{-1} : \Phi_i(U_i \cap U_j) \rightarrow \Phi_j(U_i \cap U_j)$ are of the form:

$$(5) \quad \Phi_{ij}(x, y) = (\Phi_{ij}^1(x), \Phi_{ij}^2(x, y)) \quad x \in \mathbb{C}^{n-p}, \quad y \in \mathbb{C}^p$$

where Φ_{ij}^1 and Φ_{ij}^2 are holomorphic and Φ_{ij}^1 is a local biholomorphism between open sets of \mathbb{C}^{n-p} and Φ_{ij}^2 is a local holomorphic submersion from an open set in \mathbb{C}^n onto an open set of \mathbb{C}^p .

Definition 2. The atlas $(U_\alpha, \Phi_\alpha)_{\alpha \in \mathcal{I}}$ is called a *holomorphic foliation atlas* and the maps Φ_α are called *holomorphic flow boxes* or *holomorphic foliation charts*. The sets of the form $\Phi_\alpha^{-1}(\{x\} \times \mathbb{C}^p)$, $x \in \mathbb{C}^{n-p}$, *i.e.*, the set of points whose coordinates (X, Y) with $X = (x_1, \dots, x_{n-p}) \in \mathbb{C}^{n-p}$, $Y = (y_1, \dots, y_p) \in \mathbb{C}^p$ satisfy $X = C$ for some constant vector $C \in \mathbb{C}^{n-p}$ are called *plaques*. Condition (5) says that the plaques glue together to form complex submanifolds called *leaves*, which are immersed in M (not necessarily properly immersed). If $(U_\alpha, \varphi_\alpha)_{\alpha \in \mathcal{I}}$ is a complex atlas as in definition 1 the leaves are immersed p -dimensional holomorphic submanifolds of W .

The family of biholomorphisms $\{\Phi_{ij}^1\}_{i \in \mathcal{I}}$ defines a groupoid called the *transverse holonomy groupoid*. It can be used to define noncommutative toric varieties [4, 46].

Let m and n be two positive natural numbers such that $n > 2m$. Let $\mathbf{\Lambda} := (\Lambda_1, \dots, \Lambda_n)$ be an n -tuple of vectors in \mathbb{C}^m where $\Lambda_i = (\lambda_i^1, \dots, \lambda_i^m)$ for $i = 1, \dots, n$.

To the configuration $(\Lambda_1, \dots, \Lambda_n)$ we can associate the linear (singular) foliation of \mathbb{C}^n generated by the m holomorphic linear commuting vector fields ($1 \leq j \leq m$)

$$\mathbb{C}^n \ni (z_1, \dots, z_n) \longmapsto \sum_{i=1}^n \lambda_i^j z_i \frac{\partial}{\partial z_i}$$

(System of linear equations) $\frac{d\mathbf{Z}}{dT} = \begin{bmatrix} \lambda_1^j & 0 & 0 & \dots & 0 \\ 0 & \lambda_2^j & 0 & \dots & 0 \\ \dots & \dots & \dots & \dots & \dots \\ 0 & 0 & \dots & \lambda_n^j \end{bmatrix} \mathbf{Z}, \quad i.e., \quad \frac{d\mathbf{Z}}{dT} = \Lambda_j \mathbf{Z},$

$$\mathbf{Z} = \begin{bmatrix} z_1 \\ \vdots \\ z_n \end{bmatrix}, \quad j = 1, \dots, m, \quad T \in \mathbb{C}$$

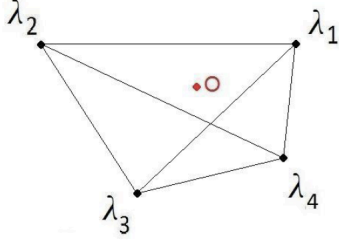
FIGURE 1. Quadrilateral in \mathbb{C}

Let us start with the construction of an infinite family of compact complex manifolds. Let m be a positive integer and n and integer such that $n > 2m$.

Definition 3. Let $\mathbf{\Lambda} = (\Lambda_1, \dots, \Lambda_n)$ be a configuration of n vectors in \mathbb{C}^m . Let $\mathcal{H}(\Lambda_1, \dots, \Lambda_n)$ be the convex hull of $(\Lambda_1, \dots, \Lambda_n)$.

We say that $\mathbf{\Lambda}$ is *admissible* if:

- (1) **(SC)** The Siegel condition: 0 belongs to the convex hull $\mathcal{H}(\mathbf{\Lambda}) := \mathcal{H}(\Lambda_1, \dots, \Lambda_n)$ of $(\Lambda_1, \dots, \Lambda_n)$ in $\mathbb{C}^m \simeq \mathbb{R}^{2m}$.
- (2) **(WH)** The weak hyperbolicity condition: for every $2m$ -tuple of integers i_1, \dots, i_{2m} such that $1 \leq i_1 < \dots < i_{2m} \leq n$ we have $0 \notin \mathcal{H}(\Lambda_{i_1}, \dots, \Lambda_{i_{2m}})$

This definition can be reformulated geometrically in the following way: the convex polytope $\mathcal{H}(\Lambda_1, \dots, \Lambda_n)$ contains 0 , but neither external nor internal facet of this polytope (that is to say hyperplane passing through $2m$ vertices) contains 0 . An admissible configuration satisfies the following regularity property

Lemma 1. Let $\Lambda'_i = (\Lambda_i, 1) \in \mathbb{C}^{n+1}$, for $i \in \{1, \dots, n\}$. For all set of integers $J \subset \{1, \dots, n\}$ such that $0 \in \mathcal{H}((\Lambda_j)_{j \in J})$ the complex rank of the matrix whose columns are the vectors $(\Lambda_j)_{j \in J}$ is equal to $m + 1$, therefore it is of maximal rank.

One considers the holomorphic (singular) foliation \mathcal{F} in projective space $\mathbb{P}_{\mathbb{C}}^{n-1}$ given by the orbits of the linear action of \mathbb{C}^m on \mathbb{C}^n induced by the linear vector fields (1).

$$(1) \quad (T, [z]) \in \mathbb{C}^m \times \mathbb{P}_{\mathbb{C}}^{n-1} \longmapsto [z_1 \cdot \exp\langle \Lambda_1, T \rangle, \dots, z_n \cdot \exp\langle \Lambda_n, T \rangle] \in \mathbb{P}_{\mathbb{C}}^{n-1}$$

where $T = (t_1, \dots, t_m) \in \mathbb{C}^m$, $[z_1, \dots, z_n]$ are projective coordinates and $\langle -, - \rangle$ is inner product $\langle Z, W \rangle = \sum_{i=1}^n z_i w_i$

One can lift this foliation to a foliation $\tilde{\mathcal{F}}$ in \mathbb{C}^n given by the linear action

$$(5) \quad (T, z) \in \mathbb{C}^m \times \mathbb{C}^n \longmapsto (z_1 \cdot \exp\langle \Lambda_1, T \rangle, \dots, z_n \cdot \exp\langle \Lambda_n, T \rangle) \in \mathbb{C}^n.$$

The so-defined foliation is singular, in particular 0 is a singular point. The behavior in the neighborhood of 0 determines two different sorts of leaves.

Definition 4. (Poincaré and Siegel leaves) Let L be a leaf of the previous foliation. If 0 belongs to the closure of L , we say that L is a *Poincaré leaf*. In the opposite case, we talk of a *Siegel leaf*.

If L is a Siegel leaf then the distance from that leaf to the origin is positive and one can show that there exists a unique point $\mathbf{z} = (z_1, \dots, z_n) \in L$ which minimizes the distance to the origin and this point satisfies

$$(2) \quad \sum_{i=1}^n \Lambda_i |z_i|^2 = 0$$

This is because the leaf L_W through the point $W = (w_1, \dots, w_n)$ in the Siegel domain is the Riemann surface

$$L_W = \{(w_1 \cdot \exp\langle \Lambda_1, T \rangle, \dots, w_n \cdot \exp\langle \Lambda_n, T \rangle) \in \mathbb{C}^n \mid T \in \mathbb{C}^m\}$$

and to minimize the (square of the) distance to the origin we see that Lagrange multipliers imply that the complex line from the origin to a point that minimizes the square of the distance must be orthogonal to the orbit at the point.

One has the following dichotomy:

i) If $0 \notin \mathcal{H}(\Lambda_1, \dots, \Lambda_n)$ then every leaf is of Poincaré type.

ii) The set of Siegel leaves is nonempty if and only if $0 \in \mathcal{H}(\Lambda_1, \dots, \Lambda_n)$

For $z = (z_1, \dots, z_n) \in \mathbb{C}^n$ let $I_z \subset \{1, \dots, n\}$ defined as follows $I_z = \{j : z_j \neq 0\}$ and let $\Lambda_{I_z} = \{\Lambda_j : j \in I_z\}$. One defines:

$$(3) \quad \mathcal{S} = \mathcal{S}_{\mathbf{\Lambda}} = \{z \in \mathbb{C}^n \mid 0 \in \mathcal{H}(\Lambda_{I_z})\}, \quad \mathcal{S} \text{ as the complement of subspaces in } \mathbb{C}^n$$

Definition 5. We define $\mathcal{V} = \mathcal{V}(\mathbf{\Lambda}) \subset \mathbb{P}^{n-1}$ to be the image of \mathcal{S} in \mathbb{P}^{n-1} under the canonical projection $\pi : \mathbb{C}^n - \{0\} \rightarrow \mathbb{P}^{n-1}$.

Let

$$(T) \quad \mathcal{T} = \mathcal{T}(\mathbf{\Lambda}) = \{z \in \mathbb{C}^n \mid z \neq 0, \sum_{i=1}^n \Lambda_i |z_i|^2 = 0\}$$

then \mathcal{T} is the set of points that realize the minimum distance in each Siegel leaf. Then \mathcal{T} meets ever Siegel leaf in exactly one point and it meets each leaf transversally. We have that $\overline{\mathcal{T}} = \mathcal{T} \cup \{0\}$ is a singular manifold with an isolated singularity at the origin. Let

$$(\dagger) \quad N = N_{\mathbf{\Lambda}} = \{[z] \in \mathbb{P}^{n-1} \mid \sum_{i=1}^n \Lambda_i |z_i|^2 = 0\} \quad \text{Equations of LVM manifolds}$$

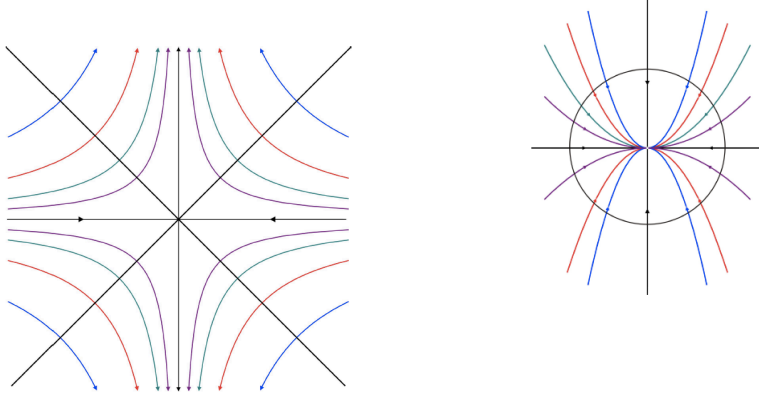

FIGURE 2. Siegel and Poincaré leaves

One can verify that \mathcal{S} is the union of the Siegel leaves and that \mathcal{S} is an open set of the form $\mathcal{S} = \mathbb{C}^n - E$ where E is an analytic set, whose different components correspond to subspaces of \mathbb{C}^n where some coordinates vanish.

The leaf space of the foliation restricted to \mathcal{S} , that we call M , or $M_{\mathbf{A}}$ if we want to emphasize \mathbf{A} , is identified with \mathcal{T} .

Since \mathcal{S} contains $(\mathbb{C}^*)^n$ we see that \mathcal{S} is dense in \mathbb{C}^n .

The weak hyperbolicity condition implies that the system of quadrics given by the preceding equations which define \mathcal{T} and N have maximal rank in every point

The Siegel condition implies that \mathcal{T} and N are nonempty. One can show also that $\tilde{\mathcal{F}}$ is regular in \mathcal{S} and that \mathcal{T} is a smooth manifold transverse to the restriction of $\tilde{\mathcal{F}}$ to \mathcal{S} . In other words the quotient space of $\tilde{\mathcal{F}}$ restricted to \mathcal{S} can be identified with \mathcal{T} .

Therefore by Haefliger's lemma 2 below \mathcal{T} has the structure on a (non-compact) complex manifold which we call M .

Also N can be identified with the quotient space of \mathcal{F} restricted to \mathcal{V} (definition 5) and therefore it inherits a complex structure. Let us denote this complex manifold by N . The complex dimension of M is $n - m$ and of N is $n - m - 1$.

The natural projection $M \rightarrow N$, induced by the projection $\pi : \mathbb{C}^n \setminus \{0\} \rightarrow \mathbb{P}_{\mathbb{C}}^{n-1}$, is in fact a principal \mathbb{C}^* fibration. Let M_1 denote the total space of the associated circle fibration It has the same homotopy type as M but it has the advantage of being compact.

Let us observe that M_1 can be identified with the transverse intersection of the cone \mathcal{T} (with the vertex at the origin delated) and the unit sphere \mathbb{S}^{2n-1} in \mathbb{C}^n . For this reason we make the following definition

Definition 6. Let

$$(4) \quad M_1 = M_1(\mathbf{\Lambda}) = \{z = (z_1, \dots, z_n) \in \mathbb{C}^n \mid \sum_{i=1}^n \Lambda_i |z_i|^2 = 0, \sum_{i=1}^n |z_i|^2 = 1\}.$$

Then $M_1(\mathbf{\Lambda})$ is called the **moment-angle** manifold corresponding to $\mathbf{\Lambda}$.

Remark 1. Let $\mathbf{\Lambda}$ be an admissible configuration. Then $N_{\mathbf{\Lambda}}$ and $N_{(A\mathbf{\Lambda}+B)}$ (with $A \in \text{GL}_m(\mathbb{C})$ and $B \in \mathbb{C}^m$) are biholomorphic (provided that $(A\mathbf{\Lambda} + B)$ is admissible and provided that the corresponding sets \mathcal{S} are the same).

Remark 2. Remark 1.5 The manifold N is naturally equipped with the principal \mathbb{C}^* -bundle $\mathcal{T} \rightarrow N$.

Remark 3. The natural projection $M_1 \rightarrow N$ is a \mathbb{S}^1 -principal bundle. It is in fact the unit bundle associated to the bundle $\mathcal{T} \rightarrow N$.

Then, the differentiable embedding of N into the projective space described yields an embedding of fibre bundles

$$\begin{array}{ccc} M_1 & \longrightarrow & \mathbb{S}^{2n-1} \\ \downarrow & & \downarrow \\ N & \longrightarrow & \mathbb{C}P^{n-1} \end{array}$$

Let us denote by ω the pull-back of the Fubini-Study Kählerian form by this embedding. The form ω is thus a closed real two-form on N which represents the Euler class of the bundle $M_1 \rightarrow N$.

Definition 7. We call ω the *canonical Euler form* of the bundle $M_1 \rightarrow N$.

Definition 8. Let $1 \leq i \leq n$. We say that Λ_i (or more briefly i) is *indispensable* if $(\Lambda_j)_{j \in \{i\}^c}$ is not admissible. Let $I \subset \{1, \dots, n\}$. We say that $(\Lambda_i)_{i \in I}$ (or more briefly I) is *removable* if $(\Lambda_j)_{j \in I^c}$ is still admissible.

Remark 4. Let $I \subset \{1, \dots, n\}$ of cardinal p . If I is removable, then the configuration $(\Lambda_i)_{i \in I^c}$ gives rise to a holomorphic LVM submanifold of $N(\Lambda_1, \dots, \Lambda_n)$ of codimension p .

Remark 5. We write $\mathcal{S}_{\mathbf{\Lambda}}$, $N_{\mathbf{\Lambda}}$, $M_1(\mathbf{\Lambda})$ etc., if we want to emphasize the configuration $\mathbf{\Lambda}$. However many times we omit $\mathbf{\Lambda}$ if it is clearly understood and no confusion is possible.

Another characterization of \mathcal{S} is the following:

$$(5) \quad \mathcal{S} = \{z \in \mathbb{C}^n \mid 0 \text{ is not in the closure of the leaf of } \tilde{\mathcal{F}} \text{ through } z\}$$

in other words \mathcal{S} is the union of the Siegel Leaves and it open and invariant under the action of \mathbb{C}^m

Remark 6. The space of Siegel leaves \mathcal{S} has the same homotopy type as M and therefore also as M_1 .

Remark 7. The linear holomorphic action of $(\mathbb{C}^*)^m$ commutes with the diagonal action (by diagonal matrices) hence $(\mathbb{C}^*)^n$ acts on M .

The open set \mathcal{S} is a deleted complex cone in \mathbb{C}^n : i.e. if $Z \in \mathcal{S}$ then $\lambda Z \in \mathcal{S}$ for all $\lambda \in \mathbb{C}^*$. Therefore $\mathcal{V} = \pi(\mathcal{S})$ (definition 5) is an open set of $\mathbb{P}_{\mathbb{C}}^{n-1}$. Then $\pi(\mathcal{T})$ is a smooth manifold of dimension equal to the codimension of \mathcal{F} and transversal to the leaves. By the following observation by André Haefliger it is a complex manifold:

Lemma 2. A. Haefliger. *Let \mathfrak{M} be a complex manifold of complex dimension $n \geq 2$ and \mathcal{F} a holomorphic foliation of \mathfrak{M} of codimension $m \geq 1$ with $n \geq m$. Let $\mathfrak{N} \subset \mathfrak{M}$ be a smooth manifold of real dimension $2m$ which is transversal to the leaves of \mathcal{F} . Then \mathfrak{N} is in a natural way a complex manifold of complex dimension m .*

Proof. In fact if $V \subset \mathfrak{M}$ is an open subset of \mathfrak{N} which is contained the domain U_α of the foliation chart $\Phi_\alpha : U_\alpha \rightarrow \mathbb{C}^m \times \mathbb{C}^{n-m}$ of \mathcal{F} then if $\hat{\Phi}_\alpha = \Phi_\alpha|_V$ is the restriction of Φ_α to V and $\pi_1 : \mathbb{C}^m \times \mathbb{C}^{n-m}$ is projection onto the first factor then $\Psi_\alpha = \pi_1 \circ \hat{\Phi}_\alpha$ is a holomorphic coordinate chart of \mathfrak{N} . Condition (2) in definition 1 implies that the coordinate changes are holomorphic. \square

Remark 8. Bogomolov has conjectured that every compact complex manifold W can be obtained by this process for a singular holomorphic foliation of projective space and W transversal to the foliation outside of the singularities. More precisely he asks: *can one embed every compact complex manifold as a C^∞ smooth subvariety that is transverse to an algebraic foliation on a complex projective algebraic variety?*

In this respect, Jean-Pierre Demailly, Hervé Gaussier [23] have shown an embedding theorem for compact almost complex manifolds into complex algebraic varieties. They show that every almost complex structure can be realized by the transverse structure to an algebraic distribution on an affine algebraic variety, namely an algebraic subbundle of the tangent bundle.

Definition 9. (LVM manifolds) If \mathbf{A} is an admissible configuration the manifold $N = N_{\mathbf{A}}$ given by formula † above is called a LVM manifold corresponding to \mathbf{A} . It is a compact complex manifold and $\dim_{\mathbb{C}} N_{\mathbf{A}} = n - m - 1$

3. EXAMPLES

3.1. Elliptic curves. In \mathbb{C} consider a non-degenerate triangle with vertices λ_1, λ_2 and λ_3 . Suppose that the origin is in the interior of this triangle. Then the open set of Siegel leaves $\mathcal{S} \subset \mathbb{C}^3$ is the complement of the three coordinate hyperplanes $z_1 = 0, z_2 = 0$ and $z_3 = 0$.

The set in $\mathcal{T} \subset \mathbb{C}^3 - \{0\}$ given by the equation:

$$(6) \quad \lambda_1|z_1|^2 + \lambda_2|z_2|^2 + \lambda_3|z_3|^2 = 0$$

is the transversal as in formula T above and it meets every leaf in \mathcal{S} in exactly one point. So that the space of leaves in \mathcal{S} can be identified with the set given by equation (6).

The set \mathcal{T} is a complex cone with the origin deleted so that if $Z \in M$ also $cZ \in \mathcal{T}$ for all $c \in \mathbb{C}^*$.

We see that $N =: N_{(\lambda_1, \lambda_2, \lambda_3)}$ is the projectivization of \mathcal{T} and therefore N can be identified as the set of points satisfying the following two equations:

$$\begin{cases} \lambda_1|z_1|^2 + \lambda_2|z_2|^2 + \lambda_3|z_3|^2 = 0 \\ |z_1|^2 + |z_2|^2 + |z_3|^2 = 1 \end{cases}$$

modulo the natural action of the circle given by

$$(z_1, z_2, z_3) \mapsto (\mu z_1, \mu z_2, \mu z_3), \quad |\mu| = 1, \quad (z_1, z_2, z_3) \in N.$$

Hence one has a free action of \mathbb{C}^* and the quotient $N := M/\mathbb{C}^*$, then a complex, compact manifold of dimension one. In fact N is an elliptic curve. In the cases where M is not simply connected (*i.e.*, when $k = 3$ and $d = n_1 = 1$), the complex structure on N can be described in terms of the defining parameters by identifying it with previous descriptions of these known manifolds, for instance when $n = k = 3$ the manifold N is diffeomorphic to the torus $\mathbb{S}^1 \times \mathbb{S}^1$. To identify the corresponding complex structure, observe that in this case $\mathcal{S} = (\mathbb{C}^*)^3$. The mapping $\exp : \mathbb{C}^3 \rightarrow \mathcal{S} = (\mathbb{C}^*)^3$ given by $\exp(\zeta_1, \zeta_2, \zeta_3) = (e^{\zeta_1}, e^{\zeta_2}, e^{\zeta_3})$ can be used to identify $N(\lambda_1, \lambda_2, \lambda_3)$ with the quotient of \mathbb{C} by the lattice generated by $\lambda_3 - \lambda_2$ and $\lambda_1 - \lambda_2$. So we have that

$N_{(\lambda_1, \lambda_2, \lambda_3)}$ is biholomorphically equivalent to the elliptic curve with modulus $\frac{\lambda_3 - \lambda_2}{\lambda_1 - \lambda_2}$.

Observe that in this case we obtain all complex structures on the torus. By choosing adequately the order of the λ_i we obtain a mapping from the Siegel domain to the Siegel upper half-plane in \mathbb{C} . Therefore *Any elliptic curve is obtained this way.*

3.2. Compact complex tori. (i) If $n = 2m + 1$, the convex hull $\{\Lambda_i\}_{i \in \{1, \dots, 2n+1\}}$ is a simplex in $\mathbb{C}^m \simeq \mathbb{R}^{2m}$.

In fact if one removes one the Λ 's then 0 is not in the complex hull of the remaining. In other words \mathcal{S} is equal to $(\mathbb{C}^*)^n$ and one can show that N is a complex torus.

Remark 9. Every compact complex torus is obtained by this process. In particular, if $n = 3$ and $m = 1$ we obtain every elliptic curve.

3.3. Hopf manifolds. (ii) If $m = 1$ let us define for $n \geq 4$

$$\Lambda_1 = 1 \quad \Lambda_2 = i \quad \Lambda_3 = \dots = \Lambda_n = -1 - i.$$

It is easy to verify that under these conditions \mathcal{S} is equal to $(\mathbb{C}^*)^2 \times \mathbb{C}^{n-2} \setminus \{0\}$. Consider the two real equations that are used to define \mathcal{T} :

$$\begin{cases} |z_1|^2 = |z_3|^2 + \dots + |z_n|^2 \\ |z_2|^2 = |z_3|^2 + \dots + |z_n|^2. \end{cases}$$

If we fix the modules of z_1 and z_2 (by the definition of \mathcal{S} they cannot be 0) the above equations imply that these modules are equal and that (z_3, \dots, z_n) belong to a sphere \mathbb{S}^{2n-5} . Therefore these equations define a manifold which is diffeomorphic to $\mathbb{S}^{2n-5} \times \mathbb{S}^1 \times \mathbb{S}^1 \times \mathbb{R}_*^+$. The manifold M_1 obtained as the intersection of \mathcal{T} and the unit sphere of \mathbb{C}^n is diffeomorphic to $\mathbb{S}^{2n-5} \times \mathbb{S}^1 \times \mathbb{S}^1$ and N is diffeomorphic to $\mathbb{S}^1 \times \mathbb{S}^{2n-5}$. In particular for $n = 4$, one has all the linear Hopf surfaces.

3.4. Calabi-Eckmann manifolds. (iii) Let $m = 1$, $n = 5$ and

$$\Lambda_1 = 1 \quad \Lambda_2 = \Lambda_3 = i \quad \Lambda_4 = \Lambda_5 = -1 - i .$$

An argument similar to the previous one shows that N is diffeomorphic to $\mathbb{S}^3 \times \mathbb{S}^3$. One obtains an example of Calabi-Eckmann of non Kähler manifolds.

Remark 10. In general one obtains complex structures in products of odd dimensional spheres $\mathbb{S}^{2r+1} \times \mathbb{S}^{2l+1}$ like in the classical Calabi-Eckmann manifolds. In fact: *Every Calabi-Eckmann manifold is obtained by this process.*

3.5. Connected sums. (iv) S. López de Medrano has shown that for the pentagon in the picture below M_1 is diffeomorphic to the connected sum of five copies of $\mathbb{S}^3 \times \mathbb{S}^4$. The complex manifold N is the quotient of this connected sum under a non-trivial action of \mathbb{S}^1 .

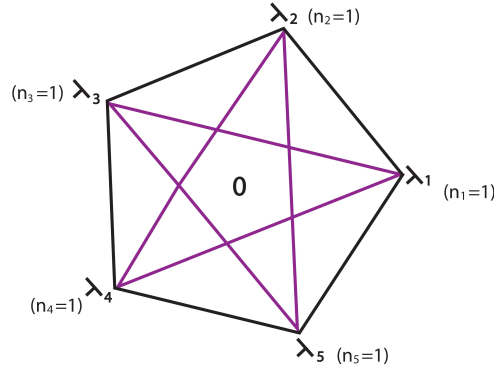

FIGURE 3. *Pentagon in \mathbb{C} . The number n_i is the multiplicity of λ_i*

When $m = 1$ it can be assumed $\mathbf{\Lambda}$ is one of the following normal forms: Take $n = n_1 + \dots + n_{2\ell+1}$ a partition of n into an odd number of positive integers. Consider the configuration consisting of the vertices of a regular polygon with $(2\ell + 1)$ vertices, where the i -th vertex in the cyclic order appears with multiplicity n_i .

The topology of M_1 and N can be completely described in terms of the numbers $d_i = n_i + \dots + n_{i+\ell-1}$, i.e., the sums of ℓ consecutive n_i in the cyclic order of the partition: For $\ell = 1$: $M_1 = \mathbb{S}^{2n_1-1} \times \mathbb{S}^{2n_2-1} \times \mathbb{S}^{2n_3-1}$. For $\ell > 1$: $M_1 = \#_{j=1}^{2\ell+1} (\mathbb{S}^{2d_i-1} \times \mathbb{S}^{2n-2d_i-2})$. See theorem 1 below.

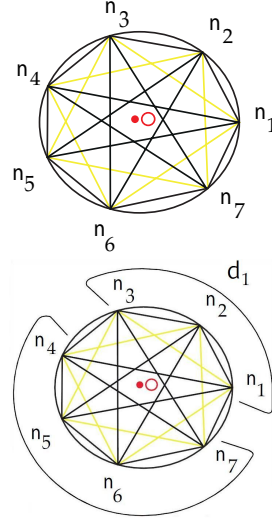

FIGURE 4. *Polygon, the number n_i is the multiplicity of λ_i*

To describe the topology of N we will use the following known facts about the topology of M_1 : First observe that the smooth topological type of M_1 (as well as that of N) does not change if we vary continuously the parameters $\mathbf{\Lambda}$ as long as we do not violate condition (WH) in definition 3 in the process. It is shown in [49] that the parameters $\mathbf{\Lambda}$ can always be so deformed until they occupy the vertices of a regular k -gon in the unit circle, where $k = 2l + 1$ is an odd integer, every vertex being occupied by one or more of the λ_i . Therefore the topology of M_1 (and that of N also) is totally described by this final configuration, which can be specified by the multiplicities of those vertices, that is, by the partition

$$n = n_1 + \cdots + n_k.$$

Observe that different partitions give different open sets \mathcal{S} and therefore also different reduced deformation spaces. It is clear that if we permute cyclically the numbers n_i we obtain again the same manifolds and deformation spaces, but it follows from the next result that the cyclic order is relevant for their description.

It is shown in [49] that the topology of M_1 is given as follows: Let $d_i = n_i + n_{i+1} + \cdots + n_{i+l-1}$ for $i = 1, \dots, k$ (the subscripts being taken modulo k). Let also

$$d = \min\{d_1, \dots, d_k\}.$$

These numbers determine the topology of M_1 :

Theorem 1. (1) If $k = 1$ then $M_1 = \emptyset$.

(2) If $k = 3$ then $M_1 = S^{2n_1-1} \times S^{2n_2-1} \times S^{2n_3-1}$.

(3) If $k = 2l + 1 > 3$ then M_1 is diffeomorphic to the connected sum of the manifolds $S^{2d_i-1} \times S^{2n-2d_i-2}$, $i = 1, \dots, k$: $M_1 = S^{2n_1-1} \times S^{2n_2-1} \times S^{2n_3-1}$. For $\ell > 1$: $M_1 = \#_{j=1}^{2\ell+1} (S^{2d_i-1} \times S^{2n-2d_i-2})$.

The proof of parts (1) and (2) is quite direct, while the proof of part (3) is long and complicated [49]. In what follows we shall only use the fact that the integral homology groups of M_1 coincide with those of the above described connected sum and the fact that M_1 is $(2d - 2)$ -connected. The homology calculations (and part (2) of Theorem 1) were first obtained by C. T. C. Wall ([80]). Thus our results will be independent of [49] and will provide a simplified proof of some of the cases of Theorem 1.

3.6. Some examples of LVM.. In all the other cases (i.e., when M_1 is simply connected) we obtain new complex structures on manifolds. An intermediate situation is given by the cases $k = 3$, with $n_1 = 2$, n_2 and n_3 even, where one can show, using the fact that each \mathbb{C}^{n_i} can be considered as a quaternionic vector space, that N is diffeomorphic to $\mathbb{P}_{\mathbb{C}}^1 \times S^{2n_2-1} \times S^{2n_3-1}$. It is easy to see that in some cases N can be identified with the product of $\mathbb{P}_{\mathbb{C}}^1$ with one of the Loeb-Nicolau complex structures on $S^{2n_2-1} \times S^{2n_3-1}$. But in other cases there is no simple way to establish such an identification, and it is plausible that these give new complex structures.

When $k = 3$, $n_1 > 2$ we definitely get a manifold which is not a product, but a twisted fibration over $\mathbb{P}_{\mathbb{C}}^{n_1-1}$. In fact, N clearly fibers over $\mathbb{P}_{\mathbb{C}}^{n_1-1}$ with fiber $S^{2n_2-1} \times S^{2n_3-1}$. This fibration does have a section (recall that we are assuming that $n_1 = d$ is not bigger than the other n_i) which is homotopic to the map $\mathbb{P}_{\mathbb{C}}^{n_1-1} \rightarrow N$ constructed in the Lemma in section 3. But, by the observation and the end of that section, the normal bundle of $\mathbb{P}_{\mathbb{C}}^{n_1-1}$ in N is stably equivalent to the normal bundle of $\mathbb{P}_{\mathbb{C}}^{n_1-1}$ in $\mathbb{P}_{\mathbb{C}}^{n-1}$. By computing the Pontryagin classes of this bundle one shows that it is not trivial. We therefore have:

Theorem 3. When $3 \leq n_1 \leq n_2 \leq n_3$ there is a non-trivial $(S^{2n_2-1} \times S^{2n_3-1})$ -fibration over $\mathbb{P}_{\mathbb{C}}^{n_1-1}$ with an $(n - 2)$ -dimensional space of complex structures.

When $k > 3$ we get new complex structures on manifolds. We will give the complete description of the underlying real smooth manifold only in the case where all $n_i = 1$ (so $n = k = 2l + 1$), where the computations and arguments are simpler. To do this we can assume as before that the λ_i are the n -th roots of unity: $\lambda_i = \rho^i$, ρ a primitive root.

In that case M_1 is a parallelizable $(2n - 3)$ -manifold with homology in the middle dimensions only, where it is free of rank n :

$$H_{n-2}(M_1) = H_{n-1}(M_1) = \mathbb{Z}^n$$

It follows from the Gysin sequence of the fibration $M_1 \rightarrow N$ (and from the order of its Euler class found in section 3) that N has homology only in dimensions $2i$, $i = 1, \dots, n - 2$ where it is free of rank 1, and in dimension $2l - 1$ where it is free of rank $2l$.

On the other hand, M_1 is the boundary of a manifold Q constructed as follows:

Let

$$Z = \{z \in \mathbb{C}^n \mid \sum \Re(\lambda_i) z_i \bar{z}_i = 0, \sum z_i \bar{z}_i = 1\}.$$

Z is diffeomorphic to $S^{2l-1} \times S^{2l+1}$ (since the defining quadratic form has index $2l$) and is the union of two manifolds with boundary

$$Q^\pm = \{z \in \mathbb{C}^n \mid \sum \Re(\lambda_i) z_i \bar{z}_i = 0, \pm \sum \Im(\lambda_i) z_i \bar{z}_i \geq 0, \sum z_i \bar{z}_i = 1\}$$

whose intersection is M_1 .

The involution of \mathbb{C}^n which interchanges the coordinates z_i and z_{n-i} preserves Z and M_1 , and interchanges Q^+ with Q^- . Therefore these two are diffeomorphic and M_1 is an equator of Z .

Let $Q = Q^+$. It follows now easily from the Mayer-Vietoris sequence of the triple $(S^{2l-1} \times S^{2l+1}, Q, Q^-)$ that $H_i(Q) = 0$ for $i \neq 2l-1, 2l$, in which case it is free of rank $l+1$ and l , respectively, and that $H_i(M_1) \rightarrow H_i(Q)$ is always surjective. Q is also simply connected by Van Kampen's Theorem. The Hurewicz and Whitehead Theorems now show that all homology classes in Q can be represented by spheres which for dimensional reasons can be assumed to be embedded in M by Whitney's imbedding theorem. (This is enough to show, using the h-cobordism theorem, that M_1 is a connected sum, as described in Theorem 1. in [49] and the argument used below. It is shown in [49] that these facts are true in general, by a detailed description of all homology classes in M_1).

The S^1 scalar action leaves Q invariant, so the quotient $R = Q/S^1$ is a compact manifold with boundary $\partial R = N$. Now the fibration $Q \rightarrow R$ again embeds in a diagram like 3 in lemma It follows now from the cohomology Gysin sequence of the fibration $Q \rightarrow R$ that $H_{2i}(R) = \mathbb{Z}$, $i = 0, \dots, l-1$ and $H_{2l-1}(R) = \mathbb{Z}^l$, all other homology groups being trivial.

Now we can embed, by lemma 3, $\mathbb{P}_{\mathbb{C}}^{l-1}$ in R representing all even dimensional homology classes, and l disjoint $(2l-1)$ -spheres with trivial normal bundle representing the generators of the corresponding homology group of R (since all these classes come from Q and are therefore spherical, and their normal bundles are again stably equivalent to the trivial normal bundle of S^{2l-1} in $\mathbb{P}_{\mathbb{C}}^{n-1}$). Taking a tubular neighborhood of these manifolds and joining them by tubes we get a manifold with boundary R' whose inclusion in R induces isomorphisms in homology groups. It follows from the h-cobordism theorem ([64]) that $N = \partial R$ is diffeomorphic to $\partial R'$ which is a connected sum of simple manifolds. These are l copies of $S^{2l-1} \times S^{2l-1}$ and the boundary of the tubular neighborhood of $\mathbb{P}_{\mathbb{C}}^{l-1}$ in R . By the remark at the end of lemma we know that the normal bundle of this inclusion is stably equivalent to the normal bundle of $\mathbb{P}_{\mathbb{C}}^{l-1}$ in $\mathbb{P}_{\mathbb{C}}^{2l}$. We have therefore proved the following

Theorem 4. *For every $l > 1$ there is a $(2l-1)$ -dimensional space of complex structures on the connected sum of $\mathbb{P}_{\mathbb{C}}^{l-1} \bar{\times} S^{2l}$ and l copies of $S^{2l-1} \times S^{2l-1}$, where $\mathbb{P}_{\mathbb{C}}^{l-1} \bar{\times} S^{2l}$ denotes the total space of the S^{2l} -bundle over $\mathbb{P}_{\mathbb{C}}^{l-1}$ stably equivalent to the spherical normal bundle of $\mathbb{P}_{\mathbb{C}}^{l-1}$ in $\mathbb{P}_{\mathbb{C}}^{2l}$.*

Observe that for $l = 2$ we get a manifold which is close, but not equal, to the one constructed by Kato and Yamada [44], where the first summand is a product. Both manifolds had been considered before, from the point of view of group actions, by Goldstein and Lininger (see [34]).

In general, these complex structures are very symmetric, in the sense that we can still find holomorphic actions of large groups on them (see [48]). In particular, there is an action of the complex, noncompact, $(n - 2)$ -torus $(\mathbb{C}^*)^{n-2}$ on them with a dense orbit. In this sense, our manifolds behave as toric varieties.

4. FOR $m = 1$ AND $n > 3$ THE MANIFOLDS N ARE NOT SYMPLECTIC.

Theorem 2. *For $n > 3$, the manifold $N = N_\Lambda$ is a compact, complex manifold that does not admit a symplectic structure.*

Proof. In fact it follows from the classification given by theorem 1 that the manifold depends on the polygon of k vertices and for $k = 1$ the manifold M_1 is empty and M_1 is a nontrivial circle bundle over N . In general we have that M_1 lies in the sphere \mathbb{S}^{2n-1} and that N sits inside the complex projective space $\mathbb{P}_{\mathbb{C}}^{n-1}$ (but not as a holomorphic submanifold), so we have an inclusion of \mathbb{S}^1 -bundles:

$$\begin{array}{ccc} M_1 & \hookrightarrow & \mathbb{S}^{2n-1} \\ \pi_1 \downarrow & & \downarrow \pi_2 \\ N & \hookrightarrow & \mathbb{P}_{\mathbb{C}}^{n-1} \end{array}$$

where π_1 and π_2 are the restrictions of the canonical map $\pi : \mathbb{C}^n \setminus \{0\} \rightarrow \mathbb{P}^{n-1}$ to M_1 and \mathbb{S}^{2n-1} respectively.

We will prove first that the inclusion of N can be deformed down in $\mathbb{P}_{\mathbb{C}}^{n-1}$ into a projective subspace of low dimension $d - 1$, but not lower. We will prove first the following:

Lemma 3. *The above inclusion of \mathbb{S}^1 -bundles embeds homotopically in the following sequence of bundle maps:*

(Diagram)

$$\begin{array}{ccccccc} \mathbb{S}^{2d-1} & \rightarrow & M_1 & \rightarrow & \mathbb{S}^{2d-1} & \rightarrow & \mathbb{S}^{2n-1} \\ \downarrow & & \downarrow & & \downarrow & & \downarrow \\ \mathbb{P}_{\mathbb{C}}^{d-1} & \rightarrow & N & \rightarrow & \mathbb{P}_{\mathbb{C}}^{d-1} & \rightarrow & \mathbb{P}_{\mathbb{C}}^{n-1} \end{array}$$

where the composition of the bottom arrows is homotopic to the natural inclusion.

Proof of lemma 3. If we put d coordinates $z_i = 0$ we obtain a new manifold $M_1(\mathbf{A}')$ where \mathbf{A}' is a configuration of eigenvalues that is concentrated in $l + 1$ consecutive vertices of the regular $(2l + 1)$ -gon. This configuration being in the Poincaré domain, it follows that the above manifold is empty.

This means that the original $M_1(\mathbf{A})$ does not intersect a linear subspace of C^n of codimension d and that correspondingly N does not intersect an d -codimensional projective subspace of $\mathbb{P}_{\mathbb{C}}^{n-1}$. Then the inclusion of N in $\mathbb{P}_{\mathbb{C}}^{n-1}$ can be deformed into a complementary projective subspace of dimension $d - 1$, which gives the middle bundle map.

Now, M_1 being $(2d - 2)$ -connected (by theorem 1), it follows that $M_1 \rightarrow N$ is a universal S^1 -bundle for spaces of dimension less than $2d - 1$ (see [75] page 19) and therefore the Hopf bundle over $\mathbb{P}_{\mathbb{C}}^{d-1}$ admits a classifying map into it, which gives the first map in the bottom row. The composition of the bottom maps also classifies this Hopf bundle and is therefore homotopic to the natural inclusion, so the Lemma is proved. From the description of M_1 it follows that M_1 is simply connected, except for the cases $k = 3, d = n_1 = 1$. In these cases the S^1 -action on $M_1 = S^1 \times S^{2n_2-1} \times S^{2n_3-1}$ can be concentrated on the first factor, and therefore N is diffeomorphic to $S^{2n_2-1} \times S^{2n_3-1}$. Unless $n_2 = n_3 = 1$ we have that $H^2(N) = 0$ and N is not symplectic.

In all the other cases we have that $d > 1$ and M_1 is 2-connected. From the cohomology Gysin sequence of the fibration $M_1 \rightarrow N$ it follows that $H^2(N) = \mathbb{Z}$ generated by the Euler class e . However, it follows from the Lemma that

$$\begin{aligned} e^{d-1} &\neq 0 \\ e^d &= 0 \end{aligned}$$

so this class does not go up to the top cohomology group $H^{2n-4}(N, \mathbb{Z})$, and it follows again that N is not symplectic, and Theorem 2 is proved. \square

Nevertheless, observe that N is a real algebraic submanifold of $\mathbb{P}_{\mathbb{C}}^{n-1}$ since it is the regular zero set of the (non holomorphic) function $g : \mathbb{P}_{\mathbb{C}}^{n-1} \rightarrow \mathbb{R}^2$ defined by

$$g([z_1, \dots, z_n]) = \frac{\sum \lambda_i z_i \bar{z}_i}{\sum z_i \bar{z}_i}$$

This implies that the normal bundle of N in $\mathbb{P}_{\mathbb{C}}^{n-1}$ is trivial. Observe also that the map $\mathbb{P}_{\mathbb{C}}^{d-1} \rightarrow N$ in the Lemma is homotopic to an embedding, whose normal bundle is then stably equivalent to the normal bundle of $\mathbb{P}_{\mathbb{C}}^{d-1}$ in $\mathbb{P}_{\mathbb{C}}^{n-1}$.

4.1. Compact complex tori are the only Kähler LVM manifolds. Let k denote the number of indispensable points (remember definition 8 above). By Carathéodory's theorem $k \leq 2m + 1$ the maximum is attained only when $n = 2m + 1$. One has:

Lemma 4. (1) $\mathcal{S} = (\mathbb{C}^*)^k \times (\mathbb{C}^{n-k} \setminus A)$ with A an analytic set of codimension at least two in every point.

(2) This decomposition descends to a decomposition $M_1 = (\mathbb{S}^1)^k \times M_0$ where M_0 is a real compact manifold which is 2-connected.

Sketch of the proof. Let $\mathcal{S} = \mathbb{C}^n \setminus E$, where E is a union of subspaces (see 3)

$$E = \{z \in \mathbb{C}^n \mid 0 \notin \mathcal{H}(\Lambda_{I_z})\}.$$

The components of codimension one are given by indices corresponding to indispensable points in the configuration. This proves the first part. Since A is of complex codimension at least 2 in every point $(\mathbb{C}^{n-k} \setminus A)$ is 2-connected, hence M_0 is 2-connected, since they have the same homotopy type. \square

In examples (ii) and (iii) one obtains compact complex manifolds which are not symplectic because the second de Rham cohomology group is trivial. This is in fact a general property of the manifolds we obtain:

Theorem 3. *Let Λ be an admissible configuration as in definition 3 and N_Λ the corresponding compact complex manifold. The the following are equivalent:*

- (1) $\mathcal{H}(\Lambda)$ is a simplex
- (2) N_Λ is symplectic.
- (3) N_Λ is Kähler.
- (4) N_Λ is a complex torus.
- (5) $n = 2m + 1$.

Sketch of the proof. It is easy to prove the equivalence of (3) and (4): If N is a complex torus, one must have $\mathcal{S} = (\mathbb{C}^*)^n$ hence all the Λ_i must be indispensable and in this case the convex hull must be a simplex and $n = 2m + 1$. If the convex hull is a simplex then as in example (i) N is a compact complex torus.

The most difficult part is that (1) implies (4). One proves that by contradiction. Suppose $n > 2m + 1$. As in the examples one must study the de Rham cohomology of N and to prove that it is incompatible with the existence of a symplectic form.

We consider two cases:

1st case There exists indispensable points. From here one can deduce that the fibration $M \rightarrow N$ is trivial. Hence the decomposition $M_1 = (\mathbb{S}^1)^k \times M_0$ of the previous lemma gives a decomposition $N = (\mathbb{S}^1)^{k-1} \times M_0$.

In other words if N has a symplectic structure it must be supported by $(\mathbb{S}^1)^{k-1}$. The maximal power of this symplectic form must be a volume form in N but that is only possible only if $k - 1$ is equal to the real dimension of N , i.e. to $2n - 2m - 2$. since $k \leq 2m + 1$ and $n > 2m + 1$

second case: If there are not indispensable points then M is 2-connected and the fibration $M \rightarrow N$ is not topologically trivial. Therefore the second de Rham cohomology group of N is generated by the Euler class of that fibration. Analyzing carefully this fibration one shows that the Euler class is trivial. Therefore this class is not symplectic, the proof is similar to that of theorem 4 \square

5. MEROMORPHIC FUNCTIONS ON THE MANIFOLD $N_{\mathbf{\Lambda}}$

Many analytic properties of LVM manifolds are related to the arithmetic properties of the configuration $\mathbf{\Lambda}$. One nice example of this fact is given by the following

Theorem 4. ([62] **Theorem 4**) *Let N be a LVM manifold without indispensable point. Then the algebraic dimension of $N_{\mathbf{\Lambda}}$ is equal to the dimension over \mathbb{Q} of the \mathbb{Q} -vector space of rational solutions of the system \mathcal{S} :*

$$(S) \quad \begin{cases} \sum_{i=1}^n s_i \Lambda_i = 0 \\ \sum_{i=1}^n s_i = 0 \end{cases}$$

The idea of the proof is very simple. If f is a meromorphic function on N , then it can be lifted to a meromorphic function \tilde{f} of \mathcal{S} which is constant along the leaves of $\tilde{\mathcal{F}}$. Since we have assumed that there is not an indispensable point lemma 8 implies that \mathcal{S} is obtained from \mathbb{C}^n by removing an analytic subspace of codimension at least two at every point. Therefore \tilde{f} can be extended to all \mathbb{C}^n by Levi's extension theorem (see [8] p.26). Furthermore \tilde{f} must be invariant by the action given in (2). In particular \tilde{f} must be invariant by the standard action of \mathbb{C}^* on $\mathbb{C}^n \setminus \{0\}$, and descends to $\mathbb{P}_{\mathbb{C}}^{n-1}$. Therefore \tilde{f} is a rational function. We can show that the fact that \tilde{f} is constant along the leaves of \mathcal{F} implies that an algebraic basis of these rational functions is given by the monomials

$$z_1^{s_1} \cdot \dots \cdot z_n^{s_n},$$

where (s_1, \dots, s_n) is a rational basis of the vector space of solutions of system (S).

Example 1. Let $n = 5$ et $m = 1$, and:

$$\Lambda_1 = 1 \quad \Lambda_2 = i \quad \Lambda_3 = -1 - i \quad \Lambda_4 = \frac{3}{2}i + 1 \quad \Lambda_5 = -i - \frac{1}{2}$$

One verifies immediately that there are not indispensable points. The complex dimension of N is 3 and its algebraic dimension is according to the preceding theorem 2. Indeed

$$f(z) = \frac{z_1^5 z_2^5 z_3^2}{z_4^6 z_5^6}, \quad g(z) = \frac{z_1 z_2^2}{z_3 z_4^2}$$

are meromorphic functions which are algebraically independent on N and in addition every meromorphic function on N depends algebraically on f and g .

Recall that a connected Moishezon manifold M is a compact complex manifold such that the field of meromorphic functions has transcendence degree equal the complex dimension of the manifold.

When theorem 4 applies the algebraic dimension of N is at most $n - 2m - 1$ therefore the dimension is strictly inferior to its dimension $n - m - 1$. In other words: if there are

not indispensable points N is not Moishezon. This happens if and only if $\mathbf{\Lambda}$ is a simplex. Hence we have the following:

Theorem 5. ([62] **Theorem 3**) *The following are equivalent:*

- (i) N is Moishezon.
- (ii) N is projective.
- (iii) N is a complex projective torus.

Sketch of the proof. We follow the proof given by Frédéric Bosio in [12] p.1276-1277. If I is a subset of $\{1, \dots, n\}$ such that 0 is in the convex envelope of $(\Lambda_i)_{i \in I}$, then the restriction of action (2) to the complex vector subspace of \mathbb{C}^n given by the equations

$$z_j = 0 \quad \text{pour } j \notin I$$

defines also a LVM manifold that we denote N_I . Then this is a complex submanifold of N . One can verify that if $n > 2m + 1$, *i.e.*, there are points that can be eliminated, one can find always submanifolds which have indispensable and in fact we can find such a submanifold with odd first Betti number. But if N is Moishezon then all of its complex subvarieties are also Moishezon and therefore must have first Betti number even. \square

Remark 11. Exactly this last argument implies that N is not Kähler if $n > 2m + 1$.

6. DEFORMATION THEORY

6.1. Small deformations. We will state without a proof a theorem of stability of LVM manifolds under small deformations. Let $\mathbf{\Lambda}$ be an admissible configuration and N the associated LVM manifold. For $\epsilon > 0$, let $(\mathbf{\Lambda}_t)_{-\epsilon < t < \epsilon}$ be a small smooth perturbation of $\mathbf{\Lambda}$ (*i.e.*, a smooth function from $(-\epsilon, \epsilon)$ to $(\mathbb{C}^m)^n$ such that $\mathbf{\Lambda}_0 = \mathbf{\Lambda} = (\Lambda_1, \dots, \Lambda_n)$).

Since the Siegel and weak hyperbolicity conditions are open in $(\mathbb{C}^m)^n$, if ϵ is sufficiently small all the configurations $(\mathbf{\Lambda}^t)$ are admissible. The manifold (ϵ, ϵ) , $\bigcup_{t \in (\epsilon, \epsilon)} N_t \subset \mathbb{P}_{\mathbb{C}}^{n-1} \times \mathbb{R}$

admits an obvious submersion over $(-\epsilon, \epsilon)$ with compact fibers. Ehresmann' lemma implies that all the N_t are diffeomorphic, however they are not necessarily biholomorphic it is enough, for instance, to start with a configuration $\mathbf{\Lambda}$ which verifies la condition **(K)** in definition 12, and to perturb it in $(\mathbb{C}^m)^n$ in order to obtain $(\mathbf{\Lambda})^t$ which verify **(H)** in 12. This way one obtains a non-trivial family of de LVM manifold $N_{\mathbf{\Lambda}}$ parametrized by the interval $(-\epsilon, \epsilon)$.

On the other hand, if $\mathbf{\Lambda}$ et $\mathbf{\Lambda}'$ are two admissible configurations such that $\mathbf{\Lambda}'$ is obtained from $\mathbf{\Lambda}$ by a complex affine transformation of \mathbb{C}^m , *i.e.*, there exists a complex affine transformation A of \mathbb{C}^m such that $\Lambda'_i = A(\Lambda_i)$ for all i , one sees immediately since $A(\mathcal{S}_{\mathbf{\Lambda}}) = \mathcal{S}'$ and A sends a Siegel leaf of the system corresponding to $\mathbf{\Lambda}$ to a leaf corresponding to $\mathbf{\Lambda}'$

Definition 10. Let $\mathbf{\Lambda}$ be an admissible configuration and $N_{\mathbf{\Lambda}}$ the corresponding LVM manifold. One calls *space of parameters* of $N_{\mathbf{\Lambda}}$ the set of equivalence classes on an open connected neighborhood of $\mathbf{\Lambda}$ in $(\mathbb{C}^m)^n$ consisting of equivalence classes of admissible configurations under the equivalence \cong given by $\mathbf{\Lambda} \cong \mathbf{\Lambda}'$ if and only if there exists a complex affine transformation A such that $A(\mathbf{\Lambda}) = \mathbf{\Lambda}'$.

The weak hyperbolicity condition implies that $\mathbf{\Lambda}$ affinely generates the space \mathbb{C}^m ([68], Lemma 1.1). Up to renumbering the vectors one can assume that $(\Lambda_1, \dots, \Lambda_{m+1})$ are affinely independent. Given a sufficiently small open connected set of configurations in $(\mathbb{C}^m)^n$ containing $\mathbf{\Lambda}$, one sees that every element in that open set can be transformed in a unique way to a configuration where the first $m + 1$ vectors coincide with those of $\mathbf{\Lambda}$. Therefore:

Lemma 5. *Let D be a space of parameters for $N_{\mathbf{\Lambda}}$. Then D can be identified with an open connected subset of $(\mathbb{C}^m)^{n-m-1}$.*

Under these conditions one can construct a holomorphic family \mathcal{D} of deformations of $N_{\mathbf{\Lambda}}$ parametrized by D . It is enough to consider the quotient of $\mathcal{S} \times D$ under the action in formula 27 with parameters in D .

Theorem 6. ([62] **Theorem 11**) *Let D be a space of parameters of the LVM manifold $N_{\mathbf{\Lambda}}$ corresponding to the configuration $\mathbf{\Lambda}$. Let $\mathcal{D} \rightarrow D$ be the associated family of deformation. Then*

- (i) *If \mathcal{S} is at least 3-connected, the family \mathcal{D} is a versal family of deformations of $N_{\mathbf{\Lambda}}$.*
- (ii) *If \mathcal{S} is at least 4-connected and $\Lambda_i \neq \Lambda_j$ if $i \neq j$, the family \mathcal{D} is universal*

Hence under rather restrictive conditions we have that all the small deformations of $N_{\mathbf{\Lambda}}$ are obtained by just perturbing the configuration $\mathbf{\Lambda}$. However this is not the general case: the Hopf surfaces don't admit a universal family.

6.2. Rigidity and Versality for $m = 1$. We consider the configuration corresponding to the regular polygon with $n = 2l + 1$ vertices (see section 3.5). Let $n = n_1 + \dots + n_k$ be an ordered partition of n with $d \geq 4$. Let $\mathbf{\Lambda} = (\lambda_1, \dots, \lambda_k)$, $\lambda_i \in \mathbb{C}$ be the admissible configuration where the multiplicity of λ_i is n_i .

Recall that the complex structure on $N(\mathbf{\Lambda})$ does not vary within the affine equivalence class of $\mathbf{\Lambda}$. We show now that the converse is true in most of the cases. These include in particular all cases with $k > 5$. It is plausible that the result is true in general.

Theorem 5. *Let $n = n_1 + \dots + n_k$ be an ordered partition of n with $d \neq 2$. Then any two collections of eigenvalues corresponding to this partition give holomorphically equivalent manifolds N if, and only if, they are affinely equivalent.*

Proof. The sufficiency of the condition was observed above. For the necessity, if $d = 1$ we are in the Calabi-Eckmann case, and this was shown by Loeb and Nicolau ([53], proposition 12). For $d > 2$ we follow their argument:

Let $V = \mathcal{S}/\mathbb{C}^*$ which is an open subset of $\mathbb{P}_{\mathbb{C}}^{n-1}$. Then the complement of V in $\mathbb{P}_{\mathbb{C}}^{n-1}$ is a union of projective subspaces whose smallest codimension is d . By the results of Scheja [74] we have that

$$H^i(V, \mathcal{O}) = H^i(\mathbb{P}_{\mathbb{C}}^{n-1}, \mathcal{O}) \text{ for } i \leq d - 2$$

where \mathcal{O}_X denotes the sheaf of holomorphic functions on a manifold. The second cohomology groups were computed by Serre and are \mathbb{C} in dimension 0 and trivial otherwise (see e.g. [30] p.118).

Now, let \mathcal{O}^{inv} be the kernel of the map $\mathcal{O} \rightarrow \mathcal{O}$ given by the Lie derivative along the vector field ξ which generates the \mathbb{C} action on V , so we have an exact sequence of sheaves:

$$0 \longrightarrow \mathcal{O}^{inv} \rightarrow \mathcal{O} \xrightarrow{L_\xi} \mathcal{O} \longrightarrow 0$$

The associated cohomology exact sequence shows that, for $d \geq 3$, $H^1(V, \mathcal{O}^{inv}) = \mathbb{C}$, but this group can be identified with $H^1(N, \mathcal{O})$. Therefore this group is also \mathbb{C} and since it classifies the principal \mathbb{C} -bundles over N , any two non-trivial principal \mathbb{C} -bundles over N differ by a scalar factor.

Let N_1, N_2 be two such manifolds which are holomorphically equivalent and consider a biholomorphism $\phi : N_1 \rightarrow N_2$. Over each N_i there is a principal \mathbb{C} -bundle $V_i \rightarrow N_i$, where the total space V_i is in both cases V , but is foliated in two different ways by the projectivized leaves of each system. We have to lift ϕ to an equivalence of the principal \mathbb{C} -bundles V_i , which amounts to finding an equivalence between V_1 and ϕ^*V_2 . Now V_1 and ϕ^*V_2 are non-trivial \mathbb{C} -bundles (otherwise they would have sections, N_i would embed holomorphically in $\mathbb{P}_{\mathbb{C}}^{n-1}$ and would be a Kähler manifold, recall [81], p.182). By the previous computation these differ by a scalar factor and there is an equivalence between V_1 and V_2 preserving the leaves of the foliations. By Hartog's Theorem this equivalence extends to one of $\mathbb{P}_{\mathbb{C}}^{n-1}$ into itself which must then necessarily be linear since the group of biholomorphisms of $\mathbb{P}_{\mathbb{C}}^{n-1}$ is the corresponding projective linear group. But then it follows easily that the corresponding eigenvalues must be affinely equivalent, and Theorem 5 is proved. \square

Theorem 5 says that when $d \neq 2$ the reduced deformation space of N injects into its universal deformation space. For $d = 1$ the question of whether the reduced deformation space is universal or not depends on the existence of resonances among the λ_i (see [41], [53]). For $d \geq 4$ the situation is simpler and only depends on the condition that all the λ_i be different:

Theorem 6. *Let $n = n_1 + \dots + n_k$ be an ordered partition of n with $d \geq 4$. Let Λ be a collection of eigenvalues corresponding to this partition and assume that all λ_i are different. Then the corresponding reduced deformation space of $N(\Lambda)$ is universal.*

Proof: Following again [53] we consider the exact sequences of sheaves over V :

$$0 \rightarrow \Theta^{inv} \rightarrow \Theta \xrightarrow{L_\xi} \Theta \rightarrow 0$$

$$0 \rightarrow \mathcal{O}^{inv}\xi \rightarrow \Theta^{inv} \rightarrow \Theta_b \rightarrow 0$$

where Θ denotes the sheaf of holomorphic vector fields on a manifold and Θ^{inv} and Θ_b are defined by these sequences. Now again by Scheja [74] we have

$$H^i(V, \Theta) = H^i(\mathbb{P}_{\mathbb{C}}^{n-1}, \Theta) \text{ for } i \leq d - 2$$

$H^0(\mathbb{P}_{\mathbb{C}}^{n-1}, \Theta)$ is the space of holomorphic global vector fields on $\mathbb{P}_{\mathbb{C}}^{n-1}$ (all of which are linear) and can be identified with the space of $n \times n$ matrices modulo the scalar ones. For $i > 0$, $H^i(\mathbb{P}_{\mathbb{C}}^{n-1}, \Theta) = 0$.

The first sequence above gives a cohomology exact sequence for $d \geq 4$:

$$0 \rightarrow H^0(\Theta^{inv}) \rightarrow H^0(\Theta) \xrightarrow{L_{\xi}} H^0(\Theta) \rightarrow H^1(\Theta^{inv}) \rightarrow 0.$$

Since ξ corresponds to the diagonal matrix with entries λ_i and these are different, the kernel and cokernel of L_{ξ} can be identified with the space of diagonal matrices modulo the scalar ones, so $H^1(\Theta^{inv})$ is a space of dimension $n - 1$. The class of ξ in this vector space is non-zero.

From the exact sequences of sheaves we have the diagram:

$$\begin{array}{ccccccc} H^0(\Theta_b) & \rightarrow & H^1(\mathcal{O}^{inv}) & \rightarrow & H^1(\Theta^{inv}) & \rightarrow & H^1(\Theta_b) \rightarrow 0 \\ & & \uparrow \cong & & \uparrow & & \\ & & H^0(\mathcal{O}) & \rightarrow & H^0(\Theta) & & \end{array}$$

where the two middle horizontal maps are induced by multiplication by ξ . Since the lower one is injective by the above remark, it follows that so is the upper one and that $H^1(\Theta_b)$ is of dimension $n - 2$.

Now it is easy to see that $H^i(\Theta_b)$ is isomorphic to $H^i(N, \Theta)$. It follows that $H^1(N, \Theta)$ is of dimension $n - 2$ and is the tangent space to the universal deformation space of N . Since we have shown that the reduced deformation space is smooth, has dimension $n - 2$ and injects into this universal space, it follows that it is itself a universal deformation space and Theorem 6 is proved. \square

Observe that in Theorem 4 for $l \geq 4$ the space of complex structures is the universal deformation space for any of its members.

6.3. Global deformation theory of LVM manifolds. Here the deformation theory of equivariant LVM manifolds is explained and then together with the reconstruction theorem we conclude that this implies the existence of the moduli stack of torics.

Let Λ be an admissible configuration. We want to describe the set \mathcal{M}_{Λ} of G -biholomorphism classes of LVM manifolds $N_{\Lambda'}$ such that $\mathcal{S}_{\Lambda'}$ is equal to \mathcal{S}_{Λ} up to a permutation of coordinates in \mathbb{C}^n .

We assume that Λ satisfies (15) and

$$(1) \quad \Lambda_i \text{ is indispensable} \iff i \leq k$$

that is, the k indispensable points are the first k vectors of the configuration. In the same way, every class $[N_{\Lambda'}]$ of \mathcal{M}_{Λ} can be represented by a configuration Λ' satisfying (15), (1) and

$$(2) \quad \mathcal{S} := \mathcal{S}_{\Lambda} = \mathcal{S}_{\Lambda'}.$$

Remark 12. Condition (2) is equivalent to K_{Λ} being combinatorially equivalent to $K_{\Lambda'}$ with same numbering (35). Observe that because of our convention (1), having the same numbering implies having the same number of indispensable points.

Now, observe that, because of (15), there exists an affine transformation T of \mathbb{C}^m sending Λ onto a configuration (which we still denote by Λ) whose first $m + 1$ vectors satisfies

$$(3) \quad \Lambda_1 = ie_1, \Lambda_2 - \Lambda_1 = e_1, \dots, \Lambda_{m+1} - \Lambda_1 = e_m, \text{ where } (e_1, \dots, e_m) \text{ is the canonical basis of } \mathbb{C}^m.$$

It is straightforward to check that this does not change N_Λ up to G -biholomorphism. In the same way, each class of \mathcal{M}_Λ can be represented by an element Λ' satisfying (15), (1), (2) and (3). We call \mathcal{S} -normalized configuration such a configuration.

Let \mathcal{T}_Λ be the set of \mathcal{S} -normalized configurations. This is an open and connected set in $(\mathbb{C}^m)^{n-m-1}$.

Assume now that $N_{\Lambda'}$ is G -biholomorphic to N_Λ . Then, G_Λ and $G_{\Lambda'}$ as subgroups of $\text{Aut}(N_\Lambda)$, respectively $\text{Aut}(N_{\Lambda'})$ are isomorphic Lie groups. Hence, their universal cover are isomorphic as Lie groups, that is, using the presentation given in Proposition 6, there exists a matrix M in $\text{GL}_{n-m-1}(\mathbb{C})$ which sends the lattice of G_Λ bijectively onto that of $G_{\Lambda'}$. Using notations (16) and (17), this means that there exists a matrix P in $\text{SL}_{n-1}(\mathbb{Z})$ such that

$$(4) \quad M(\text{Id}, B_\Lambda A_\Lambda^{-1}) = (\text{Id}, B_{\Lambda'} A_{\Lambda'}^{-1})P.$$

Decomposing P as

$$(5) \quad P = \begin{pmatrix} P_1 & P_2 \\ Q_1 & Q_2 \end{pmatrix}$$

with P_1 a square matrix of size $n - m - 1$ and Q_2 a square matrix of size m , we obtain

$$(6) \quad MB_\Lambda A_\Lambda^{-1} = (P_1 + B_{\Lambda'} A_{\Lambda'}^{-1} Q_1) B_\Lambda A_\Lambda^{-1} = P_2 + B_{\Lambda'} A_{\Lambda'}^{-1} Q_2.$$

Because of (3), this means that

$$(7) \quad {}^t B_\Lambda = ({}^t P_2 + {}^t Q_2 {}^t B_{\Lambda'}) ({}^t P_1 + {}^t Q_1 {}^t B_{\Lambda'})^{-1}$$

that is

Proposition 1. *Let Λ and Λ' be two \mathcal{S} -normalized configurations. Then N_Λ and $N_{\Lambda'}$ are G -biholomorphic if and only if Λ and Λ' satisfies (7).*

Thus, \mathcal{M}_Λ is the quotient of \mathcal{T}_Λ by the action of $\text{SL}_{n-1}(\mathbb{Z})$ described in (7). We claim

Proposition 2. *If the number k of indispensable points is less than $m + 1$, then the moduli space $\mathcal{M}(X)$ is an orbifold.*

Proof From the previous description, it is enough to prove that the stabilizers of action (7) are finite. Let f be a G -biholomorphism of N_Λ . Set

$$(8) \quad \mathcal{S}_1 = \{w \in \mathbb{C}^{n-m-1} \mid (1, \dots, 1, w) \in \mathcal{S}\}.$$

Observe that (8) is a covering of the quotient N_1 of $\mathcal{S} \cap \{z_1 \cdots z_{m+1} \neq 0\}$ by the action (27). Indeed, we have a commutative diagram

$$(9) \quad \begin{array}{ccccc} (\mathbb{C}^*)^{n-m-1} & \longrightarrow & \mathcal{S}_1 & \longrightarrow & \mathcal{S} \\ \downarrow & & \downarrow & & \downarrow \\ G_\Lambda & \longrightarrow & N_1 & \longrightarrow & N_\Lambda \end{array}$$

where the horizontal maps are inclusions and the first two vertical ones are coverings.

Then, up to composing with a permutation of \mathbb{C}^n , we may assume that f sends N_1 onto itself. Because of assumption (1), the set (8) is a 2-connected open subset of \mathbb{C}^{n-m-1} , hence the restriction of f to N_1 , say f_1 , lifts to a biholomorphic map F_1 of (8). More precisely, \mathcal{S}_1 is equal to \mathbb{C}^{n-m-1} minus a finite union of codimension 2 vector subspaces, hence by Hartogs, F_1 extends as a biholomorphism of \mathbb{C}^{n-m-1} .

On the other hand, the restriction of f to G_Λ preserves G_Λ and lifts as a biholomorphism \tilde{F} of its universal covering \mathbb{C}^{n-m-1} . And we have a commutative diagram

$$(10) \quad \begin{array}{ccc} \mathbb{C}^{n-m-1} & \xrightarrow{\exp(2i\pi-)} & (\mathbb{C}^*)^{n-m-1} \\ \tilde{F} \downarrow & & \downarrow F_1 \\ \mathbb{C}^{n-m-1} & \xrightarrow{\exp(2i\pi-)} & (\mathbb{C}^*)^{n-m-1} \end{array}$$

But, since the linear map $\tilde{F} = M$ must preserve the abelian subgroup of Proposition 6, using (3) and (4), we have

$$(11) \quad \tilde{F}(z + e_i) = \tilde{F}(z) + P_1 e_i := \tilde{F}(z) + \sum_{j=1}^{n-m-1} a_{ij} e_j$$

that is Q_1 is equal to 0. But through (10), this implies that

$$(12) \quad F_1(w) = \left(w_1^{a_{1j}} \cdots w_{n-m-1}^{a_{n-m-1j}} \right)_{j=1}^{n-m-1}$$

Now, recall that F_1 is a biholomorphism of the whole \mathbb{C}^{n-m-1} , so must send a coordinate hyperplane onto another one without ramifying. This shows that $P_1 = (a_{ij})$ is a matrix of permutation. Hence every stabilizer is a subgroup of the group of permutations with $n - m - 1$ elements, so is finite.

Example 2. Tori. Let $n = 2m + 1$, then there are $2m + 1$ indispensable points, \mathcal{S} is $(\mathbb{C}^*)^n$ and N is a compact complex torus of dimension m [62, Theorem 1]. The associate polytope K is reduced to a point and $N = G$. The moduli space \mathcal{M} is equal to the moduli space of compact complex tori of dimension m , which is not an orbifold for $m > 1$.

Example Hopf surfaces. Let $n = 4$ and $m = 1$, then there are two indispensable points and \mathcal{S} is $(\mathbb{C}^*)^2 \times \mathbb{C}^2 \setminus \{(0, 0)\}$. A \mathcal{S} -admissible configuration is given by a couple complex numbers (λ_3, λ_4) belonging to

$$(13) \quad \{z \in \mathbb{C} \mid \Re z < 0 \text{ and } \Re z < \Im z\}.$$

The manifold N_Λ is equal to the diagonal Hopf surface obtained by taking the quotient of $\mathbb{C}^2 \setminus \{(0, 0)\}$ by the group generated by

$$(14) \quad (z, w) \mapsto (\exp 2i\pi(\lambda_3 - \lambda_1) \cdot z, (\exp 2i\pi(\lambda_4 - \lambda_1) \cdot w))$$

Two points (λ_3, λ_4) and (λ'_3, λ'_4) with coordinates in (13) are equivalent if and only if their difference is in the lattice $\mathbb{Z} \oplus \mathbb{Z}$ or if the difference of (λ_3, λ_4) by the switched (λ'_4, λ'_3) is in this lattice. The isotropy group of a point is \mathbb{Z}_2 for the diagonal $\lambda_3 = \lambda_4$ and is zero elsewhere. The moduli space is an orbifold.

Observe that not all Hopf surfaces are obtained as LVM-manifolds, but only the linear diagonal ones. Now, they coincide with the set of Hopf surfaces that are equivariant compactifications of $(\mathbb{C}^*)^2$.

(b) Generalized Hopf manifolds.

When $n_1 = n_2 = 1$ the manifold N is diffeomorphic to $\mathbb{S}^1 \times \mathbb{S}^{2n_3-1}$. Here the mapping $exp : \mathbb{C}^2 \times (\mathbb{C}^{n_3} \setminus 0) \rightarrow \mathcal{S} = (\mathbb{C}^*)^2 \times (\mathbb{C}^{n_3} \setminus 0)$ given by $exp(\zeta_1, \zeta_2, \zeta) = (e^{\zeta_1}, e^{\zeta_2}, \zeta)$ can be used to identify N with the quotient of $\mathbb{C}^{n_3} \setminus 0$ by the action of \mathbb{Z} defined by the multipliers

$$\alpha_i = \exp\left(2\pi i \frac{\lambda_{2+i} - \lambda_2}{\lambda_1 - \lambda_2}\right), \quad i = 1, \dots, n_3.$$

In this case we obtain all complex structures on $\mathbb{S}^1 \times \mathbb{S}^{2n_3-1}$ having $\mathbb{C}^n \setminus 0$ as universal cover when there is no resonance among the α_i . But in the resonant case we do not obtain all such complex structures since we do not obtain the non-linear resonant cases of Haefliger. It is clear that, in order to obtain the latter, one must look at the resonant non-linear versions of equation (1).

(c) Generalized Calabi-Eckmann manifolds.

When $n_1 = 1$ and n_2, n_3 are both greater than 1 we have seen that the manifold N is diffeomorphic to $\mathbb{S}^{2n_2-1} \times \mathbb{S}^{2n_3-1}$. Here the mapping $exp : \mathbb{C} \times (\mathbb{C}^{n_2} \setminus 0) \times (\mathbb{C}^{n_3} \setminus 0) \rightarrow \mathcal{S} = \mathbb{C}^* \times (\mathbb{C}^{n_2} \setminus 0) \times (\mathbb{C}^{n_3} \setminus 0)$ given by $exp(\zeta, \zeta_1, \zeta_2) = (e^\zeta, \zeta_1, \zeta_2)$ can be used to identify N with the quotient of $(\mathbb{C}^{n_2} \setminus 0) \times (\mathbb{C}^{n_3} \setminus 0)$ by the action of \mathbb{C} defined by the linear differential equation with eigenvalues $\lambda'_i = 2\pi i(\lambda_i - \lambda_1)$, $i = 2, \dots, n$. This is exactly the construction of the Loeb-Nicolau complex structure corresponding to a linear system of equations of Poincaré type [53].

Observe that in their construction only the quotients of the eigenvalues of the system are relevant for the definition of the complex structure on N , so once again only the quotients $\frac{\lambda_i - \lambda_k}{\lambda_j - \lambda_k}$ of our original eigenvalues count.

Again we obtain all their examples of complex structures on $\mathbb{S}^{2n_2-1} \mathbb{S}^{2n_3-1}$ when there is no resonance among the λ'_i . But, once more, in the resonant case we do not obtain all their complex structures since we do not obtain the non-linear resonant examples.

Observe that in all the cases considered in this section only the quotients $\frac{\lambda_i - \lambda_k}{\lambda_j - \lambda_k}$ are relevant in the description of the complex structure of N (in accordance with the observation made in section 2 that affinely equivalent configurations of eigenvalues with the same \mathcal{S} give the same complex structure) and that they are actually *moduli* of that complex structure.

7. LVM MANIFOLDS AS EQUIVARIANT COMPACTIFICATIONS

Theorem 4 has a deeper explanation related to the structure of $N_{\mathbf{A}}$ and the arithmetic properties of \mathbf{A} . In fact \mathcal{S} contains always $(\mathbb{C}^*)^n$ as an open and dense subset *invariant under the foliation* $\tilde{\mathcal{F}}$. If we pass to the quotient under the action of (27) one obtains that $N_{\mathbf{A}}$ has as an open subset $G_{\mathbf{A}}$, which is the quotient of $(\mathbb{C}^*)^n$ by $\tilde{\mathcal{F}}$. Since $\tilde{\mathcal{F}}$ is defined by the action (27) and this action commutes with the group structure of the multiplicative group $de (\mathbb{C}^*)^n$, it follows that $G_{\mathbf{A}}$ itself is a connected commutative complex Lie group. In other words:

Theorem 7. ([55]) $N_{\mathbf{A}}$ is the equivariant compactification of a complex commutative Lie group $G_{\mathbf{A}}$.

Remark 13. In some sense, this theorem is the principal reason of the interconnection between LVMB manifolds, toric varieties, convex polytopes and moment-angle manifolds

Definition 11. A connected complex Lie group G is called *Cousin group* (or toroidal group in [43]) if any holomorphic function on it is constant [1].

Proposition 3. *Cousin groups are commutative. Moreover, they are quotients of a complex vector space \mathbb{V} by a discrete additive subgroup of \mathbb{V} [1].*

Proposition 4. *Any commutative connected complex Lie group G can be written in a unique way as a product $G = C \times \mathbb{C}^l \times (\mathbb{C}^*)^r$ where C is a Cousin group ($l, r \geq 0$).*

Proposition 5. *A commutative complex Lie group is Cousin if and only if it does not have non-trivial characters.*

Observe that $(\mathbb{C}^*)^n$ acts by multiplication on the space of Siegel leaves \mathcal{S}_Λ with an open and dense orbit, making it a toric variety. This action commutes with projectivization and with (27), making of N_Λ an equivariant compactification of an abelian Lie group, say G_Λ . A straightforward computation shows the following [63, p.27]

Proposition 6. *Assume that*

$$(15) \quad \text{rank}_{\mathbb{C}} \begin{pmatrix} \Lambda_1 & \cdots & \Lambda_{m+1} \\ 1 & \cdots & 1 \end{pmatrix} = m + 1.$$

Then G_Λ is isomorphic to the quotient of \mathbb{C}^{n-m-1} by the \mathbb{Z}^{n-1} abelian subgroup generated by $(Id, B_\Lambda A_\Lambda^{-1})$ where

$$(16) \quad A_\Lambda = {}^t(\Lambda_2 - \Lambda_1, \dots, \Lambda_{m+1} - \Lambda_1)$$

and

$$(17) \quad B_\Lambda = {}^t(\Lambda_{m+2} - \Lambda_1, \dots, \Lambda_{n-1} - \Lambda_1).$$

Remark 14. It is easy to prove that

$$\text{rank}_{\mathbb{C}} \begin{pmatrix} \Lambda_1 & \cdots & \Lambda_n \\ 1 & \cdots & 1 \end{pmatrix} = m + 1.$$

(cf. [68, Lemma 1.1] in the LVM case). Hence, up to a permutation, condition (15) is always fulfilled.

We say that N_Λ and $N_{\Lambda'}$ are *G-biholomorphic* if they are $(G_\Lambda, G_{\Lambda'})$ -equivariantly biholomorphic.

Remark 15. When \mathcal{S} is $(\mathbb{C}^*)^n$, one has $N = G$ is a compact complex Lie group and therefore a compact complex torus. This is a direct proof of the example presented in 2

The structure of groups like G_Λ is well-known [67]. Since we know that the dimension of G_Λ is equal to that of N we obtain that G_Λ is the quotient of $(\mathbb{C}^*)^{n-m-1}$ by a discrete multiplicative subgroup Γ . The group G_Λ is sometimes called a semi torus *i.e.*, there exists a short equivariant exact sequence

$$0 \longrightarrow (\mathbb{C}^*)^{n-m-1} \longrightarrow G_\Lambda \longrightarrow T \longrightarrow 0$$

where T is an appropriate compact complex torus of dimension $n - m - 1$.

Furthermore, the group G_Λ is isomorphic to $(\mathbb{C}^*)^a \times C$, where $a \geq 0$ and C is a Cousin group. Compact Cousin groups are just complex tori. However there are non-compact Cousin group, for instance If $C = (\mathbb{C}^*)^{n-m-a-1}/\Gamma_0$, and Γ_0 is a ‘‘sufficiently generic’’ discrete subgroup in order to have that any holomorphic function on $(\mathbb{C}^*)^{n-m-a-1}$ which is invariant under Γ_0 must be constant then any holomorphic function on the quotient is constant.

In our case, any holomorphic function on G extends to a meromorphic function on N_Λ . Then theorem 2 shows is the following:

Proposition 7. *If N_Λ does not have an indispensable point, then the algebraic dimension of N_Λ is equal to the dimension a of the factor \mathbb{C}^* in the associated decomposition $G = (\mathbb{C}^*)^a \times C$.*

Hence we obtain the following.

Corollary 1. ([62] **Proposition IV.1.**) *Let $N_{\mathbf{\Lambda}}$ be an LVM manifold which is the equivariant compactification of the connected complex abelian Lie group $G_{\mathbf{\Lambda}}$. Suppose $N_{\mathbf{\Lambda}}$ is without indispensable points. Then one has an equivalence:*

- (i) $N_{\mathbf{\Lambda}}$ does not have non-constant meromorphic functions
- (ii) $G_{\mathbf{\Lambda}}$ is a Cousin group, i.e, every holomorphic function on $G_{\mathbf{\Lambda}}$ is constant
- (iii) System **S** has no solution in the rationals.

8. TORIC VARIETIES AND GENERALIZED CALABI-ECKMANN FIBRATIONS

Let $\mathbf{\Lambda} = (\Lambda_1, \dots, \Lambda_n)$ be a configuration which is admissible *i.e.*, it satisfies both the Siegel and weak hyperbolicity conditions as before.

Consider the system of equations:

$$(S) \quad \begin{cases} \sum_{i=1}^n s_i \Lambda_i = 0 \\ \sum_{i=1}^n s_i = 0 \end{cases}$$

Definition 12. We say that the configuration $\mathbf{\Lambda}$ satisfies condition **(K)** if the dimension over \mathbb{Q} of the vector space of rational solutions of the system **S** above is maximal, in other words is of dimension $n - 2m - 1$.

Observe that any linear diagonal holomorphic vector field

$$\xi = \sum_{i=1}^n \alpha_i z_i \frac{\partial}{\partial z_i}$$

on \mathbb{C}^n projects onto a holomorphic vector field on N . In particular, let

$$\Lambda_i = (\lambda_i^1, \dots, \lambda_i^m) \quad 1 \leq i \leq n$$

and define the m commuting vector fields on \mathcal{S}

$$(VF) \quad \eta_i(z) = \left\langle \operatorname{Re} \Lambda_i \sum_{j=1}^n z_j \frac{\partial}{\partial z_j} \right\rangle = \sum_{j=1}^n \Re(\lambda_j^i) z_j \frac{\partial}{\partial z_j} \quad 1 \leq i \leq m$$

for i between 1 and m . The composition of the (holomorphic) flows of these vector fields gives an action of \mathbb{C}^m on N . The following Theorem is proven in [62], as a generalization of a result of J.J. Loeb and M. Nicolau [54].

Theorem 8. ([62], **Theorem 7**) *The projection onto N of the vector fields (η_1, \dots, η_m) gives on N a regular holomorphic foliation \mathcal{G} of dimension m . Moreover, the foliation \mathcal{G} is transversely Kählerian with respect to ω , the canonical Euler form of the bundle $M_1 \rightarrow N$ (see definition 7).*

Recall that transversely Kählerian means that

- (i) \mathcal{G} is the kernel of ω .
- (ii) ω is closed and real.
- (iii) The quadratic form $h(-, -) = \omega(J-, -) + i\omega(-, -)$ (where J denotes the almost complex structure of N) defines a hermitian metric on the normal bundle to the foliation.

We note that this Theorem gives non-trivial examples of transversely Kählerian foliations on compact complex manifolds.

The aim of this Section is to study the quotient space of N by \mathcal{G} . Observe that it can be obtained as the quotient space of \mathcal{S} by the action induced by the action \mathfrak{S} .

Going back to the abelian group G_{Λ} of theorem 7, we see that its Lie algebra is generated by the linear vector fields $z_i \partial / \partial z_i$ for $i = 1, \dots, n$. Due to the quotient by (\mathfrak{S}) , they only generate a vector space of dimension $n - m - 1$ as needed. Amongst these $n - m - 1$ linearly independent vector fields, we can find m of them which extend to \mathcal{S}_{Λ} without zeros and which generates a locally free action of \mathbb{C}^m onto \mathcal{S}_{Λ} . For example, we can take the commuting vector fields in formula VF above.

Definition 13. (Canonical foliation). We denote by $\mathcal{G} = \mathcal{G}_{\Lambda}$ the foliation induced by this action. This is the *canonical foliation* of N_{Λ} .

It is easy to check that \mathcal{G} is independent of the choice of vector fields. Indeed, changing the vector fields just means changing the parametrization of \mathcal{G} , that is changing the \mathbb{C}^m -action by taking a different basis of \mathbb{C}^m .

Pull back the Fubini-Study form of \mathbb{P}^{n-1} to the embedding (30). This is the *canonical Euler form* ω of Λ , as defined in definition 7. It is a representative of the Euler class of a particular \mathbb{S}^1 -bundle associated to N_{Λ} , hence the name. Then \mathcal{G} is transversely Kähler with transverse Kähler form ω . For our purposes, we will not focus on ω but on the ray $\mathbb{R}^{>0}\omega$ it generates. Recall that Λ fulfills condition **(K)** if 32 admits a basis of solutions with integer coordinates; and that Λ fulfills condition **(H)** if **S** does not admit any solution with integer coordinates. If condition **K** in definition 12 is fulfilled, then \mathcal{G} is a foliation by compact complex tori and the quotient space is a projective toric orbifold, see [68] which contains a thorough study of this case.

We just note here that, even if condition **(K)** in definition 12 is not satisfied, the foliation \mathcal{G} has some compact orbits. Indeed, let I be a vertex of K_{Λ} . Then, by (34), 0 belongs to $\mathcal{H}(\Lambda_{I^c})$, so by [68, Lemma 1.1],

$$(18) \quad \text{rank}_{\mathbb{C}} \begin{pmatrix} \Lambda_{i_1^c} & \cdots & \Lambda_{i_{2m+1}^c} \\ 1 & \cdots & 1 \end{pmatrix} = m + 1.$$

Hence, up to performing a permutation, we may assume at the same time (15) and

$$(19) \quad I \cap \{1, \dots, m + 1\} = \emptyset.$$

Definition 14. An n -dimensional toric variety W (possibly singular) is an algebraic variety with an open and dense subset biholomorphic to $(\mathbb{C}^*)^n$ such that the natural action of $(\mathbb{C}^*)^n$ extends to a holomorphic action on all of W . In other words: a toric variety of complex dimension n is an algebraic variety which is an equivariant compactification of the abelian algebraic torus $(\mathbb{C}^*)^n$.

We have

Proposition 8. For each vertex I of K_{Λ} , the corresponding submanifold N_I is a compact complex torus of dimension m and is a leaf of \mathcal{F} . Moreover, assume that Λ satisfies (15) and (19). Then, letting B_I denote the matrix obtained from (17) by erasing the rows $\Lambda_i - \Lambda_1$ for $i \in I$, the torus N_I is isomorphic to the torus of lattice $(Id, B_I A_{\Lambda}^{-1})$.

The following theorem is the fundamental connection between toric varieties with at most quotient singularities (*i.e.*, quasi-regular varieties) and LVM manifolds.

Theorem 9. ([68] **Theorem A**) *Let N be one of our manifolds corresponding to a configuration which satisfies condition **(K)** in definition 12. Then N is a Seifert-Orlik fibration in complex tori of dimension m over a quasi-regular, projective, toric variety of dimension $n - 2m - 1$. More precisely: Let $\mathbf{\Lambda}$ be an admissible configuration satisfying condition **(K)**. Then*

- (1) The leaves of the foliation \mathcal{G} of $N_{\mathbf{\Lambda}}$ are compact complex tori of dimension m .
- (2) The quotient space of $N_{\mathbf{\Lambda}}$ by \mathcal{G} is a projective toric variety of dimension $n - 2m - 1$. We denote it by $X(\Delta)$, where Δ is the corresponding fan.
- (3) The toric variety $X(\Delta)$ comes equipped with an equivariant orbifold structure.
- (4) The natural projection $\pi : N \rightarrow X(\Delta)$ is a holomorphic principal Seifert bundle, with compact complex tori of dimension m as fibers.
- (5) The transversely Kählerian form ω of N projects onto a Kählerian (singular at the singular locus of $X(\Delta)$ as a variety) form $\tilde{\omega}$ of $X(\Delta)$.

Moreover, condition **(K)** is optimal with respect to these properties in the sense that the foliation \mathcal{G} of a configuration which does not satisfy it has non-compact leaves, so item 1 is not verified.

9. IDEA OF THE PROOF OF THEOREM 9

9.1. Toy example. We start with an example that shows the close relationship between LVM manifolds and Calabi-Eckmann manifolds

Example 3. Consider the admissible configuration given by

$$\Lambda_1 = \Lambda_2 = 1 \quad \Lambda_3 = i \quad \Lambda_4 = -1 - i.$$

We have seen in 3.3 that the manifold corresponding N is diffeomorphic to $\mathbb{S}^1 \times \mathbb{S}^3$, *i.e.*, N is a primary Hopf surface primaire. One knows ([8] Chapter V, Proposition 8.18) that such a surface contains either exactly two elliptic curves or else it is an elliptic fibration over $\mathbb{P}_{\mathbb{C}}^1$. In addition these two cases are distinguished by their algebraic dimensions: in the first case the algebraic dimension is 0 and in the second it is 1.

Although theorem 4 does not apply directly here since the configuration has two indispensable points one still has that the algebraic dimension of N is *greater or equal to a* , the number of rational solutions which are \mathbb{Q} -linearly independent of system **S**. Here $a = 1$, the solutions of system **S** are generated by

$$s_1 = 1 \quad s_2 = -1 \quad s_3 = 0 \quad s_4 = 0$$

It follows that the algebraic dimension of N is equal to one and that N fibers over $\mathbb{P}_{\mathbb{C}}^1$ with fiber an elliptic curve.

Let us now consider $\Lambda_j = a_j + ib_j$ and the following action of \mathbb{C}^2 in $\mathbb{P}_{\mathbb{C}}^3$:

$$(\bullet) \quad ((t_1, t_2), [z]) \in (\mathbb{C}^*)^2 \times \mathbb{P}_{\mathbb{C}}^3 \longmapsto [z_i \cdot t_1^{a_i} \cdot t_2^{b_i}]_{i=1}^{i=4} = [z_1 t_1, z_2 t_1, z_3 t_2, z_4 / (t_1 t_2)] \in \mathbb{P}_{\mathbb{C}}^3$$

Let us restrict this action to \mathcal{V} (the projection to $\mathbb{P}_{\mathbb{C}}^3$ of the open set of Siegel leaves of the system definition 5)

$$\mathcal{V} = \{[z] \in \mathbb{P}_{\mathbb{C}}^3 \mid (z_1, \dots, z_4) \in (\mathbb{C}^2 \setminus \{(0, 0)\}) \times (\mathbb{C}^*)^2\}$$

The projection

$$[z_1, \dots, z_4] \in \mathcal{V} \longmapsto [z_1, z_2] \in \mathbb{P}_{\mathbb{C}}^1$$

is invariant invariante under the action \bullet , hence the quotient of \mathcal{V} under the action can be identified with $\mathbb{P}_{\mathbb{C}}^1$.

Consider now the action 27 of \mathbb{C} on \mathcal{V} (definition 5). This action commutes with the action of $(\mathbb{C}^*)^2$, hence it respects the projection. In fact, the inclusion

$$T \in \mathbb{C} \longmapsto (t_1 = \exp T, t_2 = \exp iT) \in (\mathbb{C}^*)^2$$

intertwines the two actions: N is given by the action (\bullet) of $(\mathbb{C}^*)^2$ restricted to couples (t_1, t_2) on its image. So one has the commutative diagram:

$$\begin{array}{ccc} \mathcal{V} & \xrightarrow{Id} & \mathcal{V} \\ \downarrow & & \downarrow \\ N & \xrightarrow{p} & \mathbb{P}_{\mathbb{C}}^{n-1} \end{array}$$

On the other hand the fibers of the projection in the righthand side are biholomorphic to $(\mathbb{C}^*)^2$, and the fibers in the lefthand side are biholomorphic to \mathbb{C} . The fibers of p are given by the quotient of $(\mathbb{C}^*)^2 \times \mathbb{C}$ where \mathbb{C} acts on $(\mathbb{C}^*)^2$ by the inclusion defined above. A direct calculation shows that the fibers are elliptic curves isomorphic to the quotient of \mathbb{C}^* by the group generated by the homothety $z \rightarrow \exp 2\pi \cdot z$. In this way we obtain the elliptic fibration of N over $\mathbb{P}_{\mathbb{C}}^1$.

Everything in the preceding example can be generalized to the case of any manifold $N = N_{\Lambda}$ where Λ verifies condition **(K)** in definition 12 . Let

$$1 \leq j \leq n \quad \Lambda_j = a_j + ib_j$$

and consider the action of \mathbb{C}^{2m} on $\mathbb{P}_{\mathbb{C}}^{n-1}$ given by the formula:

$$(R, S, [z]) \in \mathbb{C}^m \times \mathbb{C}^m \times \mathbb{P}_{\mathbb{C}}^{n-1} \longmapsto [z_j \cdot \exp \langle a_j, R \rangle \cdot \exp \langle b_j, S \rangle]_{j=1}^n \in \mathbb{P}_{\mathbb{C}}^{n-1}$$

Since N verifies condition **(K)** in definition 12, up to replacing the configuration

Λ by $A(\Lambda)$ where A is an appropriate *real* affine transformation of $\mathbb{R}^{2m} \simeq \mathbb{C}^m$ one can assume that the real and imaginary parts of each Λ_j are vectors belonging to the lattice \mathbb{Z}^m ([68] Lemma 2.4):

This means that the preceding action of \mathbb{C}^{2m} on $\mathbb{P}_{\mathbb{C}}^{n-1}$ is equivalent to an algebraic action of $(\mathbb{C}^*)^{2m}$ on $\mathbb{P}_{\mathbb{C}}^{n-1}$

$$(8) \quad (t, s, [z]) \in (\mathbb{C}^*)^m \times (\mathbb{C}^*)^m \times \mathbb{P}_{\mathbb{C}}^{n-1} \longmapsto [z_1 \cdot t^{a_1} \cdot s^{b_1}, \dots, z_n \cdot t^{a_n} \cdot s^{b_n}] \in \mathbb{P}_{\mathbb{C}}^{n-1}$$

where a_j and b_j belong to \mathbb{Z}^m . Here t^{a_j} (respectively s^{b_j}) means $t_1^{a_j^1} \dots t_m^{a_j^m}$ (respectively $s_1^{b_j^1} \dots s_m^{b_j^m}$). When one restricts the action (8) to \mathcal{V} (5), one can show that one obtains as quotient a projective toric variety X . In fact this procedure is precisely the construction of toric varieties as **GIT** (Geometric Invariant Theory) quotients by de David Cox in [20]. One simply verifies that the open set $\mathcal{V} \subset \mathbb{P}_{\mathbb{C}}^{n-1}$ corresponds to the semi-stable points for the natural linearization of $\mathbb{C}^n \rightarrow \mathbb{P}_{\mathbb{C}}^{n-1}$ ([68], Lemma 2.12). Since in our case the quotient is a geometric quotient (the orbit space which is Hausdorff) and not a quotient where one identifies instead the closure of the orbits, one deduces that the semi-stable points are in fact stable and, via [20], that the quotient is a projective quasi-regular toric variety *i.e.*, it possesses at worst quotient singularities,

Let i be the inclusion: $T \in \mathbb{C}^m \xrightarrow{i} (\exp T, \exp iT) \in (\mathbb{C}^*)^m \times (\mathbb{C}^*)^m$

Like in the toy example one can restrict the action (8) to the pairs in $(\mathbb{C}^*)^m \times (\mathbb{C}^*)^m$ that are in the image of i . This way one obtains an *algebraic* action of \mathbb{C}^m on \mathcal{V} . This action is precisely the action of formula (2). One obtains the same type of commutative diagram as in the toy example:

$$(CE) \quad \begin{array}{ccc} \mathcal{V} & \xrightarrow{Id} & \mathcal{V} \\ \downarrow & & \downarrow \\ N & \xrightarrow{p} & X \end{array}$$

A calculation shows that the fibers of $p : N_{\Lambda} \rightarrow X$ are compact complex tori of complex dimension m . This is equivalent to showing that every isotropy group under the action is a lattice isomorphic to \mathbb{Z}^{2m} . In fact this lattice can be explicitly calculated here is where one uses the rationality condition **(K)** in definition 12. The lattice is constant in an open dense set (in the Hausdorff or Zariski topology) but it could have special fibers that are finite quotients of the typical fibre (all the fibers are isogenous). In other words: the projection p corresponds to the quotient (*i.e.*, the orbit space) of N by the holomorphic action of a compact complex torus of complex dimension m acting with finite isotropy groups. This implies that X has the structure of an orbifold such that $p : N \rightarrow X$ is a Seifert-Orlik fibration [70].

Remark 16. The pre-image under $p : N \rightarrow X$ of a singular point of X is necessarily a special fiber. However there could be above regular points special fibers. In fact, the locus on the base X having special fibers could be of codimension one but the singular locus of X as a normal projective toric manifold must have codimension at least two. The reason of this difference is that X is an orbifold in addition to being toric and this structure could have “fake” codimension one singularities. For instance in the examples 3.3 of if one replaces $\Lambda_2 = 1$ by $\Lambda_2 = p$, one constructs a Hopf surface with an elliptic fibration over $\mathbb{P}_{\mathbb{C}}^1$ having two singular points of orbifold type and one or two special fibers.

Theorem 9 has the following corollary:

Corollary 2. *Let N satisfy the conditions of theorem 9. Then the algebraic reduction of N is a quasi-regular, projective, toric variety of dimension $n - 2m - 1$.*

As a particular case of the previous theorem one recovers the elliptic fibrations used by E. Calabi et B. Eckmann to provide the product of spheres $\mathbb{S}^{2p-1} \times \mathbb{S}^{2q-1}$ (for $p > 1$ et $q > 1$) with a complex structure. This generalization is given by the following

Definition 15. A generalized Calabi-Eckmann fibration is the fibration obtained by the previous theorem.

Since we know, fixing m and n , that the set of configurations satisfying condition **(K)** in definition 12 is dense in the space of admissible configurations on obtains:

Corollary 3. *Every manifold N corresponding to an admissible configuration is a small deformation of a generalized Calabi-Eckmann fibration*

Remark 17. All the fibers are isogeneous complex tori.

In the case where $X(\Delta) = \mathbb{P}_{\mathbb{C}}^p \times \mathbb{P}_{\mathbb{C}}^q$ with its manifold structure, then the fibration is the one in elliptic curves

$$\mathbb{S}^{2p+1} \times \mathbb{S}^{2q+1} \rightarrow \mathbb{C}P^p \times \mathbb{C}P^q$$

where $\mathbb{S}^{2p+1} \times \mathbb{S}^{2q+1}$ is endowed with a Calabi-Eckmann complex structure (see [18]). This explains the following definition

Definition 16. Definition 2.11 We call such a Seifert bundle $N \rightarrow X(\Delta)$ a generalized Calabi-Eckmann fibration over $X(\Delta)$.

Corollary 4. Let $\mathbf{\Lambda}$ be an admissible configuration satisfying condition **(K)**. Let $z \in \mathcal{S}$ and let

$$J_z = \{i_1, \dots, i_p\} = \{1 \leq i \leq n \mid z_i \neq 0\}$$

Then,

- (1) The lattice in \mathbb{C}^m of the orbit through z is $2\pi L_{(J_z)^c}^*$.
- (2) The orbit through z is an exceptional orbit if and only if $L_0 \subsetneq L_{(J_z)^c}$. In this case, it is a finite unramified quotient of the generic orbit of degree the index of L_0 in $L_{(J_z)^c}$.

The construction in the preceding section is completely reversible. Let X be a quasi-regular toric projective variety (*i.e.*, if it has singularities they are quotient singularities) then the construction by David Cox in [20] permits to realize X as the quotient of an open set X_{ss} by a linear algebraic action of $(\mathbb{C}^*)^p$ like the one given in formula (8) above. One can arrange this action in order to have p even and set $m = p/2$. Then one defines the configuration by the formulae:

$$\text{(Realization of } \mathbf{\Lambda}) \quad \mathbf{\Lambda} = \{\Lambda_j = a_j + ib_j \mid 1 \leq j \leq n\}$$

where the natural numbers a_j, b_j are the weights (like in formula (8)) of the algebraic action of $(\mathbb{C}^*)^{2m} = (\mathbb{C}^*)^m \times (\mathbb{C}^*)^m$ and one induces an action of \mathbb{C}^m on X_{ss} via the inclusion i defined above. To achieve one uses the following technical lemma found in ([68], **Lemmas 2.12 et 4.9.**):

Lemma 6. ([68], **Lemmas 2.12 et 4.9.**) *With the previous definition the configuration $\mathbf{\Lambda}$ is admissible and satisfies condition **(K)** in definition 12. In addition the open set $\mathcal{V}(\mathbf{\Lambda})$ (see definition 5) is equal to X_{ss} .*

One can show without difficulty that the variety X obtained by Cox construction is the generalized Calabi-Eckmann fibration associated to $N_{\mathbf{\Lambda}}$ via the commutative diagram CE. Therefore one the following theorem which is the reciprocal of theorem 9:

Theorem 10. *Let X be a projective, quasi-regular, toric variety. Then there exists $m > 0$ and a manifold N corresponding to an admissible configuration which admits a generalized Calabi-Eckmann over X and whose fibres are complex torii of complex dimension m .*

Furthermore, if X is nonsingular (smooth), one can choose m and N such that the fibration is a holomorphic principal fibration.

Remark 18. The previous theorem motivated a possible definition of non-commutative toric varieties and its deformations (usual toric varieties are rigid). See [4, 46].

Example 4. ([68], **Proposition I.**) (**Hirzebruch surfaces**) Let $a \in \mathbb{N}$. Then the manifold $N_{\mathbf{\Lambda}}$ associated to the admissible configuration $\mathbf{\Lambda} = \{\Lambda_1, \Lambda_2, \Lambda_3, \Lambda_4, \Lambda_5\}$ with

$$\Lambda_1 = \Lambda_4 = 1 \quad \Lambda_2 = i \quad \Lambda_3 = (2a^2 + 3a) + i(2a + 1) \quad \Lambda_5 = -2(a + 1) - 2i$$

is diffeomorphic to $\mathbb{S}^3 \times \mathbb{S}^3$ and it is a principal fibration in elliptic curves over the Hirzebruch surface \mathbb{F}_a .

The existence of such manifold was noticed by H. Maeda dans [57].

9.2. **Examples.** In this subsection, we shall use the following facts (which are proven in [52]). Let $\mathbf{\Lambda} = (\lambda_1, \dots, \lambda_5)$ be an admissible configuration with $m = 1$ and $n = 5$. Then, the classification of $N_{\mathbf{\Lambda}}$ up to diffeomorphism is completely determined by k , the number of indispensable points. We have

$$\begin{aligned} k = 0 &\iff N \text{ is the quotient of } \#(5)(\mathbb{S}^3 \times \mathbb{S}^4) \text{ by a non-trivial action of } \mathbb{S}^1 \\ k = 1 &\iff N \text{ is diffeomorphic to } \mathbb{S}^3 \times \mathbb{S}^3 \\ k = 2 &\iff N \text{ is diffeomorphic to } (\mathbb{S}^5 \times \mathbb{S}^1) \end{aligned}$$

where $\#(5)\mathbb{S}^3 \times \mathbb{S}^4$ denotes the connected sum of five copies of $\mathbb{S}^3 \times \mathbb{S}^4$. In all of the following examples, we shall give the fans in \mathbb{R}^2 with canonical basis (e_1, e_2) and lattice \mathbb{Z}^2 , or in \mathbb{R} with canonical basis e_1 and lattice \mathbb{Z} .

Remark 19. In the examples that follow we also use the very technical fact, proven in [68], that given the fan Δ of a toric variety with quotient singularities one can recover the configuration $\mathbf{\Lambda}$ satisfying condition **(K)** of definition 12. In particular one can recover from the fan the number of equations m and the dimension n to have an admissible action of C^m on C^n .

Example 5. Consider the complete fan Δ generated by

$$w_1 = e_1 \quad w_2 = e_2 \quad w_3 = -e_1 - e_2$$

of the complex projective space $\mathbb{C}P^2$. There is a unique class of Kähler classes (in the sense of Theorem G in [68]), which is that of the (Chern class) of the anti-canonical divisor. Up to scaling and up to translation, the polytope Q is defined as

$$Q = \{u \in \mathbb{R}^2 \mid \langle w_1, u \rangle \geq -1, \langle w_2, u \rangle \geq -1, \langle w_3, u \rangle \geq -1\}.$$

By the methods of [68] (**Realization of $\mathbf{\Lambda}$**) we can recover the configuration:

$$\lambda_1 = \lambda_2 = \lambda_3 = 1 \quad \lambda_4 = -3 + i \quad \lambda_5 = -i.$$

It is easy to check that this configuration has two indispensable points (λ_4 and λ_5) and thus the manifold N is diffeomorphic to $\mathbb{S}^5 \times \mathbb{S}^1$. We obtain finally the well-known (holomorphic) fibration $\mathbb{S}^5 \times \mathbb{S}^1 \rightarrow \mathbb{P}_{\mathbb{C}}^2$ and the pre-symplectic form of N scaled by 5 projects onto the (Chern class) of the anti-canonical divisor.

Notice that we may easily compute the modulus of the fiber in this case. From Corollary B in [68], we obtain the lattice and we obtain:

$$L_0^* = \frac{1}{5} \text{Vect}_{\mathbb{Z}}(-4 + i, 1 + i)$$

and this modulus is equal to

$$\frac{-4 + i}{1 + i} = \frac{-3}{2} + \frac{5}{2}i.$$

It is known [18] (see also [53]) that, for any choice of a modulus τ , there exists a complex structure on $\mathbb{S}^5 \times \mathbb{S}^1$ such that it fibers in elliptic curves of modulus τ over the complex projective space.

Fix $\tau = \alpha + i\beta$ with $\beta > 0$. A straightforward computation shows that the admissible configuration

$$\begin{pmatrix} \Re \lambda'_i \\ \Im \lambda'_i \end{pmatrix} = \begin{pmatrix} -\beta & \beta \\ 1 + \alpha & 4 - \alpha \end{pmatrix} \cdot \begin{pmatrix} \Re \lambda_i \\ \Im \lambda_i \end{pmatrix} \quad 1 \leq i \leq 5$$

determines a complex threefold diffeomorphic to $\mathbb{S}^5 \times \mathbb{S}^1$ which fibers over $\mathbb{P}_{\mathbb{C}}^2$ with fiber an elliptic curve of modulus τ .

Example 6. Consider the complete fan Δ generated by

$$w_1 = e_1 \quad w_2 = e_2 \quad w_3 = -e_1 \quad w_4 = -e_2$$

of $\mathbb{C}P^1 \times \mathbb{C}P^1$. The Kähler classes are

$$D_{\alpha,\beta} = \alpha(D_1 + D_3) + \beta(D_2 + D_4) \quad \alpha > 0, \beta > 0$$

corresponding to the rectangles

$$Q_{\alpha,\beta} = \{(u_1, u_2) \in \mathbb{R}^2 \mid -\alpha \leq u_1 \leq \alpha, -\beta \leq u_2 \leq \beta\} .$$

We get the corresponding configuration:

$$\lambda_1 = \lambda_3 = 1 \quad \lambda_2 = \lambda_4 = i \quad \lambda_5 = -2\alpha - 2i\beta.$$

The corresponding manifold $N_{\alpha,\beta}$ is diffeomorphic to $\mathbb{S}^3 \times \mathbb{S}^3$ and we find the Calabi-Eckmann fibration $\mathbb{S}^3 \times \mathbb{S}^3 \rightarrow \mathbb{P}_{\mathbb{C}}^1 \times \mathbb{P}_{\mathbb{C}}^1$. The pre-symplectic form of $N_{\alpha,\beta}$ projects onto a representative of the class of $D_{\alpha,\beta}$ (up to scaling).

Fix α and β . As in Example 5, for every choice of $\tau \in \mathbb{C}$ with $\text{Im } \tau > 0$, there exists a matrix A of $\text{GL}_2(\mathbb{R})$ such that the product of the previous configuration by A determines a LVM manifold diffeomorphic to $\mathbb{S}^3 \times \mathbb{S}^3$ which fibers over the product of projective lines with an elliptic curve of modulus τ as fiber (compare with [18]).

Alternatively, we may start from

$$\lambda_1 = \lambda_3 = 1 \quad \lambda_2 = \lambda_4 = i \quad \lambda_5 = -1 - i.$$

which is an admissible configuration such that the class of $\tilde{\omega}$ is $D_{1,1}$ (up to scaling) and perform a translation on $(\lambda_1, \dots, \lambda_5)$ to have another Kähler ray associated to $\tilde{\omega}$ (see Remarks 4.11 and 4.12 in [68]).

More precisely, assume that $\alpha < 1$ and $\beta < 1$ and let

$$b = \frac{1 - 2\alpha}{2\alpha + 2\beta + 1} + i \frac{1 - 2\beta}{2\alpha + 2\beta + 1}$$

then the class of $\tilde{\omega}$ of $N((\lambda_1, \dots, \lambda_5) + b)$ is $D_{\alpha,\beta}$.

Example 7. Consider the fan of $\mathbb{P}_{\mathbb{C}}^1$:

$$w_1 = e_1 \quad w_2 = -e_1$$

There is a unique Kähler ray, that of $D = D_1 + D_2$. We choose $p_1 = p$ and $p_2 = q$ for p and q strictly positive integers, that is we want to recover all possible codimension one equivariant orbifold singularities on $\mathbb{P}_{\mathbb{C}}^1$. We take $n = 4$ and $m = 1$ and choose

One can show that that configuration is:

$$\lambda_1 = \frac{-3}{2p} + i \frac{1 - 2q}{2p} \quad \lambda_2 = \frac{-1}{2q} - i \frac{2p + 1}{2q} \quad \lambda_3 = 1 \quad \lambda_4 = i .$$

It is easy to check that the corresponding manifold $N_{p,q}$ is diffeomorphic to $\mathbb{S}^3 \times \mathbb{S}^1$. It is the total space of a generalized Calabi-Eckmann fibration over $\mathbb{P}_{\mathbb{C}}^1$ with at most two singular points of order p and q .

Notice that if p and q are not coprime, then the orbifold structure cannot be obtained as a weighted projective space, i.e. cannot be obtained as quotient of $\mathbb{C}^2 \setminus \{(0, 0)\}$ by an algebraic action of \mathbb{C}^* .

Example 8. Consider the complete fan Δ generated by

$$w_1 = e_1, \quad w_2 = e_2, \quad w_3 = -e_1, \quad w_4 = -e_1 - e_2, \quad w_5 = -e_2$$

of the toric del Pezzo surface X obtained as the equivariant blowing-up of $\mathbb{P}_{\mathbb{C}}^2$ in two points. Define Q as the pentagon associated to the anti-canonical divisor of X (which is ample for X is del Pezzo)

$$Q = \{u \in \mathbb{R}^2 \mid \langle w_1, u \rangle \geq -1, \dots, \langle w_5, u \rangle \geq -1\} .$$

We want to construct a generalized Calabi-Eckmann fibration with elliptic curves as fibers. This implies that we must take $m = 1$ and $n = 5$, so we cannot add any indispensable point. As the sum of the w_i is not zero, we cannot take at the same time $p_1 = \dots = p_5 = 1$. In other words, there does not exist any *non singular* generalized Calabi-Eckmann fibration over X with elliptic curves as fibers. However, if we allow exceptional fibers, the construction is possible keeping $m = 1$. For example, take

$$p_1 = 2 \quad p_2 = 2 \quad p_3 = 1 \quad p_4 = 1 \quad p_5 = 1 .$$

This gives

$$v_1 = 2e_1, \quad v_2 = 2e_2, \quad v_3 = -e_1, \quad v_4 = -e_1 - e_2, \quad v_5 = -e_2, \quad \epsilon_1 = \epsilon_2 = \frac{2}{7}, \quad \epsilon_3 = \epsilon_4 = \epsilon_5 = \frac{1}{7}$$

Notice that \mathcal{L} is \mathbb{Z}^2 . Taking a linear Gale transform of this, we obtain

$$\lambda_1 = 1, \quad \lambda_2 = i, \quad \lambda_3 = -2 - 4i, \quad \lambda_4 = 4 + 4i \quad \lambda_5 = -4 - 2i .$$

This gives a fibration in elliptic curves $N \rightarrow X$ where N is the quotient of the differentiable manifold $\#(5)\mathbb{S}^3 \times \mathbb{S}^4$ by a non trivial action of \mathbb{S}^1 . The orbifold structure on X has two codimension one singular sets of index 2 and the form 7ω projects onto a representant of the Chern class of D .

Example 9. We consider the same toric variety X and the same polytope Q as in Example 8, but this time we want $p_1 = \dots = p_5 = 1$, i.e. we want a non singular fibration. We are thus forced to increase m by one and take $m = 2$ and $n = 7$, which gives us two additional indispensable points. We take

$$v_1 = e_1, \quad v_2 = e_2, \quad v_3 = -e_1, \quad v_4 = -e_1 - e_2,$$

$$v_5 = -e_2, \quad v_6 = -v_1 - v_2 - v_3 - v_4 - v_5 = e_1 + e_2, \quad v_7 = 0$$

and

$$\epsilon_1 = \dots = \epsilon_5 = \epsilon_7 = \frac{1}{9}, \quad \epsilon_6 = \frac{1}{3}$$

Notice that ϵ_6 is chosen so that v_6/ϵ_6 lies in the interior of $\mathcal{H}(v_1/\epsilon_1, \dots, v_5/\epsilon_5)$. Making all the computations, we find that

$$(\Lambda_1, \dots, \Lambda_7) = \begin{pmatrix} 1 & i & 0 & 0 & -1+i & -1 & 3-2i \\ 0 & 0 & 1 & i & 1 & 1+i & -5-4i \end{pmatrix}$$

defines a LVM manifold diffeomorphic to $(\#(5)\mathbb{S}^3 \times \mathbb{S}^4) \times \mathbb{S}^1$ (by application of Theorem 12 of [62]) which is the total space of a non singular principal holomorphic fibration over X with complex tori of dimension 2 as fibers. The form 9ω projects onto the anti-canonical divisor of X .

Example 10. Let $a \in \mathbb{N}$ and consider the complete fan Δ generated by

$$w_1 = e_1 \quad w_2 = e_2 \quad w_3 = -e_2 \quad w_4 = -e_1 + ae_2$$

of the Hirzebruch surface F_a .

Let $D = D_1 + D_2 + D_3 + (a+1)D_4$. The divisor D is ample (see [28], p.70). We take $v_i = w_i$ for $1 \leq i \leq 4$ and add the vertex $v_5 = -v_1 - \dots - v_4 = -ae_2$. We have $m = 1$ and $n = 5$. We choose

$$\epsilon_1 = \frac{1}{2a+5} \quad \epsilon_2 = \frac{1}{2a+5} \quad \epsilon_3 = \frac{1}{2a+5} \quad \epsilon_4 = \frac{a+1}{2a+5} \quad \epsilon_5 = \frac{a+1}{2a+5}$$

Taking a linear Gale transform of this, we obtain

$$\lambda_1 = \lambda_4 = 1 \quad \lambda_2 = i \quad \lambda_3 = (2a^2 + 3a) + i(2a+1) \quad \lambda_5 = -2(a+1) - 2i$$

with only one indispensable point λ_5 . We thus have the following proposition.

Proposition 9. *Let $a \in \mathbb{N}$. Consider the admissible configuration*

$$\lambda_1 = \lambda_4 = 1 \quad \lambda_2 = i \quad \lambda_3 = (2a^2 + 3a) + i(2a+1) \quad \lambda_5 = -2(a+1) - 2i$$

Then, the corresponding LVM manifold N_a is diffeomorphic to $\mathbb{S}^3 \times \mathbb{S}^3$ and is a principal fiber bundle in elliptic curves over the Hirzebruch surface F_a (where F_0 is $\mathbb{C}P^1 \times \mathbb{P}^1_{\mathbb{C}}$). The scaling of the canonical Euler form of the bundle $M_1 \rightarrow N_a$ by $2a+5$ projects onto a representant of the Chern class of the ample divisor $D = D_1 + D_2 + D_3 + (a+1)D_4$ on F_a .

Remark 20. The preceding example shows that, for special complex structures of Calabi-Eckmann type on $\mathbb{S}^3 \times \mathbb{S}^3$, there exists holomorphic principal actions of an elliptic curve whose quotient may be topologically different (since the Hirzebruch surfaces F_{2n} are all diffeomorphic to $\mathbb{S}^2 \times \mathbb{S}^2$ whereas the Hirzebruch surfaces F_{2n+1} are all diffeomorphic to the non-trivial \mathbb{S}^2 -bundle over \mathbb{S}^2 , and these two manifolds have different intersection form).

10. FROM POLYTOPES TO QUADRICS

This section and the following rely on the paper by T. Panov [71] and we also recommend [14] for this section. Let \mathbb{R}^n be given the standard inner product $\langle \cdot, \cdot \rangle$ and consider convex polyhedrons P defined as intersections of m closed half-spaces:

$$\Pi_{(a_i, b_i)} = \{x \in \mathbb{R}^n \mid \langle a_i, x \rangle + b_i \geq 0\}, \quad \text{for } i = 1, \dots, m$$

with $a_i \in \mathbb{R}^n$, $b_i \in \mathbb{R}$. Assume that the hyperplanes defined by the equations $\langle a_i, x \rangle + b_i = 0$ are in general position, i. e. at least n of them meet at a single point. Assume further that $\dim P = n$ and P is bounded (which implies that $m > n$). Then P is an n -dimensional compact simple polytope. Set

$$F_i = \{x \in P : \langle a_i, x \rangle + b_i = 0\} \quad (F \text{ for facet}).$$

Since the hyperplanes are in general position F_i is either empty or a facet of P . If it is empty the linear equation is redundant and we can remove the corresponding inequality without changing P .

Let A_P be the $m \times n$ matrix of row vectors a_i , and b_P be the column m -vector of scalars $b_i \in \mathbb{R}$ ($i \in \{1, \dots, m\}$). Then we can write:

$$P = \{x \in \mathbb{R}^n : A_P x + b_P \geq 0\}$$

and consider the affine map

$$\begin{aligned} i_P : \mathbb{R}^n &\rightarrow \mathbb{R}^m, \\ i_P(x) &= A_P x + b_P. \end{aligned}$$

It embeds P into the first orthant

$$\mathbb{R}_{\geq 0}^m = \{(y_1, \dots, y_m) \in \mathbb{R}^m \mid y_i > 0, \quad i \in \{1, \dots, m\}\}.$$

We identify \mathbb{C}^m (as a real vector space) with \mathbb{R}^{2m} as usual using the map $z = (z_1, \dots, z_m) \mapsto (x_1, y_1, \dots, x_m, y_m)$, where $z_k = x_k + iy_k$ for $k = 1, \dots, m$.

Consider the following commutative diagram where \mathcal{Z}_P is obtained by pull-back and $\mu : \mathbb{C}^m \rightarrow \mathbb{R}_{\geq 0}^m$ is given by $\mu(z_1, \dots, z_m) = (|z_1|, \dots, |z_m|)$:

$$\begin{array}{ccc} \mathcal{Z}_P & \xrightarrow{i_P^*} & \mathbb{C}^m \\ \pi \downarrow & & \downarrow \mu \\ P & \xrightarrow{i_P} & \mathbb{R}_{\geq 0}^m \end{array}$$

The map μ may be thought of as the quotient map for the coordinatewise action of the standard torus

$$\mathbb{T}^m = \{(z_1, \dots, z_m) \in \mathbb{C}^m : |z_i| = 1 \text{ for } 1 \leq i \leq m\}$$

on \mathbb{C}^m .

Therefore, \mathbb{T}^m acts on \mathcal{Z}_P with quotient P , and i_P^* is a \mathbb{T}^m -equivariant embedding.

The image of \mathbb{R}^n under i_P is an n -dimensional affine plane in \mathbb{R}^m , which can be written as

$$i_P(\mathbb{R}^n) = \{y \in \mathbb{R}^m : y = A_P(x) + b_P \text{ for some } x \in \mathbb{R}^n\} =$$

$$= \{y \in \mathbb{R}^m : \Gamma y = \Gamma b_P\},$$

where $\Gamma = ((\gamma_{jk}))$ is an $(m - n) \times m$ matrix whose rows form a basis of linear relations between the vectors a_i . That is, Γ is of full rank and satisfies the identity $\Gamma A_P = 0$.

Then we obtain that \mathcal{Z}_P embeds into \mathbb{C}^m as the set of common zeros of $m - n$ real quadratic equations:

$$\text{(Quadratic } \star) \quad i_P^*(\mathcal{Z}_P) = \left\{ z \in \mathbb{C}^m \mid \sum_{k=1}^m \gamma_{jk} |z_k|^2 = \sum_{k=1}^m \gamma_{jk} b_k, \text{ for } 1 \leq j \leq m - n \right\}$$

The following properties of \mathcal{Z}_P easily follow from its construction.

- (1) Given a point $z \in \mathcal{Z}_P$, the i^{th} coordinate of $i_P^*(z) \in \mathbb{C}^m$ vanishes if and only if z projects onto a point $x \in P$ such that $x \in F_i$ for some facet F_i .
- (2) Adding a redundant inequality to results in multiplying \mathcal{Z}_P by a circle.
- (3) \mathcal{Z}_P is a smooth manifold of dimension $m + n$. The embedding $i_P^* : \mathcal{Z}_P \rightarrow \mathbb{C}^m$ has \mathbb{T}^m -equivariantly trivial normal bundle.

11. FROM QUADRICS TO POLYTOPES (ASSOCIATED POLYTOPE OF LVM MANIFOLDS)

Let N and

$$M_1 = \{z \in \mathbb{C}^n \mid \sum_{i=1}^n \Lambda_i |z_i|^2 = 0, \sum_{i=1}^n |z_i|^2 = 1\}$$

be as before in definition 4.

Let us remark that the standard action of the torus $(\mathbb{S}^1)^n$ on \mathbb{C}^n

$$(\star\star) \quad ((\exp i\theta_1, \dots, \exp i\theta_n), z) \longmapsto (\exp i\theta_1 \cdot z_1, \dots, \exp i\theta_n \cdot z_n)$$

leaves M_1 invariant. The quotient of M_1 by this action can be identified, via the diffeomorphism $r \in \mathbb{R}_{>0}^+ \rightarrow r^2 \in \mathbb{R}_{>0}^+$, to

$$(P) \quad K = \{r \in (\mathbb{R}^+)^n \mid \sum_{i=1}^n r_i \Lambda_i = 0, \sum_{i=1}^n r_i = 1\}$$

Lemma 7. *The quotient K is a convex polytope of dimension $n - 2m - 1$ with $n - k$ facets.*

Proof. By definition K is the intersection of the space A of solutions of an affine system with the closed sets $r_i \geq 0$. Each one of these closed sets defines an affine half-space $A \cap \{r_i \geq 0\}$ in the affine space A . In other words, K is the intersection of a finite number of affine half-spaces. Since this intersection is bounded (since M_1 is compact), one obtains indeed a convex polytope. The weak hyperbolicity condition implies that the affine system that defines K is of maximal rank. Hence, K is of dimension $n - 2m - 1$.

Let us consider in more detail the definition of K . The points $r \in K$ verifying $r_i > 0$ for all i are the points which belong to the interior of the convex polytope. They correspond to the points z de M_1 which also belong to $(\mathbb{C}^*)^n$, i.e. to the points of M_1 such that the orbit under the action $(\star\star)$ is isomorphic to $(\mathbb{S}^1)^n$. The points which belong to a hyperface are exactly the points r of K having all of its coordinates *except one* equal to zero. They correspond to the points z de M_1 which have a unique coordinate equal to zero, i.e. such that its orbit under the action $(\star\star)$ is isomorphic to $(\mathbb{S}^1)^{n-1}$. One obtains from the definition of K that there exist points of K having all coordinates different from zero except the i^{th} coordinate if and only if 0 belongs to the convex envelope of the configuration formed by the Λ_j with j different from i ; hence if and only if Λ_i is a point which can be eliminated keeping the conditions of Siegel and weak hyperbolicity. therefore one has $n - k$ hyperfaces. \square

Definition 17. One calls the convex polytope $K = K_{\mathbf{\Lambda}}$ corresponding to the admissible configuration $\mathbf{\Lambda}$ the *associated polytope*. The polytopes $\mathcal{H}(\mathbf{\Lambda})$ and $K_{\mathbf{\Lambda}}$ are related by the Gale transform.

One central idea is that the topology of the manifolds M_1 , and therefore of the manifolds N , is codified by the combinatorial type of the polytope K . To make this idea more precise, it is interesting to push to the end the reasoning involved in the proof of the preceding lemma. One had seen that

$$K_i = K \cap \{r_i = 0, r_j > 0 \text{ for } j \neq i\}$$

is nonempty, and therefore is a hyperface de K , if and only if

$$0 \in \mathcal{H}((\Lambda_j)_{j \neq i}).$$

Analogously, given I a subset of $\{1, \dots, n\}$, the set

$$K_I = K \cap \{r_i = 0 \text{ for } i \in I, r_j > 0 \text{ for } j \notin I\}$$

is nonempty, and therefore it is a facet of K of codimension equal the cardinality of I , if and only if

$$0 \in \mathcal{H}((\Lambda_j)_{j \notin I})$$

One has therefore established a very important correspondence between two convex polytopes: the polytope K on one hand and the convex hull of the Λ_i 's on the other hand.

This correspondence allows us to to prove the following result:

Remark 21. It follows from [68, Lemma 1.1] that

$$\text{rank}_{\mathbb{C}} \begin{pmatrix} \Lambda_1 & \cdots & \Lambda_n \\ 1 & \cdots & 1 \end{pmatrix} = m + 1.$$

Hence, up to a permutation, condition (15) is always fulfilled.

Definition 18. We say that N_{Λ} and $N_{\Lambda'}$ are G -biholomorphic if they are $(G(\Lambda), G(\Lambda'))$ -equivariantly biholomorphic.

Recall that by definition † the manifold N_{Λ} embeds in \mathbb{P}^{n-1} as the C^{∞} submanifold

$$(20) \quad N = \{[z] \in \mathbb{P}^{n-1} \mid \sum_{i=1}^n \Lambda |z_i|^2 = 0\}.$$

It is crucial to notice that this embedding is not arbitrary but has a clear geometric meaning. Indeed, it is proven in that action (27) induces a foliation of \mathcal{S}_{Λ} ; that every leaf admits a unique point closest to the origin (for the euclidean metric); and finally that N is the projectivization of the set of all these minima. This is a sort of non-algebraic Kempf-Ness Theorem. So we may say that this embedding is canonical.

The maximal compact subgroup $(\mathbb{S}^1)^n \subset (\mathbb{C}^*)^n$ acts on \mathcal{S}_{Λ} , and thus on N_{Λ} . This action is clear on the smooth model (30). Notice that it reduces to a $(\mathbb{S}^1)^{n-1}$ since we projectivized everything.

The quotient of N_{Λ} by this action is easily seen to be a simple convex polytope of dimension $n - 2m - 1$, cf. Up to scaling, it is canonically identified to

$$(21) \quad K_{\Lambda} := \{r \in (\mathbb{R}^+)^n \mid \sum_{i=1}^n \Lambda r_i = 0, \sum_{i=1}^n r_i = 1\}.$$

It is important to have a description of K_{Λ} as a convex polytope in \mathbb{R}^{n-2m-1} . This can be done as follows. Take a Gale diagram of Λ , that is a basis of solutions (v_1, \dots, v_n) over \mathbb{R} of the system **S**:

$$(S) \quad \begin{cases} \sum_{i=1}^n \Lambda_i x_i = 0 \\ \sum_{i=1}^n x_i = 0 \end{cases}$$

Take also a point ϵ in K_{Λ} . This gives a presentation of K_{Λ} as

$$(22) \quad \{x \in \mathbb{R}^{n-2m-1} \mid \langle x, v_i \rangle \geq -\epsilon_i \text{ for } i = 1, \dots, n\}$$

This presentation is not unique. Indeed, taking into account that K_{Λ} is unique only up to scaling, we have

Lemma 8. *The projection (33) is unique up to action of the affine group of \mathbb{R}^{n-2m-1} .*

On the combinatorial side, K_{Λ} has the following property. A point $r \in K_{\Lambda}$ is a vertex if and only if the set I of indices i for which r_i is zero is maximal, that is has $n - 2m - 1$ elements. Moreover, we have

$$(23) \quad r \text{ is a vertex} \iff \mathcal{S}_{\Lambda} \cap \{z_i = 0 \text{ for } i \in I\} \neq \emptyset \iff 0 \in \mathcal{H}(\Lambda_{I^c})$$

for I^c the complementary subset to I in $\{1, \dots, n\}$. This gives a numbering of the faces of K_{Λ} by the corresponding set of indices of zero coordinates.

More precisely, we have

$$(24) \quad \begin{aligned} J \subset \{1, \dots, n\} \text{ is a face of codimension Card } J \\ \iff \mathcal{S}_\Lambda \cap \{z_i = 0 \text{ for } i \in J\} \neq \emptyset \iff 0 \in \mathcal{H}(\Lambda_{J^c}) \end{aligned}$$

In particular, K_Λ has $n - k$ facets. Observe moreover that the action (27) fixes $\mathcal{S}_\Lambda \cap \{z_i = 0 \text{ for } i \in J\}$, hence its quotient defines a submanifold N_J of N_Λ of codimension Card J .

12. MOMENT-ANGLE MANIFOLDS

We will explain the link between the moment-angle manifolds in definition 4 and the manifolds studied by V. Buchstaber et T. Panov in [14]. Let P be a simple convex polytope with the set $\mathcal{F} = \{F_1, \dots, F_n\}$ of hyperfaces (*i.e.*, codimension one faces). Let $T_i \simeq \mathbb{S}^1$ for $1 \leq i \leq n$ and let $T_{\mathcal{F}} = T_1 \times \dots \times T_n \simeq (\mathbb{S}^1)^n = \mathbb{T}^n$ be the n torus with its standard group structure. For each hyperface F_i associate T_i , the circle corresponding to the i^{th} coordinate of \mathbb{T}^n . If G is a face of the polytope P let

$$T_G = \prod_{F_i \supset G} T_i \subset T_{\mathcal{F}}$$

For each point $q \in P$, let $G(q)$ be the unique face of P which contains q in its relative interior

Definition 19. The *moment-angle complex* \mathcal{Z}_P associated to P is defined as

$$\mathcal{Z}_P = (T_{\mathcal{F}} \times P) / \sim$$

where the equivalence relation is: $(t_1, p) \sim (t_2, q)$ if and only if $p = q$ and $t_1 t_2^{-1} \in T_{G(q)}$.

The *moment-angle complex* \mathcal{Z}_P depends only upon the combinatorial type of P and it admits a natural continuous action of the n -torus $T_{\mathcal{F}}$ having as quotient P . The fact that P is simple implies that \mathcal{Z}_P is a topological manifold (see [14] Lemma 6.2).

Consider now the moment-angle manifolds $M_1(\Lambda)$ defined by formula (4) and let K_Λ the associated polytope (17). One has the natural projection $\Pi : M_1(\Lambda) \rightarrow K_\Lambda$. The faces of codimension q of $K(\Lambda)$ correspond to the orbits of the points of \mathcal{V} which have some precise q coordinates fixed. In other words the orbits above the relative interior of a codimension q face are isomorphic to $(\mathbb{S}^1)^{n-q}$. En poussant un peu plus loin cette description, on montre le lemme suivant.

Lemma 9. ([11] Lemma 0.15). *Let N_Λ be an LVM manifold without indispensable points. Let K_Λ be its associated polytope. Then there exists an equivariant homeomorphism between $M_1(\Lambda)$ and the moment-angle variety \mathcal{Z}_{K_Λ} .*

Equivariant homeomorphism means that the homeomorphism conjugates the action ($\star\star$) of on $M_1(\Lambda)$ to the action of $T_{\mathcal{F}}$ on \mathcal{Z}_P .

Hence:

Corollary 5. *Let N_Λ et $N_{\Lambda'}$ two LVM manifolds without indispensable points. Then there exists an equivariant homeomorphism of the associated moment-angle varieties $M_1(\Lambda)$ and $M_1(\Lambda')$ if and only if the associated polytopes K_Λ et $K_{\Lambda'}$ are combinatorially equivalent. More generally, there exists an equivariant homeomorphism between $M_1(\Lambda)$ and $M_1(\Lambda')$ if and only if K_Λ and $K_{\Lambda'}$ are combinatorially equivalent the number of indispensable points k and k' , respectively, are equal.*

Proof. The combinatorial equivalence between K_Λ and $K_{\Lambda'}$ implies the existence of an equivariant homeomorphism between \mathcal{Z}_{K_Λ} and $\mathcal{Z}_{K_{\Lambda'}}$, and hence by lemma 9 between $M_1(\Lambda)$ and $M_1(\Lambda')$. The proof for any number of indispensable points follows from the first result and lemma 9. \square

It is more delicate to have the same result up to *equivariant diffeomorphism*, however one has the following theorem:

Theorem 11. ([11] Theorem 4.1). *There is an equivalence between the following assertions:*

- (i) *The manifolds $M_1(\mathbf{\Lambda})$ and $M_1(\mathbf{\Lambda}')$ are equivariantly diffeomorphic*
- (ii) *The corresponding associated polytopes $K_{\mathbf{\Lambda}}$ and $K_{\mathbf{\Lambda}'}$ are combinatorially equivalent and the number of indispensable points k and k' are equal.*

13. FLIPS OF SIMPLE POLYTOPES AND ELEMENTARY SURGERIES ON LVM MANIFOLDS

The motivation of this section is to generalize the following result of Mac Gavran [59] adapted to our case.

Theorem 12. (Mac Gavran [59]). *Let $\mathbf{\Lambda}$ be an admissible configuration. Suppose that the associated polytope $K_{\mathbf{\Lambda}}$ is a polygon with p vertices. Then the moment-angle manifold $M_1(\mathbf{\Lambda})$ is diffeomorphic via an equivariant diffeomorphism to the connected sum of products of spheres;*

$$\left(\#_{j=1}^{p-3} (jC_{p-2}^{j+1}) \mathbb{S}^{2+j} \times \mathbb{S}^{p-j}\right) \times (\mathbb{S}^1)^k$$

There are many cases of configurations for higher-dimensional polytopes where the manifolds $M_1(\mathbf{\Lambda})$ are similar to those of Mac Gavran *i.e.*, the manifolds are products of manifolds of the type:

- (i) Odd dimensional spheres.
- (ii) Connected sums of products of spheres

F. Bosio and L. Meersseman [11] showed that some, but not all, moment-angle manifolds $M_{\mathbf{\Lambda}}$ are connected sums of products of spheres, and they conjectured that if the dual to the polytope is neighborly, then the manifold is such a connected sum. This conjecture was proven by Samuel Gitler and Santiago López de Medrano in [35].

Let us remember once more the results by S. López de Medrano ([48] et [49]) on the classification of manifolds $M_1(\mathbf{\Lambda})$ when $m = 1$ given above in subsection 3.5 given by Theorem 1

When $m = 1$ the vectors are vectors Λ_i in $\mathbb{C} \simeq \mathbb{R}^2$ and S. López de Medrano shows that one can modify the configuration $\mathbf{\Lambda} \in \mathbb{C}$ through a smooth homotopy $\mathbf{\Lambda}_t$ (just moving the vectors) that *satisfies the admissibility conditions of Siegel and weak hyperbolicity for all $t \in [0, 1]$* such that $\mathbf{\Lambda}_0 = \mathbf{\Lambda}$ and $\mathbf{\Lambda}_1$ is a regular polygon with an odd number of vertices $2l + 1$ and with multiplicities n_1, \dots, n_{2l+1} . Thus, for instance, in figure 5, one can move from the pentagon at the left to the pentagon at the right to configurations with different multiplicities, for instance configurations with 4 vectors with multiplicities $n_1 = n_2 = 1$ and $n_3 = 3$, then 3 vectors of multiplicities $n_1 = 1, n_2 = n_3 = 2$, and finally 5 vectors of multiplicity 1. Ehresmann lemma implies, that all manifolds belonging to the homotopy are diffeomorphic.

With these notations we recall theorem 1 which was seen before:

Theorem 13. [48], [49] *Let N be an LVM manifold $m = 1$ then M_1 is diffeomorphic to*

- (i) *The product of spheres $\mathbb{S}^{2n_1-1} \times \mathbb{S}^{2n_2-1} \times \mathbb{S}^{2n_3-1}$ if $l = 1$.*
- (ii) *The connected sum*

$$\#_{i=1}^{2l+1} \mathbb{S}^{2d_i-1} \times \mathbb{S}^{2n-2d_i-2}$$

if $l > 1$. Where $d_i = n_{[i]} + \dots + n_{[i+l-1]}$ and $[a]$ is the residue of the euclidean division of a by $2l + 1$.

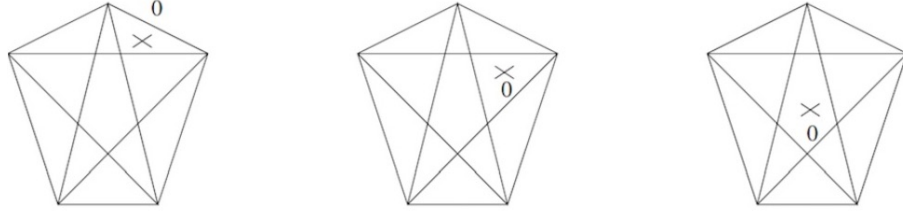

FIGURE 5. *Chambers of a pentagon in \mathbb{C} (the small cross is the origin in \mathbb{C})*

If $m > 1$ one has a higher dimensional polytope of n elements in \mathbb{C}^m ($n > 2m$) and there is not a way to have a canonical model. One could consider a homotopy that takes the configuration to one with minimal number of vertices, but that is not enough to determine the polytope which is the convex hull of the points in the configuration. For this reason it is better to adapt the approach used by Mac Gavran in [59]. He considers simply connected manifolds of dimension $p + 2$ which admit a smooth action of a torus $(\mathbb{S}^1)^p$ which satisfies certain conditions, in particular one requires that the quotient under the action can be identified with a 2-dimensional convex polygon K with p vertices. If we write $M_1 \simeq (\mathbb{S}^1)^k \times M_0$, where \simeq means “up to an equivariant diffeomorphism”, then as in lemma 14 one shows that the factor M_0 verifies the hypotheses of Mac Gavran. The proof of Mac Gavran theorem is done by induction on the number p of vertices of K . If $p = 3$ one has a triangle and we know that M_1 is $\mathbb{S}^5 \times (\mathbb{S}^1)^k$, where M_0 is the sphere \mathbb{S}^5 . To go from a polygon with p vertices to a polygon with $p + 1$ vertices one can do the following “surgery”: remove an open neighborhood of a vertex and glue an interval. The reciprocal operation consists in collapsing to a point an edge. Now we recall that the faces of the associated polytope corresponding to the admissible sub-configurations of $\mathbf{\Lambda}$ (i.e, subsets of $\mathbf{\Lambda}$) determine equivariant subvarieties of M_1 or M_0 where the quotient space identifies in a natural way with the given face. In other words to remove a neighborhood of a face means to remove an invariant (under the action of the torus) tubular neighborhood of the subvariety associated to the face in question in M_0 . The invariant subvarieties have trivial tubular neighborhoods (by the slice theorem). Since we know that the subvarieties associated to a vertex is a torus and the subvarieties associated to an edge are the product of a torus with \mathbb{S}^3 , one sees that if M_p denotes the manifold corresponding to a polygon K with p vertices, then to pass from M_p a M_{p+1} consists of applying an equivariant surgery

$$M_{p+1} = (M_p \times \mathbb{S}^1) \setminus ((\mathbb{S}^1)^{p-2} \times \mathbb{D}^4 \times \mathbb{S}^1) \cup ((\mathbb{S}^1)^{p-2} \times \mathbb{S}^3 \times \mathbb{D}^2)$$

Where \mathbb{D}^s denotes the closed disk of dimension s . The work of Mac Gavran consists of understanding the meaning of these surgeries up to equivariant diffeomorphisms. To generalize this approach to higher dimensional polytopes K we need to generalize the notion of “surgery”. and understand what is the construction one has to perform on the moment angle manifold M_1 associated to K . This is done using the following notion of cobordism between polytopes inspired by [60] et [79].

Definition 20. Let P and Q be two simple convex polytopes of the same dimension p . One says that P and Q are obtained from each other by an *elementary cobordism* if there exists a simple convex polytope W of dimension $p + 1$ such that:

- (i) P and Q are disjoint hyperfaces of W .
- (ii) There exists a unique vertex v of W that does not belong neither to P or Q .

Let us recall that everything related to polytopes is up to combinatorial equivalence for instance figure 6 illustrates an elementary cobordism between a square and a pentagon.

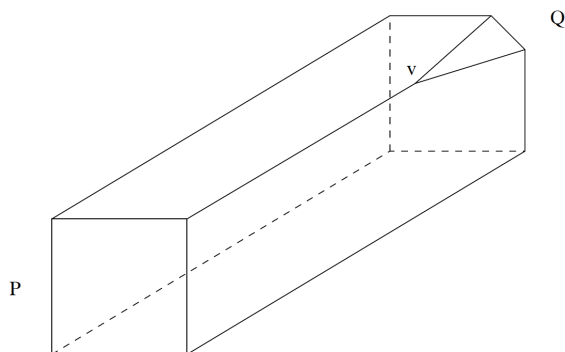

FIGURE 6. *Elementary Cobordism between a square and a pentagon*

Given a vertex v , since W is simple, there are exactly $q + 1$ edges that have v as an end point. Then, hypothesis (ii) these edges have the second end point either in P or in Q , then the *type* of the elementary cobordism is the pair (a, b) where a (respectively b) is the number of edges joining v to P (respectively Q). Of course $a + b = q + 1$,

Definition 21. One says that Q is obtained from P by a flip of type (a, b) if there exists an elementary cobordism of type (a, b) between P and Q .

Figure 7 shows an example of type $(2, 2)$.

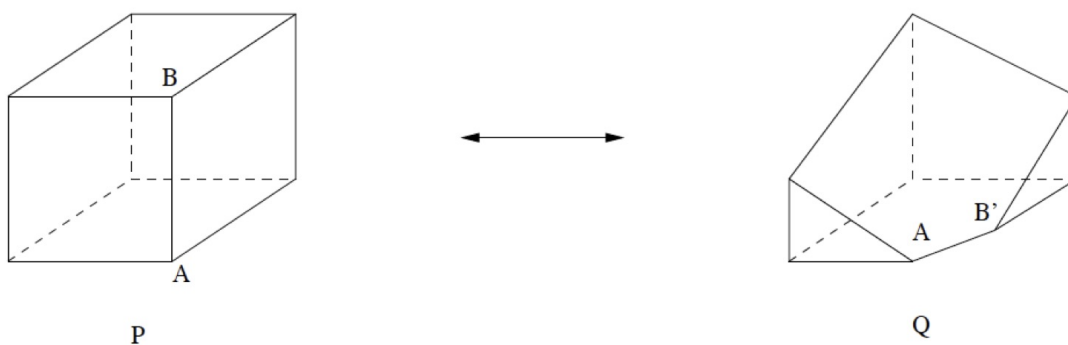

FIGURE 7. *Flip de type (2, 2)*

Let us consider the elementary cobordism W of dimension 4 between the 3-dimensional polyhedra P and Q and let us “cut” W with 3-dimensional hyperplanes parallel to P . Starting from P one sees that the edge $[AB]$ is contracted as one moves the cuts up to the point when the edge collapses

to the vertex $v = A$ when the cut meets the vertex A . On the other hand if one makes cuts by hyperplanes parallel to Q the edge $[AB]$ is contracted to $v = A$. In some sense W is the *trace* of the cobordism. In other words Q is obtained P by removing a neighborhood of the edge $[AB]$ and gluing the “transverse” edge $[AB']$.

This description can be generalized for higher dimensional polytopes. A flip of type (a, b) is obtained by removing a simplicial face of dimension a and gluing the neighborhood of a simplicial face of “complementary” dimension b . Since the simplicial faces of dimension a correspond to products of a sphere of dimension $2a - 1$ by a torus ([11] Proposition 3.6) an argument similar to that of Mac Gavran shows that if K' is obtained from K (of dimension q) by a flip of type (a, b) , then the manifold $(M_0)'$ is obtained from M_0 (de dimension p) by an elementary *surgery of type* (a, b) then:

$$(M_0)' = (M_0 \times \mathbb{S}^1) \setminus ((\mathbb{S}^1)^{p-2b} \times \mathbb{D}^{2b} \times \mathbb{S}^1) \cup ((\mathbb{S}^1)^{p-2b} \times \mathbb{S}^{2b-1} \times \mathbb{D}^2)$$

if $a = 1$ and

$$(M_0)' = M_0 \setminus ((\mathbb{S}^1)^{p-2b-2a+1} \times \mathbb{D}^{2b} \times \mathbb{S}^{2a-1}) \cup ((\mathbb{S}^1)^{p-2b-2a+1} \times \mathbb{S}^{2b-1} \times \mathbb{D}^{2a})$$

if $a > 1$.

The proof of this fact is very delicate and technical since we must prove the equivariance of the constructions. All the details can be found in [11].

The essential difference with the case of polygons of Mac Gavran is that starting with an odd-dimensional sphere as M_0 after a finite number of elementary surgeries one does not end up with a manifold of the type connected sum of products of spheres or product of spheres. In fact in the next section one will describe the homology. However the previous considerations prove again that if two moment-angle manifolds of type M_1 of dimension p are combinatorially equivalent they are obtained from the sphere \mathbb{S}^{2p-1} by the same sequence of elementary surgeries and therefore they are equivariantly diffeomorphic.

14. THE HOMOLOGY OF LVM MANIFOLDS

Recall that from lemma we have that for a configuration \mathbf{A} the associated moment angle manifold $M_1(\mathbf{A})$ factorizes as $M_1(\mathbf{A}) \simeq (\mathbb{S}^1)^k \times M_0(\mathbf{A})$ where k is the number of indispensable points and $M_0(\mathbf{A})$ is 2-connected. Since M_0 is a moment-angle manifold one can use the results of V. Buchstaber and T. Panov [14] to compute the homology and cohomology of these manifolds

Theorem 14. ([11], **Theorem 10.1.**) *Soit $N_{\mathbf{A}}$ be an LVM manifold and $M_0(\mathbf{A})$ the 2-connected factor as in 14. Let K be the associated polytope (quotient under the action of the torus). Let K^* be its dual which is therefore a convex simplicial polytope. Let \mathbf{F} be its set of vertices. Then the homology of $M_0(\mathbf{A})$ with coefficients in \mathbb{Z} is given by the formula:*

$$H_i(M_0(\mathbf{A}), \mathbb{Z}) = \bigoplus_{\mathcal{I} \subset \mathbf{F}} \tilde{H}_{i-|\mathcal{I}|-1}(K_{\mathcal{I}}^*, \mathbb{Z})$$

where \tilde{H}_i denotes the reduced homology, $|\mathcal{I}|$ is the cardinality of \mathcal{I} and $K_{\mathcal{I}}^*$ is the maximal simplicial subcomplex of K^* with vertices \mathcal{I} . (We remark that $H_i(M_0(\mathbf{A}), \mathbb{Z}) = 0$ if $i < 0$).

Let us explain the meaning of *maximal simplicial subcomplex of K^* with vertices \mathcal{I}* . Given a q -tuple (i_1, \dots, i_q) in \mathcal{I} it is a face of the simplicial subcomplex $K_{\mathcal{I}}^*$ if and only if a q -face of the simplicial complex K^* . For instance in figure 8 (K^* is the octahedron which is the dual of the cube K) the subcomplex which corresponds to the vertices $\{1, 2, 3, 4\}$ is indicated in boldface.

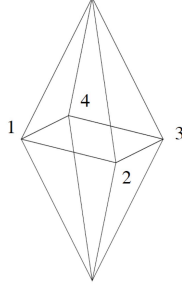

FIGURE 8.

Let us consider now the question of the level of complexity of the homology of the manifolds $M_0(\mathbf{A})$. By theorem 14 the dual polytope K^* can be an arbitrary simplicial complex and the question of complexity becomes to ask which simplicial complexes can be *maximal* subcomplexes of a simplicial convex polytope. We claim that any finite simplicial complex can be a *maximal* sub-complexes of a simplicial convex polytope. In effect, let K_0 be any finite simplicial complex, we can always embed K_0 in a simplex \mathfrak{S}^d of dimension d equal to the number of vertices of K_0 minus one. In general is not embedded in a maximal subcomplex For instance in figure 8, K_0 is the one-dimensional complex with is a circuit of four edges with vertices in boldface. It can be embedded in a tetrahedron \mathfrak{S}^3 as a circuit with 4 vertices but the maximal associated subcomplex is the tetrahedron itself so this embedded copy is not maximal but we can fix this by choosing a barycentric subdivision of the tetrahedron. In general it is enough to make barycentric subdivision of all the faces that belong to the maximal simplicial complex generated by K_0 to obtain an embedding which is maximal. *This is always possible* (see [11]).

Therefore one has:

Theorem 15. ([11], **Théorème 14.1**). *Let K_0 be any finite simplicial complex. Then there exists a 2-connected LVM manifold N such that its homology verifies:*

$$H_{i+q+1}(N, \mathbb{Z}) = \tilde{H}_i(K_0, \mathbb{Z}) \oplus \dots$$

for all i between 0 and the dimension of K_0 .

Hence there exist an LVM manifold such that its homology has as a direct summand the homology of a given simplicial complex, in particular its homology can be as complex as one wishes. For instance, given a finite abelian group \mathfrak{G} there exists a configuration \mathbf{A} such that $N_{\mathbf{A}}$ has as subgroup \mathfrak{G} in its group of torsion.

Remark 22. In ([11], **Theorem 10.1**) one finds a formula describing the ring structure via the cup product of the cohomology of these manifolds.

Remark 23. More details and results about the homology of moment-angle manifolds using the fact that they have in many cases an open-book structure will be found in section 17 subsection 17

15. WALL-CROSSING

Let us consider again figure 5 before now considered as figure 9 with the purpose of illustrating the process of *wall-crossing*

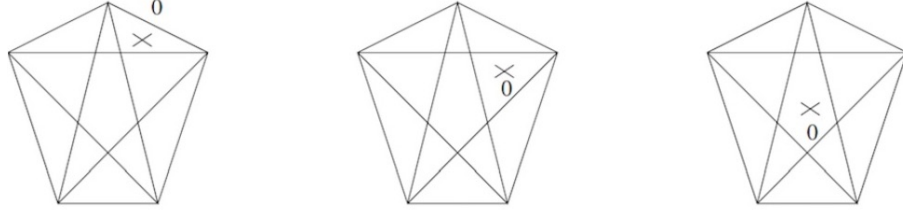

FIGURE 9. *Wall-crossing from one chamber to another*

Consider in figure 9 different positions of the origin (marked as a cross) with respect to a configuration which is a regular pentagon and in the three positions the pentagon has been translated so that the origin is in different “chambers” bounded by the diagonals of the pentagon. We see that if the point marked with a cross moves from the figure on the left to the figure on the right then the figure in the left has two indispensable points, in the second there is one indispensable point and in the figure at right there are not indispensable points. The manifolds from left to right are, respectively, $\mathbb{S}^5 \times \mathbb{S}^1 \times \mathbb{S}^1$, then $\mathbb{S}^3 \times \mathbb{S}^3 \times \mathbb{S}^1$ and finally $\#5(\mathbb{S}^3 \times \mathbb{S}^4)$.

As we mentioned before, these configurations are similar: one passes from one to the other translating $\mathbf{\Lambda}$ by a family $\mathbf{\Lambda}_t$ or if one wishes translating the origin. If we take the latter perspective and if we regard the translation of the origin as a homotopy along which 0 moves, we see that there is a moment in which 0 crosses at certain moment a “wall” $[\Lambda_i \Lambda_j]$ (in fact one crosses first a wall to go from left to the middle and the another to go from the middle to the right). The topology changes exactly after crossing the wall. In effect, if 0 does not encounters the wall the configuration is admissible and $M_1(\mathbf{\Lambda})$ does not change differentiably (again using Ehresmann lemma). After crossing the mure the topology of M_1 changes drastically and after crossing the wall, by the same argument using Ehresmann lemma, nothing happens for the rest of the homotopy.

This situation generalizes to every dimension

Question. *How does the topology of M_1 changes when we cross a wall?*

Let us see what happens in our example in figure 9 at the level of the associated polygons. At the left one has a triangle, in the middle a square and finally at right a pentagon. In other words one passes from the configuration at the left to the configuration in the middle by a surgery of type (1,2), then from the configuration in the middle to that in the right to a second surgery of type (1,2). This solves completely this particular case.

Some simple arguments of convex geometry allows us to see that everything is analogous in the general case. When one crosses a wall in a configuration $(\Lambda_1, \dots, \Lambda_n)$, the wall is supported by $2m$ vectors Λ_i . This wall separates the convex envelope of $\mathbf{\Lambda}$ in two connected components one contains 0 *before* the other contains 0 *after*. The Λ_j 's which do not belong to the wall divide in two parts: a

belong to the part that contains 0 before crossing the wall and b to the part that contains 0 after crossing the wall. One of course has $a + b = n - 2m$, namely $a + b$ is equal to the dimension of the associated polytope plus one. We say that it is a wall-crossing of type (a, b) .

With this notation we have:

Theorem 16. ([11], Theorem 5.4.) *Let $\mathbf{\Lambda}$ et $\mathbf{\Lambda}'$ be two admissible configurations. Suppose that $\mathbf{\Lambda}'$ is obtained from $\mathbf{\Lambda}$ through a wall crossing of type (a, b) . Then*

- (i) *The polytope associated to K' is obtained from K by a flip of type (a, b) .*
- (ii) *The manifold $M_1(\mathbf{\Lambda}')$ is obtained from $M_1(\mathbf{\Lambda})$ by an elementary surgery of type (a, b) .*

One can be more precise and characterize the face of the polytope where the “flip” happens (or equivalently the subvariety along which we perform an equivariant surgery in function of the wall)

16. LVMB MANIFOLDS

Recall that

$$(25) \quad \mathcal{S} := \{z \in \mathbb{C}^n \mid 0 \in \mathcal{H}(\Lambda_{I_z})\}$$

where

$$(26) \quad i \in I_z \iff z_i \neq 0.$$

Then $N_{\mathbf{\Lambda}}$ is the quotient of the projectivization $\mathbb{P}(\mathcal{S})$ by the holomorphic action

$$(27) \quad (T, [z]) \in \mathbb{C}^m \times \mathbb{P}(\mathcal{S}) \longmapsto [z_i \exp\langle \Lambda_i, T \rangle]_{i=1, \dots, n}$$

where $\langle -, - \rangle$ denotes the inner product of \mathbb{C}^m , and not the hermitian one. It is a compact complex manifold of dimension $n - m - 1$, which is either a m -dimensional compact complex torus (for $n = 2m + 1$) or a non kähler manifold (for $n > 2m + 1$).

16.1. Bosio manifolds. In [12], Frédéric Bosio gave a generalization of the previous construction. His idea was to relax the weak hyperbolicity and Siegel conditions for $\mathbf{\Lambda}$ and to look for all the subsets \mathcal{S} of \mathbb{C}^n such that action (27) is free and proper.

To be more precise, let $n \geq 2m + 1$ and let $\mathbf{\Lambda} = (\Lambda_1, \dots, \Lambda_n)$ be a configuration of n vectors in \mathbb{C}^m . Let also \mathcal{E} be a non-empty set of subsets of $\{1, \dots, n\}$ of cardinal $2m + 1$ and set

$$(28) \quad \mathcal{S} = \{z \in \mathbb{C}^n \mid I_z \supset E \text{ for some } E \in \mathcal{E}\}$$

Assume that

- (i) For all $E \in \mathcal{E}$, the affine hull of $(\Lambda_i)_{i \in E}$ is the whole \mathbb{C}^m .
- (ii) For all couples $(E, E') \in \mathcal{E} \times \mathcal{E}$, the convex hulls $\mathcal{H}((\Lambda_i)_{i \in E})$ and $\mathcal{H}((\Lambda_i)_{i \in E'})$ have non-empty interior.
- (iii) For all $E \in \mathcal{E}$ and for every $k \in \{1, \dots, n\}$, there exists some $k' \in E$ such that $E \setminus \{k'\} \cup \{k'\}$ belongs to \mathcal{E} .

Then, action (27) is free and proper [12, Théorème 1.4]. We still denote it by $N_{\mathbf{\Lambda}}$ although it also depends on the choice of \mathcal{S} . As in the LVM case, it is a compact complex manifold of dimension $n - m - 1$, which is either a m -dimensional compact complex torus (for $n = 2m + 1$) or a non Kähler manifold (for $n > 2m + 1$).

Assume now that $(\Lambda_1, \dots, \Lambda_n)$ is an admissible configuration. Let

$$(29) \quad \mathcal{E} = \{I \subset \{1, \dots, n\} \mid 0 \in \mathcal{H}((\Lambda_i)_{i \in I})\}$$

Then (28) and (25) are equal, the previous three properties are satisfied and the LVMB manifold is exactly the corresponding LVM.

We say that Λ_i , or simply i , is an *indispensable point* if every point z of \mathcal{S} satisfies $z_i \neq 0$. We denote by k the number of indispensable points.

16.1.1. *The associated polytope of a LVM manifold.* In this section, N_Λ is a LVM manifold. Recall that the manifold N_Λ embeds in \mathbb{P}^{n-1} as the C^∞ submanifold

$$(30) \quad N = \{[z] \in \mathbb{P}^{n-1} \mid \sum_{i=1}^n \Lambda |z_i|^2 = 0\}.$$

It is crucial to notice that this embedding is not arbitrary but has a clear geometric meaning. Indeed, it is proven in [63] that action (27) induces a foliation of \mathcal{S} ; that every leaf admits a unique point closest to the origin (for the euclidean metric); and finally that (30) is the projectivization of the set of all these minima¹. So we may say that this embedding is canonical.

The maximal compact subgroup $(\mathbb{S}^1)^n \subset (\mathbb{C}^*)^n$ acts on \mathcal{S} , and thus on N_Λ . This action is clear on the smooth model (30). Notice that it reduces to a $(\mathbb{S}^1)^{n-1}$ since we projectivized everything.

The quotient of N_Λ by this action is easily seen to be a simple convex polytope of dimension $n - 2m - 1$, cf. [63] and [68]. Up to scaling, it is canonically identified to

$$(31) \quad K_\Lambda := \{r \in (\mathbb{R}^+)^n \mid \sum_{i=1}^n \Lambda r_i = 0, \sum_{i=1}^n r_i = 1\}.$$

It is important to have a description of K_Λ as a convex polytope in \mathbb{R}^{n-2m-1} . This can be done as follows. Take a Gale diagram of Λ , that is a basis of solutions (v_1, \dots, v_n) over \mathbb{R} of the system

$$(32) \quad \begin{cases} \sum_{i=1}^n \Lambda_i x_i = 0 \\ \sum_{i=1}^n x_i = 0 \end{cases}$$

Take also a point ϵ in K_Λ . This gives a presentation of K_Λ as

$$(33) \quad \{x \in \mathbb{R}^{n-2m-1} \mid \langle x, v_i \rangle \geq -\epsilon_i \text{ for } i = 1, \dots, n\}$$

This presentation is not unique. Indeed, taking into account that K_Λ is unique only up to scaling, we have

Lemma 10. *The projection (33) is unique up to action of the affine group of \mathbb{R}^{n-2m-1} .*

On the combinatorial side, K_Λ has the following property. A point $r \in K_\Lambda$ is a vertex if and only if the set I of indices i for which r_i is zero is maximal, that is has $n - 2m - 1$ elements. Moreover, we have

$$(34) \quad r \text{ is a vertex} \iff \mathcal{S} \cap \{z_i = 0 \text{ for } i \in I\} \neq \emptyset \iff 0 \in \mathcal{H}(\Lambda_{I^c})$$

for I^c the complementary subset to I in $\{1, \dots, n\}$. This gives a numbering of the faces of K_Λ by the corresponding set of indices of zero coordinates. To be more precise, we have

$$(35) \quad \begin{aligned} J \subset \{1, \dots, n\} \text{ is a face of codimension } \text{Card } J \\ \iff \mathcal{S} \cap \{z_i = 0 \text{ for } i \in J\} \neq \emptyset \iff 0 \in \mathcal{H}(\Lambda_{J^c}) \end{aligned}$$

¹This is a sort of non-algebraic Kempf-Ness Theorem.

In particular, K_Λ has $n-k$ facets. Observe moreover that the action (27) fixes $\mathcal{S} \cap \{z_i = 0 \text{ for } i \in J\}$, hence its quotient defines a submanifold N_J of N_Λ of codimension $\text{Card } J$.

Also, (35) implies that

$$(36) \quad \mathcal{S} = \{z \in \mathbb{C}^n \mid I_z^c \text{ is a face of } K_\Lambda\}$$

17. MOMENT-ANGLE MANIFOLDS AND INTERSECTION OF QUADRICS

Remark 24. This section is based on the papers [9, 10, 35] and it borrows freely a lot from them. In order to be compatible with the notation in these papers, we use in this section sometimes different notations that the ones used in the previous sections, for instance the moment-angle manifolds $M_1(\mathbf{\Lambda})$ are called here $Z^c(\mathbf{\Lambda})$ and the corresponding LVM manifolds N_Λ are denoted here $\mathcal{N}(\mathbf{\Lambda}) = Z^c(\mathbf{\Lambda})/S^1$

The topology of generic intersections of quadrics in \mathbb{R}^n of the form:

$$\sum_{i=1}^n \lambda_i x_i^2 = 0, \quad \sum_{i=1}^n x_i^2 = 1, \quad \text{where } \lambda_i \in \mathbb{R}^k, i = 1, \dots, n$$

appears naturally in many instances and has been studied for many years. If $k = 2$ they are diffeomorphic to a triple product of spheres or to the connected sum of sphere products ([36, 49]); for $k > 2$ this is no longer the case ([5], [11]) but there are large families of them which are again connected sums of spheres products ([35]).

The generic condition, known as *weak hyperbolicity* and equivalent to regularity of the manifold, is the following:

If $J \subset 1, \dots, m$ has k or fewer elements then the origin is not in the convex hull of the λ_i with $i \in J$.

A crucial feature of these manifolds is that they admit natural group actions: all of them admit \mathbb{Z}_2^n actions by changing the signs of the coordinates.

Their complex versions in \mathbb{C}^n , which we denote by Z^c or $Z^c(\mathbf{\Lambda})$ (denoted by $M_1(\mathbf{\Lambda})$ in the previous sections),

$$\sum_{i=1}^n \lambda_i |z_i|^2 = 0, \quad \sum_{i=1}^n |z_i|^2 = 1, \quad \text{where } \lambda_i \in \mathbb{C}^k, i = 1, \dots, n$$

(now known as *moment-angle manifolds*) admit natural actions of the n -torus \mathbb{T}^n

$$((u_i, \dots, u_n), (z_i, \dots, z_n)) \mapsto (u_1 z_1, \dots, u_n z_n)$$

The quotient can be identified in both cases with the polytope \mathcal{P} given by

$$\sum_{i=1}^n \lambda_i r_i = 0, \quad \sum_{i=1}^n r_i = 1, \quad r_i \geq 0.$$

that determines completely the varieties (so we can use the notations $Z(\mathcal{P})$ and $Z^c(\mathcal{P})$ for them) as well as the actions. The weak hyperbolicity condition implies that \mathcal{P} is a simple polytope and any simple polytope can be realized as such a quotient.

The facets of \mathcal{P} are its non-empty intersections with the coordinate hyperplanes. If all such intersections are non-empty Z and Z^c fall under the general concept of *generalized moment-angle complexes* ([5]).

If we take the quotient of $Z^c(\mathbf{A})$ by the scalar action of \mathbb{S}^1 :

$$\mathcal{N}(\mathbf{A}) = Z^c(\mathbf{A})/\mathbb{S}^1,$$

we obtain a compact, smooth LVM manifold $\mathcal{N}(\mathbf{A}) \subset \mathbb{P}_{\mathbb{C}}^{n-1}$.

When k is even, $\mathcal{N}(\mathbf{A})$ and $Z^c(\mathbf{A}) \times \mathbb{S}^1$ have natural complex structures and so does $Z^c(\mathbf{A})$ itself when k is odd, but admit symplectic structures only in a few well-known cases ([52], [62]).

An open book construction was used to describe the topology of Z for $k = 2$ in some cases not covered by Theorem 2 in [49]. In [35] it is a principal technique for studying the case $k > 2$. In section I-1 17 we recall this construction, underlining the case of moment-angle manifolds:

If \mathcal{P} is a simple convex polytope and F one of its facets, $Z^c(\mathcal{P})$ admits an open book decomposition with binding $Z^c(F)$ and trivial monodromy.

When $k = 2$, the varieties Z and $Z^c(\mathbf{A})$ can be put in a normal form given by an *odd cyclic partition* (see section I-1 17) and they are diffeomorphic to a triple product of spheres or to the connected sum of sphere products (see [49, 35]). Using the same normal form, we give a topological description of the leaves of their open book decompositions which is complete in the case of moment-angle manifolds:

The leaf of the open book decomposition of $Z^c(\mathbf{A})$ is the interior of:

- a) a product $\mathbb{S}^{2n_2-1} \times \mathbb{S}^{2n_3-1} \times \mathbb{D}^{2n_1-2}$,
- b) a connected sum along the boundary of products of the form $\mathbb{S}^p \times \mathbb{D}^{2n-p-4}$,
- c) in some cases, there may appear summands of the form:
*a punctured product of spheres $\mathbb{S}^{2p-1} \times \mathbb{S}^{2n-2p-3} \setminus \mathbb{D}^{2n-4}$ or
the exterior of an embedding $\mathbb{S}^{2q-1} \times \mathbb{S}^{2r-1} \subset \mathbb{S}^{2n-4}$.*

The precise result (Theorem 18 in section 17) follows from Theorem 19 in section I-4, a general theorem that gives the topological description of the *half* real varieties $Z_+ = Z \cap \{x_1 \geq 0\}$, and requires additional dimensional and connectivity hypotheses that should be avoidable using the methods of [36]. Some of the proofs follow directly from the result in [49], while other ones require the use of some parts of its proof. All these manifolds with boundary are also generalized moment-angle complexes.

In part II 17, using a recent deep result about contact forms due to Borman, Eliashberg and Murphy [7], we show that every odd dimensional moment-angle manifold admits a contact structure. This is surprising since even dimensional moment-angle manifolds admit symplectic structures only in a few well-known cases. We also show this for large families of more general odd-dimensional intersections of quadrics by a different argument.

PART I. OPEN BOOK STRUCTURES.

I-1. Construction of the open books. Let $\mathbf{\Lambda}'$ be obtained from $\mathbf{\Lambda}$ by adding an extra λ_1 which we interpret as the coefficient of a new extra variable x_0 , so we get the variety Z' :

$$\lambda_1 (x_0^2 + x_1^2) + \sum_{i>1} \lambda_i x_i^2 = 0, \quad (x_0^2 + x_1^2) + \sum_{i>1} x_i^2 = 1.$$

Let Z_+ be the intersection of Z with the half space $x_1 \geq 0$. Z_+ admits an action of \mathbb{Z}_2^{n-1} with quotient the same \mathcal{P} : Z_+ can be obtained by reflecting \mathcal{P} on all the coordinate hyperplanes except $x_1 = 0$. Z_+ is a manifold with boundary Z_0 which is the intersection of Z with the subspace $x_1 = 0$.

Consider the action of \mathbb{S}^1 on Z' by rotation of the coordinates (x_0, x_1) . This action fixes the points of Z_0 and all its other orbits cut Z_+ transversely in exactly one point. So Z' is the open book with binding Z_0 , page Z_+ and trivial monodromy:

Theorem 17. *i) Every manifold Z' is an open book with trivial monodromy, binding Z_0 and page Z_+ .*

ii) If \mathcal{P} is a simple convex polytope and F is one of its facets, there is an open book decomposition of $Z^c(\mathcal{P})$ with binding $Z^c(F)$ and trivial monodromy.

(ii) follows because if we write the equations of $Z^c(\mathcal{P})$ in real coordinates, we get terms $\lambda_i(x_i^2 + y_i^2)$ so each λ_i appears twice as a coefficient and $Z^c(\mathcal{P})$ is a variety of the type Z' in several ways. It is then an open book with binding the manifold $Z_0^c(\mathcal{P})$ obtained by taking $z_i = 0$.

When $k = 2$ it can be assumed $\mathbf{\Lambda}$ is one of the following normal forms (see [49]): Take $n = n_1 + \dots + n_{2\ell+1}$ a partition of n into an odd number of positive integers. Consider the configuration $\mathbf{\Lambda}$ consisting of the vertices of a regular polygon with $(2\ell + 1)$ vertices, where the i -th vertex in the cyclic order appears with multiplicity n_i .

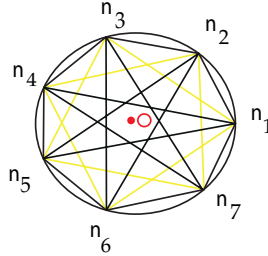

The topology of Z and $Z^c(\mathbf{\Lambda})$ can be completely described in terms of the numbers $d_i = n_i + \dots + n_{i+\ell-1}$, i.e., the sums of ℓ consecutive n_i in the cyclic order of the partition (see [49], [36] and section I-1 17):
For $\ell = 1$: $Z = \mathbb{S}^{n_1-1} \times \mathbb{S}^{n_2-1} \times \mathbb{S}^{n_3-1}$, $Z^c = \mathbb{S}^{2n_1-1} \times \mathbb{S}^{2n_2-1} \times \mathbb{S}^{2n_3-1}$.

For $\ell > 1$: $Z = \#_{j=1}^{2\ell+1} (\mathbb{S}^{d_i-1} \times \mathbb{S}^{n-d_i-2})$, $Z^c = \#_{j=1}^{2\ell+1} (\mathbb{S}^{2d_i-1} \times \mathbb{S}^{2n-2d_i-2})$.

Now we have a similar description of the topology of the leaves in all moment-angle manifolds, where \coprod denotes connected sum along the boundary and $\tilde{\mathcal{E}}_{2n_2-1, 2n_4-1}^{2n-4}$ is the exterior of $\mathbb{S}^{2n_2-1} \times \mathbb{S}^{2n_4-1}$ in \mathbb{S}^{2n-4} (see section I-3 17):

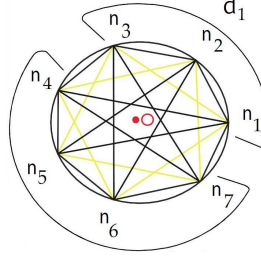

Theorem 18. *Let $k = 2$, and consider the manifold Z^c corresponding to the cyclic partition $n = n_1 + \cdots + n_{2\ell+1}$. Consider the open book decomposition of Z^c corresponding to the binding at $z_1 = 0$, as given by Theorem 1. Then the leaf of this decomposition is diffeomorphic to the interior of:*

a) *If $\ell = 1$, the product*

$$\mathbb{S}^{2n_2-1} \times \mathbb{S}^{2n_3-1} \times \mathbb{D}^{2n_1-2}.$$

b) *If $\ell > 1$ and $n_1 > 1$, the connected sum along the boundary of $2\ell + 1$ manifolds:*

$$\coprod_{i=2}^{\ell+2} (\mathbb{S}^{2d_i-1} \times \mathbb{D}^{2n-2d_i-3}) \coprod \coprod_{i=\ell+3}^1 (\mathbb{D}^{2d_i-2} \times \mathbb{S}^{2n-2d_i-2}).$$

c) *If $n_1 = 1$ and $\ell > 2$, the connected sum along the boundary of 2ℓ manifolds:*

$$\coprod_{i=3}^{\ell+1} (\mathbb{S}^{2d_i-1} \times \mathbb{D}^{2n-2d_i-3}) \coprod \coprod_{i=\ell+3}^1 (\mathbb{D}^{2d_i-2} \times \mathbb{S}^{2n-2d_i-2}) \\ \coprod (\mathbb{S}^{2d_2-1} \times \mathbb{S}^{2d_{\ell+2}-1} \setminus \mathbb{D}^{2n-4}).$$

d) *If $n_1 = 1$ and $\ell = 2$, the connected sum along the boundary of two manifolds:*

$$(\mathbb{S}^{2d_2-1} \times \mathbb{S}^{2d_4-1} \setminus \mathbb{D}^{2n-4}) \coprod \tilde{\mathcal{E}}_{2n_2-1, 2n_5-1}^{2n-4}.$$

Theorem 18 will follow from its real version (see Theorem 19). It follows also that in cases c) and d) the product of the leaf with an open interval is diffeomorphic to the interior of a connected sum along the boundary of the type of case b).

For $k > 2$, the topology of moment-angle manifolds and their leaves is much more complicated and it seems hopeless to give a complete description of them: they may have non-trivial triple Massey products ([3]), any amount of torsion in their homology ([11]) or may be a different kind of open books ([35]). Nevertheless, it is plausible that a description of their leaves as above may be possible for large families of them in the spirit of [35].

The manifold $\mathcal{N}(\mathbf{A})$, defined in the introduction, also admits an open book decomposition, since the \mathbb{S}^1 action on the first coordinate commutes with the diagonal one.

Let

$$\pi_{\mathbf{A}} : Z^c(\mathbf{A}) \rightarrow \mathcal{N}(\mathbf{A}),$$

denote the canonical projection.

Consider now the open book decomposition of Z^c described above, corresponding to the variable z_1 . If $\mathbf{\Lambda}_0$ is obtained from $\mathbf{\Lambda}$ by removing λ_1 it is clear that the diagonal \mathbb{S}^1 -action on Z^c has the property that each orbit intersects each page in a unique point and at all of its points this page is intersected transversally by the orbits. This implies that the restriction of the canonical projection $\pi_{\mathbf{\Lambda}}$ to each page is a diffeomorphism onto its image $\mathcal{N}(\mathbf{\Lambda}) - \mathcal{N}(\mathbf{\Lambda}_0)$.

For k even we therefore obtain, since $\mathcal{N}(\mathbf{\Lambda}) - \mathcal{N}(\mathbf{\Lambda}_0)$ has a complex structure:

For k even, the page of the open book decomposition of $Z^c(\mathbf{\Lambda})$ in Theorem 2 with binding $Z_0^c(\mathbf{\Lambda}_0)$ admits a natural complex structure which makes it biholomorphic to $\mathcal{N}(\mathbf{\Lambda}) - \mathcal{N}(\mathbf{\Lambda}_0)$.

For k odd, both the whole manifold and the binding admit natural complex structures.

So we have a very nice open book decomposition of every moment-angle manifold. Unfortunately, it does not have the right properties to help in the construction of contact structures on them.

The topology of these manifolds and of the leaves of their foliations is more complicated, even for $k = 2$, and only some cases have been described (see [52] for the simpler ones).

I-2. Homology of intersections of quadrics and their halves. We recall here the results of [49], whose proofs are equally valid for any intersection of quadrics and not only for $k = 2$.

Let $Z = Z(\mathbf{\Lambda}) \subset \mathbb{R}^n$ as before, \mathcal{P} its associated polytope and F_1, \dots, F_n the intersections of \mathcal{P} with the coordinate hyperplanes $x_i = 0$ (some of which might be empty).

Let g_i be the reflection on the i -th coordinate hyperplane and for $J \subset \{1, \dots, n\}$ let g_J be the composition of the g_i with $i \in J$. Let also F_J be the intersection of the F_i for $i \in J$.

The polytope \mathcal{P} , all its faces (the non-empty F_J) and all their combined reflections on the coordinate hyperplanes form a cell decomposition of Z . Then the elements $g_J(F_L)$ with non-empty F_L generate the chain groups $C_*(Z)$, where to avoid repetitions one has to ask $J \cap L = \emptyset$ (since g_i acts trivially on F_i).

A more useful basis is given as follows: let $h_i = 1 - g_i$ and h_J be the product of the h_i with $i \in J$. The elements $h_J(F_L)$ with $J \cap L = \emptyset$ are also a basis, with the advantage that $h_J C_*(Z)$ is a chain subcomplex of $C_*(Z)$ for every J and, since h_i annihilates F_i and all its subfaces, this subcomplex can be identified with the chain complex $C_*(\mathcal{P}, \mathcal{P}_J)$, where \mathcal{P}_J is the union of all the F_i with $i \in J$. It follows that

$$H_*(Z) \approx \bigoplus_J H_*(\mathcal{P}, \mathcal{P}_J).$$

For the manifold Z_+ we start also with the faces of \mathcal{P} , but we cannot reflect them in the subspace $x_1 = 0$. This means we miss the classes $h_J(F_L)$ where $1 \in J$ and we get²

$$H_*(Z_+) \approx \bigoplus_{1 \notin J} H_*(\mathcal{P}, \mathcal{P}_J).$$

²The retraction $Z \rightarrow Z_+$ induces an epimorphism in homology and fundamental group.

To compute the homology of $Z^c(\mathbf{A})$ one can just take that of its real version (with each λ_i duplicated) or directly using instead of the basis $h_J(F_L)$ with $J \cap L = \emptyset$ the basis of (singular) cells $F_L \times T_J$ (with $J \cap L = \emptyset$) where T_J is the subtorus of T^m which is the product of its i -th factors with $i \in J$. This gives the splitting

$$H_i(Z^c(\mathbf{A})) \approx \bigoplus_J H_{i-|J|}(\mathcal{P}, \mathcal{P}_J).$$

(See [11]).

These splittings have the same summands as the ones in [5] derived from the homotopy splitting of ΣZ . Even if it is not clear that they are the *same* splitting, having two such with different geometric interpretations is most valuable.

I-3. The space $\tilde{\mathcal{E}}_{p,q}^m$. Consider the standard embedding of $\mathbb{S}^p \times \mathbb{S}^q$ in \mathbb{S}^m , $m > p + q$ given by

$$\mathbb{S}^p \times \mathbb{S}^q \subset \mathbb{R}^{p+1} \times \mathbb{R}^{q+1} = \mathbb{R}^{p+q+2} \subset \mathbb{R}^{m+1},$$

whose image lies in the m -sphere of radius $\sqrt{2}$.

We will denote by $\tilde{\mathcal{E}}_{p,q}^m$ the exterior of this embedding, i.e., the complement in S^m of the open tubular neighborhood $U = \text{int}(\mathbb{S}^p \times \mathbb{S}^q \times \mathbb{D}^{m-p-q}) \subset \mathbb{S}^m$. Observe that the boundary of $\tilde{\mathcal{E}}_{p,q}^m$ is $\mathbb{S}^p \times \mathbb{S}^q \times \mathbb{S}^{m-p-q-1}$ and that the classes $[\mathbb{S}^{m-p-q-1}]$, $[\mathbb{S}^p \times \mathbb{S}^{m-p-q-1}]$ and $[\mathbb{S}^q \times \mathbb{S}^{m-p-q-1}]$ are the ones below the top dimension that go to zero in the homology of U . By Alexander duality, the images of these classes freely generate the homology of $\tilde{\mathcal{E}}_{p,q}^m$.

Theorem A2.2 of [35] tells that, under adequate hypotheses (and probably always) $\tilde{\mathcal{E}}_{p,q}^m \times \mathbb{D}^1$ is diffeomorphic to a connected sum along the boundary of products of the type $\mathbb{S}^a \times \mathbb{D}^{m+1-a}$.

Under some conditions (and probably always), $\tilde{\mathcal{E}}_{p,q}^m$ is characterized by its boundary and its homology properties: Let X be a smooth compact manifold with boundary $\mathbb{S}^p \times \mathbb{S}^q \times \mathbb{S}^{m-p-q-1}$ and ι the inclusion $\partial X \subset X$.

Lemma. *Assume that*

(i) *X and ∂X are simply connected.*

(ii) *the classes $\iota_*[\mathbb{S}^{m-p-q-1}]$, $\iota_*[\mathbb{S}^p \times \mathbb{S}^{m-p-q-1}]$ and $\iota_*[\mathbb{S}^q \times \mathbb{S}^{m-p-q-1}]$ freely generate the homology of X .*

Then X is diffeomorphic to $\tilde{\mathcal{E}}_{p,q}^m$.

Proof: Observe that condition (i) implies that $p, q, m-p-q-1 \geq 2$ so $\dim(X) = m \geq 7$. Consider the following subset of ∂X :

$$K = \mathbb{S}^p \times * \times \mathbb{S}^{m-p-q-1} \cup * \times \mathbb{S}^q \times \mathbb{S}^{m-p-q-1}$$

and embed K into the interior of X as $K \times \{1/2\}$ with respect to a collar neighborhood $\partial X \times [0, 1)$ of ∂X . Finally, let V be a smooth regular neighborhood ([40]) of $K \times \{1/2\}$ in $\partial X \times [0, 1)$.

Now, the inclusion $V \subset X$ induces an isomorphism in homology. Since the codimension of K in X is equal to $1 + \min(p, q) \geq 3$, $X \setminus \text{int}(V)$ is simply connected and therefore an h-cobordism, so X is diffeomorphic to V .

Since $\tilde{\mathcal{E}}_{p,q}^m$ verifies the same properties as X , the above construction *with the same* V shows that $\tilde{\mathcal{E}}_{p,q}^m$ is also diffeomorphic to V and the Lemma is proved.

I-4 Topology of Z and Z_+ when $k = 2$. For $k = 2$ and $\ell = 1$ a simple computation shows that

$$Z_+ = \mathbb{D}^{n_1-1} \times \mathbb{S}^{n_2-1} \times \mathbb{S}^{n_3-1}.$$

For the case $\ell > 1$ we recall here the main steps in the proof of the result about the topology of Z in [49], underlining those that are needed to determine the topology of Z_+ . For the cyclic partition $n = n_1 + \dots + n_{2\ell+1}$ we will denote by J_i the set of indices corresponding to the n_i copies of the i -th vertex of the polygon in the normal form. Let also $D_i = J_i \cup \dots \cup J_{i+\ell-1}$ and \tilde{D}_i its complement. It is shown in [49] that for $k = 2$, the pairs $(\mathcal{P}, \mathcal{P}_J)$ with non-trivial homology are those where J consists of ℓ or $\ell + 1$ consecutive classes, that is, those where J is some D_i or \tilde{D}_i . In those cases there is just one dimension where the homology is non-trivial and it is infinite cyclic.

In the case of D_i that homology group is in dimension $d_i - 1$ where $d_i = n_i + \dots + n_{i+\ell-1}$ is the length of D_i . A generator is given by the face F_{L_i} where

$$L_i = \tilde{D}_i \setminus (\{j_{i-1}\} \cup \{j_{i+\ell}\})$$

and $j_{i-1} \in J_{i-1}$, $j_{i+\ell} \in J_{i+\ell}$ are any two indices in the extreme classes of \tilde{D}_i (in other words, those contiguous to D_i).

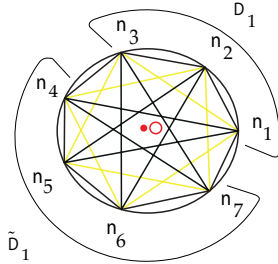

F_{L_i} is non empty of dimension $d_i - 1$. It is not in \mathcal{P}_{D_i} , but its boundary is. Therefore it represents a homology class in $H_{d_i-1}(\mathcal{P}, \mathcal{P}_{D_i})$, which defines a generator $h_{D_i} F_{L_i}$ of $H_{d_i-1}(Z)$. Since F_{L_i} has exactly d_i facets it is a $(d_i - 1)$ -simplex so when reflected in all the coordinate subspaces containing those facets we obtain a sphere, which clearly represents $h_{D_i} F_{L_i} \in H_{d_i-1}(Z)$.

The class corresponding to \tilde{D}_i is in dimension $n - d_i - 2$ and is represented by the face $F_{\tilde{L}_i}$, where $\tilde{L}_i = D_i \setminus \{j\}$ and j is any index in one of the extreme classes of D_i . It represents a generator of $H_{n-d_i-2}(Z)$, but now it is a product of spheres. For $\ell = 1$ this cannot be avoided, but for $\ell > 1$, with a good choice of j and a surgery, it can be represented by a sphere (this also follows from [35]). We will not make use of this class in what follows.

The final result is that, if $\ell > 1$, all the homology of Z below the top dimension can be represented by embedded spheres with trivial normal bundle.

Let Z'_+ be the manifold with boundary obtained by setting $x_0 \geq 0$ in Z' (as defined in section I-1 17). Then Z'_+ can be deformed down to Z_+ by folding gradually the half-plane $x_0 \geq 0, x_1$ onto the ray $x_1 \geq 0$. This shows that the inclusion $Z \subset Z'_+$ induces an epimorphism in homology so one can represent all the classes in a basis of $H_*(Z'_+)$ by embedded spheres with trivial normal bundle. Those spheres can be assumed to be disjoint since they all come from the boundary Z and can be placed at different levels of a collar neighborhood. Finally, one forms a manifold Q with boundary by joining disjoint tubular neighborhoods of those spheres by a minimal set of tubes and then the inclusion $Q \subset Z'_+$ induces an isomorphism in homology. If Z is simply connected and of dimension at least 5, then Z'_+ minus the interior of Q is an h -cobordism and therefore Z is diffeomorphic to the boundary of Q which is a connected sum of spheres products. Knowing its homology we can tell the dimensions of those spheres:

If $\ell > 1$ and Z is simply connected of dimension at least 5, then:

$$Z = \#_{j=1}^{2\ell+1} (\mathbb{S}^{d_j-1} \times \mathbb{S}^{n-d_j-2}).$$

For the moment-angle manifold Z^C this formula gives, without any restrictions

$$Z^C = \#_{j=1}^{2\ell+1} (\mathbb{S}^{2d_j-1} \times \mathbb{S}^{2n-2d_j-2}).$$

(In [34] this has recently been proved without any restrictions also on Z).

The topology of Z'_+ is implicit in the above proof: Z'_+ is diffeomorphic to Q and therefore it is a connected sum along the boundary of manifolds of the form $\mathbb{S}^p \times \mathbb{D}^{n-3-p}$. Since any Z with $n_1 > 1$ is such a Z' we have:

If Z_0 is simply connected of dimension at least 5, and $\ell > 1, n_1 > 1$ then:

$$Z_+ = \prod_{i=2}^{\ell+2} (\mathbb{S}^{d_i-1} \times \mathbb{D}^{n-d_i-2}) \prod_{i=\ell+3}^1 (\mathbb{D}^{d_i-1} \times \mathbb{S}^{n-d_i-2}).$$

The classes D_i and \tilde{D}_i that now give no homology are the ones that contain n_1 .

The case $n_1 = 1$ is different. When $n_1 > 1$ the inclusion $Z_0 \subset Z_+$ induces an epimorphism in homology (since it is of the type $Z \subset Z'_+$). This is not the case for $n_1 = 1$: for the partition $5 = 1 + 1 + 1 + 1 + 1$, the polytope \mathcal{P} is a pentagon and an Euler characteristic computation (from a cell decomposition formed by \mathcal{P} and its reflections) shows that Z is the surface of genus 5. Now Z_0 has partition $4 = 1 + 2 + 1$ and consists of four copies of \mathbb{S}^1 . From this, Z_+ must be a torus minus four disks that can be seen as the connected sum of a sphere minus four disks (all whose homology comes from the boundary) and a torus that carries the homology not coming from the boundary.

In general, when $n_1 = 1$ Z_0 is given by a normal form with $2\ell - 1$ classes, has $4\ell - 2$ homology generators below the top dimension, only half of which survive in Z_+ . But Z_+ has $2\ell + 1$ homology generators, so two of them do not come from its boundary and actually form a handle.

To be more precise, the removal of the element $1 \in J_1$ allows the opposite classes $J_{\ell+1}$ and $J_{\ell+2}$ to be joined into one without breaking the weak hyperbolicity condition.

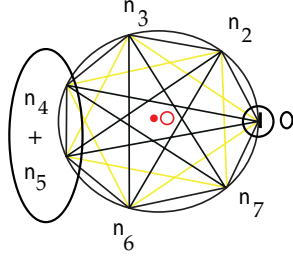

Therefore Z_0 has fewer such classes and $D_2 = J_2 \cup \dots \cup J_{\ell+1}$, which gives a generator of $H_*(Z_+)$, does not give anything in $H_*(Z_0)$ because there *it is not a union of classes* (it lacks the elements of $J_{\ell+2}$ to be so).

The two classes in $H_*(Z_+)$ missing in $H_*(Z_0)$ are thus those corresponding to $J = D_2$ and $J = D_{\ell+2}$; all the others contain both $J_{\ell+1}$ and $J_{\ell+2}$ and thus live in $H_*(Z_0)$.

As shown above, these two classes are represented by embedded spheres in Z_+ with trivial normal bundle built from the cells F_{L_2} and $F_{L_{\ell+2}}$ by reflection. Now $F_{L_2} \cap F_{L_{\ell+2}}$ is a single vertex v , all coordinates except $x_1, x_{j_{\ell+1}}, x_{j_{\ell+2}}$ being 0.

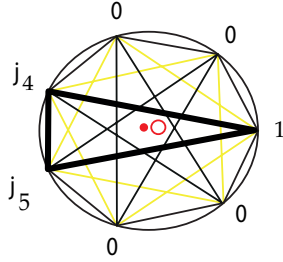

The corresponding spheres are obtained by reflecting in the hyperplanes corresponding to elements in D_2 and $D_{\ell+2}$, respectively. Since these sets are disjoint, the only point of intersection is the point v .

Now, a neighborhood of the vertex v in \mathcal{P} looks like the first orthant of \mathbb{R}^{n-3} where the faces F_{L_2} and $F_{L_{\ell+2}}$ correspond to complementary subspaces. When reflected in all the coordinates hyperplanes of \mathbb{R}^{n-3} , one obtains a neighborhood of v in Z_+ where those subspaces produce neighborhoods of the two spheres. Therefore the spheres intersect transversely in that point.

A regular neighborhood of the union of those spheres is diffeomorphic to their product minus a disk:

$$\mathbb{S}^{d_2-1} \times \mathbb{S}^{d_{\ell+2}-1} \setminus \mathbb{D}^{n-3}.$$

Joining its boundary with the boundary of Z_+ we see that Z_+ is the connected sum along the boundary of two manifolds:

$$Z_+ = \mathbb{S}^{d_2-1} \times \mathbb{S}^{d_{\ell+2}-1} \setminus \mathbb{D}^{n-3} \amalg X$$

where $\partial X = Z_0$ and X is simply connected.

Now, all the homology of X comes from its boundary which again is Z_0 , since all those classes actually live in the homology of Z and are the ones corresponding to the classes D_i and \tilde{D}_i that do not contain n_1 . Those classes also exist in the homology of Z_0 and are given by the same generators, so this part of the homology of Z_0 embeds isomorphically onto the homology of X .

If $\ell > 2$, Z_0 is a connected sum of sphere products, so the homology classes of X can be represented again by disjoint products $\mathbb{S}^p \times \mathbb{D}^{n-p-3}$ and finally we construct the analog of the manifold with boundary Q and the h -cobordism theorem gives:

If Z is simply connected of dimension at least 6, and $n_1 = 1$, $\ell > 2$ then

$$Z_+ = \coprod_{i=3}^{\ell+1} (\mathbb{S}^{d_i-1} \times \mathbb{D}^{n-d_i-2}) \coprod \coprod_{i=\ell+3}^1 (\mathbb{D}^{d_i-1} \times \mathbb{S}^{n-d_i-2}) \\ \coprod (\mathbb{S}^{d_2-1} \times \mathbb{S}^{d_{\ell+2}-1} \setminus \mathbb{D}^{n-3}).$$

The homology classes of Z_+ are those corresponding to D_2 , D_4 (not coming from the boundary) and to D_3 , \tilde{D}_1 , \tilde{D}_5 . Clearly the last ones come from the classes $[\mathbb{S}^{n_3+n_4-1}]$, $[\mathbb{S}^{n_2-1} \times \mathbb{S}^{n_3+n_4-1}]$ and $[\mathbb{S}^{n_5-1} \times \mathbb{S}^{n_3+n_4-1}]$ in the boundary. This means that X satisfies the hypotheses of the Lemma in section I.3 with $p = n_2 - 1$, $q = n_5 - 1$ and $m = n - 3$, so we can conclude that X is diffeomorphic to $\tilde{\mathcal{E}}_{n_2-1, n_5-1}^{n-3}$. We have proved all the cases of the

Theorem 19. *Let $k = 2$, and consider the manifold Z corresponding to the cyclic decomposition $n = n_1 + \dots + n_{2\ell+1}$ and the half manifold $Z_+ = Z \cap \{x_1 \geq 0\}$. When $\ell > 1$ assume Z and $Z_0 = Z \cap \{x_1 = 0\}$ are simply connected and the dimension of Z is at least 6. Then Z_+ diffeomorphic to:*

a) If $\ell = 1$, the product

$$\mathbb{S}^{n_2-1} \times \mathbb{S}^{n_3-1} \times \mathbb{D}^{n_1-1}.$$

b) If $\ell > 1$ and $n_1 > 1$, the connected sum along the boundary of $2\ell + 1$ manifolds:

$$\coprod_{i=2}^{\ell+2} (\mathbb{S}^{d_i-1} \times \mathbb{D}^{n-d_i-2}) \coprod \coprod_{i=\ell+3}^1 (\mathbb{D}^{d_i-1} \times \mathbb{S}^{n-d_i-2}).$$

c) If $n_1 = 1$ and $\ell > 2$, the connected sum along the boundary of 2ℓ manifolds:

$$\coprod_{i=3}^{\ell+1} (\mathbb{S}^{d_i-1} \times \mathbb{D}^{n-d_i-2}) \coprod \coprod_{i=\ell+3}^1 (\mathbb{D}^{d_i-1} \times \mathbb{S}^{n-d_i-2}) \\ \coprod (\mathbb{S}^{d_2-1} \times \mathbb{S}^{d_{\ell+2}-1} \setminus \mathbb{D}^{n-3}).$$

d) If $n_1 = 1$ and $\ell = 2$, the connected sum along the boundary of two manifolds:

$$(\mathbb{S}^{d_2-1} \times \mathbb{S}^{d_4-1} \setminus \mathbb{D}^{n-3}) \coprod \tilde{\mathcal{E}}_{n_2-1, n_5-1}^{n-3}.$$

When $n_1 = 1$ and $\ell = 2$ we have the additional complication that restricting to $x_1 = 0$ takes us from the pentagonal Z_+ to the triangular Z_0 , which is not a connected sum but a product of three spheres and not all of its homology below the middle dimension is spherical.

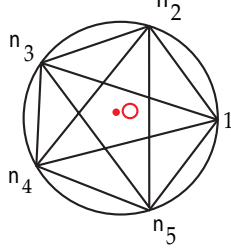

Theorem 19 immediately describes, under the same hypotheses, the topology of the page of the open book decomposition of Z' given by Theorem 1, since this page is precisely the interior of Z_+ .

Theorem 18 about the page of the open book decomposition of the moment-angle manifold $Z^{\mathbb{C}}$ follows also, since this page is Z_+ for Z the (real) intersection of quadrics corresponding to the partition $2n - 1 = (2n_1 - 1) + (2n_2) + \dots + (2n_{2\ell+1})$. In this case all the extra hypotheses of Theorem 19 hold automatically.

Theorem 19 applies also to the topological description of some *smoothings* of the cones on our intersections of quadrics. In this case the normal form is not sufficient to describe all possibilities as it was in ([48]) where actually only the sums d_i were needed to describe the topology or in the present work where additional information about n_1 only is required.

PART II. SOME CONTACT STRUCTURES ON MOMENT-ANGLE MANIFOLDS

The even dimensional moment-angle manifolds and the **LVM**-manifolds have the characteristic that, except for a few, well-determined cases, do not admit symplectic structures. We will show that the odd-dimensional moment-angle manifolds (and large families of intersections of quadrics) admit contact structures.

Theorem 20. *If k is even, $Z^{\mathbb{C}}(\mathbf{\Lambda})$ is a contact manifold.*

First we show that $Z^{\mathbb{C}}(\mathbf{\Lambda})$ is an almost-contact manifold. Recall that a $(2n+1)$ -dimensional manifold \mathcal{M} is called *almost contact* if its tangent bundle admits a reduction to $\mathbf{U}(n) \times \mathbb{R}$. This is seen as follows: consider the fibration $\pi : Z^{\mathbb{C}}(\mathbf{\Lambda}) \rightarrow \mathcal{N}(\mathbf{\Lambda})$ with fibre the circle, given by taking the quotient by the diagonal action. Since $\mathcal{N}(\mathbf{\Lambda})$ is a complex manifold, the foliation defined by the diagonal circle action is transversally holomorphic. Therefore, $Z^{\mathbb{C}}(\mathbf{\Lambda})$ has an atlas modeled on $\mathbb{C}^{n-2} \times \mathbb{R}$ with changes of coordinates of the charts of the form

$$((z_1, \dots, z_{n-2}), t) \mapsto (h(z_1, \dots, z_{n-2}, t), g(z_1, \dots, z_{n-2}, t)),$$

where $h : U \rightarrow \mathbb{C}^{n-2}$ and $g : U \rightarrow \mathbb{R}$ where U is an open set in $\mathbb{C}^{n-2} \times \mathbb{R}$ and, for each fixed t the function $(z_1, \dots, z_{n-2}) \mapsto h(z_1, \dots, z_{n-2}, t)$ is a biholomorphism onto an open set of $\mathbb{C}^{n-2} \times \{t\}$. This means that the differential, in the given coordinates, is represented by a matrix of the form

$$\left[\begin{array}{ccc|c} & & & \\ & A & & * \\ \hline & 0 & \dots & 0 & r \end{array} \right]$$

where $*$ denotes a column $(n-2)$ -real vector and $A \in \mathbf{GL}(n-2, \mathbb{C})$. The set of matrices of the above type form a subgroup of $\mathbf{GL}(2n-3, \mathbb{R})$. By Gram-Schmidt this group retracts onto $\mathbf{U}(n-2) \times \mathbb{R}$.

Now it follows from [7] that $Z^c(\mathbf{A})$ is a contact manifold and the Theorem is proved.

In [15] it is given a different construction, in some sense more explicit, of contact structures, not on moment-angle manifolds but on certain non-diagonal generalizations of moment-angle manifolds of the type that has been studied by Gómez Gutiérrez and Santiago López de Medrano in [34]. It consists in the construction of a positive confoliation which is constructive and uses the heat flow method described in [2].

The argument used there applies however for many other intersections of quadrics that are not moment angle manifolds, for which the proof of the previous Theorem need not apply:

Theorem 21. *There are infinitely many infinite families of odd-dimensional generic intersections of quadrics that admit contact structures.*

First consider the odd-dimensional intersections of quadrics that are connected sums of spheres products:

An odd dimensional product $\mathbb{S}^m \times \mathbb{S}^n$ of two spheres admits a contact structure by the following argument: let n even and m odd, and $n, m > 2$. Without loss of generality, we suppose that $m > n$ (the other case is analogous) then \mathbb{S}^m is an open book with binding \mathbb{S}^{m-2} and page \mathbb{R}^{m-1} . Hence $\mathbb{S}^n \times \mathbb{S}^m$ is an open book with binding $\mathbb{S}^{m-2} \times \mathbb{S}^n$ and page $\mathbb{R}^{m-1} \times \mathbb{S}^n$. This page is parallelizable since $\mathbb{R} \times \mathbb{S}^n$ already is so. Then, since $m+n-1$ is even the page has an almost complex structure. Furthermore, by hypothesis, $2n \leq n+m$ hence by a theorem of Eliashberg [25] the page is Stein and is the interior of a compact manifold with contact boundary $\mathbb{S}^{m-2} \times \mathbb{S}^n$. Hence by a theorem of E. Giroux [33] $\mathbb{S}^n \times \mathbb{S}^m$ is a contact manifold.

Now, it was shown by C. Meckert [61] and more generally by Weinstein [82] (see also [25]) that the connected sum of contact manifolds of the same dimension is a contact manifold. Therefore all odd dimensional connected sums of sphere products admit contact structures.

Additionally, it was proved by F. Bourgeois in [13] (see also Theorem 10 in [33]) that if a closed manifold \mathcal{M} admits a contact structure, then so does $\mathcal{M} \times \mathbb{T}$. Therefore, all moment-angle manifolds of the form $Z \times \mathbb{T}^{2m}$, where Z is a connected sum of sphere products, admit contact structures. For every case where Z is a connected sum of sphere products we have an infinite family obtained by applying construction $Z \mapsto Z'$ an infinite number of times and in the different coordinates (as well as other operations). The basic cases from which to start these infinite families constitute also a large set and the estimates on their number in each dimension keep growing. Adding to those varieties their products with tori we obtain an even larger set of cases where an odd-dimensional Z admits a contact structure.

Another interesting fact is that most of them (including moment-angle manifolds) also have an open book decomposition. However, for these open book decompositions there does not exist a contact form which is supported in the open book decomposition like in Giroux's theorem because the pages are not Weinstein manifolds (i.e manifolds of dimension $2n$ with a Morse function with indices of critical points lesser or equal to n). It is possible however that the pages of the book decomposition admit Liouville structures in which case one could apply the techniques of D. McDuff ([58]) and P. Seidel ([78]) to obtain contact structures.

ACKNOWLEDGEMENTS

I would like to thank Yadira Barreto, Santiago López de Medrano, Ernesto Lupercio and Laurent Meersseman for their suggestions, lecture notes, and sharing their thoughts about the different aspects of the subject of these notes with me during several years.

This work was partially supported by project IN106817, PAPIIT, DGAPA, Universidad Nacional Autónoma de México

REFERENCES

- [1] Abe Yu., Kopfermann K., *Toroidal Groups: Line Bundles, Cohomology and Quasi-Abelian Varieties*, Lecture Notes in Mathematics, 1759. Springer-Verlag, Berlin, 2001. viii+133 pp.
- [2] Altschuler, S. J.; Wu, L. F., *On Deforming Confoliations*, J. Differential Geometry, Vol. 54, pp. 75–97, 2000.
- [3] Baskakov, I. V., *Massey triple products in the cohomology of moment-angle complexes*, Russian Math. Surveys 58 (2003), 1039–1041.
- [4] Battaglia, F.; Zaffran, D., *Foliations modeling nonrational simplicial toric varieties*. Int. Math. Res. Not. IMRN 2015, no. 22, 11785–11815.
- [5] Bahri, A.; Bendersky, M.; Cohen, F. R.; Gitler, S., *The polyhedral product functor: a method of decomposition for moment-angle complexes, arrangements and related spaces*, Adv. Math., Vol. 225, no. 3, pp. 1634–1668, 2010.
- [6] Borisov, L.A.; Chen, L. ; Smith, G.G., *The Orbifold Chow Ring of Toric Deligne-Mumford Stacks*. J. Amer. Math. Soc. **18** (2005), no. 1, 193–215.
- [7] Borman, M.S.; Eliashberg, Y.; Murphy, E., *Existence and classification of overtwisted contact structures in all dimensions*, Acta Mathematica, 215 (2015), 281–361.
- [8] Barth, W.; Hulek, K.; Peters, C.; Van de Ven , A., *Compact complex surfaces*, Springer, Berlin, 2004
- [9] Barreto, Y.; Lpez de Medrano, S.; Verjovsky, A. *Some open book and contact structures on moment-angle manifolds*. Bol. Soc. Mat. Mex. (3) 23 (2017), no. 1, 423–437
- [10] Barreto, Y.; López de Medrano, S.; Verjovsky, A., *Open Book Structures on Moment-Angle Manifolds $Z^C(\Lambda)$ and Higher Dimensional Contact Manifolds*. arXiv:1303.2671.
- [11] Bosio F.; Meersseman, L., *Real quadrics in \mathbb{C}^n , complex manifolds and convex polytopes*, Acta Math., Vol. 197, pp. 53–127, 2006.
- [12] Bosio, F., *Variétés complexes compactes: une généralisation de la construction de Meersseman et López de Medrano-Verjovsky*. Ann. Inst. Fourier **51** (2001), no. 5, 1259–1297.
- [13] Bourgeois, F., *Odd dimensional tori are contact manifolds*, International Mathematics Research Notices, no. 30, pp. 1571–1574, 2002.
- [14] Buchstaber V. M.; Panov T. E. *Torus actions and their applications in topology and combinatorics* AMS, Providence R.I. USA, 2002
- [15] Barreto, Y.; Verjovsky, A., *Moment-angle manifolds, intersection of quadrics and higher dimensional contact manifolds*, Moscow Mathematical Journal, Vol. 14, No. 4, pp. 669–696, 2014.
- [16] Battaglia, F.; Prato, E., *Simple nonrational convex polytopes via symplectic geometry*. Topology **40** (2001), 961–975.
- [17] Battaglia F. ; Prato E., *Generalized Toric Varieties for Simple Nonrational Convex Polytopes*, Internat. Math. Res. Notices 24 (2001), 1315–1337
- [18] Calabi, E.; Eckmann, B., *A class of compact, complex manifolds which are not algebraic*, Ann. Math., Vol. 58, pp. 494–500, 1953.
- [19] Cupit-Foutu, S.; Zaffran, D. *Non-Kähler manifolds and GIT quotients*. Math. Z. **257** (2007), 783–797.
- [20] Cox D., *The homogeneous coordinate ring of a toric variety* J. Algebraic Geometry, 4, 1995, 17–50
- [21] Connes, A., *Non-commutative differential geometry*. Publications mathématiques de l’IHES, 1985, vol. **62**, no 1, p. 41–144.
- [22] Connes, A, *Noncommutative geometry*. Academic Press, Inc., San Diego, CA, 1994. xiv+661 pp

- [23] Demailly, J. P.; Gaussier, H. *Algebraic embeddings of smooth almost complex structures*. J. Eur. Math. Soc. (JEMS) 19 (2017), no. 11, 3391–3419.
- [24] Davis, M.; Januszkiewicz T. *Convex polytopes, Coxeter orbifolds and torus actions*, Duke Math. Journal 62 no. 2, 417–451.
- [25] Eliashberg, Y., *Topological characterization of Stein manifolds of dimension > 2* , International Journal of Mathematics, Vol. 1, No. 1, pp. 29–46, 1990.
- [26] Eliashberg, Y., *Contact 3-manifolds twenty years since J. Martinet’s work*, Ann. Inst. Fourier, Vol. 42, no. 1-2, pp. 165–192, 1992.
- [27] Eliashberg, Y., M. and Thurston, W. P., *Confoliations*, American Mathematical Society. *Lectures Series*, Vol. 13, 1998.
- [28] Fulton, W., *Introduction to toric varieties*, Princeton University Press, Princeton, 1993
- [29] Geiges, H., *A brief history of contact geometry and topology*, Expositiones Mathematicae, Vol. 19, pp. 25–53, 2001.
- [30] Griffiths, P.; Harris, J. *Principles of algebraic geometry*. Pure and Applied Mathematics. Wiley-Interscience, John Wiley & Sons, New York, 1978. xii+813 pp
- [31] Girbau, J.; Haefliger, A.; Sundararaman D., *On deformations of transversely holomorphic foliations* J. Reine Angew. Math. vol. 345, 1983, pages 122–147
- [32] Giroux, E.; Mohsen, J. P., *Structures de contact et fibrations symplectiques sur le cercle, in process*.
- [33] Giroux, E., *Geometrie de contact: de la dimension trois vers les dimensions superieures*, ICM, Vol. II, pp. 405–414, 2002.
- [34] Goldstein, R.; Lininger, L., *A Classification of 6-Manifolds with free S^1 -Action*, Springer-Verlag Lecture Notes in Mathematics 298 (1971), p.316–323
- [35] Gitler, S; López de Medrano, S, *Intersections of quadrics, moment-angle manifolds and connected sums*. Geom. Topol. 17 (2013), no. 3, 1497–1534
- [36] Gómez, G. V.; López de Medrano, S., *Stably parallelizable manifolds are complete intersections of quadrics* prépublication, 2005
- [37] Gómez, G. V; López de Medrano, S., *Topology of the intersections of quadrics II*. Bol. Soc. Mat. Mex. (3) 20 (2014), no. 2, 237–255.
- [38] Gray, J. W., *Some global properties of contact structures*, Annals of Math, Vol. 69, no. 2, pp. 421–450, 1959.
- [39] Grünbaum, B., *Convex polytopes*, Interscience, New York, 1967
- [40] Hirsch, M.W., *Smooth Regular Neighborhoods*, Annals of Mathematics, Vol. 76, No. 3 (Nov., 1962), pp. 524–530.
- [41] Haefliger, A., *Deformations of transversely holomorphic flows on spheres and deformations of Hopf manifolds* Compo. Math. vol, 55, 1985. pages 241–251
- [42] Hopf, H., *Zur Topologie der komplexen Mannigfaltigkeiten*, Studies and essays presented to R. Courant, New York, 1948
- [43] Kopfermann, K., *Maximale Untergruppen Abelscher komplexer Liescher Gruppen*, Schr. Math. Inst. Univ. Münster No. 29 (1964) iii+72 pp.
- [44] Kato, M, Yamada, A., *Examples of Simply Connected Compact Complex 3-folds II*, Tokyo J.Math. 9(1986), p.1–28.
- [45] Niederkruger, K., *The plastikstufe-a generalization of the overtwisted disk to higher dimensions*, Algebraic and Geometric Topology, Vol. 6, pp. 2473–2508, 2006.
- [46] Katzarkov, Ludmil; Lupercio, Ernesto; Meersseman, Laurent; Verjovsky, Alberto., *The definition of a non-commutative toric variety*. Algebraic topology: applications and new directions, 223–250, Contemp. Math., 620, Amer. Math. Soc., Providence, RI, 2014.
- [47] Niederkruger, K.; Van Koert, O., *Every contact manifold can be given a non-fillable contact structure*, IMRN, no. 23, Art. ID rnm115, 22 pp, 2007.
- [48] López de Medrano S., *The Space of Siegel Leaves of a Holomorphic Vector Field*, Springer-Verlag Lecture Notes in Mathematics 1345(1988), p.233–245.

- [49] López de Medrano S., *The Topology of the Intersection of Quadrics in \mathbb{R}^n* , Springer–Verlag Lecture Notes in Mathematics 1370 (1989), p.280–292.
- [50] López de Medrano, S. *Singularities of homogeneous quadratic mappings*. Rev. R. Acad. Cienc. Exactas Fs. Nat. Ser. A Math. RACSAM 108 (2014), no. 1, 95–112
- [51] López de Medrano, S. *Samuel Gitler and the topology of intersections of quadrics*. Bol. Soc. Mat. Mex. (3) 23 (2017), no. 1, 5–21.
- [52] López de Medrano, S.; Verjovsky, A. *A new family of complex, compact, non-symplectic manifolds*. Bulletin of the Brazilian Mathematical Society **28** (1997), no. 2, 253–269.
- [53] Loeb J. J.; Nicolau, M., *Holomorphic flows and complex structures on products of odd-dimensional spheres*. Math. Ann. vol. 306, 1996, pages 781–817
- [54] Loeb, J. J.; Nicolau, M. *On the complex geometry of a class of non-Kählerian manifolds*. Israel J. Math. 110 (1999), 371–379.
- [55] Lescure, F.; Meersseman L., *Compactifications équivariantes non kählériennes d’un groupe algébrique multiplicatif*. Ann. Inst. Fourier, vol, 52, 2002. pages 255–273
- [56] Lutz, R.; Meckert, C., *Structures de contact sur certaines sphères exotiques*, C. R. Acad. Sci. Paris Sér. A-B , Vol. 282, pp. A591–A593, 1976.
- [57] Maeda, H., *Some complex structures on the product of spheres*, J. Fac. Sci. Univ. Tokyo, vol. 21, pages 161–165, 1974
- [58] McDuff, D., *Symplectic manifolds with contact type boundaries*, Invent. Math., Vol. 103, no. 3, pp. 651–671, 1991.
- [59] McGavran, D., *Adjacent connected sums and torus actions*, Trans. Amer. Math. Soc. 251 (1979), 235–254.
- [60] MacMullen, P., *On simple polytopes* Invent. Math. 113, 1993, 419–444
- [61] Meckert, C., *Forme de contact sur la somme connexe de deux variétés de contact de dimension impaire*, Annales De L’Institut Fourier, Vol. 32, no. 3 pp. 251–260, 1982.
- [62] Meersseman, L., *A new geometric construction of compact complex manifolds in any dimension*. Mathematische Annalen **317** (2000), 79–115.
- [63] Meersseman, L., *Un nouveau procédé de construction géométrique de variétés compactes, complexes, non algébriques, en dimension quelconque*, PhD Thesis, Lille, 1998.
- [64] Milnor J., *Lectures on the h-cobordism theorem*, Princeton University Press, 1965.
- [65] Moerdijk, I.; Mrčun, J. *Introduction to Foliations and Lie Groupoids*. Cambridge University Press, Cambridge, 2003.
- [66] Martínez, D.; Muñoz, V.; Presas, F., *Open book decompositions for almost contact manifolds*, *Proceedings of the XI Fall Workshop on Geometry and Physics, Publicaciones de la RSME*, Vol. 6, pp. 131–149, 2004.
- [67] Morimoto, A., *On the classification of non compact complex abelian Lie groups*, Trans. Amer. Math. Soc. vol 123, 1966, pages 200–228
- [68] Meersseman, L.; Verjovsky, A. *Holomorphic principal bundles over projective toric varieties*. Journal für die Reine und Angewandte Mathematik **572** (2004), 57–96.
- [69] Meersseman, L.; Verjovsky, A. *Sur les varités LV-M.* (French) [On LV-M manifolds] Singularities II, 111–134, Contemp. Math., 475, Amer. Math. Soc., Providence, RI, 2008.
- [70] Orlik P., *Seifert manifolds* LNM, vol 291, Springer, Berlin, 1972
- [71] Panov T., *Moment-angle manifolds and complexes*. Lecture notes KAIST’2010. Taras Panov. Trends in Mathematics - New Series. ICMS, KAIST. Vol.12 (2010), no.1, pp.43–69
- [72] Prato, E., *Simple non-rational convex polytopes via symplectic geometry*. Topology 40 (2001), no. 5, 961–975
- [73] Presas, F., *A class of non-fillable contact structures*, *Geom. Topol.*, no. 11, pp. 2203–2225, 2007.
- [74] Scheja G., *Riemannsche Hebbarkeitssätze für Cohomologieklassen*, Math. Ann. 144 p.345–360, 1961.
- [75] Steenrod N., *The Topology of Fibre Bundles*, Princeton University Press, 1951.

- [76] Sternberg, S., *Lectures on differential geometry*. Second edition. With an appendix by Sternberg and Victor W. Guillemin. Chelsea Publishing Co., New York, 1983.
- [77] Stanley, P. R., *Combinatorics and commutative algebra*, 2nd ed., Progress in Mathematics, vol. 41, Birkhäuser Boston Inc., Boston, MA, 1996.
- [78] Seidel, P., *Simple examples of distinct Liouville type symplectic structures*, J. Topol. Anal. , no. 1, pp. 1–5, 2011.
- [79] Timorin, V.A., *An analogue of the Hodge-Riemann relations for simple convex polytopes*, Russian Math. Surveys, vol 54, 1999, pages 381–426
- [80] Wall C.T.C., *Stability, Pencils and Polytopes*, Bull.London Math.Soc. 12(1980), p.401–421.
- [81] Wells R.O. Jr., *Differential Analysis on Complex Manifolds*, Prentice Hall, 1973.
- [82] Weinstein, A., *Contact surgery and symplectic handlebodies*, Hokkaido Math. J., Vol. 620, no. 2, pp. 241–251, 1991.
- [83] Winkelnkemper, H. E., *Manifolds as open books*, Bull. Am. Math. Soc., Vol. 79, pp. 45–51, 1973.

INSTITUTO DE MATEMÁTICAS, UNIDAD CUERNAVACA, UNIVERSIDAD NACIONAL AUTÓNOMA DE MÉXICO,
AV. UNIVERSIDAD S/N, C.P. 62210 CUERNAVACA, MORELOS, MÉXICO
E-mail address: `alberto@matcuer.unam.mx`