

# The Herzog-Schönheim conjecture for finitely generated groups

Fabienne Chouraqui

## Abstract

Let  $G$  be a group and  $H_1, \dots, H_s$  be subgroups of  $G$  of indices  $d_1, \dots, d_s$  respectively. In 1974, M. Herzog and J. Schönheim conjectured that if  $\{H_i\alpha_i\}_{i=1}^{i=s}$ ,  $\alpha_i \in G$ , is a coset partition of  $G$ , then  $d_1, \dots, d_s$  cannot be distinct. We consider the Herzog-Schönheim conjecture for free groups of finite rank and develop a new combinatorial approach, using covering spaces. We define  $Y$  the space of coset partitions of  $F_n$  and show  $Y$  is a metric space with interesting properties. We give some sufficient conditions on the coset partition that ensure the conjecture is satisfied and moreover has a neighborhood  $U$  in  $Y$  such that all the partitions in  $U$  satisfy also the conjecture.

## 1 Introduction

Let  $G$  be a group and  $H_1, \dots, H_s$  be subgroups of  $G$ . If there exist  $\alpha_i \in G$  such that  $G = \bigcup_{i=1}^{i=s} H_i\alpha_i$ , and the sets  $H_i\alpha_i$ ,  $1 \leq i \leq s$ , are pairwise disjoint, then  $\{H_i\alpha_i\}_{i=1}^{i=s}$  is a *coset partition of  $G$*  (or a *disjoint cover of  $G$* ). In this case, all the subgroups  $H_1, \dots, H_s$  can be assumed to be of finite index in  $G$  [30, 21]. We denote by  $d_1, \dots, d_s$  the indices of  $H_1, \dots, H_s$  respectively. The coset partition  $\{H_i\alpha_i\}_{i=1}^{i=s}$  has *multiplicity* if  $d_i = d_j$  for some  $i \neq j$ . The Herzog-Schönheim conjecture is true for the group  $G$ , if any coset partition of  $G$  has multiplicity.

If  $G$  is the infinite cyclic group  $\mathbb{Z}$ , a coset partition of  $\mathbb{Z}$  is  $\{d_i\mathbb{Z} + r_i\}_{i=1}^{i=s}$ ,  $r_i \in \mathbb{Z}$ , with each  $d_i\mathbb{Z} + r_i$  the residue class of  $r_i$  modulo  $d_i$ . These coset partitions of  $\mathbb{Z}$  were first introduced by P. Erdős [10] and he conjectured that if  $\{d_i\mathbb{Z} + r_i\}_{i=1}^{i=s}$ ,  $r_i \in \mathbb{Z}$ , is a coset partition of  $\mathbb{Z}$ , then the largest index  $d_s$  appears at least twice. Erdős' conjecture was proved independently by H. Davenport, L. Mirsky, D. Newman and R. Rado using analysis of complex function [11, 30, 31]. Furthermore, it was proved that the largest

index  $d_s$  appears at least  $p$  times, where  $p$  is the smallest prime dividing  $d_s$  [30, 31, 46], that each index  $d_i$  divides another index  $d_j$ ,  $j \neq i$ , and that each index  $d_k$  that does not properly divide any other index appears at least twice [31]. We refer also to [34, 35, 36, 37, 47] for more details on coset partitions of  $\mathbb{Z}$  (also called covers of  $\mathbb{Z}$  by arithmetic progressions) and to [15] for a proof of the Erdős' conjecture using group representations.

In 1974, M. Herzog and J. Schönheim extended Erdős' conjecture for arbitrary groups and conjectured that if  $\{H_i\alpha_i\}_{i=1}^s$ ,  $\alpha_i \in G$ , is a coset partition of  $G$ , then  $d_1, \dots, d_s$  cannot be distinct. In the 1980's, in a series of papers, M.A. Berger, A. Felzenbaum and A.S. Fraenkel studied the Herzog-Schönheim conjecture [2, 3, 4] and in [5] they proved the conjecture is true for the pyramidal groups, a subclass of the finite solvable groups. Coset partitions of finite groups with additional assumptions on the subgroups of the partition have been extensively studied. We refer to [6, 50, 51, 45]. In [25], the authors very recently proved that the conjecture is true for all groups of order less than 1440.

The common approach to the Herzog-Schönheim conjecture is to study it in finite groups. Indeed, given any group  $G$ , every coset partition of  $G$  induces a coset partition of a particular finite quotient group of  $G$  with the same indices (the quotient of  $G$  by the intersection of the normal cores of the subgroups from the partition) [21]. In this paper, we adopt a completely different approach to the Herzog-Schönheim conjecture. Instead of finite groups, we consider free groups of finite rank and develop a new approach to the problem. This approach has two advantages. First, it permits to study the Herzog-Schönheim conjecture in the free groups of finite rank for their own sake and secondly it provides some answers for every finitely generated group. Indeed, we show any coset partition of a finitely generated group  $G$  induces a coset partition of  $F$  with the same indices.

In order to study the Herzog-Schönheim conjecture in free groups of finite rank, we use the machinery of covering spaces. The fundamental group of the bouquet with  $n$  leaves (or the wedge sum of  $n$  circles),  $X$ , is  $F_n$ , the free group of finite rank  $n$ . As  $X$  is a "good" space (connected, locally path connected and semilocally 1-connected),  $X$  has a universal covering which can be identified with the Cayley graph of  $F_n$ , an infinite simplicial tree. Furthermore, there exists a one-to-one correspondence between the subgroups of  $F_n$  and the covering spaces (together with a chosen point) of  $X$ . Using these covering spaces, J. Stallings gave a topological proof of some classical results about finitely generated subgroups of  $F_n$  and introduced the notion of folding [43].

For any subgroup  $H$  of  $F_n$  of finite index  $d$ , there exists a  $d$ -sheeted covering space  $(\tilde{X}_H, p)$  with a fixed basepoint, which is also a combinatorial object. Indeed, the underlying graph of  $\tilde{X}_H$  is a directed labelled graph, with  $d$  vertices, that can be seen as a finite complete bi-deterministic automaton; fixing the start and the end state at the basepoint, it recognises the set of elements in  $H$ . It is called *the Schreier coset diagram for  $F_n$  relative to the subgroup  $H$*  [44, p.107] or *the Schreier automaton for  $F_n$  relative to the subgroup  $H$*  [42, p.102]. The  $d$  vertices (or states) correspond to the  $d$  right cosets of  $H$ , each edge (or transition)  $Hg \xrightarrow{a} Hga$ ,  $g \in F_n$ ,  $a$  a generator of  $F_n$ , describes the right action of  $a$  on  $Hg$ . *The transition group  $T$*  of the Schreier automaton for  $F_n$  relative to  $H$  describes the action of  $F_n$  on the set of the  $d$  right cosets of  $H$ , and is generated by  $n$  permutations. The group  $T$  is a subgroup of  $S_d$  such that  $T \simeq F_n / N_H$ , where  $N_H = \bigcap_{g \in F_n} g^{-1}Hg$  is the normal core of  $H$ .

Given  $H \leq F_n$  of index  $d$ , we consider the covering  $(\tilde{X}_H, p)$  of  $X$  with basepoint  $\tilde{x}_0$ , from several points of view in parallel: as a covering, as a Schreier coset diagram for  $F_n$  relative to the subgroup  $H$ , as a complete automaton. We use the following terminology. Let  $\tilde{X}_H$  denote the Schreier coset diagram for  $F_n$  relative to the subgroup  $H$ . Let  $\tilde{x}_0, \dots, \tilde{x}_{d-1}$  be the  $d$  vertices in  $\tilde{X}_H$ . Let  $t_i$  denote the label of a minimal path from  $\tilde{x}_0$  to any vertex  $\tilde{x}_i$ ,  $1 \leq i \leq d-1$ . Let  $\mathcal{T} = \{1, t_i \mid 1 \leq i \leq d-1\}$ . As  $\tilde{X}_H$  is the Schreier coset diagram for  $F_n$  relative to the subgroup  $H$ ,  $\tilde{x}_0$  represents the subgroup  $H$  and  $\tilde{x}_1, \dots, \tilde{x}_{d-1}$  represent the cosets  $Ht_i$  accordingly. We call  $\tilde{X}_H$  *the Schreier graph of  $H$* , with this correspondence between the vertices  $\tilde{x}_0, \tilde{x}_1, \dots, \tilde{x}_{d-1}$  and the cosets  $H, Ht_1, \dots, Ht_s$  accordingly.

The intuitive idea behind our approach is as follows. Let  $\{H_i\alpha_i\}_{i=1}^s$  be a coset partition of  $F_n$ ,  $n \geq 2$ , with  $H_i < F_n$  of index  $d_i > 1$ ,  $\alpha_i \in F_n$ ,  $1 \leq i \leq s$ . Let  $w \in F_n$ . For every Schreier graph  $\tilde{X}_i$ ,  $1 \leq i \leq s$ , we define a graph  $\tilde{X}_i(w)$  that describes the action of  $w$  on the vertices of  $\tilde{X}_i$ . We denote by  $o_{*i}(w)$  the minimal natural number,  $1 \leq o_{*i}(w) \leq d_i$ , such that  $w^{o_{*i}(w)}$  is a loop at the vertex  $H_i\alpha_i$ . Combining in some way the  $s$  graphs,  $\tilde{X}_1(w), \dots, \tilde{X}_s(w)$ , we define a new finite graph, *the HS-colored graph*, to describe graphically the coset partition of  $F_n$ .

We show the HS-colored graph is the disjoint union of loops of the same length, that satisfies many interesting properties. In particular, we show that each loop  $\ell$  describes a coset partition of  $\mathbb{Z}$ , with subgroups of indices  $\{o_{*i}(w) \mid i \in I_\ell\}$ , where  $I_\ell \subseteq \{1, 2, \dots, s\}$  and we can then apply the results on the Erdős' conjecture. Indeed, if  $o_{max}(w) = \max\{o_{*i}(w) \mid 1 \leq i \leq s\}$ ,

then  $o_{*i}(w) = o_{max}(w)$ , for at least  $p$  values of  $i$ , where  $p$  is the smallest prime dividing  $o_{max}(w)$ . Since each  $o_{*i}(w)$  is the length of a cycle in some permutation in  $T_i$ , we can formulate our results in terms of cycles in the permutation groups  $T_1, \dots, T_s$ . In particular, if  $o_{max} = \max\{o_{max}(w) \mid w \in F_n\} = d_s$ , we have the following first result.

**Theorem 1.** *Let  $F_n$  be the free group on  $n \geq 2$  generators. Let  $\{H_i\alpha_i\}_{i=1}^{i=s}$  be a coset partition of  $F_n$  with  $H_i < F_n$  of index  $d_i$ ,  $\alpha_i \in F_n$ ,  $1 \leq i \leq s$ , and  $1 < d_1 \leq \dots \leq d_s$ . Let  $\tilde{X}_i$  denote the Schreier graph of  $H_i$ , with transition group  $T_i$ ,  $1 \leq i \leq s$ . If there exists a  $d_s$ -cycle in  $T_s$ , then the index  $d_s$  appears in the partition at least  $p$  times, where  $p$  is the smallest prime dividing  $d_s$ . Furthermore, all the subgroups  $H_i$  with same index are isomorphic.*

The transition group  $T_s$  is a subgroup of the symmetric group  $S_{d_s}$ , generated by  $n \geq 2$  permutations. Dixon proved that the probability that a random pair of elements of  $S_n$  generate  $S_n$  approaches  $3/4$  as  $n \rightarrow \infty$ , and the probability that they generate  $A_n$  approaches  $1/4$  [8]. As  $d_s \rightarrow \infty$ , the probability that  $T_s$  is the symmetric group  $S_{d_s}$  approaches  $3/4$ . So, asymptotically, the probability that there exists a  $d_s$ -cycle in  $T_s$  is greater than  $3/4$ . If  $T_s$  is cyclic, there exists a  $d_s$ -cycle in  $T_s$ , since  $d_s$  divides the order of  $T_s$ . That is, Theorem 1 is satisfied with very high probability and the conjecture is ‘‘asymptotically satisfied with probability greater than  $3/4$ ’’ for free groups of finite rank.

Theorem 2 provides a list of conditions on a coset partition that ensure multiplicity. Let  $k = \max\{o_{max}(w) \mid w \in F_n\}$ ,  $k$  is the maximal length of a cycle in  $\bigcup_{i=1}^{i=s} T_i$ . Let  $p$  denote the smallest prime dividing  $k$ . We show there exists  $u \in F_n$  such that  $o_{max}(u) = k$  and  $\# \geq 2$ , where  $\# = |\{1 \leq i \leq s \mid o_{*i}(u) = k\}|$ . Using this notation, we have the following result.

**Theorem 2.** *Let  $F_n$  be the free group on  $n \geq 2$  generators. Let  $\{H_i\alpha_i\}_{i=1}^{i=s}$  be a coset partition of  $F_n$  with  $H_i < F_n$  of index  $d_i$ ,  $\alpha_i \in F_n$ ,  $1 \leq i \leq s$ , and  $1 < d_1 \leq \dots \leq d_s$ . Let  $r$  be an integer,  $4 \leq r \leq s - 1$ . If  $k$ ,  $p$  and  $\#$ , as defined above, satisfy one of the following conditions:*

- (i)  $k > d_{s-2}$ .
- (ii)  $k > d_{s-3}$ ,  $p \geq 3$ .
- (iii)  $k > d_{s-3}$ ,  $p = 2$ , and  $\# = 2$  or  $\# \geq 4$ .
- (iv)  $k > d_{s-r}$  and  $p \geq r$ , or  $\# = p$ , or  $\# \geq r + 1$ .

Then the coset partition  $\{H_i\alpha_i\}_{i=1}^{i=s}$  has multiplicity.

Assuming that  $k > d_1$ , there is a finite number of cases that are not covered by Theorem 2. For  $k > d_{s-3}$ , there is only one case which is not covered:  $p = 2, \# = 3$ . For  $k > d_{s-4}$ , there are three cases which are not covered:  $p = 2, \# = 3, 4$  and  $p = 3, \# = 4$ . As  $r$  grows, the number of cases not covered by Theorem 2 grows also, but as  $s$  is finite, the total number of cases not covered by Theorem 2 is finite.

In the following Theorem, we give a condition that ensures the same subgroup appears at least twice in the partition.

**Theorem 3.** *Let  $F_n$  be the free group on  $n \geq 2$  generators. Let  $\{H_i\alpha_i\}_{i=1}^{i=s}$  be a coset partition of  $F_n$  with  $H_i < F_n$  of index  $d_i > 1$ ,  $\alpha_i \in F_n$ ,  $1 \leq i \leq s$ . If one of the following conditions holds:*

- (i) *There exist  $1 \leq j, k \leq s$  such that  $\bigcap_{i=1}^{i=s} \alpha_i^{-1}H_i\alpha_i \subsetneq \bigcap_{i \neq j, k} \alpha_i^{-1}H_i\alpha_i$ .*
- (ii) *There exist  $1 \leq j, k \leq s$  such that  $\text{lcm}(d_j, d_k)$  does not divide the index  $[F_n : \bigcap_{i \neq j, k} \alpha_i^{-1}H_i\alpha_i]$ .*

Then  $\{H_i\alpha_i\}_{i=1}^{i=s}$  has multiplicity. Furthermore,  $H_j = H_k$ .

Inspired by [41], in which the author defines the space of left orders of a left-orderable group and show it is a compact and totally disconnected metric space, we define  $Y$  to be the space of coset partitions of  $F_n$  (under some equivalence relation) and show  $Y$  is a metric space. In our case, the metric defined induces the discrete topology.

**Theorem 4.** *Let  $F_n$  be the free group on  $n \geq 2$  generators. Let  $Y$  be the space of coset partitions of  $F_n$  (under some equivalence relation). Then  $Y$  is a metric space with a metric  $\rho$  and  $Y$  is (topologically) discrete*

We show that for each coset partition of  $F_n$ , which satisfies one of the conditions in Theorems 1 or 2, there exists a neighborhood  $U$  in  $Y$  such that all the coset partitions in  $U$  have multiplicity.

**Theorem 5.** *Let  $F_n$  be the free group on  $n \geq 2$  generators. Let  $Y$  be the space of coset partitions of  $F_n$  (under some equivalence relation) with metric  $\rho$ . Let  $P_0 = \{H_i\alpha_i\}_{i=1}^{i=s}$  be in  $Y$ , with  $1 < d_1 \leq \dots \leq d_s$ .*

- (i) *If  $P_0$  satisfies the condition of Theorem 1, then every  $P \in Y$  with  $\rho(P, P_0) < \frac{1}{2}$  satisfies the same condition and hence has multiplicity.*

- (ii) If  $P_0$  satisfies (i) or (ii) of Theorem 2, with some  $2 \leq r \leq s - 1$ , then every  $P \in Y$  with  $\rho(P, P_0) < 2^{-(r+1)}$  satisfies the same condition and hence has multiplicity.
- (iii) If  $P_0$  satisfies (iii) or (iv) of Theorem 2, with some  $2 \leq r \leq s - 1$ , then every  $P \in Y$  with  $\rho(P, P_0) < 2^{-(r+1)}$  has multiplicity.

Theorem 5 implies that given a “small” subgroup  $H_s$  (or some “small” subgroups) satisfying one of the conditions cited above, then for every  $\alpha_s \in F_n$ , any completion of  $H_s \alpha_s$ , to a coset partition of  $F_n$  with  $H_s$  being the “smallest” (greatest index) subgroup has multiplicity.

We now turn to finitely generated groups in general.

**Theorem 6.** *Let  $G \simeq F_n / K$ , with canonical epimorphism  $\pi : F_n \rightarrow G$ . Let  $\{K_i g_i\}_{i=1}^{i=s}$  be a coset partition of  $G$  with  $K_i < G$  of index  $d_i > 1$ ,  $g_i \in G$ ,  $1 \leq i \leq s$ . Let  $H_i = \pi^{-1}(K_i)$  and  $\alpha_i = \pi^{-1}(g_i)$ . Then there exists  $\{H_i \alpha_i\}_{i=1}^{i=s}$  an induced coset partition of  $F_n$ , with  $H_i < F_n$  of index  $d_i$ ,  $\alpha_i \in F_n$ ,  $1 \leq i \leq s$ . Furthermore, if for  $\{H_i \alpha_i\}_{i=1}^{i=s}$ , one of the conditions from Theorem 1, 2, or 3 is satisfied, then the coset partition  $\{K_i g_i\}_{i=1}^{i=s}$  has multiplicity.*

The paper is organized as follows. The two first sections are background sections: Section 1 on free groups and covering spaces and Section 2 on graphs and automata. In Section 3, we describe the equivalent approaches to covering spaces in the special case of free groups and in particular we present the Schreier graph and its properties. In Section 4, we give a graphical description of the coset partition of  $F_n$  in terms of the Schreier graphs, and in particular in the case of  $\mathbb{Z}$ . Section 6 is devoted to the proofs of the main results. In Section 7, we introduce the space of coset partitions of  $F_n$ , an action of  $F_n$  on it, a metric and prove Theorems 3, 4 and 5. In Section 8, we consider the case of any finitely generated group and prove Theorem 6. In many places, we write the HS conjecture instead of the Herzog-Schönheim conjecture.

**Acknowledgment.** I am very grateful to Yuval Ginosar for introducing me to the Herzog-Schönheim conjecture, to Luis Paris for suggesting me to study the conjecture in free groups, and to Aryeh Juhasz for his useful comments on the paper.

## 2 Free Groups and Covering spaces

### 2.1 Free Groups

For more details, we refer the reader to the books [23, Chapter 1], [24, Section 1.4], [1, Chapter 1]. Let  $X$  be a non-empty set. The group generated by  $X$  is  $\langle X \rangle = \{x_1^{\epsilon_1} x_2^{\epsilon_2} \dots x_n^{\epsilon_n} \mid x_i \in X, \epsilon_i = \pm 1, n \geq 0\}$ , this is the set of all words on  $X$ . If  $X$  is finite, the group generated by  $X$  is *finitely generated*. A word  $w = x_1^{\epsilon_1} x_2^{\epsilon_2} \dots x_n^{\epsilon_n}$  is *reduced* if  $x_i = x_{i+1}$  implies  $\epsilon_i + \epsilon_{i+1} \neq 0$  and in this case *the length of  $w$* ,  $\ell(w)$ , is equal to  $n$ . A word  $w = x_1^{\epsilon_1} x_2^{\epsilon_2} \dots x_n^{\epsilon_n}$  is *cyclically reduced* if  $x_1 = x_n$  implies  $\epsilon_1 + \epsilon_n \neq 0$ . If  $F = \langle X \rangle$  and every non-empty reduced word  $w \neq 1$  in  $F$ , then we say that  $X$  is a *free set of generators of  $F$*  or that  $F$  is *free with base  $X$* . It holds that all bases for a given free group have the same cardinal and this common cardinal is termed *the rank of the free group  $F$*  and denoted by  $\text{rank}(F)$ . The free group of rank  $n$  is denoted by  $F_n$  and  $F_n \simeq F_m$  if and only if  $n = m$ .

The Nielsen-Schreier theorem states that every subgroup of a free group is free. If  $H$  is a subgroup of  $F_n$  of finite index  $d$ , then  $H$  is a free group of rank  $d(n - 1) + 1$  and  $H$  has non-trivial intersection with every non-trivial subgroup of  $F_n$ . If  $K$  is a subgroup of  $F_n$  of same index  $d$ , then  $K \simeq H$ . Note that a finitely generated subgroup of  $F_n$  is not necessarily of finite index and that there exist infinitely generated subgroups in  $F_n$ . A set  $S$  of representatives of the right cosets of a subgroup  $H$  in a group  $G$  generated by  $X$  is called a (*right*) *Schreier transversal* if whenever  $x_1^{\epsilon_1} x_2^{\epsilon_2} \dots x_n^{\epsilon_n} \in S$ ,  $x_i \in X$ , then  $x_1^{\epsilon_1} x_2^{\epsilon_2} \dots x_{n-1}^{\epsilon_{n-1}}$  is also in  $S$ . If  $H$  is a subgroup of the free group  $F_n$ , then there exists a right Schreier transversal of  $H$  in  $F_n$ . If  $G$  is a group generated by a set of  $n$  of its elements, then  $G \simeq F_n / N$ , with  $N \triangleleft F_n$ . If  $G \simeq F_n / N$ , then the group  $G$  has a presentation  $\langle X \mid R \rangle$ , where  $X$  is a base of  $F_n$  and the normal closure of the set  $R$  is equal to  $N$ . If  $X$  and  $R$  are finite, the group  $G$  is *finitely presented*.

### 2.2 Covering spaces

For more details, we refer the reader to the books [39, Chapter 10], [18, Chapter 1], [23, Chapter 3], [44], [13]. If  $X$  is a topological space, then  $(\tilde{X}, p)$  is a *covering space* of  $X$  if  $\tilde{X}$  is a path connected topological space,  $p : \tilde{X} \rightarrow X$  is an open continuous surjection and each point  $x \in X$  has an open neighborhood  $U_x$  such that  $p^{-1}(U_x)$  is a disjoint union of open sets in  $\tilde{X}$ , each of which is mapped homeomorphically onto  $U_x$  by  $p$ . If  $(\tilde{X}, p)$  is a covering space of  $X$ , then  $X$  is path connected. For each  $x \in X$ , the

non-empty set  $Y_x = p^{-1}(x)$  is called *the fiber over  $x$*  and for all  $x, x' \in X$ ,  $|Y_x| = |Y_{x'}|$ . The cardinal of a fiber is called *the multiplicity* of the covering. One also says  $(\tilde{X}, p)$  is a  *$m$ -sheeted covering* ( *$m$ -fold cover*) of  $X$ .

If  $X$  and  $\tilde{X}$  are spaces and there is a continuous map  $p : \tilde{X} \rightarrow X$ , with  $p(\tilde{x}_0) = x_0$ , then there is an induced homomorphism  $p_* : \pi_1(\tilde{X}, \tilde{x}_0) \rightarrow \pi_1(X, x_0)$ . If  $[f]$  is a loop class in  $\tilde{X}$ , then  $p_*([f]) = [p(f)]$  [39, Chapter 3].

**Theorem 2.1.** [39, p.279-281] *Let  $(\tilde{X}, p)$  be a covering space of  $X$ . Let  $G = \pi_1(X, x_0)$ . Let  $Y_0$  denote the fiber over  $x_0$  and let  $\tilde{x}_0 \in Y_0$ . Then*

- (i) *The induced homomorphism  $p_* : \pi_1(\tilde{X}, \tilde{x}_0) \rightarrow G$  is an injection.*
- (ii)  *$G$  acts transitively on  $Y_0$ .*
- (iii) *The stabilizer of  $\tilde{x}_0$  is  $p_*(\pi_1(\tilde{X}, \tilde{x}_0))$ .*
- (iv)  *$|Y_0| = [G : p_*(\pi_1(\tilde{X}, \tilde{x}_0))]$ .*
- (v)  *$p_*(\pi_1(\tilde{X}, \tilde{x}_0))$  and  $p_*(\pi_1(\tilde{X}, \tilde{x}_1))$  are conjugate subgroups of  $G$ , for every  $\tilde{x}_1 \in Y_0$ .*
- (vi) *If  $K \leq G$  is conjugate to  $p_*(\pi_1(\tilde{X}, \tilde{x}_0))$ , then there exists  $\tilde{x}_1 \in Y_0$  such that  $K = p_*(\pi_1(\tilde{X}, \tilde{x}_1))$ .*

A covering space  $(\tilde{X}, p)$  of  $X$  is *regular* if  $p_*(\pi_1(\tilde{X}, \tilde{x}_0)) \triangleleft G$ . A *Deck transformation* of  $\tilde{X}$  is a homeomorphism  $h : \tilde{X} \rightarrow \tilde{X}$  with  $p \circ h = p$ . The group of Deck transformations,  $\text{Cov}(\tilde{X}/X)$ , is called *The Deck group* and it acts freely on  $\tilde{X}$ . If  $(\tilde{X}, p)$  is universal, that is  $\tilde{X}$  is simply-connected, then  $\text{Cov}(\tilde{X}/X) \simeq G$ . If  $X$  is locally path connected,  $H = p_*(\pi_1(\tilde{X}, \tilde{x}_0))$ , then  $\text{Cov}(\tilde{X}/X) \simeq N(H)/H$ , where  $N(H)$  is the normaliser of  $H$  in  $G$ . So,  $(\tilde{X}, p)$  is regular if and only if  $\text{Cov}(\tilde{X}/X) \simeq G/H$  [39, p.289-294].

Two covering spaces  $(\tilde{X}, p)$  and  $(\tilde{Y}, q)$  of a space  $X$  are *equivalent* if there exists a homeomorphism  $\varphi : \tilde{Y} \rightarrow \tilde{X}$  such that  $q = p\varphi$ . If  $X$  is a locally path connected space, then the covering spaces  $(\tilde{X}, p)$  and  $(\tilde{Y}, q)$  of  $X$  are equivalent if and only if  $p_*(\pi_1(\tilde{X}, \tilde{x}_0))$  and  $q_*(\pi_1(\tilde{Y}, \tilde{y}_0))$  are conjugate subgroups of  $\pi_1(X, x_0)$ , with  $\tilde{x}_0 \in p^{-1}(x_0)$  and  $\tilde{y}_0 \in q^{-1}(x_0)$ . If  $X$  satisfies several conditions, a converse to Theorem 2.1 is true, that is given  $x_0 \in X$  and a subgroup  $H$  of  $\pi_1(X, x_0)$ , there exists a covering space  $(\tilde{X}, p)$  of  $X$ , with  $p_*(\pi_1(\tilde{X}, \tilde{x}_0)) = H$  for a suitably chosen basepoint  $\tilde{x}_0 \in \tilde{X}$ . A space  $X$  is *semilocally 1-connected* if each  $x \in X$  has an open neighborhood  $U$  so that  $i_* : \pi_1(U, x) \rightarrow \pi_1(X, x)$  is the trivial map (where  $i : U \hookrightarrow X$  is the inclusion). A connected and locally path connected space  $X$  has a universal covering if and only if  $X$  is semilocally 1-connected.



**Theorem 2.2.** [39, p.295-300] Let  $X$  be a connected, locally path connected and semilocally 1-connected space. Let  $x_0 \in X$ . Let  $H$  be a subgroup of  $\pi_1(X, x_0)$ . Then there exists a covering space  $(\tilde{X}, p)$  of  $X$ , and  $\tilde{x}_0 \in p^{-1}(x_0)$  such that  $p_*(\pi_1(\tilde{X}, \tilde{x}_0)) = H$ .

The free group of finite rank  $n$ ,  $F_n$ , is the fundamental group of the bouquet with  $n$  leaves, which is a space that satisfies all the conditions of Theorem 2.2. So, we can take for granted the one-to-one correspondence between the subgroups of  $F_n$  and the covering spaces (together with a chosen point) of the bouquet with  $n$  leaves.

**Example 2.3.** Let  $K = \langle b, a^2, ab^2a, aba^2ba, (ab)^3a \rangle$  be a subgroup of index 4 in  $F_2$ . So, there exist a covering space  $(\tilde{X}_K, p')$  over  $X$  and a chosen basepoint  $\tilde{x}_{0_0}$  (or  $\tilde{x}_{0_1}$ ) such that  $p'_*(\pi_1(\tilde{X}_K, \tilde{x}_{0_0})) = K$ . Note that this covering is not regular, so  $K$  is not normal in  $F_2$ .

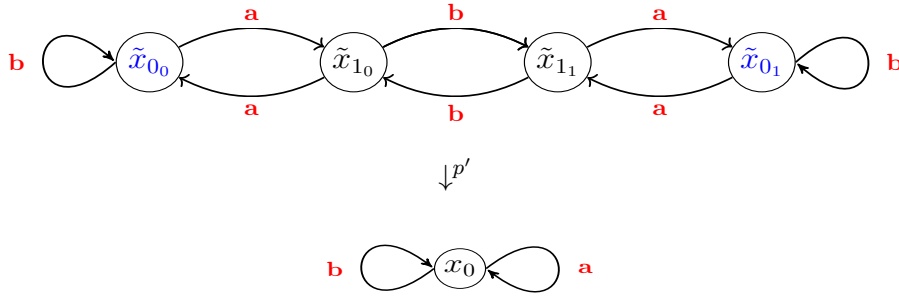

Figure 2.3.1: The 4-sheeted covering  $(\tilde{X}_K, p')$  over  $X$ .

### 3 Graphs and Automata

#### 3.1 Graphs

For more details, we refer the reader to [40], [43], [17]. A *graph*  $\Gamma$  consists of two sets  $V$  and  $E$ , and two maps  $E \rightarrow V \times V : e \mapsto (i(e), t(e))$  and  $E \rightarrow E : e \mapsto \bar{e}$ , which satisfy the following conditions:  $\forall e \in E, \bar{\bar{e}} = e$  and  $i(\bar{e}) = t(e)$ . An element  $v \in V$  is called a *vertex* of  $\Gamma$ ,  $e \in E$  is called an *edge* of  $\Gamma$  and  $\bar{e}$  is called the *reverse* of  $e$ . The vertex  $i(e)$  is the *initial vertex* of  $e$  (or *origin*) and  $t(e)$  the *terminal vertex* of  $e$  (or *terminus*). These two vertices are called the *extremities* of  $e$  and two vertices are

*adjacent* if they are the extremities of some edge. An *orientation* of  $\Gamma$  consists of a choice of exactly one edge in each pair  $\{e, \bar{e}\}$ , and in this case  $\Gamma$  is called a *directed graph*. The *indegree*( $v$ ) is the cardinal of  $\{e \in E \mid t(e) = v\}$  and the *outdegree*( $v$ ) is the cardinal of  $\{e \in E \mid i(e) = v\}$ . A *path*  $p$  in  $\Gamma$  of length  $n \geq 0$ , with origin  $v_1$  and terminus  $v_n$  is an  $n$ -tuple of edges of  $\Gamma$ ,  $p = e_1 e_2 \dots e_n$ , such that for  $j = 1, \dots, n-1$ ,  $t(e_j) = i(e_{j+1})$  and  $v_1 = i(e_1)$ ,  $v_n = t(e_n)$ . A path  $p$  is a *loop at*  $v$  if  $v$  is both its origin and its terminus. A loop of length 1 at  $v$  contributes 1 to the indegree of  $v$  and 1 to its outdegree.

### 3.2 Automata

We refer the reader to [42, p.96], [9, p.7], [32, 33]. A *finite state automaton* is a quintuple  $(S, A, \mu, Y, s_0)$ , where  $S$  is a finite set, called the *state set*,  $A$  is a finite set, called the *alphabet*,  $\mu : S \times A \rightarrow S$  is a function, called the *transition function*,  $Y$  is a (possibly empty) subset of  $S$  called the *accept (or final) states*, and  $s_0$  is called the *start state*. It is a directed graph with vertices the states and each transition  $s \xrightarrow{a} s'$  between states  $s$  and  $s'$  is an edge with label  $a \in A$ . The *label of a path*  $p$  of length  $n$  is the product  $a_1 a_2 \dots a_n$  of the labels of the edges of  $p$ . The finite state automaton  $M = (S, A, \mu, Y, s_0)$  is *deterministic* if there is only one initial state and each state is the source of exactly one arrow with any given label from  $A$ . In a deterministic automaton, a path is determined by its starting point and its label [42, p.105]. It is *co-deterministic* if there is only one final state and each state is the target of exactly one arrow with any given label from  $A$ . The automaton  $M = (S, A, \mu, Y, s_0)$  is *bi-deterministic* if it is both deterministic and co-deterministic. An automaton  $M$  is *complete* if for each state  $s \in S$  and for each  $a \in A$ , there is exactly one edge from  $s$  labelled  $a$ .

**Definition 3.1.** Let  $M = (S, A, \mu, Y, s_0)$  be a finite state automaton. Let  $A^*$  be the free monoid generated by  $A$ . Let  $\text{Map}(S, S)$  be the monoid consisting of all maps from  $S$  to  $S$ . The map  $\phi : A \rightarrow \text{Map}(S, S)$  given by  $\mu$  can be extended in a unique way to a monoid homomorphism  $\phi : A^* \rightarrow \text{Map}(S, S)$ . The range of this map is a monoid called *the transition monoid of  $M$* , which is generated by  $\{\phi(a) \mid a \in A\}$ . An element  $w \in A^*$  is *accepted* by  $M$  if the corresponding element of  $\text{Map}(S, S)$ ,  $\phi(w)$ , takes  $s_0$  to an element of the accept states set  $Y$ . The set  $L \subseteq A^*$  recognized by  $M$  is called *the language accepted by  $M$* , denoted by  $L(M)$ .

In order to extend this definition to languages in groups, one takes the

alphabet  $A$  of monoid generators to be closed under inverses and each transition  $s \xrightarrow{a} s'$  labelled by  $a \in A$  induces a "reverse" transition  $s' \xrightarrow{x} s$ , with  $x = a^{-1}$ .

**Example 3.2.** Let  $A = \{a, b, x = a^{-1}, y = b^{-1}\}$  be an alphabet. So,  $A^*$  is  $F_2$ . The transition monoid  $T$  of the following complete automaton  $M$  is generated by  $\{\phi_a = \phi_x = (s_0, s_1), \phi_b = \phi_y = (s_1, s_2)\}$ , that is  $S_3$ .

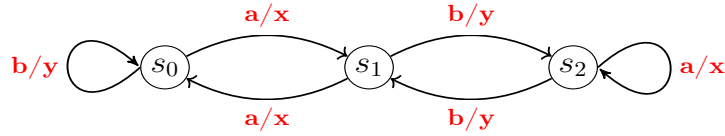

Figure 3.2.1: A complete automaton  $M$  on  $A = \{a, b, x = a^{-1}, y = b^{-1}\}$ .

Once a unique start state and a unique accept state are specified, the automaton  $M$  from Figure 3.2.1 is bi-deterministic. We describe the consequences of several different choices on  $L(M)$ , the language accepted by  $M$ . If  $s_0$  is both the start and accept state of  $M$ , then  $L(M)$  is the subgroup  $H$  of  $A^*$  generated by  $\{b, a^2, ab^2a, ababa\}$ . If  $s_1$  is both the start and accept state of  $M$ , then  $L(M)$  is the subgroup  $a^{-1}Ha$  of  $A^*$  and if  $s_2$  is both the start and accept state of  $M$ , then  $L(M)$  is the subgroup  $(ab)^{-1}H(ab)$  of  $A^*$ . If  $s_0$  is the start state and  $s_1$  the accept state, then  $L(M)$  is the coset  $Ha$  of  $H$ . If  $s_0$  is the start state and  $s_2$  the accept state, then  $L(M)$  is the coset  $Hab$  of  $H$ . When  $s_0$  is both the start and accept state of  $M$ ,  $M$  is called *the Schreier automaton for  $F_2$  relative to the subgroup  $H$*  [42, p.102]. Generally, the Schreier automaton for  $F_2$  relative to a subgroup  $H$  is a finite, complete and bi-deterministic automaton, with transition monoid  $T$  a group of permutations in  $S_d$ , with  $T \simeq G/N_H$ , where  $N_H = \bigcap_{g \in G} g^{-1}Hg$  is the normal core of  $H$ .

## 4 Covering spaces in the context of free groups

### 4.1 How to look at the covering space of the $n$ -leaves bouquet ?

We refer to [44, Chapter 2], and [20] for details. Let  $X$  denote the  $n$ -leaves bouquet with basepoint  $x_0$ . Its fundamental group  $\pi_1(X, x_0)$  is  $F_n$ . Given  $H \leq F_n$  of index  $d$ , there exists a covering  $(\tilde{X}_H, p)$  of  $X$  with basepoint  $\tilde{x}_0$

(see Theorem 2.2). The covering  $(\tilde{X}_H, p)$  can be viewed as a directed and labelled graph. Using this covering space, J. Stallings gave a topological proof of some classical results about finitely generated subgroups of  $F_n$ . In [43], he introduced the topological notion of a folding, and used it in the study of finitely generated subgroups of a free group.

The folding corresponding to a finitely generated subgroup  $H$  of  $F_n$  is a directed labelled graph, that can be considered as a finite deterministic automaton; fixing the start and the end state at a distinguished vertex, it recognises the set of elements in  $H$ . Stallings's approach has been applied to solve many combinatorial and algorithmic problems in group theory. In the years 1980-90, similar graphical approaches were developed in the study of finitely generated subgroups of the free group, in order to solve many special cases of the Hanna Neumann conjecture [14, 28, 49], which states:  $rank(H \cap K) - 1 \leq (rank(H) - 1)(rank(K) - 1)$ , where  $H$  and  $K$  are finitely generated subgroups of the free group (of ranks  $rank(H)$  and  $rank(K)$  respectively). It was recently solved [26], [12], [7].

In this work, our approach is the following: given  $H \leq F_n$  of index  $d$ , we consider the covering  $(\tilde{X}_H, p)$  of  $X$  with basepoint  $\tilde{x}_0$ , from several points of view in parallel: as a covering, as a Schreier coset diagram for  $F_n$  relative to the subgroup  $H$ , as a complete and "almost" bi-deterministic automaton, in the sense that we do not fix the start and accept states in advance, but we fix them differently at our needs. We will use all these points of view together. More formally:

**Definition 4.1.** Let  $H < F_n$  be of finite index  $d$ . Let  $(\tilde{X}_H, p)$  be the covering of the  $n$ -leaves bouquet with basepoint  $\tilde{x}_0$  and vertices  $\tilde{x}_0, \tilde{x}_1, \dots, \tilde{x}_{d-1}$ . Let  $t_i$  denote the label of a minimal path from  $\tilde{x}_0$  to  $\tilde{x}_i$ . Let  $\mathcal{T} = \{1, t_i \mid 1 \leq i \leq d-1\}$ . As  $\tilde{X}_H$  is the Schreier coset diagram for  $F_n$  relative to the subgroup  $H$ ,  $\tilde{x}_0$  represents the subgroup  $H$  and the other vertices  $\tilde{x}_1, \dots, \tilde{x}_{d-1}$  represent the cosets  $Ht_i$  accordingly. We call  $\tilde{X}_H$  *the Schreier graph of  $H$* , with this correspondence between the vertices  $\tilde{x}_0, \tilde{x}_1, \dots, \tilde{x}_{d-1}$  and the cosets  $Ht_i$  accordingly.

Note that a minimal path from  $\tilde{x}_0$  to  $\tilde{x}_i$  is not necessarily unique, so we choose arbitrarily one. The transversal  $\mathcal{T}$  may be a Schreier transversal or any transversal with representatives of minimal length.

**Example 4.2.** Consider the automaton in Figure 3.2.1. Replacing  $s_0$  by  $G$  and the other vertices accordingly, this graph is the Schreier graph of  $G = \langle b, a^2, ab^2a, ababa \rangle$ , a subgroup of  $F_2$  of index 3, with Schreier transversal  $\mathcal{T} = \{1, a, ab\}$ :

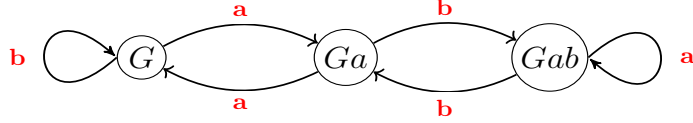

Figure 4.2.1: The Schreier graph of  $G = \langle b, a^2, ab^2a, (ab)^3 \rangle$ .

*Remark 4.3.* If  $H \leq F_n$  of index  $d$  with Schreier graph  $\tilde{X}_H$ , then from Theorem 2.2 (covering theory), the Deck group  $\text{Cov}(\tilde{X}/X) \simeq N(H)/H$ , where  $N(H)$  is the normaliser of  $H$  in  $F_n$ . From Section 3.2 (automaton theory), the transition group  $T \simeq F_n/N_H$ , where  $N_H$  is the normal core of  $H$ . So, whenever  $H$  is a normal subgroup of  $F_n$ ,  $\text{Cov}(\tilde{X}/X) \simeq T$  and it can be read easily from the graph. If  $H$  is not normal in  $F_n$ , this is not necessarily true. Indeed, in Example 4.2,  $G$  is of index 3, not normal, so  $\text{Cov}(\tilde{X}/X) = \{1\}$ , while its transition group is  $S_3$  (see Example 3.2).

## 4.2 A combinatorial approach to coverings of the leaves bouquet

We keep the same terminology as in Section 4.1. We develop a combinatorial approach to  $\tilde{X}_H$  and prove some of its properties. If  $H \leq F_n$  of index  $d$ , then for every  $w \in F_n$ , there exists a minimal natural number  $1 \leq m_{w,i} \leq d$  such that  $w^{m_{w,i}} \in t_i^{-1}Ht_i$ , where  $t_i \in \mathcal{T}$ .

**Lemma 4.4.** *Let  $H \leq F_n$  of index  $d$ . Let  $\tilde{X}_H$  be the Schreier graph of  $H$  with vertices  $\tilde{x}_0, \tilde{x}_1, \dots, \tilde{x}_{d-1}$ . Then, for every  $w \in F_n$ , there exists a minimal natural number  $1 \leq m_{w,i} \leq d$  such that  $w^{m_{w,i}}$  is a loop at  $\tilde{x}_i$ .*

*Proof.* Since  $1 \leq m_{w,i} \leq d$  is the minimal natural number such that  $w^{m_{w,i}} \in t_i^{-1}Ht_i$ ,  $m_{w,i}$  is also the minimal natural number such that  $w^{m_{w,i}}$  is a loop at  $\tilde{x}_i$ .  $\square$

In [29], the authors define the order of an element in regular coverings. We extend the definition of the order of an element to any covering.

**Definition 4.5.** Let  $H < F_n$  of index  $d$ . Let  $w \in F_n$ . Let  $\tilde{X}_H, \mathcal{T}$  as in Definition 4.1.

- (i) *The order of  $w$  at  $\tilde{x}_i$  in  $\tilde{X}_H$  is the minimal natural number  $1 \leq o(w, i) \leq d$  such that  $w^{o(w, i)}$  is a loop at  $\tilde{x}_i$ , or equivalently such that  $w^{o(w, i)} \in t_i^{-1}Ht_i$ .*

- (ii) The  $k$ -th  $w$ -step,  $1 \leq k \leq o(w, i)$ , is the  $k$ -th path labelled  $w$  in the loop  $w^{o(w, i)}$  at  $\tilde{x}_i$ .
- (iii) The set  $V_{w, i}$  is the set of vertices in  $\tilde{X}_H$  visited at each  $w$ -step in the loop  $w^{o(w, i)}$  at  $\tilde{x}_i$ .
- (iv) The loops of  $w$  at  $\tilde{x}_i$  and  $\tilde{x}_j$  are *disjoint* if  $V_{w, i} \cap V_{w, j} = \emptyset$

**Example 4.6.** Consider Examples 4.2. For  $w = aba^{-1}$ ,  $o(aba^{-1}, 0) = 2$ ,  $V_{aba^{-1}, 0} = V_{aba^{-1}, 2} = \{\tilde{x}_0, \tilde{x}_2\}$  and  $o(aba^{-1}, 1) = 1$ ,  $V_{aba^{-1}, 1} = \{\tilde{x}_1\}$ , that is the loops at  $\tilde{x}_0$  and  $\tilde{x}_1$  are disjoint. If we reduce cyclically  $aba^{-1}$ , we get  $b$ , with  $o(b, 0) = 1$ ,  $V_{b, 0} = \{\tilde{x}_0\}$ ;  $o(b, 1) = o(b, 2) = 2$ ,  $V_{b, 1} = V_{b, 2} = \{\tilde{x}_1, \tilde{x}_2\}$ . If  $w = ab$ ,  $o(ab, 0) = o(ab, 1) = o(ab, 2) = 3$ ,  $V_{a, 0} = V_{a, 1} = V_{a, 2} = \{\tilde{x}_0, \tilde{x}_1, \tilde{x}_2\}$ .

**Lemma 4.7.** Let  $H < F_n$  of index  $d$ . Let  $N_H$  denote the normal core of  $H$ . Let  $\tilde{X}_H$  be the Schreier graph of  $H$  with vertices  $\tilde{x}_0, \tilde{x}_1, \dots, \tilde{x}_{d-1}$ . Let  $w \in F_n$  with  $o(w, i)$  and  $V_{w, i}$ ,  $0 \leq i \leq d-1$ , as in Definition 4.5. Then

- (i)  $|V_{w, i}| = o(w, i)$ .
- (ii) Either  $V_{w, i} \cap V_{w, j} = \emptyset$ , or  $V_{w, i} = V_{w, j}$ ,  $0 \leq i, j \leq d-1$ .
- (iii)  $\bigcup_{i=0}^{i=d-1} V_{w, i} = \{\tilde{x}_0, \dots, \tilde{x}_{d-1}\}$ .
- (iv)  $\sum o(w, i) = d$ , where the sum is on disjoint loops.
- (v) If for some integer  $k$ ,  $w^k$  is a loop at  $\tilde{x}_i$ , then  $o(w, i)$  divides  $k$ .
- (vi) If  $o(w, i) = d$  for some  $0 \leq i \leq d-1$ , then  $w^d \in N_H$ .
- (vii) If  $w^k \in N_H$  for  $k \in \mathbb{Z}$ , then  $\text{lcm}\{o(w, i) \mid 0 \leq i \leq d-1\}$  divides  $k$ .
- (viii)  $o(w, i)$  divides  $[F_n : N_H]$ .

In particular,  $w \in N_H$  if and only if  $o(w, i) = 1$ , for all  $0 \leq i \leq d-1$ .

*Proof.* (i) Clearly,  $|V_{w, i}| \leq o(w, i)$ . If  $|V_{w, i}| < o(w, i)$ , then the loop crosses a vertex at least twice and there exists a loop  $w^j$  at  $\tilde{x}_i$  with  $j < o(w, i)$ , so this contradicts the minimality of  $o(w, i)$ .

(ii) Assume by contradiction there exists  $\tilde{x}_k \in V_{w, i} \cap V_{w, j}$ , with  $V_{w, i} \neq V_{w, j}$ . So, from (i),  $o(w, k) = o(w, i) = o(w, j)$ , and there are two different loops of the same length  $o(w, i)$  at  $\tilde{x}_k$ . So, beginning at  $\tilde{x}_k$ , there exists a first  $j < o(w, i)$ , such that at the  $j$ -th  $w$ -step in one loop the

vertex  $\tilde{x}_{k'}$  is attained and in the other loop a different vertex  $\tilde{x}_{k''}$  is attained. That is, the element  $w^j$  acts in two different ways on the coset of  $H$  represented by  $\tilde{x}_k$  and this is a contradiction.

(iii), (iv) The sets  $V_{w,i}$  partition the finite set  $\{\tilde{x}_0, \dots, \tilde{x}_{d-1}\}$ .

(v) From the minimality of  $o(w, i)$ ,  $o(w, i) \leq k$ . We divide  $k$  by  $o(w, i)$ :  $k = q(o(w, i)) + r$ , with residue  $0 \leq r < o(w, i)$ . So,  $w^r = w^{k-q(o(w, i))}$  is a loop at  $\tilde{x}_i$ . From the minimality of  $o(w, i)$ ,  $r = 0$ , that is  $o(w, i)$  divides  $k$ .

(vi) If  $o(w, i) = d$ , then  $w^d$  is a loop at all the  $d$  vertices. So,  $w^d$  belongs to all the conjugates of  $H$ , that is  $w^d \in N_H$ .

(vii), (viii) If  $w^k \in N_H$ , then from (v),  $o(w, i)$  divides  $k$  for every  $0 \leq i \leq d-1$ , that is  $\text{lcm}\{o(w, i) \mid 0 \leq i \leq d-1\}$  divides  $k$ . As  $N_H \triangleleft F_n$ ,  $k$  divides  $[F_n : N_H]$  and so  $o(w, i)$  divides  $[F_n : N_H]$ , for all  $0 \leq i \leq d-1$ .  $\square$

Note that from Lemma 4.7(v), it results that for every integer  $q$  dividing  $o(w, i)$ , there exists an element  $g \in F_n$  with  $o(g, i) = q$  (take  $g = w^{\frac{o(w, i)}{q}}$ ). We now consider the case of a normal subgroup, with a regular covering.

**Lemma 4.8.** *Let  $N \triangleleft F_n$  of index  $m$ . Let  $\tilde{X}_N$  be the Schreier graph of  $N$  with vertices  $\tilde{x}_0, \tilde{x}_1, \dots, \tilde{x}_{m-1}$ . Let  $\mathcal{T} = \{1, t_i \mid 1 \leq i \leq m-1\}$  be a transversal of  $N$  in  $F_n$ , with  $t_i$  the label of a minimal path from  $\tilde{x}_0$  to  $\tilde{x}_i$ . Let  $w \in F_n$  with  $o(w, i)$  and  $V_{w,i}$ ,  $0 \leq i \leq m-1$ , as in Definition 4.5. Then*

(i)  $o(w, i) = o(w, j) = o(w)$ , for all  $0 \leq i, j \leq m-1$ .

(ii)  $o(w)$  divides  $m$ .

(iii) There are exactly  $\frac{m}{o(w)}$  disjoint loops labelled  $w^{o(w)}$  in  $\tilde{X}_N$ .

*Proof.* (i) We recall that  $o(w, i)$  is the minimal natural number such that  $w^{o(w, i)} \in t_i^{-1} N t_i$ . Since  $N \triangleleft F_n$ ,  $g^{-1} N g = N$  for every  $g \in F_n$ . So, for all  $0 \leq i, j \leq m-1$ ,  $o(w, i) = o(w, j) = o(w)$ .

(ii) results from Lemma 4.7(iv) and (iii) from Lemma 4.7(iii).  $\square$

We introduce a graph derived from the Schreier graph that describes the  $w$ -steps, where  $w$  is a word in  $F_n$ .

**Definition 4.9.** Let  $w \in F_n$ . Let  $H < F_n$  of index  $d$ . Let  $\tilde{X}_H$  be the Schreier graph of  $H$ . We define  $\tilde{X}_H(w)$  to be the Schreier graph of  $H$ , but instead of being labelled by the generators of  $F_n$ , only the  $w$ -steps are specified. We also call  $\tilde{X}_H(w)$  the Schreier graph of  $H$ .

**Example 4.10.** Consider the subgroup  $G$  of index 3 in  $F_2$  from Example 4.2. Let  $w = ab$ . Then,  $\tilde{X}_G(ab)$  is the following connected graph:

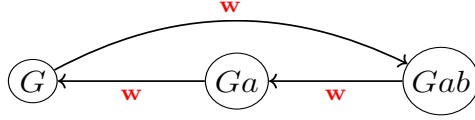

Figure 4.10.1: The graph  $\tilde{X}_G(ab)$  for  $G = \langle b, a^2, ab^2a, (ab)^2a \rangle$ .

Let  $w = a$ . The graph  $\tilde{X}_G(a)$  is the following disconnected graph:



Figure 4.10.2: The graph  $\tilde{X}_G(a)$  for  $G = \langle b, a^2, ab^2a, (ab)^2a \rangle$ .

From Lemma 4.8, the situation described in Figure 4.10.2 can never occur if the subgroup is normal.

### 4.3 What happens when we look at a tower of covering spaces?

Let  $H < F_n$  of index  $d$ . Let  $\tilde{X}_H$  be the Schreier graph of  $H$ . Let  $N < F_n$  of index  $m$  such that  $N \subset H$ , with Schreier graph  $\tilde{X}_N$ . The subgroup  $H$  is a free group of rank  $d(n-1) + 1$ , so it is the fundamental group of  $X_H$ , the bouquet of  $d(n-1) + 1$  circles. As  $N < H$ , there exists a regular  $\frac{m}{d}$ -sheeted covering  $\hat{X}_N$  over  $X_H$ , such that the  $\frac{m}{d}$  vertices in  $\hat{X}_N$  represent the  $\frac{m}{d}$  right cosets of  $N$  whose disjoint union is  $H$  (see Theorem 2.1). We now introduce a graph that combines in some sense the Schreier graphs of  $N$  and  $H$ , and gives a more complete picture.

**Definition 4.11.** Let  $w \in F_n$ . Let  $H < F_n$  of index  $d$  and let  $N < F_n$  of index  $m$  such that  $N \subset H$ . Let  $\tilde{X}_H(w)$ ,  $\tilde{X}_N(w)$  as in Definition 4.9. We define *the combined graph of  $N$  and  $H$* , denoted by  $\tilde{X}_{N,H}(w)$ , to be the following two-levelled graph:

At the top layer, denoted *Top*:  $\tilde{X}_N(w)$

At the bottom layer, denoted *Bot*:  $\tilde{X}_H(w)$



The relative position of the vertices in *Top* and *Bot* is:

For each vertex  $\tilde{x}_i$  representing  $Ht_i$  in *Bot*, there is above it a set of  $\frac{m}{d}$  vertices  $Ny_1, \dots, Ny_{\frac{m}{d}}$  such that  $Ht_i$  is the disjoint union of  $Ny_1, \dots, Ny_{\frac{m}{d}}$ . We call the set  $\{Ny_1, \dots, Ny_{\frac{m}{d}}\}$  the fiber over  $Ht_i$ , denoted by  $p_w^{-1}(Ht_i)$ .

As  $N \subset H$ , the action of  $F_n$  on the right cosets of  $H$  induces an action of  $F_n$  on the right cosets of  $N$ . That is, for each loop in *Bot*, there is at least one loop induced in *Top*. Indeed, consider the loop labelled  $w^{o(w,i)}$  at  $\tilde{x}_i$  in *Bot* with  $V_{w,i}$ ,  $0 \leq i \leq d-1$ , as in Definition 4.5. Then, if we denote by  $p_w^{-1}(V_{w,i})$  the set of fibers in *Top* over the set of visited vertices, then there are some loops connecting the fibers in  $p_w^{-1}(V_{w,i})$ . We will study these loops in more detail in the following lemmas.

**Example 4.12.** Let  $K < F_2$  of index 4 from Example 2.3. Let  $N = N_K$  of index 8 in  $F_2$ , with  $\tilde{X}_N$  below, and  $\tilde{X}_{N,K}(ab)$  in Figure 4.12.1:

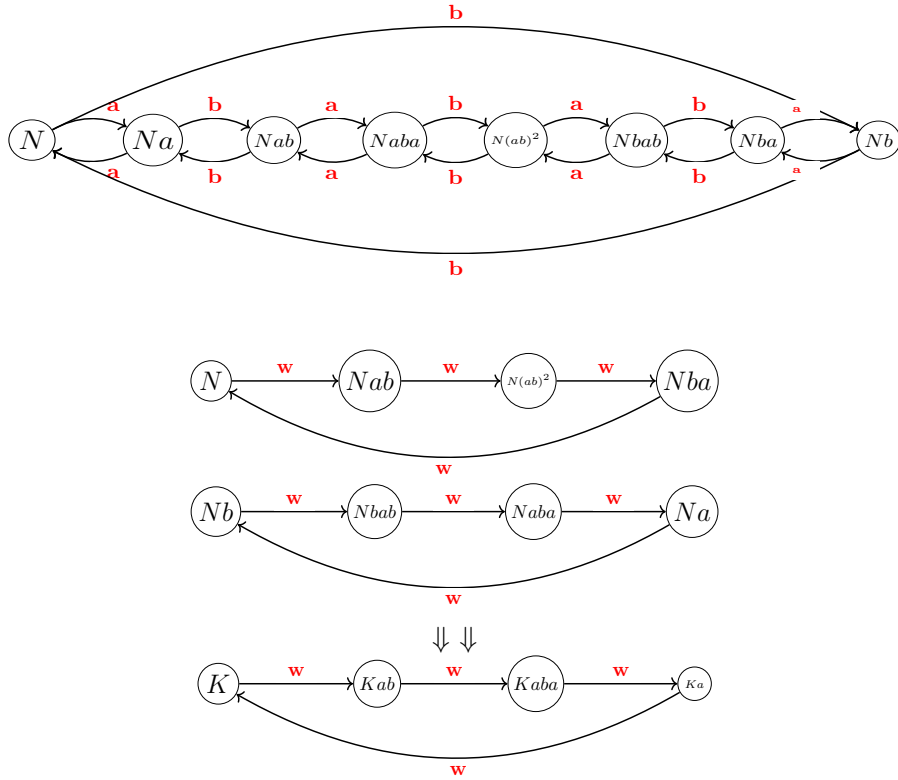

Figure 4.12.1: The combined graph  $\tilde{X}_{N,K}(w)$ : *Top*:  $\tilde{X}_N(w)$ , and *Bot*:  $\tilde{X}_K(w)$ , with arrows delimiting between *Top* and *Bot*,  $w = ab$ .

In *Bot*, there is one loop of length 4, labelled  $w^4$ , since  $o_K(w) = 4$ . In *Top*, there are 2 disjoint loops of length 4, labelled  $w^4$ . The fiber of  $K$  is the set  $p_w^{-1}(K) = \{N, Nb\}$ , with all its elements just above  $K$ , the fiber of  $Kab$  is  $p_w^{-1}(Kab) = \{Nab, Nbab\}$  with all its elements just above  $Kab$  and so on. Now, consider  $H = \langle b, a^2, aba \rangle < F_2$  of index 2. Then  $N < H$  and  $\tilde{X}_{N,H}(ab)$  is:

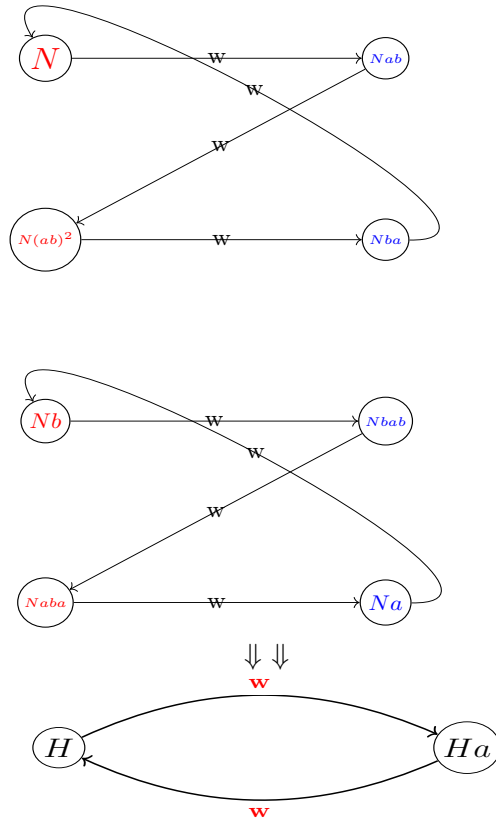

Figure 4.12.2: The combined graph  $\tilde{X}_{N,H}(w)$ : *Top*:  $\tilde{X}_N(w)$ , and *Bot*:  $\tilde{X}_H(w)$ , with arrows delimiting between *Top* and *Bot*,  $w = ab$ .

The fiber of  $H$  is  $p_w^{-1}(H) = \{N, N(ab)^2, Nb, Naba\}$ , with all its elements just above  $H$  and the fiber of  $Ha$  is  $p_w^{-1}(Ha) = \{Nab, Nba, Nbab, Na\}$ , with all its elements just above  $Ha$ . In *Bot*, there is one loop of length 2,

labelled  $w^2$ , since  $o_H(w) = 2$ . In *Top*, there are 2 disjoint loops of length 4, labelled  $w^4$ . These are exactly the same loops as in Figure 4.12.1, but their distribution into the fibers are different. Here each fiber contributes two elements in a loop, while in *Top* of  $\tilde{X}_{N,K}(ab)$  each fiber contributes only one element in a loop.

The next lemma describes some basic properties of the combined graph that are derived directly from its definition and the properties of  $\tilde{X}_H(w)$ ,  $\tilde{X}_N(w)$  (see Section 4.2).

**Lemma 4.13.** *Let  $w \in F_n$ . Let  $H < F_n$  of index  $d$  and  $N \triangleleft F_n$  of index  $m$  such that  $N \subset H$ . Let  $\tilde{X}_{N,H}(w)$  be their combined graph. Then*

- (i) *In Bot, there are  $d$  vertices.*
- (ii) *In Top, there are  $d$  fibers each of size  $\frac{m}{d}$ .*
- (iii) *In Top, the fiber over  $Hx$  is the set of  $\frac{m}{d}$  right cosets of  $N$  whose disjoint union is  $Hx$ .*
- (iv) *In Top, there are exactly  $\frac{m}{o_N(w)}$  disjoint loops labelled  $w^{o_N(w)}$ .*

In the following lemmas, we describe the connection between the top layer and the bottom layer in the combined graph. The next lemma is very important for the rest of the paper, as here we describe entirely the induced loops in *Top*.

**Lemma 4.14.** *Let  $w \in F_n$ . Let  $H < F_n$  of index  $d$  and  $N \triangleleft F_n$  of index  $m$  such that  $N \subset H$ . Let  $\tilde{X}_{N,H}(w)$  be their combined graph, with  $\tilde{x}_0, \tilde{x}_1, \dots, \tilde{x}_{d-1}$  the vertices in Bot. Let  $o(w, j)$  be the order of  $w$  at a chosen vertex  $\tilde{x}_j$  in Bot and let  $V_{w,j}$  be the set of vertices visited at each  $w$ -step in this loop. Let  $p_w^{-1}(V_{w,j})$  be the set of fibers over  $V_{w,j}$  in Top. Then*

- (i)  $|p_w^{-1}(V_{w,j})| = |V_{w,j}| = o(w, j)$ .
- (ii) *The loop in Bot labelled  $w^{o(w,j)}$  between the vertices in  $V_{w,j}$  induces  $\frac{\frac{m}{d}}{\frac{o_N(w)}{o(w,j)}}$  loops labelled  $w^{o_N(w)}$  between the  $o(w, j)$  fibers in  $p^{-1}(V_{w,j})$  in Top.*
- (iii) *Each fiber in  $p_w^{-1}(V_{w,j})$  contributes exactly  $\frac{o_N(w)}{o(w,j)}$  elements in an induced loop labelled  $w^{o_N(w)}$ .*

*Proof.* (i) As  $N \subset H$ , the action of  $F_n$  on the right cosets of  $H$  induces an action of  $F_n$  on the corresponding right cosets of  $N$ .

(ii), (iii) To simplify the notation, let  $k = o(w, j)$ , let  $\ell$  denote the loop in  $Bot$  labelled  $w^k$  at  $\tilde{x}_j$ . Assume  $\tilde{x}_j$  represents the right coset  $Hx$  and  $p_w^{-1}(Hx) = \{Ny_1, Ny_2, \dots, Ny_{\frac{m}{d}}\}$ . Each  $w$ -step in  $Bot$  between two vertices  $Hx$  and  $Hxw$  induces a  $w$ -step in  $Top$  between  $Ny_i$  and  $Ny_iw$ , for every  $1 \leq i \leq \frac{m}{d}$ . So,  $\ell$  induces

$Ny_i \rightarrow Ny_iw \rightarrow Ny_iw^2 \rightarrow \dots \rightarrow Ny_iw^{k-1} \rightarrow Ny_iw^k \rightarrow Ny_iw^{k+1} \dots$ . From Definition 4.5(i),  $k$  is the minimal natural number such that  $w^k \in x^{-1}Hx$  or equivalently  $Hxw^k = Hx$ . So,  $Ny_iw^k \in p_w^{-1}(Hx)$ ,  $Ny_iw^{k+1} \in p_w^{-1}(Hxw)$  and so on.

If  $k = o_N(w)$ , then  $Ny_iw^k = Ny_i$ , for all  $1 \leq i \leq \frac{m}{d}$  and each fiber in  $p^{-1}(V_{w,j})$  contributes exactly  $\frac{o_N(w)}{o(w,j)} = \frac{o_N(w)}{k} = 1$  element in a loop labelled  $w^{o_N(w)}$ . Since there are  $\frac{m}{d}$  elements in each fiber, the loop in  $Bot$  labelled  $w^k$  induces  $\frac{\frac{m}{d}}{\frac{o_N(w)}{k}} = \frac{m}{d}$  loops labelled  $w^{o_N(w)}$  between the  $o(w, j)$  fibers in  $p^{-1}(V_{w,j})$ .

Assume now that  $\frac{o_N(w)}{k} = p > 1$ . Then  $Ny_iw^k \in p_w^{-1}(Hx)$ , but  $Ny_iw^k \neq Ny_i$  and  $Ny_iw^{pk} = Ny_i$ . In fact,  $Ny_iw^k = Ny_{i_1}$ ,  $Ny_iw^{2k} = Ny_{i_2}, \dots$ ,  $Ny_iw^{(p-1)k} = Ny_{i_{p-1}}$  for different  $i_1, i_2, \dots, i_{p-1}$  between 1 and  $\frac{m}{d}$ . So,  $\ell$  induces a loop of length  $o_N(w)$  between the  $k$  fibers of the form:

$$\begin{array}{ccccccc} Ny_i & \rightarrow & Ny_iw & \rightarrow & Ny_iw^2 & \rightarrow \dots & Ny_iw^{k-1} \rightarrow \\ Ny_iw^k & \rightarrow & Ny_iw^{k+1} & \rightarrow & Ny_iw^{k+2} & \rightarrow \dots & Ny_iw^{2k-1} \rightarrow \\ \dots & \dots & \dots & \dots & \dots & \dots & \dots \\ Ny_iw^{(p-1)k} & \rightarrow & Ny_iw^{(p-1)k+1} & \rightarrow & Ny_iw^{(p-1)k+2} & \rightarrow & Ny_iw^{kp-1} \end{array}$$

In such a loop, each fiber contributes exactly  $\frac{o_N(w)}{k} = p$  elements. Since there are  $\frac{m}{d}$  elements in each fiber,  $\ell$  induces  $\frac{\frac{m}{d}}{\frac{o_N(w)}{k}}$  loops labelled  $w^{o_N(w)}$

between the  $o(w, j)$  fibers in  $p^{-1}(V_{w,j})$ . □

*Remark 4.15.* As Example 4.12 illustrate it, given  $N \triangleleft F_n$  of index  $m$  and  $w \in F_n$ , the number of loops and the length of the loops in  $Top$  of any combined graph  $\tilde{X}_{N,H}(w)$  are independent of the subgroup  $H$ . Indeed,  $o_N(w)$  is determined by  $\tilde{X}_N$  and the loops correspond to the action of  $w$  on the cosets of  $N$ , or more generally if  $w = a, b$  they describe the action of  $F_n$  on the cosets of  $N$ . Yet, changing  $H$  changes the fibers, the size of the fibers ( $= \frac{m}{d_H}$ ) and the number of elements ( $= \frac{o_N(w)}{o_H(w)}$ ) contributed by each fiber in a loop of length  $o_N(w)$ .

## 5 The HS conjecture and covering spaces

Let  $\{H_i\alpha_i\}_{i=1}^{i=s}$  be a coset partition of  $F_n$  with  $H_i < F_n$  of index  $d_i > 1$ ,  $\alpha_i \in F_n$ ,  $1 \leq i \leq s$ . Let  $N_i = \bigcap_{g \in F_n} g^{-1}H_i g$  of index  $m_i$ . Let  $N = \bigcap_{i=1}^{i=s} N_i$  of index  $m$ . For every  $1 \leq i \leq s$ , and for any  $w \in F_n$ , there exists a combined graph  $\tilde{X}_{N,H_i}(w)$ , since  $N \triangleleft F_n$  and  $N \subset H_i$ . At *Top* of every combined graph  $\tilde{X}_{N,H_i}(w)$ , there are  $\frac{m}{o_N(w)}$  loops of length  $o_N(w)$  labelled  $w^{o_N(w)}$ . Yet, for each  $i$ , *Top* of  $\tilde{X}_{N,H_i}(w)$  looks different, since the fibers and the connections between them are different and they depend on the subgroup  $H_i$  (see Section 4.3). Our aim in the following section is to describe graphically the coset partition in terms of the combined graphs  $\tilde{X}_{N,H_i}(w)$ , for any  $w \in F_n$ . In particular, we introduce a new graph, the HS-colored graph, to describe the coset partition.

### 5.1 A graphical description of a coset partition of $F_n$ with the Schreier graphs

Let  $w \in F_n$ , with order  $o_N(w)$ . Let  $\tilde{X}_N(w)$  be the Schreier graph of  $N$ . Let  $\tilde{X}_{N,i}(w)$  denote the  $s$  combined graphs  $\tilde{X}_{N,H_i}(w)$ ,  $1 \leq i \leq s$ . Let denote by  $p_w^{-1}(H_i\alpha_i)$  the fiber over  $H_i\alpha_i$  in *Top* of the combined graph  $\tilde{X}_{N,i}(w)$ . In each  $\tilde{X}_{N,i}(w)$ ,  $1 \leq i \leq s$ , let color in color  $c_i$  the vertex representing the coset  $H_i\alpha_i$  at *Bot*, and all the elements in the fiber  $p_w^{-1}(H_i\alpha_i)$  in *Top*. We keep record of the color attributed to each coset of  $N$ , and color accordingly the vertices in  $\tilde{X}_N(w)$ .

**Definition 5.1.** Let  $\{H_i\alpha_i\}_{i=1}^{i=s}$  be a coset partition of  $F_n$  with  $H_i < F_n$  of index  $d_i$ ,  $\alpha_i \in F_n$ ,  $1 \leq i \leq s$ . Let  $N = \bigcap_{i=1}^{i=s} \bigcap_{g \in F_n} g^{-1}H_i g$  of index  $m$ , with Schreier graph  $\tilde{X}_N(w)$ ,  $w \in F_n$ .

- (i) We define  $\bar{X}_N(w)$ , *the HS-colored graph*, to be  $\tilde{X}_N(w)$  with colored vertices: a vertex is colored in color  $c_i$  if and only if it belongs to  $p_w^{-1}(H_i\alpha_i)$  in *Top* of  $\tilde{X}_{N,i}(w)$ ,  $1 \leq i \leq s$ .
- (ii) We define *the order of  $w$  relative to  $H_i\alpha_i$* ,  $o_{*i}(w)$ , to be the order of  $w$  in *Bot* of  $\tilde{X}_{N,i}(w)$  relative to the vertex  $H_i\alpha_i$ , that is the minimal natural number such that  $w^{o_{*i}(w)} \in \alpha_i^{-1}H_i\alpha_i$ , or equivalently  $w^{o_{*i}(w)}$  is a loop at the vertex  $H_i\alpha_i$  in *Bot* of  $\tilde{X}_{N,i}(w)$ .

Since  $\{H_i\alpha_i\}_{i=1}^{i=s}$  is a coset partition of  $F_n$  and each fiber  $p_w^{-1}(H_i\alpha_i)$  contains exactly  $\frac{m}{d_i}$  cosets of  $N$ , we have that each vertex in  $\bar{X}_N(w)$  is colored in one and only one color, and  $m = \sum_{i=1}^{i=s} \frac{m}{d_i}$ .

**Example 5.2.** Consider this partition of  $F_2$ :  $F_2 = H_1 \cup H_2a \cup H_3ab$ , where  $H_1 = H = \langle b, a^2, aba \rangle$  and  $H_2 = H_3 = K$  from Example 2.3. Let  $N \triangleleft F_2$  of index 8 from Example 4.12,  $N$  is the intersection of the normal cores of  $H_1$ ,  $H_2$  and  $H_3$ . Let  $w = ab$  with  $o_N(w) = 4$ ,  $o_{*1}(w) = 2$ ,  $o_{*2}(w) = o_{*3}(w) = 4$ . The HS-colored graph  $\bar{X}_N(w)$  is described below:

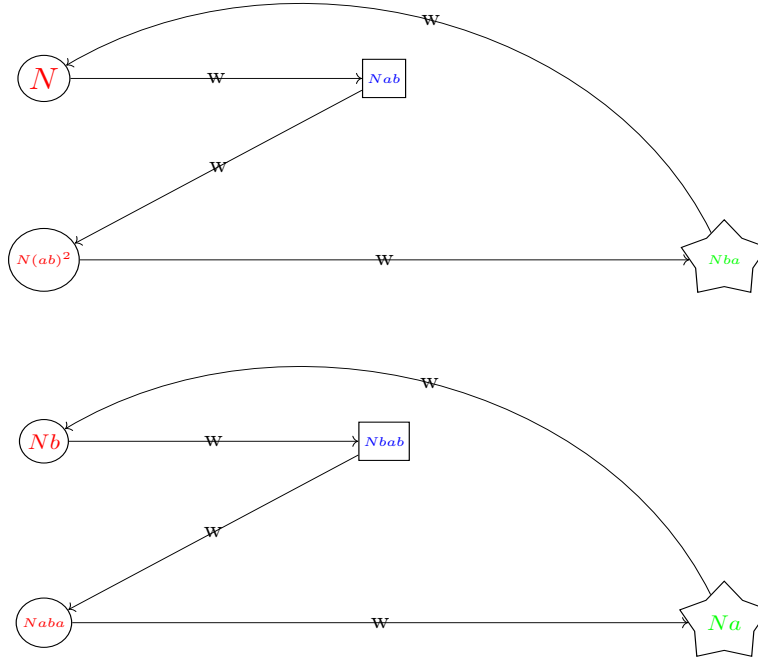

Figure 5.2.1: The HS-colored graph  $\bar{X}_N(w)$ , with  $N \triangleleft F_2$ ,  $w = ab$ .

The vertices in  $p_w^{-1}(H_1) = \{N, N(ab)^2, Nb, Naba\}$  are colored in red (circles), those in  $p_w^{-1}(H_2a) = \{Nba, Na\}$  in green (stars) and those in  $p_w^{-1}(H_3ab) = \{Nab, Nbab\}$  in blue (squares). From Lemma 4.14, the fiber  $p_w^{-1}(H_1)$  participates in  $\frac{\frac{m}{d_1}}{\frac{o_N(w)}{o_{*1}(w)}} = 2$  loops and in each loop it contributes  $\frac{o_N(w)}{o_{*1}(w)} = 2$  elements, the fiber  $p_w^{-1}(H_2a)$  participates in  $\frac{\frac{m}{d_2}}{\frac{o_N(w)}{o_{*2}(w)}} = 2$  loops

and in each loop it contributes  $\frac{o_N(w)}{o_{*2}(w)} = 1$  element and the same holds for the fiber  $p_w^{-1}(H_3ab)$ .

Before we go on with  $F_n$  with  $n \geq 2$ , we give a graphical description of a coset partition in the special case of  $F_1 = \mathbb{Z}$ .

## 5.2 A graphical description of a coset partition of $\mathbb{Z}$

The group of integers  $\mathbb{Z} = \langle 1 \rangle$  is the fundamental group of the bouquet  $X$  with only one circle labelled 1. For each subgroup  $H = o\mathbb{Z}$  of index  $o > 1$ , there exists a  $o$ -fold covering  $\tilde{X}_H$ , which is an oriented loop of length  $o > 1$  and labelled  $o$ . Let  $\{o_i\mathbb{Z} + r_i\}_{i=1}^{i=t}$ ,  $r_i \in \mathbb{Z}$ , be a coset partition of  $\mathbb{Z}$ . Let fix  $w = 1$ , so that  $o_i(1) = o_i$ , and  $\tilde{X}_H$  and  $\tilde{X}_H(1)$  coincide, for any  $H < \mathbb{Z}$ .

Let  $N = o_N\mathbb{Z}$ , with  $o_N$  divisible by  $\text{lcm}(o_1, \dots, o_t)$ , so  $N \subseteq \bigcap_{i=1}^{i=t} o_i\mathbb{Z}$ . Let  $\bar{X}_N$  be the HS-colored graph as defined in Section 5.1. Since  $o_N(1) = o_N$ , there is a unique loop of length  $o_N$ . So, all the  $t$  fibers participate in this unique loop and from Lemma 4.14, each fiber contributes all its  $\frac{o_N}{o_i} (= \frac{o_N(1)}{o_i(1)})$  elements in this loop. That is,  $\sum_{i=1}^{i=t} \frac{o_N}{o_i} = o_N$ . And conversely,

**Lemma 5.3.** *Let  $c_i$ ,  $1 \leq i \leq t$ , be different colors. Let  $o_N$ ,  $o_i > 1$ ,  $1 \leq i \leq t$ , be natural numbers such that  $\text{lcm}(o_1, \dots, o_t)$  divides  $o_N$ . If there exists a loop  $\ell$  of length  $o_N = \sum_{i=1}^{i=t} \frac{o_N}{o_i}$ , with each package of  $\frac{o_N}{o_i}$  vertices colored in  $c_i$ ,  $1 \leq i \leq t$  and such that any two consecutive vertices colored in the same color  $c_i$  are at  $o_i$  distance. Then there exist  $r_i \in \mathbb{Z}$ ,  $1 \leq i \leq t$ , such that  $\{o_i\mathbb{Z} + r_i\}_{i=1}^{i=t}$  is a coset partition of  $\mathbb{Z}$ .*

*Proof.* We set  $N = o_N\mathbb{Z}$  and  $H_i = o_i\mathbb{Z}$ ,  $1 \leq i \leq t$ . Since  $\text{lcm}(o_1, \dots, o_t)$  divides  $o_N$ ,  $N \subseteq \bigcap_{i=1}^{i=t} H_i$ . We show that a loop  $\ell$  satisfying the conditions of the lemma describes the Schreier graph of  $N$  and a coset partition  $\{o_i\mathbb{Z} + r_i\}_{i=1}^{i=t}$ . Choose any vertex in  $\ell$  and call it  $N$  and the adjacent vertex  $N + 1$  and so on until  $N + o_N - 1$ . If in  $\ell$ , any two consecutive vertices colored in the same color  $c_i$  are at  $o_i$  distance, then there exist  $r_i \in \mathbb{Z}$ ,  $1 \leq i \leq t$ , such that the vertices colored  $c_i$  are  $N + r_i$ ,  $N + r_i + o_i$ ,  $N + r_i + 2o_i, \dots, N + r_i + (\frac{o_N}{o_i} - 1)o_i$ , that is these are  $\frac{o_N}{o_i}$  cosets of  $N$  whose union is  $o_i\mathbb{Z} + r_i$ . Next, since each vertex in  $\ell$  is colored in only one color, the sets  $o_i\mathbb{Z} + r_i$ ,  $1 \leq i \leq t$ , are all disjoint. At last,  $o_N = \sum_{i=1}^{i=t} \frac{o_N}{o_i}$  implies that  $\mathbb{Z}$  is partitioned by these disjoint cosets.  $\square$

**Theorem 5.4.** *[30, Theorem 2][31, Theorems 4,5] Let  $\{o_i\mathbb{Z} + r_i\}_{i=1}^{i=t}$  be a coset partition of  $\mathbb{Z}$ . Then:*

- (i) The natural numbers  $\{o_i \mid 1 \leq i \leq t\}$  are not pairwise prime.
- (ii)  $o_{max} = \text{Max}\{o_i \mid 1 \leq i \leq t\}$  appears at least  $p$  times, where  $p$  is the smallest prime dividing  $o_{max}$ .
- (iii) Any  $o_l$  divides another  $o_k$ , where  $1 \leq k \neq l \leq t$ .
- (iv) Any  $o_k$  that does not properly divide any other  $o_i$  appears at least twice,  $1 \leq k, i \leq t$ .

## 6 Main results on the Herzog-Schönheim conjecture for free groups of finite rank

In this section, we give some conditions that ensure a partition of the free group of finite rank has multiplicity. The notation is the following for the rest of this section. Let  $F_n$  be the free group on  $n \geq 2$  generators. Let  $\{H_i\alpha_i\}_{i=1}^{i=s}$  be a coset partition of  $F_n$  with  $H_i < F_n$  of index  $d_i > 1$ ,  $\alpha_i \in F_n$ ,  $1 \leq i \leq s$ , and  $d_1 \leq \dots \leq d_s$ . Let  $N_i = \bigcap_{g \in F_n} g^{-1}H_i g$  of index  $m_i$ .

Let  $N = \bigcap_{i=1}^{i=s} N_i$  of index  $m$ . Let  $w \in F_n$ . Let  $\tilde{X}_i(w)$  denote the Schreier graph  $\tilde{X}_{H_i}(w)$ ,  $1 \leq i \leq s$  and  $\tilde{X}_N(w)$  be the Schreier graph of  $N$ . Let  $\tilde{X}_{N,i}(w)$  denote the combined graph  $\tilde{X}_{N,H_i}(w)$ ,  $1 \leq i \leq s$ . Let denote by  $p_w^{-1}(H_i\alpha_i)$  the fiber over  $H_i\alpha_i$  in *Top* of the combined graph  $\tilde{X}_{N,i}(w)$ . Let  $\bar{X}_N(w)$  be the HS-colored graph. Let  $o_{*i}(w)$ ,  $1 \leq i \leq s$ , be the order of  $w$  relative to the vertex  $H_i\alpha_i$ .

### 6.1 Description of the loops in the HS-colored graph

In *Top* of any combined graph, there are the same  $\frac{m}{o_N(w)}$  disjoint loops of length  $o_N(w)$  from  $\tilde{X}_N(w)$ . But, for different subgroups  $H_i$  and  $H_j$ , the fibers in *Top* of  $\tilde{X}_{N,i}(w)$  and  $\tilde{X}_{N,j}(w)$  are different and so *Top* of  $\tilde{X}_{N,i}(w)$  and  $\tilde{X}_{N,j}(w)$  look also different. The HS-colored graph  $\bar{X}_N(w)$  describes the partition  $\{H_i\alpha_i\}_{i=1}^{i=s}$ , with each fiber  $p_w^{-1}(H_i\alpha_i)$  colored in a different color (see Figures 4.12.1, 4.12.2 and 5.2.1). The question now is how the colored fibers are connected in  $\bar{X}_N(w)$ . In the following lemmas, we aim to answer this question and describe the loops in  $\bar{X}_N(w)$ .

Note that  $w \in \bigcap_{i=1}^{i=s} \alpha_i^{-1}H_i\alpha_i$  if and only if  $o_{*i}(w) = 1$  for every  $1 \leq i \leq s$ , so if  $w \in F_n \setminus \bigcap_{i=1}^{i=s} \alpha_i^{-1}H_i\alpha_i$ , then there exists  $1 \leq i_1 \leq s$  such that  $o_{*i_1}(w) > 1$ .



**Lemma 6.1.** *Let  $w \in F_n \setminus \bigcap_{i=1}^{i=s} \alpha_i^{-1} H_i \alpha_i$ , with order  $o_N(w)$ . Then in  $\bar{X}_N(w)$ , the HS-colored graph, the following occurs:*

- (i) *There are  $\frac{m}{o_N(w)}$  disjoint loops of length  $o_N(w)$  (labelled  $w^{o_N(w)}$ ).*
- (ii) *If the fiber  $p_w^{-1}(H_i \alpha_i)$  participates in a loop, then it contributes  $\frac{o_N(w)}{o_{*i}(w)}$  elements and the distance between two consecutive vertices is  $o_{*i}(w)$ .*
- (iii) *Each fiber  $p_w^{-1}(H_i \alpha_i)$  participates in  $\frac{\frac{m}{d_i}}{\frac{o_N(w)}{o_{*i}(w)}}$  loops.*
- (iv) *A fiber  $p_w^{-1}(H_i \alpha_i)$  participates in all the  $\frac{m}{o_N(w)}$  loops if and only if  $o_{*i}(w) = d_i$ .*
- (v) *Two fibers  $p_w^{-1}(H_i \alpha_i)$  and  $p_w^{-1}(H_j \alpha_j)$  participate in the same number of loops if and only if  $\frac{o_{*i}(w)}{d_i} = \frac{o_{*j}(w)}{d_j}$ .*
- (vi) *For each  $j$ -th loop,  $1 \leq j \leq \frac{m}{o_N(w)}$ , the following equation holds:*

$$\sum_{i \in Y_j} \frac{o_N(w)}{o_{*i}(w)} = o_N(w) \quad (6.1)$$

where  $Y_j = \{1 \leq i \leq s \mid p^{-1}(H_i \alpha_i) \text{ participates in the } j\text{-th loop}\}$ .

*Proof.* (i), (ii), (iii) result from Lemma 4.14, since from the definition of the HS-colored graph,  $\bar{X}_N(w)$  is just  $\tilde{X}_N(w)$  with colored vertices.

(iv) results from (iii):  $\frac{\frac{m}{d_i}}{\frac{o_N(w)}{o_{*i}(w)}} = \frac{m}{o_N(w)}$  if and only if  $o_{*i}(w) = d_i$ .

(v) results from (iii):  $\frac{\frac{m}{d_i}}{\frac{o_N(w)}{o_{*i}(w)}} = \frac{\frac{m}{d_j}}{\frac{o_N(w)}{o_{*j}(w)}}$  if and only if  $\frac{o_{*i}(w)}{d_i} = \frac{o_{*j}(w)}{d_j}$ .

(vi) Consider a  $j$ -th loop,  $1 \leq j \leq \frac{m}{o_N(w)}$ . If the fiber  $p^{-1}(H_{i_0} \alpha_{i_0})$  participates in this loop, then from (iii) it contributes  $\frac{o_N(w)}{o_{*i_0}(w)}$  elements. If  $\frac{o_N(w)}{o_{*i_0}(w)} = o_N(w)$ , that is  $o_{*i_0}(w) = 1$ , then Equation 6.1 holds trivially for

this loop. Since  $w \notin \bigcap_{i=1}^{i=s} \alpha_i^{-1} H_i \alpha_i$ , there is some  $1 \leq i_1 \leq s$  such that

$o_{*i_1}(w) > 1$  and there are loops with more than one participating fiber.

Assume the fiber  $p_w^{-1}(H_{i_1} \alpha_{i_1})$  participates in such a loop, then from (iii) it contributes  $\frac{o_N(w)}{o_{*i_1}(w)}$  elements colored in  $c_{i_1}$ . Next, another fiber,

$p_w^{-1}(H_{i_2} \alpha_{i_2})$ , participates and contributes  $\frac{o_N(w)}{o_{*i_2}(w)}$  elements colored in  $c_{i_2}$

(completely disjoint with the former). If  $\frac{o_N(w)}{o_{*i_1}(w)} + \frac{o_N(w)}{o_{*i_2}(w)} = o_N(w)$ , Equation 6.1 holds for this loop. Otherwise, if  $\frac{o_N(w)}{o_{*i_1}(w)} + \frac{o_N(w)}{o_{*i_2}(w)} < o_N(w)$ , then there is a fiber,  $p_w^{-1}(H_{i_3}\alpha_{i_3})$ , that participates and contributes  $\frac{o_N(w)}{o_{*i_3}(w)}$  elements colored in  $c_{i_3}$ . We repeat the process until all the  $o_N(w)$  vertices in this loop are counted and Equation 6.1 holds for this loop. Since the  $\frac{m}{o_N(w)}$  loops are disjoint, we do the process for each loop independently.  $\square$

**Proposition 6.2.** *Let  $w \in F_n \setminus \bigcap_{i=1}^{i=s} \alpha_i^{-1}H_i\alpha_i$ , with order  $o_N(w)$ . For each  $j$ -th loop,  $1 \leq j \leq \frac{m}{o_N(w)}$ , let  $Y_j = \{1 \leq i \leq s \mid p^{-1}(H_i\alpha_i) \text{ participates in the } j\text{-th loop}\}$ . Then, in  $\tilde{X}_N(w)$ , the following occurs:*

- (i) *The natural numbers  $\{o_{*i}(w) \mid i \in Y_j\}$  are not pairwise prime.*
- (ii)  *$o_{max,j} = \text{Max}\{o_{*i}(w) \mid i \in Y_j\}$  appears at least  $p$  times, where  $p$  is the smallest prime dividing  $o_{max,j}$ .*
- (iii) *Any  $o_{*l}(w)$  divides another  $o_{*k}(w)$ , for  $k, l \in Y_j$ .*
- (iv) *Any  $o_{*k}(w)$  that does not properly divide any other  $o_{*i}(w)$  appears at least twice, for  $i, k \in Y_j$ .*

*Proof.* We consider only loops with more than one participating fiber. From Lemma 6.1, any  $j$ -th loop is of length  $o_N(w)$  and satisfies the following three conditions:  $o_N(w) = \sum_{i \in Y_j} \frac{o_N(w)}{o_{*i}(w)}$ , each package of  $\frac{o_N(w)}{o_{*i}(w)}$  vertices are colored in color  $c_i$ ,  $i \in Y_j$ , and any two consecutive vertices colored in the same color  $c_i$  are at  $o_{*i}(w)$  distance. So, from Lemma 5.3, each such loop describes a coset partition of  $\mathbb{Z}$ ,  $\{o_{*i}(w)\mathbb{Z} + r_i\}_{i \in Y_j}$   $r_i \in \mathbb{Z}$ . (i), (ii), (iii), (iv) result then from the HS in  $\mathbb{Z}$  and are a transcription of (i), (ii), (iii), (iv) from Theorem 5.4 for a  $j$ -th loop.  $\square$

## 6.2 Main Results on the Herzog-Schönheim conjecture for free groups of finite rank

We prove the first Theorems that provide sufficient conditions for multiplicity in the coset partition of  $F_n$ .

**Theorem 6.3.** *Let  $F_n$  be the free group on  $n \geq 2$  generators. Let  $\{H_i\alpha_i\}_{i=1}^{i=s}$  be a coset partition of  $F_n$  with  $H_i < F_n$  of index  $d_i$ ,  $\alpha_i \in F_n$ ,  $1 \leq i \leq s$ , and  $1 < d_1 \leq \dots \leq d_s$ . Let  $\tilde{X}_i$  denote the Schreier graph of  $H_i$ ,*

$1 \leq i \leq s$ . For  $g \in F_n$ , let  $o_{*i}(g)$  denote the order of  $g$  relative to  $H_i\alpha_i$ ,  $1 \leq i \leq s$ . If there exists  $w \in F_n$  such that  $o_{*s}(w) = d_s$ , then the index  $d_s$  appears in the partition at least  $p$  times, where  $p$  is the smallest prime dividing  $d_s$ .

*Proof.* If there exists  $w \in F_n$  such that  $o_{*s}(w) = d_s$ , then  $o_{max}(w) = \text{Max}\{o_{*i}(w) \mid 1 \leq i \leq s\} = d_s$ . Furthermore, from Lemma 6.1(iv), the fiber  $p_w^{-1}(H_s\alpha_s)$  participates in all the loops. Consider any  $j$ -th loop. From Proposition 6.2,  $o_{max}(w)$  appears at least  $p$  times in this loop, where  $p$  is the smallest prime dividing  $o_{max}(w)$ . That is, there are at least  $1 \leq i_1, \dots, i_{p-1} \leq s-1$  such that  $o_{*i_1}(w) = \dots = o_{*i_{p-1}}(w) = o_{max} = d_s$ . But,  $o_{*i}(w) \leq d_i$ , so  $d_{i_1} = \dots = d_{i_{p-1}} = d_s$ .  $\square$

Note that if there exists  $w \in F_n$ , such that  $o_{*i}(w) = d_i$  for every  $1 \leq i \leq s$ , then multiplicities occur as in  $\mathbb{Z}$ . In particular, it ensures the existence of a partition of  $\mathbb{Z}$  with subgroups of indices  $d_1, \dots, d_s$ . For the partition of  $F_2$  in Example 5.2,  $o_{*1}(ab) = d_1 = 2$ ,  $o_{*2}(ab) = d_2 = o_{*3}(ab) = d_3 = 4$ . If  $H_s \triangleleft F_n$ , then there exists a  $d_s$ -cycle in  $T_s$  if and only if  $T_s \simeq \mathbb{Z}_{d_s}$ .

**Example 6.4.** Consider the partition of  $F_2$  given in Example 5.2. The subgroup of maximal index is  $K$  with index 4 (see Figure 2.3.1). For  $w = ab$ ,  $o_K(ab) = 4$  in  $\tilde{X}_K$  (see Figure 4.12.1), so Theorem 6.3(i) ensures the HS is satisfied and in this example the index 4 appears exactly twice.

We keep the same notation as in Theorem 6.3. For  $g \in F_n$ , let  $o_{max}(g) = \text{Max}\{o_{*i}(g) \mid 1 \leq i \leq s\}$ , and  $p$  be the smallest prime dividing  $o_{max}(g)$ . We define  $\# = |\{1 \leq i \leq s \mid o_{*i}(g) = o_{max}(g)\}|$ .

**Theorem 6.5.** Let  $F_n$  be the free group on  $n \geq 2$  generators. Let  $\{H_i\alpha_i\}_{i=1}^{i=s}$  be a coset partition of  $F_n$  with  $H_i \triangleleft F_n$  of index  $d_i$ ,  $\alpha_i \in F_n$ ,  $1 \leq i \leq s$ , and  $1 < d_1 \leq \dots \leq d_s$ . Let  $r \in \mathbb{Z}$ ,  $4 \leq r \leq s-1$ . If there exists  $w \in F_n$  that satisfies one of the following conditions:

- (i)  $o_{max}(w) > d_{s-2}$ .
- (ii)  $o_{max}(w) > d_{s-3}$ ,  $p \geq 3$ .
- (iii)  $o_{max}(w) > d_{s-3}$ ,  $p = 2$ , and  $\# \geq 4$ .
- (iv)  $o_{max}(w) > d_{s-3}$ ,  $p = 2$ , and  $\# = 2$ .
- (v)  $o_{max}(w) > d_{s-r}$ ,  $p \geq r$ .
- (vi)  $o_{max}(w) > d_{s-r}$ ,  $\# \geq r+1$ .

(vii)  $o_{max}(w) > d_{s-r}$ ,  $\# = p$ .

Then the coset partition  $\{H_i\alpha_i\}_{i=1}^{i=s}$  has multiplicity.

*Proof.* (i) Let  $k_w$  denote  $o_{max}(w)$ . If there exists  $w \in F_n$  with  $k_w > d_{s-2}$ , then either  $o_{*s}(w) = k_w$  or  $o_{*s-1}(w) = k_w$ . From Proposition 6.2,  $o_{max}(w)$  appears at least twice, so  $o_{*s}(w) = o_{*s-1}(w) = k_w$ . If  $k_w$  occurs exactly twice, then the fibers  $p_w^{-1}(H_s\alpha_s)$  and  $p_w^{-1}(H_{s-1}\alpha_{s-1})$  participate together in the same loops (otherwise there would be a repetition of  $k_w$  for an additional fiber). So, from Lemma 6.1(v),  $\frac{o_{*s}(w)}{d_s} = \frac{o_{*s-1}(w)}{d_{s-1}}$  implies  $d_{s-1} = d_s$ . If  $k_w$  occurs three times or more, then there is at least one additional fiber  $p_w^{-1}(H_i\alpha_i)$ , with  $o_{*i}(w) = k_w > d_{s-2}$  and  $o_{*i}(w) \leq d_i \leq d_{s-2}$ . So, the pigeonhole principle can be applied: there are two values of indices  $d_s$  and  $d_{s-1}$  to distribute to at least three fibers, that is  $d_i = d_s$  or  $d_i = d_{s-1}$ , and there is a repetition of one of the indices. (ii), (iii), (v), (vi) The proof relies on the pigeonhole principle as it was applied in the proof of (i). (iv), (vii) Whenever  $\# = p$ , there are  $p$  fibers that participate together in the same loops. So, Lemma 6.1(v) implies they have the same index.  $\square$

Theorem 1 and Theorem 2 from the introduction are computationally speaking far easier to check than Theorems 6.3 and 6.5. We show that in fact Theorems 1 and 2 are equivalent to Theorems 6.3 and 6.5 respectively. For that, we need the following lemma. In the following, we assume the permutations are decomposed into the product of disjoint cycles.

**Lemma 6.6.** *Let  $H < F_n$  be of finite index  $d$ . Let  $\tilde{X}_H$  be the Schreier graph of  $H$  with vertices  $\tilde{x}_0, \dots, \tilde{x}_{d-1}$ . Let  $T \leq S_d$  be the transition group of  $\tilde{X}_H$ . Then*

(i) *There exists a  $d$ -cycle in  $T$ , if and only if there exists  $w \in F_n$  such that  $o(w, j) = d$ , for some  $0 \leq j \leq d-1$ .*

(ii) *If there exists a permutation in  $T$  with a  $k$ -cycle at some  $\tilde{x}_j$ , then for every  $\tilde{x}_r$ , there exists a permutation in  $T$  with a  $k$ -cycle at  $\tilde{x}_r$ .*

*Proof.* (i) Let  $w \in F_n$ . Assume  $o(w, j) = d$ , for some  $0 \leq j \leq d-1$ . Then, from Lemma 4.7(i),  $o(w, j) = d$ , for all  $0 \leq j \leq d-1$ , that is  $w^d \in N_H$ , where  $N_H$  is the normal core of  $H$ . So,  $o(N_H w) = d$  in  $F_n / N_H \cong T$  with  $T \leq S_d$  and  $w$  acts as a  $d$ -cycle on the right cosets of  $H$ . Conversely, assume there is a  $d$ -cycle  $\phi$  in  $T$ . Let  $w \in F_n$  be any inverse image of  $\phi$ . Then  $o(w, j) = d$ , for all  $0 \leq j \leq d-1$ .

(ii) Assume first that  $\sigma \in T$  is a permutation with a  $k$ -cycle at  $\tilde{x}_0$ . Let  $g \in F_n$  be any inverse image of  $\sigma$ . Then there is a loop labelled  $g^k$  at  $\tilde{x}_0$ . Let  $w = t_r^{-1}gt_r$ , with  $t_r$  the label of a minimal path from  $\tilde{x}_0$  to  $\tilde{x}_r$ . Then there is a loop labelled  $w^k$  at  $\tilde{x}_r$  and in the corresponding permutation in  $T$  there is a  $k$ -cycle. The same proof applies for any  $\tilde{x}_j$ .  $\square$

*Proofs of Theorem 1 and Theorem 2 .* Using Lemma 6.6(i), Theorem 1 and Theorem 2 from the introduction are the transcription in terms of cycles of Theorems 6.3 and 6.5 respectively.  $\square$

## 7 The space of coset partitions of $F_n$

Let  $F_n$  be the free group on  $n \geq 2$  generators. We define  $Y'$  to be the space of coset partitions of  $F_n$  (only with subgroups of finite index). For each subgroup  $H$  of  $F_n$  of finite index  $d > 1$ , there exists a partition of  $F_n$  by the  $d$  cosets of  $H$ . Generally, if  $P \in Y'$ , then  $P = \{H_i\alpha_i\}_{i=1}^{i=s}$ , a coset partition of  $F_n$  with  $H_i < F_n$  of index  $d_i$ ,  $\alpha_i \in F_n$ ,  $1 \leq i \leq s$ , and  $1 < d_1 \leq \dots \leq d_s$ . To get some intuition on  $Y'$ , it is worth recalling that the subgroup growth of  $F_n$  is exponential.

### 7.1 Action of $F_n$ on the space of its coset partitions

There exists a natural right action of  $F_n$  on  $Y'$ . Indeed, if  $w \in F_n$ , then  $P \cdot w = P'$ , with  $P' = \{H_i\alpha_i w\}_{i=1}^{i=s}$  in  $Y'$ .

**Lemma 7.1.** *The natural right action of  $F_n$  on  $Y'$  is faithful*

*Proof.* Let  $w \in F_n$ . Then  $P \cdot w = P$  for every  $P \in Y'$  if and only if  $w$  belongs to the intersection of all the subgroups of finite index of  $F_n$ . As  $F_n$  is residually finite [38, p.158], the intersection of all the subgroups of finite index of  $F_n$  is trivial, so  $w = 1$ , that is the action is faithful.  $\square$

Let  $P = \{H_i\alpha_i\}_{i=1}^{i=s}$  in  $Y'$  and let  $\tilde{X}_i$  be the Schreier graph of  $H_i$ ,  $1 \leq i \leq s$ . Let  $w \in F_n$ . We denote by  $o_{*i}(w)$  the minimal natural number,  $1 \leq o_{*i}(w) \leq d_i$ , such that  $w^{o_{*i}(w)}$  is a loop at the vertex  $H_i\alpha_i$  in  $\tilde{X}_i$  or equivalently  $w^{o_{*i}(w)} \in \alpha_i^{-1}H_i\alpha_i$  (see Section 4.1).

**Lemma 7.2.** *Let  $P = \{H_i\alpha_i\}_{i=1}^{i=s}$  in  $Y'$ . Then  $|\text{Orb}_{F_n}(P)| \leq d_1 \dots d_s$ , where  $\text{Orb}_{F_n}(P)$  denotes the orbit of  $P$  under the action of  $F_n$ . Furthermore, for  $w \in F_n$ ,  $|\text{Orb}_w(P)| = \text{lcm}(o_{*1}(w), \dots, o_{*s}(w))$ , where  $\text{Orb}_w(P)$  denotes the orbit of  $P$  under the action of  $\langle w \rangle$ .*

*Proof.* From the definition of the action of  $F_n$  on  $P$ ,  $F_n$  permutes between the cosets of  $H_1$ , between the cosets of  $H_2$  and so on. So,  $|Orb_{F_n}(P)| \leq d_1 \dots d_s$ . The size of  $Orb_w(P)$  is equal to the minimal natural number such that  $P \cdot w^k = P$ , that is  $k = lcm(o_{*1}(w), \dots, o_{*s}(w))$ . Indeed,  $P \cdot w^k = P \Leftrightarrow w^k \in \bigcap_{i=1}^{i=s} \alpha_i^{-1} H_i \alpha_i \Leftrightarrow lcm(o_{*1}(w), \dots, o_{*s}(w))$  divides  $k$  (Lemma 4.10). As  $k = lcm(o_{*1}(w), \dots, o_{*s}(w))$  is minimal such that  $P \cdot w^k = P$ ,  $|Orb_w(P)| = lcm(o_{*1}(w), \dots, o_{*s}(w))$ .  $\square$

*Proof of Theorem 3.* (i), (ii) From the assumption, there exists  $w \in \bigcap_{i \neq j, k} \alpha_i^{-1} H_i \alpha_i$ ,  $w \notin \bigcap_{i=1}^{i=s} \alpha_i^{-1} H_i \alpha_i$ . Then  $P \cdot w = \{H_i \alpha_i w\}_{i=1}^{i=s}$  gives  $F_n = \bigcup_{i \neq j, k} H_i \alpha_i \cup H_j \alpha_j w \cup H_k \alpha_k w$ . So,  $H_j \alpha_j w \cup H_k \alpha_k w = H_j \alpha_j \cup H_k \alpha_k$ , with  $H_j \alpha_j w \neq H_j \alpha_j$  and  $H_k \alpha_k w \neq H_k \alpha_k$ . As  $H_j \alpha_j w \cap H_j \alpha_j = \emptyset$  and  $H_k \alpha_k w \cap H_k \alpha_k = \emptyset$ ,  $H_j \alpha_j w \subseteq H_k \alpha_k$  and  $H_k \alpha_k w \subseteq H_j \alpha_j$ . From  $H_j \alpha_j w \cup H_k \alpha_k w = H_j \alpha_j \cup H_k \alpha_k$  again, we have  $H_j \alpha_j w = H_k \alpha_k$  and  $H_j \alpha_j = H_k \alpha_k w$ , that is  $H_k \alpha_k w \alpha_j^{-1} = H_j$  a subgroup, so  $H_k \alpha_k w \alpha_j^{-1} = H_k$ , that is  $H_k = H_j$ . Furthermore,  $o_{*j}(w) = o_{*k}(w) = 2$ ,  $w^2 \in \bigcap_{i=1}^{i=s} \alpha_i^{-1} H_i \alpha_i$ .  $\square$

If the condition in Theorem 3 holds, then  $m, m_j, m_k$  are necessarily even.

**Example 7.3.** Consider another partition of  $F_2$ , with all the subgroups normal in  $F_2$ :  $F_2 = H_1 \cup H_2 a \cup H_3 ab$ , where  $H_1 = H = \langle b, a^2, aba \rangle$  and  $H_2 = H_3 = M$  with  $\tilde{X}_M$  described below:

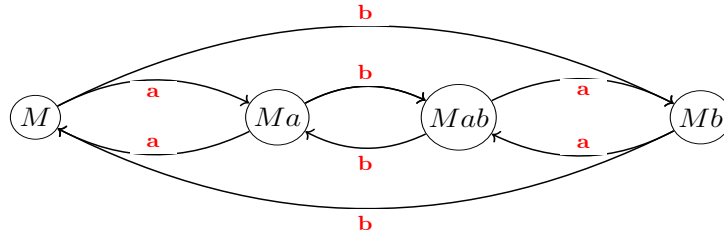

Figure 7.3.1:  $\tilde{X}_M$  for the normal subgroup  $M$  of index 4.

The subgroup of maximal index is  $M$  with index 4 (see Figure 7.3.1). The transition group  $T_M$  of  $\tilde{X}_M$  is isomorphic to  $\mathbb{Z}_2 \times \mathbb{Z}_2$ . So, there is no 4-cycle in  $T_M$ , no cycle of length greater than 2 ( $2 = d_1 = d_{s-2}$ ) neither,

and Theorem 1 cannot apply. Nevertheless, Theorem 3 applies. Indeed, the subgroup  $\bigcap_{i=1}^{i=3} H_i \subsetneq H_1$ , and this implies  $H_2 = H_3$ .

We recall that for each subgroup  $H$  of index  $d$  in  $F_n$  (or in any group), there is a transitive action of the group on the set of right cosets of  $H$ , that is given two cosets  $H\alpha$  and  $H\beta$  of  $H$ , there exists  $w$  such that  $H\alpha \cdot w = H\beta$ . So, the following question arises:

**Question.** Let  $P = \{H_i\alpha_i\}_{i=1}^{i=s}$  and  $P' = \{H_i\beta_i\}_{i=1}^{i=s}$  in  $Y'$ . Does there necessarily exist  $w \in F_n$  such that  $P' = P \cdot w$  ?

## 7.2 Topology in the space of coset partitions of $F_n$

We refer to [27] for more details. Let  $Y'$  be the space of coset partitions of  $F_n$ . Given  $P = \{H_i\alpha_i\}_{i=1}^{i=s}$  in  $Y'$ , with  $d_s \geq \dots \geq d_1 > 1$ , we identify  $P$  with the  $s$ -tuple  $(H_s, \dots, H_1)$  and we consider  $H_s$  at the first place,  $H_{s-1}$  at the second place and so on. Let  $P' \in Y'$ ,  $P' = \{K_i\beta_i\}_{i=1}^{i=t}$ . We define a function  $d : Y' \times Y' \rightarrow \mathbb{R}$  :

$$d(P, P') = \begin{cases} 2^{-k} & \text{if } k \text{ is the first place at which } K_i \neq H_i \\ 0 & \text{if } t = s; \quad H_i = K_i, \quad \forall 1 \leq i \leq s \end{cases}$$

The function  $d : Y' \times Y' \rightarrow \mathbb{R} \cup \{\infty\}$  is a *semi-metric* if for all  $P, P', P'' \in Y'$ ,  $d$  satisfies  $d(P, P') = d(P', P)$  (symmetry) and  $d(P, P'') \leq d(P, P') + d(P', P'')$  (triangle inequality). A standard argument shows:

**Lemma 7.4.** *The function  $d$  is a semi-metric.*

*Proof.* Let  $P, P', P'' \in Y'$ . Clearly,  $d(P, P') = d(P', P)$ . Assume  $d(P, P') = 2^{-k}$ ,  $d(P', P'') = 2^{-\ell}$ , and  $d(P, P'') = 2^{-m}$ . If  $k > 1$  or  $\ell > 1$ , then  $m = \min\{k, \ell\}$  and  $d(P, P'') = 2^{-(\min\{k, \ell\})} \leq 2^{-k} + 2^{-\ell}$ . If  $k = \ell = 1$ , then  $m \geq 1$  and  $d(P, P'') = 2^{-m} < 1$ . □

A *metric* is a semi-metric with the additional requirement that  $d(P, P') = 0$  implies  $P = P'$ . Identifying points with zero distance in a semi-metric  $d$  is an equivalence relation that leads to a metric  $\hat{d}$ . The function  $\hat{d}$  is then a metric in  $Y' / \equiv$ , with  $P \equiv P'$  if and only if  $d(P, P') = 0$ . If the answer to Question 7.1 is positive, then  $Y' / \equiv$  is the same as the quotient of  $Y'$  by the action of  $F_n$ . We denote  $Y' / \equiv$  by  $Y$  and  $\hat{d}$  by  $\rho$ .

We denote by  $B_r(P_0) = \{P \in Y \mid \rho(P, P_0) < 2^{-r}\}$ , the open ball of radius  $2^{-r}$  centered at  $P_0$ . A set  $U \subset Y$  is open if and only if for every point  $P \in U$ , there exists  $\epsilon > 0$  such that  $B_\epsilon(P) \subset U$ . A space  $Y$  is *totally disconnected* if every two distinct points of  $Y$  are contained in two disjoint open sets covering the space. A point  $P$  in a metric space  $Y$  is an *isolated point* of  $Y$  if there exists a real number  $\epsilon > 0$ , such that  $B_\epsilon(P) = \{P\}$ . If all the points in  $Y$  are isolated, then  $Y$  is *discrete*. The space  $Y$  is *(topologically) discrete* if  $Y$  is discrete as a topological space, that is the metric may be different from the discrete metric.

**Theorem 7.5.** *The metric space  $Y$  is (topologically) discrete.*

*Proof.* We show that all the points in  $Y$  are isolated. Let  $P = \{H_i \alpha_i\}_{i=1}^{i=s}$  in  $Y$ , with  $d_s \geq \dots \geq d_1 > 1$ . Then for  $\epsilon < 2^{-(s+1)}$ ,  $B_\epsilon(P) = \{P\}$ .  $\square$

This implies that  $Y$  is Hausdorff, bounded and totally disconnected, facts that could be easily proved directly using  $\rho$ . A metric space  $X$  is *uniformly discrete*, if there exists  $\epsilon > 0$  such that for any  $x, x' \in X$ ,  $x \neq x'$ ,  $\rho(x, x') > \epsilon$ . The space  $Y$  is not uniformly discrete.

*Remark 7.6.* Given an arbitrary group  $G$ , one can define in the same way the space  $Y$ , the metric  $\rho$  and obtain the same topological properties. The action of  $G$  on  $Y$  can also be defined in the same way, but it is not necessarily faithful anymore.

*Proof of Theorem 5.* Let  $P_0 = \{H_i \alpha_i\}_{i=1}^{i=s}$ , with  $1 < d_{H_1} \leq \dots \leq d_{H_s}$ . Let  $P \in Y$ ,  $P = \{K_i \beta_i\}_{i=1}^{i=t}$ , with  $1 < d_{K_1} \leq \dots \leq d_{K_t}$ .

(i) If  $\rho(P, P_0) < \frac{1}{2}$ , then  $K_t = H_s$ . So, if there exists a  $d_s$ -cycle in  $T_{H_s}$ , the index  $d_s$  appears in  $P_0$  and in  $P$  at least  $p$  times, where  $p$  is the least prime dividing  $d_s$ . Note that this implies necessarily  $\rho(P, P_0) \leq 2^{-p-1}$ .

(ii), (iii) If  $\rho(P, P_0) < 2^{-(r+1)}$ ,  $2 \leq r \leq s-1$ , then  $K_t = H_s$ ,

$K_{t-1} = H_{s-1}, \dots, K_{t-r} = H_{s-r}$ . If  $k$ , the maximal length of a cycle in

$\bigcup_{i=1}^{i=s} T_{H_i}$ , satisfies  $k > d_{H_{s-r}}$ , then  $k > d_{K_{t-r}}$  also. Furthermore,  $k$  occurs in

$\bigcup_{i=s-r}^{i=s} T_{H_i}$  and also in  $\bigcup_{j=t-r}^{j=t} T_{K_j}$ , since  $\bigcup_{i=s-r}^{i=s} T_{H_i} = \bigcup_{j=t-r}^{j=t} T_{K_j}$ . If  $P_0$  satisfies

condition (i) or (ii) of Theorem 2, then  $P$  satisfies the same condition and hence has multiplicity.

If  $P_0$  satisfies condition (iii) or (iv) of Theorem 2, then  $P_0$  has multiplicity, with  $d_{H_{s-i}} = d_{H_{s-j}}$  for some  $i \neq j$ ,  $0 \leq i, j \leq r$ . So,  $d_{K_{t-i}} = d_{K_{t-j}}$  also, that is  $P$  has multiplicity.  $\square$



To conclude, we ask the following natural question: does there exist a metric on the space of coset partitions  $Y'$  that induces a non-discrete topology and yet can give rise to a result of the form of Theorem 4 ?

## 8 The Herzog-Schönheim conjecture for any finitely generated group

Let  $G$  be the group with presentation  $\langle X \mid R \rangle$ , with  $|X| = n$ . So,  $G \simeq F_n / K$ , with the normal closure of the set  $R$  (not necessarily finite) equal to  $K$ . There exists the canonical epimorphism  $\pi : F_n \rightarrow G$ . We show that this partition of  $G$  induces a partition of  $F_n$  with subgroups of the same indices.

**Lemma 8.1.** *Let  $G \simeq F_n / K$ , with canonical epimorphism  $\pi : F_n \rightarrow G$ . Let  $\{K_i g_i\}_{i=1}^{i=s}$  be a coset partition of  $G$  with  $K_i < G$  of index  $d_i > 1$ ,  $g_i \in G$ ,  $1 \leq i \leq s$ . Let  $H_i = \pi^{-1}(K_i)$  and  $\alpha_i = \pi^{-1}(g_i)$ . Then  $\{H_i \alpha_i\}_{i=1}^{i=s}$  is a coset partition of  $F_n$ , with  $H_i < F_n$  of index  $d_i$ ,  $\alpha_i \in F_n$ ,  $1 \leq i \leq s$ .*

*Proof.* From the third isomorphism theorem, there is a one-to-one correspondence between the subgroups of  $G$  and the subgroups of  $F_n$  containing  $\text{Ker}(\pi) = K$ . We set  $H_i = \pi^{-1}(K_i)$ , so  $H_i$  are subgroups of  $F_n$  of index  $d_i$  containing  $K$ . Let  $\alpha_i = \pi^{-1}(g_i)$ , that is  $\alpha_i$  are words in  $F_n$  representing the elements  $g_i \in G$ , in particular we can choose the words  $g_i$ . We show  $\{H_i \alpha_i\}_{i=1}^{i=s}$  is a coset partition of  $F_n$ . First, assume by

contradiction that  $\bigcup_{i=1}^{i=s} H_i \alpha_i \subsetneq F_n$ . So, there exists  $w \in F_n$  such that

$w \notin \bigcup_{i=1}^{i=s} H_i \alpha_i$ . The element  $\pi(w) = Kw \in G$ , so there exists  $1 \leq j \leq s$  such

that  $Kw \in K_j g_j$ . Since  $K_j g_j = (H_j / K) \alpha_j$ , there exists  $h_j \in H_j$ , such that  $Kw = Kh_j \alpha_j$ , that is  $w \in Kh_j \alpha_j$ . As  $K \subset H_j$ ,  $w \in H_j \alpha_j$ . So, a

contradiction, that is  $\bigcup_{i=1}^{i=s} H_i \alpha_i = F_n$ . Next, we show that the cosets  $H_i \alpha_i$ ,

$1 \leq i \leq s$ , are disjoint. Assume by contradiction that there is

$w \in H_i \alpha_i \cap H_j \alpha_j$ ,  $i \neq j$ . So, there exist  $h_j \in H_j$ , and  $h_i \in H_i$ , such that

$w = h_j \alpha_j = h_i \alpha_i$ , and  $Kw = Kh_j \alpha_j = Kh_i \alpha_i$ , with

$Kh_j \alpha_j \in (H_j / K) \alpha_j = K_j g_j$  and  $Kh_i \alpha_i \in (H_i / K) \alpha_i = K_i g_i$ . So, a

contradiction, that is the cosets  $H_i \alpha_i$ ,  $1 \leq i \leq s$ , are disjoint.  $\square$

*Proof of Theorem 6.* If one of the conditions from Theorem 1, 2, or 3 is satisfied, then in the induced partition  $\{H_i \alpha_i\}_{i=1}^{i=s}$ , with  $H_i$  subgroups of  $F_n$

of index  $d_i$ , there exists an index  $d_j$  that appears at least twice, and this is also true for the partition of  $G$ .  $\square$

Note that whenever the coset partition  $\{H_i\alpha_i\}_{i=1}^{i=s}$  has multiplicity, with  $d_i = d_j$  say, then  $H_i$  and  $H_j$  are isomorphic. This does not hold necessarily for any finitely generated group  $G$ . Indeed, if the isomorphism  $\varphi_{ij}$  between any pair of isomorphic subgroups  $H_i$  and  $H_j$  satisfies  $\varphi_{ij}(Ker(\pi)) = Ker(\pi)$ , then the corresponding subgroups  $K_i$  and  $K_j$  are also isomorphic.

## References

- [1] G.Baumslag, *Topics in Combinatorial Group Theory*, Lectures in Mathematics ETH Zurich, Birkhauser Verlag, Basel, 1993.
- [2] M.A. Berger, A. Felzenbaum, A.S. Fraenkel, *Improvements to two results concerning systems of residue sets*, Ars. Combin. **20** (1985), 69-82.
- [3] M.A. Berger, A. Felzenbaum, A.S. Fraenkel, *The Herzog-Schönheim conjecture for finite nilpotent groups*, Canad. Math. Bull. **29**(1986),329-333.
- [4] M.A. Berger, A. Felzenbaum, A.S. Fraenkel, *Lattice parallelotopes and disjoint covering systems*, Discrete Math. **65** (1987), 23-44.
- [5] M.A. Berger, A. Felzenbaum, A.S. Fraenkel, *Remark on the multiplicity of a partition of a group into cosets*, Fund. Math. **128** (1987), 139-144.
- [6] M.A. Brodie, R.F. Chamberlain, L.C Kappe, *Finite coverings by normal subgroups*, Proc. Amer. Math. Soc. **104** (1988), 669-674.
- [7] W.Dicks, *Simplified Mineyev*, <http://mat.uab.es/~dicks/SimplifiedMineyev.pdf>.
- [8] J. D. Dixon, *The probability of generating the symmetric group*, Math. Z. **110** (1969), 199-205.
- [9] D.B.A. Epstein, J.W. Cannon, D.F. Holt, S.V.F. Levy, M.S. Paterson, W.P. Thurston, *Word Processing in Groups*, Jones and Bartlett Publishers (1992).

- [10] P. Erdős, *On integers of the form  $2^k + p$  and some related problems*, Summa Brasil. Math. **2** (1950), 113-123.
- [11] P. Erdős, *Problems and results in Number theory*, Recent Progress in Analytic Number Theory, vol. 1, Academic Press, London-New York, 1981, 1-13.
- [12] J. Friedman, *Sheaves on graphs, their homological invariants, and a proof of the Hanna Neumann conjecture: with an appendix by Warren Dicks*, Mem. Amer. Math. Soc. **233** (2015).
- [13] R. Geoghegan, *Topological Methods in Group Theory*, Graduate Texts in Mathematics **243**, Springer-Verlag, Berlin, Heidelberg, New York (2008).
- [14] S.M. Gersten, *Intersections of finitely generated subgroups of free groups and resolutions of graphs*, Invent. Math. **71** (1983), 567-591.
- [15] , Y. Ginosar, *Tile the group*, Elem. Math. **72**, Swiss Math. Society, to appear.
- [16] Y. Ginosar, O. Schnabel, *Prime factorization conditions providing multiplicities in coset partitions of groups*, J. Comb. Number Theory, **3** (2011), n.2, 75-86.
- [17] J.L. Gross, J. Yellen, *Graph Theory and its applications*, Discrete Mathematics and its Applications (2006).
- [18] A. Hatcher, *Algebraic Topology*, Cambridge University Press (2002).
- [19] M. Herzog, J. Schönheim, *Research problem no. 9*, Canad. Math. Bull., **17** (1974), 150.
- [20] S.V. Ivanov, P.E. Schupp, *A remark on finitely generated subgroups of free groups*, Algorithmic Problems in Groups and Semigroups, Birkhauser 2000, 139-142.
- [21] I. Korec, Š. Znám, *On disjoint covering of groups by their cosets*, Math. Slovaca, **27** (1977), 3-7.
- [22] T. Lam, K. Leung, *On vanishing sums of roots of unity*, J. Algebra **224** (2000), n.1, 91-109.

- [23] R.C. Lyndon, P.E. Schupp, *Combinatorial Group Theory*, Ergebnisse der Mathematik und ihrer Grenzgebiete **89**, Springer-Verlag, Berlin, Heidelberg, New York (1977).
- [24] W. Magnus, A. Karrass, D. Solitar, *Combinatorial Group Theory*, Dover Publications, New York (1976).
- [25] L. Margolis, O. Schnabel, *The Herzog-Schönheim conjecture for small groups and harmonic subgroups*, ArXiv 1803.03569.
- [26] I. Mineyev, *Submultiplicativity and the Hanna Neumann Conjecture*, Annals of Math. **175** (2012), 393-414.
- [27] J. Munkres, *Topology*, Pearson Modern Classics for Advanced Mathematics Series, 2000.
- [28] P. Nickolas, *Intersections of finitely generated free groups*, Bull. Austral. Math. Soc. **31** (1985), 339-348.
- [29] S. Nieveen, A. Smith, *Covering spaces and Subgroups of Free groups*, Adviser Dennis Garity, Oregon State University.
- [30] M. Newman, *Roots of unity and covering sets*, Math. Ann. **191** (1971), 279-282.
- [31] B. Novák, Š. ZnáM, *Disjoint covering systems*, Amer. Math. Monthly, **81** (1974), 42-45.
- [32] J.E. Pin, *On reversible automata*, Lecture Notes in Computer Science **583**, Springer 1992, p. 401-416.
- [33] J.E. Pin, *Mathematical foundations of automata theory*, <https://www.irif.fr/~jep/PDF/MPRI/MPRI.pdf>
- [34] Š. Porubský, *Natural exactly covering systems of congruences*, Czechoslovak Math. J. **24** (1974), 598-606.
- [35] Š. Porubský, *Covering systems and generating functions*, Acta Arith. **26** (1975), n.3, 223-231.
- [36] Š. Porubský, *Results and problems on covering systems of residue classes*, Mitt. Math. Sem. Giessen, **150** (1981).
- [37] Š. Porubský, J. Schönheim, *Covering systems of Paul Erdős. Past, present and future. Paul Erdős and his mathematics*, János Bolyai Math. Soc., **11** (2002), 581-627.

- [38] D.J.S. Robinson, *A Course in the Theory of Groups*, Graduate Texts in Mathematics **80**, Springer-Verlag, Berlin, Heidelberg, New York (1980).
- [39] J.J. Rotman, *An Introduction to Algebraic Topology*, Graduate Texts in Mathematics **119**, Springer-Verlag, Berlin, Heidelberg, New York (1988).
- [40] J.P. Serre, *Arbres, Amalgames  $SL_2$* , Astérisque **46**, Société Math. de France (1977).
- [41] A. Sikora, *Topology on the spaces of orderings of groups*, Bull. London Math. Soc. **36** (2004), 519-526.
- [42] C.C. Sims, *Computation with finitely presented groups*, Encyclopedia of Mathematics and its Applications **48**, Cambridge University Press (1994).
- [43] J.R. Stallings, *Topology of finite graphs*, Invent. Math. **71** (1983), 551-565.
- [44] J. Stillwell, *Classical Topology and Combinatorial Group Theory*, Graduate Texts in Mathematics **72**, Springer-Verlag, Berlin, Heidelberg, New York (1980).
- [45] Z.W. Sun, *Finite covers of groups by cosets or subgroups*, Internat. J. Math. **17** (2006), n.9, 1047-1064.
- [46] Z.W. Sun, *An improvement of the Zná-m-Newman result*, Chinese Quart. J. Math. **6** (1991), n.3, 90-96.
- [47] Z.W. Sun, *Covering the integers by arithmetic sequences II* Trans. Amer. Math. Soc. **348** (1996), 4279-4320.
- [48] Z.W. Sun, *Classified publications on covering systems*, <http://math.nju.edu.cn/zwsun/Cref.pdf>.
- [49] G. Tardos, *On the intersection of subgroups of a free group*, Invent. Math. **108** (1992), 29-36.
- [50] M.J. Tomkinson, *Groups covered by abelian subgroups*, London Math. Soc. Lecture Note Ser. **121**, Cambridge Univ. Press (1986).
- [51] M.J. Tomkinson, *Groups covered by finitely many cosets or subgroups*, Comm. Algebra **15**(1987), 845-859.

Fabienne Chouraqui,  
University of Haifa at Oranim, Israel. E-mail:  
fabienne.chouraqui@gmail.com fchoura@sci.haifa.ac.il