

REAL AND COMPLEX MULTIPLICATION ON $K3$ SURFACES VIA PERIOD INTEGRATION

ANDREAS-STEPHAN ELSENHANS AND JÖRG JAHNEL

ABSTRACT. We report on a new approach, as well as some related experiments, to construct families of $K3$ surfaces having real or complex multiplication. The approach is based on an explicit description of the transcendental part of the cohomology in a topological way, using topological tori. Fundamental ideas include considering the period space of marked $K3$ surfaces, determining the periods by numerical integration, as well as tracing the modular curve by a numerical continuation method.

1. INTRODUCTION

The endomorphism algebra of an elliptic curve X over \mathbb{C} is isomorphic either to \mathbb{Z} or to an order in an imaginary quadratic field. The latter phenomenon is called complex multiplication. The theory of CM elliptic curves is very rich, cf. [Si, Chapter II] or [Co, Chapter 3], and their construction in an analytic setting is classical. The whole theory generalises to higher dimensions, most obviously to abelian varieties. There are, however, natural generalisations of elliptic curves, other than abelian varieties. One such kind is provided by the surfaces of type $K3$. Indeed, elliptic curves may be characterised as being the curves with trivial canonical class, a property shared by $K3$ surfaces.

Since $K3$ surfaces do not carry a natural group structure, the endomorphism algebra needs to be defined cohomologically. For X a $K3$ surface, $H := H^2(X, \mathbb{Q})$ is a pure weight-2 Hodge structure of dimension 22, being the direct sum of the image of $\text{Pic } X \otimes_{\mathbb{Z}} \mathbb{Q}$ under the Chern class homomorphism and its orthogonal complement T , the *transcendental part* of H . The endomorphism algebra $\text{End}_{\text{Hodge}}(T)$ in the category of pure weight-2 Hodge structures is either \mathbb{Q} , or a totally real number field, or a CM field [Za, Theorem 1.6.a)], cf. Proposition 6.5.i). If $E \cong \mathbb{Q}$ is totally real then X is said to have *real multiplication (RM)*. If E is CM then one speaks of *complex multiplication (CM)*.

For example, the Kummer surface $X := \text{Kum}(E_1 \times E_2)$ attached to the product of two elliptic curves has complex multiplication if one of the elliptic curves has. In this case, CM is actually caused by an endomorphism of X . In 6.17 to 6.20, we give examples of $K3$ surfaces of lower Picard ranks having CM even due to an automorphism.

Date: October 24, 2021.

2010 Mathematics Subject Classification. 14J28; Secondary 14J15, 14F25, 65D30, 65D10.

Key words and phrases. $K3$ surface, real multiplication, complex multiplication, periods, numerical integration, curve tracing, numerical continuation.

On the other hand, a Kummer surface does *not* inherit real multiplication from the underlying abelian surface [EJ14, Remark 3.5.ii)]. Nonetheless, the existence of $K3$ surfaces having real multiplication has been established for quite some time by analytic, i.e. Hodge-theoretic, means. It is known, for instance, that $K3$ surfaces having RM by E exist for every real quadratic field E . The same is true for every cubic field that is totally real. Note though that these methods do not provide explicit equations for the surfaces found to exist. Cf. the work [vG] of B. van Geemen, in particular [vG, Proposition 3.3].

Dimensions of the RM and CM loci. Theorem 6.29 is similar in spirit to van Geemen's result. It covers, however, the CM case, too, and provides exact formulae for the dimensions of the RM and CM loci in period space. These loci are, strictly speaking, not even closed sets. The reason is that there is a semicontinuity phenomenon. If the general fibre of a family has RM or CM by a field K then each special fibre has RM or CM by a field containing K . Cf. Corollary 6.30.

Our terminology concerning RM/CM. In order to cope with that situation, we use a particular terminology. If $\text{End}_{\text{Hodge}}(T) \supseteq K$ then we say that the transcendental part $T \subset H^2(X, \mathbb{Q})$ is *acted upon* by K . Thus, if T is acted upon by $K \not\supseteq \mathbb{Q}$ then X has RM or CM by a field that contains K .

Semicontinuity of $\text{End}_{\text{Hodge}}(T)$ in families. Semicontinuity may thus be formulated as follows. If the general fibre of a family $q: \mathfrak{X} \rightarrow Y$ of complex $K3$ surfaces has RM or CM by a field K then, for every special fibre \mathfrak{X}_t , the transcendental part $T_t \subset H^2(\mathfrak{X}_t, \mathbb{Q})$ is acted upon by K . Moreover, as Corollary 6.30 shows, there is a countable union $V \subset Y$ of analytic subsets such that \mathfrak{X}_t actually has RM or CM by K if and only if $t \in Y \setminus V$.

Periods. By a marked $K3$ surface, we mean a complex $K3$ surface X together with an isomorphism $i: \mathbb{Z}^{22} \rightarrow H^2(X, \mathbb{Z})$, i.e. equipped with a distinguished basis (c^1, \dots, c^{22}) of $H^2(X, \mathbb{Z})$. A marked $K3$ surface (X, i) gives rise to the *period point*

$$\Pi_{X,i} := ((c^1, [\omega]) : \dots : (c^{22}, [\omega])) \in \mathbf{P}^{21}(\mathbb{C}).$$

Here, $[\omega] \in H^2(X, \mathbb{C})$ denotes the class of a nowhere vanishing holomorphic $(2, 0)$ -form. The form ω is unique up to a constant factor $\lambda \in \mathbb{C}^*$. Having chosen a particular such form, one may consider the *period vector* $((c^1, [\omega]), \dots, (c^{22}, [\omega])) \in \mathbb{C}^{22}$, which is usually denoted by $\Pi_{X,i}$, as well. The marking i is often suppressed from the notation, when there seems to be no danger of confusion. The coordinates of the period vector are usually referred to as *periods*.

Moreover, a marking $i: \mathbb{Z}^{22} \rightarrow H^2(X, \mathbb{Z}), e_k \mapsto c^k$, induces a perfect symmetric bilinear pairing on \mathbb{Z}^{22} , the pull-back of the cup product pairing. On the other hand, let such a symmetric bilinear pairing κ be given on \mathbb{Z}^{22} . Then a classical result (cf. [Sh, Chapter IX]) states that the period points of all marked $K3$ surfaces that induce κ on \mathbb{Z}^{22} form a (possibly void) open subset Ω_κ of the quadric Q_κ in $\mathbf{P}^{21}(\mathbb{C})$, defined by κ .

RM in the situation of Picard rank 16. In a sufficiently general family $q: \mathfrak{X} \rightarrow Y$ of $K3$ surfaces that is generically of geometric Picard rank 16, and not containing an isotrivial subfamily, the surfaces that are acted upon by a *real* quadratic field form families over base curves $C \subset Y$. For arbitrary Picard rank, number fields of larger degree, or CM instead of RM, the dimensions of the base varieties occurring are known, too. Cf. Theorem 6.29, shown below.

In coincidence with this, several explicit 1-dimensional families of RM surfaces, but also isolated examples, have been found. There are two families, for which RM by $\mathbb{Q}(\sqrt{2})$ and $\mathbb{Q}(\sqrt{5})$, respectively, is proven. Cf. Examples 6.22 and 6.24 or [EJ20]. For conjectural examples, we refer to [EJ16, Conjectures 5.2], cf. Remarks 6.26.

On the side of the period space, the geometry of the corresponding base curves $\Pi(C) \subset \mathbf{P}^{21}(\mathbb{C})$ is very simple. Concretely, the restricted period space $\Omega_{\kappa,16} \subset \Omega_{\kappa}$, taking into account the fact that a fixed 16-dimensional subspace of $H^2(X, \mathbb{Q})$ is contained in the algebraic part, is an open subset of a quadric in $\mathbf{P}^5(\mathbb{C}) \subset \mathbf{P}^{21}(\mathbb{C})$. And $\Pi(C) \subset \mathbf{P}^5(\mathbb{C})$ is just the intersection of $\Omega_{\kappa,16}$ with a projective subspace of codimension 3.

Explicit construction of tori representing transcendental cohomology classes. Unfortunately, the period map $\Pi: Y \rightarrow \Omega_{\kappa,16}$ is not too explicit. In order to deal with this problem, in Section 4, we describe a particular family of $K3$ surfaces, which is the one we work with.

For the surfaces in this family, we give a topological construction of *topological tori*, representing a generating system of the transcendental part of the cohomology. I.e., of continuous mappings $\alpha: T^2 \rightarrow X$, for T^2 the 2-dimensional torus. This construction is fundamental to the whole approach.

Caution 1.1. In what follows, we just write *torus* to mean a topological torus. The reader should, however, keep in mind that α needs not even to be injective.

The tori we construct are not just continuous, but almost C^1 , cf. Definition 8.1. This gives us a link to the de Rham cohomology theory, so that the coordinates $(c_k, [\omega])$ of the period vector turn out to be improper integrals, cf. Theorem 4.16. This makes it possible to compute, for a single point $t \in Y$, i.e. a single surface $X = \mathfrak{X}_t$, the period point $\Pi(t) = \Pi_{\mathfrak{X}_t}$ by numerical integration. In addition, the directional derivatives of Π at t may be calculated.

We describe the construction of the tori in the course of Section 4. The technical details are treated in the final section.

Remark 1.2. There is a completely different approach to the calculation of periods, due to E.C. Sertöz [Ser]. Sertöz's method is based on an understanding of the periods under deformation. I.e., he computes the directional derivatives of Π exactly, something we do not do, and derives a partial differential equation for Π from the outcome. This works for nonsingular hypersurfaces, which includes $K3$ surfaces of degree 4, while our method is, at least at this moment, limited to double covers

of \mathbf{P}^2 , ramified in a union of six lines. Thus, a fair comparison seems to be difficult to undertake.

The base curve C parametrising RM surfaces–Numerical continuation. Given an isolated example as mentioned above, numerical continuation methods (cf. [AG]) may apply in order to extend to example to a 1-dimensional family. One determines a list of further surfaces in the same family, the period points of which lie on $\Pi(C)$ at high precision. Then, using numerical linear algebra (in particular the singular value decomposition), one can recover algebraic equations with small coefficients defining a curve that numerically contains the parameters of the surfaces found.

This approach should work rather generally. We illustrate it at one particular example, which is a 1-dimensional family of $K3$ surfaces of degree 2, for which we report strong evidence for real multiplication by $\mathbb{Q}(\sqrt{13})$. The generic geometric Picard rank is 16. Cf. Example 6.27 for the isolated example that was known to us before and Example 7.3 the 1-dimensional family found.

Notation. We follow standard mathematical conventions and use standard notation. In particular,

- The standard basis of the free R -module R^n is denoted by (e_1, \dots, e_n) .
- When $f: M \rightarrow \mathbb{R}^n$ is a map from a set M to \mathbb{R}^n , we denote by f_1, \dots, f_n the components of f . I.e., $f = (f_1, \dots, f_n)$.
- When K is a field, we identify $K = \mathbf{A}^1(K)$ with a subset of $\mathbf{P}^1(K)$, according to the embedding $K \rightarrow \mathbf{P}^1(K)$, $x \mapsto (1 : x)$. Moreover, we let $\infty := (0 : 1)$.
- For positive integers $m < n$, we denote by $\mathbf{P}^m(\mathbb{C}) \subset \mathbf{P}^n(\mathbb{C})$ the particular m -dimensional projective subspace $\{(x_0 : \dots : x_n) \in \mathbf{P}^n(\mathbb{C}) \mid x_{m+1} = \dots = x_n = 0\}$ of $\mathbf{P}^n(\mathbb{C})$.
- For l_1, \dots, l_r global sections of an invertible sheaf $\mathcal{L} \in \text{Pic } X$ on a scheme X , we let $V(l_1, \dots, l_r)$ be the common vanishing locus of l_1, \dots, l_r .
- When $f: S \rightarrow X$ is a continuous map between topological spaces, we denote by $f^*: H^i(X, \mathbb{Z}) \rightarrow H^i(S, \mathbb{Z})$ the induced homomorphism in cohomology and by $f_*: H_i(S, \mathbb{Z}) \rightarrow H_i(X, \mathbb{Z})$ that in homology. Moreover, as in [Sp, Chapter 1], we use the notation $f_\#: \pi_1(S, \cdot) \rightarrow \pi_1(X, \cdot)$ for the induced homomorphism between the fundamental groups.
- When $f: S \rightarrow X$ is a continuous map between equidimensional, oriented, compact manifolds, we let $f_!: H^i(S, \mathbb{Z}) \rightarrow H^{i+\dim X - \dim S}(X, \mathbb{Z})$ denote the (cohomological) transfer map. For a definition, cf. [Dd, Chapter VIII, Definition 10.5].
- By a manifold, we always mean a smooth (i.e. C^∞) manifold.
- When X is a complex $K3$ surface, we usually identify the Picard group $\text{Pic } X$ with its image in $H^2(X, \mathbb{Z})$, under the Chern class homomorphism.

Computations. All computations are done with `magma` [BCP] on one core of an Intel i7-7700 processor running at 3.6 GHz.

2. $K3$ SURFACES

The algebraic setting. Let k be an algebraically closed field. Then $K3$ surfaces form one of the types of surfaces over k , according to the Enriques–Kodaira classification of surfaces [CE, Sh]. This classification is due to the Italian school of Algebraic Geometry, cf. [CE, Sev], and today called the Enriques–Kodaira classification. More recent treatments are given in [Sh], [Be], and [BHPV]. By a *surface*, here, one means a 2-dimensional, connected, regular scheme that is projective over k .

More concretely, $K3$ surfaces form one of the four types of surfaces of Kodaira dimension 0 and, among them, one of the two types of surfaces having trivial canonical class. The other such type are abelian surfaces. A surface X is characterised ([Be, Theorem VIII.2] and [BHPV, Corollary VIII.8.6]) to be $K3$ by the properties that

i) $K_X \cong \mathcal{O}_X$ and

ii) $\pi_1^{\text{ét}}(X, \cdot) = 0$.

Moreover, $H_{\text{ét}}^2(X, \mathbb{Z}_l)$ is free of rank 22 and, of course, $H_{\text{ét}}^4(X, \mathbb{Z}_l) \cong H_{\text{ét}}^0(X, \mathbb{Z}_l) \cong \mathbb{Z}_l$ as well as $H_{\text{ét}}^3(X, \mathbb{Z}_l) \cong H_{\text{ét}}^1(X, \mathbb{Z}_l) = 0$ [under the assumption that $l \neq \text{char } k$].

Remarks 2.1. a) The degree of a $K3$ surface embedded in ordinary projective space is automatically even. There are examples in every even degree $d \geq 4$ [Be, Proposition VIII.15].

i) Smooth quartics in \mathbf{P}^3 are $K3$ surfaces of degree 4.

ii) Smooth complete intersections of a quadric and a cubic in \mathbf{P}^4 are $K3$ surfaces of degree 6.

iii) Smooth complete intersections of three quadrics in \mathbf{P}^5 are $K3$ surfaces of degree 8.

b) Similarly, double covers of \mathbf{P}^2 ramified in a smooth sextic curve are $K3$ surfaces of degree 2.

c) In each of the cases mentioned in a) and b), isolated singular points may be allowed, as long as all of them are of type ADE [Do, Section 8.2.7]. Then a $K3$ surface is obtained as the minimal desingularisation of the surface described.

The setting of complex manifolds. There is a theory, parallel to the classification just mentioned, for complex surfaces. I.e., for 2-dimensional compact complex manifolds. In this setting, a $K3$ *surface* is a complex surface such that

i) there is a global holomorphic $(2, 0)$ -form $\omega \in \Omega^{2,0}(X)$ without zeros (or poles), and

ii) $\pi_1(X, \cdot) = 0$.

A complex $K3$ surface is automatically a Kähler manifold [BHPV, Theorem IV.3.1]. In general, however, it is *not* projective so that this theory does not exactly mirror the algebraic theory of $K3$ surfaces in the case that $k = \mathbb{C}$, but is more general.

All $K3$ surfaces X are mutually diffeomorphic [BHPV, Corollary VIII.8.6]. Moreover, $H^2(X, \mathbb{Z})$ is free of rank 22 and, of course, $H^4(X, \mathbb{Z}) \cong H^0(X, \mathbb{Z}) \cong \mathbb{Z}$ as well as $H^3(X, \mathbb{Z}) \cong H^1(X, \mathbb{Z}) = 0$. Consequently, $H_2(X, \mathbb{Z}) \cong \mathbb{Z}^{22}$, too.

3. THE PERIOD SPACE

Explicit cohomology classes. A complex $K3$ surface X has a natural orientation, defined by the complex structure. Consider a compact, oriented 2-manifold S , together with a continuous map $\alpha: S \rightarrow X$. Then α defines a cohomology class

$$c_\alpha := \alpha_!(1) \in H^2(X, \mathbb{Z}),$$

for $1 \in H^0(S, \mathbb{Z})$ the canonical generator.

Definition 3.1. We call the class $c_\alpha \in H^2(X, \mathbb{Z})$ the *cohomology class given by S , together with the continuous map $\alpha: S \rightarrow X$* .

Remark 3.2. The class $c_\alpha \in H^2(X, \mathbb{Z})$ is the same as the Poincaré dual of the homology class of the image of S in X . Cf. Lemma 3.4.b), below.

Remarks 3.3. i) Note that the continuous map $\alpha: S \rightarrow X$ might be the embedding of a divisor, the embedding of a non-holomorphic submanifold, or not even an embedding.

ii) In the particular case that $i_D: D \rightarrow X$ is the embedding of a divisor, we prefer the more classical notation $[D] := c_{i_D} \in H^2(X, \mathbb{Z})$.

Lemma 3.4 (Cohomology versus homology).

a) *There is the canonical isomorphism*

$$\iota: H^2(X, \mathbb{Z}) \rightarrow H_2(X, \mathbb{Z}), \quad u \mapsto u \cap z_X,$$

for $z_X \in H_4(X, \mathbb{Z})$ the fundamental class.

b) *Let $\alpha: S \rightarrow X$ be as above. Then, for $u \in H^2(X, \mathbb{C})$ arbitrary,*

$$\langle u \cup c_\alpha, z_X \rangle = \langle \alpha^*(u), z_S \rangle,$$

where $z_S \in H_2(S, \mathbb{Z})$ denotes the fundamental class of S . Moreover,

$$\iota(c_\alpha) = \alpha_*(z_S).$$

Proof. a) This is a version of Poincaré duality [Sp, Chapter 6, Theorem 3.12].

b) The cohomological transfer map $\alpha_!$ is characterised [Dd, Chapter VIII, Definition 10.5] by the property that $\alpha_!(a) \cap z_X = \alpha_*(a \cap z_S)$, for every $a \in H^0(S, \mathbb{Z})$. The second assertion is just a particular case of this.

For the first one, the claim is simply $(u \cup c_\alpha) \cap z_X = \alpha_*(\alpha^*(u) \cap z_S)$. But the term on the left hand side is $u \cap (c_\alpha \cap z_X) = u \cap \iota(c_\alpha) = u \cap \alpha_*(z_S)$, due to [Sp, Chapter 5, 6.18], while that to the right is $u \cap \alpha_*(z_S)$, by [Sp, Chapter 5, 6.16]. \square

Remarks 3.5. i) In what follows, we generally prefer cohomology versus homology, although there are situations, in which homology classes appear to be more natural. For instance, as $K3$ surfaces are simply connected, the Hurewicz isomorphism theorem [Sp, Chapter 7, Proposition 5.2] shows that $\pi_2(X, \cdot) \cong H_2(X, \mathbb{Z})$. Thus, every class in $H_2(X, \mathbb{Z})$, and hence every class in $H^2(X, \mathbb{Z})$, may be represented by a spheroid $S^2 \rightarrow X$. Therefore, it can be represented by a torus $\alpha: T^2 \rightarrow X$, too.

- ii) Lemma 3.4.a) does not hold for singular surfaces. Cf. Proposition 4.5, below.
 iii) There is the *cup product pairing* $(\cdot, \cdot) := \langle \cdot \cup \cdot, z_X \rangle : H^2(X, \mathbb{Z}) \times H^2(X, \mathbb{Z}) \rightarrow \mathbb{Z}$, which is symmetric, bilinear, and perfect. The cup product pairing bilinearly extends to a pairing

$$(\cdot, \cdot) : H^2(X, \mathbb{Z}) \times H^2(X, \mathbb{C}) \rightarrow \mathbb{C}.$$

Marked K3 surfaces.

Definition 3.6. By a *marked K3 surface*, we mean a complex K3 surface together with an isomorphism $i : \mathbb{Z}^{22} \rightarrow H^2(X, \mathbb{Z})$.

Notation 3.7. i) The *marking* $i : \mathbb{Z}^{22} \rightarrow H^2(X, \mathbb{Z})$ determines the cohomology classes

$$c^k := i(e_k) \in H^2(X, \mathbb{Z}),$$

for $k = 1, \dots, 22$, which form a basis of $H^2(X, \mathbb{Z})$.

ii) There is the dual basis (c_1, \dots, c_{22}) of $H^2(X, \mathbb{Z})$, given by the condition that $(c_k, c^j) = \delta_{kj}$, for $(\cdot, \cdot) : H^2(X, \mathbb{Z}) \times H^2(X, \mathbb{Z}) \rightarrow \mathbb{Z}$ the cup product pairing.

We denote the isomorphism $\mathbb{Z}^{22} \rightarrow H^2(X, \mathbb{Z})$, $e_k \rightarrow c_k$, by \check{i} .

iii) Moreover, the marking defines a perfect, symmetric pairing on \mathbb{Z}^{22} , namely the pull-back of the cup product pairing via \check{i} .

Given any cohomology class $u \in H^2(X, \mathbb{C})$, there is the *tautological decomposition*

$$u = (c^1, u)c_1 + \dots + (c^{22}, u)c_{22},$$

of u with respect to i . For instance, this applies to the *distinguished* cohomology class $[\omega] \in H^2(X, \mathbb{C})$ of the K3 surface X , which is uniquely determined up to scaling. Here and in what follows, we denote by ω a nowhere vanishing holomorphic $(2, 0)$ -form on X .

Definition 3.8. A marked K3 surface (X, i) gives rise to a point

$$\Pi_{X,i} := ((c^1, [\omega]) : \dots : (c^{22}, [\omega])) \in \mathbf{P}^{21}(\mathbb{C}),$$

which is called the *period point* of (X, i) .

Lemma 3.9. *Let X be a complex K3 surface. Then the period point $\Pi_{X,i}$ is completely determined by the composition $\mathbb{Z}^{22} \xrightarrow{i} H^2(X, \mathbb{Z}) \twoheadrightarrow H^2(X, \mathbb{Z})/\text{Pic } X$.*

Proof. Suppose that i and i' are two markings on X differing only by elements in $\text{Pic } X$. I.e., that $c'^k - c^k \in \text{Pic } X$, for $k = 1, \dots, 22$. Then

$$(c'^k, [\omega]) - (c^k, [\omega]) = (c'^k - c^k, [\omega]) = 0,$$

since $c'^k - c^k \in \text{Pic } X$ is of type $(1, 1)$, while $[\omega]$ is of type $(2, 0)$. The assertion follows. \square

Theorem 3.10 (I.R. Shafarevich et al.). *Let κ be a perfect, symmetric pairing on \mathbb{Z}^{22} . Denote the \mathbb{C} -bilinear pairing induced by κ on \mathbb{C}^{22} , by κ as well.*

a) *Let (X_1, i_1) and (X_2, i_2) be marked K3 surfaces defining the pairing κ on \mathbb{Z}^{22} and having the same period point. Then (X_1, i_1) and (X_2, i_2) are isomorphic.*

b) The set Ω_κ of the period points of all marked K3 surfaces defining the pairing κ is possibly empty. Otherwise, one has

$$\Omega_\kappa = \{(x_1 : \cdots : x_{22}) \in \mathbf{P}^{21}(\mathbb{C}) \mid \kappa(x, x) = 0, \kappa(x, \bar{x}) > 0\}.$$

This is an open subset of the quadric $Q_\kappa \subset \mathbf{P}^{21}(\mathbb{C})$, defined by κ .

Proof. This is [BHPV, Theorem VIII.11.1], together with [BHPV, Theorem VIII.14.1]. Cf. [Sh, Chapter IX]. \square

The relative situation. Let $q: \mathfrak{X} \rightarrow Y$ be a holomorphic submersion of complex manifolds and suppose that every fibre is a K3 surface. Then the higher direct image sheaf $R^2q_*\mathbb{Z}$ on Y is locally constant of dimension 22. Moreover, due to Grauert's Theorem ([Gr, Satz 5]), one has a natural base change isomorphism $\iota_t^*: (R^2q_*\mathbb{Z})_t \xrightarrow{\cong} H^2(\mathfrak{X}_t, \mathbb{Z})$, for every $t \in Y$.

Definition 3.11. By a *family of marked K3 surfaces*, one means a holomorphic submersion $q: \mathfrak{X} \rightarrow Y$, every fibre of which is a K3 surface, together with a system $\mathbf{i} = (i_t)_{t \in Y}$ of markings satisfying the following conditions.

- i) For each $t \in Y$, i_t is a marking on the fibre \mathfrak{X}_t .
- ii) For every $v \in \mathbb{Z}^{22}$, $t \mapsto (\iota_t^*)^{-1} \circ i_t(v) \in (R^2q_*\mathbb{Z})_t$ is a global section of $R^2q_*\mathbb{Z}$. I.e., the markings i_t trivialise $R^2q_*\mathbb{Z}$ globally.

Lemma 3.12. Let $q: (\mathfrak{X}, \mathbf{i}) \rightarrow Y$ be a family of marked K3 surfaces. Then the period mapping $\Pi: Y \rightarrow \mathbf{P}^{21}(\mathbb{C})$, $t \mapsto \Pi_{\mathfrak{X}_t, i_t}$, is holomorphic.

Proof. This is easily verified by a direct calculation, cf. [BHPV, Theorem IV.4.3]. \square

The restricted period space.

Lemma 3.13. Let (X, i) be a marked K3 surface, $x = \Pi_{X, i} \in \mathbf{P}^{21}(\mathbb{C})$ its period point, and κ the perfect, symmetric pairing on \mathbb{Z}^{22} defined by (X, i) . Denote the pairing induced on \mathbb{C}^{22} by κ , too. Then

$$\check{i}^{-1} \text{Pic } X = \text{span}(x)^\perp \cap \mathbb{Z}^{22},$$

the orthogonal complement being taken in \mathbb{C}^{22} with respect to κ .

Proof. One has $\text{Pic } X \cong \{u \in H^2(X, \mathbb{Z}) \mid u \cup [\omega] = 0\}$, according to the Lefschetz theorem on $(1, 1)$ -classes [GH, p. 163]. Moreover,

$$\begin{aligned} \langle u \cup [\omega], z_X \rangle &= \left\langle \left(\sum_k (c^k, u) c_k \right) \cup \left(\sum_j x_j c_j \right), z_X \right\rangle = \kappa((c^k, u)_{k=1, \dots, 22}, (x_j)_{j=1, \dots, 22}) \\ &= \kappa((c^k, u)_{k=1, \dots, 22}, x). \end{aligned}$$

Thus, $\check{i}^{-1} \text{Pic } X = \{v \in \mathbb{Z}^{22} \mid \kappa(v, x) = 0\} = \text{span}(x)^\perp \cap \mathbb{Z}^{22}$, as required. \square

Corollary 3.14. Let $r \in \{1, \dots, 20\}$ and κ a perfect, symmetric pairing on \mathbb{Z}^{22} . Denote the pairing induced on \mathbb{C}^{22} by κ , too. Then the set $\Omega_{\kappa, r}$ of the period points of all marked K3 surfaces (X, i) such that

- i) the cohomology classes $c^{22-r+1}, \dots, c^{22} \in H^2(X, \mathbb{Z})$ are algebraic, i.e. contained in $\text{Pic } X \subset H^2(X, \mathbb{Z})$, and

ii) the pairing on \mathbb{C}^{22} induced by (X, i) is exactly κ ,
is either void or one has

$$\Omega_{\kappa, r} = \{(x_1 : \cdots : x_{22-r} : 0 : \cdots : 0) \in \mathbf{P}^{21}(\mathbb{C}) \mid \kappa(x, x) = 0, \kappa(x, \bar{x}) > 0\}. \quad (1)$$

This is an open subset of a quadric $Q_{\kappa, r} \subset \mathbf{P}^{21-r}(\mathbb{C}) \subset \mathbf{P}^{21}(\mathbb{C})$.

Proof. In comparison with Theorem 3.10, $c^{22-r+1}, \dots, c^{22} \in H^2(X, \mathbb{Z})$ being algebraic is the only additional condition. By Lemma 3.13, this means precisely that

$$x \perp \check{i}^{-1}(c^{22-r+1}), \dots, x \perp \check{i}^{-1}(c^{22})$$

with respect to κ . I.e., that $\check{i}(x) \perp \text{span}(c^{22-r+1}, \dots, c^{22})$ with respect to the cup product pairing. The latter is equivalent to $\check{i}(x) \in \text{span}(c_1, \dots, c_{22-r})$, which exactly means that $x \in \text{span}(e_1, \dots, e_{22-r})$. \square

Definition 3.15. Let $q: (\mathfrak{X}, i) \rightarrow Y$ be a family of marked $K3$ surfaces of the kind that $i_t(e_{22-r+1}), \dots, i_t(e_{22})$ are algebraic, for every $t \in Y$. Then we call

$$\Pi: Y \rightarrow \mathbf{P}^{21-r}(\mathbb{C}), \quad t \mapsto \Pi_{\check{x}_t, i_t} := ((i_t(e_1), [\omega]) : \cdots : (i_t(e_{22-r}), [\omega])),$$

the *restricted period map*. In the case that Y is a point, we speak of the *restricted period point*.

Theorem 3.16 (A basis of the transcendental part induces a class of markings).

Let $r \in \{1, \dots, 20\}$, X a complex $K3$ surface, $P \subseteq \text{Pic } X$ a subgroup that is cotorsion-free, and $\iota: \mathbb{Z}^{22-r} \rightarrow H^2(X, \mathbb{Z})/P$ an isomorphism.

a) Then

i) lifting ι to a homomorphism $\mathbb{Z}^{22-r} \rightarrow H^2(X, \mathbb{Z})$ and

ii) extending that to a homomorphism $i: \mathbb{Z}^{22} \rightarrow H^2(X, \mathbb{Z})$ by choosing an arbitrary basis $(u_{22-r+1}, \dots, u_{22})$ of P and putting $i(e_k) := u_k$, for $k = 22-r+1, \dots, 22$,

provides a marking i on X .

b) The marking i yields a restricted period point $\Pi_X \in \mathbf{P}^{21-r}(\mathbb{C})$.

c) The restricted period point $\Pi_X \in \mathbf{P}^{21-r}(\mathbb{C})$ is independent of the choices made in steps a.i) and a.ii).

Proof. The only assertion in a) is that i is an isomorphism, which is clear. b) follows, as the assumptions imply that $i(e_{22-r+1}), \dots, i(e_{22})$ are algebraic. Finally, c) is a direct consequence of Lemma 3.9. \square

Periods as integrals. Suppose that, on a marked $K3$ surface (X, i) , the cohomology class c^j is given by a compact, oriented 2-manifold S , together with a continuous map $\alpha: S \rightarrow X$. Then the j -th period is

$$(c^j, [\omega]) = (c_\alpha, [\omega]) = \langle c_\alpha \cup [\omega], z_X \rangle = \langle \alpha^*([\omega]), z_S \rangle,$$

by Lemma 3.4.b). For smooth α , this is simply $\int_S \alpha^*([\omega])$. Thus, one might have the idea to avoid the topological machinery and to consider the periods just as integrals of the nowhere vanishing $(2, 0)$ -form.

While we indeed use a representation as an integral for computational purposes, cf. Theorem 4.16 below, such a representation is not well suitable as a definition. One problem is that, in our situation, the map α is usually non-smooth. Also, and more crucially, the application of the periods we have in mind is towards real multiplication, which is defined in terms of cohomology.

4. EXPLICIT DESCRIPTION OF TRANSCENDENTAL COHOMOLOGY CLASSES

The family. We consider double covers of $\mathbf{P}_{\mathbb{C}}^2$, ramified in a union of six lines. These are given by $X': w^2 = l_1 \cdots l_6$, for l_1, \dots, l_6 linear forms in three variables. We assume that no point of the plane is contained in three lines. Then there are 15 singular points, each of which is isolated and conical, i.e. of type A_1 . The minimal desingularisation X of X' is hence a $K3$ surface.

Concretely, the $K3$ surface X is obtained from X' by blowing up the 15 singular points. This yields 15 exceptional curves, each of which is a (-2) -curve. In particular, $\text{rk Pic } X \geq 16$.

Notation 4.1. i) For $a = 1, \dots, 6$, we denote the coefficients of the linear form l_a by A_{a1} , A_{a2} , and A_{a3} . I.e., $l_a = A_{a1}x + A_{a2}y + A_{a3}z$.

ii) We write $x_{ij} := V(l_i, l_j) \in \mathbf{P}^2(\mathbb{C})$, for $1 \leq i, j \leq 6$, for the 15 double points of the branch locus. Accordingly, we denote the 15 exceptional curves by E_{ij} , $1 \leq i, j \leq 6$.

iii) We use the notation $\pi: X \rightarrow \mathbf{P}^2(\mathbb{C})$ for the natural map. By definition, π factors via X' ,

$$\pi: X \xrightarrow{\text{bl}} X' \xrightarrow{\pi_{X'}} \mathbf{P}^2(\mathbb{C}).$$

Similarly, as is well-known, π factors via the blowing-up of $\mathbf{P}^2(\mathbb{C})$ in the 15 double points of the branch locus,

$$\pi: X \xrightarrow{\pi'} \text{Bl}_{x_{12}, \dots, x_{56}}(\mathbf{P}^2(\mathbb{C})) \longrightarrow \mathbf{P}^2(\mathbb{C}).$$

The map π' is a double cover, ramified in the union of six mutually disjoint projective lines.

iv) Moreover, X carries the natural involution $\zeta: X \rightarrow X$, which is induced by the map $\zeta': X' \rightarrow X'$, $(w; x : y : z) \mapsto (-w; x : y : z)$.

v) We put

$$P := V \cap H^2(X, \mathbb{Z}),$$

for $V \subset H^2(X, \mathbb{Q})$ the subvector space spanned by the classes $[E_{ij}]$, for $1 \leq i, j \leq 6$, together with $\pi^*[l]$, the inverse image of a general line on \mathbf{P}^2 .

According to this definition, $P \subset H^2(X, \mathbb{Z})$ is a saturated sublattice of rank 16. Let us note explicitly that P is generated by the classes $[E_{ij}]$ and $\pi^*[l]$ only up to finite index.

Remarks 4.2. i) It is a well-known fact from projective geometry that configurations of six lines in \mathbf{P}^2 have exactly four moduli. Indeed, one might normalise the six lines

under the operation of $\text{Aut}(\mathbf{P}_{\mathbb{C}}^2) = \text{PGL}_3(\mathbb{C})$ in such a way that X' is given by an equation of the form

$$X' = X'_{(a_0, b_0, c_0, d_0)}: w^2 = xyz(x + y + z)(x + a_0y + b_0z)(x + c_0y + d_0z). \quad (2)$$

ii) The restricted period space corresponding to a system of generators of P is an open subset of a quadric $Q \subset \mathbf{P}^5$, which is in perfect coincidence with the fact that geometrically there are four moduli.

Lemma 4.3. *Let X be a K3 surface of the family described.*

a) *Then the involution ζ acts on $P \otimes_{\mathbb{Z}} \mathbb{Q} \subset H^2(X, \mathbb{Q})$ as the identity map and on $P^{\perp} \subset H^2(X, \mathbb{Q})$ as the multiplication by (-1) .*

b) *In particular, ζ operates on $H^2(X, \mathbb{Z})/P$ as the multiplication by (-1) .*

Proof. a) The involution ζ has a disjoint union of six projective lines as its fixed point set. The topological Euler characteristic of such a configuration amounts to 12. Therefore, the Lefschetz trace formula [Ed, Theorem 8.5], cf. [SGA5, Exposé III, formule (4.11.3)], shows that $\text{Tr } \zeta|_{H^2(X, \mathbb{Q})} = 10$. In other words, the eigenvalue 1 has multiplicity 16, while the eigenvalue (-1) occurs with multiplicity 6.

On the other hand, ζ clearly fixes P pointwise, which shows that indeed $P \otimes_{\mathbb{Z}} \mathbb{Q}$ is the eigenspace for 1. Finally, the operation of ζ is compatible with the cup product pairing. Thus, for $x \in P$ and $c \in H^2(X, \mathbb{Q})$ in the eigenspace for (-1) , one finds

$$(x, c) = (\zeta^*x, \zeta^*c) = (x, -c) = -(x, c)$$

and hence $c \in P^{\perp}$. This completes the proof of a).

b) directly follows from a). □

Lemma 4.4. *Let Y' be a complex space that is equidimensional of dimension two and has an isolated singular point $y \in Y'$ of type A_1 , i.e. an ordinary double point. Denote by $b: Y \rightarrow Y'$ the blowing-up of Y' at y and by $E \subset Y$ the exceptional curve. Then the homomorphism $b_*: H_2(Y, \mathbb{Z}) \rightarrow H_2(Y', \mathbb{Z})$ is surjective with kernel $\text{span}_{\mathbb{Z}}(\iota([E]))$. I.e., b_* induces a natural isomorphism*

$$H_2(Y, \mathbb{Z}) / \text{span}_{\mathbb{Z}}(\iota([E])) \xrightarrow{\cong} H_2(Y', \mathbb{Z}).$$

Proof. There is the following commutative diagram of Mayer-Vietoris exact sequences

$$\begin{array}{ccccccc} H_2(U(E) \setminus E, \mathbb{Z}) & \rightarrow & H_2(Y \setminus E, \mathbb{Z}) \oplus H_2(U(E), \mathbb{Z}) & \rightarrow & H_2(Y, \mathbb{Z}) & \rightarrow & H_1(U(E) \setminus E, \mathbb{Z}) \\ \parallel & & \downarrow & & \downarrow b_* & & \parallel \\ H_2(U(y) \setminus \{y\}, \mathbb{Z}) & \rightarrow & H_2(Y' \setminus \{y\}, \mathbb{Z}) \oplus H_2(U(y), \mathbb{Z}) & \rightarrow & H_2(Y', \mathbb{Z}) & \rightarrow & H_1(U(y) \setminus \{y\}, \mathbb{Z}). \end{array}$$

Here, we write $U(y)$ for the intersection of Y' with a tiny ball around the point y and $U(E) := b^{-1}(U(y))$ for its preimage in Y . Clearly, the natural map

$$b|_{Y \setminus E}: Y \setminus E \rightarrow Y' \setminus \{y\}$$

is a homeomorphism. Moreover, one readily sees that $U(y)$ is homotopy equivalent to an affine quadratic cone, and hence contractible, while $U(E)$ is of the homotopy type of $\mathbf{P}^1(\mathbb{C}) \cong S^2$. Finally, $U(y) \setminus \{y\}$ has the homotopy type of a complex conic, i.e. that of $\mathbf{P}^1(\mathbb{C}) \cong S^2$, too. In particular, we find that $H_1(U(y) \setminus \{y\}, \mathbb{Z}) = 0$. The commutative diagram therefore takes the form below,

$$\begin{array}{ccccccc} H' & \longrightarrow & H'' \oplus \iota([E]) \cdot \mathbb{Z} & \longrightarrow & H_2(Y, \mathbb{Z}) & \longrightarrow & 0 \\ \parallel & & \downarrow & & \downarrow b_* & & \\ H' & \longrightarrow & H'' & \longrightarrow & H_2(Y', \mathbb{Z}) & \longrightarrow & 0. \end{array}$$

The assertion follows from this by a simple diagram chase. \square

Proposition 4.5 (Homology of the double cover). *Let X be a K3 surface of the family described and X' the underlying double cover of $\mathbf{P}^2(\mathbb{C})$.*

a) *Then the homomorphism $\text{bl}_*: H_2(X, \mathbb{Z}) \rightarrow H_2(X', \mathbb{Z})$ is surjective with kernel $\text{span}_{\mathbb{Z}}(\iota([E_{12}]), \dots, \iota([E_{56}]))$. I.e., bl_* induces a natural isomorphism*

$$H_2(X, \mathbb{Z}) / \text{span}_{\mathbb{Z}}(\iota([E_{12}]), \dots, \iota([E_{56}])) \xrightarrow{\cong} H_2(X', \mathbb{Z}).$$

b) *In particular, the natural homomorphism $H^2(X, \mathbb{Z}) \rightarrow H^2(X, \mathbb{Z})/P$ factors via*

$$H^2(X, \mathbb{Z}) \xrightarrow{\iota} H_2(X, \mathbb{Z}) \xrightarrow{\text{bl}_*} H_2(X', \mathbb{Z}).$$

Proof. Assertion a) follows applying Lemma 4.4 repeatedly, 15 times in total. b) is a direct consequence of a). \square

Remark 4.6. Proposition 4.5 shows, in particular, that $H_2(X', \mathbb{Z})$ has torsion. Indeed, the cohomology class $[E_{12}] + \dots + [E_{16}] + 5\pi^*[l] = [\text{div}(G)] \in H^2(X, \mathbb{Z})$, for $G := l_2 \cdots l_6 - l_1^5$, is divisible by 2. The reason is that, modulo G , the equation $w^2 = l_1 \cdots l_6$ of the surface goes over into $w^2 = l_1^6$. Thus, the divisor $\text{div}(G)$ splits into two components that are interchanged under the involution ζ and the claim follows from Lemma 4.3.a). Consequently, $[E_{13}] + \dots + [E_{16}] - ([E_{23}] + \dots + [E_{26}]) \in H^2(X, \mathbb{Z})$ is divisible by 2, too, and the same is true for its image under ι in $H_2(X, \mathbb{Z})$.

The nontrivial torsion classes in $H_2(X', \mathbb{Z})$ are certainly worth being considered more closely, but, in this article, we do not have any applications for them.

Corollary 4.7. *Let $\alpha: T^2 \rightarrow X'$ be a torus and $\underline{\alpha}, \underline{\underline{\alpha}}: T^2 \rightarrow X$ continuous lifts of α . Then $c_{\underline{\alpha}} - c_{\underline{\underline{\alpha}}} \in P \subset H^2(X, \mathbb{Z})$ (cf. the notation introduced in 4.1.v).*

Proof. According to Proposition 4.5.b), it is sufficient to verify that

$$\text{bl}_*(\iota(c_{\underline{\alpha}})) = \text{bl}_*(\iota(c_{\underline{\underline{\alpha}}})) \in H_2(X', \mathbb{Z}).$$

But this is clear, since $\iota(c_{\underline{\alpha}}) = \underline{\alpha}_*(z_{T^2})$, by Lemma 3.4.b), and therefore

$$\text{bl}_*(\iota(c_{\underline{\alpha}})) = \text{bl}_*(\underline{\alpha}_*(z_{T^2})) = (\text{bl} \circ \underline{\alpha})_*(z_{T^2}) = \alpha_*(z_{T^2}),$$

while exactly the same holds for $\text{bl}_*(\iota(c_{\underline{\underline{\alpha}}}))$. \square

Assumptions on the branch locus.

Assumptions (on the branch locus). **0.i)** We assume once and for all that the branch locus is the union of six *real* lines $V(l_1), \dots, V(l_6)$ [no three of which have a point in common] in $\mathbf{P}^2_{\mathbb{C}}$. I.e., that $A_{a1}, A_{a2}, A_{a3} \in \mathbb{R}$, for $a = 1, \dots, 6$.

0.ii) We suppose that any two of the vectors

$$(A_{11}, A_{12}), \dots, (A_{61}, A_{62})$$

are linearly independent. I.e., it is assumed that the open chart given by “ $z = 1$ ”, which is the one we are going to work with, contains the 15 double points x_{ij} , for $1 \leq i, j \leq 6$.

The linear forms l_1, \dots, l_6 then go over into the affine-linear maps l'_1, \dots, l'_6 ,

$$\begin{aligned} l'_a(x, y) = l_a(x, y, 1) &= A_{a1}x + A_{a2}y + A_{a3} \\ &=: \tilde{l}_a(x, y) + A_{a3}. \end{aligned}$$

Particular 1-manifolds in $\mathbf{P}^2(\mathbb{R})$. The starting point of our construction are compact, connected 1-manifolds Γ , embedded into $\mathbf{P}^2(\mathbb{R})$, of the behaviour indicated in the two figures below. Observe that, in either case, the 1-manifold meets the branch locus $V(l_1 \cdots l_6)$ only in its double points.

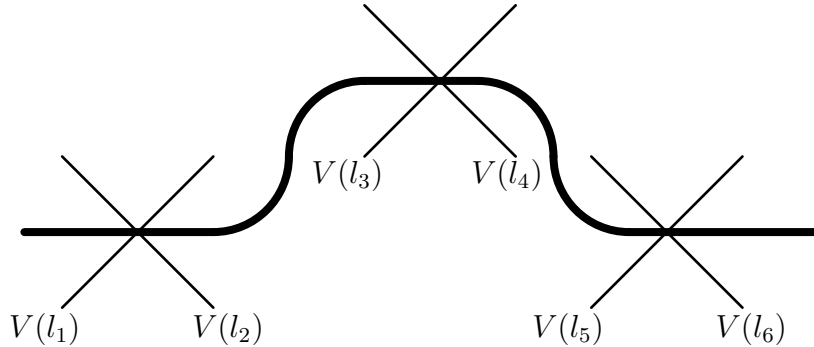

FIGURE 1. A deformed line

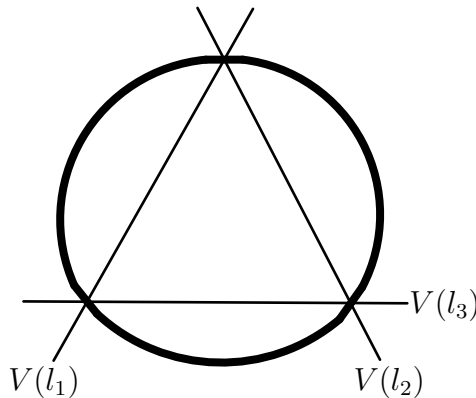

FIGURE 2. A curve encircling a triangle

Terminology 4.8. We call a 1-manifold as in Figure 1 a *deformed line* and one of the type indicated in Figure 2 a *curve encircling a triangle*. We allow as well compact 1-manifolds that are of a similar shape as the one in Figure 2, but encircle a quadrangle or pentagon instead of a triangle. Note here that every compact, connected 1-manifold is diffeomorphic to S^1 .

Technical assumptions on the 1-manifolds. Consider a single compact 1-manifold in $\mathbf{P}^2(\mathbb{R})$ of one of the kinds described. We may certainly assume that it is specified in parametrised form. In the case of a deformed line, the affine part allows a parametrisation given by a C^1 -map

$$\gamma: \mathbb{R} \rightarrow \mathbb{R}^2 \subset \mathbf{P}^2(\mathbb{R}).$$

Similarly, a curve encircling a polygon may be parametrised by a C^1 -map

$$\bar{\gamma}: \mathbf{P}^1(\mathbb{R}) \rightarrow \mathbb{R}^2 \subset \mathbf{P}^2(\mathbb{R}).$$

In this situation, we denote the restriction $\bar{\gamma}|_{\mathbb{R}}$ by γ .

For reasons of simplicity of the presentation, let us make the following assumptions on the 1-manifolds we consider, as well as on their parametrisations.

Assumptions (on the 1-manifolds). **A.i)** In the case that Γ is a curve encircling a polygon, the parametrisation is of the kind that $\bar{\gamma}(\infty)$ is not a branch point.

A.ii) Suppose that the branch point x_{ij} is met by the 1-manifold Γ , and let $x_{ij} = \gamma(t_{ij})$. Then the parametrisation is *linear* near t_{ij} . More precisely,

$$\gamma(t) = (t - t_{ij})b_{ij} + x_{ij},$$

for some $b_{ij} \in \mathbb{R}^2$ and $t \in [t_{ij} - 1, t_{ij} + 1]$. We require, moreover, that

$$b_{ij} \notin \mathbb{R}(A_{i2}, -A_{i1}) \cup \mathbb{R}(A_{j2}, -A_{j1}).$$

I.e., that the direction of Γ near x_{ij} differs from the directions of the lines $V(l_i)$ and $V(l_j)$ of the branch locus that meet at x_{ij} .

A.iii) In addition, for all branch points that are met by Γ , the intervals $[t_{ij} - 1, t_{ij} + 1]$ are mutually disjoint.

A.iv) Finally, for a deformed line, we assume that the map γ is of the shape

$$\gamma(t) = tb + \gamma_0(t) \tag{3}$$

for all $t \in \mathbb{R}$, where $b \in \mathbb{R}^2 \setminus \{(0, 0)\}$ is a certain vector and the C^1 -map $\gamma_0: \mathbb{R} \rightarrow \mathbb{R}^2$ has compact support. We require, moreover, that

$$b \notin \mathbb{R}(A_{12}, -A_{11}) \cup \dots \cup \mathbb{R}(A_{62}, -A_{61}).$$

I.e., that the direction of Γ near infinity differs from the directions of the lines $V(l_1), \dots, V(l_6)$ forming the branch locus.

Notation 4.9. i) We let $x_{i_1, j_1}, \dots, x_{i_n, j_n} \in V(l_1 \cdots l_6) \subset \mathbf{P}^2(\mathbb{R})$, for $n = 3, 4$, or 5 , be the points of the branch locus that are met by Γ .

ii) Moreover, we denote by $t_1 = t_{i_1, j_1}, \dots, t_n = t_{i_n, j_n} \in \mathbb{R}$ the parameters of these points. I.e. the reals such that $\gamma(t_1) = x_{i_1, j_1}, \dots, \gamma(t_n) = x_{i_n, j_n}$.

The main construction—2-tori from 1-manifolds.

Notation 4.10. Write $\mathbf{T} := \mathbf{P}^1(\mathbb{R}) \times \mathbf{P}^1(\mathbb{R}) \supset \mathbb{R} \times \mathbb{R} = \mathbb{R}^2$, for the obvious compactification. This is our standard 2-torus.

Definition 4.11. By a *liftable torus*, in this article, we mean a torus $\alpha_\bullet: \mathbf{T} \rightarrow X'$ that lifts through the blowing-down map $\text{bl}: X \rightarrow X'$ between the $K3$ surface X and the singular double cover X' of \mathbf{P}^2 . I.e., we require the existence of a continuous map $\alpha: \mathbf{T} \rightarrow X$ to the $K3$ surface, such that $\text{bl} \circ \alpha = \alpha_\bullet$.

Main construction 4.12 (2-dimensional tori from 1-manifolds).

a) There are two liftable tori, i.e. continuous maps

$$\alpha_\Gamma, \tilde{\alpha}_\Gamma: \mathbf{T} \longrightarrow X',$$

which differ only by the involution ζ , associated with each deformed line Γ , as above.

b) Similarly, there are two liftable tori

$$\alpha_{\Gamma,b}, \tilde{\alpha}_{\Gamma,b}: \mathbf{T} \longrightarrow X',$$

differing only by the involution ζ , associated with each curve Γ encircling a polygon, together with a vector

$$b \in \mathbb{R}^2 \setminus (\mathbb{R}(A_{12}, -A_{11}) \cup \dots \cup \mathbb{R}(A_{62}, -A_{61})). \quad (4)$$

4.13. The tori are obtained by the following purely topological construction.

i) (Adding an imaginary direction) Extend the map $\gamma: \mathbb{R} \rightarrow \mathbb{R}^2 \subset \mathbf{P}^2(\mathbb{R})$ to a continuous map in two variables by putting

$$\gamma': \mathbb{R}^2 \longrightarrow \mathbb{C}^2 \subset \mathbf{P}^2(\mathbb{C}), \quad (t, u) \mapsto \gamma(t) + iub. \quad (5)$$

Here, in the case of a deformed line, the vector b is taken from A.iv), while, in the case of a curve encircling a polygon, b is part of the input data. The map γ' allows a continuous prolongation

$$\alpha': \mathbf{T} \rightarrow \mathbf{P}^2(\mathbb{C}).$$

ii) (Lifting to the double cover) The map α' allows a continuous lift

$$\alpha'': \mathbf{T} \rightarrow X'$$

to the double cover. There is, in fact, a second such lift, $\tilde{\alpha}''$, differing from α'' by the involution ζ .

iii) (Widening the holes) Use a self-map $\Psi: \mathbf{T} \rightarrow \mathbf{T}$ that induces a homeomorphism

$$\Psi|_{\mathbf{T} \setminus (\overline{U_{\frac{1}{2}}(t_1, 0)} \cup \dots \cup \overline{U_{\frac{1}{2}}(t_n, 0)})}: \mathbf{T} \setminus (\overline{U_{\frac{1}{2}}(t_1, 0)} \cup \dots \cup \overline{U_{\frac{1}{2}}(t_n, 0)}) \xrightarrow{\cong} \mathbf{T} \setminus \{(t_1, 0), \dots, (t_n, 0)\}$$

and sends $\overline{U_{\frac{1}{2}}(t_i, 0)}$ constantly to $(t_i, 0)$, for $i = 1, \dots, n$, to define

$$\alpha''' := \alpha'' \circ \Psi: \mathbf{T} \rightarrow X'.$$

This is the liftable torus α_Γ or $\alpha_{\Gamma,b}$ desired.

Remarks 4.14. i) The cohomology class $c_\alpha \in H^2(X, \mathbb{Z})$ is dependent on the lift $\alpha: \mathbf{T} \rightarrow X$ chosen. Two different lifts lead to cohomology classes differing by a summand from P . I.e., the image $\bar{c}_\alpha \in H^2(X, \mathbb{Z})/P$ depends only on the torus α_Γ or $\alpha_{\Gamma, b}: \mathbf{T} \rightarrow X'$ lifted. In fact, \bar{c}_α depends only on the homotopy class of α_Γ or $\alpha_{\Gamma, b}$, respectively. This is a direct consequence of Corollary 4.7.

Moreover, by Lemma 4.3.b), the classes \bar{c}_α and $\bar{c}_{\bar{\alpha}} \in H^2(X, \mathbb{Z})/P$ only differ by sign.

ii) Step iii) in the construction above could be eliminated at the cost of a somewhat less elegant description of the class $\bar{c}_\alpha \in H^2(X, \mathbb{Z})/P$, which works as follows.

Take the homology class $\alpha''_*(z_{\mathbf{T}}) \in H_2(X', \mathbb{Z})$ and put $\bar{c}_\alpha \in H^2(X, \mathbb{Z})/P$ to be its image, according to the homomorphism described in Lemma 4.5.b).

iii) The two theorems below are the principal results on the construction just described. As their proofs are a bit technical, we postpone them to the final section. The same applies to the claims made in 4.13. Cf., in particular, Propositions 8.11 and 8.13.

Theorem 4.15 (Independence of b in the case of a curve encircling a polygon). *Let Γ be a curve encircling a polygon and*

$$\underline{b}, \underline{\bar{b}} \in \mathbb{R}^2 \setminus (\mathbb{R}(A_{12}, -A_{11}) \cup \dots \cup \mathbb{R}(A_{62}, -A_{61}))$$

any two vectors. Moreover, let $\underline{\alpha}: \mathbf{T} \rightarrow X$ be any continuous lift of $\alpha_{\Gamma, \underline{b}}: \mathbf{T} \rightarrow X'$ and $\underline{\bar{\alpha}}: \mathbf{T} \rightarrow X$ any continuous lift of $\alpha_{\Gamma, \underline{\bar{b}}}: \mathbf{T} \rightarrow X'$.

Then $\bar{c}_{\underline{\alpha}} \in H^2(X, \mathbb{Z})/P$ coincides either with $\bar{c}_{\underline{\bar{\alpha}}}$ or with $-\bar{c}_{\underline{\bar{\alpha}}} \in H^2(X, \mathbb{Z})/P$.

Theorem 4.16 (Periods as improper integrals). *Let X be the K3 surface obtained as the minimal desingularisation of the double cover $X': w^2 = l_1 \cdots l_6$, for l_1, \dots, l_6 real linear forms. Assume that no three of the linear forms have a zero in common. On X , fix the global holomorphic $(2, 0)$ -form ω , determined by formula (8), below. Let, moreover, Γ be a compact 1-manifold in $\mathbf{P}^2(\mathbb{R})$ being a deformed line or a curve encircling a polygon. We assume that Γ is parametrised by $\gamma: \mathbb{R} \rightarrow \mathbb{R}^2 \subset \mathbf{P}^2(\mathbb{R})$ and that Assumptions A.i) to A.iv) are fulfilled.*

i) *Let Γ be a deformed line. Then, for every continuous lift $\alpha: \mathbf{T} \rightarrow X$ of the torus $\alpha_\Gamma: \mathbf{T} \rightarrow X'$,*

$$(c_\alpha, [\omega]) = i \int_{-\infty}^{\infty} \int_{-\infty}^{\infty} \frac{\dot{\gamma}_1(t)b_2 - \dot{\gamma}_2(t)b_1}{\sqrt{l_1(\gamma(t) + iub) \cdots l_6(\gamma(t) + iub)}} du dt, \quad (6)$$

where the vector $b \in \mathbb{R}^2 \setminus \mathbb{R}(A_{12}, -A_{11}) \cup \dots \cup \mathbb{R}(A_{62}, -A_{61})$ is taken from A.iv).

ii) *Let $b \in \mathbb{R}^2 \setminus \mathbb{R}(A_{12}, -A_{11}) \cup \dots \cup \mathbb{R}(A_{62}, -A_{61})$ be any vector and Γ a curve encircling a polygon. Then, for every continuous lift $\alpha: \mathbf{T} \rightarrow X$ of the torus $\alpha_{\Gamma, b}: \mathbf{T} \rightarrow X'$,*

$$(c_\alpha, [\omega]) = i \int_{-\infty}^{\infty} \int_{-\infty}^{\infty} \frac{\dot{\gamma}_1(t)b_2 - \dot{\gamma}_2(t)b_1}{\sqrt{l_1(\gamma(t) + iub) \cdots l_6(\gamma(t) + iub)}} du dt. \quad (7)$$

In either case, the square root in the integrand is meant to be the same as that in the form ω .

Remarks 4.17. i) In the case of a deformed line, the outer integral in (6) is actually proper. Indeed, formulae (5) and (3) together imply that the map α' , and hence the lift α'' , too, is holomorphic near every point $(t, u) \in \mathbf{T}$ with $t \notin \text{supp } \gamma_0$. Furthermore, since ω is a $(2, 0)$ -form on X and \mathbf{T} is of real dimension two, holomorphicity enforces the pull-back $(\alpha''|_{\mathbb{R}^2 \setminus \{t_1, \dots, t_n\}})^* \omega'$ to be the null form in a neighbourhood of (t, u) . Finally, the integrand in (6) exactly corresponds to this differential form. Thus, the outer integral actually ranges only over $\text{supp } \gamma_0$.

ii) On the other hand, a curve encircling a polygon is a curve in \mathbb{R}^2 of finite length. It is convenient to reparametrise it by a compact interval, so that in this case the outer integral in (7) becomes proper, too.

The global holomorphic differential form.

Proposition 4.18. *Let X be the minimal desingularisation of the double cover $X': w^2 = l_1 \cdots l_6$, for l_1, \dots, l_6 linear forms in the variables x, y , and z . Assume that no three of the six linear forms have a zero in common.*

Then, for any linear form l that is not just a scalar multiple of x or y and defines a nonsingular curve on X' ,

$$\omega' := \frac{d(\frac{x}{l}) \wedge d(\frac{y}{l})}{\frac{w}{l^3}} \quad (8)$$

is a differential form on X' , whose pull-back ω to X is a global holomorphic $(2, 0)$ -form without zeroes or poles.

Proof. On the affine plane, given by $l \neq 0$, the functions $\xi := \frac{x}{l}$ and $\eta := \frac{y}{l}$ form a system of coordinates. In particular, there are functions $\lambda_1, \dots, \lambda_6$ of total degree 1 such that $\lambda_i(\xi, \eta) = l_i(\frac{x}{l}, \frac{y}{l}, \frac{z}{l})$, for $i = 1, \dots, 6$. The corresponding affine part of the double cover X' is thus given by $\psi^2 = \lambda_1 \cdots \lambda_6$, for $\psi := \frac{w}{l^3}$.

Hence, $\omega' = d\xi \wedge d\eta / \psi$. This immediately shows that, outside $V(l_1 \cdots l_6)$, which is the branch locus, and $V(l)$, which is not on our chart, ω has neither zeroes, nor poles.

Next, consider a point that lies on exactly one of the lines $V(\lambda_1), \dots, V(\lambda_6)$. Then at least one of the partial derivatives $\frac{\partial(\lambda_1 \cdots \lambda_6)}{\partial \xi}$ and $\frac{\partial(\lambda_1 \cdots \lambda_6)}{\partial \eta}$ is nonzero. Without restriction, assume that $\frac{\partial(\lambda_1 \cdots \lambda_6)}{\partial \eta} \neq 0$. Then ψ and ξ form a local system of coordinates. Moreover, the equation $\psi^2 = \lambda_1 \cdots \lambda_6$ yields $2\psi d\psi = \frac{\partial(\lambda_1 \cdots \lambda_6)}{\partial \xi} d\xi + \frac{\partial(\lambda_1 \cdots \lambda_6)}{\partial \eta} d\eta$, which shows that $2\psi d\xi \wedge d\psi = \frac{\partial(\lambda_1 \cdots \lambda_6)}{\partial \eta} d\xi \wedge d\eta$. Thus, $d\xi \wedge d\eta$ is indeed divisible by ψ and the quotient $\omega' = d\xi \wedge d\eta / \psi$ is nonzero near the point considered.

Finally, let us write $W := \text{div } \omega \in \text{Div } X$. The calculations above prove that W has the form

$$W = n[L] + \sum_{1 \leq i < j \leq 6} n_{ij}[E_{ij}],$$

for $L := V(l)$. We have to show that, in fact, all the coefficients vanish.

For this, let us note that W is, by construction, a canonical divisor. Thus, the adjunction formula shows that $(W + [E_{ij}])[E_{ij}] = 2g_{E_{ij}} - 2 = -2$, i.e. $W[E_{ij}] = 0$,

for $1 \leq i < j \leq 6$. Consequently, $n_{ij} = -\frac{1}{2}W[E_{ij}] = 0$. Moreover, L is a double cover of a projective line ramified over six points, and hence its genus is $g_L = 2$. Here, adjunction shows that $(W + [L])[L] = 2g_L - 2 = 2$. As $[L][L] = 2$, this yields $W[L] = 0$ and $n = \frac{1}{2}W[L] = 0$. The assertion follows. \square

5. EXPLICIT DESCRIPTION OF TRANSCENDENTAL COHOMOLOGY CLASSES— COMPUTATION OF PERIODS

The main algorithms.

5.1. For clarity of the presentation, let us present our main algorithms in a somewhat idealised setting. Imagine for a moment that one could calculate 2-dimensional integrals *exactly*, as complex numbers. Then, given an arbitrary K3 surface $X = X_{(a_0, b_0, c_0, d_0)}$ (cf. formula (2)), we could run the following algorithm.

Algorithm 5.2 (Explicit description of the transcendental part of $H^2(X, \mathbb{Z})$ — Idealised setting).

- i) Set up a list of 1-manifolds in $\mathbf{P}^2(\mathbb{R})$ consisting of
 - for each triangle, quadrangle, or pentagon formed in the affine plane given by “ $z = 1$ ” by the lines of the branch locus, one curve encircling it,
 - through each triple of double points of the branch locus that may be connected by a deformed line within the affine plane given by “ $z = 1$ ”, one deformed line.
- ii) For every 1-manifold listed, construct a torus $\alpha: \mathbf{T} \rightarrow X$, as described in 4.12.
- iii) For every torus α constructed, calculate $(c_\alpha, [\omega]) \in \mathbb{C}$ using Theorem 4.16, formulae (6) and (7).
- iv) Detect all \mathbb{Z} -linear dependencies among these numbers, and select six (linear combinations of) tori $\alpha_1, \dots, \alpha_6$ that yield a \mathbb{Z} -basis for the complex numbers obtained.

In the case that the numbers $(c_\alpha, [\omega])$ form a \mathbb{Q} -vector space of dimension less than six, do the calculations on a surface $X_{(a, b, c, d)}$, for a quadruple (a, b, c, d) near (a_0, b_0, c_0, d_0) .

- v) Detect the \mathbb{Q} -linear dependency among the products $(c_{\alpha_i}, [\omega]) \cdot (c_{\alpha_j}, [\omega])$, for $1 \leq i < j \leq 6$. I.e., determine the projective quadric $Q_{\kappa, 16} \subset \mathbf{P}^5(\mathbb{C})$ in the restricted period space.

Again, do this on a neighbouring surface that is generic, if necessary.

- vi) Determine the quadratic form κ exactly, not only up to scaling, from the fact that the self-product is known for a deformed line. (Cf. Lemma 5.12.)
- vii) Verify that $c_{\alpha_1}, \dots, c_{\alpha_6}$ indeed form a generating system of $H^2(X, \mathbb{Z})/P$, not only up to finite index. (Cf. Theorem 5.14.)

Remarks 5.3. i) By Theorem 3.16, the result that $c_{\alpha_1}, \dots, c_{\alpha_6}$ generate $H^2(X, \mathbb{Z})/P$ implies that these elements give rise to a class of markings on X , for which the numbers $(c_{\alpha_i}, [\omega])$ are indeed the coordinates of the period vector.

ii) In practice, of course, in step iii), one has to use numerical integration methods working at a finite precision. Moreover, instead of the exact linear algebra in step iv), the singular value decomposition is playing the main role.

iii) Algorithm 5.9 below gives a more thorough description of step v).

5.4. Furthermore, given a $K3$ surface $X = X_{(a_0, b_0, c_0, d_0)}$ having real multiplication (cf. Section 6), one could run the algorithm below.

Algorithm 5.5 (Tracing the modular curve — Idealised setting).

i) Detect the linear relations between the coordinates of the period points encoding real multiplication. Cf. Theorem 6.29 for details.

ii) Using Newton iteration, find surfaces $X_{(a, b, c, d)}$, for quadruples (a, b, c, d) near (a_0, b_0, c_0, d_0) , the coordinates of the period points of which fulfil the same relation, not exactly but at high precision.

Remark 5.6. If one had enough of these quadruples (exactly) then it would just be linear algebra to find an algebraic curve through these quadruples. Again, the singular value decomposition plays the main role in our adaption of Algorithm 5.5 to practice.

Numerical integration.

Strategy 5.7. In order to numerically calculate the 2-dimensional integrals occurring in Theorem 4.16, our strategy is roughly as follows.

i) We decompose the domain of the outer integral into finitely many intervals $[a_{k-1}, t_k]$ and $[t_k, a_k]$, each of which contains none of the t_1, \dots, t_n as an inner point and exactly one as an endpoint. For integration, each such interval is treated individually, the results being added together at the very end.

ii) For each concrete interval, the inner integral needs to be computed only over $[0, \infty) \subset \mathbb{R}$. Indeed, the sign change $u \mapsto (-u)$ transforms the integrand into its complex conjugate or minus its complex conjugate, depending on the sign of $(l_1 \cdots l_6) \circ \gamma$ on the interval.

iii) We decompose the two-dimensional domains of integration emerging into three subdomains each, as indicated in Figure 3 below. For each subdomain, we determine the integral using Fubini's Theorem in a rather naive manner. The inner integrals, for the computation, are taken along the line segments and rays, as shown in the figure.

iv) To compute the inner integrals of the integral over the triangle, we use the Gauß-Legendre method.

For the computation of the inner integrals that are improper, we decompose the ray into finitely many intervals I_1, \dots, I_N of lengths increasing by a factor of $\frac{|I_{i+1}|}{|I_i|} = q = \frac{3}{2}$ and the remaining ray. The substitution $u' := 1/u$ transforms the integral over the latter into a definite one. We then use the Gauß-Legendre method for each of the individual integrals and add the results together.

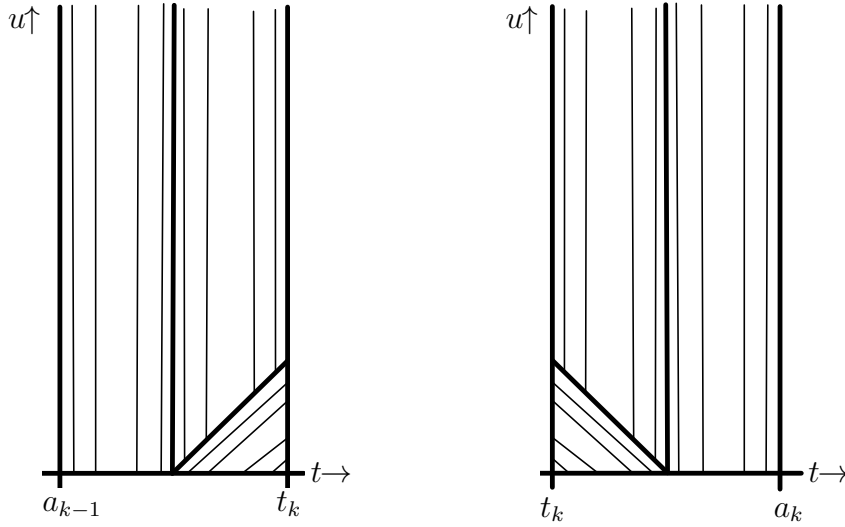

FIGURE 3. The two-dimensional domains of integration

Thereby, we work with adaptive stepsizes, as follows. First, we parametrise the ray. This results in a hyperelliptic integral of the form

$$\int_{u_0}^{\infty} \frac{1}{\sqrt{(a_1 i u + b_1) \cdots (a_6 i u + b_6)}} du,$$

for $u_0 \geq 0$ and $a_1, \dots, a_6, b_1, \dots, b_6 \in \mathbb{R}$. Note that all singularities of the integrand are located on the imaginary line, while the domain of integration is a ray contained in the reals.

We compute the smallest and the largest among the absolute values of all the singularities of the integrand. Denote these by S and M . The first interval I_1 , starting at u_0 , is then taken to be of length $\max(u_0, S)$. We then increase the lengths of the intervals by the factor of $q = \frac{3}{2}$ in each step, until we reach a value of $u_1 > 4M$. Then, on the remaining ray, coordinates are changed as described above.

The aim of this strategy is to make sure that, for each interval of integration, the ratio between its length and the distance to the next singularity is bounded by a constant. This suffices to make sure that the Gauss-Legendre method provides the expected precision.

For example, applying the change of coordinates, the final ray is turned into the interval $[0, \frac{1}{u_1}]$, whereas the smallest absolute value of a singularity becomes $\frac{1}{M}$. As $\frac{1}{u_1} < \frac{1}{4M}$, the resulting integral can be computed numerically without any further splitting of the interval $[0, \frac{1}{u_1}]$.

v) For the outer integrals, we again use the Gauß-Legendre method.

Remarks 5.8. i) One might want to choose the degrees for the Gauß-Legendre method differently for the two levels, the computations of the inner and the outer integrals. However, we never did so.

ii) Our experience is that the approximations obtained start to get useful for degree 30 [i.e. order 60], and that the calculations start to become slow at degree 100, while degree 300 appears to be some kind of acceptance limit for usability in practice.

iii) To illustrate this, let us present some data related to Example 6.27, below. Working on a suitably chosen affine chart, there are four deformed lines, four curves encircling a triangle, and six curves encircling a quadrangle occurring. The running times to compute the corresponding 14 integrals at various precisions, as well as the largest relative errors in comparison with degree 200, are summarised in the table below. We did the numerical calculations in floats of as many decimal digits as the degree chosen.

Degree	Running time	Largest relative error
20	20.99 s	$3.301361055 \cdot 10^{-18}$
30	45.95 s	$6.544716595 \cdot 10^{-26}$
50	138.58 s	$2.767253174 \cdot 10^{-40}$
100	640.45 s	$2.562917026 \cdot 10^{-77}$
150	1644.72 s	$3.312576296 \cdot 10^{-114}$
200	3234.76 s	—

TABLE 1. Running times to compute the 14 integrals

Transcendental 2-cocycles. Given a concrete $K3$ surface of the type aforementioned, we usually apply the main construction 4.12 to all curves encircling a polygon and all deformed lines occurring on a fixed affine chart. This provides by far more than six representatives of classes in $H^2(X, \mathbb{Z})/P$.

Algorithm 5.9 (Determining the cup product on $P^\perp \otimes_{\mathbb{Z}} \mathbb{Q}$, up to scaling).

Let $X = X_{(a_0, b_0, c_0, d_0)}$ be a $K3$ surface given as the minimal desingularisation of a double cover of the form (2), for $a_0, b_0, c_0, d_0 \in \mathbb{R}$. Moreover, let $\alpha_1, \dots, \alpha_n: \mathbf{T} \rightarrow X$ be tori of the kind that the classes $\bar{c}_{\alpha_1}, \dots, \bar{c}_{\alpha_n} \in H^2(X, \mathbb{Z})/P$ form a system of generators.

i) Choose open neighbourhoods $\mathbb{D} \cong U(a_0) \ni a_0, \dots, \mathbb{D} \cong U(d_0) \ni d_0$ in such a way that, for every $(a, b, c, d) \in U := U(a_0) \times \dots \times U(d_0)$, no three of the resulting six lines in $\mathbf{P}_{\mathbb{C}}^2$ have a point in common. Then the cohomology classes $c_{\alpha_1}, \dots, c_{\alpha_n}$ uniquely extend to the whole family $\mathfrak{X} \rightarrow U$ of the $K3$ surfaces $X_{(a, b, c, d)}$.

Moreover, choose N surfaces X_1, \dots, X_N at random from the family and write down the corresponding holomorphic 2-forms $\omega_1, \dots, \omega_N$. (We usually work with $N = 50$.)

ii) Set up the matrix $M := (c_{\alpha_j}, [\omega_i])_{1 \leq i \leq N, 1 \leq j \leq n}$ using numerical integration and calculate the singular value decomposition of M . Six singular values should be numerically nonzero. The others give rise to linear relations among the cohomology classes $c_{\alpha_1}, \dots, c_{\alpha_n}$.

iii) Choose a basis c_1, \dots, c_6 of the free \mathbb{Z} -module spanned by $c_{\alpha_1}, \dots, c_{\alpha_n}$ modulo the relations found.

iv) Build from M the $N \times 15$ -matrix $F := (c_{j_1}, [\omega_i])(c_{j_2}, [\omega_i])_{1 \leq i \leq N, 1 \leq j_1 \leq j_2 \leq 6}$. Then determine an approximate solution of the corresponding homogeneous linear system of equations, using the QR-factorisation of F . I.e., detect the one linear relation between the 15 products that is approximately fulfilled for all i . This solution vector describes the symmetric, bilinear pairing desired.

Remarks 5.10. i) As it relies only on the projective quadric $Q_{\kappa,16} \subset \mathbf{P}^5(\mathbb{C})$ defined by the symmetric, bilinear form κ (cf. Corollary 3.14, in particular formula (1)) and not on κ itself, our method is inherently limited to determining the cup product pairing, or κ , up to scaling.

ii) Algorithm 5.9 works with the restricted period space. Therefore, it detects only the restriction of the cup product pairing to $P^\perp \otimes_{\mathbb{Z}} \mathbb{Q} \subset H^2(X, \mathbb{Q})$.

iii) Every class in $H^2(X, \mathbb{Z})/P$ has a unique representative in $P^\perp \otimes_{\mathbb{Z}} \mathbb{Q}$, the orthogonal projection

$$\text{pr}: H^2(X, \mathbb{Z})/P \longrightarrow P^\perp \otimes_{\mathbb{Z}} \mathbb{Q}$$

being injective. (Note that $P \subset H^2(X, \mathbb{Z})$ is a sublattice not of discriminant ± 1 , so the image of pr indeed contains non-integral classes.) Thus, we actually compute the pairing $(\text{pr}(\cdot), \text{pr}(\cdot)): H^2(X, \mathbb{Z}) \times H^2(X, \mathbb{Z}) \rightarrow \mathbb{Q}$, up to scaling.

iv) The algorithm yields the matrix describing the cup product pairing, up to scaling, with respect to (c^1, \dots, c^6) , but provides the dual basis (c_1, \dots, c_6) . The corresponding matrices are, in fact, inverse to each other. Indeed,

$$\sum_k (u, c_k)(c^k, v) = \left(u, \sum_k (c^k, v)c_k \right) = (u, v)$$

and therefore $\sum_k (c_i, c_k)(c^k, c^j) = \delta_{ij}$.

Remark 5.11. Often, one may detect the cup product pairing (up to scaling) relying only on a single surface (instead of $N = 50$), using an LLL-based approach. Indeed, it seems plausible that the cohomology classes of the tori constructed are rather small within the transcendental lattice. Thus, between their periods, being irrational numbers known at high precision, there should be no further small quadratic relations besides that coming from the cup product pairing.

Lemma 5.12. *Let $\alpha: \mathbf{T} \rightarrow X$ be a torus constructed from a deformed line, as in Figure 1. Then $(\text{pr}(c_\alpha), \text{pr}(c_\alpha)) = -1$.*

Proof. The expression $(\text{pr}(c_\alpha), \text{pr}(c_\alpha))$ is purely cohomological, and therefore homotopy invariant. Up to homotopy, the three double points may be assumed to be collinear. Without restriction, the deformed line Γ is then actually a line, parametrised by $\gamma(t) = tb$, i.e. $\gamma_0(t) \equiv 0$.

In this situation, the main construction 4.12 yields that

$$\alpha'|_{\mathbb{R}^2} = \gamma': \mathbb{R}^2 \longrightarrow \mathbb{C}^2 \subset \mathbf{P}^2(\mathbb{C})$$

is given by $(t, u) \mapsto (t + iu)b$. Thus, $\alpha'|_{\mathbb{R}^2}$ is a holomorphic embedding onto an affine line contained in $\mathbf{P}^2(\mathbb{C})$. In other words, the torus α' , as described in (5) and (10),

parametrises, generically one-to-one, the complex projective line $g' \subset \mathbf{P}^2(\mathbb{C})$ through the three double points.

The inverse image of g' in X' splits into two complex algebraic curves both being rational as the branch locus consists entirely of double points. Thus, the lift $\alpha'' : \mathbf{T} \rightarrow X'$ parametrises, generically one-to-one, one such component g'' . And $\alpha_\Gamma : \mathbf{T} \rightarrow X$ parametrises the strict transform $g \subset X$ of g'' . Consequently, $c_\alpha = [g]$.

One has $[g]^2 = -2$, $[g] \cdot \pi^*[l] = 1$, and $[g][E_1] = [g][E_2] = [g][E_3] = 1$, for E_1 , E_2 , and E_3 the exceptional points over the double points met by Γ . Clearly, $[g]$ is perpendicular to the classes of the three other exceptional curves. As for algebraic classes, the cup product pairing coincides with the intersection pairing [GH, §0.4], using the facts that $[E_i]^2 = -2$ and $\pi^*[l] \cdot \pi^*[l] = 2$, one finds that $\text{pr}(c_\alpha) = D$, for D the \mathbb{Q} -divisor

$$D := [g] - \frac{1}{2}\pi^*[l] + \frac{1}{2}[E_1] + \frac{1}{2}[E_2] + \frac{1}{2}[E_3].$$

Finally, $D^2 = -1$ is easily seen by a direct calculation. \square

Remark 5.13. We use the observation made in Lemma 5.12 for scaling.

Theorem 5.14. *Let X be the minimal desingularisation of a double cover of $\mathbf{P}^2_{\mathbb{C}}$, ramified over a union of six real lines, such that no three of them have a point in common. Then the classes of the tori, as described in Proposition 8.11 below, always generate the whole of $H^2(X, \mathbb{Z})/P$.*

Proof (depending on numerical integration). There are four essentially distinct configurations of six real lines in \mathbf{P}^2 , no three of which have a point in common [Yo, Chapter VII, Section 8.1]. We made an experiment for each case. \square

Remark 5.15. Our approach to find example configurations for each of the four types was invariant-theoretic and used only a small proportion of the theory developed in [Yo]. Some details are as follows.

The admissible configurations of six real lines correspond under projective duality to arrangements of six real points $(x_1 : y_1 : z_1), \dots, (x_6 : y_6 : z_6) \in \mathbf{P}^2$, no three of which are collinear. I.e., such that each of the twenty determinants

$$\det \begin{pmatrix} x_{i_1} & x_{i_2} & x_{i_3} \\ y_{i_1} & y_{i_2} & y_{i_3} \\ z_{i_1} & z_{i_2} & z_{i_3} \end{pmatrix},$$

for $1 \leq i_1 < i_2 < i_3 \leq 6$, is nonzero. Thus, the vector of signs in $(\pm 1)^{10}$ of the ten products

$$\det \begin{pmatrix} x_{i_1} & x_{i_2} & x_{i_3} \\ y_{i_1} & y_{i_2} & y_{i_3} \\ z_{i_1} & z_{i_2} & z_{i_3} \end{pmatrix} \cdot \det \begin{pmatrix} x_{i_4} & x_{i_5} & x_{i_6} \\ y_{i_4} & y_{i_5} & y_{i_6} \\ z_{i_4} & z_{i_5} & z_{i_6} \end{pmatrix},$$

for $\{i_1, \dots, i_6\} = \{1, \dots, 6\}$, $i_1 < i_2 < i_3$, $i_4 < i_5 < i_6$, and $i_1 < i_4$ is an invariant of the configuration, up to the action of S_6 permuting the six points and up to that of $(\mathbb{Z}/2\mathbb{Z})^6$, by sign changes. However, the latter group acts via the summation

character $+: (\mathbb{Z}/2\mathbb{Z})^6 \rightarrow \mathbb{Z}/2\mathbb{Z}$. I.e., there is either no change at all or all ten signs are changed simultaneously.

Working with a few explicit example configurations, one readily finds four distinct types, having invariant vectors as follows.

Type	Multisets associated with the invariant vectors
0	$\{1^{10}\}, \{1^6, (-1)^4\}, \{1^4, (-1)^6\}, \{(-1)^{10}\}$
1	$\{1^9, (-1)\}, \{1^7, (-1)^3\}, \{1^5, (-1)^5\}, \{1^3, (-1)^7\}, \{1, (-1)^9\}$
2	$\{1^8, (-1)^2\}, \{1^6, (-1)^4\}, \{1^4, (-1)^6\}, \{1^2, (-1)^8\}$
3	$\{1^7, (-1)^3\}, \{1^3, (-1)^7\}$

TABLE 2. The admissible configurations of six real lines in \mathbf{P}^2

Remarks 5.16. i) We constructed our example configurations systematically. We assumed without restriction that the first four points are $(1:0:0)$, $(0:1:0)$, $(0:0:1)$, and $(1:1:1)$. The complement in $\mathbf{P}^2(\mathbb{R})$ of the six lines through these points breaks into $\frac{6 \cdot 5}{2} + 1 - 4 \cdot \frac{2 \cdot 1}{2} = 12$ chambers. Thus, for the choice of the fifth point, there are only twelve essentially different cases. Moreover, each time, the complement of the ten lines through the five points obtained is a disjoint union of $\frac{10 \cdot 9}{2} + 1 - 5 \cdot \frac{3 \cdot 2}{2} = 31$ chambers [Yo, Chapter VII, Section 8.2]. This means that all cases are covered by $31 \cdot 12 = 372$ explicit configurations.

Calculating the invariants, we produced a partition of these 372 configurations into four subsets. We then checked that two configurations in the same subset were indeed always equivalent to each other, under the operation of S_6 , followed by a renormalisation of the first four points to $(1:0:0)$, $(0:1:0)$, $(0:0:1)$, and $(1:1:1)$, plus a naive relocation of points within the same chamber.

ii) This means that our approach actually provides a new proof for the fact that there are exactly four types of configurations of six real lines in \mathbf{P}^2 , no three of which have a point in common. Our proof is essentially computational and thus rather different from the one presented in [Yo].

iii) The group S_6 , of course, does not give rise to all permutations in S_{10} , but to a subgroup of S_{10} of index 5040. We ignored the information that is perhaps carried by this subgroup and just took care of the multisets that are associated with the invariant vectors.

iv) Plotting an example of each type and counting triangles, quadrangles, pentagons, and hexagons, respectively, one finds that the four types correspond, in this order, to the types O, I, II, and III in the terminology of M. Yoshida [Yo, Chapter VII, Table in Section 8.1].

6. REAL AND COMPLEX MULTIPLICATION. HODGE STRUCTURES

The concepts.

Definition 6.1 (Deligne). i) A (pure \mathbb{Q} -) *Hodge structure* of weight i is a finite dimensional \mathbb{Q} -vector space V together with a decomposition

$$V_{\mathbb{C}} := V \otimes_{\mathbb{Q}} \mathbb{C} = H^{0,i} \oplus H^{1,i-1} \oplus \dots \oplus H^{i,0},$$

having the property that $\overline{H^{m,n}} = H^{n,m}$ for every $m, n \in \mathbb{Z}_{\geq 0}$ such that $m + n = i$.

A *morphism* $f: V \rightarrow V'$ of (pure \mathbb{Q} -) *Hodge structures* is a \mathbb{Q} -linear map such that $f_{\mathbb{C}}: V_{\mathbb{C}} \rightarrow V'_{\mathbb{C}}$ respects the decompositions.

ii) A *polarisation* on a pure \mathbb{Q} -Hodge structure V of even weight is a nondegenerate symmetric bilinear form $(\cdot, \cdot): V \times V \rightarrow \mathbb{Q}$ such that its \mathbb{C} -bilinear extension $(\cdot, \cdot): V_{\mathbb{C}} \times V_{\mathbb{C}} \rightarrow \mathbb{C}$ satisfies the two conditions below.

- One has $(x, y) = 0$ for all $x \in H^{m,n}$ and $y \in H^{m',n'}$ such that $m \neq n'$.
- The inequality $i^{m-n}(x, \bar{x}) > 0$ is true for every $0 \neq x \in H^{m,n}$.

Remark 6.2. The weight i Hodge structures form an abelian category [De71, 2.1.11]. Furthermore, the subcategory of polarisable Hodge structures is semisimple [De71, Lemme 4.2.3.i)]. I.e., every sub-Hodge structure of a polarisable Hodge structure is a direct summand. Thus, every polarisable Hodge structure can be written as a direct sum of indecomposable subobjects, which are called *primitive* Hodge structures.

Definition 6.3 (Zarhin). A *Hodge structure of K3 type* is a primitive polarisable Hodge structure of weight 2 such that $\dim_{\mathbb{C}} H^{2,0} = 1$.

Examples 6.4. Let X be a compact complex manifold that is Kähler.

i) Then $H^j(X, \mathbb{Q})$ is naturally a polarisable pure \mathbb{Q} -Hodge structure of weight j .

ii) For X a K3 surface, the *transcendental part* $T := (\text{Pic } X \otimes_{\mathbb{Z}} \mathbb{Q})^{\perp} \subset H^2(X, \mathbb{Q})$ is a Hodge structure of K3 type. Indeed, if T would split off a direct summand T' then, without restriction, one had $T'^{2,0} = 0$. But this yields, according to the Lefschetz (1, 1)-Theorem, T' that must be contained in the algebraic part, a contradiction.

Proposition 6.5 (Zarhin). *Let T be a Hodge structure of K3 type.*

i) *Then $E := \text{End}_{\text{Hodge}}(T)$ is either a totally real field or a CM field.*

ii) *Suppose that T is equipped with a polarisation (\cdot, \cdot) . Then every $\varphi \in E$ operates as a self-adjoint mapping, i.e. $(\varphi(x), y) = (x, \bar{\varphi}(y))$ for $\bar{\cdot}$ the identity map in the case that E is totally real and the complex conjugation in the case that E is a CM field.*

Proof. Assertion i) is [Za, Theorem 1.6.a)], while assertion ii) is [Za, Theorem 1.5.1]. \square

Real and complex multiplication—Our terminology.

Definition 6.6 (RM and CM). Let $T \subset H^2(X, \mathbb{Q})$ be the transcendental part of the cohomology of a complex K3 surface X .

i) If $\text{End}_{\text{Hodge}}(T) \supsetneq \mathbb{Q}$ is a totally real field then X is said to have *real multiplication*.

ii) If $\text{End}_{\text{Hodge}}(T)$ is CM then we speak of *complex multiplication*.

Remark 6.7. For complex multiplication, some authors, e.g. L. Taelman [Tae], require, in addition, that $\dim_{\text{End}_{\text{Hodge}}(T)} T = 1$. However, for our purposes, the definition above appears to be more practical.

Remark 6.8. It is a rather common phenomenon that only a subfield of the endomorphism field $\text{End}_{\text{Hodge}}(T)$ is known. Moreover, if the generic member of a family of $K3$ surfaces has real or complex multiplication by a certain field K then for particular members the endomorphism field may well be larger, cf. Corollary 6.30, below. We introduce the terminology below in order to cope with such situations.

Definition 6.9 ($T' \supseteq T$ being acted upon by some field).

Let X be a $K3$ surface and $T' \subseteq H^2(X, \mathbb{Q})$ be a subvector space such that $T' \supseteq T$, for $T \subset H^2(X, \mathbb{Q})$ the transcendental part. We say that T' is *acted upon* by a field K , if there is a ring homomorphism $K \rightarrow \text{End}_{\text{Hodge}}(T')$ taking 1 to $\text{id}_{T'}$.

Remarks 6.10. i) In the situation of Definition 6.9, T' is automatically a sub-Hodge structure of $H^2(X, \mathbb{Q})$.

ii) If T' is acted upon by K then T is clearly acted upon by K .

Moreover, if T is acted upon by $K \not\supseteq \mathbb{Q}$ then X has real or complex multiplication by K or an extension field of K .

Arithmetic effects caused by real or complex multiplication.

Definition 6.11. Let X be an algebraic $K3$ surface defined over a field k that is finitely generated over \mathbb{Q} . Then we say that X has *real multiplication* or *complex multiplication* by a number field E if, for a certain embedding $k \hookrightarrow \mathbb{C}$ of fields, the complex $K3$ surface $X(\mathbb{C}) = (X \times_{\text{Spec } k} \text{Spec } \mathbb{C})(\mathbb{C})$ has.

Remark 6.12. This is independent of the choice of an embedding $k \hookrightarrow \mathbb{C}$ [EJ20, Corollary 4.2]. The endomorphism field itself is independent, for $\dim_{\mathbb{Q}} T < 7$ [EJ20, Corollary 4.2.b)] or when k is primary [EJ20, Corollary 4.4].

For a $K3$ surface over a number field, the properties of RM and CM cause a particular *arithmetic* behaviour. We summarise the known effects below.

Notation 6.13. Let X be a $K3$ surface over \mathbb{Q} and p a prime number. We say that X has *good reduction* at p , if there exists a proper model \mathcal{X} of X over \mathbb{Z} , the reduction $X_p := \mathcal{X}_p$ modulo p of which is again a $K3$ surface. In this case, for $f \in \mathbb{N}$, we let $\chi_{p^f} \in \mathbb{Q}[Z]$ be the characteristic polynomial of $\text{Frob}^f \in \text{Gal}(\overline{\mathbb{F}}_p/\mathbb{F}_p)$ on $H_{\text{ét}}^2((X_p)_{\overline{\mathbb{F}}_p}, \mathbb{Q}_l(1))$ [De74, Théorème 1.6].

We factorise χ_{p^f} completely in the form

$$\chi_{p^f}(Z) = \chi_{p^f}^{\text{tr}}(Z) \cdot \prod_{i=1}^d (Z - \zeta_{k_i}^{e_i}),$$

for $k_1, \dots, k_d \in \mathbb{N}$. I.e. in such a way that $\chi_{p^f}^{\text{tr}} \in \mathbb{Q}[Z]$ does not have any further zeroes being roots of unity.

According to the Tate conjecture [MP, KM], $\chi_{p^f}^{\text{tr}}$ is the characteristic polynomial of Frob^f on the transcendental part of $H_{\text{ét}}^2(X_{\overline{\mathbb{F}}_p}, \mathbb{Q}_l(1))$. Let us note, in particular, that $\deg \chi_{p^f}^{\text{tr}} = 22 - \text{rk Pic } X_{\overline{\mathbb{F}}_p}$.

Proposition 6.14 (Some arithmetic effects of real or complex multiplication).

Let X be a K3 surface over \mathbb{Q} . Suppose that X has real or complex multiplication by a number field E . Let, moreover, p be a prime of good reduction.

A) Then $\text{rk Pic}(X_p)_{\overline{\mathbb{F}}_p} - \text{rk Pic } X(\mathbb{C})$ is divisible by $[E:\mathbb{Q}]$.

B) Assume that $E \supseteq \mathbb{Q}(\sqrt{\delta})$, for a non-square $\delta \in \mathbb{Q}^*$.

a) Then one of the following is true. Either χ_p^{tr} splits over $\mathbb{Q}(\sqrt{\delta})$. Or, for a certain $f > 0$, the polynomial $\chi_{p^f}^{\text{tr}}$ is a square.

b) If the prime p is inert in $\mathbb{Q}(\sqrt{\delta})$ then the reduction X_p is non-ordinary. I.e., one has that $\#X_p(\mathbb{F}_p) \equiv 1 \pmod{p}$.

Proof. A) This result appears between the lines of F. Charles' famous article [Ch], but was not explicitly stated. A proof is provided in [EJ20, Lemma 6.2].

B) Assertion B.a) is shown in [EJ14, Theorem 4.9], while B.b) is [EJ14, Corollary 4.13.i)]. \square

Proposition 6.15 (Sufficient criterion for real or complex multiplication).

Let $a, D \in \mathbb{Z}$ be such that $\gcd(a, D) = 1$ and X a K3 surface over \mathbb{Q} . Suppose that $\#X_p(\mathbb{F}_p) \equiv 1 \pmod{p}$ for every good prime $p \equiv a \pmod{D}$. Then X has real or complex multiplication.

Proof. This is [EJ14, Lemma 6.1]. \square

Remark 6.16. A relative version of Proposition 6.15 is established in [EJ20, Theorem 3.5].

Some known examples I.

Example 6.17. Let f_4 be a homogeneous quartic form in three variables that defines a regular curve $C \subset \mathbf{P}^2$. Then the fourfold cover $X: w^4 = f_4(x, y, z)$ ramified at C is a K3 surface of degree 4 and Picard rank at least 8. It has an automorphism, given by

$$I: (w:x:y:z) \mapsto (iw:x:y:z).$$

Moreover, there is a 14-dimensional subvector space $T' \subset H^2(X, \mathbb{Q})$ containing T that is acted upon by $\mathbb{Q}(\sqrt{-1})$. I.e., X has complex multiplication by $\mathbb{Q}(\sqrt{-1})$ or by a field that properly contains $\mathbb{Q}(\sqrt{-1})$.

Proof. The automorphism $J := I \circ I$ is of order 2 and has the curve C as its fixed point set. The genus of C is 3, hence the topological Euler characteristic is equal to (-4) . Therefore, the Lefschetz trace formula [Ed, Theorem 8.5], cf. [SGA5, Exposé III, formule (4.11.3)], shows that $\text{Tr } J|_{H^2(X, \mathbb{Q})} = -6$. In other words, $J|_{H^2(X, \mathbb{Q})}$ has the eigenvalue 1 with multiplicity 8, while the eigenvalue (-1) occurs with multiplicity 14.

On the other hand, X is a double cover of the degree two del Pezzo surface X' , given by $w^2 = f_4(x, y, z)$. One has $\text{Pic } X' \cong \mathbb{Z}^8$ and the natural homomorphism $\pi^*: \text{Pic } X' \rightarrow \text{Pic } X$ is an injection, as it doubles all intersection numbers. Thus, J acts nontrivially, with only eigenvalue (-1) , on the 14-dimensional orthogonal complement of $\text{im}(\pi^*: H^2(X', \mathbb{Q}) \rightarrow H^2(X, \mathbb{Q}))$. \square

Example 6.18. Let f_2 and f_3 be homogeneous forms in four variables such that the subscheme $X \subset \mathbf{P}^4$, given by $f_2(x, y, z, u) = 0$ and $v^3 = f_3(x, y, z, u)$ is regular. Then X is a $K3$ surface of degree 6. It has an automorphism, given by

$$I: (v:x:y:z:u) \mapsto (\zeta_3 v:x:y:z:u).$$

Moreover, there is a 20-dimensional subvector space $T' \subset H^2(X, \mathbb{Q})$ containing T that is acted upon by $\mathbb{Q}(\sqrt{-3})$.

Proof. The automorphism I is of order 3 and has the curve

$$C: f_2(x, y, z, u) = f_3(x, y, z, u) = 0, v = 0,$$

as its fixed point set. This is a canonical curve of genus 4, such that the Lefschetz trace formula yields $\text{Tr } J|_{H^2(X, \mathbb{Q})} = -8$. In other words, the eigenvalue 1 has multiplicity 2, while the eigenvalues ζ_3 and ζ_3^{-1} both occur with multiplicity 10.

On the other hand, X is a threefold cover of the space quadric, given by $X': f_2(x, y, z, u) = 0$. One has $\text{Pic } X' \cong \mathbb{Z}^2$ and the natural homomorphism $\text{Pic } X' \rightarrow \text{Pic } X$ is an injection, tripling all intersection numbers. Thus, J acts nontrivially, with eigenvalues only ζ_3 and ζ_3^{-1} , on the 20-dimensional orthogonal complement of the image of $H^2(X', \mathbb{Q})$ in $H^2(X, \mathbb{Q})$.

Example 6.19. Let f_6 be a homogeneous sextic form in three variables that defines a regular curve $C \subset \mathbf{P}^2$. Then the double cover $X: w^2 = f_6(x, y, z)$ ramified at C is a $K3$ surface of degree 2. Suppose that $f_6(x, y, z) = \zeta_3 f_6(y, z, x)$. Then X has an automorphism, given by

$$I: (w, x:y:z) \mapsto (\zeta_6 w, y:z:x).$$

Moreover, there is a 14-dimensional subvector space $T' \subset H^2(X, \mathbb{Q})$ containing T that is acted upon by $\mathbb{Q}(\sqrt{-3})$. I.e., X has complex multiplication either by $\mathbb{Q}(\sqrt{-3})$ or by a field that contains $\mathbb{Q}(\sqrt{-3})$. Furthermore, $\text{rk Pic } X \geq 8$.

Proof. The automorphism $J := I \circ I \circ I$ of X is of order 2 and has the curve C as its fixed point set. The genus of C is 10, hence the topological Euler characteristic is equal to (-18) . Therefore, the Lefschetz trace formula shows that $\text{Tr } J|_{H^2(X, \mathbb{Q})} = -20$. This means that J acts nontrivially, with only eigenvalue (-1) , on the 21-dimensional orthogonal complement of the inverse image of a general line on \mathbf{P}^2 . Consequently, I acts on this space with eigenvalues at most (-1) , ζ_6 , and ζ_6^{-1} .

On the other hand, the fixed point set of I is $\{(0, 1:1:1), (0, 1:\zeta_6^2:\zeta_6^4), 0, 1:\zeta_6^4:\zeta_6^2\}$, which yields that $\text{Tr } I|_{H^2(X, \mathbb{Q})} = 1$. Consequently, each of the eigenvalues (-1) , ζ_6 , and ζ_6^{-1} occurs with multiplicity 7. The direct sum of the eigenspaces for ζ_6 , and ζ_6^{-1} has the property required. Finally, the assertion on the Picard rank follows from [Za, Theorem 1.4.1]. \square

Example 6.20. Let f_5 be a homogeneous quintic form in three variables that defines a regular curve $C \subset \mathbf{P}^2$. Suppose that $C \cap V(z)$ consists of five distinct points. Then the minimal desingularisation X of the double cover $X': w^2 = zf_5(x, y, z)$ is a $K3$ surface of Picard rank at least 6. Suppose that $f_5(x, y, -z) = f_5(x, y, z)$. Then X has an automorphism, given by

$$I: (w, x:y:z) \mapsto (iw, x:y:-z).$$

Moreover, there is a 16-dimensional subvector space $T' \subset H^2(X, \mathbb{Q})$ containing T that is acted upon by $\mathbb{Q}(\sqrt{-1})$. I.e., X has complex multiplication either by $\mathbb{Q}(\sqrt{-1})$ or by a field that contains $\mathbb{Q}(\sqrt{-1})$.

Proof. Here, the automorphism $J := I \circ I$ of X is of order 2. Its fixed point set is the union of the strict transforms of C and $V(z)$ in \mathbf{P}^2 , blown up in the five points of $C \cap V(z)$. Note that this is a disjoint union. As the genera of C and $V(z)$ are 6 and 0, the topological Euler characteristic of $C \cup V(z)$ is equal to $(-10) + 2 = (-8)$. Thus, the Lefschetz trace formula implies $\text{Tr } J|_{H^2(X, \mathbb{Q})} = -10$. This means that J acts nontrivially, with only eigenvalue (-1) , on the 16-dimensional orthogonal complement of the span of the five exceptional curves and the inverse image of a general line on \mathbf{P}^2 . \square

Remark 6.21. More generally, when a $K3$ surface X has an automorphism of finite order that operates nontrivially on $H^{2,0}(X)$ then X has complex multiplication. More precisely, $T \subset H^2(X, \mathbb{Q})$ is acted upon by a cyclotomic field. Such $K3$ surfaces have been intensively studied, there is even a classification for the case that the order is a prime number. The interested reader is advised to consult the article [AST] and the references given therein.

Some known examples II.

Real multiplication tends to be more complicated than complex multiplication. In particular, no examples are known, in which real multiplication occurs due to an automorphism. Instead, the examples presented below were found searching extensively for $K3$ surfaces showing the arithmetic abnormalities predicted by Proposition 6.14.

Example 6.22 (A family of $K3$ surfaces for which RM by $\mathbb{Q}(\sqrt{2})$ is established). Let $q: \mathfrak{X} \rightarrow B$, for $B := \text{Spec } \mathbb{Q}[T, \frac{1}{T(T^2-2)(T^2+2)(T^2-4T+2)(T^2+4T+2)}] \subset \mathbf{A}_{\mathbb{Q}}^1$, be the family of $K3$ surfaces, the fibre at $t \in B$ of which is the minimal desingularisation of the double cover of \mathbf{P}^2 , given by

$$w^2 = [(\frac{1}{8}t^2 - \frac{1}{2}t + \frac{1}{4})y^2 + (t^2 - 2t + 2)yz + (t^2 - 4t + 2)z^2] \\ [(\frac{1}{8}t^2 + \frac{1}{2}t + \frac{1}{4})x^2 + (t^2 + 2t + 2)xz + (t^2 + 4t + 2)z^2][2x^2 + (t^2 + 2)xy + t^2y^2].$$

- i) Then the geometric generic fibre $\mathfrak{X}_{\bar{\eta}}$ of q is of Picard rank 16.
- ii) For every $\theta \in B(\mathbb{C})$, the transcendental part $T \subset H^2(\mathfrak{X}_{\theta}(\mathbb{C}), \mathbb{Q})$ of the cohomology of the fibre $\mathfrak{X}_{\theta}(\mathbb{C})$ of the holomorphic submersion $q(\mathbb{C}): \mathfrak{X}(\mathbb{C}) \rightarrow B(\mathbb{C})$ is acted upon by $\mathbb{Q}(\sqrt{2})$.

iii) Let the complex point $\theta \in B(\mathbb{C})$ be of the kind that the fibre $\mathfrak{X}_\theta(\mathbb{C})$ of $q(\mathbb{C})$ has Picard rank 16. Then $\mathfrak{X}_\theta(\mathbb{C})$ has real multiplication by $\mathbb{Q}(\sqrt{2})$.

Proof. This is [EJ20, Example 5.1]. The family was presented in [EJ14] for the first time. \square

Remark 6.23. For $\theta \in \mathbb{Q}$, the field of definition of the Picard group is $\mathbb{Q}(\sqrt{2})$, too.

Example 6.24 (A family of $K3$ surfaces for which RM by $\mathbb{Q}(\sqrt{5})$ is established). Let $q: \mathfrak{X} \rightarrow B$, for $B := \text{Spec } \mathbb{Q}[T, \frac{1}{(T-1)(T^4-T^3+T^2-T+1)}] \subset \mathbf{A}_{\mathbb{Q}}^1$, be the family of $K3$ surfaces, the fibre at $t \in B$ of which is the minimal desingularisation of the double cover of \mathbf{P}^2 , given by

$$w^2 = y(x - 2(t-1)y - tz) \\ (x^4 + x^3y - x^3z + x^2y^2 - 2x^2yz + x^2z^2 + xy^3 - 3xy^2z - 2xyz^2 - xz^3 + y^4 \\ + y^3z + y^2z^2 + yz^3 + z^4).$$

i) Then the generic fibre \mathfrak{X}_η of q is of geometric Picard rank 16.

ii) For every $\theta \in B(\mathbb{C})$, the transcendental part $T \subset H^2(\mathfrak{X}_\theta(\mathbb{C}), \mathbb{Q})$ of the cohomology of the fibre \mathfrak{X}_θ is acted upon by $\mathbb{Q}(\sqrt{5})$.

iii) Let the complex point $\theta \in B(\mathbb{C})$ be of the kind that the fibre \mathfrak{X}_θ has geometric Picard rank 16. Then \mathfrak{X}_θ has real multiplication by $\mathbb{Q}(\sqrt{5})$.

Proof. This is [EJ20, Example 1.5]. \square

Remark 6.25. Here, for $\theta \in \mathbb{Q}$, the field of definition of the Picard group is $\mathbb{Q}(\zeta_5)$.

Remarks 6.26. i) Several further families have been found, for the generic members of which there is strong evidence for real multiplication by specific fields, including $\mathbb{Q}(\sqrt{2})$, $\mathbb{Q}(\sqrt{3})$, and $\mathbb{Q}(\sqrt{5})$. Furthermore, there are isolated examples that conjecturally have complex multiplication by $\mathbb{Q}(\sqrt{-1}, \zeta_7 + \zeta_7^{-1})$, $\mathbb{Q}(\sqrt{-1}, \zeta_9 + \zeta_9^{-1})$, and $L(\sqrt{-1})$, respectively, for $L \subset \mathbb{Q}(\zeta_{19})$ the unique cubic subfield. Explicit equations are given in [EJ16, Conjecture 5.2.b)].

For each of these surfaces, it has been verified that the arithmetic effects caused by real or complex multiplication (cf. Proposition 6.14) occur for all primes $p < 500$. This required fast algorithms for point counting on algebraic surfaces over finite fields, cf. [Ha] or [EJ16] for the main ideas behind them. By now, an implementation of the method we used is available to the public, as the `magma` intrinsic `WeilPolynomialOfDegree2K3Surface`.

ii) Moreover, there are a few isolated examples for $\mathbb{Q}(\sqrt{13})$. For instance, there is the following.

Example 6.27. Let X be the minimal desingularisation of the double cover of \mathbf{P}^2 , given by

$$w^2 = (x - 4z)(5x - 9y - 8z)f_4(x, y, z),$$

for $f_4 := x^4 - 2x^3y - 5x^2y^2 - 26x^2z^2 + 6xy^3 + 104xyz^2 + 9y^4 - 130y^2z^2 + 52z^4$.

i) Then X is a $K3$ surface over \mathbb{Q} of geometric Picard rank 16.

ii) There is strong evidence that $X(\mathbb{C})$ has real multiplication by $\mathbb{Q}(\sqrt{13})$.

Proof of i). The quartic form f_4 is the norm of a linear form over the cyclic quartic number field

$$K = \mathbb{Q}(\sqrt{13 - 3\sqrt{13}})$$

of conductor $8 \cdot 13 = 104$. Thus, the branch locus is the union of six lines in general position. This shows that $\text{rk Pic } X_{\overline{\mathbb{Q}}} \geq 16$, while an upper bound of 17 may, once again, be obtained using van Luijk's method. Let us note that X has bad reduction only at the primes 2, 3, and 13.

In order to verify that $\text{rk Pic } X_{\overline{\mathbb{Q}}} \neq 17$, a modification of the method described in [EJ11] applies. Indeed, the $\text{Gal}(\overline{\mathbb{Q}}/\mathbb{Q})$ -representation $H_{\text{ét}}^2((X_p)_{\overline{\mathbb{F}}_p}, \overline{\mathbb{Q}}_l(1))$ splits into a direct summand of dimension 16 corresponding to the obvious rank 16 part of $\text{Pic } X_{\overline{\mathbb{Q}}}$ and a complement V_6 . Geometric Picard rank 17 would cause a free \mathbb{Z} -module of rank one being contained in V_6 that is acted upon by $\text{Gal}(\overline{\mathbb{Q}}/\mathbb{Q})$. However, the characteristic polynomial of Frob_5 on V_6 turns out to be $(Z^2 + 1)(Z^4 - \frac{2}{5}Z^2 + 1)$. Thus, there is no eigenvalue ± 1 , which is a contradiction. \square

ii) Evidence for real multiplication is as follows. For every good prime $p < 500$, the characteristic polynomial χ_p^{tr} splits over $\mathbb{Q}(\sqrt{13})$ or $\chi_{p^2}^{\text{tr}}$ is a square, as predicted by Proposition 6.14.B.a). Moreover, for every good prime $p \equiv 2, 5, 6, 7, 8, 11 \pmod{13}$ up to 1000, one has $\#X(\mathbb{F}_p) \equiv 1 \pmod{p}$, cf. Proposition 6.14.B.b). In fact, $\#X'(\mathbb{F}_p) = p^2 + p + 1$ for X' the double cover of \mathbf{P}^2 underlying X .

Remark 6.28. For the surface in Example 6.27, the Picard group is defined over $K = \mathbb{Q}(\sqrt{13 - 3\sqrt{13}})$.

Periods of K3 surfaces having real or complex multiplication.

Theorem 6.29. *Let $r \in \{1, \dots, 20\}$ be an integer and κ a perfect pairing on \mathbb{Z}^{22} .*

a) (Periods of the families generically having RM.)

Let K be a totally real number field of degree d . Then there is an at most countable union $M_{K,\kappa,r} \subseteq Q_{\kappa,r}$ of quadrics of dimension $\frac{22-r}{d} - 2$ such that the following holds.

Let $x \in \Omega_{\kappa,r} \subset Q_{\kappa,r}$ be the period point of a marked K3 surface (X, i) , for which $c_k \in H^2(X, \mathbb{Q})$ (cf. 3.7.ii) is algebraic, for $k = 22-r+1, \dots, 22$, and the Picard rank of X is exactly r . Then $T \subset H^2(X, \mathbb{Q})$ is acted upon by K if and only if $x \in M_{K,\kappa,r}$.

b) (Periods of the families generically having CM.)

Let K be a CM field of degree d . Then there is an at most countable union $M_{K,\kappa,r} \subseteq Q_{\kappa,r}$ of projective subspaces of dimension $\frac{22-r}{d} - 1$ such that the following is true.

Let $x \in \Omega_{\kappa,r} \subset Q_{\kappa,r}$ be the period point of a marked K3 surface (X, i) , for which $c_k \in H_2(X, \mathbb{Q})$ (cf. 3.7.ii) is algebraic, for $k = 22-r+1, \dots, 22$, and the Picard rank of X is exactly r . Then $T \subset H^2(X, \mathbb{Q})$ is acted upon by K if and only if $x \in M_{K,\kappa,r}$.

Proof. By Lemma 3.13, one has that $\text{Pic } X = (i(x))^\perp \supseteq \text{span}(c^1, \dots, c^{22-r})^\perp$. However, the assumption $\text{rk Pic} = r$ ensures equality, such that the transcendental lattice of X is $T = (\text{Pic } X \otimes_{\mathbb{Z}} \mathbb{Q})^\perp = \text{span}(c^1, \dots, c^{22-r})$.

a) Being acted upon by the totally real field K means that K operates \mathbb{Q} -linearly on T , keeping the distinguished cohomology class $x_1c^1 + \cdots + x_{22-r}c^{22-r}$ as a simultaneous eigenvector.

For this, take a primitive element $u \in K$. To fix the operation of K , one simply has to choose a self-adjoint endomorphism $U: T \rightarrow T$, whose minimal polynomial is the same as that of u . If this is possible then $d \mid (22 - r)$. Moreover, there are certainly only countably many choices. Thus, let us consider U as being fixed.

Then $U_{\mathbb{R}}$ has d eigenvalues, the numbers $\sigma_1(u), \dots, \sigma_d(u)$, for $\sigma_i: K \rightarrow \mathbb{R}$ the real embeddings, and the eigenspaces E_1, \dots, E_d are of dimension $\frac{22-r}{d}$ each. Since U is self-adjoint, the eigenspaces are perpendicular to each other. In particular, they are non-degenerate quadratic spaces.

To complete the proof, let us note that, for T being acted upon by K , the vector $x_1c^1 + \cdots + x_{22-r}c^{22-r}$ needs to be contained in $E_i \otimes_{\mathbb{R}} \mathbb{C}$, for one of the eigenspaces.

b) Take a primitive element $u \in K$. Similarly to the above, for T being acted upon by the CM field K , one has to choose an endomorphism $U: T \rightarrow T$, whose minimal polynomial is the same as that of u . Again, if this is possible then $d \mid (22 - r)$, and, again, there are only countably many choices, so that we may consider U as being fixed.

Then $U_{\mathbb{C}}$ has d eigenvalues, the numbers $\sigma_1(u), \dots, \sigma_d(u)$, for $\sigma_i: K \rightarrow \mathbb{C}$ the complex embeddings, and the eigenspaces E_1, \dots, E_d are of dimension $\frac{22-r}{d}$ each. And, clearly, for T being acted upon by K , the vector $x_1c^1 + \cdots + x_{22-r}c^{22-r}$ needs to be contained in one of the eigenspaces E_i . This provides us with projective subspaces of dimension $\frac{22-r}{d} - 1$, as desired.

Moreover, U must fulfil, together with the linear map V , associated with \bar{u} , the self-adjointness relation $(U_{\mathbb{C}}(x), y) = (x, V_{\mathbb{C}}(y))$. In particular, for $x \in E_i$, this yields

$$\sigma_i(u)(x, x) = (U_{\mathbb{C}}(x), x) = (x, V_{\mathbb{C}}(x)) = \overline{\sigma_i(u)}(x, x)$$

and hence $(x, x) = 0$, as $\sigma_i(u)$ is certainly non-real, when K is a CM field and u a primitive element. This shows that the projective subspaces $\mathbf{P}(E_i)$, associated with the eigenspaces E_i , are already contained in the quadric $Q_{\kappa, r}$. \square

Corollary 6.30 (Semicontinuity). *Let $r \in \{1, \dots, 20\}$ be an integer and κ a perfect pairing on \mathbb{Z}^{22} .*

a) (RM) *Let K be a totally real number field of degree d . Assume that $\frac{22-r}{d} \geq 3$. Then there is an at most countable union $V_{K, \kappa, r} \subset M_{K, \kappa, r}$ of analytic subsets such that the following is true.*

Let $x \in \Omega_{\kappa, r} \subset Q_{\kappa, r}$ be the period point of a marked K3 surface (X, i) , for which $c_k \in H^2(X, \mathbb{Q})$ (cf. 3.7.ii) is algebraic, for $k = 22 - r + 1, \dots, 22$. Then X has real multiplication by K and $\text{rk Pic } X = r$ if and only if $x \in M_{K, \kappa, r} \setminus V_{K, \kappa, r}$.

b) (CM) *Let K be a CM field of degree d . Assume that $\frac{22-r}{d} \geq 2$. Then there is an at most countable union $V_{K, \kappa, r} \subset M_{K, \kappa, r}$ of analytic subsets such that the following is true.*

Let $x \in \Omega_{\kappa,r} \subset Q_{\kappa,r}$ be the period point of a marked $K3$ surface (X, i) , for which $c_k \in H^2(X, \mathbb{Q})$ (cf. 3.7.ii) is algebraic, for $k = 22 - r + 1, \dots, 22$. Then X has complex multiplication by K and $\text{rk Pic } X = r$ if and only if $x \in M_{K,\kappa,r} \setminus V_{K,\kappa,r}$.

Proof. We present the proof only for a), as that for b) is completely analogous. There are two ways for the property stated on X to fail. Either $\text{rk Pic } X > r$ or $\text{rk Pic } X = r$, but $\text{End}_{\text{Hodge}}(T) \not\supseteq K$.

Case 1: $\text{rk Pic } X > r$.

This means that, besides the linear combinations of $c_{22-r+1}, \dots, c_{22}$, a further cohomology class $c \in H^2(X, \mathbb{Z})$ is algebraic. According to Lemma 3.13, that is equivalent to $x \in (i^*c)^\perp$, which clearly defines an analytic subset. As there are only countably many possibilities for c , this case indeed contributes to $V_{K,\kappa,r}$ a countable union of analytic subsets.

Case 2: $\text{rk Pic } X = r$ and $\text{End}_{\text{Hodge}}(T) \not\supseteq K$.

If $\text{End}_{\text{Hodge}}(T) = K' \not\supseteq K$ then $x \in M_{K',\kappa,r}$, which, according to Theorem 6.29.a), defines a countable union of analytic subsets of $M_{K,\kappa,r}$. As there are, up to isomorphism, only countably many number fields, the assertion follows. \square

Remark 6.31. This shows, in particular, the following. As long as the Picard rank remains unchanged, the endomorphism field $\text{End}_{\text{Hodge}}(T)$ cannot shrink under specialisation. This fact actually has been obtained before and in more generality [EJ20, Corollary 4.8]. The restrictive assumption on the Picard ranks is in fact unnecessary.

7. TRACING THE PREIMAGE OF A CURVE IN THE PERIOD SPACE

Remark 7.1. As a particular case of Theorem 6.29.a), we see that in a sufficiently general family of $K3$ surfaces of Picard rank 16, not containing an isotrivial subfamily, those surfaces that are acted upon by a *real* quadratic number field form families over curves $C \subset Y$, cf. [vG, Example 3.4].

Strategy 7.2. Let X be an isolated example of a $K3$ surface that has real multiplication by a quadratic field $\mathbb{Q}(\sqrt{d})$. Assume that X is given as the minimal desingularisation of a double cover of the form (2). The strategy below describes how to find the 1-dimensional family of RM surfaces, X belongs to.

i) Run Algorithm 5.2 on X . The resulting elements $c_{\alpha_1}, \dots, c_{\alpha_6} \in H^2(X, \mathbb{Z})/P$ yield a class of markings on X , as described in Theorem 3.16.

As step v), Algorithm 5.2 includes running Algorithm 5.9. In particular, open neighbourhoods $\mathbb{D} \cong U(a_0) \ni a_0, \dots, \mathbb{D} \cong U(d_0) \ni d_0$ are chosen in such a way that, for every

$$(a, b, c, d) \in U := U(a_0) \times \dots \times U(d_0),$$

no three of the resulting six lines in $\mathbf{P}_{\mathbb{C}}^2$ have a point in common. Thus, any marking i from the class above extends to the whole family over U . There is the associated restricted period map

$$\Pi: U \longrightarrow \mathbf{P}^5(\mathbb{C}), \quad (a, b, c, d) \mapsto \Pi_{X_{(a,b,c,d)}, i_{(a,b,c,d)}},$$

which is independent of the choice of i , cf. Theorem 3.16.c).

ii) Calculate the period point of $X = X_{(a_0, b_0, c_0, d_0)}$, based on Theorem 4.16, using numerical integration, and identify the three linear relations between the six periods that encode real multiplication. These define, together with the quadric induced by the cup product pairing, a conic $C \subset \mathbf{P}^5(\mathbb{C})$ in the restricted period space.

iii) Trace the curve $\Pi^{-1}(C) \subset U \cong \mathbb{D}^4$ using a numerical continuation method [AG].

iv) Use the singular-value decomposition in order to find algebraic relations between the coordinates of the points found. Control, by using Gröbner bases, that they indeed define an irreducible algebraic curve.

We provide a few details on how this strategy was implemented in Remarks 7.5, below.

The result.

Example 7.3. Consider the family of double covers $X'_{(a,b,c,d)}$ of \mathbf{P}^2 , given by

$$w^2 = (x + ay + bz)(x + cy + dz)f_4(x, y, z),$$

for $f_4 := x^4 - 2x^3y - 5x^2y^2 - 26x^2z^2 + 6xy^3 + 104xyz^2 + 9y^4 - 130y^2z^2 + 52z^4$.

a.i) Then the branch locus is the union of six lines, which are in general position for a generic choice of $(a, b, c, d) \in \mathbb{C}^4$.

a.ii) Consider the closed subscheme $C \subset \mathbf{A}^4$, given by the equations

$$\begin{aligned} 0 &= 630\,272a - 11\,421bd^5 + 411\,400bd^3 - 871\,552bd - 272\,976c^2d^2 + 315\,136c^2 \\ &\quad + 98\,982cd^4 - 3\,508\,064cd^2 + 2\,205\,952c + 233\,496d^4 - 6\,409\,856d^2 + 4\,411\,904, \\ 0 &= 78\,784bc - 243bd^4 + 37\,040bd^2 + 110\,528b - 5808c^2d + 2106cd^3 - 319\,792cd \\ &\quad + 4968d^3 - 714\,688d, \\ 0 &= 243bd^6 - 8960bd^4 + 29\,952bd^2 - 26\,624b + 5808c^2d^3 - 11\,648c^2d - 2106cd^5 \\ &\quad + 76\,432cd^3 - 144\,768cd - 4968d^5 + 140\,608d^3 - 259\,584d, \\ 0 &= 2c^3 + 28c^2 - 3cd^2 + 98c - 8d^2 + 104. \end{aligned}$$

Then C is a geometrically irreducible, nonsingular curve of genus 1.

b) Moreover, there is strong evidence that, for generic $(a, b, c, d) \in C(\mathbb{C})$, the $K3$ surface $X_{(a,b,c,d)}$ obtained as the minimal desingularisation of $X'_{(a,b,c,d)}$ is of Picard rank 16 and has real multiplication by $\mathbb{Q}(\sqrt{13})$.

Proof of a). i) Putting $(a, b, c, d) := (0, -4, -9, -8)$, the surface from Example 6.27 is obtained.

ii) This is easily obtained by a calculation in any computer algebra system. The curve C is the result of Strategy 7.2, taking the surface from Example 6.27 as the starting point. \square

Evidence for b). For every prime $p < 500$ and every $(a_0, b_0, c_0, d_0) \in C(\mathbb{F}_p)$ of the kind that $X_{(a_0, b_0, c_0, d_0)}$ is a nonsingular surface over \mathbb{F}_p , the characteristic polynomial χ_p^{tr} either splits over $\mathbb{Q}(\sqrt{13})$ or $\chi_{p^2}^{\text{tr}}$ is a square, as predicted by Proposition 6.14.B.a). Moreover, for every prime $p \equiv 2, 5, 6, 7, 8, 11 \pmod{13}$ up to 1000

and every $(a_0, b_0, c_0, d_0) \in C(\mathbb{F}_p)$, one has that $\#X_{(a_0, b_0, c_0, d_0)}(\mathbb{F}_p) \equiv 1 \pmod{p}$, cf. Proposition 6.14.B.b). To be more precise, $\#X'_{(a_0, b_0, c_0, d_0)}(\mathbb{F}_p) = p^2 + p + 1$. \square

Remark 7.4. The genus 1 curve C has \mathbb{Q} -rational points. Taking any of them as the origin, the Mordell–Weil group of C is isomorphic to \mathbb{Z} .

Remarks 7.5 (Some details on the experiment). i) When running Algorithm 5.9, we used 14 transcendental cohomology classes, which were represented by tori and obtained as explained in Section 4. For numerical integration, the Gauß-Legendre method of degree 30 [i.e. order 60] was applied, using floats of 30 digits.

In step ii) of Algorithm 5.9, we found six singular values within a factor of 100, while the next one was smaller by nine orders of magnitude. In the basis chosen, the cup product form found on P^\perp had coefficients only from $\{\pm 1, \pm \frac{1}{2}, 0\}$, up to errors less than 10^{-10} .

ii) In step iii) of Strategy 7.2, in the language of [AG], we applied a predictor–corrector method. More precisely, we used the Euler predictor [AG, Section 2.2], followed by Newton corrector steps. We did not care too much about rounding errors, as we worked with floats of high precision. Neither did we implement a step length adaptation, but worked, as simply as possible, with a constant step length. For numerical integration, the Gauß-Legendre method of degree 100 [i.e. order 200] was used.

Based on this, we determined a sample of 101 points on $\Pi^{-1}(C) \subset \mathbb{D}^4$, each with a numerical precision of 80 digits. Due to the constant stepsize, these points are essentially equidistant. There are further particularities, caused by the limitations of our approach. First of all, all the points are real. Moreover, they have a limited distance from the starting point, i.e. the parameters of the surface from Example 6.27, because we are forced to stop sampling when approaching the first singular surface along the path.

iii) Polynomials of degree ≤ 3 in four variables form a vector space of dimension 35. When looking for cubic relations between the 101 points found, we ended up with 25 singular values in the range from 1714 to $6.08 \cdot 10^{-41}$, the other ten being less than 10^{-80} . Thus, the curve sought is contained in an intersection of ten cubics in \mathbf{A}^4 . The equations given form a Gröbner basis for the ideal generated by them.

8. EXPLICIT DESCRIPTION OF TRANSCENDENTAL COHOMOLOGY CLASSES— PROOFS OF THE MAIN RESULTS

Almost C^1 -maps. In the application below, it turns out to be convenient to work with the following technical condition on maps between smooth manifolds.

Definition 8.1. A continuous map $\varphi: S \rightarrow X$ between two smooth manifolds is called *almost C^1* , if there exists a auxiliary C^1 -map $\iota: S' \rightarrow S$ being a homeomorphism from another smooth manifold S' that satisfies the following two conditions.

- i) The map $\varphi \circ \iota: S' \rightarrow X$ is C^1 .
- ii) For a suitable Lebesgue null set $N \subset S'$, the restriction $\varphi|_{S \setminus \iota(N)}: S \setminus \iota(N) \rightarrow X$ is C^1 .

Examples 8.2. i) Every C^1 -map between smooth manifolds is almost C^1 .
 ii) The map $\varphi: \mathbb{R} \rightarrow \mathbb{R}, x \mapsto \sqrt[3]{x}$, is almost C^1 .

Remarks 8.3. i) One has that $\iota(N)$ is a Lebesgue null set, according to [Di3, section 16.22, problème 1.c)]. Thus, being almost C^1 implies being C^1 outside of a null set.
 ii) In particular, if $\varphi: S \rightarrow X$ is almost C^1 and η a C^1 differential form on X then the pull-back $\varphi^*\eta$ is defined as a C^1 -form on S , outside of a Lebesgue null set.
 iii) Rather generally, for a differential form ξ that is defined on S , up to a Lebesgue null set \underline{N} , we put $\int_S \xi = \int_{S \setminus \underline{N}} \xi$, as soon as the integral to the right is existing.

From now on, as in the sections above, X always denotes a complex $K3$ surface.

Proposition 8.4. *Let the cohomology class $c_\varphi \in H^2(X, \mathbb{Z})$ be given by a compact oriented 2-manifold S , together with an almost C^1 -map $\varphi: S \rightarrow X$ (cf. Definition 3.1). Moreover, let $w \in H^2(X, \mathbb{C})$ be represented by a closed, smooth 2-form η . Then the extended cup product pairing may be evaluated as the 2-dimensional integral*

$$(c_\varphi, w) = \int_S \varphi^* \eta.$$

Proof. *First step.* The case that φ is C^∞ .

One has $(c_\varphi, w) = \langle w \cup c_\varphi, z_X \rangle = \langle \varphi^*(w), z_S \rangle$, according to the definition of the cup product pairing and the first claim of Lemma 3.4.b). Interpreting the term to the right in the de Rham cohomology theory, one indeed has $\langle \varphi^*(w), z_S \rangle = \int_S \varphi^* \eta$.

Second step. The case that φ is C^1 .

There is a C^1 homotopy $H: S \times [0, 1] \rightarrow X$ connecting φ with a C^∞ -map $\underline{\varphi}$, cf. the proof of [BT, Proposition 17.8]. As homotopic maps induce the same homomorphism on cohomology, one has $c_\varphi = c_{\underline{\varphi}}$ and, therefore, $(c_\varphi, w) = (c_{\underline{\varphi}}, w) = \int_S \underline{\varphi}^* \eta$, according to the first step.

Moreover, the homotopy formula, cf. [Di9, formule (24.2.4.2)], shows that

$$\varphi^* \eta - \underline{\varphi}^* \eta = j_0^* H^* \eta - j_1^* H^* \eta = d(LH^* \eta) + L(dH^* \eta),$$

for $L: E^1(S \times [0, 1]) \rightarrow E^1(S)$ the operator of integration along the fibre. Here, $dH^* \eta = 0$, as the form η is closed. And hence $\int_S \varphi^* \eta - \int_S \underline{\varphi}^* \eta = \int_S d(LH^* \eta) = 0$, due to Stokes' Theorem [Di9, formule (24.14.2.1)].

Third step. The general case that φ is almost C^1 .

Let $\iota: S' \rightarrow S$ be an auxiliary map for φ , as in Definition 8.1. Since ι is a homeomorphism, one has $c_\varphi = \varphi!(1) = \varphi!(\iota!(1)) = (\varphi \circ \iota)!(1) = c_{\varphi \circ \iota}$. Consequently,

$$(c_\varphi, w) = (c_{\varphi \circ \iota}, w) = \int_{S'} (\varphi \circ \iota)^* \eta,$$

according to the step before. The integral to the right is the same as

$$\int_{S' \setminus N} (\varphi \circ \iota)^* \eta = \int_{S' \setminus N} \iota^*(\varphi^* \eta).$$

Note here that φ is C^1 on $\iota(S' \setminus N) = S \setminus \iota(N)$. Since ι is a C^1 -map and bijective, the last integral coincides with $\int_{S \setminus \iota(N)} \varphi^* \eta = \int_S \varphi^* \eta$, as required. \square

The main construction–Technical details. Our idea for the proof of Theorem 4.16 is to apply Proposition 8.4. This means that we have to provide a model of α_Γ , respectively $\alpha_{\Gamma,b}$, allowing a lift to X that is not only continuous, but almost C^1 .

Step 1. 2-dimensional tori from compact 1-manifolds – Adding an imaginary direction.

As before, we extend the C^1 -map $\gamma: \mathbb{R} \rightarrow \mathbb{R}^2 \subset \mathbf{P}^2(\mathbb{R})$ to a C^1 -map in two variables by putting

$$\gamma': \mathbb{R}^2 \longrightarrow \mathbb{C}^2 \subset \mathbf{P}^2(\mathbb{C}), \quad (t, u) \mapsto \gamma(t) + iub.$$

Then $\lim_{t \rightarrow \pm\infty} \gamma'(t, u)$ exists in $\mathbf{P}^2(\mathbb{C})$, for every $u \in \mathbb{R}$. Indeed, this is obvious in the case of a curve encircling a polygon, when simply $\lim_{t \rightarrow \pm\infty} \gamma'(t, u) = \overline{\gamma}(\infty) + iub$. On the other hand, for a deformed line, we have

$$\gamma'(t, u) = \gamma_0(t) + (t+iu)b, \quad (9)$$

γ_0 being of compact support. This shows that, independently of u , the limit is, on $\mathbf{P}^2(\mathbb{C})$, the point on the line at infinity, in the direction of the vector b . Thus, in either case, γ' defines a continuous map γ' from $\mathbf{P}^1(\mathbb{R}) \times \mathbb{R}$ to $\mathbf{P}^2(\mathbb{C})$.

Moreover, $\lim_{u \rightarrow \pm\infty} \underline{\gamma}'(t, u)$ exists in $\mathbf{P}^2(\mathbb{C})$ and is independent of $t \in \mathbf{P}^1(\mathbb{R})$. In all cases, it is the point on the infinite line of $\mathbf{P}^2(\mathbb{C})$ in the direction of the vector $ib \sim b$. Therefore, γ' actually provides a continuous map

$$\alpha': \mathbf{T} = \mathbf{P}^1(\mathbb{R}) \times \mathbf{P}^1(\mathbb{R}) \rightarrow \mathbf{P}^2(\mathbb{C}). \quad (10)$$

Caution 8.5. Here, in the case of a deformed line, for the imaginary direction b , we take the real direction of the deformed line near infinity. In the case of a curve encircling a polygon, the imaginary direction $b \in \mathbb{R}^2 \setminus (\mathbb{R}(A_{12}, -A_{11}) \cup \dots \cup \mathbb{R}(A_{62}, -A_{61}))$ is to be specified later. The actual choice turns out to be irrelevant, cf. Theorem 4.15.

Construction 8.6 (An unusual differential structure on the 2-torus). We equip the topological space $\mathbf{P}^1(\mathbb{R}) \times \mathbf{P}^1(\mathbb{R})$ with the structure of a smooth 2-manifold, in a way that fits our purposes. On the open subset $\mathbf{P}^1(\mathbb{R}) \times \mathbf{P}^1(\mathbb{R}) \setminus \{(\infty, \infty)\}$, we take the natural C^∞ differential structure, given as an open submanifold of the product. We extend this structure to the whole of $\mathbf{P}^1(\mathbb{R}) \times \mathbf{P}^1(\mathbb{R})$, by adding the chart

$$\varphi_{\infty, \infty}: \quad O \longrightarrow \mathbb{R}^2$$

$$((t_0 : t_1), (u_0 : u_1)) \mapsto \begin{cases} (0, 0) & \text{if } (t_0, u_0) = (0, 0), \\ \frac{(t_0, u_0)}{\sqrt[3]{(t_1)^2 + (u_1)^2}} & \text{otherwise,} \end{cases}$$

for $O := \mathbf{P}^1(\mathbb{R}) \times \mathbf{P}^1(\mathbb{R}) \setminus (\mathbf{P}^1(\mathbb{R}) \times \{0\} \cup \{0\} \times \mathbf{P}^1(\mathbb{R})) \subset \mathbf{P}^1(\mathbb{R}) \times \mathbf{P}^1(\mathbb{R})$. It is obvious that the chart $\varphi_{\infty, \infty}$ is compatible with those on

$$\mathbf{P}^1(\mathbb{R}) \times \mathbf{P}^1(\mathbb{R}) \setminus \{(\infty, \infty)\},$$

so that altogether they form a C^∞ -atlas for $\mathbf{P}^1(\mathbb{R}) \times \mathbf{P}^1(\mathbb{R})$.

We denote the C^∞ -manifold obtained in this way by \mathbf{T}' . The identity $\text{id}: \mathbf{T}' \rightarrow \mathbf{T}$ is then a C^∞ -map and a homeomorphism. The restriction

$$\text{id}: \mathbf{T}' \setminus \{(\infty, \infty)\} \rightarrow \mathbf{T} \setminus \{(\infty, \infty)\}$$

is a diffeomorphism.

Lemma 8.7. *The map*

$$\alpha': \mathbf{T} \longrightarrow \mathbf{P}^2(\mathbb{C}),$$

as defined in (10), is almost C^1 . In the case of a curve encircling a polygon, α' is C^1 . Otherwise, α' is C^1 except at the point (∞, ∞) .

Proof. *First case.* Γ is a deformed line.

Then, on $\mathbb{R}^2 \subset \mathbf{T}$, the map α' is given by the formula

$$\begin{aligned} ((t_0:t_1), (u_0:u_1)) &\mapsto \gamma_0\left(\frac{t_1}{t_0}\right) + \left(\frac{t_1}{t_0} + i\frac{u_1}{u_0}\right)b \\ &= \left(1 : \gamma_{0,1}\left(\frac{t_1}{t_0}\right) + \left(\frac{t_1}{t_0} + i\frac{u_1}{u_0}\right)b_1 : \gamma_{0,2}\left(\frac{t_1}{t_0}\right) + \left(\frac{t_1}{t_0} + i\frac{u_1}{u_0}\right)b_2\right) \\ &= \left(t_0u_0 : t_0u_0\gamma_{0,1}\left(\frac{t_1}{t_0}\right) + (t_1u_0 + it_0u_1)b_1 : \right. \\ &\quad \left. : t_0u_0\gamma_{0,2}\left(\frac{t_1}{t_0}\right) + (t_1u_0 + it_0u_1)b_2\right), \end{aligned}$$

which immediately extends to $\mathbf{T} \setminus \{((0:1), (0:1))\} = \mathbf{T} \setminus \{(\infty, \infty)\}$ and defines a C^1 -map on this open subset.

Thus, it remains to show that α' is almost C^1 . We choose $\text{id}: \mathbf{T}' \rightarrow \mathbf{T}$ as the auxiliary map, so that it suffices to verify that $\alpha' \circ \text{id}: \mathbf{T}' \rightarrow \mathbf{P}^2(\mathbb{C})$ is a C^1 -map near (∞, ∞) . For this, it needs to be shown that $\alpha' \circ \varphi_{\infty, \infty}^{-1}$ is C^1 in a neighbourhood of $(0, 0)$. But $\varphi_{\infty, \infty}^{-1}$ sends (x, y) to $((x(x^2 + y^2):1), (y(x^2 + y^2):1))$, so that this map is given by

$$\begin{aligned} (x, y) &\mapsto \left(xy(x^2 + y^2)^2 : xy(x^2 + y^2)^2\gamma_{0,1}\left(\frac{1}{x(x^2 + y^2)}\right) + (y + ix)(x^2 + y^2)b_1 : \right. \\ &\quad \left. : xy(x^2 + y^2)^2\gamma_{0,2}\left(\frac{1}{x(x^2 + y^2)}\right) + (y + ix)(x^2 + y^2)b_2\right) \\ &= \left(xy(x^2 + y^2)^2 : (y + ix)(x^2 + y^2)b_1 : (y + ix)(x^2 + y^2)b_2\right) \\ &= \left(xy(y - ix) : b_1 : b_2\right), \end{aligned}$$

at least in a neighbourhood of the origin. Note here that $\gamma_0 = (\gamma_{0,1}, \gamma_{0,2})$ has compact support. Finally, the function defined by $xy(y - ix)$ is clearly continuously differentiable at $(0, 0)$.

Second case. Γ is a curve encircling a polygon.

Here, for α' , one has a formula that is valid on $\mathbf{P}^1(\mathbb{R}) \times \mathbb{R} \subset \mathbf{T}$,

$$\begin{aligned} ((t_0:t_1), (u_0:u_1)) &\mapsto \bar{\gamma}(t_0:t_1) + i\frac{u_1}{u_0}b \\ &= \left(1 : \bar{\gamma}_1(t_0:t_1) + i\frac{u_1}{u_0}b_1 : \bar{\gamma}_2(t_0:t_1) + i\frac{u_1}{u_0}b_2\right) \\ &= \left(u_0 : u_0\bar{\gamma}_1(t_0:t_1) + iu_1b_1 : u_0\bar{\gamma}_2(t_0:t_1) + iu_1b_2\right). \end{aligned}$$

From this, one sees that α' extends as a C^1 -map to $\mathbf{P}^1(\mathbb{R}) \times \mathbf{P}^1(\mathbb{R})$. Finally, let us note that, by our construction, the identity map $\text{id}: \mathbf{T} \rightarrow \mathbf{P}^1(\mathbb{R}) \times \mathbf{P}^1(\mathbb{R})$ is C^1 . \square

Remark 8.8. According to its definition, given in (9) and (10), the torus α' is constant on $\mathbf{P}^1(\mathbb{R}) \times \{\infty\}$. Contracting this subset, the 2-torus goes over into a 2-sphere with two points identified. Thus, one might possibly work with spheroids instead of tori.

However, for the sphere, it is seemingly much harder to explicitly write down a differential structure that makes the resulting map C^1 , at least in the case of a deformed line. And this is what we need in view of Proposition 8.4, in order to write the periods as integrals.

Step 2. Lifting to the double cover, i.e. to the $K3$ surface X , except at $\mathfrak{t}_1, \dots, \mathfrak{t}_n$.

Notation 8.9. We write $\mathfrak{t}_1, \dots, \mathfrak{t}_n$ for the points $(t_1, 0), \dots, (t_n, 0)$ on \mathbf{T} .

Lemma 8.10. *Assume that b is generic in the sense of Assumption (4) in the case that Γ is a curve encircling a polygon. I.e., that*

$$b \notin \mathbb{R}(A_{12}, -A_{11}) \cup \dots \cup \mathbb{R}(A_{62}, -A_{61}).$$

Then the torus α' meets the branch locus $V(l_1 \cdots l_6)$ only at \mathfrak{t}_i , for $i = 1, \dots, n$. I.e., only in the three to five double points.

Proof. First of all, $\gamma'(t, u) \in V(l_1 \cdots l_6)$ implies that $u = 0$. Indeed, $(x, y) \in V(l_i)$ yields $A_{i1} \operatorname{Im} x + A_{i2} \operatorname{Im} y = 0$. On the other hand, $\operatorname{Im} \gamma'(t, u) = ub = (ub_1, ub_2)$, so that $\gamma'(t, u) \in V(l_i)$ is possible only when $u(A_{i1}b_1 + A_{i2}b_2) = A_{i1}ub_1 + A_{i2}ub_2 = 0$. As $b \notin \mathbb{R}(A_{i2}, -A_{i1})$, one has $A_{i1}b_1 + A_{i2}b_2 \neq 0$ and hence $u = 0$, as required. Thus, the assertion is shown for $\alpha'|_{\mathbb{R}^2}$. In the case of a curve encircling a polygon, the same argument applies to $t = \infty$, too.

Moreover, all points of \mathbf{T} that are not yet covered are mapped under α' to the point of $\mathbf{P}^2(\mathbb{C})$ on the line at infinity, in the direction of the vector $ib \sim b$. This can not be the point at infinity of any of the lines $V(l_i)$, for $i = 1, \dots, 6$. In fact, one has $b \notin \mathbb{R}(A_{12}, -A_{11}) \cup \dots \cup \mathbb{R}(A_{62}, -A_{61})$ in either case. For deformed lines, this is due to Assumption A.iv). \square

Proposition 8.11. a) *Let $\alpha': \mathbf{T} \rightarrow \mathbf{P}^2(\mathbb{C})$ be a torus as above. In the case that Γ is a curve encircling a polygon, assume $b \in \mathbb{R}^2 \setminus (\mathbb{R}(A_{12}, -A_{11}) \cup \dots \cup \mathbb{R}(A_{62}, -A_{61}))$. Then the restriction $\alpha'|_{\mathbf{T} \setminus \{\mathfrak{t}_1, \dots, \mathfrak{t}_n\}}$ allows a continuous lift α'' to the $K3$ surface X .*
 b) *In either case, α'' is automatically almost C^1 .*

Proof. a) *First step.* Reduction to a statement on fundamental groups.

Put $X_0 \subset X$ to be the preimage of $\mathbf{P}^2(\mathbb{C}) \setminus V(l_1 \cdots l_6)$ under the natural map. As X_0 avoids the branch locus and, in particular, the locus that is blown up, the restriction $\pi_0: X_0 \rightarrow \mathbf{P}^2(\mathbb{C}) \setminus V(l_1 \cdots l_6)$ of π is a covering projection [Sp, Chapter 2, Section 1].

The assertion is that $\alpha_0 := \alpha'|_{\mathbf{T} \setminus \{\mathfrak{t}_1, \dots, \mathfrak{t}_n\}}: \mathbf{T} \setminus \{\mathfrak{t}_1, \dots, \mathfrak{t}_n\} \rightarrow \mathbf{P}^2(\mathbb{C}) \setminus V(l_1 \cdots l_6)$ allows a continuous lift α'' , as indicated in the diagram below,

$$\begin{array}{ccc} & & X_0 \\ & \nearrow \alpha'' & \downarrow \pi_0 \\ \mathbf{T} \setminus \{\mathfrak{t}_1, \dots, \mathfrak{t}_n\} & \xrightarrow{\alpha_0} & \mathbf{P}^2(\mathbb{C}) \setminus V(l_1 \cdots l_6). \end{array}$$

In order to establish this claim, according to [Sp, Chapter 2, Theorem 4.5], we have to show that $(\alpha_0)_\# \pi_1(\mathbf{T} \setminus \{\mathbf{t}_1, \dots, \mathbf{t}_n\}, \cdot) \subseteq (\pi_0)_\# \pi_1(X_0, \cdot)$.

For this, let us note that $\pi_1(\mathbf{T} \setminus \{\mathbf{t}_1, \dots, \mathbf{t}_n\}, \cdot)$, the fundamental group of the 2-torus minus n points, is a free group on $(n+1)$ generators. A generating system is provided by the homotopy classes of n small loops $\nu_1, \dots, \nu_n: S^1 \rightarrow \mathbf{T} \setminus \{\mathbf{t}_1, \dots, \mathbf{t}_n\}$, each of which encircles exactly one of the points $\mathbf{t}_1, \dots, \mathbf{t}_n$, together with the homotopy class of the closed path μ_1 running through $\mathbf{P}^1(\mathbb{R}) \times \{\infty\}$ and the homotopy class of the closed path μ_2 running through $\{\infty\} \times \mathbf{P}^1(\mathbb{R})$.

Second step. The small loops.

Let us first show that $(\alpha_0)_\# [\nu_k] \in (\pi_0)_\# \pi_1(X_0, \cdot)$, for $k = 1, \dots, n$. This claim is clearly equivalent to the liftability of the loop $\alpha_0 \circ \nu_k: S^1 \rightarrow \mathbf{P}^2(\mathbb{C}) \setminus V(l_1 \cdots l_6)$ to X_0 . As the particular covering projection $\pi_0: X_0 \rightarrow \mathbf{P}^2(\mathbb{C}) \setminus V(l_1 \cdots l_6)$ is given by $w^2 = l_1 \cdots l_6$, this just means that the loop

$$\begin{aligned} \underline{\nu}_k &= (l_1 \cdots l_6) \circ \alpha_0 \circ \nu_k: S^1 \longrightarrow \mathbb{C} \setminus \{0\}, \\ z &\mapsto (l_1 \cdots l_6)(\alpha_0(\nu_k(z))) \end{aligned}$$

lifts under the covering projection $\mathbb{C} \setminus \{0\} \rightarrow \mathbb{C} \setminus \{0\}, w \mapsto w^2$. And the latter is well-known to be possible if and only if the winding number of $\underline{\nu}_k$ is even.

We may assume that $\nu_k: S^1 \rightarrow \mathbf{T} \setminus \{\mathbf{t}_1, \dots, \mathbf{t}_n\}$ is given by $z \mapsto (t_k + \varepsilon \operatorname{Re} z, \varepsilon \operatorname{Im} z)$, for some real number $\varepsilon > 0$. Then the composition $\alpha_0 \circ \nu_k: S^1 \rightarrow \mathbf{P}^2(\mathbb{C}) \setminus V(l_1 \cdots l_6)$ is

$$\begin{aligned} \alpha_0 \circ \nu_k: (\cos \varphi, \sin \varphi) &\mapsto \gamma(t_k + \varepsilon \cos \varphi) + \varepsilon i \sin \varphi \cdot b \\ &= \gamma(t_{i_k, j_k} + \varepsilon \cos \varphi) + \varepsilon i \sin \varphi \cdot b \\ &= x_{i_k, j_k} + \varepsilon \cos \varphi \cdot b_{i_k, j_k} + \varepsilon i \sin \varphi \cdot b. \end{aligned}$$

Hence, for $a = 1, \dots, 6$, the triple composition $l_a \circ \alpha_0 \circ \nu_k: S^1 \rightarrow \mathbb{C} \setminus \{0\}$ is given by

$$\begin{aligned} l_a \circ \alpha_0 \circ \nu_k: (\cos \varphi, \sin \varphi) &\mapsto l'_a(x_{i_k, j_k} + \varepsilon \cos \varphi \cdot b_{i_k, j_k} + \varepsilon i \sin \varphi \cdot b) \\ &= l'_a(x_{i_k, j_k}) + \tilde{l}_a(\varepsilon \cos \varphi \cdot b_{i_k, j_k} + \varepsilon i \sin \varphi \cdot b) \\ &= l'_a(x_{i_k, j_k}) + \varepsilon \cos \varphi \cdot \tilde{l}_a(b_{i_k, j_k}) + \varepsilon i \sin \varphi \cdot \tilde{l}_a(b). \end{aligned}$$

Here, for $a \neq i_k, j_k$, one has that $x_{i_k, j_k} \notin V(l_a)$, i.e. that $l'_a(x_{i_k, j_k}) \neq 0$. This shows that the winding number of $l_a \circ \alpha_0 \circ \nu_k$ is 0, at least as long as ε is sufficiently small.

On the other hand, for $a = i_k$ or $a = j_k$, clearly $x_{i_k, j_k} \in V(l_a)$, and hence $l'_a(x_{i_k, j_k}) = 0$. Moreover, the constants $\tilde{l}_a(b_{i_k, j_k})$ and $\tilde{l}_a(b)$ are both nonzero. Indeed, for the first, this follows from Assumption A.ii), while, for the second, this is either Assumption A.iv) or Assumption (4). Therefore, the winding number of $l_a \circ \alpha_0 \circ \nu_k$ must be 1 or (-1) . Altogether, the winding number of $\underline{\nu}_k = (l_1 \cdots l_6) \circ \alpha_0 \circ \nu_k$ is an element of $\{-2, 0, 2\}$ and, in particular, even, as claimed.

Third step. The large closed paths.

One has that $\alpha_0 \circ \mu_1$ is a constant map. In the case of a deformed line, $\alpha_0 \circ \mu_2$ is a constant map, too. Therefore, it suffices to consider μ_2 in the case of a curve encircling a polygon. One has to verify that $(\alpha_0)_\# [\mu_2] \in (\pi_0)_\# \pi_1(X_0, \cdot)$, which is equivalent to

the liftability of the closed path $\alpha_0 \circ \mu_2: \mathbf{P}^1(\mathbb{R}) \cong S^1 \rightarrow \mathbf{P}^2(\mathbb{C}) \setminus V(l_1 \cdots l_6)$ to X_0 . For the particular covering projection $\pi_0: X_0 \rightarrow \mathbf{P}^2(\mathbb{C}) \setminus V(l_1 \cdots l_6)$, in exactly the same way as above, this just means to show that the winding number of

$$\begin{aligned} \underline{\mu}_2 = (l_1 \cdots l_6) \circ \alpha_0 \circ \mu_2: \mathbf{P}^1(\mathbb{R}) &\longrightarrow \mathbb{C} \setminus \{0\}, \\ (u_0 : u_1) &\mapsto (l_1 \cdots l_6)(\alpha_0(\mu_2(u_0 : u_1))) \end{aligned}$$

is even.

Assume that $\mu_2: \mathbf{P}^1(\mathbb{R}) \rightarrow \mathbf{T} \setminus \{\mathfrak{t}_1, \dots, \mathfrak{t}_n\}$ is given by $(u_0 : u_1) \mapsto (\infty, (u_0 : u_1))$, for $\infty = (0 : 1)$, as before. Then $\alpha_0 \circ \mu_2: \mathbf{P}^1(\mathbb{R}) \cong S^1 \rightarrow \mathbf{P}^2(\mathbb{C}) \setminus V(l_1 \cdots l_6)$ is

$$\begin{aligned} \alpha_0 \circ \mu_2: (u_0 : u_1) &\mapsto \bar{\gamma}(\infty) + i \frac{u_1}{u_0} b \\ &= (\bar{\gamma}_1(\infty) + i \frac{u_1}{u_0} b_1 : \bar{\gamma}_2(\infty) + i \frac{u_1}{u_0} b_2 : 1) \\ &= (\bar{\gamma}_1(\infty) \cdot u_0 + i b_1 \cdot u_1 : \bar{\gamma}_2(\infty) \cdot u_0 + i b_2 \cdot u_1 : u_0). \end{aligned}$$

Hence, for $a = 1, \dots, 6$, the triple composition $l_a \circ \alpha_0 \circ \mu_2: \mathbf{P}^1(\mathbb{R}) \rightarrow \mathbb{C} \setminus \{0\}$ is given by

$$l_a \circ \alpha_0 \circ \mu_2: (u_0 : u_1) \mapsto l_a(\bar{\gamma}_1(\infty), \bar{\gamma}_2(\infty), 1) \cdot u_0 + i l_a(b_1, b_2, 0) \cdot u_1.$$

Here, both constants, $l_a(\bar{\gamma}_1(\infty), \bar{\gamma}_2(\infty), 1)$ and $l_a(b_1, b_2, 0)$, are nonzero. Indeed, for the first, this follows from Assumption A.i), while, for the second, this is just Assumption (4). Thus, the winding number of $l_a \circ \alpha_0 \circ \mu_2$ is either 1 or (-1) . Altogether, the winding number of $\underline{\mu}_2 = (l_1 \cdots l_6) \circ \alpha_0 \circ \mu_2$ is even, as required. Its absolute value is bounded by 6.

b) The final assertion is an immediate consequence of Lemma 8.7, together with the fact that $\pi_0: X_0 \rightarrow \mathbf{P}^2(\mathbb{C}) \setminus V(l_1 \cdots l_6)$ is a local diffeomorphism. \square

Step 3. Widening the holes of the domain $\mathbf{T} \setminus \{\mathfrak{t}_1, \dots, \mathfrak{t}_n\}$.

Let us first construct a few auxiliary functions.

- We put

$$\psi: [0, \infty) \longrightarrow [0, \infty), \quad r \mapsto \begin{cases} 0 & \text{if } r \leq \frac{1}{2}, \\ 10(r - \frac{1}{2})^2 - 12(r - \frac{1}{2})^3 & \text{if } \frac{1}{2} \leq r \leq 1, \\ r & \text{if } 1 \leq r. \end{cases}$$

As is easily checked, the function ψ is monotonically increasing and C^1 .

- Working in polar coordinates and using ψ , we define

$$\Psi: \mathbb{R}^2 \longrightarrow \mathbb{R}^2, \quad (r, \varphi) \mapsto (\psi(r), \varphi).$$

This is a C^1 -map being the identity outside $U_1(0)$ and contracting $U_{\frac{1}{2}}(0)$ into the origin. Consequently, for $p \in \mathbb{R}^2$,

$$\underline{\Psi}_p: \mathbb{R}^2 \longrightarrow \mathbb{R}^2, \quad x \mapsto p + \Psi(x - p)$$

is C^1 , equal to the identity outside $U_1(p)$, and contracts $U_{\frac{1}{2}}(p)$ to p .

- As $\underline{\Psi}_p$ differs from id only within a compact subset of \mathbb{R}^2 , it extends uniquely to a self-map

$$\Psi_p: \mathbf{T} \rightarrow \mathbf{T}$$

that is again C^1 , contracts $U_{\frac{1}{2}}(p)$ to p and is the identity outside $U_1(p)$.

Construction 8.12 (Widening the holes). For $\alpha'': \mathbf{T} \setminus \{\mathbf{t}_1, \dots, \mathbf{t}_n\} \rightarrow X$, put

$$\alpha''' := \alpha'' \circ (\Psi_{\mathbf{t}_1} \circ \dots \circ \Psi_{\mathbf{t}_n})|_{\mathbf{T} \setminus (\overline{U_{1/2}(\mathbf{t}_1)} \cup \dots \cup \overline{U_{1/2}(\mathbf{t}_n)})}: \mathbf{T} \setminus (\overline{U_{\frac{1}{2}}(\mathbf{t}_1)} \cup \dots \cup \overline{U_{\frac{1}{2}}(\mathbf{t}_n)}) \rightarrow X.$$

Note that the order of the maps $\Psi_{\mathbf{t}_j}$ is irrelevant here, due to Assumption A.iii).

Proposition 8.13. *The almost C^1 -map*

$$\alpha''': \mathbf{T} \setminus (\overline{U_{\frac{1}{2}}(\mathbf{t}_1)} \cup \dots \cup \overline{U_{\frac{1}{2}}(\mathbf{t}_n)}) \rightarrow X$$

allows an extension to the manifold with boundary $\mathbf{T} \setminus (U_{\frac{1}{2}}(\mathbf{t}_1) \cup \dots \cup U_{\frac{1}{2}}(\mathbf{t}_n))$ that is again almost C^1 . It is, in fact, a C^1 -map on $\mathbf{T} \setminus \{(\infty, \infty)\}$.

Proof. By the constructions above, on an annulus around \mathbf{t}_k of inner radius $\frac{1}{2}$ and outer radius 1, the projection $\pi \circ \alpha''': \mathbf{T} \setminus (\overline{U_{\frac{1}{2}}(\mathbf{t}_1)} \cup \dots \cup \overline{U_{\frac{1}{2}}(\mathbf{t}_n)}) \rightarrow \mathbf{P}^2(\mathbb{C})$ is given by

$$(t_k + r \cos \varphi, r \sin \varphi) \mapsto x_{i_k, j_k} + \psi(r) \cos \varphi \cdot b_{i_k, j_k} + i\psi(r) \sin \varphi \cdot b \in \mathbb{C}^2 \subset \mathbf{P}^2(\mathbb{C}).$$

The exceptional curve of the blowup $\text{Bl}_{x_{i_k, j_k}}(\mathbf{P}^2(\mathbb{C}))$ of $\mathbf{P}^2(\mathbb{C})$ in x_{i_k, j_k} is covered by two open subschemes, both of which being affine 2-spaces. The projections down to $\mathbf{P}^2(\mathbb{C})$ are given by $(x', y') \mapsto x_{i_k, j_k} + (x', x'y')$ and $(x', y') \mapsto x_{i_k, j_k} + (x'y', y')$. Let us work in the first chart, the other one being analogous.

Then, on the annulus above, the lift of $\pi \circ \alpha'''$ to $\text{Bl}_{x_{i_k, j_k}}(\mathbf{P}^2(\mathbb{C}))$ is given by

$$\begin{aligned} (t_k + r \cos \varphi, r \sin \varphi) &\mapsto (\psi(r) \cos \varphi \cdot (b_{i_k, j_k})_1 + i\psi(r) \sin \varphi \cdot b_1, \frac{\psi(r) \cos \varphi \cdot (b_{i_k, j_k})_2 + i\psi(r) \sin \varphi \cdot b_2}{\psi(r) \cos \varphi \cdot (b_{i_k, j_k})_1 + i\psi(r) \sin \varphi \cdot b_1}) \\ &= (\psi(r) \cdot (\cos \varphi \cdot (b_{i_k, j_k})_1 + i \sin \varphi \cdot b_1), \frac{\cos \varphi \cdot (b_{i_k, j_k})_2 + i \sin \varphi \cdot b_2}{\cos \varphi \cdot (b_{i_k, j_k})_1 + i \sin \varphi \cdot b_1}). \end{aligned} \quad (11)$$

Here, of course, the denominator in the second coordinate might vanish for certain values of φ . For these values, however, the numerator is nonzero and therefore other chart applies. Indeed, by Assumptions A.ii), A.iv), as well as (4), the vectors b_{i_k, j_k} and b are both real and different from the zero vector.

For $U \subset \{\varphi \in [0, 2\pi) \mid \cos \varphi \cdot (b_{i_k, j_k})_1 + i \sin \varphi \cdot b_1 \neq 0\}$ an open interval, the map (11) clearly extends as a C^1 -map from $(\frac{1}{2}, 1) \times U$ to $[\frac{1}{2}, 1) \times U$. In total, this shows that

$$\pi \circ \alpha'''|_{U_1(\mathbf{t}_k) \setminus \overline{U_{\frac{1}{2}}(\mathbf{t}_k)}}: U_1(\mathbf{t}_k) \setminus \overline{U_{\frac{1}{2}}(\mathbf{t}_k)} \longrightarrow \mathbf{P}^2(\mathbb{C})$$

allows an extension to $U_1(\mathbf{t}_k) \setminus U_{\frac{1}{2}}(\mathbf{t}_k)$ that lifts as a C^1 -map to $\text{Bl}_{x_{i_k, j_k}}(\mathbf{P}^2(\mathbb{C}))$.

We still have to eliminate the projection π , i.e. to lift to the $K3$ surface X . For this, recall that the double cover $\pi': X \rightarrow \text{Bl}_{x_{12}, \dots, x_{56}}(\mathbf{P}^2(\mathbb{C}))$ is a local diffeomorphism outside the branch locus. Moreover, the branch locus on $\text{Bl}_{x_{i_k, j_k}}(\mathbf{P}^2(\mathbb{C}))$ consists of the union of six disjoint curves. Locally near x_{i_k, j_k} , it is the union of the two curves, given by $\tilde{l}_{i_k}(1, y') = 0$ and $\tilde{l}_{j_k}(1, y') = 0$. Thus, to complete the proof, it suffices to show that the image of $U_{\frac{1}{2}}(\mathbf{t}_k)$ does not meet either of the two curves.

For this, let us note first that, by our assumptions, $\tilde{l}_{i_k}(1, y') = 0$ or $\tilde{l}_{j_k}(1, y') = 0$ is possible only when y' is real. Moreover, in the generic case that the vectors b_{i_k, j_k} and b are linearly independent,

$$\frac{\cos \varphi \cdot (b_{i_k, j_k})_2 + i \sin \varphi \cdot b_2}{\cos \varphi \cdot (b_{i_k, j_k})_1 + i \sin \varphi \cdot b_1} \in \mathbb{R}$$

implies that $\cos \varphi = 0$ or $\sin \varphi = 0$. I.e., that

$$y' = \frac{(b_{i_k, j_k})_2}{(b_{i_k, j_k})_1} \quad \text{or} \quad y' = \frac{b_2}{b_1}.$$

But $\tilde{l}_{i_k}(1, \frac{b_2}{b_1}) = 0$ or $\tilde{l}_{j_k}(1, \frac{b_2}{b_1}) = 0$ would mean nothing but $b \in \mathbb{R}(A_{i_k, 2}, -A_{i_k, 1})$ or $b \in \mathbb{R}(A_{j_k, 2}, -A_{j_k, 1})$, which is excluded by Assumption A.iv) or (4), respectively. And

$$\tilde{l}_{i_k}\left(1, \frac{(b_{i_k, j_k})_2}{(b_{i_k, j_k})_1}\right) = 0 \quad \text{or} \quad \tilde{l}_{j_k}\left(1, \frac{(b_{i_k, j_k})_2}{(b_{i_k, j_k})_1}\right) = 0$$

would yield that $b_{i_k, j_k} \in \mathbb{R}(A_{i_k, 2}, -A_{i_k, 1})$ or $b_{i_k, j_k} \in \mathbb{R}(A_{j_k, 2}, -A_{j_k, 1})$, in contradiction with Assumption A.ii).

Finally, in the exceptional case that the vectors b_{i_k, j_k} and b are linearly dependent, one has that $\frac{\cos \varphi \cdot (b_{i_k, j_k})_2 + i \sin \varphi \cdot b_2}{\cos \varphi \cdot (b_{i_k, j_k})_1 + i \sin \varphi \cdot b_1}$ is constantly $\frac{b_2}{b_1}$. But both $\tilde{l}_{i_k}(1, \frac{b_2}{b_1}) = 0$ and $\tilde{l}_{j_k}(1, \frac{b_2}{b_1}) = 0$ are contradictory to our assumptions, as above. \square

Step 4. Extending to the whole of \mathbf{T} .

Proposition 8.14. i) *The almost C^1 -map $\alpha''' : \mathbf{T} \setminus (\overline{U_{\frac{1}{2}}(\mathbf{t}_1)} \cup \dots \cup \overline{U_{\frac{1}{2}}(\mathbf{t}_n)}) \rightarrow X$ allows an extension $\alpha : \mathbf{T} \rightarrow X$ to the whole of \mathbf{T} that is again almost C^1 .*

ii) *The map α may be chosen in such a way that, for each k , the image $\alpha(\overline{U_{\frac{1}{2}}(\mathbf{t}_k)})$ is completely contained in an exceptional curve.*

Proof. We start with the extension $\alpha''' : \mathbf{T} \setminus (U_{\frac{1}{2}}(\mathbf{t}_1) \cup \dots \cup U_{\frac{1}{2}}(\mathbf{t}_n)) \rightarrow X$ that is provided by Proposition 8.13. Then,

$$\alpha'''(\overline{\partial U_{\frac{1}{2}}(\mathbf{t}_k)}) \subset E_{i_k, j_k},$$

for each $k \in \{1, \dots, n\}$, according to our construction. Moreover, for every point $x \in \overline{\partial U_{\frac{1}{2}}(\mathbf{t}_k)}$ and every tangent vector $v \in T_x \mathbf{T}$ that is perpendicular to the boundary and points to the interior of $\mathbf{T} \setminus (U_{\frac{1}{2}}(\mathbf{t}_1) \cup \dots \cup U_{\frac{1}{2}}(\mathbf{t}_n))$, one has

$$T\alpha'''(v) = \vec{0} \in T_{\alpha'''(x)} X.$$

Moreover, as $E_{i_k, j_k} \cong \mathbf{P}^1(\mathbb{C})$ is simply-connected, the modification of [BT, Corollary 17.8.1] for the C^1 -case yields a C^1 -homotopy $H : \overline{\partial U_{\frac{1}{2}}(\mathbf{t}_k)} \times [0, \frac{1}{2}] \rightarrow E_{i_k, j_k}$ connecting

$$H_{\overline{\partial U_{\frac{1}{2}}(\mathbf{t}_k)} \times \{\frac{1}{2}\}} = \alpha'''|_{\overline{\partial U_{\frac{1}{2}}(\mathbf{t}_k)}}$$

with a constant map. Applying a suitable monotonously increasing, bijective C^1 -self-map of $[0, \frac{1}{2}]$, if necessary, one may assume that

$$TH(v) = \vec{0} \in T_{H(x, \frac{1}{2})} E_{i_k, j_k} \quad \text{and} \quad TH(x, v) = \vec{0} \in T_{H(x, 0)} E_{i_k, j_k}$$

for every tangent vector $v \in T_{(x, \frac{1}{2})}(\overline{\partial U_{\frac{1}{2}}(\mathbf{t}_k)} \times [0, \frac{1}{2}])$ or $v \in T_{(x, 0)}(\overline{\partial U_{\frac{1}{2}}(\mathbf{t}_k)} \times [0, \frac{1}{2}])$, respectively, that is perpendicular to the boundary and points to the inside.

Putting, finally,

$$\alpha(tx) := H(x, t)$$

for $x \in \overline{\partial U_{\frac{1}{2}}(\mathbf{t}_k)}$ and $t \in [0, \frac{1}{2}]$, and gluing the maps together, one finds an extension α of α''' with all the properties required. \square

Step 5. Projecting down to X' .

We obtain the torus $\alpha_\Gamma: \mathbf{T} \rightarrow X'$ or $\alpha_{\Gamma, b}: \mathbf{T} \rightarrow X'$, respectively, as the composition $\text{bl} \circ \alpha$.

Remark 8.15. Modifying Definition 8.1 in an obvious way, one defines the concept of an *almost C^∞ -map*. Starting with a C^∞ -parametrisation of the 1-manifold Γ , it is certainly possible to work out the constructions just presented entirely within the setup of almost C^∞ -maps. We prefer the use of almost C^1 -maps, as this approach keeps Steps 3 and 4 slightly simpler.

Periods as improper integrals.

Proof of Theorem 4.16. According to our construction, we may suppose that the lift $\alpha: \mathbf{T} \rightarrow X$ of the torus α_Γ or $\alpha_{\Gamma, b}$ considered is an almost C^1 map. Therefore, Proposition 8.4 applies and shows that $(c_\alpha, [\omega]) = \int_{\mathbf{T}} \alpha^* \omega$.

Moreover, the exceptional curves $E_{i_1, j_1}, \dots, E_{i_n, j_n}$ are holomorphic curves on X . Hence, as ω is a $(2, 0)$ -form, one has that the restrictions $\omega|_{E_{i_k, j_k}}$ are equal to the null form. In particular, $\int_{E_{i_k, j_k}} \omega = 0$. Pulling back, one finds that $\int_{U_{\frac{1}{2}}(\mathbf{t}_k)} \alpha^* \omega = 0$. Since, in addition, $\partial U_{\frac{1}{2}}(\mathbf{t}_k)$ is a Lebesgue null set, this yields

$$(c_\alpha, [\omega]) = \int_{\mathbf{T} \setminus (\overline{U_{1/2}(\mathbf{t}_1)} \cup \dots \cup \overline{U_{1/2}(\mathbf{t}_n)})} \alpha^* \omega = \int_{\mathbf{T} \setminus (\overline{U_{1/2}(\mathbf{t}_1)} \cup \dots \cup \overline{U_{1/2}(\mathbf{t}_n)})} \alpha'''^* \omega = \int_{\mathbf{T} \setminus \{\mathbf{t}_1, \dots, \mathbf{t}_n\}} \alpha''^* \omega = \int_{\mathbf{T} \setminus \{\mathbf{t}_1, \dots, \mathbf{t}_n\}} \alpha''^* \omega'.$$

Furthermore, noticing that $\mathbb{R}^2 \setminus \{\mathbf{t}_1, \dots, \mathbf{t}_n\}$ differs from $\mathbf{T} \setminus \{\mathbf{t}_1, \dots, \mathbf{t}_n\}$ by a Lebesgue null set, we conclude that

$$(c_\alpha, [\omega]) = \int_{\mathbb{R}^2 \setminus \{\mathbf{t}_1, \dots, \mathbf{t}_n\}} (\alpha''|_{\mathbb{R}^2 \setminus \{\mathbf{t}_1, \dots, \mathbf{t}_n\}})^* \omega' = \int_{\mathbb{R}^2} (\alpha''|_{\mathbb{R}^2 \setminus \{\mathbf{t}_1, \dots, \mathbf{t}_n\}})^* \omega'.$$

Finally, a direct calculation of the differential 2-form $(\alpha''|_{\mathbb{R}^2 \setminus \{\mathbf{t}_1, \dots, \mathbf{t}_n\}})^* \omega'$ in terms of the coordinates t and u , making use of formulae (8) and (5), establishes the claim. \square

Independence of the choice of b in the case of a curve encircling a polygon.

Proof of Theorem 4.15. *First step.* Preparations.

By Corollary 4.7, it suffices to show that $\alpha_{\Gamma, \underline{b}}: \mathbf{T} \rightarrow X'$ is homotopic either to $\alpha_{\Gamma, \underline{b}}$ or to $\alpha_{\Gamma, \tilde{\underline{b}}}: \mathbf{T} \rightarrow X'$. Moreover, in doing so, it is clearly sufficient to assume that \underline{b} and $\tilde{\underline{b}}$ lie in neighbouring sectors of the set $\mathbb{R}^2 \setminus (\mathbb{R}(A_{12}, -A_{11}) \cup \dots \cup \mathbb{R}(A_{62}, -A_{61}))$ of admissible vectors.

We let $s_0 \in (0, 1)$ be the unique real number such that $b_0 := \underline{b} + s_0(\underline{b} - \underline{b})$ is not an admissible vector, cf. Figure 4. Furthermore, we denote by $i_0 \in \{\overline{1}, \dots, 6\}$ the index, for which $b_0 \in \mathbb{R}(A_{i_0,2}, -A_{i_0,1})$.

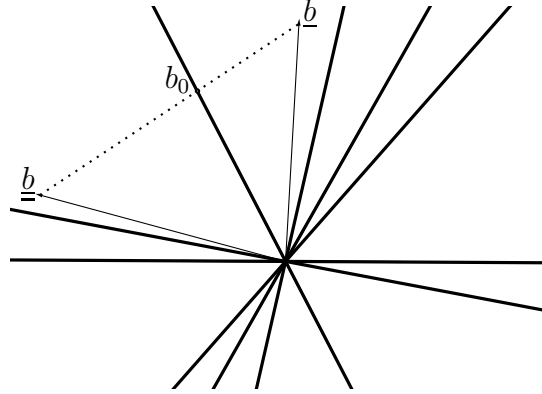

FIGURE 4. The set of admissible vectors

Then, at first, the map

$$\begin{aligned} \underline{H}: \mathbb{R}^2 \times [0, 1] &\longrightarrow \mathbb{C}^2 \subset \mathbf{P}^2(\mathbb{C}), \\ (t, u, s) &\mapsto \gamma(t) + iu[\underline{b} + s(\underline{b} - \underline{b})], \end{aligned}$$

clearly allows an extension to a continuous map

$$H: \mathbf{T} \times [0, 1] \longrightarrow \mathbf{P}^2(\mathbb{C}),$$

which is a homotopy connecting α'_b with $\alpha'_{\underline{b}}$. Moreover, one readily sees that $H^{-1}(V(l_1 \cdots l_6)) = B$, for $B \subset \mathbf{T} \times [0, 1]$ the subset

$$B := (\{t_1\} \times [0, 1]) \cup \dots \cup (\{t_n\} \times [0, 1]) \cup \bigcup_{\substack{k=1, \dots, n \\ l_{i_0}(\gamma(t_k))=0}} (\{t_k\} \times \mathbf{P}^1(\mathbb{R}) \times \{s_0\}).$$

I.e., the map H hits the branch locus $V(l_1 \cdots l_6)$ exactly for the arguments $(t, u, s) \in B$.

There are now two cases to be distinguished. Either, $V(l_{i_0})$ is one of the edges of the polygon encircled by Γ . Then $l_{i_0}(\gamma(t_k)) = 0$ happens exactly two times, say for k_1 and k_2 . In this case, $\gamma(t_{k_1}) = x_{i_{k_1}, j_{k_1}}$ and $\gamma(t_{k_2}) = x_{i_{k_2}, j_{k_2}}$ are the two vertices of the edge $V(l_{i_0})$. Which means that i_0 is one of the indices i_{k_1} and j_{k_1} , as well as one of the indices i_{k_2} and j_{k_2} . We take the ordering such that $t_{k_1} < t_{k_2}$. Moreover, we assume, without loss of generality, that the parametrisation γ is of the kind that $\gamma((t_{k_1}, t_{k_2}))$ is the direct path on Γ from $x_{i_{k_1}, j_{k_1}}$ to $x_{i_{k_2}, j_{k_2}}$, not meeting any other branch point, cf. Figure 5 below.

Or, $V(l_{i_0})$ is not an edge of the polygon. Then $l_{i_0}(\gamma(t_k)) = 0$ does not happen, for any k .

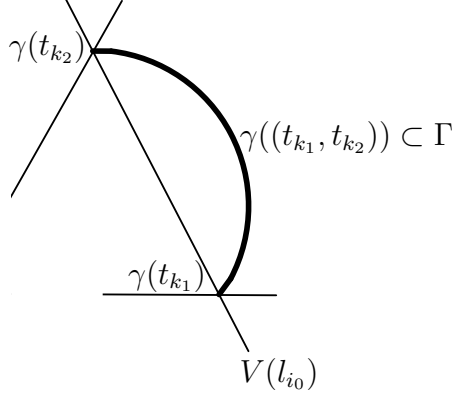

FIGURE 5. The direct path along Γ from $\gamma(t_{k_1})$ to $\gamma(t_{k_2})$

Second step. Lifting to the double cover X' .

As usual, the continuity of a lift of H to X' ,

$$\begin{array}{ccc}
 & & X_0 \subset X' \\
 & \nearrow H' & \downarrow \pi_0 \\
 (\mathbf{T} \times [0, 1]) \setminus B & \xrightarrow{H|_{(\mathbf{T} \times [0, 1]) \setminus B}} & \mathbf{P}^2(\mathbb{C}) \setminus V(l_1 \cdots l_6),
 \end{array}$$

is governed by the image of the fundamental group $\pi_1((\mathbf{T} \times [0, 1]) \setminus B, \cdot)$ under $(H|_{(\mathbf{T} \times [0, 1]) \setminus B})\#$.

By [Sp, Chapter 2, Theorem 4.5], there would be a continuous lift if and only if

$$(H|_{(\mathbf{T} \times [0, 1]) \setminus B})\#\pi_1((\mathbf{T} \times [0, 1]) \setminus B, \cdot) \subseteq (\pi_0)\#\pi_1(X_0, \cdot).$$

So let us consider the fundamental group $\pi_1((\mathbf{T} \times [0, 1]) \setminus B, \cdot)$. It is generated by the homotopy classes $[\nu_1], \dots, [\nu_n]$ of small loops encircling $\{\mathbf{t}_1\} \times [0, 1], \dots, \{\mathbf{t}_n\} \times [0, 1]$, respectively, together with the homotopy class $[\mu_1]$ of a closed path running through $\mathbf{P}^1(\mathbb{R}) \times \{\infty\} \times \{0\}$, and the homotopy class $[\mu_2]$ of the closed path running through $\{\infty\} \times \mathbf{P}^1(\mathbb{R}) \times \{0\}$. In the more interesting case that $V(l_{i_0})$ is one of the edges of the polygon encircled by Γ , two further generators need to be taken into consideration, namely the homotopy classes $[\lambda_{k_1}]$ and $[\lambda_{k_2}]$ of small loops $\lambda_{k_1}, \lambda_{k_2}: S^1 \rightarrow (\mathbf{T} \times [0, 1]) \setminus B$ encircling

$$\{t_{k_1}\} \times \mathbf{P}^1(\mathbb{R}) \times \{s_0\} \quad \text{and} \quad \{t_{k_2}\} \times \mathbf{P}^1(\mathbb{R}) \times \{s_0\},$$

respectively.

One indeed has $(H|_{(\mathbf{T} \times [0, 1]) \setminus B})\#([\nu_k]) \subseteq (\pi_0)\#\pi_1(X_0, \cdot)$, for $k = 1, \dots, n$, as well as $(H|_{(\mathbf{T} \times [0, 1]) \setminus B})\#([\mu_1]) \subseteq (\pi_0)\#\pi_1(X_0, \cdot)$ and $(H|_{(\mathbf{T} \times [0, 1]) \setminus B})\#([\mu_2]) \subseteq (\pi_0)\#\pi_1(X_0, \cdot)$. The calculations showing this are essentially the same as those performed in the second and third steps of the proof of Proposition 8.11.a). Thus, there is no need to repeat them here.

As a conclusion, one finds that H allows a continuous lift $H': \mathbf{T} \times [0, 1] \rightarrow X'$ in the case when $V(l_{i_0})$ is not an edge of the polygon. In particular, in this case, $\alpha_{\Gamma, \underline{b}}$ is homotopic either to $\alpha_{\Gamma, \underline{b}}$ or to $\alpha_{\Gamma, \tilde{\underline{b}}}$, as claimed.

Third step. A discontinuous lift.

On the other hand, $(H|_{(\mathbf{T} \times [0,1]) \setminus B})_{\#}([\lambda_k]) \subseteq (\pi_0)_{\#} \pi_1(X_0, \cdot)$ is *false* for both indices, $k = k_1$ and k_2 . In order to see this, let us restrict considerations to $[\lambda_{k_1}]$, the arguments for the other one being exactly the same. Similarly to the above, we have to show that the winding number of $\underline{\lambda}_{k_1} := (l_1 \cdots l_6) \circ H|_{(\mathbf{T} \times [0,1]) \setminus B} \circ \lambda_{k_1} : S^1 \rightarrow \mathbb{C} \setminus \{0\}$ is odd.

Choose a real number $u_0 \neq 0$ and let $\lambda_{k_1} : S^1 \rightarrow (\mathbf{T} \times [0, 1]) \setminus B$ be given by

$$(\cos \varphi, \sin \varphi) \mapsto (t_{k_1} + \varepsilon \cos \varphi, u_0, s_0 + \varepsilon \sin \varphi),$$

for some real number $\varepsilon > 0$. Then $H|_{(\mathbf{T} \times [0,1]) \setminus B} \circ \lambda_{k_1} : S^1 \rightarrow \mathbf{P}^2(\mathbb{C}) \setminus V(l_1 \cdots l_6)$ is

$$\begin{aligned} H|_{(\mathbf{T} \times [0,1]) \setminus B} \circ \lambda_{k_1} : (\cos \varphi, \sin \varphi) &\mapsto \gamma(t_k + \varepsilon \cos \varphi) + iu_0[\underline{b} + (s_0 + \varepsilon \sin \varphi)(\underline{b} - \underline{b})] \\ &= \gamma(t_k + \varepsilon \cos \varphi) + iu_0[b_0 + \varepsilon \sin \varphi(\underline{b} - \underline{b})] \\ &= x_{i_{k_1}, j_{k_1}} + iu_0 \cdot b_0 + \varepsilon \cos \varphi \cdot b_{i_{k_1}, j_{k_1}} + \varepsilon i \sin \varphi \cdot u_0(\underline{b} - \underline{b}). \end{aligned}$$

Hence, for $a = 1, \dots, 6$, the triple composition $l_a \circ H|_{(\mathbf{T} \times [0,1]) \setminus B} \circ \lambda_{k_1} : S^1 \rightarrow \mathbb{C} \setminus \{0\}$ is given by

$$\begin{aligned} l_a \circ H|_{(\mathbf{T} \times [0,1]) \setminus B} \circ \lambda_{k_1} : (\cos \varphi, \sin \varphi) &\mapsto \\ &l_a(x_{i_{k_1}, j_{k_1}} + iu_0 \cdot b_0 + \varepsilon \cos \varphi \cdot b_{i_{k_1}, j_{k_1}} + \varepsilon i \sin \varphi \cdot u_0(\underline{b} - \underline{b})) \\ &= l'_a(x_{i_{k_1}, j_{k_1}}) + iu_0 \cdot \tilde{l}_a(b_0) + \varepsilon \cos \varphi \cdot \tilde{l}_a(b_{i_{k_1}, j_{k_1}}) + \varepsilon i \sin \varphi \cdot u_0 \tilde{l}_a(\underline{b} - \underline{b}). \end{aligned}$$

Here, for $a \neq i_0$, the real number $\tilde{l}_a(b_0)$ is nonzero. As $l'_a(x_{i_{k_1}, j_{k_1}}) \in \mathbb{R}$, this means that the winding number of $l_a \circ H|_{(\mathbf{T} \times [0,1]) \setminus B} \circ \lambda_{k_1}$ is 0, at least as long as ε is sufficiently small.

On the other hand, $l'_{i_0}(x_{i_{k_1}, j_{k_1}}) = 0$ and $\tilde{l}_{i_0}(b_0) = 0$. Moreover, the constants $\tilde{l}_{i_0}(b_{i_{k_1}, j_{k_1}})$ and $\tilde{l}_{i_0}(\underline{b} - \underline{b})$ are both nonzero. This is due to Assumption A.ii) for the first and obvious for the second. Therefore, the winding number of $l_{i_0} \circ H|_{(\mathbf{T} \times [0,1]) \setminus B} \circ \lambda_{k_1}$ must be 1 or (-1) . Altogether, the winding number of the triple composition $\underline{\lambda}_{k_1} = (l_1 \cdots l_6) \circ H|_{(\mathbf{T} \times [0,1]) \setminus B} \circ \lambda_{k_1}$ is 1 or (-1) and, in particular, odd, as claimed.

As a conclusion, one finds that $H : \mathbf{T} \times [0, 1] \rightarrow \mathbf{P}^2(\mathbb{C})$ does not allow any continuous lift to X' . There is, however, a discontinuous lift

$$H' : \mathbf{T} \times [0, 1] \longrightarrow X'$$

that is continuous on $(\mathbf{T} \times [0, 1]) \setminus ((t_{k_1}, t_{k_2}) \times \mathbf{P}^1(\mathbb{R}) \times \{s_0\})$. The discontinuity is of the kind that, for $(t, u) \in \mathbf{T}$ such that $t \in (t_{k_1}, t_{k_2})$, the limit $\alpha_{\Gamma, b_0}^+(t, u) := \lim_{s \rightarrow s_0+0} H'(t, u, s)$ differs from $\alpha_{\Gamma, b_0}^-(t, u) := \lim_{s \rightarrow s_0-0} H'(t, u, s)$ by the involution ζ .

In particular, H' provides us with two homotopies, one connecting $\alpha_{\Gamma, \underline{b}}$ with α_{Γ, b_0}^- and another, connecting $\alpha_{\Gamma, \underline{b}}$ or $\alpha_{\Gamma, \tilde{\underline{b}}}$ with α_{Γ, b_0}^+ .

Fourth step. Straightening the 1-manifold Γ .

It is thus our remaining task to show that α_{Γ, b_0}^+ and $\alpha_{\Gamma, b_0}^- : \mathbf{T} \rightarrow X'$ are homotopic to each other. For this, consider the following,

$$\underline{D} : \mathbf{P}^1(\mathbb{R}) \times \mathbb{R} \times [0, 1] \longrightarrow \mathbb{C}^2 \subset \mathbf{P}^2(\mathbb{C}),$$

$$(t, u, s) \mapsto \begin{cases} s \left(\frac{t_{k_2} - t}{t_{k_2} - t_{k_1}} \gamma(t_{k_1}) + \frac{t - t_{k_1}}{t_{k_2} - t_{k_1}} \gamma(t_{k_2}) \right) \\ \quad + (1 - s) \gamma(t) + iu \cdot b_0 & \text{if } t \in (t_{k_1}, t_{k_2}), \\ \gamma(t) + iu \cdot b_0 & \text{otherwise.} \end{cases}$$

The map \underline{D} clearly allows an extension to a continuous map $D : \mathbf{T} \times [0, 1] \rightarrow \mathbf{P}^2(\mathbb{C})$, which is a homotopy between the maps α'_Γ and $\alpha'_{\Gamma'}$, for Γ' a straightening of Γ , as indicated in the figure below.

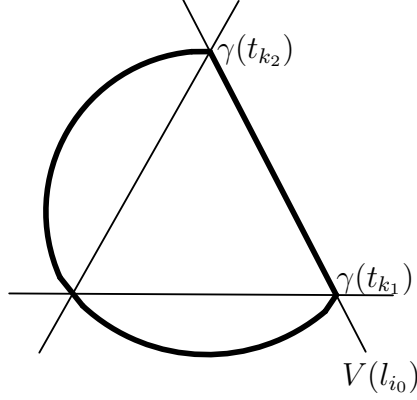

FIGURE 6. A straightening of Γ

Moreover, one has $D^{-1}(V(l_1 \cdots l_6)) = B$, for

$$B := \bigcup_{\substack{k=1, \dots, n \\ k \neq k_1, k_2}} (\{t_k\} \times [0, 1]) \cup \bigcup_{k=k_1, k_2} (\{t_k\} \times \mathbf{P}^1(\mathbb{R}) \times [0, 1]) \cup ((t_{k_1}, t_{k_2}) \times \mathbf{P}^1(\mathbb{R}) \times \{1\}).$$

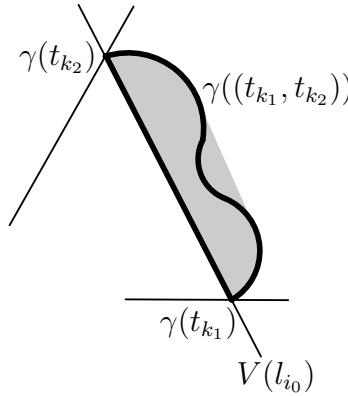

FIGURE 7. The convex hull of the line segment and the direct path $\gamma((t_{k_1}, t_{k_2}))$

Indeed, the inclusion “ \supseteq ” is obvious. In order to verify the reverse inclusion “ \subseteq ”, we first observe that the convex hull of the union of the line segment $[\gamma(t_{k_1}), \gamma(t_{k_2})]$

with the direct path $\gamma((t_{k_1}, t_{k_2}))$ does not contain any point of $V(l_1 \cdots l_6)$ in its interior. In fact, a line $V(l_a)$ through such a point would necessarily intersect $\gamma((t_{k_1}, t_{k_2}))$ somewhere, in contradiction to the assumption that this is a direct path from one vertex of the encircled polygon to the next, cf. Figure 7, above.

Now let $(t, u, s) \in \mathbf{T} \times [0, 1]$ be any point such that $D(t, u, s) \in V(l_1 \cdots l_6)$. I.e., such that $l_a(D(t, u, s)) = 0$ for some $a \in \{1, \dots, 6\}$. In the particular case that $t \in (t_{k_1}, t_{k_2})$, the reasoning just given shows that

$$0 = \operatorname{Re} l_a(D(t, u, s)) = l_a(\operatorname{Re} D(t, u, s)) \tag{12}$$

is possible only for $s = 1$, as claimed.

On the other hand, for $t \notin (t_{k_1}, t_{k_2})$, equation (12) means that $0 = l_a(\gamma(t))$, which, according to the general assumptions on the 1-manifold Γ , together with Notation 4.9.ii), may happen only for $t = t_1, \dots, t_n$. Moreover, in this case,

$$0 = \operatorname{Im} l_a(D(t, u, s)) = l_a(\operatorname{Im} D(t, u, s)) = u \cdot \tilde{l}_a(b_0),$$

which is true only for $u = 0$ or $a = i_0$. But $l_{i_0}(\gamma(t)) = 0$ happens only for $t = t_{k_1}$ and $t = t_{k_2}$, which completes the argument for the inclusion “ \subseteq ”.

The domain $(\mathbf{T} \times [0, 1]) \setminus B$ turns out to be disconnected into two components. We construct a continuous lift $D' : \mathbf{T} \times [0, 1] \rightarrow X'$ of D as follows. For $t \notin (t_{k_1}, t_{k_2})$, we put $D'(t, u, s) := \alpha_{\Gamma, b_0}^+(t, u)$. For $(t, u, s) \in B$, there is a unique lift of $D(t, u, s)$, anyway. Finally, $((t_{k_1}, t_{k_2}) \times \mathbf{P}^1(\mathbb{R}) \times [0, 1]) \setminus B$ is simply connected. Thus, there are two continuous lifts, interchanged by the involution ζ , and we may take the one that agrees with α_{Γ, b_0}^+ on $\mathbf{T} \times \{0\} \cong \mathbf{T}$. Then D' is automatically continuous on the whole of $\mathbf{T} \times [0, 1]$, and a homotopy connecting α_{Γ, b_0}^+ with α_{Γ', b_0} .

It is obvious that a completely analogous construction yields a homotopy connecting α_{Γ, b_0}^- with α_{Γ', b_0} . The proof is hence complete. \square

REFERENCES

- [AG] Allgower, E. L. and Georg, K.: Numerical continuation methods. An introduction, Springer Series in Computational Mathematics 13, *Springer*, Berlin 1990
- [AST] Artebani, M., Sarti, A., and Taki, S.: $K3$ surfaces with non-symplectic automorphisms of prime order (with an appendix by S. Kondō), *Math. Z.* **268** (2011), 507–533
- [BCP] Bosma, W., Cannon, J., and Playoust, C.: The Magma algebra system I. The user language, *J. Symbolic Comput.* **24** (1997), 235–265
- [BHPV] Barth, W., Hulek, K., Peters, C., and Van de Ven, A.: Compact complex surfaces, Second edition, *Ergebnisse der Mathematik und ihrer Grenzgebiete 4*, *Springer*, Berlin 2004
- [BT] Bott, R. and Tu, L. W.: Differential forms in algebraic topology, Graduate Texts in Math. 82, *Springer*, New York, Berlin 1982
- [Be] Beauville, A.: Complex algebraic surfaces, London Math. Soc. Lecture Note Ser. 68, *Cambridge University Press*, Cambridge 1983
- [CE] Castelnuovo, G. and Enriques, F.: Die algebraischen Flächen vom Gesichtspunkte der birationalen Transformationen aus, in: Enzyklopädie der Mathematischen Wissenschaften mit Einschluß ihrer Anwendungen, Volume III.1, *Teubner*, Leipzig 1903–1915, 675–767
- [Ch] Charles, F.: On the Picard number of $K3$ surfaces over number fields, *Algebra Number Theory* **8** (2014), 1–17

- [Co] Cox, D. A.: Primes of the form $x^2 + ny^2$: Fermat, class field theory and complex multiplication, *John Wiley & Sons*, New York 1989
- [De71] Deligne, P.: Théorie de Hodge II, *Publ. Math. IHES* **40** (1971), 5–57
- [De74] Deligne, P.: La conjecture de Weil I, *Publ. Math. IHES* **43** (1974), 273–307
- [Di3] Dieudonné, J.: Éléments d’analyse, Tome III, *Gauthier-Villars*, Cahiers Scientifiques, Fasc. XXXIII, Paris 1970
- [Di9] Dieudonné, J.: Éléments d’analyse, Tome IX, *Gauthier-Villars*, Cahiers Scientifiques, Fasc. XLII, Paris 1982
- [Dd] Dold, A.: Lectures on algebraic topology, Second edition, Grundlehren der Mathematischen Wissenschaften 200, *Springer*, Berlin–New York 1980
- [Do] Dolgachev, I. V.: Classical Algebraic Geometry: a modern view, *Cambridge University press*, Cambridge 2012
- [Ed] Edmonds A. L.: Introduction to transformation groups, www.indiana.edu/~jfdavis/seminar/transformationgroupsb.pdf
- [EJ11] Elsenhans, A.-S. and Jahnel, J.: On the computation of the Picard group for $K3$ surfaces, *Mathematical Proceedings of the Cambridge Philosophical Society* **151** (2011), 263–270
- [EJ14] Elsenhans, A.-S. and Jahnel, J.: Examples of $K3$ surfaces with real multiplication, in: Proceedings of the ANTS XI conference (Gyeongju 2014), *LMS Journal of Computation and Mathematics* **17** (2014), 14–35
- [EJ16] Elsenhans, A.-S. and Jahnel, J.: Point counting on $K3$ surfaces and an application concerning real and complex multiplication, in: Proceedings of the ANTS XII conference (Kaiserslautern 2016), *LMS Journal of Computation and Mathematics* **19** (2016), 12–28
- [EJ20] Elsenhans, A.-S. and Jahnel, J.: Explicit families of $K3$ surfaces having real multiplication, To appear in: *Michigan Mathematical Journal*
- [Fu] Fulton, W.: Intersection theory, *Ergebnisse der Mathematik und ihrer Grenzgebiete*, 3. Folge, Band 2, *Springer*, Berlin 1984
- [vG] van Geemen, B.: Real multiplication on $K3$ surfaces and Kuga-Satake varieties, *Michigan Math. J.* **56** (2008), 375–399
- [Gr] Grauert, H.: Ein Theorem der analytischen Garbentheorie und die Modulräume komplexer Strukturen, *Publ. Math. IHES* **5** (1960), 5–64
- [GH] Griffiths, P. and Harris, J.: Principles of algebraic geometry, *John Wiley & Sons*, New York 1978
- [Ha] Harvey, D.: Computing zeta functions of arithmetic schemes, *Proc. Lond. Math. Soc.* **111** (2015), 1379–1401
- [KM] Kim, W. and Madapusi Pera, K.: 2-adic integral canonical models, *Forum Math. Sigma* **4** (2016), e28, 34 pp.
- [vL] van Luijk, R.: $K3$ surfaces with Picard number one and infinitely many rational points, *Algebra & Number Theory* **1** (2007), 1–15
- [MP] Madapusi Pera, K.: The Tate conjecture for $K3$ surfaces in odd characteristic, *Invent. Math.* **201** (2015), 625–668
- [Ser] Sertöz, E. C.: Computing periods of hypersurfaces, *Preprint*, [arXiv:1803.08068](https://arxiv.org/abs/1803.08068)
- [Sev] Severi, F.: Le superficie algebriche con curva canonica d’ordine zero, *Atti del R. Ist. Veneto di Scienze, Lettere ed Arti* **68** (1908), 247–260
- [SGA5] Grothendieck, A. (avec la collaboration de Bucur, I., Houzel, C., Illusie, L. et Serre, J.-P.): Cohomologie l -adique et Fonctions L , Séminaire de Géométrie Algébrique du Bois Marie 1965–1966 (SGA 5), Lecture Notes in Math. 589, *Springer*, Berlin, Heidelberg, New York 1977
- [Sh] Šafarevič, I. R. (Editor): Algebraic Surfaces, Proceedings of the Steklov Institute 75, *AMS*, Providence 1967

- [Si] Silverman, J. H.: Advanced topics in the arithmetic of elliptic curves, Graduate Texts in Mathematics 151, *Springer*, New York 1994
- [Sp] Spanier, E. H.: Algebraic Topology, *McGraw-Hill Book Co.*, New York, Toronto, London 1966
- [Tae] Taelman, L.: Complex Multiplication and Shimura Stacks, *Preprint*, [arXiv:1707.01236](https://arxiv.org/abs/1707.01236)
- [Yo] Yoshida, M.: Hypergeometric functions, my love, Aspects of Mathematics E32, *Friedr. Vieweg & Sohn*, Braunschweig 1997
- [Za] Zarhin, Yu. G.: Hodge groups of $K3$ surfaces, *J. Reine Angew. Math.* **341** (1983), 193–220

INSTITUT FÜR MATHEMATIK, UNIVERSITÄT WÜRZBURG, EMIL-FISCHER-STRASSE 30, D-97074 WÜRZBURG, GERMANY

Email address: stephan.elsenhans@mathematik.uni-wuerzburg.de

URL: <https://www.mathematik.uni-wuerzburg.de/computeralgebra/team/elsenhans-stephan-prof-dr/>

DEPARTMENT MATHEMATIK, UNIV. SIEGEN, WALTER-FLEX-STR. 3, D-57068 SIEGEN, GERMANY

Email address: jahnel@mathematik.uni-siegen.de

URL: <http://www.uni-math.gwdg.de/jahnel>