

SELF-SIMILAR TILINGS OF FRACTAL BLOW-UPS

M. F. BARNSLEY AND A. VINCE

ABSTRACT. New tilings of certain subsets of \mathbb{R}^M are studied, tilings associated with fractal blow-ups of certain similitude iterated function systems (IFS). For each such IFS with attractor satisfying the open set condition, our construction produces a usually infinite family of tilings that satisfy the following properties: (1) the prototile set is finite; (2) the tilings are repetitive (quasiperiodic); (3) each family contains self-similar tilings, usually infinitely many; and (4) when the IFS is rigid in an appropriate sense, the tiling has no non-trivial symmetry; in particular the tiling is non-periodic.

1. INTRODUCTION

The subject of this paper is a new type of tiling of certain subsets D of \mathbb{R}^M . Such a domain D is a fractal blow-up (as defined in Section 3) of certain similitude iterated function systems (IFSs); see also [3, 14]. For an important class of such tilings it is the case that $D = \mathbb{R}^M$, as exemplified by the tiling of Figure 1 (on the right) that is based on the “golden b” tile (on the left). We are also interested, however, in situations where D has non-integer Hausdorff dimension. The left panel in Figure 2 shows the domain D , the right panel a tiling of D . These examples are explored in Section 12. In this work, tiles may be fractals; pairs of distinct tiles in a tiling are required to be non-overlapping, i.e., they intersect on a set whose Hausdorff dimension is lower than that of the individual tiles.

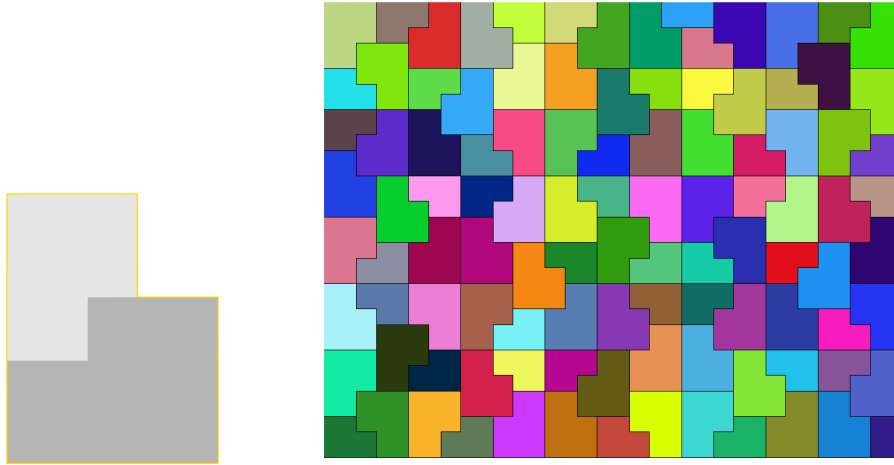

FIGURE 1. Golden b and golden b tiling.

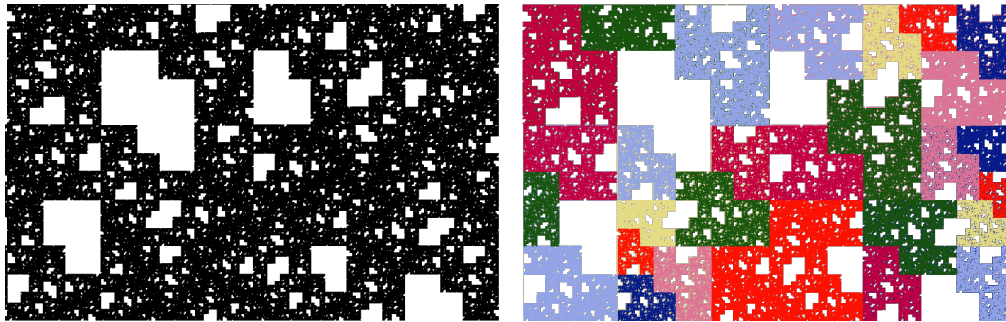

FIGURE 2. The left image shows part of an infinite fractal blow-up D ; the right image shows part of a tiling of D using a finite set of prototiles. See Section 12.

These tilings come in families, one family for each similitude IFS whose functions f_1, f_2, \dots, f_N have scaling ratios that are integer powers $s^{a_1}, s^{a_2}, \dots, s^{a_N}$ of a single real number s and whose attractor is non-overlapping. Each such family contains, in general, an uncountable number of tilings. Each family has a finite set of prototiles.

The paper is organized as follows. Sections 2 and 3 provide background and definitions relevant to tilings and to iterated function systems. The construction of our tilings is given in Section 3. The main theorems are stated precisely in Section 3 and proved in subsequent sections. Results appear in Section 8 that define and discuss the relative and absolute addresses of tiles. These concepts, useful towards understanding the relationships between different tilings, are illustrated in Section 12. Also in Section 12 are examples of tilings of \mathbb{R}^2 and of a quadrant of \mathbb{R}^2 . The Ammann (the golden b) tilings and related fractal tilings are also discussed in that section, as is a blow-up of a Cantor set.

A subset P of a tiling T is called a *patch* of T if it is contained in a ball of finite radius. A tiling T is *quasiperiodic* (also called repetitive) if, for any patch P , there is a number $R > 0$ such that any disk of radius R centered at a point contained in a tile of T contains an isometric copy of P . Two tilings are *locally isomorphic* if any patch in either tiling also appears in the other tiling. A tiling T is *self-similar* if there is a similitude ψ such that $\psi(t)$ is a union of tiles in T for all $t \in T$. Such a map ψ is called a *self-similarity*.

Let \mathcal{F} be a similitude IFS whose functions have scaling ratios $s^{a_1}, s^{a_2}, \dots, s^{a_N}$ as defined above. Let $[N]^*$ be the set of finite words over the alphabet $[N] := \{1, 2, \dots, N\}$ and $[N]^\infty$ be the set of infinite words over the alphabet $[N]$. For a fixed IFS \mathcal{F} , our results show that:

- (1) For each $\theta \in [N]^*$, our construction yields a bounded tiling, and for each $\theta \in [N]^\infty$, our construction yields an unbounded tiling. In the latter case, the tiling, denoted $\pi(\theta)$, almost always covers \mathbb{R}^M when the attractor of the IFS has nonempty interior.
- (2) The mapping $\theta \mapsto \pi(\theta)$ is continuous with respect to the standard topologies on the domain and range of π .
- (3) Under quite general conditions, the mapping $\theta \mapsto \pi(\theta)$ is injective.
- (4) For each such tiling, the prototile set is $\{sA, s^2A, \dots, s^{a_{\max}}A\}$, where A is the attractor of the IFS and $a_{\max} = \max\{a_1, a_2, \dots, a_N\}$.

- (5) The constructed tilings, in the unbounded case, are repetitive (quasiperiodic) and any two such tilings are locally isomorphic.
- (6) For all $\theta \in [N]^\infty$, if θ is eventually periodic, then $\pi(\theta)$ is self-similar.
- (7) If \mathcal{F} is strongly rigid, then how isometric copies of a pair bounded tilings can overlap is extremely restricted: if the two tilings are such that their overlap is a subset of each, then one tiling must be contained in the other.
- (8) If \mathcal{F} is strongly rigid, then the constructed tilings have no non-identity symmetry. In particular, they are non-periodic.

The concept of a rigid and a strongly rigid IFS is discussed in Sections 9.

A special case of our construction (polygonal tilings, no fractals) appears in [5], in which we took a more recreational approach, devoid of proofs. Other references to related material are [1, 13]. This work extends, but is markedly different from [4].

2. TILINGS, SIMILITUDES AND TILING SPACES

Given a natural number M , this paper is concerned with certain tilings of strict subsets of Euclidean space \mathbb{R}^M and of \mathbb{R}^M itself. A *tile* is a perfect (i.e. no isolated points) compact nonempty subset of \mathbb{R}^M . Fix a Hausdorff dimension $0 < D_H \leq M$. A *tiling* in \mathbb{R}^M is a set of tiles, each of Hausdorff dimension D_H , such that every distinct pair is non-overlapping. Two tiles are *non-overlapping* if their intersection is of Hausdorff dimension strictly less than D_H . The *support* of a tiling is the union of its tiles. We say that a tiling tiles its support. Some examples are presented in Section 12.

A *similitude* is an affine transformation $f : \mathbb{R}^M \rightarrow \mathbb{R}^M$ of the form $f(x) = sO(x) + q$, where O is an orthogonal transformation and $q \in \mathbb{R}^M$ is the translational part of $f(x)$. The real number $s > 0$, a measure of the expansion or contraction of the similitude, is called its *scaling ratio*. An *isometry* is a similitude of unit scaling ratio and we say that two sets are isometric if they are related by an isometry. We write \mathcal{E} to denote the group of isometries on \mathbb{R}^M .

The *prototile set* \mathcal{P} of a tiling T is a minimal set of tiles such that every tile in T is an isometric copy of a tile in \mathcal{P} . The tilings constructed in this paper have a finite prototile set.

Given a tiling T we define ∂T to be the union of the set of boundaries of all of the tiles in T and we let $\rho : \mathbb{R}^M \rightarrow \mathbb{S}^M$ be the usual M -dimensional stereographic projection to the M -sphere, obtained by positioning \mathbb{S}^M tangent to \mathbb{R}^M at the origin. We define the distance between tilings T and T' to be

$$d_\tau(T, T') = h(\overline{\rho(\partial T)}, \overline{\rho(\partial T')})$$

where the bar denotes closure and h is the Hausdorff distance with respect to the round metric on \mathbb{S}^M . Let $\mathbb{K}(\mathbb{R}^M)$ be the set of nonempty compact subsets of \mathbb{R}^M . It is well known that d_τ provides a metric on the space $\mathbb{K}(\mathbb{R}^M)$ and that $(\mathbb{K}(\mathbb{R}^M), d_\tau)$ is a compact metric space.

This paper examines spaces consisting, for example, of $\pi(\theta)$ indexed by $\theta \in [N]^*$ with metric d_τ . Although we are aware of the large literature on tiling spaces, we do not explore the larger spaces obtained by taking the closure of orbits of our tilings under groups of isometries as in, for example, [1, 13]. We focus on the relationship between the addressing structures associated with IFS theory and the particular families of tilings constructed here.

3. DEFINITION AND PROPERTIES OF IFS TILINGS

Let $\mathbb{N} = \{1, 2, \dots\}$ and $\mathbb{N}_0 = \{0, 1, 2, \dots\}$. For $N \in \mathbb{N}$, let $[N] = \{1, 2, \dots, N\}$. Let $[N]^* = \cup_{k \in \mathbb{N}_0} [N]^k$, where $[N]^0$ is the empty string, denoted \emptyset .

See [7] for formal background on iterated function systems (IFSs). Here we are concerned with IFSs of a special form: let $\mathcal{F} = \{\mathbb{R}^M; f_1, f_2, \dots, f_N\}$, with $N \geq 2$, be an IFS of contractive similitudes where the scaling factor of f_n is s^{a_n} with $0 < s < 1$ where $a_n \in \mathbb{N}$. There is no loss of generality in assuming that the greatest common divisor is one: $\gcd\{a_1, a_2, \dots, a_N\} = 1$. That is, for $x \in \mathbb{R}^M$, the function $f_n : \mathbb{R}^M \rightarrow \mathbb{R}^M$ is defined by

$$f_n(x) = s^{a_n} O_n(x) + q_n$$

where O_n is an orthogonal transformation and $q_n \in \mathbb{R}^M$. It is convenient to define

$$a_{\max} = \max\{a_i : i = 1, 2, \dots, N\}.$$

The *attractor* A of \mathcal{F} is the unique solution in $\mathbb{K}(\mathbb{R}^M)$ to the equation

$$A = \bigcup_{i \in [N]} f_i(A).$$

It is assumed throughout that A obeys the open set condition (OSC) with respect to \mathcal{F} . As a consequence, the intersection of each pair of distinct tiles in the tilings that we construct either have empty intersection or intersect on a relatively small set. More precisely, the OSC implies that the Hausdorff dimension of A is strictly greater than the Hausdorff dimension of the *set of overlap* $\mathcal{O} = \cup_{i \neq j} f_i(A) \cap f_j(A)$. Similitudes applied to subsets of the set of overlap comprise the sets of points at which tiles may meet. See [2, p.481] for a discussion concerning measures of attractors compared to measures of the set of overlap.

In what follows, the space $[N]^* \cup [N]^\infty$ is equipped with a metric $d_{[N]^* \cup [N]^\infty}$ such that it becomes compact. First, define the “length” $|\theta|$ of $\theta \in [N]^* \cup [N]^\infty$ as follows. For $\theta = \theta_1 \theta_2 \dots \theta_k \in [N]^*$ define $|\theta| = k$, and for $\theta \in [N]^\infty$ define $|\theta| = \infty$. Now define $d_{[N]^* \cup [N]^\infty}(\theta, \omega) = 0$ if $\theta = \omega$, and

$$d_{[N]^* \cup [N]^\infty}(\theta, \omega) = 2^{-\mathcal{N}(\theta, \omega)}$$

if $\theta \neq \omega$, where $\mathcal{N}(\theta, \omega)$ is the index of the first disagreement between θ and ω (and θ and ω are understood to disagree at index k if either $|\theta| < k$ or $|\omega| < k$). It is routine to prove that $([N]^* \cup [N]^\infty, d_{[N]^* \cup [N]^\infty})$ is a compact metric space.

A point $\theta \in [N]^\infty$ is *eventually periodic* if there exists $m \in \mathbb{N}_0$ and $n \in \mathbb{N}$ such that $\theta_{m+i} = \theta_{m+n+i}$ for all $i \geq 1$. In this case we write $\theta = \theta_1 \theta_2 \dots \theta_m \overline{\theta_{m+1} \theta_{m+2} \dots \theta_{m+n}}$.

For $\theta = \theta_1 \theta_2 \dots \theta_k \in [N]^*$, the following simplifying notation will be used:

$$\begin{aligned} f_\theta &= f_{\theta_1} f_{\theta_2} \dots f_{\theta_k} \\ f_{-\theta} &= f_{\theta_1}^{-1} f_{\theta_2}^{-1} \dots f_{\theta_k}^{-1} = (f_{\theta_k \theta_{k-1} \dots \theta_1})^{-1}, \end{aligned}$$

with the convention that f_θ and $f_{-\theta}$ are the identity function *id* if $\theta = \emptyset$. Likewise, for all $\theta \in [N]^\infty$ and $k \in \mathbb{N}_0$ define $\theta|k = \theta_1 \theta_2 \dots \theta_k$, and

$$f_{-\theta|k} = f_{\theta_1}^{-1} f_{\theta_2}^{-1} \dots f_{\theta_k}^{-1} = (f_{\theta_k \theta_{k-1} \dots \theta_1})^{-1},$$

with the convention that $f_{-\theta|0} = id$.

For $\sigma = \sigma_1 \sigma_2 \dots \sigma_k \in [N]^*$ and with $\{a_1, \dots, a_N\}$ the scaling powers defined above, let

$$e(\sigma) = a_{\sigma_1} + a_{\sigma_2} + \dots + a_{\sigma_k} \quad \text{and} \quad e^-(\sigma) = a_{\sigma_1} + a_{\sigma_2} + \dots + a_{\sigma_{k-1}},$$

with the conventions $e(\emptyset) = e^-(\emptyset) = 0$. Let

$$\Omega_k := \{\sigma \in [N]^* : e(\sigma) > k \geq e^-(\sigma)\}$$

for all $k \in \mathbb{N}_0$, and note that $\Omega_0 = [N]$. We also write, in some places, $\sigma^- = \sigma_1\sigma_2 \cdots \sigma_{k-1}$ so that

$$e^-(\sigma) = e(\sigma^-).$$

Definition 1. A mapping π from $[N]^* \cup [N]^\infty$ to collections of subsets of \mathbb{R}^M is defined as follows. For $\theta \in [N]^*$

$$\pi(\theta) := \{f_{-\theta} f_\sigma(A) : \sigma \in \Omega_{e(\theta)}\},$$

and for $\theta \in [N]^\infty$

$$\pi(\theta) := \bigcup_{k \in \mathbb{N}_0} \pi(\theta|k).$$

Let \mathbb{T} be the image of π , i.e.

$$\mathbb{T} = \{\pi(\theta) : \theta \in [N]^* \cup [N]^\infty\}.$$

It is consequence of Theorem 1, stated below, that the elements of \mathbb{T} are tilings. We refer to $\pi(\theta)$ as an *IFS tiling*, but usually drop the term ‘‘IFS’’. It is a consequence of the proof of Theorem 1, given in Section 6, that the support of $\pi(\theta)$ is what is sometimes referred to as a *fractal blow-up* [3, 14]. More exactly, if $F_k := f_{-\theta|k}(A)$, then

$$\text{support}(\pi(\theta)) = \bigcup_{k \in \mathbb{N}_0} F_k.$$

Thus the support of $\pi(\theta)$ is the limit of an increasing union of sets $F_0 \subseteq F_1 \subseteq F_2 \subseteq \cdots$, each similar to A .

The theorems of this paper are summarized in the rest of this section. The first two theorems, as well as a proposition in Section 8, reveal general information about the tilings in \mathbb{T} without the rigidity condition that is assumed in the second two theorems. The proof of the following theorem appears in Section 6.

Theorem 1. *Each set $\pi(\theta)$ in \mathbb{T} is a tiling of a subset of \mathbb{R}^M , the subset being bounded when $\theta \in [N]^*$ and unbounded when $\theta \in [N]^\infty$. For all $\theta \in [N]^\infty$ the sequence of tilings $\{\pi(\theta|k)\}_{k=0}^\infty$ is nested according to*

$$(3.1) \quad \{f_i(A) : i \in [N]\} = \pi(\emptyset) \subset \pi(\theta|1) \subset \pi(\theta|2) \subset \pi(\theta|3) \subset \cdots.$$

For all $\theta \in [N]^\infty$, the prototile set for $\pi(\theta)$ is $\{s^i A : i = 1, 2, \dots, a_{\max}\}$. Furthermore

$$\pi : [N]^* \cup [N]^\infty \rightarrow \mathbb{T}$$

is a continuous map from the compact metric space $[N]^ \cup [N]^\infty$ into the space $(\mathbb{K}(\mathbb{R}^M), d_\tau)$.*

The proof of the following theorem is given in Section 7.

Theorem 2. (1) *Each tiling in \mathbb{T} is quasiperiodic and each pair of such tilings in \mathbb{T} are locally isomorphic.*

(2) *If θ is eventually periodic, then $\pi(\theta)$ is self-similar. In fact, if $\theta = \alpha\bar{\beta}$ for some $\alpha, \beta \in [N]^*$ then $f_{-\alpha} f_{-\beta} (f_{-\alpha})^{-1}$ is a self-similarity of $\pi(\theta)$.*

In Section 9 the concept of *rigidity* of an IFS is defined. We postpone the definition because additional notation is required. There are numerous examples of rigid \mathcal{F} , including the golden b IFS in Section 12. The following theorem is proved in Section 9.

Theorem 3. *Let \mathcal{F} be strongly rigid. If $\theta, \theta' \in [N]^*$ and $E \in \mathcal{E}$ are such that $\pi(\theta) \cap E\pi(\theta')$ is a nonempty common tiling, then either $\pi(\theta) \subset E\pi(\theta')$ or $E\pi(\theta') \subset \pi(\theta)$. If $e(\theta) = e(\theta')$, then $E\pi(\theta') = \pi(\theta)$.*

A *symmetry* of a tiling is an isometry that takes tiles to tiles. A tiling is *periodic* if there exists a translational symmetry; otherwise the tiling is *non-periodic*. For example, any tiling of a quadrant of \mathbb{R}^2 by congruent squares is periodic. The proof of the following theorem is given in Section 10.

Theorem 4. *If \mathcal{F} is strongly rigid, then there does not exist any non-identity isometry $E \in \mathcal{E}$ and $\theta \in [N]^\infty$ such that $E\pi(\theta) \subset \pi(\theta)$.*

The following theorem is proved in Section 11.

Theorem 5. *If $\pi(i) \cap \pi(j)$ does not tile ($\text{support } \pi(i) \cap \text{support } \pi(j)$) for all $i \neq j$, then $\pi : [N]^* \cup [N]^\infty \rightarrow \mathbb{T}$ is one-to-one.*

4. STRUCTURE OF $\{\Omega_k\}$ AND SYMBOLIC IFS TILINGS

The results in this section, which will be applied later, relate to a symbolic version of the theory in this paper. The next two lemmas provide recursions for the sequence $\Omega_k := \{\sigma \in [N]^* : e(\sigma) > k \geq e^-(\sigma)\}$. In this section the square union symbol \sqcup denotes a disjoint union.

Lemma 1. *For all $k \geq a_{\max}$*

$$(4.1) \quad \Omega_k = \bigsqcup_{i=1}^N i\Omega_{k-a_i}.$$

Proof. For all $k \in \mathbb{N}_0$ we have

$$\begin{aligned} i\Omega_k &= \{i\sigma : \sigma \in [N]^*, e(\sigma) > k \geq e^-(\sigma)\} \\ &= \{\omega : \omega \in [N]^*, e(\omega) > k + a_i \geq e^-(\omega), \omega_1 = i\} \\ &= \Omega_{k+a_i} \cap i[N]^*. \end{aligned}$$

It follows that

$$i\Omega_{k-a_i} = \Omega_k \cap i[N]^*$$

for all $k \geq a_i$, from which it follows that $\Omega_k = \bigsqcup_{i=1}^N i\Omega_{k-a_i}$ for all $k \geq a_{\max}$. \square

Lemma 2. *With $\Omega'_k := \{\omega \in [N]^* : e(\omega) = k + 1\}$, we have $\Omega'_k \subset \Omega_k$ and*

$$\Omega_{k+1} = \{\Omega_k \setminus \Omega'_k\} \sqcup \left\{ \bigsqcup_{i=1}^N \Omega'_k i \right\}.$$

Proof. (i) We first show that $\{\Omega_k \setminus \Omega'_k\} \sqcup \left\{ \bigsqcup_{i=1}^N \Omega'_k i \right\} \subset \Omega_{k+1}$.

Suppose $\theta \in \Omega_k \setminus \Omega'_k$. Then $e^-(\theta) \leq k < e(\theta)$ and $e(\theta) \neq k + 1$. Hence $e^-(\theta) \leq k + 1 < e(\theta)$ and so $\theta \in \Omega_{k+1}$.

Suppose $\theta \in \Omega'_k i$ for some $i \in [N]$. Then $\theta = \theta^- i$ where $\theta^- \in \Omega'_k$, $e^-(\theta) = e(\theta^-) = k + 1$ and $e(\theta) = e(\theta^- i) = k + 1 + a_i$. Hence $e(\theta) > k + 1 = e^-(\theta)$. Hence $e^-(\theta) \leq k + 1 < e(\theta)$. Hence $\theta \in \Omega_{k+1}$.

(ii) We next show that $\Omega_{k+1} \subset \{\Omega_k \setminus \Omega'_k\} \sqcup \left\{ \bigsqcup_{i=1}^N \Omega'_k i \right\}$.

Let $\theta \in \Omega_{k+1}$. Then $e^-(\theta) = e(\theta^-) \leq k + 1 < e(\theta)$.

If $e(\theta^-) = k + 1$, then $\theta \in \Omega'_k \theta_{|\theta|} \subset \{\Omega_k \setminus \Omega'_k\} \sqcup \left\{ \bigsqcup_{i=1}^N \Omega'_k i \right\}$.

If $e(\theta^-) \neq k + 1$, then $e(\theta^-) < k + 1$. So $e(\theta^-) \leq k < k + 1 < e(\theta)$; so $\theta \in \Omega_k \setminus \Omega'_k \subset \{\Omega_k \setminus \Omega'_k\} \sqcup \left\{ \bigsqcup_{i=1}^N \Omega'_k i \right\}$. \square

For all $\theta \in [N]^*$, define $c(\theta) = \{\omega \in [N]^\infty : \omega_1 \omega_2 \cdots \omega_{|\theta|} = \theta\}$. (Such sets are sometimes called *cylinder sets*.) With the metric on $[N]^\infty$ defined to be $d_0(\theta, \omega) = 2^{-\min\{k: \theta_k \neq \omega_k\}}$ for $\theta \neq \omega$, the diameter of $c(\theta)$ is $2^{-(|\theta|+1)}$. The following lemma tells us how $\{c(\theta) : \theta \in \Omega_k\}$ may be considered as a tiling of the symbolic space $[N]^\infty$.

Lemma 3. *For each $k \in \mathbb{N}_0$ the collection of sets $\{c(\theta) : \theta \in \Omega_k\}$ form a partition of $[N]^\infty$, each part of which has diameter belonging to $\{s^{k+1}, s^{k+2}, \dots, s^{k+a_{\max}}\}$ where $s = 1/2$. That is,*

$$[N]^\infty = \bigsqcup_{\theta \in \Omega_k} c(\theta)$$

for all $k \in \mathbb{N}_0$.

Proof. Assume that $\omega \in [N]^\infty$. There is a unique j such that $\omega|_j \in \Omega_k$. Letting $\theta = \omega|_j$ we have $\omega \in c(\theta) \subset [N]^\infty$. Therefore $[N]^\infty = \bigcup_{\theta \in \Omega_k} c(\theta)$.

Assume that $\theta, \theta' \in \Omega_k$. If $\omega \in c(\theta) \cap c(\theta')$, then by the definition of cylinder set either $\theta = \theta'$ or $|\theta| \neq |\theta'|$. However, if $|\theta| \neq |\theta'|$, then $\omega|_{|\theta|} = \theta \in \Omega_k$ and $\omega|_{|\theta'|} = \theta' \in \Omega_k$, which would contradict the uniqueness of j . Therefore $[N]^\infty = \bigsqcup_{\theta \in \Omega_k} c(\theta)$. \square

5. A CANONICAL SEQUENCE OF SELF-SIMILAR TILINGS

To facilitate the proofs of the theorems stated in Section 3, another family of tilings is introduced, tilings isometric to those that are the subject of this paper. Let

$$A_k = s^{-k} A$$

for all $k \in \mathbb{N} \cup \{-1, -2, \dots, -a_{\max}\}$, and define, for all $k \in \mathbb{N}$, a sequence of tilings T_k of A_k by

$$T_k = \{s^{-k} f_\sigma(A) : \sigma \in \Omega_k\}.$$

The following lemma says, in particular, that T_k is a non-overlapping union of copies of T_{k-a_i} for $i \in [N]$ when $k \geq a_{\max}$, and T_k may be expressed as a non-overlapping union of copies of $T_{k-e(\omega)}$ for $\omega \in \Omega_l$ when k is somewhat larger than $l \in \mathbb{N}_0$. In this section the square union notation \sqcup denotes a non-overlapping union.

Lemma 4. *For all $k \in \mathbb{N}_0$ the support of T_k is A_k . For all $\theta \in [N]^*$,*

$$\pi(\theta) = E_\theta T_{e(\theta)}$$

where E_θ is the isometry $f_{-\theta}s^{e(\theta)}$. Also

$$(5.1) \quad T_k = \bigsqcup_{i=1}^N E_{k,i} T_{k-a_i}$$

for all $k \geq a_{\max}$, where each of the mappings $E_{k,i} = s^{-k} \circ f_i \circ s^{k-a_i}$ is an isometry. More generally,

$$(5.2) \quad T_k = \bigsqcup_{\omega \in \Omega_l} E_{k,\omega} T_{k-e(\omega)},$$

for all $k \geq l + a_{\max}$ and for all $l \in \mathbb{N}_0$, where each of the mappings $E_{k,\omega} = s^{-k} \circ f_\omega \circ s^{k-e(\omega)}$ is an isometry.

Proof. It is well-known that if \mathcal{P} is a partition of $[N]^\infty$, then $A = \bigcup_{\omega \in \mathcal{P}} \phi(\omega)$ where $\phi : [N]^\infty \rightarrow A$ is the usual (continuous) coding map defined by $\phi(\omega) = \lim_{k \rightarrow \infty} f_{\omega|k}(x)$ for any fixed $x \in A$. By Lemma 3 we can choose $\mathcal{P} = \{c(\theta) : \theta \in \Omega_k\}$. Hence, the support of T_k is

$$\begin{aligned} s^{-k} \{ \bigcup \{ f_\sigma(A) : \sigma \in \Omega_k \} \} &= s^{-k} \{ \bigcup \{ \phi(\omega) : \omega \in \{c(\theta) : \theta \in \Omega_k\} \} \} \\ &= s^{-k} A. \end{aligned}$$

The expression $\pi(\theta) = E_\theta T_{e(\theta)}$ where E_θ is the isometry $f_{-\theta}s^{e(\theta)}$ follows from the definitions of $\pi(\theta)$ and T_k on taking $k = e(\theta)$.

Equation (5.1) follows from Lemma 1 according to these steps.

$$\begin{aligned} T_k &= \{s^{-k} f_\sigma(A) : \sigma \in \Omega_k\} \text{ (by definition)} \\ &= s^{-k} \{f_\sigma(A) : \sigma \in \bigsqcup_{i=1}^N i\Omega_{k-a_i}\} \text{ (by Lemma 1)} \\ &= s^{-k} \bigsqcup_{i=1}^N \{f_{i\sigma}(A) : \sigma \in \Omega_{k-a_i}\} \text{ (identity)} \\ &= s^{-k} \bigsqcup_{i=1}^N f_i(\{f_\sigma(A) : \sigma \in \Omega_{k-a_i}\}) \text{ (identity)} \\ &= \bigsqcup_{i=1}^N E_{k,i} T_{k-a_i} \text{ (by definition)} \end{aligned}$$

The function $E_{k,i} = s^{-k} \circ f_i \circ s^{k-a_i}$ is an isometry because it is a composition of three similitudes, of scaling ratios s^{-k} , s^{a_i} , and s^{k-a_i} . The proof of the last assertion is immediate: tiles meet at images under similitudes of the set of overlap $\mathcal{O} = \cup_{i \neq j} f_i(A) \cap f_j(A)$.

Equation (5.2) can be proved by induction on l , starting from Equation (5.1) and using Lemma 2. \square

The following definition, formalizing the notion of an ‘‘isometric combination of tilings’’, will be used later, but it is convenient to place it here.

Definition 2. Let $\{U_i : i \in \mathcal{I}\}$ be a collection of tilings. An **isometric combination of the set of tilings** $\{U_i : i \in \mathcal{I}\}$ is a tiling V that can be written in the

form

$$V = \bigsqcup_{i=1}^K E^{(i)} U^{(i)}$$

for some $K \in \mathbb{N}$, where $E^{(i)} \in \mathcal{E}$, $U^{(i)} \in \{U_i : i \in \mathcal{I}\}$, for all $i \in \{1, 2, \dots, K\}$.

For example, Lemma 4 tells us that any T_k can be written as an isometric combination of any set of tilings of the form $\{T_j, T_{j+1}, \dots, T_{j+a_{\max}-1}\}$ when $k \geq j$.

Proposition 1. *The sequence $\{T_k\}$ of tilings is self-similar in the following sense. Each of the sets in the magnified tiling $s^{-1}T_k$ is a union of tiles in T_{k+1} .*

Proof. This follows at once from Lemma 2. The tiling T_{k+1} is obtained from T_k by applying the similitude s^{-1} and then splitting those resulting sets that are isometric to A . By splitting we mean we replace EA by $\{Ef_1(A), Ef_2(A), \dots, Ef_N(A)\}$, see Section 9. \square

6. THEOREM 1: EXISTENCE AND CONTINUITY OF TILINGS

Let

$$A_{-\theta|k} := f_{-\theta|k}A$$

for all $\theta \in [N]^\infty$. It is immediate from Definition 1 that the support of the tiling $\pi(\theta|k)$ is $A_{-\theta|k}$ and that $\pi(\theta|k)$ is isometric to the tiling $T_{e(k)}$ of $A_{e(k)}$. We use this fact repeatedly in the rest of this paper.

Theorem 1. Each set $\pi(\theta)$ in \mathbb{T} is a tiling of a subset of \mathbb{R}^M , the subset being bounded when $\theta \in [N]^*$ and unbounded when $\theta \in [N]^\infty$. For all $\theta \in [N]^\infty$ the sequence of tilings $\{\pi(\theta|k)\}_{k=0}^\infty$ is nested according to

$$(6.1) \quad \{f_i(A) : i \in [N]\} = \pi(\emptyset) \subset \pi(\theta|1) \subset \pi(\theta|2) \subset \pi(\theta|3) \subset \dots$$

For all $\theta \in [N]^\infty$, the prototile set for $\pi(\theta)$ is $\{s^i A : i = 1, 2, \dots, a_{\max}\}$. Furthermore

$$\pi : [N]^* \cup [N]^\infty \rightarrow \mathbb{T}$$

is a continuous map from the compact metric space $[N]^* \cup [N]^\infty$ into the space $(\mathbb{K}(\mathbb{R}^M), d_\tau)$.

Proof. Using Lemma 4, for $\theta = \theta_1\theta_2 \dots \theta_l \in [N]^*$ and $\theta^- = \theta_1\theta_2 \dots \theta_{l-1}$,

$$\begin{aligned} \pi(\theta) &= E_\theta T_{e(\theta)} = \bigsqcup_{i=1}^N E_\theta E_{e(\theta), i} T_{k-a_i} \\ &\supset E_\theta E_{e(\theta), \theta_l} T_{k-a_{\theta_l}} = E_{\theta^-} T_{e(\theta^-)} = \pi(\theta^-). \end{aligned}$$

It follows that $\{\pi(\theta|k)\}$ is an increasing sequence of tilings for all $\theta \in [N]^\infty$, as in Equation (3.1), and so converges to a well-defined limit. Since the maps in the IFS are strict contractions, their inverses are expansive, whence $\pi(\theta)$ is unbounded for all $\theta \in [N]^\infty$.

The fact that the tiles here are indeed tiles as we defined them at the start of this paper follows from three readily checked observations. (i) The tiles are nonempty perfect compact sets because they are isometric to the attractor, that is not a singleton, of an IFS of similitudes. (ii) There are only finitely many tiles that intersect any ball of finite radius. (iii) Any two tiles can meet only on a set that is contained in the image under a similitude of the set of overlap.

Next we prove that there are exactly a_{\max} distinct tiles, up to isometry, in any tiling $\pi(\theta)$ for $\theta \in [N]^\infty$. The tiles of $\pi(\theta)$ take the form $\{f_{-\theta|k} f_\sigma(A) : \sigma \in \Omega_{e(\theta|k)}\}$ for some $k \in \mathbb{N}$. The mappings here are similitudes whose scaling factors are $\{s^{e(\sigma) - e(\theta|k)} : e(\sigma) - e(\theta|k) > 0 \geq e(\sigma) - e(\theta|k) - a_{|\sigma|}\}$, namely $\{s^m : m > 0 \geq m - a_{|\sigma|}\}$ for which the possible values are at most all of $\{1, 2, \dots, a_{\max}\}$. That all of these values occur for large enough k follows from $\gcd\{a_i : i = 1, 2, \dots, N\} = 1$.

Next we prove that $\pi : [N]^* \cup [N]^\infty \rightarrow \mathbb{T}$ is a continuous map from the compact metric space $[N]^* \cup [N]^\infty$ onto the space (\mathbb{T}, d_T) . The map $\pi|_{[N]^*} : [N]^* \rightarrow \mathbb{T}$ is continuous on the discrete part of the space $([N]^*, d_{[N]^* \cup [N]^\infty})$ because each point $\theta \in [N]^*$ possesses an open neighborhood that contains no other points of $[N]^* \cup [N]^\infty$. To show that π is continuous at points of $[N]^\infty$ we follow a similar method to the one in [1]. Let $\varepsilon > 0$ be given and let $B(R)$ be the open ball of radius R centered at the origin. Choose R so large that $h(\rho(\overline{B(R)}), S^M) < \varepsilon$. This implies that if two tilings differ only where they intersect the complement of $\overline{B(R)}$, then their distance d_T apart is less than ε . But geometrical consideration of the way in which $\text{support}(\pi(\theta_1\theta_2\theta_3..\theta_k))$ grows with increasing k shows that we can choose K so large that $\text{support}(\pi(\theta_1\theta_2\theta_3..\theta_k)) \cap \overline{B(R)}$ is constant for all $k \geq K$. It follows that

$$h(\rho(\pi(\theta_1\theta_2..\theta_k)), \rho(\pi(\theta_1\theta_2..\theta_l))) \leq \varepsilon$$

and as a consequence

$$h(\rho(\partial\pi(\theta_1\theta_2..\theta_k)), \rho(\partial\pi(\theta_1\theta_2..\theta_l))) \leq \varepsilon$$

for all $k, l \geq K$. It follows that $h(\rho(\pi(\theta)), \rho(\pi(\omega))) \leq \varepsilon$ whenever $\theta_1\theta_2..\theta_K = \omega_1\omega_2..\omega_K$. It follows that π is continuous. \square

7. THEOREM 2: WHEN DO ALL TILINGS REPEAT THE SAME PATTERNS?

Theorem 2.

- (1) Each unbounded tiling in \mathbb{T} is quasiperiodic and all tilings in \mathbb{T} have the local isomorphism property.
- (2) If θ is eventually periodic, then $\pi(\theta)$ is self-similar. In fact, if $\theta = \alpha\bar{\beta}$ for some $\alpha, \beta \in [N]^*$, then $f_{-\alpha}f_{-\beta}(f_{-\alpha})^{-1}$ is a self-similarity of $\pi(\theta)$.

Proof. (1) First we prove quasiperiodicity. This is related to the self-similarity of the sequence of tilings $\{T_k\}$ mentioned in Proposition 1.

Let $\theta \in [N]^\infty$ be given and let P be a patch in $\pi(\theta)$. There is a $K_1 \in \mathbb{N}$ such that P is contained in $\pi(\theta|K_1)$. Hence an isometric copy of P is contained in T_{K_2} where $K_2 = e(\theta|K_1)$. Now choose $K_3 \in \mathbb{N}$ so that an isometric copy of T_{K_2} is contained in each T_k with $k \geq K_3$. That this is possible follows from the recursion (5.2) of Lemma 4 and $\gcd\{a_i\} = 1$. In particular, $T_{K_2} \subset T_{K_3+i}$ for all $i \in \{1, 2, \dots, a_{\max}\}$.

Now let $K_4 = K_3 + a_{\max}$. Then, for all $k \geq K_4$, the tiling T_k is an isometric combination of $\{T_{K_3+i} : i = 1, 2, \dots, a_{\max}\}$, and each of these tilings contains a copy of T_{K_2} and in particular a copy of P .

Let $D = \max\{\|x - y\| : x, y \in A\}$ be the diameter of A . The support of T_k is $s^{-k}A$ which has diameter $s^{-k}D$. Hence $\text{support}(T_k) \subset B(x, 2s^{-k}D)$, the ball centered at x of radius $2s^{-k}D$, for all $x \in \text{support}(T_k)$. It follows that if $x \in \text{support}\pi(\theta')$ for any $\theta' \in [N]^\infty$, then $B(x, 2s^{-K_4}D)$ contains a copy of $\text{support}(T_{K_2})$ and hence a copy of P . Therefore all unbounded tilings in \mathbb{T} are quasiperiodic.

In [10] Radin and Wolff define a tiling to have the local isomorphism property if for every patch P in the tiling there is some distance $d(P)$ such that every sphere of diameter $d(P)$ in the tiling contains an isometric copy of P . Above, we have proved a stronger property of tilings, as defined here, of fractal blow-ups. Given P , there is a distance $d(P)$ such that each sphere of diameter $d(P)$, centered at any point belonging to the support of any unbounded tiling in \mathbb{T} , contains a copy of P .

(2) Let $\theta = \alpha\bar{\beta} = \alpha_1\alpha_2 \cdots \alpha_l\beta_1\beta_2 \cdots \beta_m\beta_1\beta_2 \cdots \beta_m\beta_1\beta_2 \cdots \beta_m \cdots$. We have the equivalent increasing unions

$$\pi(\theta) = \bigcup_{k \in \mathbb{N}} E_{\theta|k} T_{e(\theta|k)} = \bigcup_{j \in \mathbb{N}} E_{\theta|(l+jm)} T_{e(\theta|(l+jm))} = \bigcup_{j \in \mathbb{N}} E_{\theta|(l+jm+m)} T_{e(\theta|(l+jm+m))}$$

where, for all k ,

$$E_{\theta|k} = f_{-\theta|k} s^{e(\theta|k)}.$$

We can write

$$\pi(\theta) = \bigcup_{j \in \mathbb{N}} E_{\theta|(l+jm)} T_{e(\theta|(l+jm))} = f_{-\alpha} \bigcup_{j \in \mathbb{N}} f_{-\beta}^j s^{e(\theta|(l+jm))} T_{e(\theta|(l+jm))},$$

and also

$$\pi(\theta) = \bigcup_{j \in \mathbb{N}} E_{\theta|(l+jm+m)} T_{e(\theta|(l+jm+m))} = f_{-\alpha} f_{-\beta} \bigcup_{j \in \mathbb{N}} f_{-\beta}^j s^{e(\theta|(l+jm+m))} T_{e(\theta|(l+jm+m))}.$$

Here $f_{-\beta}^j s^{e(\theta|(l+jm+m))} T_{e(\theta|(l+jm+m))}$ is a refinement of $f_{-\beta}^j s^{e(\theta|(l+jm))} T_{e(\theta|(l+jm))}$. It follows that $(f_{-\alpha} f_{-\beta})^{-1} \pi(\theta)$ is a refinement of $(f_{-\alpha})^{-1} \pi(\theta)$, from which it follows that $(f_{-\alpha}) (f_{-\alpha} f_{-\beta})^{-1} \pi(\theta)$ is a refinement of $\pi(\theta)$. Therefore, every set in $(f_{-\alpha} f_{-\beta}) (f_{-\alpha})^{-1} \pi(\theta)$ is a union of tiles in $\pi(\theta)$. \square

8. RELATIVE AND ABSOLUTE ADDRESSES

In order to understand how different tilings relate to one another, the notions of relative and absolute addresses of tiles are introduced. Given an IFS \mathcal{F} , the *set of absolute addresses* is defined to be:

$$\mathbb{A} := \{\theta.\omega : \theta \in [N]^*, \omega \in \Omega_{e(\theta)}, \theta_{|\theta|} \neq \omega_1\}.$$

Define $\hat{\pi} : \mathbb{A} \rightarrow \{t \in T : T \in \mathbb{T}\}$ by

$$\hat{\pi}(\theta.\omega) = f_{-\theta}.f_{\omega}(A).$$

We say that $\theta.\omega$ is an *absolute address* of the tile $f_{-\theta}.f_{\omega}(A)$. It follows from Definition 1 that the map $\hat{\pi}$ is surjective: every tile of $\{t \in T : T \in \mathbb{T}\}$ possesses at least one address. The condition $\theta_{|\theta|} \neq \omega_1$ is imposed to make cancellation unnecessary.

The *set of relative addresses* is associated with the tiling T_k of $A_k = s^{-k}A$ and is defined to be $\{\omega : \omega \in \Omega_k\}$.

Proposition 2. *There is a bijection between the set of relative addresses $\{\omega : \omega \in \Omega_k\}$ and the tiles of T_k , for all $k \in \mathbb{N}_0$.*

Proof. This follows from the non-overlapping union

$$A = \bigsqcup_{\omega \in \Omega_k} f_{\omega}(A).$$

This expression follows immediately from Lemma 3; see the start of the proof of Lemma 4. \square

Accordingly, we say that ω , or equivalently $\emptyset.\omega$, where $\omega \in \Omega_k$, is *the relative address* of the tile $s^{-k}f_\omega(A)$ in the tiling T_k of A_k . Note that a tile of T_k may share the same relative address as a different tile of T_l for $l \neq k$.

Define the *set of labelled tiles* of T_k to be

$$\mathcal{A}_k = \{(\omega, s^{-k}f_\omega(A)) : \omega \in \Omega_k\}$$

for all $k \in \mathbb{N}_0$. A key point about relative addresses is that the set of labelled tiles of T_k for $k \in \mathbb{N}$ can be computed recursively. Define

$$\mathcal{A}'_k = \{(\omega, s^{-k}f_\omega(A)) \in \mathcal{A}_k : e(\omega) = k + 1\} \subset \mathcal{A}_k.$$

An example of the following inductive construction is illustrated in Figure 6, and some corresponding tilings $\pi(\theta)$ labelled by absolute addresses are illustrated in Figure 7.

Lemma 5. *For all $k \in \mathbb{N}_0$ we have*

$$\mathcal{A}_{k+1} = \mathcal{L}(\mathcal{A}_k \setminus \mathcal{A}'_k) \cup \mathcal{M}(\mathcal{A}'_k)$$

where

$$\begin{aligned} \mathcal{L}(\omega, s^{-k}f_\omega(A)) &= (\omega, s^{-k-1}f_\omega(A)), \\ \mathcal{M}(\omega, s^{-k}f_\omega(A)) &= \{(\omega i, s^{-k-1}f_{\omega i}(A)) : i \in [N]\}. \end{aligned}$$

Proof. This follows immediately from Lemma 2. \square

9. STRONG RIGIDITY, DEFINITION OF “AMALGAMATION AND SHRINKING” OPERATION α ON TILINGS, AND PROOF OF THEOREM 3.

We begin this key section by introducing an operation, called “amalgamation and shrinking”, that maps certain tilings into tilings. This leads to the main result of this section, Theorem 3, which, in turn, leads to Theorem 4.

Definition 3. Let $T_0 = \{f_i(A) : i \in [N]\}$. The IFS \mathcal{F} is said to be **rigid** if (i) there exists no non-identity isometry $E \in \mathcal{E}$ such that $T_0 \cap ET_0$ is non-empty and tiles $A \cap ET$, and (ii) there exists no non-identity isometry $E \in \mathcal{E}$ such that $A = EA$.

Definition 4. Define \mathbb{T}' to be the set of all tilings using the set of prototiles $\{s^i A : i = 1, 2, \dots, a_{\max}\}$. Any tile that is isometric to $s^{a_{\max}} A$ is called a **small tile**, and any tile that is isometric to sA is called a **large tile**. We say that a tiling $P \in \mathbb{T}'$ comprises a set of **partners** if $P = ET_0$ for some $E \in \mathcal{E}$. Define $\mathbb{T}'' \subset \mathbb{T}'$ to be the set of all tilings in \mathbb{T}' such that, given any $Q \in \mathbb{T}''$ and any small tile $t \in Q$, there is a set of partners of t , call it $P(t)$, such that $P(t) \subset Q$. Given any $Q \in \mathbb{T}''$ we define Q' to be the union of all sets of partners in Q .

Definition 5. Let \mathcal{F} be a rigid IFS. The amalgamation and shrinking operation $\alpha : \mathbb{T}'' \rightarrow \mathbb{T}'$ is defined by

$$\alpha Q = \{st : t \in Q \setminus Q'\} \cup \bigsqcup_{\{E \in \mathcal{E} : ET_0 \subset Q'\}} sEA.$$

Lemma 6. *If \mathcal{F} is rigid, the function $\alpha : \mathbb{T}'' \rightarrow \mathbb{T}'$ is well-defined and bijective; in particular, $\alpha^{-1} : \mathbb{T}' \rightarrow \mathbb{T}''$ is well defined by*

$$\alpha^{-1}(Q) = \{\alpha_Q^{-1}(q) : q \in Q\}$$

where

$$\alpha_Q^{-1}(q) = \begin{cases} s^{-1}q & \text{if } q \in Q \text{ is not a large tile} \\ s^{-1}ET_0 & \text{if } Eq \text{ is a large tile, some } E \in \mathcal{E} \end{cases}$$

Proof. Because \mathcal{F} is rigid, there can be no ambiguity with regard to which sets of tiles in a tiling are partners, nor with regard to which tiles are the partners of a given small tile. Hence $\alpha : \mathbb{T}'' \rightarrow \mathbb{T}'$ is well defined. Given any $T' \in \mathbb{T}'$ we can find a unique $Q \in \mathbb{T}''$ such that $\alpha(Q) = T'$, namely $\alpha^{-1}(Q)$ as defined in the lemma. \square

Lemma 7. *Let \mathcal{F} be rigid and $k \in \mathbb{N}$. Then*

- (i) $T_k \in \mathbb{T}''$;
- (ii) $\alpha T_k = T_{k-1}$ and $\alpha^{-1}T_{k-1} = T_k$.

Proof. As described in Lemma 5, T_k can be constructed in a well-defined manner, starting from T_{k-1} , by scaling and splitting, that is, by applying α^{-1} . Conversely T_{k-1} can be constructed from T_k by applying α . Statements (i) and (ii) are consequences. \square

Lemma 8. *If \mathcal{F} is rigid, $L, M \in \mathbb{T}''$, and $L \cap M$ tiles $\text{support}(L) \cap \text{support}(M)$, then $L \cap M \in \mathbb{T}''$. Moreover,*

$$\alpha(L \cap M) = \alpha(L) \cap \alpha(M),$$

and $\alpha(L \cap M)$ tiles $\text{support}\alpha(L) \cap \text{support}\alpha(M)$.

Proof. Since $L, M \in \mathbb{T}'' \subset \mathbb{T}'$ lie in the range of α^{-1} , we can find unique $L', M' \in \mathbb{T}'$ such that

$$L = \alpha^{-1}L' \text{ and } M = \alpha^{-1}M'.$$

Note that $\alpha^{-1}(T') = \{\alpha^{-1}(t) : t \in T'\}$ for all $T' \in \mathbb{T}'$, which implies that α^{-1} commutes both with unions of disjoint tilings and also with intersections of tilings whose intersections tile the intersections of their supports. It follows that $L \cap M \in \mathbb{T}''$,

$$\begin{aligned} \alpha(L \cap M) &= \alpha(\alpha^{-1}L' \cap \alpha^{-1}M') \\ &= \alpha(\alpha^{-1}(L' \cap M')) \\ &= L' \cap M' \\ &= \alpha(L) \cap \alpha(M), \end{aligned}$$

and $\text{support } \alpha(L \cap M) = \text{support } \alpha(L) \cap \text{support } \alpha(M)$. \square

Definition 6. \mathcal{F} is **strongly rigid** if \mathcal{F} is rigid and whenever $i, j \in \{0, 1, 2, \dots, a_{\max} - 1\}$, $E \in \mathcal{E}$, and $T_i \cap ET_j$ tiles $A_i \cap EA_j$, either $T_i \subset ET_j$ or $T_i \supset ET_j$.

Section 12 contain a few examples of strongly rigid IFSs.

Lemma 9. *Let \mathcal{F} be strongly rigid, $k, l \in \mathbb{N}_0$, and $E \in \mathcal{E}$.*

- (i) *If $ET_k \cap T_k$ is nonempty and tiles $EA_k \cap A_k$, then $E = \text{id}$.*
- (ii) *If $EA_k \cap A_{k+l}$ is nonempty and $ET_k \cap T_{k+l}$ tiles $EA_k \cap A_{k+l}$, then $ET_k \subset T_{k+l}$.*

Proof. Suppose $ET_k \cap T_l \neq \emptyset$ and t.i.s. (tiles intersection of supports). Without loss of generality assume $k \leq l$, for if not, then apply E^{-1} , then redefine E^{-1} as E .

Both ET_k and T_l lie in the domain of α^k , so we can apply Lemma 8 k times, yielding

$$(9.1) \quad \begin{aligned} \alpha^k(ET_k \cap T_l) &= s^k E s^{-k} T_0 \cap T_{l-k} \\ &:= \tilde{E}T_0 \cap T_{l-k} \neq \emptyset, \end{aligned}$$

where $\tilde{E}T_0 \cap T_{l-k}$ t.i.s. Now observe that by Lemma 4 we can write, for all $k' \geq l' + a_{\max}$,

$$T_{k'} = \bigsqcup_{\omega \in \Omega_{l'}} E_{k', \omega} T_{k'-e(\omega)} (= \{E_{k', \omega} T_{k'-e(\omega)} : \omega \in \Omega_{l'}\}),$$

where $E_{k', \omega} \in \mathcal{E}$ for all k', ω . Choosing $l' = k' - a_{\max}$ and noting that, for $\omega \in \Omega_{l'}$, we have $e(\omega) \in \{l' + 1, \dots, l' + a_{\max}\}$, and for $\omega \in \Omega_{k'-a_{\max}}$ we have $e(\omega) \in \{k' - a_{\max} + 1, \dots, k'\}$. Therefore $k' - e(\omega) \in \{0, 1, \dots, a_{\max} - 1\}$ and we obtain the explicit representation

$$T_{k'} = \bigsqcup_{\omega \in \Omega_{k'-a_{\max}}} E_{k', \omega} T_{k'-e(\omega)}$$

which is an isometric combination of $\{T_0, T_1, \dots, T_{a_{\max}-1}\}$. In particular, we can always reexpress T_{l-k} in (9.1) as isometric combination of $\{T_0, T_1, \dots, T_{a_{\max}-1}\}$ and so there is some E' and some $T_m \in \{T_0, T_1, \dots, T_{a_{\max}-1}\}$ such that

$$\tilde{E}T_0 \cap E'T_m \neq \emptyset \text{ and t.i.s.}$$

By the strong rigidity assumption, this implies $\tilde{E}T_0 \subset E'T_m$, which in turn implies

$$\tilde{E}T_0 \subset T_{l-k}$$

and t.i.s. Now apply α^{-k} to both sides of this last equation to obtain the conclusions of the lemma. \square

Theorem 3. Let \mathcal{F} be strongly rigid. If $\theta, \theta' \in [N]^*$ and $E \in \mathcal{E}$ are such that $\pi(\theta) \cap E\pi(\theta')$ is not empty and tiles $A_{-\theta} \cap EA_{-\theta'}$, then either $\pi(\theta) \subset E\pi(\theta')$ or $E\pi(\theta') \subset \pi(\theta)$. In this situation, if $e(\theta) = e(\theta')$, then $E\pi(\theta') = \pi(\theta)$.

Proof. This follows from Lemma 9. If $\theta, \theta' \in [N]^*$ and $E \in \mathcal{E}$ are such that $\pi(\theta) \cap E\pi(\theta')$ is not empty and tiles $A_{-\theta} \cap EA_{-\theta'}$, then $\theta, \theta' \in [N]^*$ and $E \in \mathcal{E}$ are such that $E_\theta T_{e(\theta)} \cap EE_{\theta'} T_{e(\theta')}$ is not empty and tiles $E_\theta A_{e(\theta)} \cap EE_{\theta'} A_{e(\theta')}$, where $E_\theta = f_{-\theta} s^{e(\theta)}$ and $E_{\theta'} = f_{-\theta'} s^{e(\theta')}$ are isometries. Assume, without loss of generality, that $e(\theta) \leq e(\theta')$ and apply $E_{\theta'}^{-1} E^{-1}$ to obtain that $\theta, \theta' \in [N]^*$ and $E' = E_{\theta'}^{-1} E^{-1} E_\theta \in \mathcal{E}$ are such that $E' T_{e(\theta)} \cap T_{e(\theta')}$ is not empty and tiles $E' A_{e(\theta)} \cap A_{e(\theta')}$. By Lemma 9 it follows that $E' T_{e(\theta)} \subset T_{e(\theta')}$, i.e. $E_{\theta'}^{-1} E^{-1} E_\theta T_{e(\theta)} \subset T_{e(\theta')}$, i.e. $\pi(\theta) \subset E\pi(\theta')$. If also $e(\theta') \leq e(\theta)$ (i.e. $e(\theta') = e(\theta)$), then also $E\pi(\theta') \subset \pi(\theta)$. Therefore $E\pi(\theta') = \pi(\theta)$. \square

10. THEOREM 4: WHEN IS A TILING NON-PERIODIC?

Theorem 4. If F is strongly rigid, then there does not exist any non-identity isometry $E \in \mathcal{E}$ and $\theta \in [N]^\infty$ such that $E\pi(\theta) \subset \pi(\theta)$.

Proof. Suppose there exists an isometry E such that $E\pi(\theta) = \pi(\theta)$. Then we can choose $K \in \mathbb{N}_0$ so large that $E\pi(\theta|K) \cap \pi(\theta|K) \neq \emptyset$ and $E\pi(\theta|K) \cap \pi(\theta|K)$ tiles $EA_{-\theta|K} \cap A_{-\theta|K}$. By Theorem 3 it follows that

$$E\pi(\theta|K) = \pi(\theta|K)$$

This implies

$$EE_\theta T_{e(\theta|K)} = E_\theta T_{e(\theta|K)}$$

whence, because $E_\theta T_{e(\theta|K)}$ is in the domain of $\alpha^{e(\theta|K)}$ and $\alpha^{e(\theta|K)} T_{e(\theta|K)} = T_0$, we have by Lemma 7

$$\begin{aligned} \alpha^{e(\theta|K)} EE_\theta T_{e(\theta|K)} &= \alpha^{e(\theta|K)} E_\theta T_{e(\theta|K)} \\ &\implies s^{e(\theta|K)} EE_\theta s^{-e(\theta|K)} \alpha^{e(\theta|K)} T_{e(\theta|K)} = s^{e(\theta|K)} E_\theta s^{-e(\theta|K)} \alpha^{e(\theta|K)} T_{e(\theta|K)} \\ &\implies s^{e(\theta|K)} EE_\theta s^{-e(\theta|K)} T_0 = s^{e(\theta|K)} E_\theta s^{-e(\theta|K)} T_0 \\ &\implies s^{e(\theta|K)} EE_\theta s^{-e(\theta|K)} = s^{e(\theta|K)} E_\theta s^{-e(\theta|K)} \quad (\text{using rigidity}) \\ &\implies E = id. \end{aligned}$$

□

It follows that if \mathcal{F} is strongly rigid, then $\pi(\theta)$ is non-periodic for all θ .

11. WHEN IS $\pi : [N]^* \cup [N]^\infty \rightarrow \mathbb{T}$ INVERTIBLE?

Lemma 10. *For all \mathcal{F} the restricted mapping $\pi|_{[N]^*} : [N]^* \rightarrow \mathbb{T}$ is injective.*

Proof. To simplify notation, write $\pi = \pi|_{[N]^*}$. We show how to calculate θ given $\pi(\theta)$ for $\theta \in [N]^*$. By Lemma 4 we have $\pi(\theta) = E_\theta T_{e(\theta)}$, where E is the isometry $f_{-\theta} s^{e(\theta)}$. Given $\pi(\theta)$, we can calculate

$$e(\theta) = \frac{\ln |A| - \ln |\pi(\theta)|}{\ln s},$$

where $|U|$ denotes the diameter of the set U .

We next show that if $E_\theta = E_{\theta'}$ for some $\theta \neq \theta'$ with $e(\theta) = e(\theta')$, then $\pi(\theta) \neq \pi(\theta')$. To do this, suppose that $E_\theta = E_{\theta'}$. This implies that $f_{-\theta} = f_{-\theta'}$ which implies

$$(f_{-\theta'})^{-1} f_{-\theta} = id,$$

which is not possible when $\theta \neq \theta'$, as we prove next. The similitude $(f_{-\theta'})^{-1} f_{-\theta}$ maps $(f_{-\theta})^{-1}(A) \subset A$ to $(f_{-\theta'})^{-1}(A) \subset A$, and these two subsets of A are distinct for all $\theta, \theta' \in [N]^*$ with $\theta \neq \theta'$, as we prove next.

Let ω, ω' denote the two strings θ, θ' written in inverse order, so that $\theta \neq \theta'$ is equivalent to $\omega \neq \omega'$. First suppose $|\omega| = |\omega'| = m$ for some $m \in \mathbb{N}$. Then use

$$A = \bigsqcup_{\omega \in [N]^m} f_\omega(A),$$

which tells us that $f_\omega(A)$ and $f_{\omega'}(A)$ are disjoint. Since $(f_{-\theta'})^{-1} f_{-\theta}$ maps $(f_{-\theta})^{-1}(A) = f_\omega(A)$ to the distinct set $(f_{-\theta'})^{-1}(A) = f_{\omega'}(A)$, we must have $(f_{-\theta'})^{-1} f_{-\theta} \neq id$.

Now suppose $|\omega| = m < |\omega'| = m'$. If both strings ω and ω' agree through the first m places, then $f_\omega(A)$ is a strict subset of $f_{\omega'}^{-1}(A)$ and again we cannot have $(f_{-\theta'})^{-1} f_{-\theta} = id$. If both strings ω and ω' do not agree through the first m

places, then let $p < m$ be the index of their first disagreement. Then we find that $f_\omega(A)$ is a subset of $f_{\omega|_p}(A)$, while $f_{\omega'}(A)$ is a subset of the set $f_{\omega'|_p}(A)$, which is disjoint from $f_{\omega|_p}(A)$. Since $(f_{-\theta'})^{-1}f_{-\theta}$ maps $f_\omega(A)$ to $f_{\omega'}(A)$, we again have that $(f_{-\theta'})^{-1}f_{-\theta} \neq id$. \square

We are going to need a key property of certain shifts maps on tilings, defined in the next lemma.

Lemma 11. *The mappings $S_i : \{\pi(\theta) : \theta \in [N]^l \cup [N]^\infty, l \geq a_i\} \rightarrow \mathbb{T}'$ for $i \in [N]$ are well-defined by*

$$S_i = f_i s^{-a_i} \alpha^{a_i}.$$

It is true that

$$S_{\theta_1} \pi(\theta) = \pi(S\theta)$$

for all $\theta \in [N]^l \cup [N]^\infty$ where $l \geq a_{\theta_1}$.

Proof. We only consider the case $\theta \in [N]^\infty$. The case $\theta \in [N]^l$ is treated similarly. A detailed calculation, outlined next, is needed. The key idea is that $\pi(\theta)$ is broken up into a countable union of disjoint tilings, each of which belongs to the domain of α^k for all $k \leq K$ for any $K \in \mathbb{N}$. For all $K \in \mathbb{N}$ we have:

$$\pi(\theta) = E_{\theta|_K} T_{e(\theta|_K)} \bigsqcup \bigsqcup_{k=K}^\infty E_{\theta|_{k+1}} T_{e(\theta|_{k+1})} \setminus E_{\theta|_k} T_{e(\theta|_k)}.$$

The tilings on the r.h.s. are indeed disjoint, and each set belongs to the domain of $\alpha^{e(\theta|_K)}$, so we can use Lemma 8 applied countably many times to yield

$$S_{\theta_1} \pi(\theta) = S_{\theta_1} (E_{\theta|_K} T_{e(\theta|_K)}) \bigsqcup_{k=K}^\infty S_{\theta_1} (E_{\theta|_{k+1}} T_{e(\theta|_{k+1})}) \setminus S_{\theta_1} (E_{\theta|_k} T_{e(\theta|_k)}).$$

Evaluating, we obtain successively

$$\begin{aligned} S_{\theta_1} \pi(\theta) &= f_{\theta_1} s^{-a_{\theta_1}} \alpha^{a_{\theta_1}} (E_{\theta|_K} T_{e(\theta|_K)}) \bigsqcup_{k=K}^\infty f_{\theta_1} s^{-a_{\theta_1}} \alpha^{a_{\theta_1}} (E_{\theta|_{k+1}} T_{e(\theta|_{k+1})}) \setminus f_{\theta_1} s^{-a_{\theta_1}} \alpha^{a_{\theta_1}} (E_{\theta|_k} T_{e(\theta|_k)}), \\ S_{\theta_1} \pi(\theta) &= f_{\theta_1} E_{\theta|_K} s^{-a_{\theta_1}} \alpha^{a_{\theta_1}} T_{e(\theta|_K)} \bigsqcup_{k=K}^\infty f_{\theta_1} E_{\theta|_{k+1}} s^{-a_{\theta_1}} \alpha^{a_{\theta_1}} T_{e(\theta|_{k+1})} \setminus f_{\theta_1} E_{\theta|_{k+1}} s^{-a_{\theta_1}} \alpha^{a_{\theta_1}} T_{e(\theta|_k)}, \\ S_{\theta_1} \pi(\theta) &= f_{\theta_1} E_{\theta|_K} s^{-a_{\theta_1}} T_{e(S\theta|_{K-1})} \bigsqcup_{k=K}^\infty f_{\theta_1} E_{\theta|_{k+1}} s^{-a_{\theta_1}} T_{e(S\theta|_k)} \setminus f_{\theta_1} E_{\theta|_k} s^{-a_{\theta_1}} T_{e(S\theta|_{k-1})}, \\ S_{\theta_1} \pi(\theta) &= E_{S\theta|(K-1)} T_{e(S\theta|_{K-1})} \bigsqcup_{k=K}^\infty E_{S\theta|_k} T_{e(S\theta|_{k-1})} \setminus E_{S\theta|_{k-1}} T_{e(S\theta|_{k-1})} = \pi(S\theta). \end{aligned}$$

\square

Theorem 5. *If $\pi(i) \cap \pi(j)$ does not tile $(\text{support } \pi(i)) \cap (\text{support } \pi(j))$ for all $i \neq j$, then $\pi : [N]^* \cup [N]^\infty \rightarrow \mathbb{T}$ is one-to-one.*

Proof. The map π is one-to-one on $[N]^*$ by Lemma 10, so we restrict attention to points in $[N]^\infty$. If θ and θ' are such that $\theta_1 = i$ and $\theta'_1 = j$, then the result is immediate because $\pi(\theta)$ contains $\pi(i)$ and $\pi(\theta')$ contains $\pi(j)$. If θ and θ' agree through their first K terms with $K \geq 1$ and $\theta_{K+1} \neq \theta'_{K+1}$, then $\pi(S^K \theta) \neq \pi(S^K \theta')$. Now apply $S_{\theta_1}^{-1} S_{\theta_2}^{-1} \dots S_{\theta_K}^{-1}$ to obtain $\pi(\theta) \neq \pi(\theta')$. (We can do this last step because $S_i^{-1} = (f_i s^{-a_i} \alpha^{a_i})^{-1} = \alpha^{-a_i} s^{a_i} f_i^{-1}$ has as its domain all of \mathbb{T}' and maps \mathbb{T}' into \mathbb{T}' .) \square

12. EXAMPLES

12.1. **Golden b tilings.** A *golden b* $G \subset \mathbb{R}^2$ is illustrated in Figure 3. This hexagon is the only rectilinear polygon that can be tiled by a pair of differently scaled copies of itself [11, 12]. Throughout this subsection the IFS is

$$\mathcal{F} = \{\mathbb{R}^2; f_1, f_2\}$$

where

$$f_1(x, y) = \begin{pmatrix} 0 & s \\ -s & 0 \end{pmatrix} \begin{pmatrix} x \\ y \end{pmatrix} + \begin{pmatrix} 0 \\ s \end{pmatrix}, \quad f_2(x, y) = \begin{pmatrix} -s^2 & 0 \\ 0 & s^2 \end{pmatrix} \begin{pmatrix} x \\ y \end{pmatrix} + \begin{pmatrix} 1 \\ 0 \end{pmatrix},$$

where the scaling ratios s and s^2 obey $s^4 + s^2 = 1$, which tells us that $s^{-2} = \alpha^{-2}$ is the golden mean. The attractor of \mathcal{F} is $A = G$. It is the union of two prototiles $f_1(G)$ and $f_2(G)$. Copies of these prototiles are labelled L and S . In this example, note that $\epsilon(\theta) = \theta_1 + \theta_2 + \dots + \theta_{|\theta|}$ for $\theta \in [2]^*$.



FIGURE 3. A golden b is a union of two tiles, a small one and its partner, a large one. The vertices of this golden b are located at $(0, 0)$ $(1, 0)$ $(1, \alpha^3)$ (α^2, α^3) (α^2, α) $(0, \alpha)$ in counterclockwise order, starting at the lower left corner, where α^{-2} is the golden mean. This picture also represents a tiling $T_0 = \pi(\emptyset)$.

The figures in this section illustrate some earlier concepts in the context of the golden b. Using some of these figures, it is easy to check that \mathcal{F} is strongly rigid, so the tilings $\pi(\theta)$ have all of the properties ascribed to them by the theorems in the earlier sections.

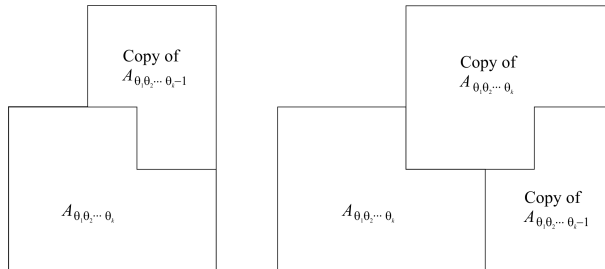

FIGURE 4. Structures of $A_{\theta_1\theta_2\dots\theta_{k-1}}$ and $A_{\theta_1\theta_2\dots\theta_{k-2}}$ relative to $A_{\theta_1\theta_2\dots\theta_k}$.

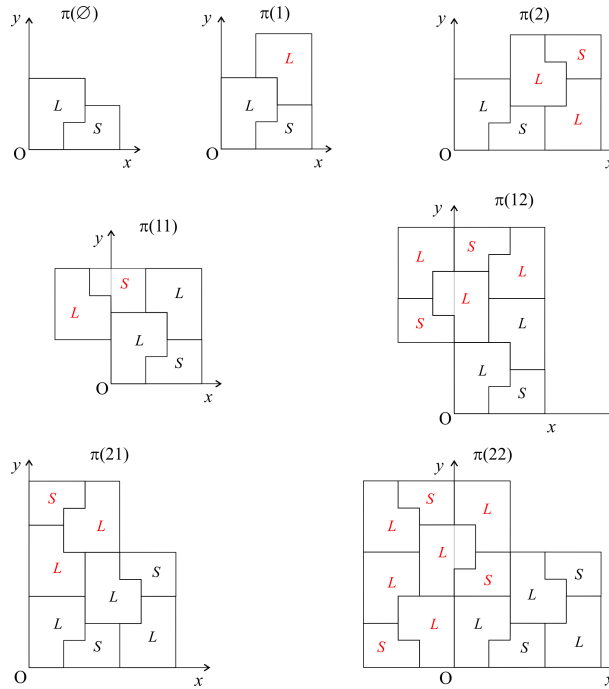

FIGURE 5. Some of the sets $A_{\theta_1\theta_2\theta_3..\theta_k}$ and the corresponding tilings $\pi(\theta_1\theta_2\theta_3..\theta_k)$. The recursive organization is such that $\pi(\emptyset) \subset \pi(\theta_1) \subset \pi(\theta_1\theta_2) \subset \dots$ regardless of the choice $\theta_1\theta_2\theta_3..\theta_k \in \{1, 2\}^\infty$.

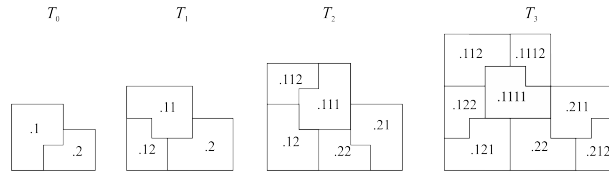

FIGURE 6. Relative addresses, the addresses of the tiles that comprise the tilings T_0, T_1, T_2, T_3 of A_0, A_1, A_2, A_3 .

The relationships between $A_{\theta_1\theta_2..\theta_{k-1}}$ and $A_{\theta_1\theta_2..\theta_k}$ relative to $A_{\theta_1\theta_2..\theta_k}$ are illustrated in Figure 4. Figure 5 illustrates some of the sets $A_{\theta_1\theta_2\theta_3..\theta_k}$ and the corresponding tilings $\pi(\theta_1\theta_2\theta_3..\theta_k)$.

In Section 8, procedures were described by which the relative addresses of tiles in $T(\theta|k)$ and the absolute addresses of tiles in $\pi(\theta|k)$ may be calculated recursively. Relative addresses for some golden b tilings are illustrated in Figure 6. Figure 7 illustrates absolute addresses for some golden b tilings.

The map $\pi : [2]^* \cup [2]^\infty \rightarrow \mathbb{T}$ is 1-1 by Theorem 5, because $\pi(1) \cup \pi(2)$ does not tile the intersection of the supports of $\pi(1)$ and $\pi(2)$, as illustrated in Figure 8.

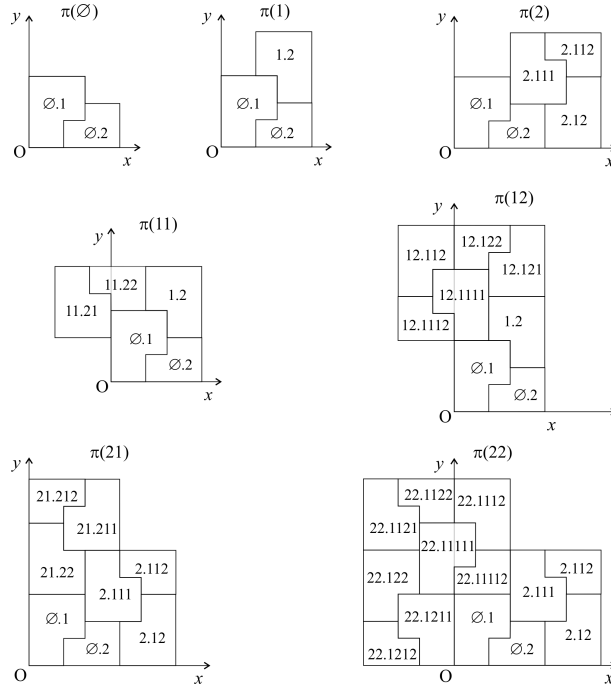

FIGURE 7. Absolute addresses associated with the golden b.

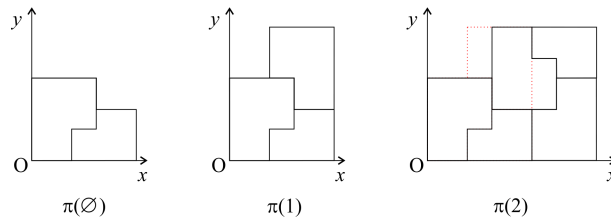

FIGURE 8. The boundaries of the tilings $\pi(\emptyset)$, $\pi(1)$, $\pi(2)$, with the parts of the boundaries of the tiles in $\pi(1)$ that are not parts of the boundaries of tiles in $\pi(2)$ superimposed in red on the rightmost image.

We note that $\pi(\overline{12})$ and $\pi(\overline{21})$ are aperiodic tilings of the upper right quadrant of \mathbb{R}^2 .

12.2. Fractal tilings with non-integer dimension. The left hand image in Figure 9, shows the attractor of the IFS represented by the different coloured regions, there being 8 maps, and provides an example of a strongly rigid IFS. The right hand image represents the attractor of the same IFS minus one of the maps, also strongly

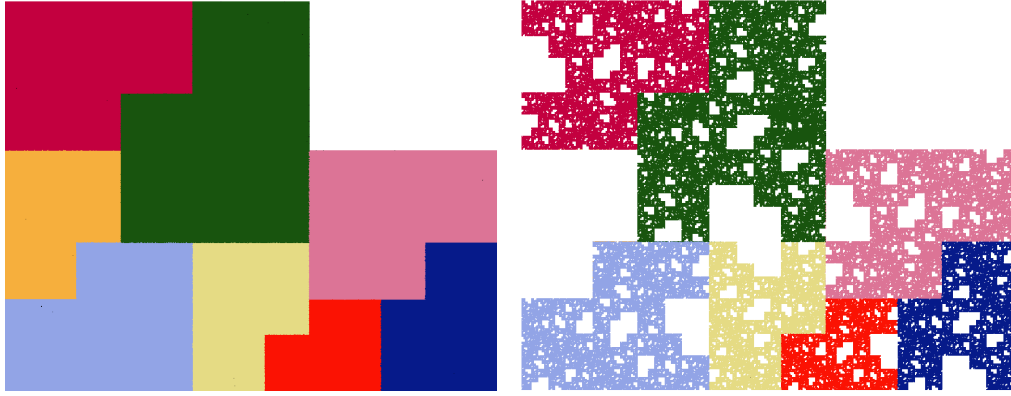

FIGURE 9. See text.

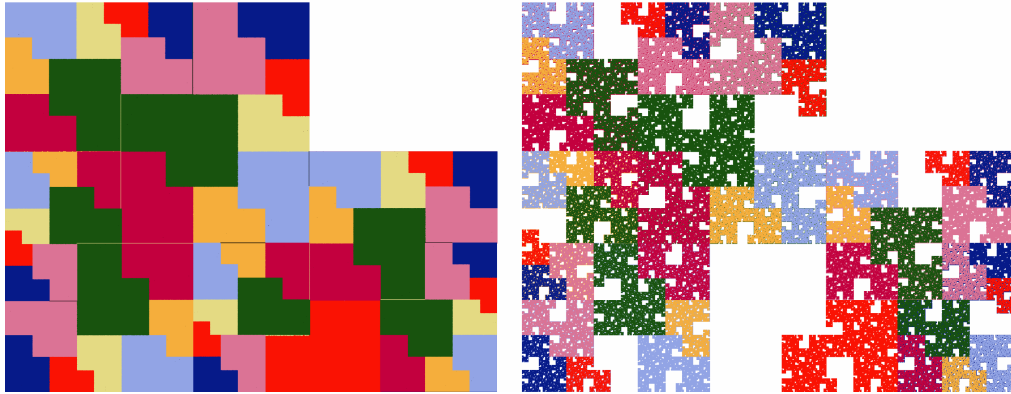

FIGURE 10. See text.

rigid, but in this case the dimensions of the tiles is less than two and greater than one. Figure 2 (in Section 1) illustrates a part of a fractal blow up of a different but related 7 map IFS, also strongly rigid, and the corresponding tiling.

Figure 10 left shows a tiling associated with the IFS \mathcal{F} represented on the left in Figure 9, while the tiling on the right is another example of a fractal tiling, obtained by dropping one of the maps of \mathcal{F} .

12.3. Tilings derived from Cantor sets. Our results apply to the case where $\mathcal{F} = \{\mathbb{R}^M; f_i(x) = s^{a_i}O_i + q_i, i \in [N]\}$ where $\{O_i, q_i : i \in [N]\}$ is fixed in a general position, the a_i s are positive integers, and s is chosen small enough to ensure that the attractor is a Cantor set. In this situation the set of overlap is empty and it is to be expected that \mathcal{F} is strongly rigid, in which case all tilings (by a finite set of

prototiles, each a Cantor set) will be non-periodic. We can then take s to be the supremum of value such that the set of overlap is nonempty, to yield interesting “just touching” tilings.

REFERENCES

- [1] J. E. Anderson and I. F. Putnam, Topological invariants for substitution tilings and their associated C^* -algebras, *Ergod. Th. & Dynam. Sys.* **18** (1998) 509-537.
- [2] C. Bandt, M. F. Barnsley, M. Hegland, A. Vince, Old wine in fractal bottles I: Orthogonal expansions on self-referential spaces via fractal transformations, *Chaos, Solitons and Fractals*, **91** (2016) 478-489.
- [3] M. F. Barnsley, A. Vince, Fast basins and branched fractal manifolds of attractors of iterated function systems, *SIGMA* **11** (2015), 084, 21 pages.
- [4] M. F. Barnsley, A. Vince, Fractal tilings from iterated function systems, *Discrete and Computational Geometry*, **51** (2014) 729-752.
- [5] M. F. Barnsley, A. Vince, Self-similar polygonal tilings, *Amer. Math. Monthly*, to appear (2017).
- [6] B. Grünbaum and G. S. Shephard, *Tilings and Patterns*, Freeman, New York (1987).
- [7] J. Hutchinson, Fractals and self-similarity, *Indiana Univ. Math. J.* **30** (1981) 713-747.
- [8] R. Kenyon, The construction of self-similar tilings, *Geom. Funct. Anal.* **6** (1996) 471-488.
- [9] R. Penrose, Pentaplexity, *Math Intelligencer* **12** (1965) 247-248.
- [10] C. Radin, M. Wolff, Space tilings and local isomorphism, *Geometrica Dedicata* **42**, 355-360, 1991.
- [11] K. Scherer, *A Puzzling Journey To The Reptiles And Related Animals*, privately published, Auckland, New Zealand, 1987.
- [12] J. H. Schmerl, Dividing a polygon into two similar polygons, *Discrete Math.*, **311** (2011) 220-231.
- [13] L. Sadun, Tiling spaces are inverse limits, *J. Math. Phys.*, **44** (2003) 5410-5414.
- [14] R. S. Strichartz, Fractals in the large, *Canad. J. Math.*, **50** (1998) 638-657.

AUSTRALIAN NATIONAL UNIVERSITY, CANBERRA, ACT, AUSTRALIA

UNIVERSITY OF FLORIDA, GAINESVILLE, FL, USA