

# THE FIRST SYZYGY OF HIBI RINGS ASSOCIATED WITH PLANAR DISTRIBUTIVE LATTICES

PRIYA DAS AND HIMADRI MUKHERJEE

ABSTRACT. In this article, we give explicit minimal generators of the first syzygy of the Hibi ring for a planar distributive lattice in terms of sublattices. We also give a characterization when it is linearly related and derive an exact formula for the first Betti number of a planar distributive lattice.

## 1. INTRODUCTION

Let  $\mathcal{L}$  be a finite distributive lattice and let  $S = K[x_\alpha : \alpha \in \mathcal{L}]$  be a polynomial ring over a field  $K$ . For  $\alpha, \beta \in \mathcal{L}$ ,  $f_{(\alpha, \beta)} = x_\alpha x_\beta - x_{\alpha \vee \beta} x_{\alpha \wedge \beta} \in S$ , is called a diamond relation if  $\alpha \approx \beta$  (we say,  $\alpha$  is not comparable to  $\beta$ ). Let  $I = \langle f_{(\alpha, \beta)} : \alpha \approx \beta, \alpha, \beta \in \mathcal{L} \rangle \subset S$  be the associated ideal, called a Hibi ideal. The associated ring  $R[\mathcal{L}] = S/I$  is called a Hibi ring.

Hibi rings were introduced by Hibi in his paper [11], he studied  $R[\mathcal{L}]$  as an algebra with straightening laws on  $\mathcal{L}$  over the field  $K$ . He demonstrated that  $R[\mathcal{L}]$  is Gorenstein when the set of join irreducible elements  $J = \{z \in \mathcal{L} : x \vee y = z \Rightarrow x = z \text{ or } y = z\}$  is pure i.e. all maximal chains have the same length. In the same paper, it is shown  $R[\mathcal{L}]$  is a Cohen-Macaulay normal domain if  $\mathcal{L}$  is distributive. Further, Hibi ideal is prime if and only if  $\mathcal{L}$  is distributive [11].

Herzog-Hibi ([10], Theorem 10.1.3), showed that the diamond relations  $f_{(\alpha, \beta)}$  form a Gröbner basis with respect to the reverse lexicographic term order on  $S$  extending the order of  $\mathcal{L}$ . The ring appears in geometric context in Lakshmibai-Gonciulea [8], where it is proved that the Schubert varieties in  $G_{d,n}$  degenerate flatly to the toric varieties  $X(I_{d,n}) (= X_{d,n}$  as in [8]) which are varieties associated to the lattices  $I_{d,n} = \{(i_1, \dots, i_d) : 1 \leq i_1 < \dots < i_d \leq n\}$ . In the same paper, using the degeneration, several geometric properties for the Schubert varieties were derived. The question of singularity of the variety associated with the Hibi ideal is dealt with in Wagner, [16]. Lakshmibai-Mukherjee, [12], gives a standard monomial basis for the tangent space at a singular point for these varieties, they used the standard monomial basis to compute the tangent cone at these singular point, [13]. The question of free resolution of Hibi rings has been addressed in a few recent papers, [5], [15], for a modular non-distributive lattice. Rodica-Ene-Hibi give a lower bound for the regularity of  $I$  (Theorem 2.2, [15]) and in (Theorem 1.1, [7]) authors have given the regularity of Hibi ring of any finite distributive lattice in terms of its poset of join-irreducibles. Hibi rings over a finite distributive lattice are further studied by several authors in, [1], [2], [3], [6] to mention but a few. Construction of an explicit minimal graded free resolutions of classes of graded modules is difficult [14] i.e. to find the explicit generators of the modules is a challenging problem. In particular for distributive lattices, the following problems may be asked

- (1) What are the explicit minimal generators of the first syzygy of  $R[\mathcal{L}]$ , in terms of the the lattice  $\mathcal{L}$ ?
- (2) Find an exact formula for the first Betti number of  $R[\mathcal{L}]$ .

The present paper deals with these two questions for finite planar distributive lattices. Our approach is that the generators are linked with certain kind of sublattices of the lattice  $\mathcal{L}$ , as a result it is easier to verify conditions such as linearity of the generators.

In our theorem (Theorem 3.16 and Theorem 3.18) we have totally characterized the lattices for which the syzygy is linear, although such theorem is available in literature [5] our result has a different description

---

*Key words and phrases.* Hibi ring, lattice, syzygy, Betti number.  
AMS Classification 2010. Primary: 05E40, 06D75, 03G10, 16E05.

that relies on the number of join meet irreducibles. In the very useful survey paper (which also contains a few new results by the author) [5], Ene answers when  $R[\mathcal{L}]$  has a linear resolution and characterizes the lattices for which  $I$  is linearly related.

The following is our main theorem that totally characterizes the syzygy generators for the Hibi ideal of a planar distributive lattice in terms of certain relations arising out of sublattices. The novelty of this theorem is that a-priori there is no reason why the minimal generators of the syzygy module should even be related to certain sublattices, let alone a small number of such sublattices.

Sublattices isomorphic to the following three, we call them classifying sublattices, in the figure 4.7 give rise to all the linear first syzygy elements. The first one (a) gives rise two two types of generators we call them  $S_1, S_2$  the next one (b) gives rise to the type  $L$  and the last one (c) gives rise to two generators  $B_1, B_2$ .

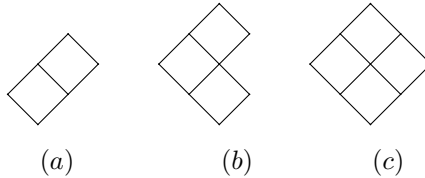

FIGURE 1. Classifying sublattices

**Theorem 1.1** (Theorem 3.6).  $Syz_1^1 R[\mathcal{L}]$  is generated by the types  $S_1, S_2, L, B_1, B_2$ .

In Theorem 1.1,  $Syz_1^1 R[\mathcal{L}]$  denotes linear generators of first syzygy of  $R[\mathcal{L}]$ . This main result of this paper is quoted in the theorem below. This theorem along with the quadratic elements coming from the *non-expressible* generators do form a linearly independent set of generators for the first syzygy module for the Hibi ideals, quoted in the Theorem 1.2. In particular, it also characterizes when  $R[\mathcal{L}]$  is linearly related.

**Theorem 1.2** (Theorem 3.16).  $Syz_1^2 R[\mathcal{L}]$  is trivial if and only if every pair of comparable diamonds in  $\mathcal{D}_2$  are expressible.

In Theorem 1.2,  $Syz_1^2 R[\mathcal{L}]$  denote the set of all diamond type (for definition see 3.8) generators of first syzygy of  $R[\mathcal{L}]$ .

Let  $JM$  be the set of join-meet irreducible elements of a lattice  $\mathcal{L}$  and let us denote  $k(\mathcal{L}) = \#\{(\theta_i, \theta_j) : \theta_i \approx \theta_j, \theta_i, \theta_j \in JM\}$ .

**Theorem 1.3** (Theorem 3.18). *With the above notations, we have the following*

- (1) When  $k(\mathcal{L}) = 1$ , the first syzygy of  $R[\mathcal{L}]$  is linear.
- (2) When  $k(\mathcal{L}) = 2$ ,
  - (a) If the lattice is Figure 7, then first syzygy is non linear.
  - (b) Else if the lattice is Figure 8, then first syzygy is linear if and only if  $ht(\theta_2 \wedge \theta_3) - ht(\theta_1 \wedge \theta_2) = 1$  or  $ht(\theta_2 \vee \theta_3) - ht(\theta_1 \vee \theta_2) = 1$ , where  $\theta_1, \theta_2, \theta_3 \in JM$ .
- (3) If  $k(\mathcal{L}) \geq 3$  then the first syzygy is non linear.

The paper is structured as follows. In Section 2, we collect basic notations, terminology, and results that will be used in the paper. The first syzygy of Hibi rings is discussed in Section 3. Explicit expression for the first Betti number for planar distributive lattices has been discussed in Section 4.

## 2. PRELIMINARIES

In this section, we introduce definitions and results needed in the next section. Let  $(P, \leq)$  be a poset with partial order relation  $\leq$ . The *height* of an element  $a \in P$ , denoted by  $ht(a)$  is the supremum of length of chains  $C$ , descending from  $a$ . A *lattice*  $\mathcal{L}$  is a poset such that for all  $x, y \in \mathcal{L}$ ,  $x \vee y, x \wedge y$  exists. A lattice  $\mathcal{L}_1$  is called *sublattice* of the lattice  $\mathcal{L}$  if  $\mathcal{L}_1 \subset \mathcal{L}$  and  $x, y \in \mathcal{L}_1$  implies  $x \vee y \in \mathcal{L}_1$  and  $x \wedge y \in \mathcal{L}_1$ . Let

$C_{m+1}$  be the chain  $1 < 2 < \dots < m + 1$ , then  $G(m, n) = C_{m+1} \times C_{n+1}$  be the product lattice, we call  $G(m, n)$  an  $m \times n$  grid lattice. A finite lattice  $\mathcal{L}$  is called *planar* if and only if there is an embedding of  $\mathcal{L}$  in grid lattice  $G(m, n)$  for some  $m, n$ . In a lattice  $\mathcal{L}$ , an element  $x \in \mathcal{L}$  is said to be *join irreducible* if  $x = y \vee z$  then  $x = y$  or  $x = z$  for  $x, y, z \in \mathcal{L}$  and is called *meet irreducible* if  $x = y \wedge z$  then  $x = y$  or  $x = z$ .

A non-empty subset  $\mathcal{I}(\mathcal{L})$  of a poset  $P$  is called *poset ideal* if for any  $x \in \mathcal{I}(\mathcal{L})$  and  $y \in P$  if  $y \leq x$  then  $y \in \mathcal{I}(\mathcal{L})$ . Now we state the fundamental theorem of distributive lattice which is implicitly used in the paper.

**Theorem 2.1** (Birkhoff Theorem, [9]). *Let  $\mathcal{L}$  be a distributive lattice and  $P$  be the poset of join-irreducible elements. Then  $\mathcal{L} \simeq I(P)$ .*

Let  $S = K[x_1, x_2, \dots, x_n]$  be a polynomial ring over a field  $K$ . If  $>$  is a monomial order then for any  $f \in S$ , the initial term of  $f$ ,  $in_>(f)$ , is the greatest term of  $f$  with respect to the order  $>$ . We will use,  $in(f)$ , when the order is understood. Let  $m, n$  be two monomials of the polynomial ring  $S$ , let  $a = (a_1, \dots, a_n), b = (b_1, \dots, b_n)$  the multi indices of  $m, n$  respectively. Then the *reverse lexicographic order* is defined by  $m >_{rlex} n$  if and only if  $\deg(m) > \deg(n)$  or  $\deg(m) = \deg(n)$  and  $a_i < b_i$  for the least integer  $i$  with  $a_i \neq b_i$ .

To find the first syzygy we are frequently using the following ([4], for more details). Let  $F$  be a free module with basis and  $M$  be a submodule of  $F$  generated by monomials  $m_1, \dots, m_t$ . Let  $\phi : \bigoplus_{j=1}^t S\varepsilon_j \rightarrow F$  be a homomorphism defined by  $\varepsilon_i \mapsto m_j$ , whose image is  $M$ . For each pair of indices  $i$  and  $j$  such that  $m_i, m_j$  involve same basis element of  $F$ , we define  $m_{ij} = m_i / \gcd(m_i, m_j)$  and let  $\ker\phi = \sigma_{ij}$  is given by  $\sigma_{ij} = m_{ji}\varepsilon_i - m_{ij}\varepsilon_j$ .

**Lemma 2.2** (Lemma [4]). *With the same notation as above,  $\ker\phi$  is generated by the  $\sigma_{ij}$ .*

### 3. FIRST SYZYGY OF HIBI RINGS

In this section, we find explicitly the generators of the first syzygy of Hibi ring for a planar distributive lattice and also find a condition for which the first syzygy linear.

Let  $f_1, f_2, \dots, f_n$  be all the diamond relations in  $I$ . Let us denote  $F = \bigoplus_{i=1}^n S(-2)$  and  $g_1, g_2, \dots, g_n$  be the generators of  $F$ ,  $\phi : F \rightarrow S$ ,  $g_i \mapsto f_i$ ,  $\ker(\phi)$  is the first syzygy of  $R[\mathcal{L}]$ . Let us denote  $\ker(\phi) = \text{Syz}^1 R[\mathcal{L}]$  and  $\text{Syz}_1^1 R[\mathcal{L}]$  denote linear generators of the  $R[\mathcal{L}]$ -module  $\text{Syz}^1 R[\mathcal{L}]$ .

Let  $Q = \{\alpha, \beta, \gamma, \delta\}$  be a poset  $\leq$  defined by  $\alpha \leq \beta, \gamma, \delta$ , where  $\beta, \gamma, \delta$  are mutually non-comparable. Let the lattice of the poset ideals of  $Q$  be called a cube lattice.

**Lemma 3.1.**  *$\mathcal{L}$  is a planar distributive lattice if and only if every join irreducible (meet irreducible)  $\beta \in \mathcal{L}$  is covered (covers) by at most two join irreducibles (meet irreducibles) in  $\mathcal{L}$ .*

*Proof.*  $\Rightarrow$ : Let  $\mathcal{L}$  be a planar distributive lattice and  $\beta \in \mathcal{L}$  be a join-irreducible element. Let us assume that it is covered by three join-irreducible elements  $x, y, z$  in  $\mathcal{L}$ . Then  $x \vee y, x \vee z, y \vee z$  are non-comparable. Hence there will be a cube sublattice in  $\mathcal{L}$ , which is non-planar.

$\Leftarrow$ : Let every join-irreducible  $\beta$  in  $\mathcal{L}$  covered by at most two join-irreducible in  $\mathcal{L}$ , let this property be called (\*). Then every sublattice of  $\mathcal{L}$  also has the property (\*). Now if  $\mathcal{L}$  is not planar then there exist a cube sublattice in  $\mathcal{L}$ , then this sublattice violates the property (\*), as the cube has three join-irreducible elements covering the minimal element which is a join-irreducible. Hence we arrive at a contradiction. By duality we get the result with meet irreducibles.  $\square$

**Lemma 3.2.**  *$\mathcal{L}$  is a planar distributive lattice if and only if for every  $x, y, z \in \mathcal{L}$ ,  $x \vee y, y \vee z, x \vee z$  are comparable.*

*Proof.*  $\Rightarrow$ : Let  $\mathcal{L}$  be a planar distributive lattice. Let  $x, y, z \in \mathcal{L}$ , then the sublattice generated by  $x \wedge y, x \wedge z, y \wedge z$  are also planar. If  $x \wedge y, x \wedge z, y \wedge z$  are not comparable to each other then we will get three join-irreducibles covering minimal element. Therefore by Lemma 3.1, we will arrive at a contradiction. Hence  $x \wedge y \sim x \wedge z$  and by duality other also holds.

$\Leftarrow$ : Let the given conditions hold. Then we have the cases (i)  $x \vee y \leq x \vee z$ ,  $x \wedge y \leq x \wedge z$  (ii)  $x \vee y \geq x \vee z$ ,  $x \wedge y \leq x \wedge z$  (iii)  $x \vee y \geq x \vee z$ ,  $x \wedge y \geq x \wedge z$ . Then the only possibilities to get the sublattices as in Figure 1 and Figure 2, which are all planar sublattices. Hence  $\mathcal{L}$  is planar.  $\square$

Let us take two diamond relations  $f_{(\alpha_1, \beta_1)} = x_{\alpha_1}x_{\beta_1} - x_{\alpha_1 \vee \beta_1}x_{\alpha_1 \wedge \beta_1}$  and  $f_{(\alpha_2, \beta_2)} = x_{\alpha_2}x_{\beta_2} - x_{\alpha_2 \vee \beta_2}x_{\alpha_2 \wedge \beta_2}$  coming from the diamonds  $(\alpha_1, \beta_1)$  and  $(\alpha_2, \beta_2)$  respectively. Then with respect to reverse lexicographic order  $>$ , we have  $\text{in}(f_{(\alpha_1, \beta_1)}) = x_{\alpha_1}x_{\beta_1}$ ,  $\text{in}(f_{(\alpha_2, \beta_2)}) = x_{\alpha_2}x_{\beta_2}$ . Then we have the following cases

CASE 1:  $\alpha_1 = \alpha_2$  or  $\alpha_1 = \beta_2$  or  $\beta_1 = \alpha_2$  or  $\beta_1 = \beta_2$ .

CASE 2:  $\alpha_1, \alpha_2, \beta_1, \beta_2$  all are different (it is dealt with definition 3.8 and after).

For CASE 1, without a loss of generality, let us suppose  $\alpha_1 = \alpha_2$ . Then we have  $\text{in}(f_{(\alpha_1, \beta_1)}) = x_{\alpha_1}x_{\beta_1}$ ,  $\text{in}(f_{(\alpha_1, \beta_2)}) = x_{\alpha_1}x_{\beta_2}$  and therefore,  $\text{Lcm}(f_{(\alpha_1, \beta_1)}, f_{(\alpha_1, \beta_2)}) = x_{\alpha_1}x_{\beta_1}x_{\beta_2}$ . So,

$$\begin{aligned} S(f_{(\alpha_1, \beta_1)}, f_{(\alpha_1, \beta_2)}) &= x_{\beta_2}f_{(\alpha_1, \beta_1)} - x_{\beta_1}f_{(\alpha_1, \beta_2)} \\ &= x_{\beta_1}x_{\alpha_1 \vee \beta_2}x_{\alpha_1 \wedge \beta_2} - x_{\beta_2}x_{\alpha_1 \vee \beta_1}x_{\alpha_1 \wedge \beta_1} \end{aligned}$$

Then either  $\beta_1 \sim \beta_2$ , let us say  $\beta_1 \leq \beta_2$  or  $\beta_1 \approx \beta_2$ . So we have the following subcases

SUBCASE 1:  $\beta_1 \leq \beta_2$

SUBCASE 2:  $\beta_1 \approx \beta_2$

Also by Lemma 3.2, for  $\alpha_1, \beta_1, \beta_2$  we have  $\alpha_1 \wedge \beta_1 \sim \alpha_1 \wedge \beta_2$  and  $\alpha_1 \vee \beta_1 \sim \alpha_1 \vee \beta_2$ . Then we have the only following possibilities

- (1)  $\alpha_1 \wedge \beta_1 \leq \alpha_1 \wedge \beta_2$ ,  $\alpha_1 \vee \beta_1 \leq \alpha_1 \vee \beta_2$ .
- (2)  $\alpha_1 \wedge \beta_1 \geq \alpha_1 \wedge \beta_2$ ,  $\alpha_1 \vee \beta_1 \leq \alpha_1 \vee \beta_2$ .
- (3)  $\alpha_1 \wedge \beta_1 \leq \alpha_1 \wedge \beta_2$ ,  $\alpha_1 \vee \beta_1 \geq \alpha_1 \vee \beta_2$ .

Now we verify all the above cases

SUBCASE 1: When  $\beta_1 \leq \beta_2$ .

- From the condition (1), we get a sublattice isomorphic to that in Figure 2. (a).

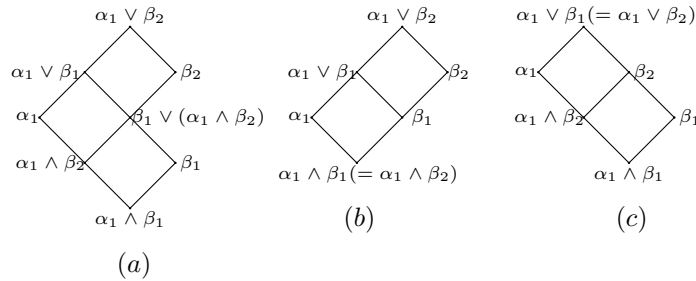

FIGURE 2.

- We get from the condition (2), a sublattice isomorphic to that in Figure 2. (b).
- The condition (3), leads us a sublattice isomorphic to that in Figure 2. (c).

SUBCASE 2: When  $\beta_1 \approx \beta_2$ .

- From the condition (1), we will not get any lattice which satisfies the given condition, since from this we get  $\beta_1 \leq \beta_2$ , then it will give us a contradiction.
- From the condition (2) we get the sublattice isomorphic to that in Figure 3.

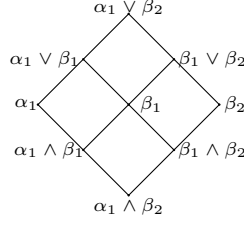

FIGURE 3.

- The condition (3), will give the same sublattice isomorphic to that in Figure 3, by replacing  $\beta_1$  and  $\beta_2$  by  $\beta_2$  and  $\beta_1$  respectively.

Let us denote  $\mathcal{D}_2 = \{(\alpha, \beta) : \alpha \approx \beta, \alpha, \beta \in \mathcal{L}\}$ . Now using the conditions of the above cases (for which lattice exists), we prove that the following are the types of the generators of the first syzygy of the Hibi ring.

**Lemma 3.3. (*Strip-type*)** Let  $(\alpha_1, \beta_1), (\alpha_1, \beta_2) \in \mathcal{D}_2$ , for every sublattice isomorphic to Figure 2.(b), with conditions  $\alpha_1 \vee \beta_1 \neq \alpha_1 \vee \beta_2, \alpha_1 \wedge \beta_1 = \alpha_1 \wedge \beta_2, \beta_1 \leq \beta_2, \beta_1 \leq \alpha_1 \vee \beta_2, \beta_1 \geq \alpha_1 \wedge \beta_2, \beta_2 \approx \alpha_1 \vee \beta_1, \beta_2 \geq \alpha_1 \wedge \beta_1$ , the following are the generators of the first syzygy

- (1)  $S_1 = -x_{\beta_2}g_{(\alpha_1, \beta_1)} + x_{\beta_1}g_{(\alpha_1, \beta_2)} - x_{\alpha_1 \wedge \beta_1}g_{(\beta_2, \alpha_1 \vee \beta_1)}$ .
- (2)  $S_2 = x_{\alpha_1 \vee \beta_2}g_{(\alpha_1, \beta_1)} - x_{\alpha_1 \vee \beta_1}g_{(\alpha_1, \beta_2)} + x_{\alpha_1}g_{(\beta_2, \alpha_1 \vee \beta_1)}$ .

*Proof.* (1)  $S(f_{(\alpha_1, \beta_1)}, f_{(\alpha_1, \beta_2)}) = x_{\beta_2}f_{(\alpha_1, \beta_1)} - x_{\beta_1}f_{(\alpha_1, \beta_2)} = x_{\beta_1}x_{\alpha_1 \vee \beta_2}x_{\alpha_1 \wedge \beta_2} - x_{\beta_2}x_{\alpha_1 \vee \beta_1}x_{\alpha_1 \wedge \beta_1} = -x_{\alpha_1 \wedge \beta_1}(x_{\beta_2}x_{\alpha_1 \vee \beta_1} - x_{\beta_1}x_{\alpha_1 \vee \beta_2}) = -x_{\alpha_1 \wedge \beta_1}f_{(\beta_2, \alpha_1 \vee \beta_1)}$ , as  $\beta_2 \approx \alpha_1 \vee \beta_1$ .

Hence  $-x_{\beta_2}g_{(\alpha_1, \beta_1)} + x_{\beta_1}g_{(\alpha_1, \beta_2)} - x_{\alpha_1 \wedge \beta_1}g_{(\beta_2, \alpha_1 \vee \beta_1)}$  is a generator of the first syzygy.

- (2)  $S(f_{(\alpha_1, \beta_2)}, f_{(\beta_2, \alpha_1 \vee \beta_1)}) = x_{\alpha_1 \vee \beta_1}f_{(\alpha_1, \beta_2)} - x_{\alpha_1}f_{(\beta_2, \alpha_1 \vee \beta_1)} = x_{\alpha_1}x_{\beta_1}x_{\alpha_1 \vee \beta_2} - x_{\alpha_1 \vee \beta_1}x_{\alpha_1 \vee \beta_2}x_{\alpha_1 \wedge \beta_2} = x_{\alpha_1 \vee \beta_2}(x_{\alpha_1}x_{\beta_1} - x_{\alpha_1 \vee \beta_1}x_{\alpha_1 \wedge \beta_1}) = x_{\alpha_1 \vee \beta_2}f_{(\alpha_1, \beta_1)}$ .

Hence,  $x_{\alpha_1 \vee \beta_2}g_{(\alpha_1, \beta_1)} - x_{\alpha_1 \vee \beta_1}g_{(\alpha_1, \beta_2)} + x_{\alpha_1}g_{(\beta_2, \alpha_1 \vee \beta_1)}$  is a generator of the first syzygy.  $\square$

**Lemma 3.4. (*L-type*)** Let  $(\alpha_1, \beta_1), (\alpha_1, \beta_2) \in \mathcal{D}_2$ , for every sublattice isomorphic to Figure 2.(a), with conditions  $\alpha_1 \wedge \beta_1 \neq \alpha_1 \wedge \beta_2, \alpha_1 \vee \beta_1 \neq \alpha_1 \vee \beta_2, \beta_1 \leq \beta_2, \beta_1 \leq \alpha_1 \vee \beta_2, \beta_1 \approx \alpha_1 \wedge \beta_2, \beta_2 \approx \alpha_1 \vee \beta_1, \beta_2 \geq \alpha_1 \wedge \beta_1$  the following is a generator of the first syzygy

$$L = -x_{\beta_2}g_{(\alpha_1, \beta_1)} + x_{\beta_1}g_{(\alpha_1, \beta_2)} + x_{\alpha_1 \vee \beta_2}g_{(\beta_1, \alpha_1 \wedge \beta_2)} - x_{\alpha_1 \wedge \beta_1}g_{(\beta_2, \alpha_1 \vee \beta_1)}.$$

*Proof.*  $S(f_{(\alpha_1, \beta_1)}, f_{(\alpha_1, \beta_2)}) = x_{\beta_2}f_{(\alpha_1, \beta_1)} - x_{\beta_1}f_{(\alpha_1, \beta_2)} = x_{\beta_1}x_{\alpha_1 \vee \beta_2}x_{\alpha_1 \wedge \beta_2} - x_{\beta_2}x_{\alpha_1 \vee \beta_1}x_{\alpha_1 \wedge \beta_1} = -x_{\alpha_1 \wedge \beta_1}(x_{\beta_2}x_{\alpha_1 \vee \beta_1} - x_{\alpha_1 \vee \beta_2}x_{\beta_2 \wedge (\alpha_1 \vee \beta_1)}) + x_{\alpha_1 \vee \beta_2}(x_{\beta_1}x_{\alpha_1 \wedge \beta_2} - x_{\alpha_1 \wedge \beta_1}x_{\beta_1 \vee (\alpha_1 \wedge \beta_2)}) = -x_{\alpha_1 \wedge \beta_1}f_{(\beta_2, \alpha_1 \vee \beta_1)} + x_{\alpha_1 \vee \beta_2}f_{(\beta_1, \alpha_1 \wedge \beta_2)}$ , where the third equality follows as,  $\beta_1 \vee (\alpha_1 \wedge \beta_2) = \beta_2 \wedge (\alpha_1 \vee \beta_1)$ .

Hence  $-x_{\beta_2}g_{(\alpha_1, \beta_1)} + x_{\beta_1}g_{(\alpha_1, \beta_2)} + x_{\alpha_1 \vee \beta_2}g_{(\beta_1, \alpha_1 \wedge \beta_2)} - x_{\alpha_1 \wedge \beta_1}g_{(\beta_2, \alpha_1 \vee \beta_1)}$  is a generator of the first syzygy.  $\square$

**Lemma 3.5. (*Box-type*)** Let  $(\alpha_1, \beta_1), (\alpha_1, \beta_2) \in \mathcal{D}_2$ , for every sublattice isomorphic to Figure 3, with conditions  $\alpha_1 \wedge \beta_1 \neq \alpha_1 \wedge \beta_2, \alpha_1 \vee \beta_1 \neq \alpha_1 \vee \beta_2, \beta_1 \approx \beta_2, \beta_1 \leq \alpha_1 \vee \beta_2, \beta_1 \geq \alpha_1 \wedge \beta_2, \beta_2 \approx \alpha_1 \vee \beta_1, \beta_2 \approx \alpha_1 \wedge \beta_1$  the following are the generators of the first syzygy

- (1)  $B_1 = -x_{\beta_2}g_{(\alpha_1, \beta_1)} + x_{\beta_1}g_{(\alpha_1, \beta_2)} - x_{\alpha_1 \vee \beta_1}g_{(\beta_2, \alpha_1 \wedge \beta_1)} - x_{\alpha_1 \wedge \beta_2}g_{(\alpha_1 \vee \beta_1, \beta_1 \vee \beta_2)}$ .
- (2)  $B_2 = -x_{\beta_1}g_{(\alpha_1, \beta_2)} + x_{\alpha_1}g_{(\beta_1, \beta_2)} + x_{\beta_1 \vee \beta_2}g_{(\alpha_1, \beta_1 \wedge \beta_2)} + x_{\alpha_1 \wedge \beta_2}g_{(\alpha_1 \vee \beta_1), (\beta_1 \vee \beta_2)}$ .

*Proof.* (1)  $S(f_{(\alpha_1, \beta_1)}, f_{(\alpha_1, \beta_2)}) = x_{\beta_2}f_{(\alpha_1, \beta_1)} - x_{\beta_1}f_{(\alpha_1, \beta_2)} = x_{\beta_1}x_{\alpha_1 \vee \beta_2}x_{\alpha_1 \wedge \beta_2} - x_{\beta_2}x_{\alpha_1 \vee \beta_1}x_{\alpha_1 \wedge \beta_1} = -x_{\alpha_1 \vee \beta_1}(x_{\beta_2}x_{\alpha_1 \wedge \beta_1} - x_{\alpha_1 \wedge \beta_2}x_{\beta_1 \vee \beta_2}) - x_{\alpha_1 \wedge \beta_2}(x_{\alpha_1 \vee \beta_1}x_{\beta_1 \vee \beta_2} - x_{\alpha_1 \vee \beta_2}x_{\beta_1}) = -x_{\alpha_1 \vee \beta_1}f_{(\beta_2, \alpha_1 \wedge \beta_1)} - x_{\alpha_1 \wedge \beta_2}f_{(\alpha_1 \vee \beta_1, \beta_1 \vee \beta_2)}$ . Hence the lemma follows.

- (2)  $S(f_{(\alpha_1, \beta_2)}, f_{(\beta_1, \beta_2)}) = x_{\beta_1}f_{(\alpha_1, \beta_2)} - x_{\alpha_1}f_{(\beta_1, \beta_2)} = x_{\alpha_1}x_{\beta_1 \vee \beta_2}x_{\beta_1 \wedge \beta_2} - x_{\beta_1}x_{\alpha_1 \vee \beta_2}x_{\alpha_1 \wedge \beta_2} = x_{\beta_1 \vee \beta_2}(x_{\alpha_1}x_{\beta_1 \wedge \beta_2} - x_{\alpha_1 \wedge \beta_2}x_{\alpha_1 \vee \beta_1}) + x_{\alpha_1 \wedge \beta_2}(x_{\alpha_1 \vee \beta_1}x_{\beta_1 \vee \beta_2} - x_{\beta_1}x_{\alpha_1 \vee \beta_2}) = x_{\beta_1 \vee \beta_2}f_{(\alpha_1, \beta_1 \wedge \beta_2)} + x_{\alpha_1 \wedge \beta_2}f_{(\alpha_1 \vee \beta_1, \beta_1 \vee \beta_2)}$ . Hence the lemma follows.  $\square$

The following theorem gives us the linear generators for the first syzygy of  $R[\mathcal{L}]$ .

**Theorem 3.6.**  $Syz_1^1 R[\mathcal{L}]$  is generated by the types  $S_1, S_2, L, B_1, B_2$ .

*Proof.* Let  $f_{(\alpha_1, \beta_1)} = x_{\alpha_1}x_{\beta_1} - x_{\alpha_1 \vee \beta_1}x_{\alpha_1 \wedge \beta_1}$ ,  $f_{(\alpha_2, \beta_2)} = x_{\alpha_2}x_{\beta_2} - x_{\alpha_2 \vee \beta_2}x_{\alpha_2 \wedge \beta_2}$  be the relation coming from the diamonds  $(\alpha_1, \beta_1), (\alpha_2, \beta_2) \in \mathcal{D}_2$ . Therefore with respect to monomial ordering  $>$ ,  $\text{in}(f_{(\alpha_1, \beta_1)}) = x_{\alpha_1}x_{\beta_1}$ ,  $\text{in}(f_{(\alpha_2, \beta_2)}) = x_{\alpha_2}x_{\beta_2}$ . For the syzygy arising out of this S-polynomial the initial monomials must be non coprime. The only possibilities described in the Figures 2(c), 2(a) and Figure 3 and we showed in Lemmas 3.3, 3.4, 3.5 that these are indeed linear syzygies.  $\square$

**Definition 3.7.** A pair of comparable diamonds  $(\alpha_1, \beta_1), (\alpha_2, \beta_2) \in \mathcal{D}_2$  (satisfying the conditions (1) and (2)) is called expressible if it also satisfies the condition (3) and non-expressible otherwise.

- (1)  $\alpha_1, \beta_1, \alpha_2, \beta_2$  are all distinct.
- (2)  $\alpha_1 \vee \beta_1 < \alpha_2 \wedge \beta_2$ .
- (3) there exist  $a, b \in \mathcal{L}$  such that  $a \wedge b = \beta_1, a \vee b = \beta_2$  and  $\alpha_1, \alpha_2, a$  each non comparable to  $b$  and  $\alpha_2 \wedge b$  non comparable to  $\alpha_1 \vee \beta_1$ .

**Definition 3.8. (Diamond-type)** Let  $Syz_1^2 R[\mathcal{L}]$  be the  $R[\mathcal{L}]$ -module generated by

$$D = (x_{\alpha_2}x_{\beta_2} - x_{\alpha_2 \vee \beta_2}x_{\alpha_2 \wedge \beta_2})g_{(\alpha_1, \beta_1)} - (x_{\alpha_1}x_{\beta_1} - x_{\alpha_1 \vee \beta_1}x_{\alpha_1 \wedge \beta_1})g_{(\alpha_2, \beta_2)}$$

for every two non-expressible diamonds  $(\alpha_1, \beta_1), (\alpha_2, \beta_2) \in \mathcal{D}_2$  be called the diamond type syzygy of  $Syz^1 R[\mathcal{L}]$ .

**Remark 3.9.** By definition of  $Syz_1^1 R[\mathcal{L}]$  and  $Syz_1^2 R[\mathcal{L}]$  we have  $Syz^1 R[\mathcal{L}] = Syz_1^1 R[\mathcal{L}] \oplus Syz_1^2 R[\mathcal{L}]$ .

In the following lemma, it is made clear that the S-polynomial arising out of two expressible diamonds is linear combination of L-type syzygies. Note that in the light of Lemma 3.11, for a pair of expressible diamonds (2, 3), (11, 12) their is a diagram as in the lemma below 3.10

**Lemma 3.10.** In Figure 4, if  $f_{(2,3)}, f_{(11,12)}$  be the relations coming from the diamonds (2, 3), (11, 12) respectively. Then the S-polynomial arising out of these two diamonds can be expressed as a combination of L-type syzygies.

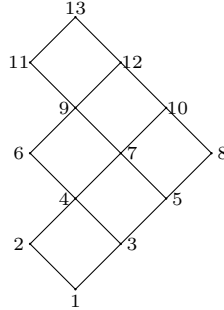

FIGURE 4.

*Proof.* Let  $f_{(2,3)} = x_2x_3 - x_1x_4$  and  $f_{(11,12)} = x_{11}x_{12} - x_9x_{13}$  be the relations coming from the diamonds (2, 3) and (11, 12) respectively. Then with respect to monomial ordering  $>$  we have  $\text{in}(f_{(2,3)}) = x_2x_3$  and  $\text{in}(f_{(11,12)}) = x_{11}x_{12}$ . So  $\text{Lcm}(f_{(2,3)}, f_{(11,12)}) = x_2x_3x_{11}x_{12}$ .  $S(f_{(2,3)}, f_{(11,12)}) = x_{11}x_{12}f_{(2,3)} - x_2x_3f_{(11,12)} = x_2x_3x_9x_{13} - x_1x_4x_{11}x_{12} = x_9x_{13}f_1 - x_1x_4f_6$ . Therefore  $(x_{11}x_{12} - x_9x_{13})g_{(2,3)} - (x_2x_3 - x_1x_4)g_{(11,12)}$  gives an element of the first syzygy. Now this expression can be written as  $(x_{11}x_{12} - x_9x_{13})g_{(2,3)} - (x_2x_3 - x_1x_4)g_{(11,12)} = x_{11}(x_{12}g_{(2,3)} - x_6g_{(2,8)} + x_2g_{(6,8)} - x_1g_{(6,10)}) - x_{13}(x_9g_{(2,3)} - x_6g_{(2,5)} + x_2g_{(5,6)} - x_1g_{(6,7)}) + x_6(x_{13}g_{(2,5)} - x_{11}g_{(2,8)} + x_2g_{(8,11)} - x_1g_{(10,11)}) + x_2(x_{13}g_{(5,6)} - x_{11}g_{(6,8)} + x_6g_{(8,11)} - x_3g_{(11,12)}) - x_1(x_{13}g_{(6,7)} - x_{11}g_{(6,10)} + x_6g_{(10,11)} - x_4g_{(11,12)})$  which shows that it is a combination of four L-type elements. Hence the lemma follows for this case.  $\square$

**Lemma 3.11.** *Let  $(\alpha_1, \beta_1), (\alpha_2, \beta_2) \in \mathcal{D}_2$  be two expressible diamonds then there is a sublattice of  $\mathcal{L}$  isomorphic to Figure 5.*

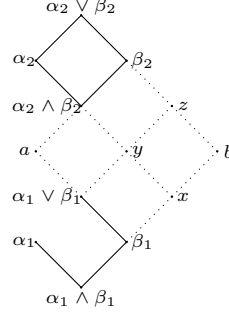

FIGURE 5.

*Proof.* In Figure 5, we have  $a \wedge b = \beta_1$  and  $a \vee b = \beta_2$ . Now we prove that there exist  $x, y, z \in \mathcal{L}$  such that the following holds.

- (1) There exist  $x$  such that  $x = \alpha_2 \wedge b = \alpha_2 \wedge \beta_2 \wedge b$  and  $\beta_1 < x < b$ . To prove this, let  $\alpha_2 \wedge b = x_1, (\alpha_2 \wedge \beta_2) \wedge b = x$ . Now since  $x_1 \vee \beta_2 = (\alpha_2 \wedge b) \vee \beta_2 = \beta_2, x \vee \beta_2 = ((\alpha_2 \wedge \beta_2) \wedge b) \vee \beta_2 = \beta_2, x_1 \wedge \beta_2 = (\alpha_2 \wedge b) \wedge \beta_2 = \alpha_2 \wedge b, x \wedge \beta_2 = ((\alpha_2 \wedge \beta_2) \wedge b) = \alpha_2 \wedge b$  then it implies  $x = x_1$  and since we have  $x = (\alpha_2 \wedge \beta_2) \wedge b$ . Let  $(\alpha_2 \wedge \beta_2) \wedge b = b$ . Then  $\alpha_2 \wedge \beta_2 \geq b$ . Since  $\alpha_1 > a, \beta_1 > b$ , then  $\alpha_1 \wedge \beta_1 > a \vee b = \beta_2$ , which is a contradiction. Hence it follows.
- (2)  $x \approx \alpha_1 \vee \beta_1, (\alpha_1 \vee \beta_1) \wedge x = \beta_1$ , as we have  $x \approx \alpha_1 \vee \beta_1, (\alpha_1 \vee \beta_1) \wedge x = (\alpha_1 \wedge x) \vee (\beta_1 \wedge x) = (\alpha_1 \wedge \beta_1) \vee \beta_1 = \beta_1$ .
- (3)  $a \vee x = \alpha_2 \wedge \beta_2$  and  $a \wedge x = \beta_1$ , since,  $a \vee x = a \vee [(\alpha_2 \wedge \beta_2) \wedge b] = (a \vee b) \wedge [a \vee (\alpha_2 \wedge \beta_2)] = \beta_2 \wedge (\alpha_2 \wedge \beta_2) = \alpha_2 \wedge \beta_2$  and  $a \wedge x = a \wedge [(\alpha_2 \wedge \beta_2) \wedge b] = \beta_1 \wedge (\alpha_2 \wedge \beta_2) = \beta_1$ .
- (4)  $y \wedge b = x$ , where  $y = (\alpha_1 \vee \beta_1) \vee x$ , as  $[(\alpha_1 \vee \beta_1) \vee x] \wedge b = [(\alpha_1 \vee \beta_1) \wedge b] \vee (x \wedge b) = \beta_1 \vee x = x$ .
- (5)  $a \vee y = \alpha_2 \wedge \beta_2$  and  $a \wedge y = \alpha_1 \wedge \beta_1$ , since  $a \vee [(\alpha_1 \vee \beta_1) \vee x] = [a \vee (\alpha_1 \vee \beta_1)] \vee x = a \vee x = \alpha_2 \wedge \beta_2$ . and  $a \wedge [(\alpha_1 \vee \beta_1) \vee x] = (a \wedge x) \vee [a \wedge (\alpha_1 \vee \beta_1)] = \beta_1 \vee (\alpha_1 \vee \beta_1) = \alpha_1 \vee \beta_1$ .
- (6)  $(\alpha_2 \wedge \beta_2) \wedge z = y$  and  $(\alpha_2 \wedge \beta_2) \vee z = \beta_2$ , where  $z = (\alpha_1 \vee \beta_1) \vee b$ , as  $(\alpha_2 \wedge \beta_2) \wedge [(\alpha_1 \vee \beta_1) \vee b] = [(\alpha_2 \wedge \beta_2) \wedge (\alpha_1 \vee \beta_1)] \vee [(\alpha_2 \wedge \beta_2) \wedge b] = (\alpha_1 \vee \beta_1) \vee x = y$  and  $(\alpha_2 \wedge \beta_2) \vee [(\alpha_1 \vee \beta_1) \vee b] = (\alpha_2 \wedge \beta_2) \vee (\alpha_1 \vee \beta_1) = (\alpha_2 \wedge \beta_2) \vee b = \beta_2$ .

□

**Lemma 3.12.** *For every pair of diamonds  $(\alpha_1, \beta_1), (\alpha_2, \beta_2) \in \mathcal{D}_2$  the syzygy*

$$Z = (x_{\alpha_2} x_{\beta_2} - x_{\alpha_2 \vee \beta_2} x_{\alpha_2 \wedge \beta_2}) g_{(\alpha_1, \beta_1)} - (x_{\alpha_1} x_{\beta_1} - x_{\alpha_1 \vee \beta_1} x_{\alpha_1 \wedge \beta_1}) g_{(\alpha_2, \beta_2)}$$

*is congruent to a syzygy  $S$  in  $\text{Syz}_1^2 R[\mathcal{L}]$  modulo  $\text{Syz}_1^1 R[\mathcal{L}]$ . Further if a pair of comparable diamonds are non-expressible then the syzygy element  $S$  is not zero.*

*Proof.* If the syzygy  $Z$  is expressible then by Lemma 3.10 it belongs to  $\text{Syz}_1^1 R[\mathcal{L}]$ . If  $Z$  is not expressible then there will not exist a sublattice as in Figure 5. (see Lemma 3.11). So, without loss of generality one of the following cases will arise.

CASE 1:  $\alpha_1 \leq \alpha_2, \alpha_1 \leq \beta_2, \beta_1 \leq \alpha_2, \beta_1 \approx \beta_2$

In this case, we can have the lattices isomorphic to the following sublattices Figure 6. (a) and (b).

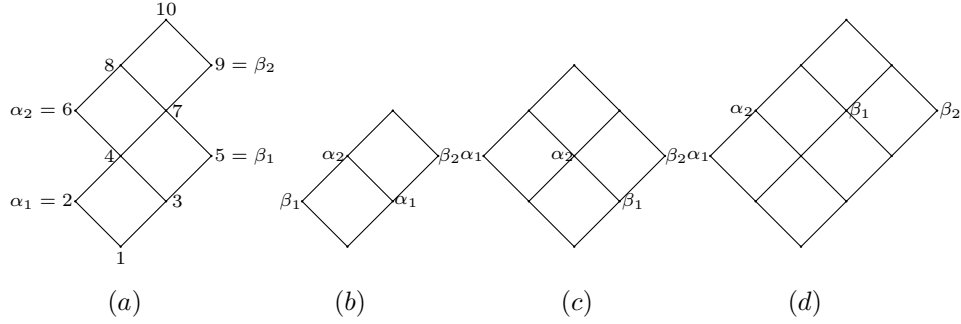

FIGURE 6.

In Figure 6. (a), numbering the lattice we have the syzygy from the diamonds  $(\alpha_1, \beta_1), (\alpha_2, \beta_2)$  that is  $(2, 5), (6, 9)$  is

$Z = (x_6x_9 - x_4x_{10})g_{(2,5)} - (x_2x_5 - x_1x_7)g_{(6,9)} = x_2[-x_9g_{(5,6)} + x_5g_{(6,9)} + x_{10}g_{(4,5)} - x_3g_{(8,9)}] + x_9[-x_6g_{(2,5)} + x_2g_{(5,6)} + x_8g_{(2,3)} - x_1g_{(6,7)}] + x_{10}[x_4g_{(2,5)} - x_2g_{(4,5)} - x_7g_{(2,3)}] + x_1[x_4g_{(8,9)} - x_7g_{(6,9)} + x_9g_{(6,7)}] + (x_2x_3 - x_1x_4)g_{(8,9)} - (x_8x_9 - x_7x_{10})g_{(2,3)}$ , which is  $S = (x_2x_3 - x_1x_4)g_{(8,9)} - (x_8x_9 - x_7x_{10})g_{(2,3)}$  modulo  $\text{Syz}_1^1R[\mathcal{L}]$  and it belongs to  $\text{Syz}_1^2R[\mathcal{L}]$ . In Figure 6. (b), the lattice is Grid lattice  $G(1, 2)$ , then the syzygy  $Z$  is in  $\text{Syz}_1^1R[\mathcal{L}]$ .

CASE 2:  $\alpha_1 \approx \alpha_2, \alpha_1 \approx \beta_2, \beta_1 \leq \alpha_2, \beta_1 \approx \beta_2$

In this case, we can have a sublattice isomorphic to the lattice Figure 5.(c). Since the lattice Figure 6.(c), is Grid lattice  $G(2, 2)$  then the syzygy  $Z$  belongs to  $\text{Syz}_1^1R[\mathcal{L}]$ .

CASE 3:  $\alpha_1 \leq \alpha_2, \alpha_1 \approx \beta_2, \beta_1 \approx \alpha_2, \beta_1 \approx \beta_2$

In this case, we can have a sublattice isomorphic to the following lattice Figure 6.(d). Since the lattice is Grid lattice  $G(2, 3)$  then it belongs to  $\text{Syz}_1^1R[\mathcal{L}]$ . Therefore, by above we have for a pair of comparable diamonds which are non-expressible is not zero. Hence the claim.  $\square$

**Corollary 3.13.** *Let  $(D_{i_1}, D_{j_1}), (D_{i_2}, D_{j_2}), \dots, (D_{i_n}, D_{j_n})$  be  $n$ -pairs of distinct non-expressible diamonds and let  $f_1, f_2, \dots, f_n$  be the corresponding syzygies. Then  $f_1, f_2, \dots, f_n$  are  $k$ -linearly independent.*

*Proof.* The syzygy element  $f_i$  has the expression  $f_i = (x_{\alpha_2}x_{\beta_2} - x_{\alpha_2 \vee \beta_2}x_{\alpha_2 \wedge \beta_2})g_{(\alpha_1, \beta_1)} - (x_{\alpha_1}x_{\beta_1} - x_{\alpha_1 \vee \beta_1}x_{\alpha_1 \wedge \beta_1})g_{(\alpha_2, \beta_2)}$ , where  $(\alpha_1, \beta_1), (\alpha_2, \beta_2) \in \mathcal{D}_2$  are the two diamonds. Since the two diamonds are distinct, then  $g_{(\alpha_i, \beta_i)}$  are distinct basis elements for  $i \neq j$ . So, clearly these are  $k$ -linearly independent.  $\square$

**Remark 3.14.** *Using the corollary 3.13 we can find the rank of the module  $\text{Syz}_1^2(\mathcal{L})$ , we call it by the number  $n_{\mathcal{D}}R[\mathcal{L}]$ .*

**Lemma 3.15.** *Let  $(\alpha_1, \beta_1), (\alpha_2, \beta_2) \in \mathcal{D}_2$ , the syzygy  $Z = (x_{\alpha_2}x_{\beta_2} - x_{\alpha_2 \vee \beta_2}x_{\alpha_2 \wedge \beta_2})g_{(\alpha_1, \beta_1)} - (x_{\alpha_1}x_{\beta_1} - x_{\alpha_1 \vee \beta_1}x_{\alpha_1 \wedge \beta_1})g_{(\alpha_2, \beta_2)}$  arising out of these two diamonds is expressible by strip, L, box types then there is a sublattice as in Figure 7.*

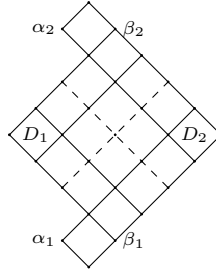

FIGURE 7.



*Proof.* We will show that if there is no sublattice isomorphic to the Figure 6, then the syzygy element  $(x_{\alpha_2}x_{\beta_2} - x_{\alpha_2 \vee \beta_2}x_{\alpha_2 \wedge \beta_2})g_{(\alpha_1, \beta_1)} - (x_{\alpha_1}x_{\beta_1} - x_{\alpha_1 \vee \beta_1}x_{\alpha_1 \wedge \beta_1})g_{(\alpha_2, \beta_2)}$  cannot be written as a combination of the linear syzygies. We argue in the following way if there is no sublattice isomorphic to the one in the figure, it must be a sublattice of the same. We will show for maximal sublattices of the syzygy element cannot be written as a combination of linear syzygies thus arriving at a contradiction.

A maximal sublattice must have either one of the two corner diamonds are missing. So let either the diamond  $D_1$  or  $D_2$  (in Figure 7) be missing. Let us say  $D_1$  is missing. Then  $x_{\alpha_2}g_{(\alpha_1, \beta_1)}$  or  $x_{\beta_2}g_{(\alpha_1, \beta_1)}$  is a term of a syzygy generator. But from the figure we see that the coefficient of  $g_{(\alpha_1, \beta_1)}$  could only be the points which are thick in the figure and we see that  $x_{\alpha_2}$  or  $x_{\beta_2}$  is not there. Thus this element cannot be expressed as a combination of other type of syzygy generators. Similarly, we can show that if the diamond  $D_2$  is not there.  $\square$

**Theorem 3.16.**  *$\text{Syz}_1^2 R[\mathcal{L}]$  is trivial if and only if every pair of comparable diamonds in  $\mathcal{D}_2$  are expressible.*

*Proof.* If every pair of diamonds in the lattice  $\mathcal{L}$  is expressible then by definition the module  $\text{Syz}_1^2 R[\mathcal{L}]$  is trivial. Now, for the other direction let us assume the module  $\text{Syz}_1^2 R[\mathcal{L}]$  is trivial and further let us assume that there is a syzygy  $Z$  which is not expressible. As a result of the Lemma 3.12 we know that the syzygy element associated to this syzygy is in  $\text{Syz}_1^2 R[\mathcal{L}]$  modulo  $\text{Syz}_1 R[\mathcal{L}]$ . Now, since  $\text{Syz}_1^2 R[\mathcal{L}]$  is trivial it must be congruent to zero modulo the linear syzygy module. Thus the syzygy  $Z$  is expressible.  $\square$

**Remark 3.17.** *The Theorem 3.16, tells us when the first syzygy is linear, i.e. when all the comparable diamonds are expressible. In particular, for the grid lattice  $G(m, n)$  the first syzygies are linear.*

In the following section we will refine our result for linearity of the first syzygy even stronger by showing that it only depends on the number of pairs of join-meet irreducibles. Let  $JM$  be the set of join-meet irreducibles of the lattice  $\mathcal{L}$  and let  $k(\mathcal{L}) = \#\{(\theta_i, \theta_j) : \theta_i \approx \theta_j, \theta_i, \theta_j \in JM\}$ .

**Theorem 3.18.** *With above notations we have the following*

- (1) *When  $k(\mathcal{L}) = 1$ , the first syzygy of  $R[\mathcal{L}]$  is linear.*
- (2) *When  $k(\mathcal{L}) = 2$ ,*
  - (a) *If the lattice is Figure 8, then first syzygy is non linear.*
  - (b) *Else if the lattice is Figure 9, then first syzygy is linear if and only if  $ht(\theta_2 \wedge \theta_3) - ht(\theta_1 \wedge \theta_2) = 1$  or  $ht(\theta_2 \vee \theta_3) - ht(\theta_1 \vee \theta_2) = 1$ , where  $\theta_1, \theta_2, \theta_3 \in JM$ .*
- (3) *If  $k(\mathcal{L}) \geq 3$  then the first syzygy is non linear.*

*Proof.* (1) Since  $k(\mathcal{L}) = 1$  then it is a grid lattice. Therefore, by Remark 3.17 it is linear.

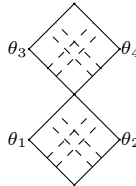

FIGURE 8.

- (2) (a) If the lattice as in Figure 8, then the first syzygy have diamond type generators such as  $(x_{\theta_3}x_{\theta_4} - x_{\theta_3 \vee \theta_4}x_{\theta_3 \wedge \theta_4})g_{(\theta_1, \theta_2)} - (x_{\theta_1}x_{\theta_2} - x_{\theta_1 \vee \theta_2}x_{\theta_1 \wedge \theta_2})g_{(\theta_3, \theta_4)}$  and it cannot be expressed by linear generators. Therefore, it belongs to  $\text{Syz}_1^2 R[\mathcal{L}]$  by Lemma 3.12. Hence it is non linear.

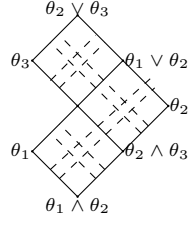

FIGURE 9.

- (b)  $\Rightarrow$ : If the lattice as in Figure 9, and since first syzygy is linear then there is a sublattice as in (see Lemma 3.11) and therefore  $ht(\theta_2 \wedge \theta_3) - ht(\theta_1 \wedge \theta_2) = 1$  or  $ht(\theta_2 \vee \theta_3) - ht(\theta_1 \vee \theta_2) = 1$ , where  $\theta_1, \theta_2, \theta_3 \in JM$ .  
 $\Leftarrow$ : Let the condition holds then all diamond type elements of the first syzygy can be expressed by other types. Hence the first syzygy is linear.

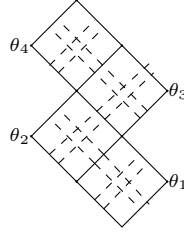

FIGURE 10.

- (3) If  $k(\mathcal{L}) \geq 3$  then we have a figure as in Figure 10, then the first syzygy element coming from the lower diamond and upper diamond cannot be expressed by other type of syzygies. Hence diamond type elements will occur. Thus for this case the first syzygy is not linear.  $\square$

#### 4. FIRST BETTI NUMBER FOR PLANAR DISTRIBUTIVE LATTICE

Let  $\mathcal{L}$  be a planar distributive lattice and  $JM$  be the set of all join-meet irreducible elements of  $\mathcal{L}$ . Let  $D_{(\theta_i, \theta_j)} = [\theta_i \wedge \theta_j, \theta_i \vee \theta_j]$ , the interval for  $\theta_i \approx \theta_j, \theta_i, \theta_j \in JM$ . One can write the lattice  $\mathcal{L}$  as a union of these intervals i.e. union of grid lattices. Let  $n(\theta_1, \theta_2)$  be the number of strip type generator in  $D_{(\theta_1, \theta_2)}$ . Then we have the following

**Lemma 4.1.** For  $\theta_1, \theta_2 \in JM$ ,

$$n(\theta_1, \theta_2) = S(ht(\theta_1) - ht(\theta_1 \wedge \theta_2), ht(\theta_2) - ht(\theta_1 \wedge \theta_2))$$

where  $S(.,.)$  is the number of strip type generator from the grid lattice.

*Proof.* Since the grid lattice formed by  $D_{(\theta_1, \theta_2)}$  is the lattice  $G(ht(\theta_1) - ht(\theta_1 \wedge \theta_2), ht(\theta_2) - ht(\theta_1 \wedge \theta_2))$ . Hence it follows.  $\square$

**Lemma 4.2.** For a planar distributive lattice  $\mathcal{L}$ , the number of strip type generators of first syzygy of  $R[\mathcal{L}]$ , we denote it by  $n_S(\mathcal{L})$  is the following

$$n_S(\mathcal{L}) = \sum_{\substack{\theta_i \approx \theta_j \\ \theta_i, \theta_j \in JM}} n(\theta_i, \theta_j) - \sum_{\theta_i, \theta_j, \theta_k} n(\theta_i \vee (\theta_j \wedge \theta_k), \theta_j).$$

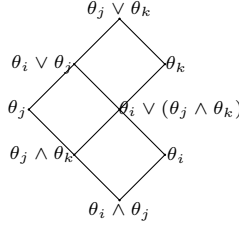

FIGURE 11.

*Proof.* From the Figure 11. it follows. □

Let  $m(\theta_1, \theta_2)$  be the number of  $L$ -type generator in  $D_{(\theta_1, \theta_2)}$ . Then we have the following

**Lemma 4.3.** For  $\theta_1, \theta_2 \in JM$ ,

$$m(\theta_1, \theta_2) = L(ht(\theta_1) - ht(\theta_1 \wedge \theta_2), ht(\theta_2) - ht(\theta_1 \wedge \theta_2)).$$

where  $L(.,.)$  denotes the number of  $L$ -shape generator from the grid lattice.

*Proof.* Since, the number of  $L$ -type generators in  $D_{(\theta_1, \theta_2)}$  is same as to find the number of  $L$ -type generators in grid lattice, then it follows. □

**Lemma 4.4.** For a planar distributive lattice  $\mathcal{L}$ , the number of  $L$ -type generator of  $R[\mathcal{L}]$ , we denote it by  $n_L(\mathcal{L})$  is the following

$$\begin{aligned} n_L(\mathcal{L}) &= \sum_{\substack{\theta_i \approx \theta_j \\ \theta_1, \theta_j \in JM}} m(\theta_i, \theta_j) - \sum L(r, s) \\ &+ \sum_{\theta_i, \theta_j, \theta_k} (ht(\theta_j \vee \theta_k) - ht(\theta_i \vee \theta_j))(ht(\theta_j \wedge \theta_k) - ht(\theta_i \wedge \theta_j)) \binom{r+1}{2} \binom{s+1}{2}. \end{aligned}$$

where  $r = ht(\theta_i \vee \theta_j) - ht(\theta_j)$ ,  $s = ht(\theta_j) - ht(\theta_j \wedge \theta_k)$ .

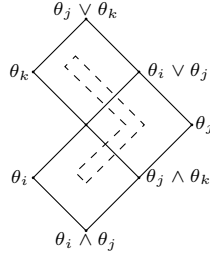

FIGURE 12.

*Proof.* The number of  $L$ -type for each  $D_{(\theta_i, \theta_j)}$  is  $m(\theta_i, \theta_j)$ . For each  $\theta_i, \theta_j, \theta_k$  there is double counting  $m(r, s)$  where  $r = ht(\theta_i \vee \theta_j) - ht(\theta_j)$ ,  $s = ht(\theta_j) - ht(\theta_j \wedge \theta_k)$ . Also for each  $\theta_i, \theta_j, \theta_k$  there is a  $L$ -type (see the dotted line in the the Figure 11) and the number is  $(ht(\theta_j \vee \theta_k) - ht(\theta_i \vee \theta_j))(ht(\theta_j \wedge \theta_k) - ht(\theta_i \wedge \theta_j)) \binom{r+1}{2} \binom{s+1}{2}$ . Since for  $(\theta_i, \theta_j), (\theta_j, \theta_k), (\theta_k, \theta_i)$  there is no  $L$ -type. Hence the lemma follows. □

Let  $B(\theta_i, \theta_j)$  be the number of box type in  $D_{(\theta_1, \theta_2)}$  then we have the following:

**Lemma 4.5.** For a planar distributive lattice  $\mathcal{L}$ , the number of box type generator of  $R[\mathcal{L}]$ ,  $n_B(\mathcal{L})$  is given by

$$n_B(\mathcal{L}) = \sum_{\substack{\theta_i \approx \theta_j \\ \theta_1, \theta_j \in JM}} B(\theta_i, \theta_j) - \sum_{\theta_i, \theta_j, \theta_k} B(\theta_i \vee (\theta_j \wedge \theta_k), \theta_j).$$

*Proof.* For each  $\theta_i, \theta_j$  the number of box types is  $B(\theta_i, \theta_j)$  and for each  $\theta_i, \theta_j, \theta_k$  there is double counting  $B(\theta_i \vee (\theta_j \wedge \theta_k), \theta_j)$  in numbers in their intersections. Hence the lemma follows.  $\square$

**Theorem 4.6.** *The first Betti number  $\beta_1(\mathcal{L})$  of  $R[\mathcal{L}]$  is*

$$\beta_1(\mathcal{L}) = n_S(\mathcal{L}) + n_L(\mathcal{L}) + n_B(\mathcal{L}) + n_D(\mathcal{L}).$$

*Proof.* It follows from the Lemmas 4.2, 4.4, 4.5 and Corollary 3.13.  $\square$

In the following example the results of this paper is demonstrated.

**Example 4.7.** *Let  $\mathcal{L}$  be a lattice as shown in the following Figure 13.*

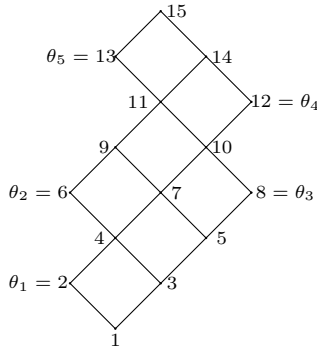

FIGURE 13.

Here the set of join-meet irreducible elements is  $JM = \{\theta_1, \theta_2, \theta_3, \theta_4, \theta_5\}$ . Since cardinality of  $k(\mathcal{L}) \geq 3$ , so the first syzygy of  $R[\mathcal{L}]$  is non linear follows from the Theorem 3.18. In  $\mathcal{L}$ , we can see that there is a sublattice isomorphic to the Figure 14.(a), so from this we get two strip type syzygies  $S_1 = -x_5g(2,3) + x_3g(2,5) - x_1g(4,5)$  and  $S_2 = x_7g(2,3) - x_4g(2,5) + x_2g(4,5)$ . Since there is a sublattice isomorphic to the Figure 14.(b), there is a L-type syzygy  $L = -x_{10}g(6,10) + x_5g(6,5) + x_{11}g(5,4) - x_3g(10,9)$ . Also, since in  $\mathcal{L}$ , there is a sublattice isomorphic to Figure 14.(c), one can get two box type syzygy  $B_1 = -x_8g(6,7) + x_7g(6,8) - x_9g(8,4) - x_3g(9,10)$  and  $B_2 = -x_7g(6,8) + x_6g(7,8) + x_{10}g(6,5) + x_3g(9,10)$ .

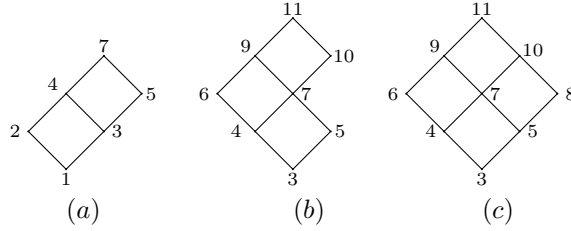

FIGURE 14.

By Definition 3.7, there is a diamond type coming from the two diamonds (2, 3) and (13, 14) and the two diamonds (2, 3) and (9, 10) are expressible by linear syzygies.

## 5. $\beta_1$ OF HIBI IDEALS WITH REGULARITY AT MOST 3

In the following, as an application of our results especially 4.6, we will give closed form formulae for the first Betti numbers of Hibi ideals with a given regularity  $r \leq 3$ . At this juncture let us recall the results from [7], in which the authors gave a complete characterization of the regularity of a distributive lattice  $\mathcal{L}$ , namely  $\text{reg}I(\mathcal{L}) = |P| - \text{rank}(P)$ , where  $P$  is the poset of nontrivial join-irreducible elements of  $\mathcal{L}$ . In the next subsection we will calculate the number of generators of strip, L and Box type syzygies for the “grid lattice”, which will be used repeatedly while applying Lemmas 4.2, 4.4, 4.5 and finally in form of the Theorem 4.6. We also use the Corollary 3.13 to calculate the number of linearly independent quadratic generators. Putting these together, we will give closed form formulae for all the planar lattices for regularity less than or equal to three.

**5.1. The first Betti number of Grid lattice. Strip type generators:** Let  $n_S(G(1, n))$  be the number of strip type generators in a grid lattice  $G(1, n)$ , we have

$$n_S(G(1, n)) = 2n_S(G(1, n-1)) - n_S(G(1, n-2)) + 2(n-1) = 2\binom{n+1}{3}.$$

Let  $n_S(G(m, n))$  be the number of strip type generators for the grid lattice  $G(m, n)$  we have,

$$\begin{aligned} n_S(G(m, n)) &= [m + (m-1) + \dots + 1]n_S(G(1, n)) + [n + (n-1) + \dots + 1]n_S(G(1, m)) \\ &= \binom{m+1}{2}n_S(G(1, n)) + \binom{n+1}{2}n_S(G(1, m)). \end{aligned}$$

**L-type generators:** Let  $n_L(G(2, n))$  be the number of L-type generators for grid lattice  $G(2, n)$  we have,

$$\begin{aligned} n_L(G(2, n)) &= 2 \sum_{i=1}^n (n+1-i)(i-1) \\ &= \frac{n(n^2-1)}{3}. \end{aligned}$$

Therefore, the L-type generators say  $n_L(G(m, n))$ , for grid lattice  $G(m, n)$  is,

$$\begin{aligned} n_L(G(m, n)) &= \sum_{i=0}^m (m+1-i)(i-1)n_L(G(2, n)) \\ &= \frac{m(m^2-1)}{6}n_L(G(2, n)) \\ &= \frac{n_L(G(2, m))n_L(G(2, n))}{2}. \end{aligned}$$

**Box type generators:** Since in a grid lattice clearly the number of box type generators is same as the number of L-type generators, hence, if  $n_B(G(m, n))$  is the number of box type generators of  $G(m, n)$  we have,

$$n_B(G(m, n)) = \frac{n_B(G(2, m))n_B(G(2, n))}{2}$$

Therefore,  $\beta_1$  of  $R[\mathcal{L}]$  for  $G(m, n)$  is

$$\beta_1(\mathcal{L}) = n_S(G(m, n)) + n_L(G(m, n)) + n_B(G(m, n)).$$

**5.2. The first Betti number of planar lattices of regularity 2.** In the following, lefthand side figure represent join irreducible poset and righthand side figure represent the corresponding lattice. Figure 15 and 16 are the regularity 2 lattices up to isomorphism.

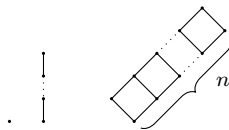

FIGURE 15.

Since here the lattice is  $G(1, n)$ , therefore, the first Betti number is same as the first Betti number of  $G(m, n)$ , for  $m = 1$ , (see 5.1). We can see that in this lattice it has no L-type, box type and diamond type. Hence all numbers are the following

$$\begin{aligned} n_S(\mathcal{L}) &= 2\binom{n+1}{3} \\ n_L(\mathcal{L}) &= 0 \\ n_B(\mathcal{L}) &= 0 \\ n_D(\mathcal{L}) &= 0 \end{aligned}$$

Therefore first Betti number  $\beta_1(\mathcal{L}) = 2\binom{n+1}{3}$ .

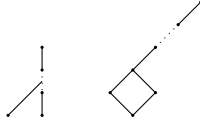

FIGURE 16.

Since here there is no strip,  $L$ , box and diamond types, therefore,  $n_S(\mathcal{L}) = n_L(\mathcal{L}) = n_B(\mathcal{L}) = n_D(\mathcal{L}) = 0$ . As a result  $\beta_1(\mathcal{L}) = 0$ .

**5.3. The first Betti number of planar lattices of regularity 3.** The following are the list of regularity 3 lattices up to isomorphic.

The figure 17 is  $G(2, n)$ , therefore  $\beta_1$  is same as  $\beta_1$  of  $G(m, n)$  for  $m = 2$  (see 5.1). Here we do not have any diamond types, therefore all the numbers are as below,

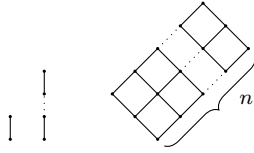

FIGURE 17.

$$n_S(\mathcal{L}) = n^2(n+1)$$

$$n_L(\mathcal{L}) = \frac{n(n^2-1)}{3}$$

$$n_B(\mathcal{L}) = \frac{n(n^2-1)}{3}$$

$$n_D(\mathcal{L}) = 0$$

$$\text{Therefore, } \beta_1(\mathcal{L}) = \frac{n(5n^2+3n-2)}{3}.$$

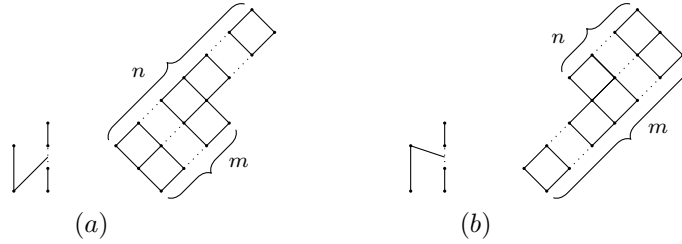

FIGURE 18.

The Figure 18 (a) (and by symmetry Figure 18, (b)) is a union of two grid lattices  $G(2, m)$  and  $G(1, n)$  with an “overlap” of  $G(1, m)$ . Therefore, by the Lemmas 4.2, 4.4, 4.5, the numbers are as below, note that there is no diamond types, and  $\beta_1$  is sum of these,

$$n_S(\mathcal{L}) = n_S(G(2, m)) + n_S(G(1, n)) - n_S(G(1, m))$$

$$n_L(\mathcal{L}) = \begin{cases} n_L(G(2, m)) + (n-m) \binom{m+1}{2} & m \geq 2 \\ n-1 & m = 1 \end{cases}$$

$$n_B(\mathcal{L}) = \begin{cases} \frac{m(m^2-1)}{3} & m \geq 2 \\ 0 & m = 1 \end{cases}$$

$$n_D(\mathcal{L}) = 0$$

In figure 19, it is clear that, the number of strip type generators is sum of the strip types in  $G(m, 1)$  and  $G(1, n)$  of the two “legs” of this figure.  $L$ -types are particular cases of (2) and (3). We can see that there is no box types. The diamond types are obtained by coupling any diamond from the upper

leg with these of the lower leg (avoiding the elbow) by virtue of 3.13. Consolidating all that, we have,

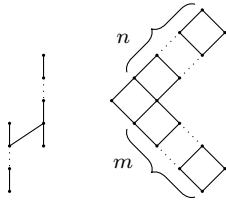

FIGURE 19.

$$\begin{aligned} n_S(\mathcal{L}) &= 2 \left[ \binom{m+2}{3} + \binom{n+2}{3} \right] \\ n_L(\mathcal{L}) &= mn \\ n_B(\mathcal{L}) &= 0 \\ n_D(\mathcal{L}) &= \begin{cases} \binom{m}{2} \binom{n}{2} & m, n \geq 2 \\ 0 & m = 1 \text{ or } n = 1 \end{cases} \end{aligned}$$

Therefore,  $\beta_1(\mathcal{L})$  is sum of above.

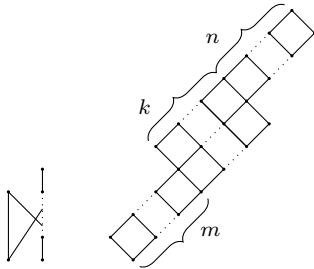

FIGURE 20.

In the figure 20, note that there are strip types coming from the two legs and the middle portion (a copy of  $G(2, k)$ ), as a result we use our lemma 4.2 to obtain the number of strip types. The number of box types are coming from the copy of  $G(2, k)$ , and the  $L$  types are computed using lemma 4.4. The diamond types can be obtained by coupling all the diamonds from the upper leg with that of lower leg but we have to remove the ones that are expressible as a result of the lemma 3.13.

$$\begin{aligned} n_S(\mathcal{L}) &= n_S(G(1, m+k)) + n_S(G(1, n+k)) + n_S(G(2, k)) - 2n_S(G(1, k)), \quad k \geq 0 \\ n_L(\mathcal{L}) &= \begin{cases} n_L(G(2, k)) + (n+m) \binom{k+1}{2} & k \geq 2 \\ mn & k = 1 \end{cases} \\ n_B(\mathcal{L}) &= \begin{cases} \frac{k(k^2-1)}{3} & k \geq 2 \\ 0 & k < 2 \end{cases} \\ n_D(\mathcal{L}) &= (D(m) + mk)(D(n) + nk) - D(k)mn, \text{ where } D(m) = \frac{m(m+1)}{2} \end{aligned}$$

Therefore,  $\beta_1(\mathcal{L})$  is sum of above numbers.

**Acknowledgement:** The authors would like to thank the referee for many helpful comments. The first author would like to thank BITS Pilani K.K. Birla Goa campus, Goa, India.

#### REFERENCES

- [1] A. Aramova, J. Herzog, and T. Hibi. Finite lattices and lexicographic gröbner bases. *European Journal of Combinatorics*, 21(4):431–439, 2000.
- [2] J. Brown and V. Lakshmibai. Singular loci of bruhat–hibi toric varieties. *Journal of Algebra*, 319(11):4759–4779, 2008.
- [3] J. Brown, V. Lakshmibai, et al. Singular loci of grassmann–hibi toric varieties. *The Michigan Mathematical Journal*, 59(2):243–267, 2010.
- [4] D. Eisenbud. *Commutative Algebra: with a view toward algebraic geometry*, volume 150. Springer Science & Business Media, 2013.
- [5] V. Ene. Syzygies of hibi rings. *Acta Mathematica Vietnamica*, 40(3):403–446, 2015.
- [6] V. Ene and T. Hibi. The join-meet ideal of a finite lattice. *Journal of Commutative Algebra*, 5(2):209–230, 2013.
- [7] V. Ene and S. J. Herzog; Saeedi Madani. A note on the regularity of hibi rings. *Manuscripta Math.*, 148(3-4):501–506, 2015.
- [8] N. Gonciulea and V. Lakshmibai. Singular loci of ladder determinantal varieties and schubert varieties. *Journal of algebra*, 229(2):463–497, 2000.
- [9] G. Grätzer. *Lattice theory: foundation*. Springer Science & Business Media, 2011.
- [10] J. Herzog and T. Hibi. Monomial ideals. In *Monomial Ideals*, pages 3–22. Springer, 2011.
- [11] T. Hibi et al. Distributive lattices, affine semigroup rings and algebras with straightening laws. In *Commutative algebra and combinatorics*, pages 93–109. Mathematical Society of Japan, 1987.
- [12] V. Lakshmibai and H. Mukherjee. Singular loci of hibi toric varieties. *Journal of Ramanujan Math Soc.*, 26:1–29, 2011.
- [13] H. Mukherjee. *Singularities of a certain class of toric varieties*. Northeastern University, 2008.
- [14] I. Peeva. *Graded syzygies*, volume 14. Springer Science & Business Media, 2010.

- [15] D. Rodica, V. Ene, and T. Hibi. On the regularity of join-meet ideals of modular lattices. *arxiv preprint arxiv:1806.05200*, 2018.
- [16] D. G. Wagner. Singularities of toric varieties associated with finite distributive lattices. *Journal of Algebraic Combinatorics*, 5(2):149–165, 1996.

INDIAN INSTITUTE OF SCIENCE EDUCATION AND RESEARCH KOLKATA, WEST BENGAL, INDIA

*Email address:* priya.math88@gmail.com

BITS PILANI K.K. BIRLA GOA CAMPUS, INDIA

*Email address:* himadrim@goa.bits-pilani.ac.in