

MODELING HOW WINDFARM GEOMETRY AFFECTS BIRD MORTALITY

ETHAN D. BOLKER, JEREMY J. HATCH, AND CATALIN ZARA

ABSTRACT. Birds flying across a region containing a windfarm risk death from turbine encounters. This paper describes a geometric model that helps estimate that risk and a spreadsheet that implements the model.

1. INTRODUCTION

After several years of controversy, Cape Wind will soon begin constructing a wind farm of 130 turbines, each about 100m in diameter, spread over about 65 km² (25 square miles) in Nantucket Sound off the coast of Massachusetts.

One component of the controversy is the potential for mortality of birds that pass through the wind farm. This paper and the software it describes is the result of a request from the biologist (Hatch) to the mathematicians (Bolker and Zara) for help with some of the underlying elementary geometry for modeling encounters with wind turbines during such crossings. Given turbine locations, flight direction, and the probability of a bird surviving a single passage through a turbine we calculate the expected number of turbine encounters for each bird and the probability of safe passage through the windfarm. To estimate absolute mortality numbers you must combine these per bird estimates with data about the number of birds exposed to the risk.

The most significant simplifying assumption is requiring a single input parameter for the survival probability for a single encounter. That number is hard to know. It depends on bird and turbine characteristics, on bird behavior (*e.g.* avoidance) and on flight and wind speed. Band [1] proposes a model that predicts the probability of surviving an encounter based on these inputs. Our model complements his: he pays careful attention to details at the level of the individual birds and turbines, but does not deal with the the arrangement of turbines in the farm.

Date: August 6, 2014.

Our model is particularly straightforward mathematically. For some questions all you need for good bounds or even exact answers (to the model) is a calculator and the number and size of turbines. For others an Excel spreadsheet (which we provide) does the job.

One important insight to draw from our geometric model is that birds passing through the wind farm turbine height, may encounter surprisingly few turbines and that this number is probably greatly reduced by avoidance. Chamberlain *et. al* [6] show that Band model predictions are much more sensitive to errors in estimating avoidance behavior than to equivalent errors in all other input parameters. Birds may act to avoid both whole turbines individual blades, so may lower both the average number of turbines encountered and the encounter mortality probability. Since we assume no active avoidance, our mortality estimates are likely to conservative – that is, too high.

Our model is generic – it accepts turbine coordinates as input. In this paper we apply it to a simple example that makes the geometry and mathematics clear. In Section 6 we report on several studies that use it in real situations.

2. THE BASIC MODEL

We assume that each bird follows a *path* T when it flies at a constant speed, height and heading (direction) across an area containing a wind farm. We want to compute the mortality probability $M(T)$ that the bird fails to survive its passage through the wind farm. To that end, let $E(T)$ be the number of turbines the bird encounters in its travel along T . Let p be the probability of safe passage through one turbine, and assume that surviving turbine encounters are independent events. Then the probability of surviving all the encounters is $p^{E(T)}$ so

$$M(T) = 1 - p^{E(T)}.$$

The price for this simple computation is the unrealistic assumptions we need to justify it. The first is our requirement that paths be straight lines. The second is our use of a single value p for the survival probability for any single encounter. In fact the value of p depends not only on the geometry of the encounter, thus on the size of the bird, on the speed at which it crosses through a revolving rotor, on the angle the flight path makes with the vertical plane of the turbine and the distance from the center of the turbine at which the encounter takes place, but also on the active avoidance behavior of the bird. So to use the model in any particular case you must decide on an appropriate average value for p or, to compute an upper bound on mortality, a minimum value.

You can then use the model to calculate the average values \bar{E} of $E(T)$ and \bar{M} of $M(T)$ over an appropriate set of paths $\{T\}$. Because finding and justifying a correct value for p is extremely difficult, our results are more reliable for \bar{E} than for \bar{M} .

Imagine a flock of birds crossing the wind farm on the way from some distant point to some distant point. Each flies along one path from the set $\{T\}$ of parallel paths on a particular compass bearing θ . We assume the paths cross a line segment perpendicular to the line of flight uniformly distributed along its length. We write $\bar{E} = \bar{E}(\theta)$ and $\bar{M} = \bar{M}(\theta)$ since both averages may depend on the angle θ .

We compute averages both over paths that actually cross the wind farm, and over paths that cross a small circle that contains the wind farm,¹ for heights uniformly distributed over a specified vertical range.

Two figures illustrate the geometry of the small wind farm we will use as an example. The top view (Figure 1) shows four turbines with blade length B meters. Turbine rotor planes can themselves rotate about a

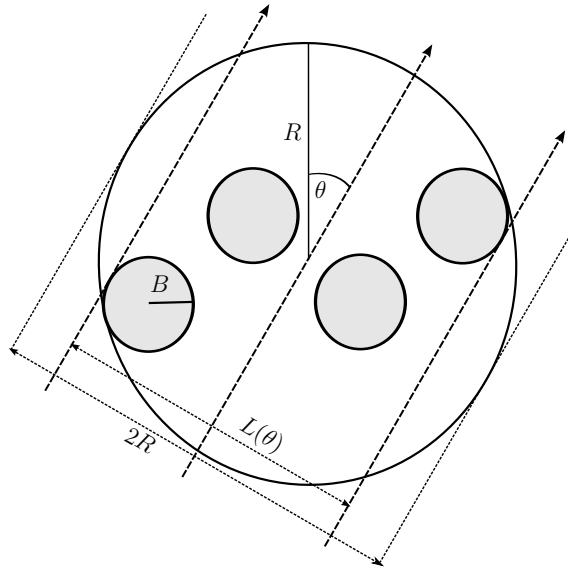

FIGURE 1. Top view.

vertical axis in order to present maximum area to the prevailing wind; the small circles in the figure represent the possible positions of the endpoints of the turbine rotors. This figure is not drawn to scale - in a real wind farm the distance between turbine centers would be on the

¹ The circle is the smallest one containing the windfarm centered at the average position of the turbines. It's not the smallest circle containing the windfarm, which might have a different center, but it is close to that circle.

order of 5 to 15 turbine diameters rather than the approximately 1.5 turbine diameters shown. The dashed lines indicate the direction of flight, labeled θ , measured in degrees East of North. The small circle containing the wind farm has radius R ; the actual diameter of the wind farm when birds fly on bearing θ is $L(\theta)$.

The side view (Figure 2) is what a bird would see looking ahead about to enter the wind farm, assuming for the moment that the flight is either upwind or downwind. Since the turbines rotate so that they always face the wind each one appears to the bird as a circle. White regions correspond to paths that miss all the turbines, light gray regions to paths that meet one and dark ones to paths that meet two.

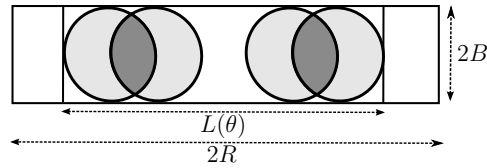

FIGURE 2. Side view.

Then the average number of turbines encountered is just

$$\bar{E}(\theta) = \frac{2 \times \text{dark area} + 1 \times \text{gray area}}{\text{total area}}$$

where the total area of the rectangle is either $2BL(\theta)$ or $4BR$ depending on the set of paths you are interested in.

The average mortality probability is

$$(1) \quad \bar{M}(\theta) = 1 - \frac{p^2 \times \text{dark area} + p \times \text{gray area} + \text{white area}}{\text{total area}}$$

It is clear that these areas and their generalizations for more than two encounters can all be computed exactly using elementary geometry and trigonometry. Our spreadsheet does that with an efficient algorithm that runs in time proportional to the number of turbines. That efficiency is possible because we assume p is independent of where a bird crosses a turbine. Chamberlain *et. al.* [5] discuss a similar model which requires numerical integration and the need to “adjust for overlapping rotors” in order to deal with a more complex determination of p .

3. COUNTING ENCOUNTERS, COMPUTING PROBABILITIES

In this section we present some mathematics that shows that you can compute $\bar{E}(\theta)$ and an upper bound for $\bar{M}(\theta)$ without needing even

the elementary geometry required to calculate the gray and dark areas in Figure 2. You don't need our spreadsheet: a calculator will do.

Imagine tacking targets (of any shape) to a dart board. Distribute them as you wish. You may (in fact should) let them overlap. Then suppose darts hit the dart board with a uniform distribution. Let \bar{E} be the average number of targets hit by a dart.

Theorem 1.

$$\bar{E} = \frac{\text{total area of targets}}{\text{area of dart board}}.$$

Proof. Write X for the dart board. For each target t let χ_t be the characteristic function of t . That is, $\chi_t(x) = 1$ if x is in t and 0 if it is not. A dart landing at x hits $\sum_t \chi_t(x)$ targets, so the average number of targets hit is

$$\begin{aligned} \bar{E} &= \frac{1}{\text{area of } X} \int_X \sum_t \chi_t(x) dx = \frac{1}{\text{area of } X} \sum_t \int_X \chi_t(x) dx \\ &= \frac{1}{\text{area of } X} \sum_t \text{area of } t = \frac{\text{total area of targets}}{\text{area of } X}. \end{aligned}$$

□

To model a wind farm, interpret paths as darts. We used the darts metaphor in the theorem in order to capture its true geometric generality. We find the theorem somehow simultaneously obvious and counterintuitive, and so think it useful and informative to provide this proof.²

Consider a wind farm with N turbines with blade length B . Recall that $L(\theta)$ is the “diameter” of the wind farm region perpendicular to bearing θ and R is the radius of the small circle containing the wind farm. Suppose bird flights are perpendicular to the rotor planes and uniformly distributed vertically between the top and bottom of the rotors.

Corollary 2. For flights that actually cross the wind farm on bearing θ

$$(2) \quad \bar{E}(\theta) = \frac{N\pi B^2}{2BL(\theta)} = \frac{N\pi B}{2L(\theta)}$$

independent of turbine placement. For flights that cross the small circle

$$(3) \quad \bar{E} = \bar{E}(\theta) = \frac{N\pi B^2}{(2B)(2R)} = \frac{N\pi B}{4R}$$

²You can also view this theorem as a corollary of the fact that the expected value of a sum of random variables is the sum of their expectations.

independent both of θ and of turbine placement.

Imagine an onshore windfarm: N turbines with centers D meters apart in a line along a ridge perpendicular to the prevailing wind. For flights with or against the wind, each bird meets no turbines, or just one. Since $2R \approx L(\theta) \approx ND$,

$$\bar{E}(\theta) = \frac{N\pi B}{2L(\theta)} \approx \frac{N\pi B}{2ND} = \frac{\pi}{2} \times \frac{B}{D}.$$

When B/D is on the order of $1/15$ to $1/7$ ([11]), \bar{E} is on the order of 0.1 to 0.2 . Between 10 and 20 percent of the birds encounter a turbine.

The average \bar{E} is likely to be less than one for offshore windfarms as well, even though turbines tend to be bunched and birds can meet more than one. To see why, imagine N turbines arranged on a square grid and roughly filling a circle. Then the radius R of the circle will be approximately $\sqrt{N/\pi}D$, where D is the distance between turbine centers along grid lines. Then Equation 3 implies

$$(4) \quad \bar{E} \approx \frac{N\pi B}{4\sqrt{N/\pi}D} = \frac{\pi^{3/2}\sqrt{N}}{4} \times \frac{B}{D}.$$

For $B/D = 1/10$, $\bar{E} < 1$ when $N < 52$. On average, a bird encounters less than one turbine. For $B/D = 1/20$, $\bar{E} < 1$ when $N < 207$. You can confirm that using the `Circle` worksheet in the spreadsheet. The Cape Wind installation will have 130 turbines in an area roughly a rectangle twice as wide as high, with $B/D \approx 1/16$. If they were packed in a circle Equation 4 would yield $\bar{E} \approx 0.85$. The spreadsheet calculations show $\bar{E} \approx 0.6$ for the actual positions of the turbines.

Unfortunately, \bar{M} is usually harder to come by. One case is easy.

Theorem 3. *When birds encounter at most one turbine on bearing θ*

$$(5) \quad \bar{M}(\theta) = (1 - p)\bar{E}(\theta).$$

Proof. The probability that a bird encounters a turbine is $\bar{E}(\theta)$. If it does, it dies with probability $(1 - p)$. \square

In general,

$$(6) \quad \bar{M} = 1 - \frac{1}{\text{area of } X} \int_X p^{\sum_t \chi_t(x)} dx.$$

Fortunately, there's an easy estimate for this integral that provides an upper bound for mortality probability and a straightforward algorithm for computing the integral exactly using simple geometry. We present the former here. The latter is in the appendix and implemented in the spreadsheet.

Theorem 4.

$$\bar{M} \leq 1 - p^{\bar{E}}.$$

Proof. Since the function $z \rightarrow p^z$ is convex, Jensen's inequality implies that the average value of $p^{\sum_t \chi_t(x)}$ is at least as large as $p^{\bar{E}}$. \square

There's a second estimate that's also useful because in practice, the survival probability p is quite close to 1.

Corollary 5. When $p \approx 1$,

$$\bar{M} \approx (1 - p)\bar{E}.$$

Proof. Let $q = 1 - p$. Then $q \approx 0$ and for any real number α

$$p^\alpha = (1 - q)^\alpha = 1 - \alpha q + \text{lower order terms} \approx 1 - \alpha q.$$

Setting $\alpha = \sum_t \chi_t(x)$ and integrating to compute the average value of the left hand side finishes the proof. \square

Theorem 3 says that this approximation is exact when birds encounter at most one turbine. The “lower order terms” we've ignored deal with multiple encounters. Figure 3 shows that it's a good estimate for Cape Wind – a real offshore windfarm – even with an unreasonably low survival probability of just 0.95. The (over)estimate smooths out the small variations in the computed mortality probabilities as a function of wind direction that are too precise to have any useful meaning.

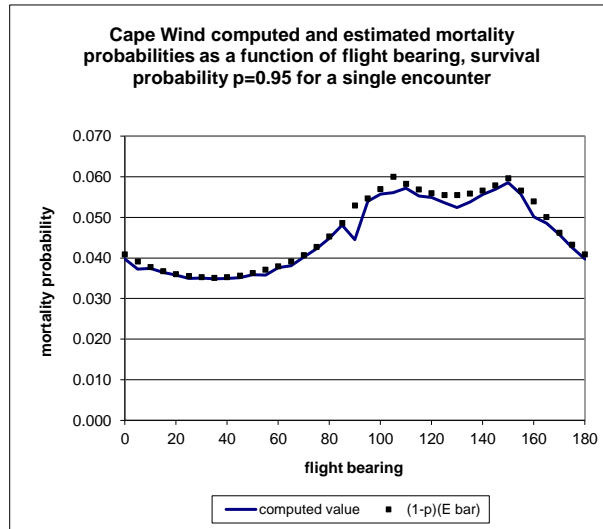

FIGURE 3. Estimated and computed mortality probabilities.

4. BELLS AND WHISTLES

We can make the model more useful by adding a few more geometric input parameters. First, you may specify a range of heights at which birds are known to fly. If, for example, they tend to cross the wind farm at an altitude between the center of the turbines and a blade length above that center then the side view is shown in Figure 4. The white, gray and dark areas are different but the computations for $\bar{E}(\theta)$ and $\bar{M}(\theta)$ are the same.

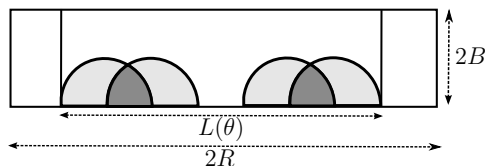

FIGURE 4. Side view when birds tend to fly above turbine centers.

A second feature allows you to evaluate the model when birds fly at an angle to the wind. In that case the birds see ellipses rather than circles. Their view is shown in Figure 5.

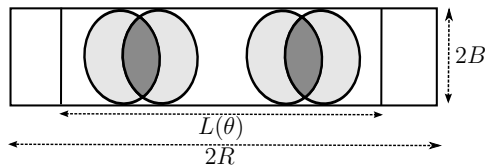

FIGURE 5. Side view when birds fly at an angle to the wind.

5. THE SPREADSHEET

You will find the spreadsheet implementing our model at <http://www.cs.umb.edu/~eb/windfarm/windfarm-v1-1.xlsm>. Here we describe spreadsheet input and output and remind the user yet again of some of our assumptions.

Input. Input goes in the yellow cells (with blue bold text) on the left in the **Main** worksheet. (Mouse over those cells to see documentation.) Figure 6 is a screen shot of that worksheet showing values for the small four turbine wind farm we've been using as an example.

- Locations of turbines. Specify these in a cartesian coordinate system with meters for units. We entered them in the worksheet

| | A | B | C | D | E | F | G | H | I | J | K | L | M |
|----|--|-------|---------------------|--------------|----------|---|---|---------------|--|------|------|------|---|
| 11 | Input | | | | | | | Output | Means for specified vertical range over wind directions, by flight direction | | | | |
| 12 | Input fields in bold blue can be edited | | | | | | | | | | | | |
| 13 | Mouse over fields to see documentation | | | | | | | | | | | | |
| 14 | | | | | | | | | | | | | |
| 15 | | | | | | | | | | | | | |
| 16 | Windfarm: | | FourTurbines | | | | | Overall mean: | | | | | |
| 17 | Rows | Start | | 9 | | | | 0 | 0.72 | 0.36 | 0.71 | 0.35 | |
| 18 | | End | | 12 | | | | 10 | 0.76 | 0.38 | 0.71 | 0.35 | |
| 19 | Xcolumn | | | 1 | A=1, etc | | | 20 | 0.82 | 0.39 | 0.71 | 0.34 | |
| 20 | | | | | | | | 30 | 0.91 | 0.41 | 0.71 | 0.32 | |
| 21 | Length of blade | | | 9 | m | | | 40 | 1.05 | 0.44 | 0.71 | 0.30 | |
| 22 | Probability of safe passage | | | 0.500 | | | | 50 | 1.28 | 0.49 | 0.71 | 0.27 | |
| 23 | | | | | | | | 60 | 1.35 | 0.55 | 0.71 | 0.29 | |
| 24 | Range of wind directions | | | | | | | 70 | 1.42 | 0.56 | 0.71 | 0.28 | |
| 25 | From | | | 999 | degrees | | | 80 | 1.52 | 0.58 | 0.71 | 0.27 | |
| 26 | To | | | 999 | degrees | | | 90 | 1.66 | 0.61 | 0.71 | 0.26 | |
| 27 | Wind angle step | | | 10 | degree | | | 100 | 1.28 | 0.54 | 0.71 | 0.30 | |
| 28 | | | | | | | | 110 | 1.06 | 0.48 | 0.71 | 0.32 | |
| 29 | Range of flight directions | | | | | | | 120 | 0.91 | 0.42 | 0.71 | 0.32 | |
| 30 | From | | | 0 | degrees | | | 130 | 0.82 | 0.36 | 0.71 | 0.31 | |
| 31 | To | | | 180 | degrees | | | 140 | 0.76 | 0.35 | 0.71 | 0.32 | |
| 32 | Flight angle step | | | 10 | degree | | | 150 | 0.73 | 0.35 | 0.71 | 0.34 | |
| 33 | | | | | | | | 160 | 0.71 | 0.35 | 0.71 | 0.35 | |
| 34 | | | | | | | | 170 | 0.71 | 0.35 | 0.71 | 0.35 | |
| 35 | Height of turbine center | | | 30 | m | | | 180 | 0.72 | 0.36 | 0.71 | 0.35 | |
| 36 | Range of heights at which birds fly: | | | | | | | | | | | | |
| 37 | From | | | 21 | m | | | | | | | | |
| 38 | To | | | 39 | m | | | | | | | | |

FIGURE 6. Spreadsheet for four turbine model.

named `FourTurbines` starting at cell `A9` and told the model that in cells `D16:D19`.

To model your wind farm you may need to convert locations to a cartesian coordinate system. The `CapeWind` worksheet shows those calculations for the Cape Wind farm.

Figure 7 shows the locations of the four turbines in our example. The input coordinates from the `FourTurbines` worksheet are on the right, the chart Excel drew in in the `Graphs` worksheet is on the left.

- Turbine blade length B , in meters – in cell `D9`. That’s 9m in this example.
- The probability p that a bird encountering a turbine survives the encounter. We’ve entered 0.5 in cell `D10`. That number is much too large for a real windfarm. We use it here because it’s easy to compute with so we will be able to check the output of the spreadsheet by hand.
- The height of the rotor centers, in meters – in cell `D35`. We use 30m in our example.
- The upper and lower limits for the altitudes at which birds fly. Setting these to `-bladlength` and `bladlength` respectively leads to the side view in Figure 4; we use $30 - 9 = 21$ and $30 + 9 = 39$ meters. Setting both to 0 means that all birds fly at exactly the height of the centers of the turbines.

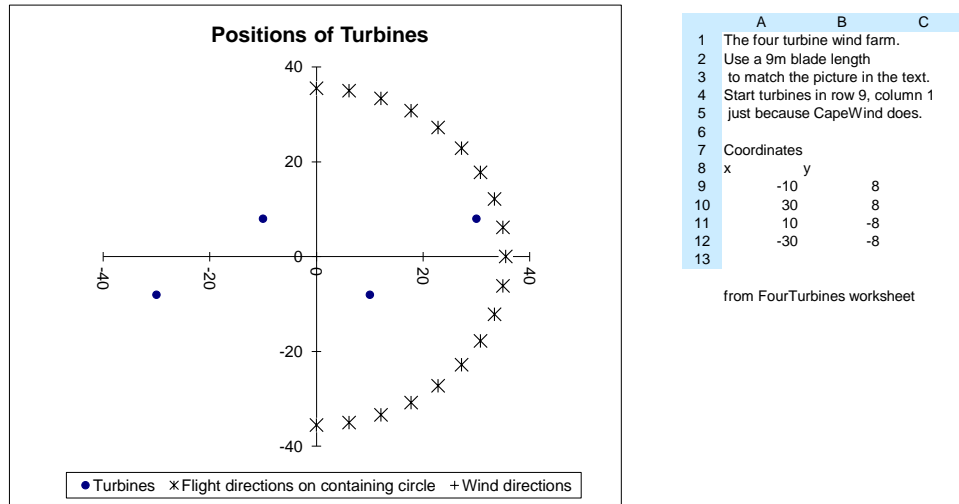

FIGURE 7. Four turbine model coordinates.

- The compass bearings θ (in degrees east of north) for flight paths you are interested in: minimum and maximum values and increment. In the example we've entered 0, 180 and 10 in cells D30:D32.
- (Optional) The compass bearings ω (in degrees east of north) for headings (directions) of the prevailing wind you are interested in: minimum and maximum values and increment in cells D25:D27. Entering 999 as we have tells Excel to skip this computation and assume that for the flight directions specified paths are perpendicular to the plane in which the turbines rotate.

Output.

- The radius of the smallest circle centered at $(0,0)$ surrounding the wind farm, in cell D41. For the **FourTurbines** example that's 41m.
- For each flight heading θ (wind direction ω)
 - the expected number $\bar{E}(\theta)$ of turbines encountered, and the average over θ (ω).
 - the expected probability $\bar{M}(\theta)$ ($\bar{M}(\omega)$) of bird mortality and the average over θ (ω).
 - the maximum number of encounters $E(T)$ for these paths and the corresponding maximum mortality probability.
- Excel charts displaying this information.

Figure 8 shows the results for flight directions in our example. You can see how they reflect windfarm geometry: the peaks for the actual region near 90 degrees correspond to the fact that the four turbine centers are approximately lined up West to East. The mortality values are large because the probability of death for each encounter is an unreasonable large 0.5. The number of encounters for the circular region is constant (as predicted by Corollary 3). The mortality chart dips near 90 degrees because most birds on that bearing crossing the circle meet no turbines. Those few near the x -axis meet four; they survive with probability $(1/2)^4 = 1/16$.

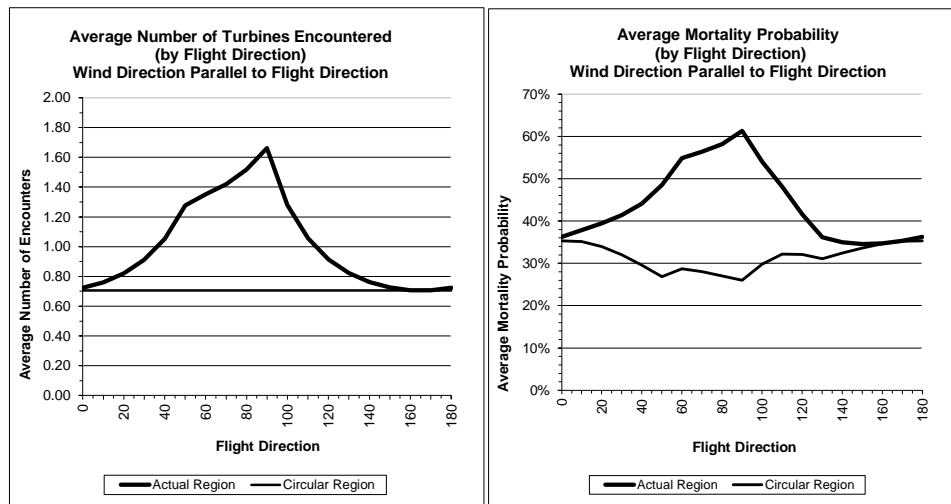

FIGURE 8. Four turbine model output charts.

Tips and workarounds.

- Before evaluating the model for your wind farm we suggest you familiarize yourself with the way the model works by playing with the four turbine example in the text and by building your own small models in the `test` worksheet in the spreadsheet. Experiment with two or three turbines, and with survival probabilities like 0, 0.5 and 1 for which you will be able to see that the answers are what you expect.
- The assumption that p is constant and known in fact unreasonable. The model assumes that a correct average value has been computed for input, leaving to others the argument about how to compute that average. Evaluate your model several times

using different estimates for p to see how sensitive your results are to its value.

- When using the spreadsheet you should specify either a range of flight headings and a single wind heading, or a single flight heading and a range of wind headings. The spreadsheet will allow you to use two ranges, but the results may be difficult to interpret.
- To model a nonuniform distribution of flight paths over heights, perhaps with different mortality probabilities for each, you can evaluate the model multiple times, once for each subrange over which the height distribution is reasonably uniform, and combine the results using Excel functions.
- To model mortality probabilities that depend on the angle between the prevailing wind and the flight path you can evaluate the model multiple times for restricted ranges of angles, varying the probability as appropriate for each evaluation.
- To model mortality due to collisions with turbine supports, set the blade length to the radius of the support, the height range from 0 to 0 meters below and above the turbine center and the wind bearing range from 999 to 999. The spreadsheet will then compute values for \bar{E} and \bar{M} for paths at any height that might encounter the turbine supports. The expected number \bar{E} of encounters is likely to be small. The value of \bar{M} depends on the probability p of surviving an encounter, which may not be small.

6. DRAWING BIOLOGICAL CONCLUSIONS

Since we posted the first complete draft of this manuscript and software in 2006 several papers have used it or referred to it. Here we summarize some of that literature.

The results suggest (as we expected) that our model can be used to provide a robust starting point for handling the geometry of the wind farm but that most of the work required to estimate bird mortality is in the biology - how many birds are there, where do they fly, and how do they behave?

The Nantucket Sound wind farm. Jeremy Hatch and Solange Brault used our model in their analysis [10] of bird mortality for the proposed wind farm on Nantucket Sound.

As we stressed in the introduction, modeling the probability of safe passage through a wind farm requires two steps: estimating the number E of turbines encountered, and the probability p of surviving one

encounter. To estimate bird mortality in absolute terms requires a further estimate of numbers of each bird-group of interest at risk: those flying through the wind farm at turbine-height. Each component of these estimates has large uncertainty and is likely to show great variation, much of which is specific to the particular location and to the bird-group examined.

Hatch and Brault combine measured bird activity with robust estimation methods for the difficult survival parameter p . They use Monte Carlo methods to turn the single mortality probability estimates from our model into mortality probability distributions, and run sensitivity analyses to assess the importance of the estimates of each parameter.

Gordon *et al* [9] use the Cape Wind configuration and measured mortality from a nearby turbine at the Massachusetts Maritime Academy to develop a more robust methodology for risk assessment:

The Cape Wind modeling approach provides a foundation for exploring the use of models in offshore conditions where high uncertainty exists. The model developed by Bolker *et al.* (2006) is an example of a model requiring minimal inputs, employing simple geometry and basic probability theory to estimate avian mortality. This paper expands upon the original work of Bolker by directly incorporating observations of turbine avoidance behavior by terns into the published mathematical framework. In addition, we modify the Bolker framework by formally incorporating a risk based approach to decision making based on the model outputs, including the use of a formal uncertainty analysis.

The Belgian Part of the North Sea. Nicolas Vanermen and Eric W.M. Stienen [14] studied bird mortality for a proposed wind farm in the Belgian Part of the North Sea. They used our model to find a worst case estimate of the number of turbines encountered.

APPENDIX A. ALGORITHMS

Here we provide an algorithm to evaluate the integral in Equation 6, which is the formal statement of the numerator in Equation 1. It's an analogue of Theorem 1, true for some arrangements of targets on a dart board – fortunately, the ones we are interested in.

Let D_1, D_2, \dots, D_N be a sequence of disks in the plane with the same radius and collinear centers, arranged in numerical order along the line

of centers. Then for each i ,

$$(7) \quad D_i \supseteq D_i \cap D_{i+1} \supseteq D_i \cap D_{i+2} \dots$$

This is just what you can see in Figure 2. It's also true for the shaded regions in Figure 4. It's exactly what we need for the next theorem.

Theorem 6. *Let D_1, D_2, \dots, D_N be a sequence of plane regions for which Equation 7 is true. Let χ_i be the characteristic function of D_i , $X_i = D_i \cup D_{i+1} \cup \dots \cup D_N$ and $X = X_1$. Then*

$$(8) \quad \int_X p^{\sum_{i=1}^N \chi_i(x)} dx = \sum_{i=1}^N \sum_{j=i}^N \lambda_{j-i}(p) A_{ij},$$

where $A_{ij} = \text{Area}(D_i \cap D_j)$ and

$$(9) \quad \lambda_r = \lambda_r(p) = \begin{cases} p, & \text{if } r = 0, \\ p^2 - 2p, & \text{if } r = 1, \\ p^{r-1}(p-1)^2, & \text{if } r \geq 2. \end{cases}$$

Proof.

$$\begin{aligned} \int_X p^{\sum_{i=1}^N \chi_i(x)} dx - \int_{X_2} p^{\sum_{i=2}^N \chi_i(x)} dx &= p(A_{11} - A_{12}) \\ &+ (p^2 - p)(A_{12} - A_{13}) + (p^3 - p^2)(A_{13} - A_{14}) \\ &+ \dots + (p^{k-1} - p^{k-2})(A_{1,k-1} - A_{1,k}) + (p^N - p^{N-1})A_{1,N} \\ &= pA_{11} + (p^2 - 2p)A_{12} + (p^3 - 2p^2 + p)A_{13} + \dots \\ &= \lambda_0 A_{11} + \lambda_1 A_{12} + \lambda_2 A_{13} + \dots + \lambda_{k-1} A_{1N} = \sum_{j=1}^N \lambda_{j-1} A_{1j}. \end{aligned}$$

Similarly

$$\begin{aligned} \int_{X_2} p^{\sum_{i=2}^N \chi_i(x)} dx - \int_{X_3} p^{\sum_{i=3}^N \chi_i(x)} dx &= \sum_{j=2}^N \lambda_{j-2} A_{2j} \\ \int_{X_3} p^{\sum_{i=3}^N \chi_i(x)} dx - \int_{X_4} p^{\sum_{i=4}^N \chi_i(x)} dx &= \sum_{j=3}^N \lambda_{j-3} A_{3j} \\ &\vdots \\ \int_{X_N} p^{\sum_{i=N}^N \chi_i(x)} dx &= \sum_{j=N}^N \lambda_{j-N} A_{Nj} \end{aligned}$$

Adding these telescoping equations leads to (8). \square

The last piece is the computation of the area of the intersections of the regions $D_i \cap D_j$. The D_i are circles when the flight direction is up or downwind. When the flight is at an angle to the wind, the D_i are ellipses obtained by compressing circles along a diameter, with the same compression factor for each. Then we can find the areas of the intersections by decompressing to circles, finding those areas and then compressing the results.

Suppose C_1 and C_2 are circles of radius R , with centers O_1 and O_2 situated at a distance $O_1O_2 = 2d \leq 2R$. Let D_1 and D_2 be the segments of the disks bounded by lines parallel to the line of the centers, at distance a and b from the line of centers; these distances are positive if the line is above the line of centers and negative otherwise. The area of the intersection $D_1 \cap D_2$ can be computed as follows using the elementary geometry illustrated in Figure 9.

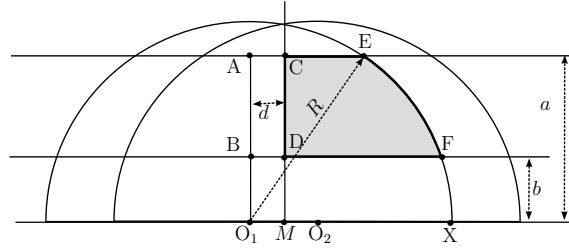

FIGURE 9. Computing area between flight altitudes

$$\text{Area}(D_1 \cap D_2) = 2\text{Area}(CDFE) = 2(\text{Area}(CMXE) - \text{Area}(DMXF))$$

and

$$\text{Area}(CMXE) = \text{Area}(EO_1X) + \text{Area}(AO_1E) - \text{Area}(AO_1MC)$$

$$= \frac{1}{2}R^2 \arcsin\left(\frac{a}{R}\right) + \frac{1}{2}a\sqrt{R^2 - a^2} - ad$$

$$\text{Area}(DMXF) = \frac{1}{2}R^2 \arcsin\left(\frac{b}{R}\right) + \frac{1}{2}b\sqrt{R^2 - b^2} - bd.$$

Therefore

$$\begin{aligned} \text{Area}(D_1 \cap D_2) &= R^2 (\arcsin(a/R) - \arcsin(b/R)) \\ &\quad + a\sqrt{R^2 - a^2} - b\sqrt{R^2 - b^2} - 2d(a - b). \end{aligned}$$

The formula is valid when

$$-\sqrt{R^2 - d^2} \leq b \leq a \leq \sqrt{R^2 - d^2};$$

if a or b lies outside that interval, replace it by the nearest endpoint of the interval.

Here is the pseudocode for the Excel macro implementing that algorithm in the spreadsheet. **Area** computes the area of each intersection of elliptic sections. The inner loop terminates prematurely as soon as the intersection is empty.

```

/* Read input parameters */
    • Location of turbines
    • Geometry of turbines (rotor height, blade length)
    • Range of flight directions (start, end, step)
    • Range of wind directions (start, end, step)
    • Probability of safe passage through one turbine

/* Normalize coordinates of turbines*/
Compute centroid of wind turbines
Compute radius of enclosing region
for each flight direction do
    Project turbines along the flight direction
    Sort coordinates of projections
    for each wind direction do
        ProbAccum  $\leftarrow$  0
        AreaAccum  $\leftarrow$  0
        for  $i \leftarrow 1$  to NumTurb do
            AreaAccum  $\leftarrow$  AreaAccum + Area( $D_i$ )
             $j \leftarrow i$ 
            repeat
                WedgeArea  $\leftarrow$  Area( $D_i \cap D_j$ )
                Weight  $\leftarrow$  lambda( $j - i, ProbSafe$ )
                ProbAccum  $\leftarrow$  ProbAccum + Weight * WedgeArea
                 $j \leftarrow j + 1$ 
            if  $j=i+1$  then
                AreaAccum  $\leftarrow$  AreaAccum - Area( $D_i \cap D_j$ )
            end
            until WedgeArea = 0 or  $j = NumTurb + 1$ 
        end
        Record ProbAccum
        Record AreaAccum
    end
end

```

REFERENCES

- [1] W. Band. Using a collision risk model to assess bird collision risks for offshore windfarms. Technical report, Strategic Ornithological Support Services, 2012.
- [2] W. Band, M. Madders, and D. P. Whitfield. Developing field and analytical methods to assess avian collision risk at wind farms. In M. de Lucas, G. Janss, and M. Ferrer, editors, *Birds and Wind Farms: Risk Assessment and Mitigation*, pages 259–275. Quercus, Madrid, Spain, 2007.
- [3] R. Brabant, L. Vigin, E. Stienen, N. Vanermen, S. Degraer, et al. Radar research on the impact of offshore wind farms on birds: Preparing to go offshore. In S. Degraer et al., editors, *Offshore wind farms in the Belgian part of the North Sea: Heading for an understanding of environmental impacts*, pages 110–126. Royal Belgian Institute of Natural Sciences, Management Unit of the North Sea Mathematical Models, Marine Ecosystem Management Unit, 2012.
- [4] S. Brault. Population Viability Analysis for the New England population of the Piping Plover (*charadrius melodus*). Technical report, Cape Wind Associates, 2007.
- [5] D. Chamberlain, S. Freeman, M. Rehfish, T. Fox, and M. Desholm. Appraisal of Scottish Natural Heritage’s wind farm collision risk model and its application. *BTO research report*, 401, 2005.
- [6] D. E. Chamberlain, M. R. Rehfish, A. D. Fox, M. Desholm, and S. J. Anthony. The effect of avoidance rates on bird mortality predictions made by wind turbine collision risk models. *Ibis*, 148(s1):198–202, 2006.
- [7] J. Everaert and E. W. Stienen. Impact of wind turbines on birds in Zeebrugge (Belgium). *Biodiversity and Conservation*, 16(12):3345–3359, 2007.
- [8] G. Forcey et al. A habitat-based wind-wildlife collision model with application to the Upper Great Plains Region. Technical report, Normandeau Associates, Inc, 2012.
- [9] C. Gordon, W. J. Warren-Hicks, and L. S. Vlietstra. New insights and new tools regarding risk to Roseate Terns, Piping Plovers, and Red Knots from wind facility operations on the Atlantic Outer Continental Shelf. Technical report, U.S. Department of the Interior Bureau of Ocean Energy Management, Regulation and Enforcement, 2011.
- [10] J. Hatch and S. Brault. Collision mortalities at Horseshoe Shoal of Bird Species of special concern. Technical report, Cape Wind Associates, 2007.
- [11] J. Meyers and C. Meneveau. Optimal turbine spacing in fully developed wind farm boundary layers. *Wind Energy*, 15(2):305–317, 2012.
- [12] I. Smales, S. Muir, C. Meredith, and R. Baird. A description of the biosis model to assess risk of bird collisions with wind turbines. *Wildlife Society Bulletin*, 37(1):59–65, 2013.
- [13] T. Troost. Estimating the frequency of bird collisions with wind turbines at sea. *Guidelines for using the spreadsheet Bird collisions Deltares v1-0. xlsBird collisions Deltares v1-0. xls. Appendix to report Z*, 4513, 2008.
- [14] N. Vanermen and E. W. Stienen. Seabirds and offshore wind farms: Monitoring results 2008. In S. Degraer and R. Brabant, editors, *Offshore wind farms in the Belgian part of the North Sea: State of the art after two years of environmental monitoring*. Royal Belgian Institute for Natural Sciences, Management Unit of the North Sea Mathematical Models. Marine ecosystem management unit, 2009.

DEPARTMENTS OF MATHEMATICS AND COMPUTER SCIENCE, UNIVERSITY OF MASSACHUSETTS BOSTON, MA 02125

E-mail address: `eb@cs.umb.edu`

DEPARTMENT OF BIOLOGY, UNIVERSITY OF MASSACHUSETTS BOSTON, MA 02125

E-mail address: `jeremy.hatch@umb.edu`

DEPARTMENT OF MATHEMATICS, UNIVERSITY OF MASSACHUSETTS BOSTON, MA 02125

E-mail address: `catalin.zara@umb.edu`