

Harmonic numbers, Catalan's triangle and mesh patterns

Sergey Kitaev

Department of Computer and Information Sciences
University of Strathclyde
Glasgow G1 1XH, United Kingdom
sergey.kitaev@cis.strath.ac.uk

Jeffrey Liese

Department of Mathematics
Cal Poly
San Luis Obispo, CA 93407, USA
jliese@calpoly.edu

Submitted: Date 1; Accepted: Date 2; Published: Date 3.
MR Subject Classifications: 05A15

Abstract

The notion of a mesh pattern was introduced recently, but it has already proved to be a useful tool for description purposes related to sets of permutations. In this paper we study eight mesh patterns of small lengths. In particular, we link avoidance of one of the patterns to the harmonic numbers, while for three other patterns we show their distributions on 132-avoiding permutations are given by the Catalan triangle. Also, we show that two specific mesh patterns are Wilf-equivalent. As a byproduct of our studies, we define a new set of sequences counted by the Catalan numbers and provide a relation on the Catalan triangle that seems to be new.

Keywords: mesh patterns, distribution, harmonic numbers, Catalan's triangle, bijection

1 Introduction

The notion of mesh patterns in permutations was introduced by Brändén and Claesson [2] to provide explicit expansions for certain permutation statistics as possibly infinite linear combinations of (classical) permutation patterns (see [4] for a comprehensive introduction to the theory of permutation patterns). There is a line of papers [1, 3, 5, 6, 7, 8, 9, 11, 12] related to studying various mesh patterns in sets of permutations or sometimes in restricted sets of permutations, and this paper is a contribution to the study. In particular, we provide links to the harmonic numbers and the Catalan triangle. Besides being interesting in their own right, there are other motivations to analyze mesh patterns. For example, a certain generalization of the notion of mesh patterns was used in [11] by Úlfarsson to simplify

a description of Gorenstein Schubert varieties and to give a new description of Schubert varieties that are defined by inclusions.

We will now provide some definitions that will be used throughout the paper. We define an n -*permutation* to be a word without repeated elements over the set $\{1, 2, \dots, n\}$. An element π_i of a permutation $\pi_1\pi_2\cdots\pi_n$ is a *right-to-left maximum* if $\pi_i > \pi_j$ for $j \in \{i+1, i+2, \dots, n\}$. For example, the set of right-to-left maxima of the permutation 264513 is $\{3, 5, 6\}$.

A mesh pattern is a generalization of several classes of patterns studied intensively in the literature during the last decade (see [4]). However for this paper we do not need the full definition of classical pattern avoidance. In fact, apart from the notion of a mesh pattern, we only need the notion of a permutations *avoiding the (classical) pattern 132*, or a *132-avoiding permutation*. A permutation $\pi = \pi_1\pi_2\cdots\pi_n$ *avoids* the pattern 132, if there are no numbers $1 \leq i < j < k \leq n$ such that $\pi_i < \pi_k < \pi_j$. For example, the permutation 43512 avoids the pattern 132 while 24531 contains two occurrences of this pattern, namely the subsequences 243 and 253. For two patterns (of any type) p and q we say that p and q are *Wilf-equivalent* if for all $n \geq 0$, the number of n -permutations avoiding p is equal to that avoiding q .

The notion of a mesh pattern can be best described using permutation diagrams, which are similar to permutation matrices (for a more detailed description, we refer to [2, 11]). For example, the diagrams in Figure 1, after ignoring the shaded areas and paying attention to the height of the dots (points) while going through them from left to right, each correspond to the permutation 213, while the diagram on the left in Figure 2 corresponds to the permutation 82536174. A mesh pattern consists of the diagram corresponding to a permutation where some subset of the squares determined by the grid are shaded. In fact, three mesh patterns are depicted in Figure 1 and eight mesh patterns in Figure 3.

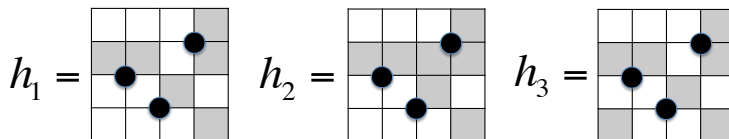

Figure 1: Three mesh patterns.

We say that a mesh pattern p of length k occurs in a permutation π if the permutation diagram of π contains k dots whose order is the same as that of the permutation diagram of p , i.e. π contains a subsequence that is order-isomorphic to p , and additionally, no element of π can be present in a shaded area determined by p and the corresponding elements of π in this subsequence. For example, the three circled elements in the permutation 82536174 in Figure 2 are an occurrence of the mesh pattern h_1 defined in Figure 1, as demonstrated by the diagram on the right in Figure 2 (note that none of the permutation elements fall into the shaded area determined by the mesh pattern). However, these circled elements are not an occurrence of the pattern h_2 in Figure 1 because of the element 6 in the permutation; they also are not an occurrence of the pattern h_3 in Figure 1 because of the element 2 in

the permutation. One can verify using the diagram in Figure 1 that the subsequence 536 in the permutation 82536174 is an occurrence of the mesh patterns h_1 and h_2 , but not h_3 .

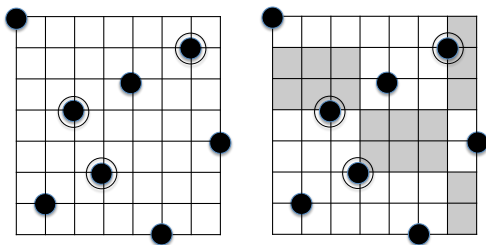

Figure 2: An example of an occurrence of a mesh pattern.

The definitions of all mesh patterns of interest in this paper are given in Figure 3. In particular, p is an instance of what we call *border mesh patterns*, which are defined by shading all non-interior squares.

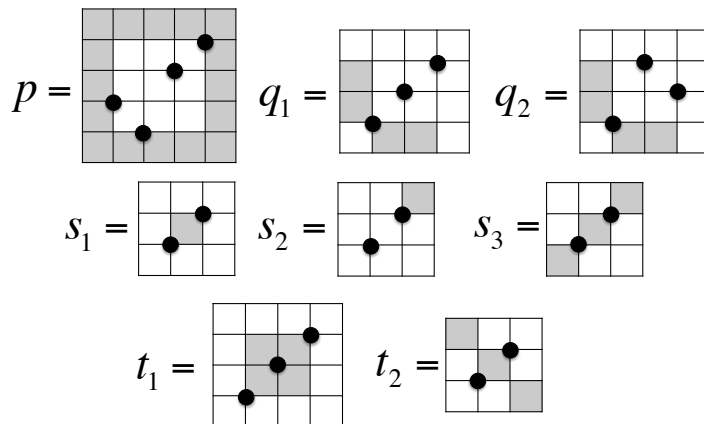

Figure 3: Definitions for all patterns of interest in this paper.

We also need to define a Catalan number and the Catalan triangle. The n -th Catalan number C_n is defined by the recursion $C_{n+1} = \sum_{i=0}^n C_i C_{n-i}$ with $C_0 = 1$. Catalan's triangle is defined by $C(0, 0) = 1$, $C(0, k) = 0$ for $k > 0$ and $C(n, k) = C(n-1, k) + C(n, k-1)$. An alternative recursion for the Catalan triangle, namely $C(n, k) = \sum_{j=0}^k C(n-1, j)$, will also be useful. The beginning of Catalan's triangle is shown below.

			1		
			1	1	
		1	2	2	
	1	3	5	5	
	1	4	9	14	14
1	5	14	28	42	42

The Catalan numbers can always be read from Catalan's triangle by looking at the right-most number in each row. The following two formulas for the Catalan numbers and the entries in Catalan's triangle are both well-known:

$$C_n = \frac{1}{n+1} \binom{2n}{n} \quad C(n, k) = \frac{(n+k)!(n-k+1)}{k!(n+1)!}.$$

If the number of n -permutations with k occurrences of a pattern τ is given by $C(n, k)$ or a shift of indices of this number, e.g. $C(n-1, k)$, we say that τ has *Catalan's distribution*.

The paper is organized as follows. In Section 2 we not only link the distribution of the pattern p to the harmonic numbers (see Theorems 2 and 3), but also study an exponential generating function for this distribution (see Theorem 4). In Section 3 we show Wilf-equivalence of the patterns q_1 and q_2 . Section 4 is devoted to study of the patterns s_1 , s_2 , s_3 , t_1 and t_2 on 132-avoiding permutations. More specifically, Subsections 4.1 and 4.2 show that both s_1 and s_2 have Catalan's distribution on 132-avoiding permutations (see Theorems 7 and 9), while Subsection 4.3 shows that s_3 has the reverse Catalan distribution on this class of permutations (see Theorem 13). We prove Theorem 13 combinatorially by introducing an involution on the set of 132-avoiding permutations and using Theorem 7. This involution allows us to establish a joint equidistribution fact for four statistics on 132-avoiding permutations. We also provide an extra proof of Theorem 7 to establish a bijective proof of the fact that s_1 and s_2 are equidistributed. As a byproduct to our research, we define a new set of sequences counted by the Catalan numbers (see Proposition 8). Additionally, we discover a relation for Catalan's triangle that involves the Catalan numbers which seems to be new (see Theorem 10). This relation led us to a combinatorial proof of a binomial identity stated in Corollary 11. In Subsection 4.4 we discuss the minimum and maximum number of occurrences of the pattern t_1 on 132-avoiding permutations (see beginning of the subsection and Theorem 18), while in Subsection 4.5 we find the number of 132-avoiding permutations with exactly zero, one, two or three occurrences of the pattern t_2 (see Theorems 21, 22, 24, 25); essentially all our results here are given in terms of the Catalan numbers. Finally, in Section 5 we provide some concluding remarks.

2 The pattern p and the harmonic numbers

We let $H_n = \sum_{k=1}^n \frac{1}{k}$ denote the n -th harmonic number. In this section, we will express the distribution of the border mesh pattern p in terms of H_n .

Proposition 1. *For $n \geq 4$ and $k \geq 1$, we have that*

$$p_{n,k} := (n-2)! \sum_{i=k+1}^{n-2} \frac{1}{i} = (n-2)!(H_{n-2} - H_k) \quad (1)$$

satisfies the recursion

$$p_{n,k} = (n-2)p_{n-1,k} + (n-3)!. \quad (2)$$

Proof. Plugging in the formula into the RHS of (2) we obtain,

$$\begin{aligned}
(n-2)p_{n-1,k} + (n-3)! &= (n-2) \left((n-3)! \sum_{i=k+1}^{n-3} \frac{1}{i} \right) + (n-3)! \\
&= (n-2)! \sum_{i=k+1}^{n-3} \frac{1}{i} + (n-3)! \\
&= (n-2)! \sum_{i=k+1}^{n-2} \frac{1}{i} \\
&= p_{n,k}.
\end{aligned}$$

We are done. □

Theorem 2. *The number of n -permutations with k occurrences of the border mesh pattern p for $k \geq 1$ is given by $p_{n,k}$.*

Proof. We prove this theorem by showing that the number of n -permutations with k occurrences of the border mesh pattern p also satisfies (2) and because of the matching initial conditions, the result follows.

To show that the number of such permutations satisfies (2), it helps first to make a few observations about the pattern p . Firstly, given any occurrence of p in an n -permutation, 1 and n must play the roles of 1 and 4 respectively in the pattern. Additionally, n must be the last element of the permutation and the first element of the permutation must play the role of 2 in the pattern. It is then easy to deduce that the number of elements between 1 and n in such a permutation is precisely the number of occurrences of p .

We will now count permutations having exactly k occurrences of p . Either the permutation begins with a 2 or it does not. Suppose the permutation does begin with a 2. As mentioned before it must also end with n and, by the above observations, in order for it to have exactly k occurrences of the pattern, 1 must be fixed in position $n - k - 1$. We are then free to permute the remaining elements in $(n - 3)!$ ways. Thus, the number of permutations beginning with a 2 and having k occurrences of the pattern is $(n - 3)!$.

Now suppose the permutation begins with a number other than 2. Notice that removing the element 2 from the permutation and relabeling yields an $(n - 1)$ -permutation still having k occurrences of the pattern. Also, 2 could have been in any position other than the first and the last so in total there are $(n - 2)$ possible positions for 2. Thus, the number of permutations beginning with an element other than two and having k occurrences of the pattern is $(n - 2)p_{n-1,k}$ and the theorem is proved. □

It turns out that $p_{n,0}$, the number of n -permutations avoiding p , does not satisfy (2). However, from (1), it is clear that we get the following relation $p_{n,k} = p_{n,k-1} - \frac{(n-2)!}{k}$, which does mean that we can always get $p_{n,k}$ in terms of $p_{n,1}$. Using this fact, one can get a formula for $p_{n,0}$, the number of n -permutations which avoid p .

Theorem 3. *We have*

$$p_{n,0} = n! - (n-3)(n-2)! + p_{n,1} = (n-2)!(H_{n-2} + n^2 - 2n + 2).$$

Proof. For any n -permutation, the maximum number of occurrences of the pattern p is $n - 3$, so to compute the number of n -permutations avoiding the pattern we only need to subtract the number of permutations having k occurrences for k from 1 to $n - 3$ from $n!$. This gives

$$\begin{aligned}
p_{n,0} &= n! - \sum_{j=1}^{n-3} p_{n,j} \\
&= n! - (n-2)! \sum_{j=1}^{n-3} \sum_{i=j+1}^{n-2} \frac{1}{i} \\
&= n! - (n-2)! \sum_{i=2}^{n-2} \frac{1}{i} (i-1) \\
&= n! - (n-2)! \left((n-3) - \sum_{i=2}^{n-2} \frac{1}{i} \right) \\
&= n! - (n-3)(n-2)! + p_{n,1}.
\end{aligned}$$

We are done. □

Next we study exponential generating functions (e.g.f.s) for the numbers $p_{n,k}$.

Theorem 4. *Let*

$$P_k(t) = \sum_{n \geq k+3} \frac{p_{n,k}}{(n-2)!} t^{n-2}.$$

Then, $P_k(t)$ satisfies the following differential equation with initial condition $P_k(0) = 0$:

$$P'_k(t) = \frac{k!P_k(t) + t^k}{k!(1-t)} + \frac{t^{k+1}}{(1-t)^2}.$$

Proof. Note that $p_{k+3,k} = k!$ and $p_{i,k} = 0$ for $i \leq k+2$. We begin with the recursion proven in Theorem 2. Namely,

$$p_{n,k} = (n-2)p_{n-1,k} + (n-3)!,$$

which we can write as

$$p_{n,k} = (n-3)p_{n-1,k} + p_{n-1,k} + (n-3)!.$$

Multiply both sides by $\frac{t^{n-3}}{(n-3)!}$ and sum over all $n \geq k+4$:

$$\sum_{n \geq k+4} \frac{p_{n,k} t^{n-3}}{(n-3)!} = t \sum_{n \geq k+4} \frac{p_{n-1,k} t^{n-4}}{(n-4)!} + \sum_{n \geq k+4} \frac{p_{n-1,k} t^{n-3}}{(n-3)!} + \sum_{n \geq k+4} t^{n-3}$$

$$P'_k(t) - \frac{t^k}{k!} = tP'_k(t) + P_k(t) + \frac{t^{k+1}}{1-t}.$$

k	e.g.f.	expansion
1	$\frac{t+\ln(1-t)}{t-1}$	$1\frac{t^2}{2!} + 5\frac{t^3}{3!} + 26\frac{t^4}{4!} + 154\frac{t^5}{5!} + 1044\frac{t^6}{6!} + \dots$
2	$\frac{2t+t^2+2\ln(1-t)}{2(t-1)}$	$2\frac{t^3}{3!} + 14\frac{t^4}{4!} + 94\frac{t^5}{5!} + 684\frac{t^6}{6!} + 5508\frac{t^7}{7!} + \dots$
3	$\frac{6t+3t^2+2t^3+6\ln(1-t)}{6(t-1)}$	$6\frac{t^4}{4!} + 54\frac{t^5}{5!} + 444\frac{t^6}{6!} + 3828\frac{t^7}{7!} + 35664\frac{t^8}{8!} + \dots$
4	$\frac{12t+6t^2+4t^3+3t^4+12\ln(1-t)}{12(t-1)}$	$24\frac{t^5}{5!} + 264\frac{t^6}{6!} + 2568\frac{t^7}{7!} + 25584\frac{t^8}{8!} + 270576\frac{t^9}{9!} + \dots$

Table 1: The e.g.f.s defined in Theorem 4 for the number of permutations with $k = 1, 2, 3, 4$ occurrences of the pattern p .

And thus,

$$P'_k(t) = \frac{k!P_k(t) + t^k}{k!(1-t)} + \frac{t^{k+1}}{(1-t)^2}.$$

□

Corollary 5. *Solving the differential equations in Theorem 4 for $k = 1, 2, 3, 4$ we get e.g.f.s that we record in Table 1. Solving this equation for general k using Mathematica produces the answer:*

$$P_k(t) = \frac{t^{1+k} {}_2F_1[1, 1+k, 2+k, t]}{(1+k)(1-t)},$$

where the hypergeometric function is defined for $|t| < 1$ by the power series

$${}_2F_1(a, b; c; t) = \sum_{n=0}^{\infty} \frac{(a)_n (b)_n t^n}{(c)_n n!}$$

provided that c does not equal $0, -1, -2, \dots$. Here $(q)_n$ is the Pochhammer symbol defined by

$$(q)_n = \begin{cases} 1 & \text{if } n = 0, \\ q(q+1) \cdots (q+n-1) & \text{if } n > 0. \end{cases}$$

3 Wilf-equivalence of q_1 and q_2

In this section we prove the Wilf-equivalence of the patterns q_1 and q_2 defined in Figure 3.

Suppose that $1 \leq x_1 < x_2 < \dots < x_k \leq n$ and $1 \leq y_1 < y_2 < \dots < y_k \leq n$ are respective positions of two occurrences of a length k pattern in an n -permutation. Then we say that the first occurrence is to the left of the second occurrence if (x_1, x_2, \dots, x_k) is

lexicographically smaller than (y_1, y_2, \dots, y_k) . Clearly, this relation defines a total order on the set of all occurrences of the pattern in the permutation. Thus, unless a permutation happens to avoid a pattern, there must be the smallest occurrence, namely the leftmost one.

We establish Wilf-equivalence of q_1 and q_2 by providing a well-defined bijective map g that turns q_1 -avoiding permutations into q_2 -avoiding permutations.

Given a q_1 -avoiding permutation π that also avoids q_2 , we let $g(\pi) = \pi$, which is trivially bijective and well-defined on the set of (q_1, q_2) -avoiding permutations.

On the other hand, if a q_1 -avoiding permutation π contains an occurrence of q_2 , we apply the following procedure. Take the leftmost (lexicographically smallest) occurrence of q_2 and swap the second and third elements of this particular occurrence as shown schematically in Figure 4 below. It is easy to see that an occurrence of q_2 will be turned into an occurrence of q_1 . Now repeat the procedure until there are no longer any occurrences of q_2 in the permutation to obtain $g(\pi)$.

g is well-defined. First, we must justify that the process described above terminates, thus resulting in a q_2 -avoiding permutation. To this end, suppose that xyz is the leftmost occurrence of q_2 in π (occurring in the positions $a < b < c$) as shown in the left half of Figure 4. We will now verify that exchanging y and z does not create an occurrence of q_2 which is lexicographically smaller than the smallest occurrence of q_2 in π . Thus at any point in the process, turning the leftmost occurrence of q_2 into an occurrence of q_1 in the prescribed way will never introduce an occurrence of q_2 which is lexicographically smaller than the occurrence we have just removed. This ensures that the process will eventually terminate. In the following discussion we refer to Figure 4.

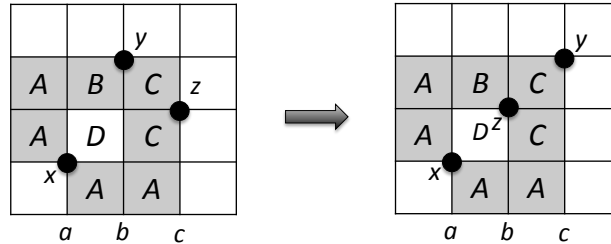

Figure 4: Turning an occurrence of q_2 into an occurrence of q_1 .

Indeed, the areas marked by A in π must be empty because xyz is an occurrence of q_2 (we indicate this by shading the area). The area marked by B must be empty because xyz is the lexicographically smallest occurrence (otherwise any element $y' \in B$ would give an occurrence of q_2 , $xy'z$, which is lexicographically smaller than xyz). By a similar reason the areas marked by C must be empty (otherwise, any element $z' \in C$ would give an occurrence of q_2 , xyz' , which is lexicographically smaller than xyz). Also note that at the first step of the algorithm, the area marked by D must be empty, because otherwise any element $t \in D$ would give an occurrence of q_1 in π , namely xty , but π is q_1 -avoiding. However, after some number of occurrences of q_2 have been turned into occurrences of q_1 , D is not guaranteed

to be empty. Therefore, we do not shade D as we can make an argument that applies to an arbitrary step of the algorithm described. Note that we can say something about the elements inside D , namely that if D contains two or more elements, these elements must be increasing (otherwise, xyz would not be the smallest occurrence of q_2).

Suppose now that turning xyz into xzy creates an occurrence $x'y'z'$ of q_2 that is lexicographically smaller than xyz . It must be the case that $x' = x$. To justify this, note that if $x' \neq x$, then one of y' or z' must be y or z , because if this weren't so, $x'y'z'$ would have been a preexisting occurrence of q_2 that was to the left of xyz , a contradiction. Since one of y' or z' must be y or z , x' could not possibly be located in the top left unshaded area. Thus, $x' < x$, and like before $x'y'z$ would have been a preexisting occurrence of q_2 to the left of xyz , again a contradiction. This fully justifies that $x = x'$, which then implies that $z' = z$ or $z' = y$. This is simply because as mentioned before, one of y' or z' must be y or z , but $y' \neq y$ and $y' \neq z$ as if y' were either y or z this would force $x'y'z'$ to be to the right of xyz , another contradiction. Thus it must be the case that $z' = z$ or $z' = y$.

So, either $xy'z$ or $xy'y$ is an occurrence of q_2 to the left of xyz . In the first case, y' is above the B area, and thus $xy'y$ would be an occurrence of q_2 in π which is to the left of xyz , a contradiction. In the second case, y' is again above the B area, because if it were above the C areas, $xy'y$ would not be to the left of xyz , and we get exactly the same contradiction. Thus we do not create an occurrence of q_2 to the left of xyz at any particular step of the algorithm. Therefore, the process is well-defined and it eventually terminates when all of occurrences of q_2 have been removed.

Note that the number of occurrences of q_2 in π is not necessarily equal to the number of occurrences of q_1 in $g(\pi)$. For example, the permutation 1432 has 3 occurrences of q_2 , while $g(1432) = 1234$ has 4 occurrences of q_1 .

g is invertible. In order to show that g is invertible, and thus is bijective, we need to analyze sequences of consecutive steps of the algorithm which leads us to considering a more refined structure presented in Figure 5. Like in Figure 4, suppose that x is the smallest element of the leftmost occurrence of q_2 .

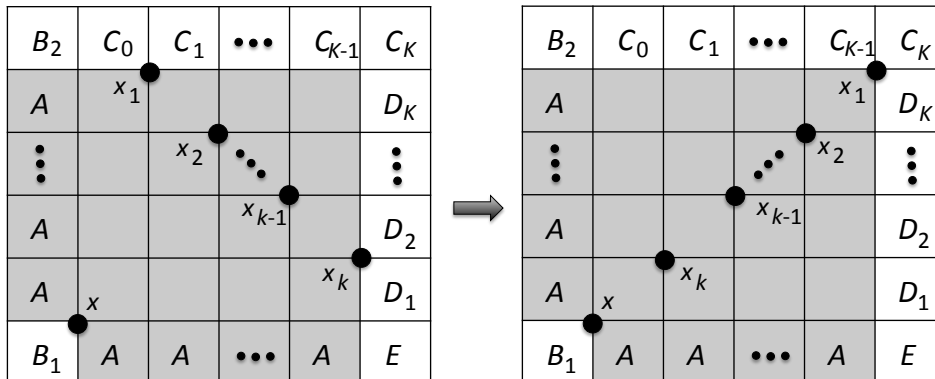

Figure 5: A sequence of steps in turning a cluster of occurrences of q_2 into occurrences of q_1 .

Define $M_x = \{x, x_1, x_2, \dots, x_k\}$ be the set of all elements involved in any occurrence of q_2 having x as the smallest element. We shall refer to the set M_x of elements as a *cluster* of occurrences of q_2 and it can be readily seen that this cluster contains $\binom{k}{2}$ occurrences of q_2 . By the definition of M_x , the squares marked with A in Figure 5 must be empty. Also, note that the elements x_1, x_2, \dots, x_k must be in decreasing order from left to right as shown in Figure 5. This is because if $x_i > x_j$ for $i < j$ then xx_ix_j would be an occurrence of q_1 , which is a contradiction on the first step because the permutation is q_1 -avoiding. It is also a contradiction at any other step because we will soon show that when performing the steps of the algorithm we never introduce an occurrence of q_1 that doesn't have x as the smallest element, i.e. we never introduce q_1 into any other cluster. By a similar argument, the elements inside the square defined by the elements x, x_1 and x_k all belong to the set M_x .

We will now make three important observations. First, the elements in M_x cannot be involved in occurrences of q_2 involving elements outside of M_x . For x it follows by definition of M_x , while if x_i is the smallest element of an occurrence x_iab of q_2 then xab would also be an occurrence of q_2 and thus a, b must belong to M_x . If x_i is the largest or second largest element of an occurrence ax_ib or abx_i , then a must lie inside the square labeled B_1 , contradicting the fact that x is involved as the smallest element in the leftmost occurrence of q_2 . In short, clusters are disjoint.

Second, note that any other cluster of occurrences of q_2 must be entirely contained inside a single square labeled with C_i or D_j . This is true because if there were an occurrence of q_2 that involved two of these squares, one can show that at least one of the elements in M_x would be present in a shaded area for the pattern q_2 . Thus when performing the steps of the algorithm, we are guaranteed to never introduce an occurrence of q_1 whose smallest element also happens to be the smallest element of some other cluster.

After performing $\binom{k}{2}$ steps of our algorithm to the cluster of occurrences of q_2 pictured on the left in Figure 5, we find ourselves in the situation pictured on the right in that figure. We now make our third observation, namely that the elements in M_x now cannot be involved in any occurrences of q_1 involving elements outside of M_x . To justify this, note that any element in the square labeled B_1 could not have been the smallest element of an occurrence of q_2 before the switch, therefore such elements can not be the smallest element of an occurrence of q_1 after the switch. Therefore the elements in M_x could only possibly be the smallest elements of occurrences of q_1 outside of this cluster. This is also not possible. Suppose that some element z of M_x exists such that zab is an occurrence of q_1 with $b \notin M_x$ (certainly if $b \in M_x$, then $a \in M_x$). If b lies in any square labeled with D_i , then xx_1z was an occurrence of q_2 before the switch, a contradiction. If b were in the square labeled with C_i for $1 \leq i \leq k$, then xx_1b was an occurrence of q_1 before the switch which is also a contradiction by our first observation; a similar argument holds if $b \in C_0$.

All of these observations together lead to the fact that after the algorithm will be implemented, the resulting permutation will contain at least one maximal increasing subsequence consisting of at least three elements so that choosing any three of them yields a q_1 pattern, like the sequence $(x, x_k, x_{k-1}, \dots, x_1)$ shown on the right in Figure 5. Such a subsequence had to be introduced by performing the algorithm to a cluster shown on the

left in Figure 5. It is then straightforward to invert g by turning subsequences of the form $x < x_k < x_{k-1} < \cdots < x_2 < x_1$ any three elements of which form an occurrence of the mesh pattern q_1 into $xx_1x_2 \cdots x_k$ where $k \geq 3$ without changing the positions of x, x_1, x_2, \dots, x_k .

4 Mesh patterns over 132-avoiding permutations

In this section, we consider the mesh patterns s_1, s_2, s_3, t_1 and t_2 defined in Figure 3. Throughout the section, we will be using the following fact that is well-known and is easy to see: If a permutation π avoids the (classical) pattern 132, then $\pi = \pi_1 n \pi_2$ where every element of π_1 , if any, is larger than every element of π_2 , if any, and π_1 and π_2 are any 132-avoiding permutations on their respective elements. It is well-known (see, e.g. [4]) that there are C_n n -permutations avoiding 132.

4.1 The pattern s_1 has Catalan's distribution

For a permutation π , we let $N_\tau(\pi)$ denote the number of occurrences of a pattern τ in π .

Lemma 6. *For a 132-avoiding n -permutation π , $N_{s_1}(\pi)$ plus the number of right-to-left maxima in π is equal to n .*

Proof. We can proceed by induction on the length of the permutation. The case $n = 1$ is clear. If $n > 1$, then $\pi = \pi_1 n \pi_2$ where every element of π_1 , if any, is larger than every element of π_2 , if any. Because of this fact, there cannot be any occurrence of s_1 in π having one element in π_1 and the other one in π_2 . We can now apply the induction hypothesis to $\pi_1 n$ and π_2 to get the desired result:

$$\begin{aligned} \text{rmax}(\pi) &= \text{rmax}(\pi_1 n) + \text{rmax}(\pi_2) \\ &= N_{s_1}(\pi_1 n) + N_{s_1}(\pi_2) \\ &= N_{s_1}(\pi), \end{aligned}$$

and thus the lemma holds. □

Let $T(n, k)$ denote the number of 132-avoiding n -permutations with k occurrences of the pattern s_1 . In particular, clearly, $T(1, 0) = 1$ and $T(1, k) = 0$ for $k > 0$.

Theorem 7. *We have $T(n, k) = C(n - 1, k)$, where $C(n, k)$ is the (n, k) -th entry of the Catalan triangle defined in the introduction. Thus,*

$$T(n, k) = \frac{(n - k) \binom{n-1+k}{n-1}}{n}.$$

We supply two proofs of the theorem. The second proof is essentially the exact argument used in the proof of Theorem 9; however, the main reason that we state it here is that it allows us to provide a combinatorial explanation for the fact that the patterns s_1 and s_2 are equidistributed.

First proof of Theorem 7. We use the following recurrence for the Catalan triangle:

$$C(n, k) = \sum_{j=0}^k C(n-1, j), \quad (3)$$

with $C(0, 0) = 1$ and $C(0, k) = 0$ for $k > 0$. Since we already know that $T(1, 0) = 1$ and that $T(1, k) = 0$ for $k > 0$, we need only show that $T(n+1, k)$ satisfies (3).

Consider creating a 132-avoiding $(n+1)$ -permutation from a 132-avoiding n -permutation by inserting $n+1$. The only valid positions to insert $n+1$ is either in front of the n -permutation, or right after a right-to-left maximum, otherwise an occurrence of the pattern 132 will be introduced. Also, inserting $n+1$ never eliminates an occurrence of s_1 . Moreover, inserting $n+1$ in front of an n -permutation does not introduce an occurrence of s_1 , while inserting it immediately to the right of the i -th right-to-left maximum (counted from left to right) increases the number of occurrences of s_1 by i . This is simply because each right-to-left maximum to the left of n , together with n , will contribute new occurrences of s_1 .

We are now able to provide a combinatorial proof of $T(n+1, k) = \sum_{j=0}^k T(n, j)$. Take all 132-avoiding n -permutations having exactly j occurrences of s_1 , where $0 \leq j \leq k$. Now for each permutation, insert $n+1$ in the unique place to make the total number of occurrences of s_1 equal k . Lemma 6 states for a 132-avoiding n -permutation the number of occurrences of s_1 plus the number of right-to-left maxima is equal to n . This lemma coupled with the fact that $k \leq n$ guarantees that we always can insert n into the proper place in a permutation counted by $T(n, j)$ to obtain a permutation counted by $T(n+1, k)$ and thus the recursion is verified. \square

Second proof of Theorem 7. We will prove combinatorially that $T(n, k)$ satisfies $T(n, k) = T(n-1, k) + T(n, k-1)$ for $k < n$, a known recursion for the Catalan triangle.

Again, suppose that $\pi = \pi_1 n \pi_2$. It is not difficult to see that every element in π_1 is the bottom element of exactly one occurrence of p ; the top element of this occurrence is either n or the next element larger than itself. The permutations that correspond to π_1 being empty are counted by the term $T(n-1, k)$. We will now show that $T(n, k-1)$ is responsible for counting those permutations where π_1 is not empty. We accomplish this by providing a general method to take a permutation $\tau = \tau_1 n \tau_2$ counted by $T(n, k-1)$ and move some number of consecutive elements from τ_2 to τ_1 to obtain $\pi = \pi_1 n \pi_2$. This move will ensure that π has exactly one more occurrence of s_1 than τ and will also guarantee that π_1 is not empty. Note here that τ_2 is guaranteed to be non-empty so this move can always be made. If τ_2 were to be empty, there would be $n-1$ occurrences of s_1 , which couldn't possibly be counted by $T(n, k-1)$ as $k < n$.

A more refined structure of a 132-avoiding n -permutation τ is

$$\tau = X_1 x_1 X_2 x_2 \dots X_i x_i n Y_1 y_1 Y_2 y_2 \dots Y_j y_j$$

where each X_s and Y_t are possibly empty 132-avoiding permutations on their respective elements, $\{x_s\}_{s=1}^i$ is the sequence of right-to-left maxima in τ_1 , and $\{y_t\}_{t=1}^j$ is the sequence

of right-to-left maxima in τ_2 . Also whenever $s < t$, each element of X_s , if any, is larger than every element of X_t , if any, and each element of Y_s , if any, is larger than every element of Y_t , if any. Again recall that in this case y_1 exists, i.e. there is at least one element to the right of n .

Now consider the permutation

$$\pi = X_1x_1X_2x_2\dots X_ix_iY_1y_1nY_2y_2\dots Y_jy_j$$

obtained from τ by moving the largest element y_1 to the right of n , together with the preceding block Y_1 , to the other side of n . We claim that the 132-avoiding n -permutation π has exactly one more occurrence of the pattern s_1 as desired and that this operation is clearly invertible. Using reasoning described at the beginning of the proof, every element in Y_1 , if any, was the bottom element of exactly one occurrence of s_1 in τ . After the move, it continues to be the bottom element of such an occurrence in π . On the other hand, y_1 was not the bottom element of an occurrence of s_1 in τ . However, after the move, it becomes the bottom element of exactly one occurrence of s_1 in π , namely y_1n . Thus, each permutation counted by $T(n, k - 1)$ can be transformed using the move described above to a permutation counted by $T(n, k)$. Because this process is invertible, there are no other permutations counted by $T(n, k)$ apart from those counted by $T(n - 1, k) + T(n, k - 1)$. \square

As a byproduct to our research, we define the following set of sequences counted by the Catalan numbers.

Proposition 8. *Let A_n denote the number of sequences $\{a_1, a_2, \dots, a_n\}$ satisfying $a_1 = 0$ and $0 \leq a_i \leq i - 1 - \sum_{j=1}^{i-1} a_j$ for $i \in \{2, \dots, n\}$. Then, A_n is given by C_n , the n -th Catalan number.*

Proof. We will prove that the sequences of length n in question are in one-to-one correspondence with 132-avoiding n -permutations, which are known to be counted by C_n .

Consider creating all 132-avoiding n -permutations by inserting n in every allowable position in every 132-avoiding $(n - 1)$ -permutation. It is easily shown, and was already used above, that the only allowable positions to insert n without introducing an occurrence of 132 is either at the beginning, or immediately after a right-to-left maximum. If at every step we label these possible positions to insert n into an $(n - 1)$ -permutation having k right-to-left maxima from left to right with $0, 1, 2, \dots, k$, then we can encode any 132-avoiding permutation as a sequence of choices of where we inserted the current largest element. Any such sequence must begin with a 0, as the first step always begins with inserting 1 at the beginning of the empty permutation. For example, the 132-avoiding permutation $\pi = 785346291$ is encoded by the sequence 000102013.

We claim that the set of all sequences $\{a_1, a_2, \dots, a_n\}$ in question are precisely the sequences that encode all 132-avoiding permutations using the method described in the previous paragraph. This will follow if we can show that for such a sequence the number of

right-to-left maxima in the corresponding 132-avoiding n -permutation is given by $n - \sum_{j=1}^n a_j$.

We prove this statement by induction on n .

The case $n = 1$ is straightforward as the only sequence is 0 and has corresponding permutation 1, which has exactly $1 - 0 = 1$ right-to-left maximum.

Suppose now that $\{a_1, a_2, \dots, a_n\}$ is a sequence describing insertion of the maximum elements satisfying the conditions specified on the a_i 's (that is $0 \leq a_i \leq i - 1 - \sum_{j=1}^{i-1} a_j$ for $2 \leq i \leq n$), and the number of right-to-left maxima in the corresponding n -permutation σ is $n - \sum_{j=1}^n a_j$. Suppose that $a_{n+1} = k$, where $0 \leq k \leq n - \sum_{j=1}^n a_j$. In this situation, we chose to insert $(n + 1)$ into σ at the position labeled k . It is easy to see that inserting $n + 1$ at position k will force each right-to-left maxima preceding this position to become non-right-to-left maxima, but will always create one as $(n + 1)$ is a right-to-left maximum. Thus the number of right-to-left maxima in the obtained permutation will be decreased by $k - 1$ when $k \geq 1$ or increased by 1 if $k = 0$. Thus the number of right-to-left maxima in the resulting permutation is $n - \sum_{j=1}^n a_j - (a_{n+1} - 1) = n + 1 - \sum_{j=1}^{n+1} a_j$ and the statement is verified. \square

4.2 The pattern s_2 has Catalan's distribution

Let $M(n, k)$ denote the number of 132-avoiding n -permutations with k occurrences of s_2 . Clearly, $M(1, 0) = 1$ and $M(1, k) = 0$ for $k > 0$. The goal of this section is to prove the following theorem.

Theorem 9. *We have $M(n, k) = C(n - 1, k)$, where $C(n, k)$ is the (n, k) -th entry of the Catalan triangle. Thus,*

$$M(n, k) = \frac{(n - k) \binom{n-1+k}{n-1}}{n}.$$

Proof. We will prove combinatorially that $M(n, k)$ satisfies $M(n, k) = M(n - 1, k) + M(n, k - 1)$ for $k < n$, a known recursion for the Catalan triangle.

Again, if $\pi = \pi_1 n \pi_2$ is an n -permutation avoiding the pattern 132, then each element of π_1 , if any, is larger than every element of π_2 , and π_1 and π_2 are any 132-avoiding permutations on their respective elements. Moreover, each element of π_1 , if any, is the bottom element of a unique occurrence of the pattern s_2 , namely the one involving the top element n . It could not be the bottom element of another occurrence of s_2 because n would always be present in the shaded area of s_2 . The permutations that correspond to π_1 being empty are counted by the term $M(n, k - 1)$. We will now show that $M(n, k - 1)$ is responsible for counting those permutations where π_1 is not empty. We accomplish this by providing a general method to take a permutation $\tau = \tau_1 n \tau_2$ counted by $M(n, k - 1)$ and

move some number of consecutive elements from τ_2 to τ_1 to obtain $\pi = \pi_1 n \pi_2$. This move will ensure that π has exactly one more occurrence of s_2 than τ and will also guarantee that π_1 is not empty. Note here that τ_2 is guaranteed to be non-empty so this move can always be made. If τ_2 were to be empty, there would be $n - 1$ occurrences of s_2 , which could not possibly be counted by $M(n, k - 1)$ as $k < n$.

A more refined structure of a 132-avoiding n -permutation τ is

$$\tau = X_1 x_1 X_2 x_2 \dots X_i x_i n Y_1 y_1 Y_2 y_2 \dots Y_j y_j$$

where each X_s and Y_t are possibly empty 132-avoiding permutations on their respective elements, $\{x_s\}_{s=1}^i$ is the sequence of right-to-left maxima in τ_1 , and $\{y_t\}_{t=1}^j$ is the sequence of right-to-left maxima in τ_2 . Also whenever $s < t$, each element of X_s , if any, is larger than every element of X_t , if any, and each element of Y_s , if any, is larger than every element of Y_t , if any. Again recall that in this case y_1 exists, i.e. there is at least one element to the right of n .

Now consider the permutation

$$\pi = X_1 x_1 X_2 x_2 \dots X_i x_i Y_1 y_1 n Y_2 y_2 \dots Y_j y_j$$

obtained from τ by moving the largest element y_1 to the right of n , together with the preceding block Y_1 , to the other side of n . We claim that the 132-avoiding n -permutation π has exactly one more occurrence of the pattern s_2 as desired and that this operation is clearly invertible. Using reasoning described at the beginning of the proof, every element in Y_1 , if any, was the bottom element of exactly one occurrence of the pattern s_2 in τ . After the move, it continues to be the bottom element of such an occurrence in π , however the top element of the occurrence changes from y_1 to n . On the other hand, y_1 was not the bottom element of an occurrence of s_2 in τ . However, after the move, it becomes the bottom element of exactly one occurrence of s_2 , namely $y_1 n$. Thus, each permutation counted by $M(n, k - 1)$ can be transformed using the move described above to a permutation counted by $M(n, k)$. Because this process is invertible, there are no other permutations counted by $M(n, k)$ apart from those counted by $M(n - 1, k) + M(n, k - 1)$. \square

Thus, we obtain a new combinatorial interpretation of $C(n - 1, k)$, namely the number of 132-avoiding n -permutations having exactly k occurrences of s_2 . Using this new interpretation, we were able to provide a relation which seems to be new on the Catalan triangle, and we record it as the following theorem.

Theorem 10. *For the Catalan triangle,*

$$C(n, k) = \sum_{i=0}^k C_i C(n - i - 1, k - i).$$

Proof. As reasoned in the proof of Theorem 9, if $\pi = \pi_1 n \pi_2$ is an n -permutation avoiding the pattern 132, then each element of π_1 , if any, is larger than every element of π_2 , and π_1 and π_2 are any 132-avoiding permutations on their respective elements. Moreover, each

element of π_1 , if any, is the bottom element of a unique occurrence of the pattern s_2 , namely the one involving the top element n .

Additionally, $\pi_1 n$ has no affect on occurrences of s_2 inside π_2 . Since there are C_n 132-avoiding n -permutations, we get the following recursion for $M(n, k)$:

$$M(n, k) = \sum_{i=0}^k C_i M(n - i - 1, k - i) \quad (4)$$

with initial conditions $M(n, 0) = 1$ and $M(n, n) = 0$ for all $n \geq 1$. Theorem 9 verifies that equation (4) is equivalent to the statement of the theorem. \square

Using known formulas for both C_i and $C(n, k)$, Theorem 10 gives rise to the following binomial identity.

Corollary 11. *We have*

$$\frac{(n - k) \binom{n-1+k}{n-1}}{n} = \sum_{i=0}^k \frac{\binom{2i}{i}}{i + 1} \frac{(n - k - 1) \binom{n-2i-2+k}{n-i-2}}{n - i - 1}.$$

Remark 12. *We have used the same recursion for the Catalan triangle in the proof of Theorem 9 and in the second proof of Theorem 7, which induces a bijective proof of the equidistribution of the mesh patterns s_1 and s_2 on 132-avoiding permutations.*

4.3 The patten s_3 has the reverse Catalan distribution

We let $N(n, k)$ denote the number of 132-avoiding n -permutations with k occurrences of the pattern s_3 . Clearly, $N(1, 0) = 1$ and $N(1, k) = 0$ for $k > 0$.

Theorem 13. $N(n, k) = C(n - 1, n - 1 - k)$, where $C(n, k)$ is the (n, k) -th entry of the Catalan triangle. Thus,

$$N(n, k) = \frac{(k + 1) \binom{2(n-1)-k}{n-1}}{n}.$$

Proof. We explain this fact by establishing a bijection f which we will show is actually an involution between 132-avoiding n -permutations having k occurrences ($0 \leq k \leq n - 1$) of the pattern s_3 and 132-avoiding n -permutations having $n - 1 - k$ occurrences of the pattern s_1 (of which there are $C(n - 1, n - 1 - k)$ many by Theorem 7).

It is easy to see that the bottom elements of occurrences of s_3 in a 132-avoiding permutation π are precisely those elements that are both a left-to-right minimum and a right-to-left maximum in the permutation obtained from π by removing all right-to-left maxima. At the same time, the only elements in π that are not the bottom elements of an occurrence of s_1 are precisely the right-to-left maxima of π .

We will provide a map that will turn the position of a bottom element of an occurrence of s_3 , as well as the rightmost element of an n -permutation, into the position of a right-to-left maximum (which as mentioned before can not be the bottom element of an occurrence of s_1) and vice-versa.

Let $\pi = \pi_1\pi_2 \cdots \pi_n$ be a 132-avoiding permutation with right-to-left maxima in positions $1 \leq i_1 < i_2 < \cdots < i_m = n$ and let $I_\pi = \{i_1, \dots, i_m\}$. Note that π_{i_1} must be n . Also, let the bottom elements of occurrences of s_3 in π be in positions $1 \leq a_1 < a_2 < \cdots < a_{s-1} < n$, $a_s := n$ and let $A_\pi = \{a_1, \dots, a_s\}$. Note that the sets I_π and A_π are both guaranteed to contain n and this is the only element they share in common.

We will first build an auxiliary permutation $\pi' = \pi'_1\pi'_2 \cdots \pi'_n$ by cyclically shifting the elements having positions in I_π to the left. Formally,

- $\pi'_i := \pi_i$ if $i \notin I_\pi$
- $\pi'_{i_j} := \pi_{i_{j+1}}$ for $j = 1, 2, \dots, m-1$ and
- $\pi'_{i_m} := \pi_{i_1} = n$.

We now build the image of π , $\sigma = \sigma_1\sigma_2 \cdots \sigma_n = f(\pi)$ from π' by cyclically shifting the elements having positions in A_π to the right. Formally,

- $\sigma_i := \pi'_i$ if $i \notin A_\pi$
- $\sigma_{a_i} := \pi'_{a_{i-1}}$ for $2 \leq i \leq s$ and
- $\sigma_{a_1} = \pi'_{a_s}$.

To demonstrate the map, we will show how it acts on the 132-avoiding permutation

$$\pi = (23)(24)(22)(20)(21)(25)(18)(17)(16)(19)(15)(11)(12)(13)9(10)(14)65741238.$$

It is easy to verify that for π , $I_\pi = \{6, 10, 11, 17, 25\}$ and $A_\pi = \{3, 7, 8, 9, 21, 25\}$. We first perform the cyclic shift among the elements having positions in I_π to the left to obtain

$$\pi' = (23)(24)(22)(20)(21)(19)(18)(17)(16)(15)(14)(11)(12)(13)9(10)86574123(25).$$

Now we perform the cyclic shift among the elements having positions in A_π to the right to obtain the image of the map

$$\sigma = (23)(24)(25)(20)(21)(19)(22)(18)(17)(15)(14)(11)(12)(13)9(10)8657(16)1234.$$

Note that while in the image permutation σ ,

$$I_\sigma = \{3, 7, 8, 9, 21, 25\} \text{ and } A_\sigma = \{6, 10, 11, 17, 25\}$$

so that $I_{f(\pi)} = A_\pi$ and $A_{f(\pi)} = I_\pi$. In fact, we will show that this is always the case and with this fact, f is easily seen to be an involution.

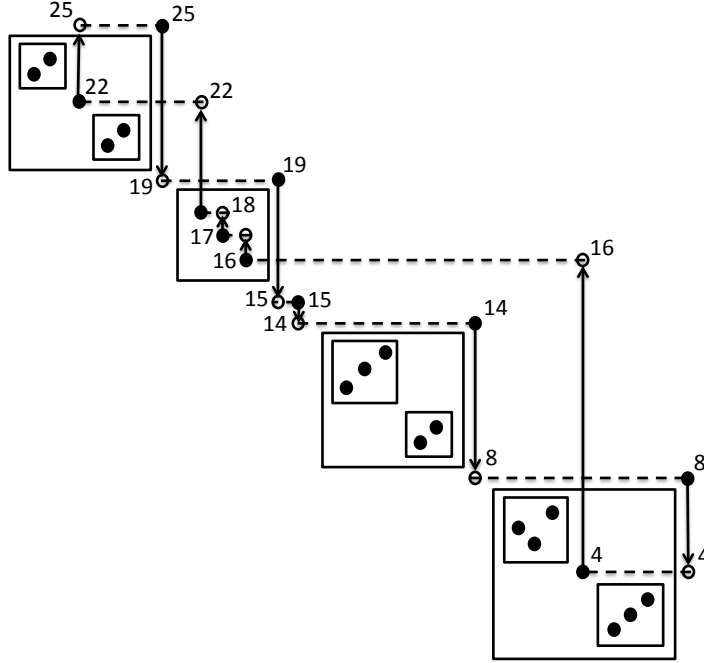

Figure 6: $(23)(24)(22)(20)(21)(25)(18)(17)(16)(19)(15)(11)(12)(13)9(10)(14)65741238$ and its image under the involution f .

The permutation matrix for π and $f(\pi)$ are shown in Figure 6. In this figure, the elements in smaller boxes without arrows are unchanged in value/position, while the other solid circles belong to the original permutation and the open circles belong to its image; for each unfixed position, there is a vertical arrow from the value of π to the value of $f(\pi)$ and the horizontal lines were included to show the levels on which elements are moved.

To check understanding, the reader can verify that image of

$$\tau = (15)(14)(12)(13)(16)89(10)(11)5643127$$

under f is

$$(16)(15)(12)(13)(11)89(10)756(14)4123.$$

It was mentioned earlier that $I_{f(\pi)} = A_\pi$ and $A_{f(\pi)} = I_\pi$. This is a direct consequence of the definition of the map and is most easily understood visually with help of Figure 6. However, for those who appreciate technical detail, we shall provide rigorous arguments in the following two paragraphs, for those who don't, feel free to skip over them.

Suppose we have a 132-avoiding permutation π having corresponding sets A_π and I_π with $i_j \in I_\pi$ and $i_j \neq n$. There is no need to consider the case when $i_j = n$ as $n \in A_{f(\pi)}$ by definition. Let us examine what happens at position i_j throughout the map f . After the first cyclic shift, we have that π'_{i_j} has only one element larger than it located to its right, namely n , and has no elements smaller than it located to its left. The latter fact is simply because if a smaller element did exist to its left then it would have been the bottom

element of a 132 pattern in π along with the elements at positions i_j and i_{j+1} (which exists since $i_j \neq n$). Consider the first position, a_k , to the right of i_j that is in A_π . After the second cyclic shift, we claim that the value at position a_k in $f(\pi)$ is greater than π'_{i_j} and is thus a right-to-left maximum, ensuring that there is an occurrence of s_3 having bottom element at position i_j and top element at position a_k . To see this, realize that if there is no element of A_π less than i_j , the claim is immediate as the element at position a_k will be n in this situation. Otherwise, we know that the value of π at position a_{k-1} (which is precisely the value of the $f(\pi)$ at position a_k) is larger than π'_{i_j} because if not, then the elements at positions a_{k-1} , i_j and i_{j+1} in π would have been an occurrence of 132. Also, in this case, the element n must now precede $f(\pi)_{a_k}$, which ensures that it is also a right-to-left maximum. This verifies that i_j belongs to the set $A_{f(\pi)}$.

Now suppose we have a 132-avoiding permutation π having corresponding sets $A_\pi = \{a_1, \dots, a_s\}$ and I_π with $a_k \in A_\pi$ and $a_k \neq n$. Again, we will examine what happens at position a_k throughout the map f . To begin, there is only one element of π to the right of position a_k that is larger than π_{a_k} and this element $i_j \in I_\pi$ must be a right-to-left maximum of π . After the first cyclic shift, π'_{i_j} is either smaller than π'_{a_k} or $\pi'_{i_j} = n$. If $\pi'_{i_j} \neq n$ and was larger than π'_{a_k} , then the elements at positions a_k , i_j and i_{j+1} in π would have been an occurrence of 132. In either case, we have that $\pi'_n = n$ is the only element following position a_k that is larger than π'_{a_k} . Additionally, we have that $\pi'_{a_k} < \pi'_{a_{k-1}}$ for $2 \leq k \leq s$ and that $\pi_{a_1} < \pi'_{a_s} = n$. These facts guarantee that after the second cyclic shift, the element of $f(\pi)$ at position a_k will be a right-to-left maximum as n will now be forced to either precede $f(\pi)_{a_k}$ or actually be equal to the value of $f(\pi)$ at this position. This verifies that a_k belongs to the set $I_{f(\pi)}$.

We will now show that f is actually an involution by showing that the image of f is actually a 132-avoiding permutation. To this end, for any permutation π , note that we do not change values of elements whose positions do not belong to $I_\pi \cup A_\pi = I_{f(\pi)} \cup A_{f(\pi)}$. Thus, if an occurrence of the pattern 132 did exist in $f(\pi)$, it must involve three elements, one of which must be in $I_\pi \cup A_\pi$. Suppose $i \in I_\pi \cup A_\pi$. If $i \in I_\pi$, then $i \in A_{f(\pi)}$ and therefore only one element to the right of position i can be larger than $f(\pi)_i$. If $i \in A_\pi$, then $i \in I_{f(\pi)}$ and therefore no element to the right of position i can be larger than $f(\pi)_i$. These facts guarantee that the element at position i can not play the role of 1 in a 132 pattern. Similarly, one can show that i can not play the role of 3 in an occurrence of the pattern 132, since either there are no elements smaller than π_i to the left of it, or everything to the left of π_i is larger than everything to the right of it. Finally, $i \neq n$ can not play the role of 2 in an occurrence of 132 because again, since either there are no elements smaller than π_i to the left of it, or there are no elements smaller than π_i to the left of the nearest right-to-left maximum preceding π_i . \square

Remark 14. *The fact that the map f in the proof of Theorem 13 is actually an involution proves a more general fact, namely that the pairs of statistics $(s_3, n - 1 - s_1)$ and $(n - 1 - s_1, s_3)$ are equidistributed on 132-avoiding permutations. In fact, the involution f actually gives a more general fact on joint equidistribution of quadruples of statistics $(s_3, v(s_3), n - 1 - s_1, v(\text{nons}_1))$ and $(n - 1 - s_1, v(\text{nons}_1), s_3, v(s_3))$ where $v(p_3)$ is a binary vector showing positions in which the bottom elements of occurrences of s_3 occur; e.g., for s_3 0010011 would*

mean that the bottom elements of s_3 are in the 3rd and 6th positions, and we can assume that the rightmost element is always 1 by definition. The meaning of $v(\text{nons}_1)$ should be clear: this is a binary vector recording positions of elements which are not bottom elements in occurrences of s_1 .

4.4 On the pattern t_1

In this subsection, we discuss the minimum and the maximum number of occurrences of the pattern t_1 on 132-avoiding permutations. Suppose $\pi_i < \pi_j$ for $i < j$ in a permutation $\pi = \pi_1\pi_2\cdots\pi_n$. By the *box between π_i and π_j* we mean the rectangle in the permutation matrix of π defined by i, j, π_i and π_j .

It is easy to see, and first was observed in [1, Theorem 4], that on 132-avoiding permutations, avoidance of t_1 is equivalent to avoidance of the classical pattern 123. Indeed, if we avoid 123 we clearly avoid t_1 . On the other hand, if we contain 123, then there must exist an occurrence of 123 which is also an occurrence of t_1 . Indeed, for any occurrence xyz of 123, if it is not an occurrence of t_1 , select the smallest element greater than y positioned strictly to the right of y but to the left of z (possibly including z), and the largest element less than y positioned strictly to the left of y but to the right of x (possibly including x). These two chosen elements together with y will form an occurrence of t_1 . Thus, simultaneous avoidance of 132 and t_1 is equivalent to simultaneous avoidance of 132 and 123, which is known to give cardinalities 2^{n-1} for n -permutations.

In what follows, we will explain our observation that the number of 132-avoiding permutations with the maximum number of occurrences of t_1 is given by the Catalan numbers.

Lemma 15. *In a 132-avoiding n -permutation, each element is the bottom element of at most one occurrence of t_1 and thus taking into account that n and $n - 1$ cannot be bottom elements of such occurrences, the maximum number of occurrences of t_1 is no more than $n - 2$ (which is attainable by, e.g. $12\cdots n$).*

Proof. Let xyz be an occurrence of t_1 , where x is the bottom element. Suppose $xy'z'$ is another occurrence of t_1 . If y' is to the left of y then y' must be larger than y (because xyz is an occurrence of t_1 and y' must be outside of the box between x and y), but then $xy'y$ is an occurrence of the pattern 132, which is a contradiction. On the other hand, if y' is to the right of y , then either y will be in the prohibited area between x and y' (if $y' > y$), or xyy' is an occurrence of the pattern 132 which is also a contradiction. Thus $y = y'$.

Similarly, if z' is to the left of z , then z' must be larger than z (not to be in the box between y and z), and we get that $yz'z$ is an occurrence of the pattern 132. On the other hand, if z' is to the right of z , then either z is in the prohibited area between z' and y , or yzz' is an occurrence of the pattern 132. Thus $z = z'$, and xyz is the only occurrence of t_1 having x as bottom element. \square

Lemma 16. *In a 132-avoiding n -permutation with maximum number of occurrences of t_1 , n must be the rightmost element and it must be preceded by $n - 1$.*

Proof. Clearly, a right-to-left maximum cannot be the bottom element of an occurrence of t_1 , and thus, by Lemma 15, an optimal permutation has at most two right-to-left maxima.

Any 132-avoiding permutation π has the structure $\pi_1 n \pi_2$, where each element of π_1 , if any, is larger than every element of π_2 , if any. Assume π has two right-to-left maxima, which makes π_2 non-empty. One of the two must be n and the other we will call x (the rightmost element of π). We see that the maximum element to the left of n and the maximum element between n and x (at least one of them exists assuming the length of π is at most 3), cannot be the bottom element of an occurrence of t_1 . Thus, π has at most $n - 3$ occurrences of t_1 and cannot be optimal. This tells us that n must be the rightmost element (the single right-to-left maximum). Therefore, we can assume $\pi = \pi' n$. However, a right-to-left maximum in π' cannot be the bottom element of an occurrence of t_1 , and thus, having more than one right-to-left maxima in π' would mean having at most $n - 3$ occurrences of t_1 in π . Thus, we must have $\pi = \pi''(n - 1)n$ for some permutation π'' \square

Lemma 17. *Suppose $\pi = \pi''(n - 1)n$ is a 132-avoiding permutation. Then the number of occurrences of t_1 in π is $(n - 2)$, and thus, by Lemma 15, π has the maximum possible number of occurrences of t_1 .*

Proof. Let x be an element of π'' . Our goal is to show that x is the bottom element of an occurrence of t_1 in π . Indeed, $x(n - 1)n$ is an occurrence of the mesh pattern r_1 shown in Figure 7. If there are no elements in the box defined by x and $(n - 1)$, we are done. Otherwise, let y be the smallest element in that box. Clearly $xy(n - 1)$ is an occurrence of the mesh pattern r_2 shown in Figure 7. If this is actually an occurrence of t_1 , we are done. Otherwise, let z be the minimum element in the box defined by y and $(n - 1)$. Then xyz is an occurrence of t_1 . \square

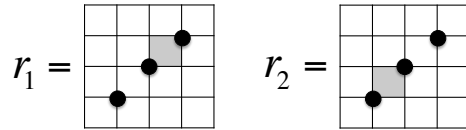

Figure 7: Two auxiliary mesh patterns.

Theorem 18. *There are C_{n-2} 132-avoiding n -permutations that contain the maximum number of occurrences of t_1 .*

Proof. The result follows from Lemmas 16 and 17 since the permutation π'' in Lemma 17 is an arbitrary 132-avoiding permutation known to be counted by C_{n-2} . \square

4.5 On the pattern t_2

In this subsection, we will prove a number of observations regarding the distribution of t_2 on 132-avoiding permutations.

Lemma 19. *If a 132-avoiding n -permutation π contains at least one occurrence of t_2 , then it ends with n and contains an occurrence of t_2 that involves n .*

Proof. Suppose that n is not at the end of π and $\pi = \pi_1 n \pi_2$ with π_2 non-empty. Clearly, because of an element in π_2 , t_2 cannot occur in $\pi_1 n$, and because of n , t_2 cannot occur in π_2 . No other occurrence of t_2 could exist in π because each element in $\pi_1 n$ is larger than every element in π_2 , which is a contradiction. Thus π must end with n .

Now, suppose that xy is an occurrence of t_2 in a permutation π and $y \neq n$. Assume that there is at least one element in the box defined by y and n . If not, yn is the desired occurrence of t_2 . Otherwise, one can take the topmost element in that box together with n to get the desired occurrence of t_2 . This completes the proof. \square

Remark 20. *Note that in the box defined by y and n in Lemma 19, all elements, if any, must be in increasing order to avoid the pattern 132.*

Theorem 21. *For $n \geq 3$, there are no 132-avoiding permutations with exactly one occurrence of the pattern t_2 .*

Proof. Suppose there exists a 132-avoiding permutation π of length n that has exactly one occurrence of t_2 . By Lemma 19, π ends with n and the only occurrence of t_2 in π involves n . Suppose that $\pi = \pi_1 n$ and the single occurrence of t_2 is xn for some x in π_1 . In the permutation matrix of π , the element x subdivides π_1 into four quadrants (using usual way to label quadrants in counterclockwise direction), where quadrant I is empty. If quadrant II is not empty, then its largest element together with n would be a different occurrence of t_2 . Similarly, if quadrant IV is not empty, then its largest element together with n would also be a different occurrence of t_2 . Lastly, if quadrant III is not empty, then its topmost element together with x would be another occurrence of t_2 . Thus all four quadrants are empty, which contradicts the assumption that $n \geq 3$. Therefore, no such π can exist. \square

As a direct corollary to the proof of Theorem 21, we have the following theorem.

Theorem 22. *The number of 132-avoiding n -permutations that avoid t_2 is given by $C_n - C_{n-1}$.*

Proof. The number of n -permutations avoiding the pattern 132 is C_n . Again, by Lemma 19, if such a permutation contains t_2 then n must be the rightmost element, and therefore could not be part of a 132 pattern in the permutation. Thus, the number of 132-avoiding n -permutations with n at the end is given by C_{n-1} . \square

A *Dyck path* of length $2n$ is a lattice path from $(0, 0)$ to $(2n, 0)$ with steps $U = (1, 1)$ and $D = (1, -1)$ that never goes below the x -axis. In the *standard bijection* between 132-avoiding permutations and Dyck paths, the position of the largest element corresponds to the leftmost return of a path to the x -axis (see [4] for details). Using Theorem 22, we can easily map bijectively such permutations to, e.g., Dyck paths that do not start with UU . Indeed, Dyck paths that begin with UD can be mapped to 132-avoiding permutations ending with the largest element through the standard bijection composed with applying

reverse to Dyck paths. The same map will then send $(132, t_2)$ -avoiding permutations to Dyck paths beginning with UU .

The following lemma is straightforward to prove.

Lemma 23. *Let $\pi = \pi'n$ be a 132-avoiding n -permutation. We have that x is a right-to-left maximum in π' if and only if xn is an occurrence of t_2 .*

Theorem 24. *For $n \geq 4$, there are C_{n-2} 132-avoiding n -permutations that contain exactly two occurrences of t_2 . There are two such permutations of length 3 and none of smaller lengths.*

Proof. To contain occurrences of t_2 , Lemma 19 forces the structure of n -permutations in question to be $\pi'n$. By Lemma 23, π' has either one or two right-to-left maxima.

If π' has one right-to-left maximum, then $\pi = \pi''(n-1)n$. We see that $(n-1)n$ is an occurrence of t_2 , and unless $\pi = 123$, Theorem 21 verifies that it is not possible to have exactly one occurrence of t_2 in π'' which is equivalent to having exactly two occurrences of t_2 in π .

Suppose that π' has two right-to-left maxima, $n-1$ and x . Note that x must be the rightmost element of π' . Clearly, $(n-1)n$ and xn are both occurrences of t_2 . Also there are no elements to the right of $n-1$ that are larger than x . On the other hand since π must avoid the pattern 132, no element to the left of $n-1$ is smaller than x . Further, because of x , no element to the left of $(n-1)$ (all of which are larger than x) can be the bottom element of an occurrence of t_2 , and such elements can form any 132-avoiding permutation. Similarly, no element to the right of $(n-1)$ that is smaller than x can be the bottom element of an occurrence of t_2 because of $n-1$ and these elements can form any 132-avoiding permutation. Thus, assuming $A_{2,n}$ denotes the number of 132-avoiding n -permutations with exactly two occurrences of t_2 , we have, for $n \geq 4$, the following recursion, where i stands for the number of elements to the left of $(n-1)$:

$$A_{2,n} = \sum_{i=0}^{n-3} C_i C_{n-3-i} = C_{n-2}.$$

The case $n = 3$ is $A_{2,3} = 2$, which is given by the permutations 123 and 213. □

Theorem 25. *For $n \geq 5$, there are C_{n-2} 132-avoiding n -permutations that contain exactly three occurrences of t_2 . There are three such permutations of length 4 and none of smaller lengths.*

Proof. Let $n \geq 4$ (clearly for smaller lengths we have no “good” permutations). By Lemma 19, to contain occurrences of t_2 , the structure of an n -permutation π in question must be $\pi'n$. By Lemma 23, π' has either one or two or three right-to-left maxima.

If π' has one right-to-left maximum, then either π ends with $(n-2)(n-1)n$ or it ends with $(n-1)n$ and there are two right-to-left maxima in the permutation obtained from π by removing $(n-1)n$. In the former case, unless $\pi = 1234$, by Theorem 21, we have no “good” permutations, while in the later case we can apply Theorem 24 to obtain C_{n-3}

permutations containing exactly three occurrence of t_2 (note, that $(n-1)n$ is an occurrence of t_2).

If π' has two right-to-left maxima, then they, together with n , will form two occurrences of t_2 , and following the arguments in Theorem 24 we will see that there are no other occurrences of t_2 . Thus, there are no “good” permutations in this case.

Finally, if π' has three right-to-left maxima, say $(n-1) > x > y$, then we can argue in a similar way as in the proof of Theorem 24 to see that $\pi = \pi'_1(n-1)\pi'_2x\pi'_3yn$ where each element of π'_1 , if any, is larger than any element in π'_2 and π'_3 , and each element of π'_2 , if any, is larger than any element in π'_3 . Moreover, π'_1 (resp., π'_2 and π'_3) is any 132-avoiding permutation not contributing to extra occurrences of t_2 . Thus, if $n \geq 5$ and $A_{3,n}$ is the number of 132-avoiding n -permutations with exactly three occurrences of t_2 , we have the following recursion (here i is the number of elements to the left of $(n-1)$ and j is the number of elements between $(n-1)$ and x):

$$A_{3,n} = C_{n-3} + \sum_{i=0}^{n-4} C_i \sum_{j=0}^{n-4-i} C_j C_{n-4-i-j} = C_{n-3} + \sum_{i=0}^{n-4} C_i C_{n-3-i} = \sum_{i=0}^{n-3} C_i C_{n-3-i} = C_{n-2}.$$

The case $n = 4$ is $A_{3,4} = 3$, which is given by the permutations 1234, 2134 and 3214. \square

Remark 26. *Note that by Theorems 24 and 25, for $n \geq 4$, the numbers of 132-avoiding n -permutations containing exactly two and exactly three occurrences of t_2 coincide. A natural question here is to provide a combinatorial proof of this fact.*

5 Concluding remarks

Studying the distribution of occurrences of a given pattern on various sets of permutations is typically a very hard problem, but in this paper we were able to solve this problem explicitly for four patterns, namely p , s_1 , s_2 and s_3 , providing links to two well-known objects – the harmonic numbers and Catalan’s triangle. A natural research direction here is to continue this study for other patterns. If determining the complete distribution seems difficult, one could attempt to provide formulas for particular cases like we have done for the patterns t_1 and t_2 on 132-avoiding permutations. Also, the patterns we have studied on 132-avoiding permutations (s_1 , s_2 , s_3 , t_1 and t_2) can be studied over all permutations or other sets of restricted permutations. Likely, such studies will bring bijective questions, like the one mentioned in Remark 26.

6 Acknowledgments

We are grateful to Sofia Archuleta for useful discussions, in particular helping discover and verify the bijection presented in Section 3.

References

- [1] S. Avgustinovich, S. Kitaev and A. Valyuzhenich, Avoidance of boxed mesh patterns on permutations, *Discrete Appl. Math.*, to appear.
- [2] P. Brändén and A. Claesson, Mesh patterns and the expansion of permutation statistics as sums of permutation patterns, *Elect. J. Comb.* **18(2)** (2011), #P5, 14pp.
- [3] Í. Hilmarsson, I. Jónsdóttir, S. Sigurdardóttir, H. Úlfarsson and S. Vidarsdóttir, Partial Wilf-classification of small mesh patterns, in preparation.
- [4] S. Kitaev, Patterns in permutations and words, Springer-Verlag, (2011).
- [5] S. Kitaev and J. Remmel, Quadrant marked mesh patterns, *J. Integer Sequences*, **12** Issue 4 (2012), Article 12.4.7.
- [6] S. Kitaev and J. Remmel, Quadrant marked mesh patterns in alternating permutations, preprint.
- [7] S. Kitaev and J. Remmel, Quadrant marked mesh patterns in alternating permutations II, preprint.
- [8] S. Kitaev, J. Remmel and M. Tiefenbruck, Quadrant marked mesh patterns in 132-avoiding permutations I, preprint.
- [9] S. Kitaev, J. Remmel and M. Tiefenbruck, Quadrant marked mesh patterns in 132-avoiding permutations II, in preparation.
- [10] N. J. A. Sloane, The on-line encyclopedia of integer sequences, published electronically at <http://www.research.att.com/~njas/sequences/>.
- [11] H. Úlfarsson, A unification of permutation patterns related to Schubert varieties, arXiv:1002.4361 (2011).
- [12] H. Úlfarsson, Describing West-3-stack-sortable permutations with permutation patterns, to appear in *Séminaire Lotharingien de Combinatoire* (2012).