

Sharp Bounds on Davenport-Schinzel Sequences of Every Order*

Seth Pettie
University of Michigan

October 31, 2018

Abstract

One of the longest-standing open problems in computational geometry is to bound the lower envelope of n univariate functions, each pair of which crosses at most s times, for some fixed s . This problem is known to be equivalent to bounding the length of an order- s Davenport-Schinzel sequence, namely a sequence over an n -letter alphabet that avoids alternating subsequences of the form $a \cdots b \cdots a \cdots b \cdots$ with length $s + 2$. These sequences were introduced by Davenport and Schinzel in 1965 to model a certain problem in differential equations and have since been applied to bounding the running times of geometric algorithms, data structures, and the combinatorial complexity of geometric arrangements.

Let $\lambda_s(n)$ be the maximum length of an order- s DS sequence over n letters. What is λ_s asymptotically? This question has been answered satisfactorily (by Hart and Sharir, Agarwal, Sharir, and Shor, Klazar, and Nivasch) when s is even or $s \leq 3$. However, since the work of Agarwal, Sharir, and Shor in the mid-1980s there has been a persistent gap in our understanding of the odd orders.

In this work we effectively close the problem by establishing sharp bounds on Davenport-Schinzel sequences of *every* order s . Our results reveal that, contrary to one's intuition, $\lambda_s(n)$ behaves essentially like $\lambda_{s-1}(n)$ when s is odd. This refutes conjectures due to Alon et al. (JACM, 2008) and Nivasch (JACM, 2010).

1 Introduction

Consider the problem of bounding the complexity of the lower envelope of n continuous univariate functions f_1, \dots, f_n , each pair of which cross at most s times. In other words, how many maximal connected intervals of the $\{f_i\}$ are contained in the graph of the function $f_{\min}(x) = \min\{f_1(x), \dots, f_n(x)\}$? In the absence of any constraints on $\{f_i\}$ this problem can be completely stripped of its geometry by *transcribing* the lower envelope f_{\min} as a *Davenport-Schinzel (DS) sequence* of order s , namely, a repetition-free sequence over the alphabet $\{1, \dots, n\}$ that does not contain any alternating subsequences of the form $\cdots a \cdots b \cdots a \cdots b \cdots$ with length $s + 2$, for any $a, b \in \{1, \dots, n\}$.¹ Although Davenport and Schinzel [27] introduced this problem nearly 50 years ago, it was only in the early 1980s that DS sequences became well known in the computational geometry community [14, 76]. Since then DS sequences have found a startling number of geometric

*This work is supported by NSF CAREER grant no. CCF-0746673, NSF grant no. CCF-1217338, and a grant from the US-Israel Binational Science Foundation.

¹If the sequence corresponding to the lower envelope contained an alternating subsequence $abab \cdots$ with length $s + 2$ then the functions f_a and f_b must have crossed at least $s + 1$ times, a contradiction.

applications, with a growing number [72, 59, 9, 21, 48, 65] that are not overtly geometric.² In each of these applications some quantity (e.g., running time, combinatorial complexity) is expressed in terms of $\lambda_s(n)$, the maximum length of an order- s DS sequence over an n -letter alphabet. To improve bounds on λ_s is, therefore, to improve our understanding of numerous problems in algorithms, data structures, and discrete geometry.

Davenport and Schinzel [27] established $n^{1+o(1)}$ upper bounds on $\lambda_s(n)$ for every order s . In order to properly survey the improvements that followed [26, 79, 41, 73, 74, 56, 4, 51, 63] we must define some notation for forbidden sequences and their extremal functions.

1.1 Sequence Notation and Terminology

Let $|\sigma|$ be the length of a sequence $\sigma = (\sigma(i))_{1 \leq i \leq |\sigma|}$ and let $\|\sigma\|$ be the size of its alphabet $\Sigma(\sigma) = \{\sigma(i)\}$. Two equal length sequences are *isomorphic* if they are the same up to a renaming of their alphabets. We say σ is a *subsequence* of σ' , written $\sigma \preceq \sigma'$, if σ can be obtained by deleting symbols from σ' . The predicate $\sigma \prec \sigma'$ asserts that σ is isomorphic to a subsequence of σ' . If $\sigma \not\prec \sigma'$ we say σ' is σ -*free*. If P is a *set* of sequences, $P \not\prec \sigma'$ holds if $\sigma \not\prec \sigma'$ for *every* $\sigma \in P$. The assertion that σ *appears in* or *occurs in* or *is contained in* σ' means either $\sigma \prec \sigma'$ or $\sigma \preceq \sigma'$, which one being clear from context. The *projection* of a sequence σ onto $G \subseteq \Sigma(\sigma)$ is obtained by deleting all non- G symbols from σ . A sequence σ is k -*sparse* if whenever $\sigma(i) = \sigma(j)$ and $i \neq j$, then $|i - j| \geq k$. A *block* is a sequence of distinct symbols. If σ is understood to be partitioned into a sequence of blocks, $\llbracket \sigma \rrbracket$ is the number of blocks. The predicate $\llbracket \sigma \rrbracket = m$ asserts that σ can be partitioned into at most m blocks. The extremal functions for *generalized* Davenport-Schinzel sequences are defined to be

$$\begin{aligned} \text{Ex}(\sigma, n, m) &= \max\{|\sigma| : \sigma \not\prec S, \|\sigma\| = n, \text{ and } \llbracket S \rrbracket \leq m\} \\ \text{Ex}(\sigma, n) &= \max\{|\sigma| : \sigma \not\prec S, \|\sigma\| = n, \text{ and } S \text{ is } \|\sigma\|\text{-sparse}\} \end{aligned}$$

where σ may be a single sequence or a set of sequences. The conditions “ $\llbracket S \rrbracket \leq m$ ” and “ S is $\|\sigma\|$ -sparse” guarantee that the extremal functions are finite. For example, if $\|\sigma\| = 2$ the sparsity criterion forbids immediate repetitions and such infinite degenerate sequences as $aaaaa \dots$. Blocked sequences, on the other hand, have no sparsity criterion. The extremal functions for (standard) Davenport-Schinzel sequences are defined to be

$$\lambda_s(n, m) = \text{Ex}(\overbrace{ababa \dots}^{\text{length } s+2}, n, m) \quad \text{and} \quad \lambda_s(n) = \text{Ex}(\overbrace{ababa \dots}^{\text{length } s+2}, n)$$

Bounds on generalized Davenport-Schinzel sequences are expressed as a function of the inverse-Ackermann function α , yet there is no universally agreed-upon definition of Ackermann’s function

²To cite a fraction of the literature, DS sequences/lower envelopes are routinely applied to problems related to geometric arrangements [61, 13, 12, 31, 69, 29, 30, 19, 42, 44, 54, 40, 32, 55, 80, 3, 46], in kinetic data structures and dynamic geometric algorithms [6, 39, 47, 1, 5, 14, 43, 85], in visibility [25, 76, 62], motion planning [76, 58], and geometric containment problems [10, 76, 77, 15], as well as variations on classical problems such as computing shortest paths [17, 11, 18] and convex hulls [33, 16]. They have also been used in some industrial applications [45, 20]. Refer to Sharir and Agarwal [75] for a survey of DS sequences and their early applications in computational geometry and to Klazar [52] for a survey of DS sequences and related problems in extremal combinatorics.

or its inverse. All definitions in the literature differ by at most a constant, which usually obviates the need for more specificity. In this article we use the following definition of Ackermann's function.

$$\begin{aligned} a_{1,j} &= 2^j & j &\geq 1 \\ a_{i,1} &= 2 & i &\geq 2 \\ a_{i,j} &= w \cdot a_{i-1,w} & i, j &\geq 2 \\ & \text{where } w = a_{i,j-1} \end{aligned}$$

Note that in the table of $\{a_{i,j}\}$ values, the first column is constant ($a_{i,1} = 2$) and the second merely exponential ($a_{i,2} = 2^i$), so we have to look to the third column to find Ackermann-type growth. We define the double- and single-argument versions of the inverse-Ackermann function to be

$$\begin{aligned} \alpha(n, m) &= \min\{i \mid a_{i,j} \geq m, \text{ where } j = \max\{\lceil n/m \rceil, 3\}\} \\ \alpha(n) &= \alpha(n, n) \end{aligned}$$

We could have defined $\alpha(n, m)$ without direct reference to Ackermann's function. Note that $j = \log(a_{1,j})$. One may convince oneself that $j = \log^*(a_{2,j}) - O(1)$, $j = \log^{**}(a_{3,j}) - O(1)$, and in general, that $j = \log^{[i-1]}(a_{i,j}) - O(1)$, where $[i-1]$ is short for $i-1$ stars.³ Thus, up to $O(1)$ differences $\alpha(n, m)$ could be defined as $\min\{i \mid \log^{[i-1]}(m) \leq \max\{\lceil n/m \rceil, 3\}\}$. We state previous results in terms of the single argument version of α . However, they all generalize to the two-argument version by replacing $\lambda_s(n)$ with $\lambda_s(n, m)$ and $\alpha(n)$ with $\alpha(n, m)$.

1.2 A Brief History of λ_s

After introducing the problem in 1965, Davenport and Schinzel [27] proved that $\lambda_1(n) = n$, $\lambda_2(n) = 2n - 1$, $\lambda_3(n) = O(n \log n)$, and for all $s \geq 4$, that $\lambda_s(n) = n \cdot 2^{O(\sqrt{\log n})}$, where the leading constant in the exponent depends on s . Shortly thereafter Davenport [26] improved the bound on $\lambda_3(n)$ to $O(n \log n / \log \log n)$. In 1973 Szemerédi [79] dramatically improved the upper bounds for all $s \geq 3$, showing that $\lambda_s(n) = O(n \log^* n)$, where the leading constant depends on s .

From a purely numerical perspective Szemerédi's bound settled the problem for all values of n one might encounter in nature (the log-star function being at most 5 for n less than $10^{19,000}$), so why should any thoughtful mathematician continue to work on the problem? In our view, the problem of quantitatively estimating $\lambda_s(n)$ has always been a proxy for several qualitative questions: is $\lambda_s(n)$ linear or nonlinear? what is the structure of extremal sequences realizing $\lambda_s(n)$? and does it even matter what s is? In 1984 Hart and Sharir [41] answered the first two questions for order-3 DS sequences. They gave a bijection between order-3 (*ababa*-free) DS sequences and so-called generalized postorder path compression schemes. Although these schemes resembled the path compressions found in set-union data structures, Tarjan's analysis [82] did not imply any non-trivial upper or lower bounds on their length. Hart and Sharir proved that such path compression schemes have length $\Theta(n\alpha(n))$, thereby settling the asymptotics of $\lambda_3(n)$.

In 1989 Agarwal, Sharir, and Shor [4] (improving on [73, 74]) gave asymptotically tight bounds on order-4 DS sequences and reasonably tight bounds on higher order sequences.

³If $f : \mathbb{N} \setminus \{0\} \rightarrow \mathbb{N}$ is a decreasing function, $f^*(m)$ is, by definition, $\min\{\ell \mid f^{(\ell)}(m) \leq 1\}$, where $f^{(0)}(m) = m$ and $f^{(\ell)}(m) = f(f^{(\ell-1)}(m))$.

$$\begin{aligned}
\lambda_4(n) &= \Theta(n \cdot 2^{\alpha(n)}) \\
\lambda_s(n) &\begin{cases} > n \cdot 2^{(1+o(1))\alpha^t(n)/t!} \\ < n \cdot 2^{(1+o(1))\alpha^t(n)} \end{cases} && \text{for even } s \geq 6, t = \lfloor \frac{s-2}{2} \rfloor. \\
\lambda_s(n) &\begin{cases} > \lambda_{s-1}(n) \\ < n \cdot (\alpha(n))^{(1+o(1))\alpha^t(n)} \end{cases} && \text{for odd } s \geq 5, t = \lfloor \frac{s-2}{2} \rfloor.
\end{aligned}$$

For even s their bounds were tight up to the constant in the exponent: 1 for the upper bound and $1/t!$ for the lower bound. Moreover, their lower bound construction gave a qualitatively satisfying answer to the question of how extremal sequences are structured when s is even. For odd s the gap between upper and lower bounds was wider, the base of the exponent being 2 at the lower bound and $\alpha(n)$ at the upper bound.

Remark 1.1 *The results of Agarwal, Sharir, and Shor [4] force us to confront another question, namely, when is it safe to declare victory and call the problem closed? As Nivasch [63, §8] observed, the “ $+o(1)$ ” in the exponent necessarily hides a $\pm \Omega(\alpha^{t-1}(n))$ term if we express the bound in an “Ackermann-invariant” fashion, that is, in terms of the generic $\alpha(n)$, without specifying the precise variant of Ackermann’s function for which it is the inverse. Furthermore, under any of the definitions in the literature $\alpha(n)$ is an integer-valued function whereas $\lambda_s(n)/n$ must increase fairly smoothly with n , that is, an estimate of $\lambda_s(n)$ that is expressed as a function of any integer-valued $\alpha(n)$ must be off by at least a $2^{\Omega(\alpha^{t-1}(n))}$ factor. A reasonable definition of sharp bound (when dealing with generalized Davenport-Schinzel sequences) is an expression that cannot be improved, given $\pm \Theta(1)$ uncertainty in the definition of $\alpha(n)$. For example, $\lambda_4(n) = \Theta(n2^{\alpha(n)})$ is sharp in this sense since the constant hidden by Θ reflects this uncertainty. In contrast, $\lambda_3(n) = \Theta(n\alpha(n))$ is not sharp in an Ackermann-invariant sense. See the tighter bounds on $\lambda_3(n)$ cited below and in Theorem 1.2.*

In 2009 Nivasch [63] presented a superior method for upper bounding $\lambda_s(n)$. In addition, he provided a new construction of order-3 DS sequences that matched an earlier upper bound of Klazar [51] up to the leading constant.

$$\begin{aligned}
\lambda_s(n) &= \begin{cases} 2n\alpha(n) + O(n\sqrt{\alpha(n)}) & \text{for } s = 3; \text{ upper bound is due to [51].} \\ \Theta(n \cdot 2^{\alpha(n)}) & \text{for } s = 4. \\ n \cdot 2^{(1+o(1))\alpha^t(n)/t!} & \text{for even } s \geq 6, t = \lfloor \frac{s-2}{2} \rfloor. \end{cases} \\
\lambda_s(n) &\begin{cases} > \lambda_{s-1}(n) \\ < n \cdot (\alpha(n))^{(1+o(1))\alpha^t(n)/t!} \end{cases} && \text{for odd } s \geq 5, t = \lfloor \frac{s-2}{2} \rfloor. \tag{Niv}
\end{aligned}$$

This closed the problem for even $s \geq 6$ (the leading constant in the exponent being precisely $1/t!$) but left the odd case open. Alon, Kaplan, Nivasch, Sharir, and Smorodinsky [8, 63] conjectured that the upper bounds (Niv) for odd orders are tight, that is, the base of the exponent is, in fact, $\alpha(n)$. This conjecture was spurred by their discovery of similar functions that arose in an apparently unrelated combinatorial problem, *stabbing interval chains with j -tuples* [8].

1.3 New Results

We provide new upper and lower bounds on the length of Davenport-Schinzel sequences and in the process refute conjectures due to Alon et al. [8, §5], Nivasch [63, §8], and Pettie [68, §7].

Theorem 1.2 *Let $\lambda_s(n)$ be the maximum length of a repetition-free sequence over an n -letter alphabet avoiding subsequences isomorphic to $abab\cdots$ (length $s+2$), or, equivalently, the maximum complexity of the lower envelope of n continuous univariate functions, each pair of which coincide at most s times. For any $s \geq 1$, λ_s satisfies:*

$$\lambda_s(n) = \begin{cases} n & s = 1 \\ 2n - 1 & s = 2 \\ 2n\alpha(n) + O(n) & s = 3 \\ \Theta(n2^{\alpha(n)}) & s = 4 \\ \Theta(n\alpha(n)2^{\alpha(n)}) & s = 5 \\ n \cdot 2^{(1+o(1))\alpha^t(n)/t!} & \text{both even and odd } s \geq 6, t = \lfloor \frac{s-2}{2} \rfloor. \end{cases}$$

Theorem 1.2 is optimal in that it provides the tightest bounds that can be expressed in an Ackermann-invariant fashion (see Remark 1.1), and in this sense closes the Davenport-Schinzel problem.⁴ However, we believe our primary contributions are not the tight asymptotic bounds *per se* but the structural differences they reveal between even and odd s . We can now give a cogent explanation for *why* odd orders $s \geq 5$ behave essentially like the preceding even orders and yet why they are intrinsically more difficult to understand.

1.4 Generalizations of Davenport-Schinzel Sequences

The (Niv) bounds are actually corollaries of a more general theorem in [63] concerning the length of sequences avoiding *catenated permutations*,⁵ which were introduced by Klazar [50]. Define $\text{Perm}(r, s+1)$ to be the set of all sequences obtained by concatenating $s+1$ permutations over an r -letter alphabet. For example, $abcd\ cbad\ badc\ abcd\ dcba \in \text{Perm}(4, 5)$. Define the extremal function of $\text{Perm}(r, s+1)$ -free sequences to be

$$\Lambda_{r,s}(n) = \text{Ex}(\text{Perm}(r, s+1), n)$$

The “ $s+1$ ” here is chosen to highlight the parallels with order- s DS sequences. Every $\sigma \in \text{Perm}(2, s+1)$ contains an alternating sequence $abab\cdots$ with length $s+2$,⁶ so order- s DS sequences are also $\text{Perm}(2, s+1)$ -free, implying that $\lambda_s(n) \leq \Lambda_{2,s}(n)$. Nivasch [63] proved that $\Lambda_{r,s}(n)$ obeys all the *upper bounds* of (Niv), as well as its lower bounds when $s \geq 4$ is even or $s \leq 3$.

There are other natural ways to generalize standard Davenport-Schinzel sequences. *Doubled* Davenport-Schinzel sequences were studied in [28, 2, 53, 68]. Define $\lambda_s^{\text{dbl}}(n)$ to be the extremal function of $\text{dbl}(abab\cdots)$ -free sequences, where the alternating sequence has length $s+2$ and $\text{dbl}(\sigma)$

⁴The exponent $(1+o(1))\alpha^t(n)/t!$ is the Ackermann-invariant expression $\alpha^t(n)/t! + O(\alpha^{t-1}(n))$.

⁵Nivasch called these formation-free sequences.

⁶The first permutation contributes two symbols and every subsequent permutation contributes at least one.

is obtained by doubling every symbol in σ save the first and last. For example, $\text{dbl}(abab) = abbaab$.⁷ Davenport and Schinzel [28] noted that $\lambda_1^{\text{dbl}}(n) = O(\lambda_1(n)) = O(n)$ (see [52]) and Adamec, Klazar, and Valtr [2] proved that $\lambda_2^{\text{dbl}}(n) = O(\lambda_2(n)) = O(n)$. Pettie proved that $\lambda_3^{\text{dbl}}(n) = O(n\alpha^2(n))$ and that $\lambda_s^{\text{dbl}}(n)$ obeys all the upper bounds of (Niv) for $s \geq 4$.

If one views alternating sequences as forming a zigzagging pattern, an obvious generalization is to extend the length of each zig and zag to include a larger alphabet. For example, the N -shaped sequences $N_k = 12 \cdots k(k+1) \cdots 212 \cdots k(k+1)$ generalize $abab = N_1$ and the M -shaped sequences $M_k = 12 \cdots k(k+1)k \cdots 212 \cdots k(k+1)k \cdots 21$ generalize $ababa = M_1$. Klazar and Valtr [53, 69] proved that $\text{Ex}(\text{dbl}(N_k), n) = O(\lambda_2(n)) = O(n)$ and Pettie [69] proved that $\text{Ex}(\{M_k, ababab\}, n) = O(\lambda_3(n))$. Sequences avoiding N - and M -shaped sequences have proved very useful in bounding the complexity of geometric graphs [84, 78, 34, 69].

In a companion paper to be published separately we provide new upper and lower bounds on doubled DS sequences, M_k -free sequences, and $\text{Perm}(r, s+1)$ -free sequences. The strangest of these results is that $\Lambda_{r,s}$ is very sensitive to the alphabet size r , but only when s is odd and at least 5. In particular $\Lambda_{2,s}(n) = \Theta(\lambda_s^{\text{dbl}}(n)) = \Theta(\lambda_s(n))$ but this is not true for general $r \neq 2$.

Theorem 1.3 *The following bounds hold for all $r \geq 2, s \geq 1$, where $t = \lfloor \frac{s-2}{2} \rfloor$.*

$$\Lambda_{r,s}(n) = \begin{cases} \Theta(n) & \text{for } s \in \{1, 2\} \text{ and all } r \geq 2 \\ \Theta(n\alpha(n)) & \text{for } s = 3 \text{ and all } r \geq 2 \\ \Theta(n2^{\alpha(n)}) & \text{for } s = 4 \text{ and all } r \geq 2 \\ \Theta(n\alpha(n)2^{\alpha(n)}) & \text{for } s = 5 \text{ and } r = 2 \\ n \cdot (\alpha(n))^{(1+o(1))\alpha(n)} & \text{for } s = 5 \text{ and all } r \geq 3 \\ n \cdot 2^{(1+o(1))\alpha^t(n)/t!} & \text{for even } s \geq 6 \text{ and all } r \geq 2 \\ n \cdot 2^{(1+o(1))\alpha^t(n)/t!} & \text{for odd } s \geq 7 \text{ and } r = 2 \\ n \cdot (\alpha(n))^{(1+o(1))\alpha^t(n)/t!} & \text{for odd } s \geq 7 \text{ and all } r \geq 3 \end{cases}$$

Theorem 1.3 is rather surprising, even given Theorem 1.2 and even in retrospect. One consequence of Theorem 1.3 is that Cibulka and Kynčl's [24, 71] upper bounds on the size of sets of permutations with fixed VC-dimension are tight.

1.5 Organization.

In Section 2 we present an informal discussion of the method of Agarwal, Sharir, and Shor [4] and Nivasch [63], its limitations for dealing with odd-order DS sequences, and the key ideas behind the proof of Theorem 1.2. Section 3 reviews Nivasch's recurrence for λ_s as well as some basic upper bounds on λ_s . The critical structure in our analysis is the *derivation tree* of a DS sequence. Its properties are analyzed in Section 4. In Section 5 we use the derivation tree to obtain a new recurrence for odd-order DS sequences. The recurrences for even- and odd-order DS sequences are solved in Section 5.1. In Section 5.2 we complete the proof of the upper bounds of Theorem 1.2 for all orders except $s = 5$. In Sections 6 and 7 we establish Theorem 1.2's lower bounds and upper

⁷Why not consider higher multiplicities? It is fairly easy to show that repeating symbols more than twice, or repeating the first and last at all, affects the extremal function by at most a constant factor. See Adamec, Klazar, and Valtr [2].

bounds on order-5 DS sequences. We discuss several open problems in Section 8. Some proofs appear in Appendices A–C.

2 A Tour of the Proof

The proof of Theorem 1.2 diverges sharply from previous analyses [73, 4, 63] in that it treats even and odd orders as fundamentally different beasts. To understand why all orders cannot be analyzed in a uniform fashion we must review the method of Agarwal, Sharir, and Shor [4] and Nivasch [63].

The basic inductive hypothesis of [63] is that there are values $\{\mu_{s,i}\}$, increasing in both s and i , for which $\lambda_s(n, m) < \mu_{s,i} \left(n + m \text{poly}(\log^{[i-1]}(m)) \right)$, for any choice of i .⁸ In other words, the multiplicity of symbols is at most $\mu_{s,i}$, up to an additive term that depends on the block count m , which may be the dominant term if i is too small. One would, ultimately, choose i to make $m \text{poly}(\log^{[i-1]}(m)) = O(n)$ (and $\alpha(n, m)$ is a good choice) but for the sake of simplifying the discussion we ignore the dependence on m . Given a sequence S with parameters s, n, m , to *invoke the inductive hypothesis with parameter i* means to upper bound $|S|$ by $\mu_{s,i}n$, with the understanding that i is not chosen to be too small.

Suppose S is an order- s , m -block DS sequence over an n -letter alphabet. The analysis of [4, 63] begins by partitioning S into \hat{m} intervals of consecutive blocks, \hat{m} typically being much smaller than m . Write S as $S_1 \cdots S_{\hat{m}}$. We can put symbols into two categories: *local* symbols are those that appear exclusively in one interval S_q and *global* symbols are those that appear in multiple intervals. Let $\check{S} = \check{S}_1 \cdots \check{S}_{\hat{m}}$ be the subsequence of S consisting of local symbols and $\hat{S} = \hat{S}_1 \cdots \hat{S}_{\hat{m}}$ the subsequence of S consisting of global symbols, so $|S| = |\check{S}| + |\hat{S}|$. On each \check{S}_q (for $1 \leq q \leq \hat{m}$) we invoke the inductive hypothesis with parameter i and deduce that $|\check{S}| \leq \mu_{s,i} \|\check{S}\|$. What remains is to bound the length of \hat{S} .

The next step is to form a *contracted* sequence from \hat{S} that has a much higher alphabet-to-block count ratio, thereby allowing us to invoke the inductive hypothesis with a smaller ‘ i ’ parameter. Let \hat{S}' be obtained from \hat{S} by replacing each interval \hat{S}_q with a *single* block β_q containing the first occurrence of each distinct symbol in \hat{S}_q . Thus, the alphabet of \hat{S}' is the same as \hat{S} but it consists of just \hat{m} blocks $\beta_1 \beta_2 \cdots \beta_{\hat{m}}$. On \hat{S}' we invoke the inductive hypothesis with parameter $i - 1$ and conclude that $|\hat{S}'| \leq \mu_{s,i-1} \|\hat{S}'\|$. One cannot immediately deduce any bound on \hat{S} from a bound on \hat{S}' since each interval \hat{S}_q could contain *numerous* copies of a symbol, only one of which is retained in β_q .

Imagine reversing the contraction operation. We replace each block β_q with a sequence \hat{S}_q , thereby reconstructing \hat{S} . To bound the length of \hat{S}_q in terms of $|\beta_q| = \|\hat{S}_q\|$ we will invoke the inductive hypothesis three more times. Put the symbols of β_q in three categories: those that make their first appearance (in \hat{S}') in β_q , those that make their last appearance in β_q , and those that make a middle (non-first, non-last) appearance in β_q . Discard from \hat{S}_q all symbols not classified as first in β_q and call the resulting sequence \acute{S}_q . Every symbol in \acute{S}_q appears at least once after \hat{S}_q (by virtue of being categorized as first in β_q), which implies that $\hat{S} = \acute{S}_1 \cdots \acute{S}_{\hat{m}}$ is an order- $(s - 1)$ DS sequence. See the diagram below.

⁸Recall that $\log^{[i-1]}(m)$ is the $\log^{\star \cdots \star}(m)$ function, with $i - 1$ \star s.

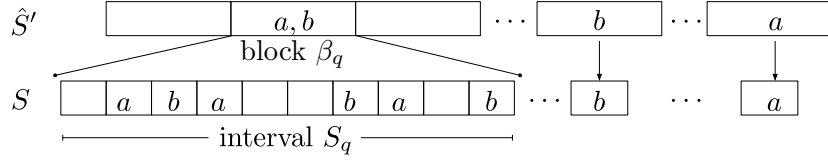

An occurrence of $\sigma_{s+1} = abab \dots$ (length $s+1$) in \hat{S}_q , together with an a or b following \hat{S}_q (depending on whether σ_{s+1} ends in b or a) gives an occurrence of σ_{s+2} in \hat{S} , contradicting the fact that it has order s . The same argument applies in a symmetric fashion to the subsequence of \hat{S}_q formed by symbols making their last appearance in β_q , call it \check{S}_q . By invoking the inductive hypothesis with parameter i on $\hat{S}_1 \dots \hat{S}_{\hat{m}}$ and $\check{S}_1 \dots \check{S}_{\hat{m}}$ we can conclude the contribution of first and last symbols to S is $2\mu_{s-1,i} \|\hat{S}\|$.

The length of the subsequence of middle symbols in \hat{S}_q , call it \bar{S}_q , is bounded with the same argument, except now there are, by definition of *middle*, occurrences of both $a, b \in \Sigma(\bar{S}_q)$ both before and after \hat{S}_q . That is, if $\sigma_s = baba \dots$ (length s) appeared in \bar{S}_q then, together with an a preceding \hat{S}_q and either an a or b following \hat{S}_q (depending on whether σ_s ends in b or a) there would be an occurrence of σ_{s+2} in \hat{S} , contradicting the fact that it has order s . We invoke the inductive hypothesis one last time, with parameter i , on each $\bar{S}_1, \dots, \bar{S}_{\hat{m}}$, which implies that $|\bar{S}_q| \leq \mu_{s-2,i} \|\bar{S}_q\|$.

Recall that each symbol in \hat{S}' appeared $\mu_{s,i-1}$ times, $\mu_{s,i-1} - 2$ times in blocks where it was categorized as middle. Thus, the contribution of middle symbols to $|\hat{S}'|$ is $\mu_{s-2,i}(\mu_{s,i-1} - 2)$. In order for every symbol, local and global alike, to appear in S with multiplicity at most $\mu_{s,i}$, we must have

$$\mu_{s,i} \geq 2\mu_{s-1,i} + \mu_{s-2,i}(\mu_{s,i-1} - 2) \quad (1)$$

When $s = 3$ we do not need to use an inductive hypothesis to determine $\mu_{1,i}$ and $\mu_{2,i}$. They are just 1 and 2; the i parameter does not come into play.⁹ This leads to a bound of $\mu_{3,i} = 2i + O(1)$.¹⁰ Although the contribution of first and last symbols is significant at $s = 3$, entertain the idea that their contribution becomes negligible at higher orders, so we can further simplify (1) as follows

$$\mu_{s,i} \geq \mu_{s-2,i} \mu_{s,i-1} \quad (2)$$

Inequality (2) is satisfied when $\mu_{s,i} = g^{\binom{i+t}{t}}$ for any base g ; recall that $t = \lfloor \frac{s-2}{2} \rfloor$ by definition. By Pascal's identity $g^{\binom{i+t}{t}} = g^{\binom{i+(t-1)}{t-1}} \cdot g^{\binom{i-1}{t} + t}$. The correct base depends on where the inductively defined inequality (2) bottoms out: at order 2 when $s \geq 4$ is even and at order 3 when $s \geq 5$ is odd. When s is even the correct base is $2 = \mu_{2,i}$. When s is odd the calculations are less clean since $\mu_{3,i} = 2i + O(1)$ is not constant but depends on i . Nonetheless, the correct base is on the order of i , that is, $\mu_{s,i} = \Theta(i)^{\binom{i+t}{t}}$ satisfies (2) at the odd orders. Plugging in $\alpha(n, m)$ for i ultimately leads to Nivasch's bounds (Niv), since $\binom{i+t}{t} = i^t/t! + O(i^{t-1}) = (1 + o(1))i^t/t!$.

To obtain a construction of order- s sequences realizing the (Niv) bounds one should start by attempting to *reverse-engineer* the argument above. To form an order- s sequence S with certain alphabet and block parameters, start by generating (inductively) local order- s sequences $\check{S}_1 \dots \check{S}_{\hat{m}}$

⁹It is easy to show that $\lambda_1(n, m) < \underline{1} \cdot n + m$ and $\lambda_2(n, m) < \underline{2} \cdot n + m$. See Lemma 3.2.

¹⁰We have not said what to do in the base case when $i = 1$, which determines the $O(1)$ term.

over disjoint alphabets, and a single global order- s sequence \hat{S}' having \hat{m} blocks. Take some block β_q in \hat{S}' and suppose for the sake of simplicity that β_q consists solely of middle symbols. We need to substitute for β_q an order- $(s-2)$ DS sequence \bar{S}_q and then somehow merge it with \check{S}_q , in a way that does not introduce into S an alternating sequence with length $s+2$. This is the point at which the even and odd orders diverge.

If s is even the longest alternating sequence $baba \cdots b$ in \bar{S}_q has length $s-1$ and therefore begins and ends with b . We can only afford to introduce one alternation at each boundary of \bar{S}_q , so the pattern of a s and b s on either side of β_q must look like $a^* b^* \beta_q b^* a^*$, as in the diagram below. We will call a and b *nested in β_q* if the sequence contains $a b \beta_q b a$ or the equivalent $b a \beta_q a b$. See the diagram below.

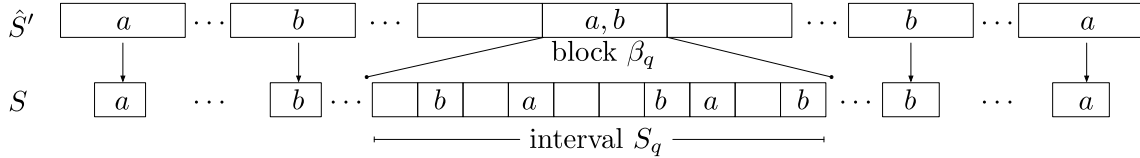

On the other hand, if s is odd then the longest alternating sequence $baba \cdots a$ in \bar{S}_q has length $s-1$, begins with b and ends with a , so the pattern of a s and b s in \hat{S}' looks like $a^* b^* \beta_q a^* b^*$. A pair of middle symbols that are not nested in β_q are called *interleaved in β_q* .

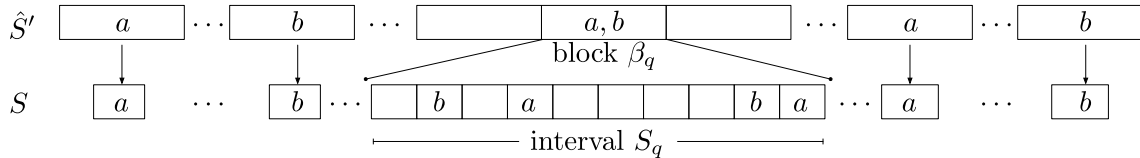

If the (Niv) bounds prove to be tight, there must be two systems for generating sequences: one where nesting is the norm, when s is even, and one where interleaving is the norm, when s is odd. If interleaving were somehow outlawed then to avoid creating an alternating sequence with length $s+2$, the sequence \bar{S}_q substituted for β_q would have to be an order- $(s-3)$ DS sequence rather than an order- $(s-2)$ one. However, it is clearly impossible to claim that interleaving simply cannot exist.

What makes the argument of [4, 63] brilliantly simple is how little it leaves to direct calculation. The length of every sequence ($\check{S}_q, \hat{S}', \check{S}_q, \bar{S}_q$, etc.) is bounded by delegation to an inductive hypothesis. However, such useful notions as *nearly all middle symbols in a block are mutually nested* are difficult to capture in a strengthened inductive hypothesis. We need to understand and characterize the phenomenon of nestedness to improve on [4, 63]. This requires a deeper understanding of the structure of Davenport-Schinzel sequences.

The Derivation Tree. Inductively defined objects can be apprehended inductively or, alternatively, apprehended holistically by completely “unrolling” the induction. From the first perspective S is the merger of \check{S} and \hat{S} , which is derived from \hat{S}' , all of which are analyzed inductively. By iteratively unrolling the decomposition of \check{S} and \hat{S}' we obtain a *derivation tree* \mathcal{T} whose nodes represent *every* block in *every* sequence encountered in the recursive decomposition of S . Whereas S occupies the leaves of \mathcal{T} , derived sequences such as \hat{S}' occupy levels higher in \mathcal{T} . Whereas S (and every sequence) is a static object, \mathcal{T} can be thought of a *process* for generating S whose history can be reasoned about explicitly. But how does \mathcal{T} let us deduce something about the nestedness

and non-nestedness of symbols in a common block?

Suppose we are interested in the nestedness of middle symbols a, b in block β , which corresponds to a leaf-node in \mathcal{T} . Imagine taking \mathcal{T} and deleting every node whose block does not contain b , that is, *projecting* \mathcal{T} onto the symbol b . What remains, $\mathcal{T}|_b$, is a tree rooted at the location in \mathcal{T} where b is “born” and represents how occurrences of b have proliferated during the process that culminates in the construction of S . The block/node β occupies a location in $\mathcal{T}|_b$ and a location in $\mathcal{T}|_a$, whose node sets are only guaranteed to intersect at β . Some locations in $\mathcal{T}|_a$ and $\mathcal{T}|_b$ are intrinsically bad—these are called *feathers* in Section 4. (Whether a node is a feather in $\mathcal{T}|_a$ depends solely on the structure of $\mathcal{T}|_a$, not how it is embedded in \mathcal{T} nor its relationship to a different $\mathcal{T}|_b$.) We show that if β is not a feather in $\mathcal{T}|_a$ and not a feather in $\mathcal{T}|_b$, then a and b are nested in β . In other words, the middle symbols in β are partitioned into two equivalence classes, depending on whether or not they appear at feathers in their respective derivation trees. We could not outlaw interleavedness in general, yet we managed to outlaw it *within* one equivalence class! The question is, what are the relative sizes of these two equivalence classes, and in particular, how many feathers can a $\mathcal{T}|_b$ have?

Our aim is to get stronger asymptotic bounds on λ_s for odd s , which means the number of feathers should be a negligible ($o(1)$ fraction) of the size of $\mathcal{T}|_b$. In the same way that the multiplicities $\mu_{s,i}$ are bounded inductively, as in (1) for example, we are able to bound the number of feathers in $\mathcal{T}|_b$ inductively, call it $\nu_{s,i}$, in terms of $\nu_{s,i-1}$ and $\mu_{s-1,i}$. However, now $\mu_{s,i}$ is bounded in terms of $\mu_{s,i-1}$ (the multiplicity of symbols in the contracted sequence \hat{S}'), $\mu_{s-1,i}$ (the multiplicity of symbols in \hat{S} begat by first and last occurrences in \hat{S}'), $\mu_{s-3,i}$ (the multiplicity of middle occurrences in \hat{S} begat by non-feathers in \hat{S}'), and both $\nu_{s,i-1}$ and $\mu_{s-2,i}$, which count the number of feathers in \hat{S}' and the multiplicity of middle occurrences in \hat{S} begat by feathers in \hat{S}' . This leads to a system of three interconnected recurrences: one for $\mu_{s,i}$ at odd s , one for $\mu_{s,i}$ at even s , and one for the feather count $\nu_{s,i}$. An elementary (though necessarily detailed) proof by induction gives solutions for $\mu_{s,i}$ and $\nu_{s,i}$ that ultimately lead to the upper bounds of Theorem 1.2, with one exception. At order $s = 5$ this method only gives us an $O(n\alpha^2(n)2^{\alpha(n)})$ upper bound on $\lambda_5(n)$. To obtain a sharp $O(n\alpha(n)2^{\alpha(n)})$ bound we are forced to analyze not just one derivation tree \mathcal{T} (of an order-5 DS sequence) but a system of derivation trees of order-4 DS sequences associated with all the sequences \hat{S} and \hat{S}' (of global first and last occurrences) encountered in the construction of \mathcal{T} .

3 Basic Upper Bounds

In Section 3.1 we review and expand on the notation introduced informally in Section 2. It will be used repeatedly throughout Sections 4–7.

3.1 Sequence Decomposition

Let S be a sequence over an $n = \|S\|$ letter alphabet consisting of $m = \llbracket S \rrbracket$ blocks. Suppose we partition S into \hat{m} intervals of consecutive blocks $S_1 S_2 \cdots S_{\hat{m}}$, where $m_q = \llbracket S_q \rrbracket$ is the number of blocks in interval q . Let $\check{\Sigma}_q$ be the alphabet of symbols *local* to S_q (that do not appear in any S_p , $p \neq q$) and let $\hat{\Sigma} = \Sigma(S) \setminus \bigcup_q \check{\Sigma}_q$ be the alphabet of all other *global* symbols. The cardinalities of $\check{\Sigma}_q$ and $\hat{\Sigma}$ are \check{n}_q and \hat{n} , thus $n = \hat{n} + \sum_{q=1}^{\hat{m}} \check{n}_q$. A global symbol in S_q is called *first*, *last*, or *middle* if it appears in no earlier interval, no later interval, or appears in both earlier and later intervals,

respectively. Let $\check{\Sigma}_q, \hat{\Sigma}_q, \bar{\Sigma}_q, \tilde{\Sigma}_q$ be the subset of $\Sigma(S_q)$ consisting of, respectively, first, last, middle, and all global symbols, and let $\check{n}_q, \hat{n}_q, \bar{n}_q,$ and \tilde{n}_q be their cardinalities. Let $\check{S}_q, \hat{S}_q, \acute{S}_q, \grave{S}_q, \bar{S}_q$ be the projection of S_q onto $\check{\Sigma}_q, \hat{\Sigma}_q, \acute{\Sigma}_q, \grave{\Sigma}_q,$ and $\bar{\Sigma}_q$. Note that \hat{S}_1 consists solely of first occurrences; if the last occurrence of a symbol appeared in \hat{S}_1 the symbol would be classified as local to S_1 , not global. The same argument shows that $\check{S}_{\hat{m}}$ consists solely of last occurrences. Let $\check{S}, \hat{S}, \acute{S}, \grave{S},$ and \bar{S} be the subsequences of local, global, first, last, and middle occurrences, respectively, that is, $\check{S} = \check{S}_1 \cdots \check{S}_{\hat{m}}, \hat{S} = \hat{S}_1 \cdots \hat{S}_{\hat{m}}, \acute{S} = \acute{S}_1 \cdots \acute{S}_{\hat{m}-1}, \grave{S} = \grave{S}_2 \cdots \grave{S}_{\hat{m}},$ and $\bar{S} = \bar{S}_2 \cdots \bar{S}_{\hat{m}-1},$ the last of which would be empty if $\hat{m} = 2$. Let $\hat{S}' = \beta_1 \cdots \beta_{\hat{m}}$ be an \hat{m} -block sequence obtained from \hat{S} by replacing each \hat{S}_q with a single block β_q containing its alphabet $\hat{\Sigma}_q,$ listed in order of *first* appearance in \hat{S}_q .

3.2 2-Sparse vs. Blocked Sequences

Every analysis of Davenport-Schinzel sequences since [41] uses Lemma 3.1(2) to reduce the problem of bounding 2-sparse DS sequences to bounding m -block DS sequences, that is, expressing $\lambda_s(n)$ in terms of $\lambda_s(n, m),$ where $m = O(n).$

Lemma 3.1 *Let $\gamma_s(n) : \mathbb{N} \rightarrow \mathbb{N}$ be a non-decreasing function such that $\lambda_s(n) \leq \gamma_s(n) \cdot n.$*

1. (Trivial) For $s \geq 1,$ $\lambda_s(n, m) \leq m - 1 + \lambda_s(n).$
2. (Sharir [73]) For $s \geq 3,$ $\lambda_s(n) \leq \gamma_{s-2}(n) \cdot \lambda_s(n, 2n - 1).$ (This generalizes Hart and Sharir's proof [41] for $s = 3.$)
3. (Sharir [73]) For $s \geq 2,$ $\lambda_s(n) \leq \gamma_{s-1}(n) \cdot \lambda_s(n, n).$
4. (New) For $s \geq 3,$ $\lambda_s(n) = \gamma_{s-2}(\gamma_s(n)) \cdot \lambda_s(n, 3n - 1).$

Lemma 3.1(4) is obtained by synthesizing ideas from Sharir [73] and Füredi and Hajnal [36]. Refer to Appendix A for the proof of Lemma 3.1.

3.3 Orders 1 and 2

In the interest of completeness we shall reestablish the known bounds on order-1 and order-2 DS sequences, in both their 2-sparse and blocked forms.

Lemma 3.2 (Davenport and Schinzel [27]) *The extremal functions for order-1 and order-2 DS sequences are*

$$\begin{aligned} \lambda_1(n) &= n \\ \lambda_2(n) &= 2n - 1 \\ \lambda_1(n, m) &= n + m - 1 \\ \lambda_2(n, m) &= 2n + m - 2 \end{aligned} \quad \text{for } m \geq 2$$

Proof: Let S be a 2-sparse sequence with $n = \|S\|.$ If $|S| > n$ then there are two copies of some symbol, say $a.$ The a s cannot be adjacent, due to 2-sparseness, so S must contain a subsequence $aba,$ for some $b \neq a.$ Such an S is not an order-1 DS sequence, hence $\lambda_1(n) \leq n.$

If S has order 2 then some symbol must appear exactly once. To see this, consider the closest pair of occurrences of some symbol, say $a.$ If every symbol b appearing between this pair of a s

occurred twice in S then S would contain $baba$, $abab$, or $abba$. The first two are precluded since S has order 2 and the third violates the fact that the two as are the *closest* such pair. Thus, every symbol b between the two as occurs once. Remove one such b ; if this causes the two as to become adjacent, remove one of the as . What remains is a 2-sparse sequence over an $(n-1)$ -letter alphabet, so $\lambda_2(n) \leq \lambda_2(n-1) + 2$. Since $\lambda_2(1) = 1$ we have $\lambda_2(n) \leq 2n - 1$.

Lemma 3.1(1) and the bounds established above imply $\lambda_1(n, m) \leq n + m - 1$ and $\lambda_2(n, m) \leq 2n + m - 2$. All these upper bounds are tight. The unique extremal order-1, 2-sparse DS sequence is $123 \cdots n$, which can be converted into an extremal m -block sequence $[123 \cdots n][n]^{m-1}$. Brackets mark block boundaries. There are exponentially many extremal DS sequences of order 2, each corresponding to an Euler tour around a rooted tree with vertex labels from $\{1, \dots, n\}$. For example, $123 \cdots (n-1)n(n-1) \cdots 321$ and $1213141 \cdots 1(n-1)1n1$ are extremal 2-sparse, order-2 DS sequences. The first corresponds to an Euler tour around a path, the second an Euler tour around a star. The first sequence can be converted into an extremal m -block, order-2 DS sequence $[12 \cdots (n-1)n][n(n-1) \cdots 21][1]^{m-2}$, assuming that $m \geq 2$. When there is only 1 block we have $\lambda_s(n, 1) = n$, regardless of the order s . \square

3.4 Nivasch's Recurrence

Nivasch's [63] upper bounds (Niv) are a consequence of a recurrence for λ_s that is stronger than one of Agarwal, Sharir, and Shor [4]. Here we present a streamlined version of Nivasch's recurrence.

Recurrence 3.3 *Let m, n , and $s \geq 3$ be the block count, alphabet size, and order parameters. For any $\hat{n} < m$, any block partition $\{m_q\}_{1 \leq q \leq \hat{m}}$, and any alphabet partition $\{\hat{n}\} \cup \{\check{n}_q\}_{1 \leq q \leq \hat{m}}$, where $m = \sum_q m_q$ and $n = \hat{n} + \sum_q \check{n}_q$, we have*

$$\lambda_s(n, m) \leq \sum_{q=1}^{\hat{m}} \lambda_s(\check{n}_q, m_q) + 2 \cdot \lambda_{s-1}(\hat{n}, m) + \lambda_{s-2}(\lambda_s(\hat{n}, \hat{m}) - 2\hat{n}, m)$$

Proof: We adopt the notation and definitions from Section 3.1, where S is an extremal order- s DS sequence with $\|S\| = n$ and $\llbracket S \rrbracket = m$. We shall bound $|S|$ by considering its four constituent subsequences $\check{S}, \acute{S}, \hat{S}$, and \bar{S} .

Each \check{S}_q is an order- s DS sequence, therefore the contribution of local symbols is $|\check{S}| \leq \sum_{q=1}^{\hat{m}} \lambda_s(\check{n}_q, m_q)$. We claim each \acute{S}_q is an order- $(s-1)$ DS sequence. By virtue of being categorized as *first* in \check{S}_q , every symbol in \acute{S}_q appears at least once after \check{S}_q . Therefore an occurrence of an alternating sequence $\sigma_{s+1} = abab \cdots$ (length $s+1$), in \acute{S}_q would imply an occurrence of σ_{s+2} in S , a contradiction. By symmetry it also follows that \grave{S}_q is an order- $(s-1)$ DS sequence, hence $|\acute{S}| = \sum_{q=1}^{\hat{m}-1} \lambda_{s-1}(\acute{n}_q, m_q)$ and $|\grave{S}| = \sum_{q=2}^{\hat{m}} \lambda_{s-1}(\grave{n}_q, m_q)$. Since λ_s is clearly superadditive¹¹ we can bound these sums by $\lambda_{s-1}(\hat{n}, m - m_{\hat{m}})$ and $\lambda_{s-1}(\hat{n}, m - m_1)$. (Note that $\sum_q \acute{n}_q = \hat{n}$ and $\sum_q \grave{n}_q = \hat{n}$ as each sum counts each global symbol exactly once.) The contribution of first and last symbols is therefore upper bounded by $2 \cdot \lambda_{s-1}(\hat{n}, m)$.

The same argument shows that \bar{S}_q is an order- $(s-2)$ DS sequence. Symbols in \bar{S}_q were categorized as *middle*, so an alternating subsequence $\sigma_s = baba \cdots$ (length s) in \bar{S}_q , together with an a preceding \bar{S}_q and either an a or b following \bar{S}_q (depending on whether s is even or odd), yields an

¹¹It is straightforward to show that $\lambda_s(n', m') + \lambda_s(n'', m'') \leq \lambda_s(n' + n'', m' + m'' - 1)$, for all n', n'', m', m'' .

instance of σ_{s+2} in S , a contradiction. Thus the contribution of middle symbols is

$$\begin{aligned}
|\bar{S}| &\leq \sum_{q=2}^{\hat{m}-1} \lambda_{s-2}(\bar{n}_q, m_q) \\
&\leq \lambda_{s-2} \left(\sum_{q=2}^{\hat{m}-1} \bar{n}_q, m - m_1 - m_{\hat{m}} \right) && \{\text{superadditivity of } \lambda_{s-2}\} \\
&\leq \lambda_{s-2}(|\hat{S}'| - 2\hat{n}, m - m_1 - m_{\hat{m}}) && (3) \\
&\leq \lambda_{s-2}(\lambda_s(\hat{n}, \hat{m}) - 2\hat{n}, m) && (4)
\end{aligned}$$

Inequality (3) follows from the fact that $\sum_q \bar{n}_q$ counts the length of \hat{S}' , save the first and last occurrence of each global symbol, that is, $2\hat{n}$ occurrences in total. Since \hat{S}' is a subsequence of S , it too is an order- s DS sequence, so $|\hat{S}'| \leq \lambda_s(\hat{n}, \hat{m})$. Inequality (4) follows.

□

Recurrence 3.3 offers us the freedom to choose the block partition $\{m_q\}_{1 \leq q \leq \hat{m}}$ but it does not suggest what the optimal partition might look like. One natural starting place [41, 4, 63] is to always choose $\hat{m} = 2$, partitioning the sequence into 2 intervals each containing $m/2$ blocks. This choice leads to $O(n + m \log^{s-2} m)$ upper bounds on $\lambda_s(n, m)$, which is $O(n + m)$ if the alphabet/block density $n/m = \Omega(\log^{s-2} m)$. Call this Analysis (1). Given Analysis (1) we can conduct a stronger Analysis (2) by selecting $\hat{m} = m / \log^{s-2} m$, so each interval contains $\log^{s-2} m$ blocks. The $\lambda_s(\hat{n}, \hat{m})$ term is bounded via Analysis (1) (that is, $\lambda_s(\hat{n}, \hat{m}) = O(\hat{n} + \hat{m} \log^{s-2} \hat{m}) = O(\hat{n} + m)$) and the remaining terms bounded inductively via analysis Analysis (2). This leads to bounds of the form $\lambda_s(n, m) = O(n + m \text{poly}(\log^* m))$. By iterating this process, Analysis (i) gives bounds of the form $O(n + m \text{poly}(\log^{[i-1]} m))$.¹² We cannot conclude that $\lambda_s(n, m) = O(n + m)$ since the constant hidden by the asymptotic notation, call it $\mu_{s,i}$, increases with i and s .

The discussion above is merely meant to foreshadow the analysis of Recurrence 3.3 and subsequent Recurrences 5.1, 5.2, 7.6, and 7.7; see Appendices B and C. We have made every attempt to segregate recurrences and structural arguments from their quantitative analyses, which are important but nonetheless rote. As a consequence, Ackermann's function, its various inverses, and quantities such as $\{\mu_{s,i}\}$ will be introduced as late as possible.

3.5 The Evolution of Recurrence 3.3

The statement of Recurrence 3.3 is simple, and arguably cannot be made simpler. We feel it is worthwhile to recount how it was assembled over the years in the works of [41, 73, 4, 51, 63].

When s is fixed the function $\lambda_s(n)$ depends only on one parameter, n , a situation that would not ordinarily lead to expressions involving “ α ”, which is most naturally expressed as a function of two independent parameters.¹³ Hart and Sharir's [41] insight was to recognize an additional parameter m (the block count) and obtain bounds on $\lambda_s(n)$ via bounds on $\lambda_s(n, m)$. See Lemma 3.1.

Implicit in Hart and Sharir's analysis is a classification of symbols into local and global, and of global occurrences into first, middle, and last.¹⁴ Agarwal, Sharir, and Shor [4] made this lo-

¹²(the $[i-1]$ here being short for $i-1$ \star s)

¹³In graph algorithms these parameters typically correspond to nodes and edges [83, 57, 22], in matrix problems [49, 48] to rows and columns, and in data structures they may correspond to elements and queries [82, 37], query time and preprocessing time [64], or input size and storage space [87, 7, 23].

¹⁴This part of their analysis is ostensibly about nodes and path compressions, not blocks and symbols.

cal/global and first/middle/last classification explicit, and arrived at a recurrence very close to Recurrence 3.3.¹⁵ However, they did not bound the contribution of global middle occurrences in the same way. Whereas \bar{S}_q is an m_q -block sequence, it can be converted to 2-sparse one by removing up to $m_q - 1$ repeated symbols at block boundaries. By Lemma 3.1(1,2)

$$|\bar{S}_q| < m_q + \lambda_{s-2}(\bar{n}_q) \leq m_q + \gamma_{s-2}(\bar{n}_q) \cdot \bar{n}_q \leq m_q + \gamma_{s-2}(n) \cdot \bar{n}_q$$

In other words, when “contracting” \bar{S} to form \bar{S}' , the shrinkage factor is at most $\gamma_{s-2}(n)$. A similar statement holds for first and last occurrences, where the shrinkage factor is at most $\gamma_{s-1}(n)$. This leads to a recurrence [4, p. 249] that *forgets* the role of m when analyzing global occurrences.

$$\lambda_s(n, m) \leq \sum_{q=1}^{\hat{m}} \lambda_s(\hat{n}_q, m_q) + 2 \cdot \gamma_{s-1}(n) \cdot n + \gamma_{s-2}(n) \cdot \lambda_s(\hat{n}, \hat{m}) + O(m)$$

Nivasch’s recurrence [63, Recurrence 3.1] improves that of Agarwal, Sharir, and Shor [4] by not forgetting that \bar{S} is an m -block sequence. In particular, $|\bar{S}'| \leq \sum_q \lambda_{s-2}(\hat{n}_q, m_q)$ where $|\bar{S}'| < \sum_q \hat{n}_q \leq \lambda_s(\hat{n}, \hat{m})$. Recurrence 3.3 is substantively no different than that of [63] but it is more succinct, for two reasons. First, the superadditivity of λ_s lets us bound the number of middle occurrences with the single term $\lambda_{s-2}(\lambda_s(\hat{n}, \hat{m}) - 2\hat{n}, m)$.¹⁶ Second, the function equivalent to $\lambda_s(n, m)$ from [4, 63] is the extremal function of order- s DS sequences that are *both* 2-sparse and have m blocks. This small change introduces $O(m)$ terms in [63, Recurrence 3.1] and [4, p. 249] since the derived sequences \hat{S}, \hat{S}' , and $\{\check{S}_q, \acute{S}_q, \bar{S}_q, \check{S}'_q\}_{1 \leq q \leq \hat{m}}$ are not necessarily 2-sparse, and must be made 2-sparse by removing $O(m)$ symbols at block boundaries.

Recurrence 3.3 could be made yet more succinct by removing the “ $-2\hat{n}$ ” from the estimation of global middle occurrences. This would not affect the solution asymptotically, but keeping it is essential for obtaining bounds on $\lambda_3(n)$ tight to the leading constant.

4 Derivation Trees

A *derivation tree* $\mathcal{T}(S)$ for an m -block sequence S is a rooted, ordered tree whose nodes are identified with the blocks encountered in recursively decomposing S , as in Section 3.1 and Recurrence 3.3. Let $\mathcal{B}(u)$ be the block associated with $u \in \mathcal{T}(S)$. The leaf level of $\mathcal{T}(S)$ coincides with S , that is, the p th leaf of $\mathcal{T}(S)$ holds the p th block of S . As we are sometimes indifferent to the order of symbols within a block, $\mathcal{B}(v)$ is often treated as a set. We assume without much loss in generality that no symbol appears just once in S . As usual, we adopt the sequence decomposition notation from Section 3.1.

Base Case. Suppose $S = \beta_1\beta_2$ is a two block sequence, where each block contains the whole alphabet $\Sigma(S)$. The tree $\mathcal{T}(S)$ consists of three nodes u, u_1 , and u_2 , where u is the parent of u_1 and u_2 , $\mathcal{B}(u_1) = \beta_1$, $\mathcal{B}(u_2) = \beta_2$, and $\mathcal{B}(u)$ does not exist. For every $a \in \Sigma(S)$ call u its *crown* and u_1 and u_2 its left and right *heads*, respectively. These nodes are denoted $\text{cr}_{|a}$, $\text{lhe}_{|a}$, and $\text{rhe}_{|a}$.

¹⁵Sharir [73] split global occurrences into two categories—first and non-first—which leads to a near-linear upper bound of $\lambda_s(n) < n \cdot \alpha(n)^{O(\alpha(n))^{s-3}}$.

¹⁶One might think it would be dangerous to bound middle occurrence with one aggregated term since we “forget” that \bar{S} is partitioned into $\hat{m} - 2$ order- $(s - 2)$ DS sequences. Doing this does not affect the solution of $\lambda_s(n, m)$ asymptotically.

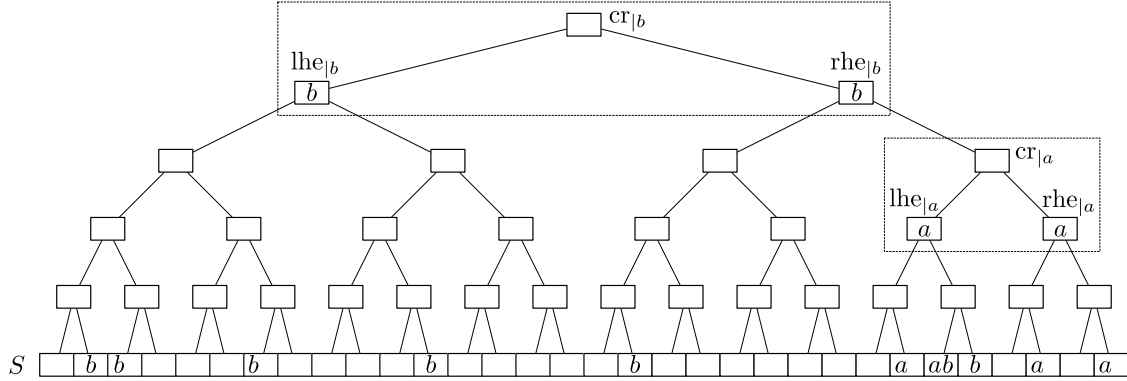

Figure 1: A derivation tree $\mathcal{T}(S)$ for a 32-block sequence S . The tree is generated by always choosing $\hat{m} = 2$ and the uniform block partition $m_1 = m_2 = m/2$, where $m > 2$ is the number of blocks in the given sequence. The frames isolate the base case derivation trees that assign the crown and heads for symbols $a, b \in \Sigma(S)$.

Inductive Case. If S contains $m > 2$ blocks, choose an $\hat{m} < m$ and an arbitrary block partition $\{m_q\}_{1 \leq q \leq \hat{m}}$. Inductively construct derivation trees $\hat{\mathcal{T}} = \mathcal{T}(\hat{S}')$ and $\{\check{\mathcal{T}}_q\}_{1 \leq q \leq \hat{m}}$, where $\check{\mathcal{T}}_q = \mathcal{T}(\check{S}_q)$, then identify the root of $\check{\mathcal{T}}_q$ (which has no block) with the q th leaf of $\hat{\mathcal{T}}$. Finally, place the blocks of S at the leaves of \mathcal{T} . This last step is necessary since only local symbols appear in the blocks of $\{\check{\mathcal{T}}_q\}$ whereas the leaves of \mathcal{T} must be identified with the blocks of S . Note that nodes at or above the leaf level of $\hat{\mathcal{T}}$ carry only global symbols in their blocks and that internal nodes in $\{\check{\mathcal{T}}_q\}$ carry only local symbols in their blocks. Local and global symbols only mingle at the leaf level of \mathcal{T} .

The crown and heads of each symbol $a \in \Sigma(S)$ are inherited from $\hat{\mathcal{T}}$, if a is global, or some $\check{\mathcal{T}}_q$ if a is local to S_q . See Figure 1 for an illustration.

4.1 Anatomy of the Tree

The *projection of \mathcal{T} onto $a \in \Sigma(S)$* , denoted $\mathcal{T}|_a$, is the tree on the node set $\{cr|_a\} \cup \{v \in \mathcal{T} \mid a \in \mathcal{B}(v)\}$ that inherits the ancestor/descendant relation from \mathcal{T} , that is, the parent of v in $\mathcal{T}|_a$, where $v \notin \{cr|_a, lhe|_a, rhe|_a\}$, is v 's nearest strict ancestor u for which $a \in \mathcal{B}(u)$. For example, in Figure 1 $\mathcal{T}|_a$ consists of $cr|_a$, its children $lhe|_a, rhe|_a$, and four grandchildren at the leaf level of \mathcal{T} .

Definition 4.1 (*Anatomy*)

- The leftmost and rightmost leaves of $\mathcal{T}|_a$ are wingtips, denoted $lwt|_a$ and $rwt|_a$.
- The left and right wings are those paths in $\mathcal{T}|_a$ extending from $lhe|_a$ to $lwt|_a$ and from $rhe|_a$ to $rwt|_a$.
- Descendants of $lhe|_a$ and $rhe|_a$ in $\mathcal{T}|_a$ are called doves and hawks, respectively.
- A child of a wing node that is not itself on the wing is called a quill.
- A leaf is called a feather if it is the rightmost descendant of a dove quill or leftmost descendant of a hawk quill.

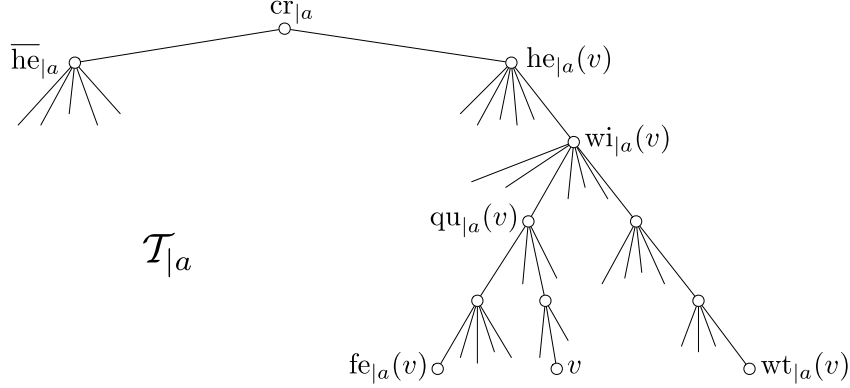

Figure 2: In this example v is a hawk leaf in \mathcal{T}_a since its head $\text{he}|_a(v) = \text{rhe}|_a$ is the right child of $\text{cr}|_a$. Its wing node $\text{wi}|_a(v)$, wingtip $\text{wt}|_a(v)$, quill $\text{qu}|_a(v)$, and feather $\text{fe}|_a(v)$ are indicated.

- Suppose v is a node in \mathcal{T}_a . Let $\text{he}|_a(v)$ be the head ancestral to v and $\overline{\text{he}}|_a(v)$ be the other head. Let $\text{wt}|_a(v)$ and $\overline{\text{wt}}|_a(v)$ be the wingtips descending from $\text{he}|_a(v)$ and $\overline{\text{he}}|_a(v)$. Let $\text{wi}|_a(v)$ be the nearest wing node ancestor of v , $\text{qu}|_a(v)$ the quill ancestral to v , and $\text{fe}|_a(v)$ the feather descending from $\text{qu}|_a(v)$. See Figure 2 for an illustration.

Once $a \in \Sigma(S)$ is known or specified, we will use these terms (feather, wingtip, etc.) to refer to nodes in \mathcal{T}_a or to the occurrences of a within those blocks. For example, an occurrence of a in S would be a feather if it appears in a block $\mathcal{B}(v)$ in S , where v is a feather in \mathcal{T}_a .

Note that the nodes $\text{he}|_a(v)$, $\text{wi}|_a(v)$, $\text{qu}|_a(v)$, $\text{wt}|_a(v)$, and $\text{fe}|_a(v)$ are not necessarily distinct. It may be that $\text{he}|_a(v) = \text{wi}|_a(v)$, and it may be that $v = \text{qu}|_a(v) = \text{fe}|_a(v)$ if v 's parent in \mathcal{T}_a is $\text{wi}|_a(v)$.

Lemma 4.2 identifies one property of \mathcal{T} used in the proof of Lemma 4.3.

Lemma 4.2 Suppose that on a leaf-to-root path in \mathcal{T} we encounter nodes u, v, x , and y (the last two possibly identical), where $u, x \in \mathcal{T}_a$ and $v, y \in \mathcal{T}_b$. It must be that $a \in \mathcal{B}(v)$ and therefore $v \in \mathcal{T}_a$.

Proof: Consider the decomposition of \mathcal{T} into a global derivation tree $\hat{\mathcal{T}}$ and local derivation trees $\{\check{\mathcal{T}}_q\}$. If v were an internal node in some $\check{\mathcal{T}}_q$ then b would be classified as local. This implies $y \in \check{\mathcal{T}}_q$ as well and the claim follows by induction on the construction of $\check{\mathcal{T}}_q$. If v were an internal node in $\hat{\mathcal{T}}$ then let u' be the leaf of $\hat{\mathcal{T}}$ ancestral to u . The nodes $u', v, x, y \in \hat{\mathcal{T}}$ also satisfy the criteria of the lemma; the claim follows by induction on the construction of $\hat{\mathcal{T}}$. Thus, we can assume v is a leaf of $\hat{\mathcal{T}}$ and u is a leaf of \mathcal{T} . See Figure 3. By construction all global symbols in $\mathcal{B}(u)$ also appear in $\mathcal{B}(v)$. Since $x \in \hat{\mathcal{T}}$, the symbol a is classified as global and must appear in $\mathcal{B}(v)$. \square

4.2 Habitual Nesting

Suppose a block β in S contains two symbols a, b that are not wingtips, that is, they make neither their first nor last appearance in β . We call a and b *nested* in β if S contains either $ab\beta ba$ or

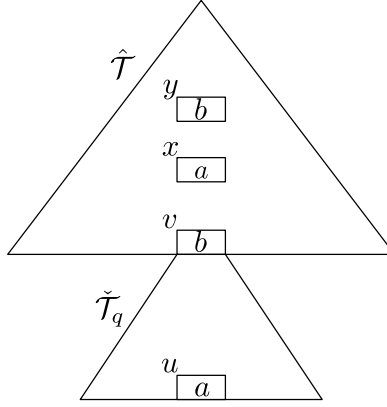

Figure 3: The case where v is a leaf of $\hat{\mathcal{T}}$. Both x and y are necessarily in $\hat{\mathcal{T}}$, which implies that a and b are global, and further implies that u is a leaf of $\check{\mathcal{T}}_q$ since global symbols do not appear in the internal nodes of $\check{\mathcal{T}}_q$. All global symbols of u also appear in v .

$ba\beta ab$ and call them *interleaved in β* otherwise, that is, if the occurrences of a and b in S take the form $a^*b^*\beta a^*b^*$ or $b^*a^*\beta b^*a^*$. Lemma 4.3 is the critical structural lemma used in our analysis. It provides us with simple criteria for nestedness.

Lemma 4.3 *Suppose that $v \in \mathcal{T}(S)$ is a leaf and a, b are symbols in a block $\mathcal{B}(v)$ of S . If the following two criteria are satisfied then a and b are nested in $\mathcal{B}(v)$.*

- i. v is not a wingtip in either $\mathcal{T}_{|a}$ or $\mathcal{T}_{|b}$.
- ii. v is not a feather in either $\mathcal{T}_{|a}$ or $\mathcal{T}_{|b}$.

Proof: Without loss of generality we can assert two additional criteria.

- iii. $\text{cr}_{|b}$ is equal to or strictly ancestral to $\text{cr}_{|a}$.
- iv. v is a dove in $\mathcal{T}_{|a}$.

By Criterion (iv) the leftmost leaf descendant of $\text{wi}_{|a}(v)$ is $\text{wt}_{|a}(v)$. Let u be its rightmost leaf descendant. According to Criteria (i,ii) v is distinct from both $\text{wt}_{|a}(v)$ and u since u must be a feather. We partition the sequence S outside of $\mathcal{B}(v)$ into the following four intervals.

- I_1 : everything preceding the a in $\mathcal{B}(\text{wt}_{|a}(v))$,
- I_2 : everything from the end of I_1 to $\mathcal{B}(v)$,
- I_3 : everything from $\mathcal{B}(v)$ to the a in $\mathcal{B}(u)$, and
- I_4 : everything following I_3 .

Since v is not a wingtip of $\mathcal{T}_{|b}$, by Criterion (i), there must be occurrences of b in S both before and after $\mathcal{B}(v)$. If, contrary to the claim, a and b are not nested in $\mathcal{B}(v)$, all other occurrences of b must appear exclusively in I_1 and I_3 or exclusively in I_2 and I_4 . We show that both possibilities lead to contradictions. Figures 4 and 5 illuminate the proof.

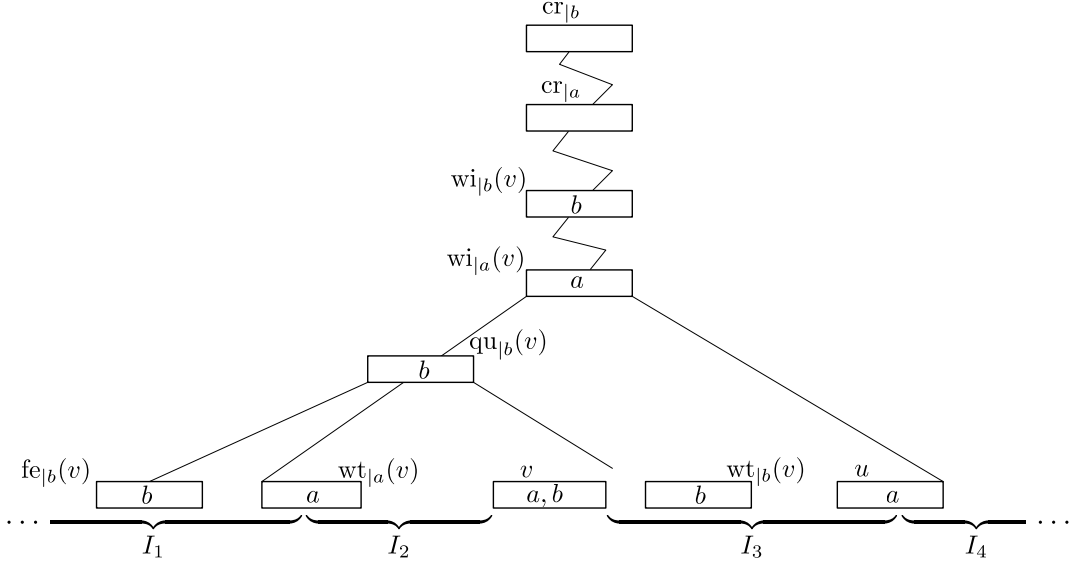

Figure 5: In Case 2 all occurrences of b outside of $\mathcal{B}(v)$ appear in intervals I_1 and I_3 .

Let us review the situation. Scanning the leaves from left to right we see the blocks $wt_{|a}(v)$, $wt_{|b}(v)$, v , u , $fe_{|b}(v)$, and $\overline{wt}_{|a}(v)$. It may be that $wt_{|a}(v)$ and $wt_{|b}(v)$ are equal and it may be that u and $fe_{|b}(v)$ are equal. If either of these cases hold then the a precedes the b in the given block. The blocks $wt_{|a}(v)$, $wt_{|b}(v)$, v , $fe_{|b}(v)$, $\overline{wt}_{|a}(v)$ certify that a and b are nested in $\mathcal{B}(v)$.

Case 2: b does not appear in I_2 or I_4 By Criterion (i) the right wingtip $rwt_{|b}$ is distinct from v and must therefore lie in I_3 . Following the same reasoning from Case 1 we can deduce that

viii. v is a hawk in $\mathcal{T}_{|b}$.

ix. In \mathcal{T} , $qu_{|b}(v)$ is strict descendant of $wi_{|a}(v)$ and a strict ancestor of $wt_{|a}(v)$.

Inference (viii) follows since v and $rwt_{|b}$ must be descendants of the same head in $\mathcal{T}_{|b}$. This implies that $fe_{|b}(v)$ is the *leftmost* leaf descendant of $qu_{|b}(v)$. Since $fe_{|b}(v)$ is distinct from v and interval I_2 is free of bs , it must be that $fe_{|b}(v)$ lies in I_1 and that $qu_{|b}(v)$ is a strict descendant of $wi_{|a}(v)$ and a strict ancestor of $wt_{|a}(v)$. Inference (ix) follows. See Figure 5.

It follows from Criterion (iii) and Inference (ix) that on a leaf-to-root path one encounters the nodes $wt_{|a}(v)$, $qu_{|b}(v)$, $wi_{|a}(v)$, and $cr_{|b}$, in that order. Lemma 4.2 implies that $a \in \mathcal{B}(qu_{|b}(v))$. We have deduced that $qu_{|b}(v)$ is in $\mathcal{T}_{|a}$, is a strict descendant of $wi_{|a}(v)$, and is a common ancestor of $wt_{|a}(v)$ and v . This contradicts the fact that $wi_{|a}(v)$ is the *least* common ancestor of v and $wt_{|a}(v)$ in $\mathcal{T}_{|a}$. \square

Note that Lemma 4.3 applies to any blocked sequence and an associated derivation tree. It has nothing to do with Davenport-Schinzel sequences as such.

5 A Recurrence for Odd Orders

Lemma 4.3 may be rephrased as follows. Every blocked sequence S is the union of four sequences: two comprising wingtips (first occurrences and last occurrences, each of length n), one comprising all feathers, and one comprising non-wingtip non-feathers. The last sequence is distinguished by the property that each pair of symbols in any block is nested with respect to S , which is a “good” thing if we are intent on giving strong upper bounds on odd-order sequences. The sequence comprising feathers is “bad” in this sense, therefore we must obtain better-than-trivial upper bounds on its length if this strategy is to bear fruit.

Recall that *feather* is a term that can be applied to nodes in some $\mathcal{T}|_b$ or the corresponding *occurrences* of b in the given sequence S . This definition is with respect to one derivation tree \mathcal{T} for S , which is not necessarily the best one. In Recurrences 5.1 and 5.2 it is useful to reason about the *optimal* derivation tree. Let $\mathcal{T}^*(S)$ be the derivation tree for S that minimizes the number of occurrences in S classified as feathers.

Recurrence 5.1 *Define $\Phi_s(n, m)$ to be the maximum number of feathers in any order- s , m -block DS sequence S over an n -letter alphabet, with respect to the optimal derivation tree $\mathcal{T}^*(S)$. When $m \leq 2$ we have $\Phi_s(n, m) = 0$. For any $\hat{m} < m$, any block partition $\{m_q\}_{1 \leq q \leq \hat{m}}$, and any alphabet partition $\{\hat{n}\} \cup \{\check{n}_q\}_{1 \leq q \leq \hat{m}}$, we have*

$$\Phi_s(n, m) \leq \sum_{q=1}^{\hat{m}} \Phi_s(\check{n}_q, m_q) + \Phi_s(\hat{n}, \hat{m}) + 2 \cdot \lambda_{s-1}(\hat{n}, m)$$

Proof: When $m \leq 2$, $\Phi_s(n, m)$ is trivially 0 since every occurrence in S is a wingtip, and feathers are not wingtips. When $m > 2$ we shall decompose S as in Section 3.1. The choice of \hat{m} and the block partition $\{m_q\}_{1 \leq q \leq \hat{m}}$ are not necessarily those of the optimal derivation tree, but we do not need them to be. We are only interested in an upper bound on $\Phi_s(n, m)$. Let $\hat{\mathcal{T}}^*$ and $\{\check{\mathcal{T}}_q^*\}_{1 \leq q \leq \hat{m}}$ be the optimal derivation trees for \hat{S} and $\{\check{S}_q\}_{1 \leq q \leq \hat{m}}$, and let \mathcal{T} be their composition, with the blocks of S placed at \mathcal{T} 's leaves.

The number of occurrences of local feathers with respect to $\{\check{\mathcal{T}}_q^*\}$ is at most $\sum_q \Phi_s(\check{n}_q, m_q)$. An occurrence of $a \in \mathcal{B}(v)$ in \hat{S} will be a dove feather in \mathcal{T} if either (i) v is the rightmost child of a dove feather in $\hat{\mathcal{T}}_{|a}^*$ or (ii) v is a non-wingtip child of the left wingtip in $\hat{\mathcal{T}}_{|a}^*$, which corresponds to an occurrence of a in \check{S} . The same statement is true of hawk feathers, swapping the roles of left and right and substituting \check{S} for \hat{S} . There are at most $\Phi_s(\hat{n}, \hat{m})$ feathers of type (i) and, since \hat{S} and \check{S} are order- $(s-1)$ DS sequences, less than $2 \cdot \lambda_{s-1}(\hat{n}, m)$ of type (ii). \square

We now have all the elements in place to provide a recurrence for odd-order Davenport-Schinzel sequences.

Recurrence 5.2 *Let m, n , and s be the block count, alphabet size, and order parameters, where $s \geq 5$ is odd. For any $\hat{m} < m$, any block partition $\{m_q\}_{1 \leq q \leq \hat{m}}$, and any alphabet partition $\{\hat{n}\} \cup \{\check{n}_q\}_{1 \leq q \leq \hat{m}}$, we have*

$$\lambda_s(n, m) \leq \sum_{q=1}^{\hat{m}} \lambda_s(\check{n}_q, m_q) + 2 \cdot \lambda_{s-1}(\hat{n}, m) + \lambda_{s-2}(\Phi_s(\hat{n}, \hat{m}), m) + \lambda_{s-3}(\lambda_s(\hat{n}, \hat{m}), m)$$

Proof: As always, we adopt the notation from Section 3.1. Define $\hat{\mathcal{T}}^*$, $\{\check{\mathcal{T}}_q^*\}$, and \mathcal{T} as in the proof of Recurrence 5.1. In Recurrence 3.3 we partitioned S into local and global symbols and partitioned the occurrences of global symbols into first, middle, and last. We now partition the middle occurrences one step further. Define \hat{S}' and \check{S}' to be the subsequences of \hat{S}' consisting of feathers (according to $\hat{\mathcal{T}}^*$) and non-feather, non-wingtips, respectively. That is, $|\hat{S}'| = |\check{S}'| + |\hat{S}'| + 2\hat{n}$. In an analogous fashion define \tilde{S} and \check{S} to be the subsequences of \hat{S} consisting of children of occurrences in \hat{S}' and \check{S}' . The sequences \hat{S} and \check{S} represent the children of dove and hawk wingtips in $\hat{\mathcal{T}}^*$. Thus, $|S| = \sum_q |\check{S}_q| + |\hat{S}| + |\check{S}| + |\tilde{S}| + |\hat{S}'|$.

The local sequences $\{\check{S}_q\}$ are order- s DS sequences. According to the standard argument \hat{S} and \check{S} are order- $(s-1)$ DS sequences and $\tilde{S} = \tilde{S}_1 \cdots \tilde{S}_{\hat{m}}$ is obtained from \check{S}' by substituting for its q th block an order- $(s-2)$ DS sequence \check{S}_q . From the superadditivity of λ_{s-2} it follows that $|\tilde{S}| \leq \lambda_{s-2}(|\check{S}'|, m) \leq \lambda_{s-2}(\Phi_s(\hat{n}, \hat{m}), m)$.

We claim that $\check{S} = \check{S}_1 \cdots \check{S}_{\hat{m}}$ is obtained from \check{S}' by substituting for its q th block an order- $(s-3)$ DS sequence \check{S}_q , which, if true, would imply that $|\check{S}'| \leq \lambda_{s-3}(|\check{S}'|, m) < \lambda_{s-3}(\lambda_s(\hat{n}, \hat{m}), m)$. Suppose for the purpose of obtaining a contradiction that the q th block β in \check{S}' contains $a, b \in \hat{\Sigma}$, and that \check{S}_q is not an order- $(s-3)$ DS sequence, that is, it contains an alternating subsequence $ab \cdots ab$ of length $s-1$. Note that $s-1$ is even. By definition β is a non-feather, non-wingtip in both $\hat{\mathcal{T}}^*|_a$ and $\hat{\mathcal{T}}^*|_b$. According to Lemma 4.3, a and b must be nested in β , which implies that S contains a subsequence of the form

$$\begin{array}{c} a \cdots b \cdots \left| \overbrace{a \cdots b \cdots a \cdots b \cdots}^{s-1} \right| \cdots b \cdots a \\ \text{or} \quad b \cdots a \cdots \left| \overbrace{a \cdots b \cdots a \cdots b \cdots}^{s-1} \right| \cdots a \cdots b \end{array}$$

where the portion between bars is in S_q . In either case S contains an alternating subsequence with length $s+2$, contradicting the fact that S is an order- s DS sequence. \square

5.1 Analysis of the Recurrences

The dependencies between λ and Φ established by Recurrences 3.3, 5.1, and 5.2 are rather intricate. For even s , λ_s is a function of λ_s, λ_{s-1} and λ_{s-2} , and for odd s , λ_s is a function of $\lambda_s, \lambda_{s-1}, \lambda_{s-2}, \lambda_{s-3}$, and Φ_s while Φ_s is a function of Φ_s and λ_{s-1} .

The proof of Lemma 5.3 is by induction over parameters: s, n, c, i , and j , where s is the order, n the alphabet size, $c \geq s-2$ a constant that determines how \hat{m} and the block partition is chosen, $i \geq 1$ is an integer, and j is minimal such that the block count $m \leq a_{i,j}^c$. Some level of complexity is therefore unavoidable. Furthermore, when $s \geq 5$ is odd, λ_s is so sensitive to approximations of λ_{s-3} that we must treat $s \in \{1, 2, 3, 4, 5\}$ as distinct base cases, and treat even and odd $s \geq 6$ as separate inductive cases. Given these constraints we feel our analysis is reasonably simple.

Lemma 5.3 *Let $s \geq 1$ be the order parameter, $c \geq s-2$ be a constant, and $i \geq 1$ be an arbitrary integer. The following upper bounds on λ_s and Φ_s hold for all $s \geq 1$ and all odd $s \geq 5$, respectively.*

Define j to be maximum such that $m \leq a_{i,j}^c$.

$$\begin{aligned}
\lambda_1(n, m) &= n + m - 1 & s = 1 \\
\lambda_2(n, m) &= 2n + m - 2 & s = 2 \\
\lambda_3(n, m) &\leq (2i + 2)n + (3i - 2)cj(m - 1) & s = 3 \\
\lambda_s(n, m) &\leq \mu_{s,i}(n + (cj)^{s-2}(m - 1)) & \text{all } s \geq 4 \\
\Phi_s(n, m) &\leq \nu_{s,i}(n + (cj)^{s-2}(m - 1)) & \text{odd } s \geq 5
\end{aligned}$$

The values $\{\mu_{s,i}, \nu_{s,i}\}$ are defined as follows, where $t = \lfloor \frac{s-2}{2} \rfloor$.

$$\begin{aligned}
\mu_{s,i} &= \begin{cases} 2^{\binom{i+t+3}{t}} - 3(2(i+t+1))^t & \text{even } s \geq 4 \\ \frac{3}{2}(2(i+t+1))^{t+1}2^{\binom{i+t+3}{t}} & \text{odd } s \geq 5 \end{cases} \\
\nu_{s,i} &= 4 \cdot 2^{\binom{i+t+3}{t}} & \text{odd } s \geq 5
\end{aligned}$$

One may want to keep in mind that we will eventually substitute $\alpha(n, m) + O(1)$ for the parameter i , and that $\binom{i+t+O(1)}{t} = i^t/t! + O(i^{t-1})$. Lemma 5.3 will, therefore, imply bounds on $\lambda_s(n, m)$ analogous to those claimed for $\lambda_s(n)$ in Theorem 1.2. The proof of Lemma 5.3 appears in Appendix B.

5.2 The Upper Bounds of Theorem 1.2

Fix $s \geq 3, n, m$ and let $c = s - 2$. For $i \geq 1$ let j_i be minimum such that $m \leq a_{i,j_i}^c$. Lemma 5.3 implies that an order- s DS sequence has length at most $\mu_{s,i}(n + (cj_i)^{s-2}m)$. Choose ι to be minimum such that¹⁷ $(cj_\iota)^{s-2} \leq \max\{\frac{n}{m}, (c \cdot 3)^{s-2}\}$. One can show that $\iota = \alpha(n, m) + O(1)$. By choice of ι it follows that $(cj_\iota)^{s-2}m = O(m + n)$, so $\lambda_s(n, m) = O((n + m)\mu_{s,\iota})$. According to Lemma 5.3's definition of $\mu_{s,\iota}$, we have

$$\begin{aligned}
\lambda_3(n, m) &= O((n + m)\alpha(n, m)) \\
\lambda_4(n, m) &= O\left((n + m)2^{\alpha(n, m)}\right) \\
\lambda_5(n, m) &= O\left((n + m)\alpha^2(n, m)2^{\alpha(n, m)}\right) \\
\lambda_s(n, m) &= (n + m) \cdot 2^{\alpha^t(n, m)/t! + O(\alpha^{t-1}(n, m))} \quad \text{both even and odd } s \geq 6, \text{ where } t = \lceil \frac{s-2}{2} \rceil.
\end{aligned}$$

The bound on $\lambda_5(n, m)$ follows since $\mu_{5,\iota} = O(\iota^2 2^\iota)$. When $s \geq 6$ and $t \geq 2$, $\mu_{s,\iota} < \iota^{t+1} 2^{\binom{\iota+t+O(1)}{t}} = 2^{\iota/t! + O(\iota^{t-1})}$.

Theorem 1.2 stated bounds on $\lambda_s(n)$ rather than $\lambda_s(n, m)$. If it were known that extremal order- s DS sequences consisted of $m = O(n)$ blocks we could simply substitute $\alpha(n)$ for $\alpha(n, m)$ in the bounds above, but this is not known to be true. According to Lemma 3.1(2,4), if γ_s is such that $\lambda_s(n) \leq \gamma_s(n) \cdot n$ then $\lambda_s(n) \leq \gamma_{s-2}(n) \cdot \lambda_s(n, 2n - 1)$ and $\lambda_s(n) \leq \gamma_{s-2}(\gamma_s(n)) \cdot \lambda_s(n, 3n - 1)$.

¹⁷We want $(cj_\iota)^{s-2}m$ not to be the dominant term, so $(cj_\iota)^{s-2}$ should be less than $\lceil n/m \rceil$. On the other hand, the first and second columns of Ackermann's function ($a_{i,1}$ and $a_{i,2}$) do not exhibit sufficient growth, so j_ι must also be at least 3.

Applying Lemma 3.1 when $s \in \{3, 4\}$ has no asymptotic affect since $\gamma_1 = 1$ and $\gamma_2 = 2$. It has no *perceptible* effect when $s \geq 6$ since $\gamma_{s-2}(n)$ or $\gamma_{s-2}(\gamma_s(n))$ is dwarfed by the lower order terms in the exponent. However, for $s \in \{3, 5\}$ these reductions only show that $\lambda_3(n) = O(n\alpha(n))$ and that $\lambda_5(n) = O(n\alpha(\alpha(n))\alpha^2(n)2^{\alpha(n)})$, which are weaker than the bounds claimed in Theorem 1.2.

In Section 5.2.1 we prove $\lambda_3(n) = 2n\alpha(n) + O(n)$, which is a tiny improvement over Klazar's bound [51, 63], though it is within $O(n)$ of Nivasch's construction [63] and is therefore optimal in the Ackermann-invariant sense. See Remark 1.1. To prove $\lambda_5(n) = \Theta(n\alpha(n)2^{\alpha(n)})$ we require a significant generalization of the derivation tree method. Sections 6 and 7 give the matching lower and upper bounds on order-5 DS sequences.

5.2.1 Order $s = 3$

Let S be an order-3 DS sequence over an n -letter alphabet. According to Lemma 3.1 ([41]), $|S| \leq \lambda_3(n) \leq \lambda_3(n, m)$, where $m = 2n - 1$. Letting ι be minimum such that $m \leq a_{\iota, 3}$, Lemma 5.3 implies that $\lambda_3(n, m) < (2\iota + 2)n + (3\iota - 2)m < (8\iota - 2)n$. It is straightforward to show that $\iota \leq \alpha(n) + O(1)$. The problem is clearly that there are too many blocks. Were there less than $(2n - 1)/\iota$ blocks, Lemma 5.3 would give a bound of $(2\iota + 2)n + O(\iota m/\iota) = 2n\alpha(n) + O(n)$. We can invoke Recurrence 3.3 to divide S into a global \hat{S} and local $\check{S} = \check{S}_1 \cdots \check{S}_{\hat{m}}$, where $\hat{m} = m/\iota \leq (2n - 1)/\iota$, that is, each \check{S}_q is an ι -block sequence. Using Lemma 5.3 we will bound \hat{S} with $i = \iota$ and each of the $\{\check{S}_q\}_q$ with $i = 1$.

$$\begin{aligned}
|S| &\leq \lambda_3(n) \leq \lambda_3(n, m) && \{\text{where } m = 2n - 1\} \\
&\leq \sum_{q=1}^{\hat{m}} \lambda_3(\check{n}_q, \iota) + 2 \cdot \lambda_2(\hat{n}, m) + \lambda_1(\lambda_3(\hat{n}, \hat{m}) - 2\hat{n}, m) && \{\text{Recurrence 3.3}\} \\
&< \sum_{q=1}^{\hat{m}} \left[4\check{n}_q + \min \left\{ \iota \lceil \log \iota \rceil, (\iota - 1) + (2\check{n}_q - 1) \lceil \log(2\check{n}_q - 1) \rceil \right\} \right] && (*) \\
&\quad + [4\hat{n} + 2m] + [2\iota\hat{n} + (3\iota - 2)\hat{m} + m] && \{\text{Lemmas 3.2, 5.3}\} \\
&< \left[m + (n - \hat{n})(4 + 2 \lceil \log(2\iota - 1) \rceil) \right] + (2\iota + 4)\hat{n} + (3\iota - 2)m/\iota + 3m && \{\hat{m} = m/\iota\} \\
&< (2\iota + 4)n + 7m && \{\text{worst case if } \hat{n} = n\} \\
&\leq 2n\alpha(n) + O(n) && \{\iota = \alpha(n) + O(1)\}
\end{aligned}$$

The bound on local symbols in line (*) follows from Lemma 5.3 and Hart and Sharir's [41] observation that $\lambda_3(n) \leq \lambda_3(n, 2n - 1)$. When $i = 1$ and $j = \lceil \log \iota \rceil$, Lemma 5.3 gives us a bound of $\lambda_3(\check{n}_q, \iota) \leq 4\check{n}_q + \iota \lceil \log \iota \rceil$. Alternatively, we could make \check{S}_q 2-sparse by removing up to $\iota - 1$ duplicated symbols at block boundaries, then partitioning the remaining sequence into $2\check{n}_q - 1$ blocks, hence $\lambda_3(\check{n}_q, \iota) \leq \iota - 1 + \lambda_3(\check{n}_q, 2\check{n}_q - 1) \leq \iota - 1 + 4\check{n}_q + (2\check{n}_q - 1) \lceil \log(2\check{n}_q - 1) \rceil$. This matches Nivasch's lower bound [63] on $\lambda_3(n)$ to within $O(n)$.

6 Lower Bounds on Fifth-Order Sequences

We have established every bound claimed in Theorem 1.2 except for those on order-5 DS sequences. In this section we give a construction that yields bounds of $\lambda_5(n, m) = \Omega(n\alpha(n, m)2^{\alpha(n, m)})$ and

$\lambda_5(n) = \Omega(n\alpha(n)2^{\alpha(n)})$. This is the first construction that is asymptotically longer than the order-4 DS sequences of [4] having length $\Theta(n2^{\alpha(n)})$. Our construction is based on generalized forms of sequence *composition* and *shuffling* used by Agarwal, Sharir, and Shor [4], Nivasch [63], and Pettie [68].

Recall from Section 1.1 that $\|S\| = |\Sigma(S)|$ is the alphabet size of S and, if S is partitioned into blocks, $\llbracket S \rrbracket$ is its block count.

6.1 Composition and Shuffling

In its generic form, a sequence S is assumed to be over the alphabet $\{1, \dots, \|S\|\}$, that is, any totally ordered set with size $\|S\|$. To *substitute* S for a block $\beta = [a_1 \dots a_{|\beta|}]$ means to replace β with a copy $S(\beta)$ under the alphabet mapping $k \mapsto a_k$, where $|\beta| \leq \|S\|$. If $|\beta|$ is strictly smaller than $\|S\|$, any occurrences of the $\|S\| - |\beta|$ unused symbols of $\Sigma(S)$ do not appear in $S(\beta)$. We always assume that S is in *canonical form*: the symbols are ordered according to the position of their first appearance in S .

Composition. If S_{mid} is a sequence in canonical form with $\|S_{\text{mid}}\| = j$ and S_{top} a sequence partitioned into blocks with length at most j , $S_{\text{sub}} = S_{\text{top}} \circ S_{\text{mid}}$ is obtained by substituting for each block β in S_{top} a copy $S_{\text{mid}}(\beta)$. Clearly $\llbracket S_{\text{sub}} \rrbracket = \llbracket S_{\text{top}} \rrbracket \cdot \llbracket S_{\text{mid}} \rrbracket$. If S_{mid} and S_{top} contain μ and μ' occurrences of each symbol, respectively, then S_{sub} contains $\mu\mu'$ occurrences of each symbol. Composition preserves canonical form, that is, if S_{mid} and S_{top} are in canonical form, so is S_{sub} .

Shuffling. If S_{bot} is a j' -block sequence and S_{sub} is partitioned into blocks of length at most j' , we can form the *shuffle* $S_{\text{sh}} = S_{\text{sub}} \diamond S_{\text{bot}}$ as follows. First create a sequence S_{bot}^* consisting of the concatenation of $\llbracket S_{\text{sub}} \rrbracket$ copies of S_{bot} , each copy being over an alphabet disjoint from the other copies and disjoint from that of S_{sub} . By design the length of S_{sub} is at most the number of blocks in S_{bot}^* , and precisely the same if all blocks in S_{sub} have their maximum length j' . The sequence $S_{\text{sub}} \diamond S_{\text{bot}}$ is obtained by shuffling the j' symbols of the l th block of S_{sub} into the j' blocks of the l th copy of S_{bot} in S_{bot}^* . Specifically, the k th symbol of the l th block is inserted at the *end* of the k th block of the l th copy of S_{bot} .

Three-Fold Composition. Our construction of order-5 DS sequences uses a generalized form of composition that treats symbols in β differently based on context. Suppose S_{top} is partitioned into blocks with length at most j and $S_{\text{mid}}^f, S_{\text{mid}}^m$, and S_{mid}^l are sequences with alphabet size $\|S_{\text{mid}}^f\| = \|S_{\text{mid}}^m\| = \|S_{\text{mid}}^l\| = j$. The 3-fold composition $S_{\text{top}} \circ \langle S_{\text{mid}}^f, S_{\text{mid}}^m, S_{\text{mid}}^l \rangle$ is formed as follows. For each block β in S_{top} , categorize its symbols as *first* if they occur in no earlier block, *last* if they occur in no later block, and *middle* otherwise. Let β^f, β^m , and β^l be the subsequences of β consisting of first, middle, and last symbols. Note that these three sequences do not necessarily occur contiguously in β , but each is nonetheless a subsequence of β . Substitute for β the concatenation of $S_{\text{mid}}^f(\beta^f), S_{\text{mid}}^m(\beta^m)$, and $S_{\text{mid}}^l(\beta^l)$. Note that if $S_{\text{top}}, S_{\text{mid}}^f, S_{\text{mid}}^m$, and S_{mid}^l contain $\mu \geq 2, \mu^f, \mu^m$, and μ^l occurrences of each symbol then $S_{\text{top}} \circ \langle S_{\text{mid}}^f, S_{\text{mid}}^m, S_{\text{mid}}^l \rangle$ contains $\mu^f + \mu^l + (\mu - 2)\mu^m$ occurrences of each symbol. Figure 6 gives a schematic of the generation of the sequence $(S_{\text{top}} \circ \langle S_{\text{mid}}^f, S_{\text{mid}}^m, S_{\text{mid}}^l \rangle) \diamond S_{\text{bot}}$.

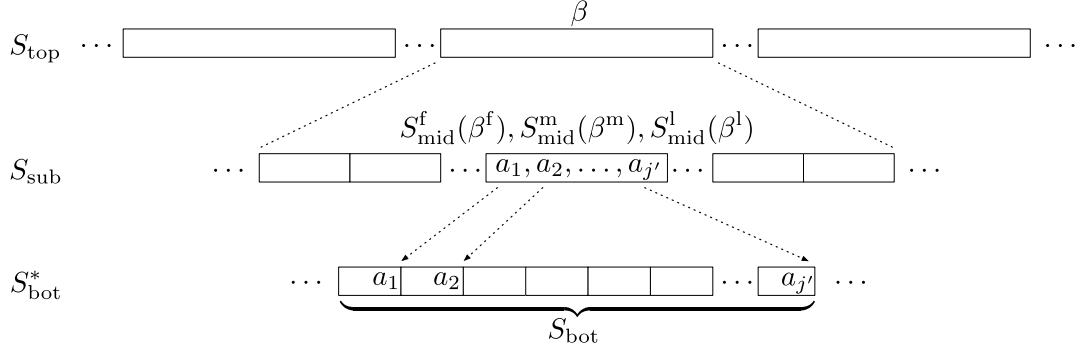

Figure 6: Three-fold composition followed by shuffling. Each block β in S_{top} is replaced with the concatenation of $S_{\text{mid}}^f(\beta^f)$, $S_{\text{mid}}^m(\beta^m)$, and $S_{\text{mid}}^l(\beta^l)$ and each block of *that* sequence is shuffled with a single copy of S_{bot} in S_{bot}^* . In general, blocks in $S_{\text{mid}}^f(\beta^f)$, $S_{\text{mid}}^m(\beta^m)$, and $S_{\text{mid}}^l(\beta^l)$ will not attain their maximum length j' .

6.2 Sequences of Orders 4 and 5

The sequences $S_4(i, j)$ and $S_5(i, j)$ are defined inductively below. As we will prove, $S_4(i, j)$ is an order-4 DS sequence partitioned into blocks of length precisely j in which each symbol appears 2^i times, whereas $S_5(i, j)$ is an order-5 DS sequence partitioned into blocks of length *at most* j in which each symbol appears $(2i - 3)2^i + 4$ times. Let $B_s(i, j) = \llbracket S_s(i, j) \rrbracket$ and $N_s(i, j) = \|S_s(i, j)\|$ be, respectively, the number of blocks in $S_s(i, j)$ and the alphabet size of $S_s(i, j)$. By definition $|S_4(i, j)| = 2^i \cdot N_4(i, j) = j \cdot B_4(i, j)$ and $|S_5(i, j)| = ((2i - 3)2^i + 4) \cdot N_5(i, j) \leq j \cdot B_5(i, j)$. The construction of S_4 is the same as Nivasch's [63] and similar to that of Agarwal et al. [4].

The base cases for our sequences are given below, where square brackets indicate blocks:

$$\begin{aligned}
 S_2(j) &= [12 \cdots (j-1)j] [j(j-1) \cdots 21] && \text{two blocks with length } j \\
 S_4(1, j) &= S_5(1, j) = S_2(j) \\
 S_4(i, 1) &= [1]^{2^i} && 2^i \text{ identical blocks} \\
 S_5(i, 1) &= [1]^{(2i-3)2^i+4} && (2i-3)2^i + 4 \text{ identical blocks}
 \end{aligned}$$

Observe that these base cases satisfy the property that symbols appear precisely 2^i times in $S_4(i, \cdot)$ and $(2i - 3)2^i + 4$ times in $S_5(i, \cdot)$. Define $S_4(i, j)$ as

$$S_4(i, j) = \left(S_4(i-1, y) \circ S_2(y) \right) \diamond S_4(i, j-1), \quad \text{where } y = B_4(i, j-1)$$

and $S_5(i, j)$ as

$$S_5(i, j) = \left(S_{\text{top}} \circ \left\langle S_{\text{mid}}^{\text{f}}, S_{\text{mid}}^{\text{m}}, S_{\text{mid}}^{\text{l}} \right\rangle \right) \diamond S_{\text{bot}}$$

where $S_{\text{bot}} = S_5(i, j - 1)$, $z = B_5(i, j - 1)$

$$S_{\text{mid}}^{\text{f}} = S_{\text{mid}}^{\text{l}} = S_4(i, z),$$

$$S_{\text{mid}}^{\text{m}} = S_2(N_4(i, z)),$$

and $S_{\text{top}} = S_5(i - 1, N_4(i, z))$,

By definition $S_{\text{mid}}^{\text{f}}$ and $S_{\text{mid}}^{\text{l}}$ are partitioned into blocks with length z . In the three-fold composition operation we also interpret $S_2(N_4(i, z))$ as a sequence of blocks of length precisely z . It will be shown shortly that $N_4(i, z)$ is, in fact, a multiple of z . We argue by induction that symbols appear with the correct multiplicity in S_4 and S_5 . In the case of S_4 each symbol appears 2^{i-1} times in $S_4(i - 1, y)$ (by the inductive hypothesis), twice in $S_2(y)$, and therefore 2^i times in $S_4(i - 1, y) \circ S_2(y)$. Symbols in copies of $S_4(i, j - 1)$ already appear 2^i times, by the inductive hypothesis. In $S_5(i - 1, N_4(i, z))$ each symbol appears $(2i - 5)2^{i-1} + 4$ times. The 3-fold composition operation increases the multiplicity of such symbols to $2((2i - 5)2^{i-1} + 2) + 2(2^i) = (2i - 3)2^i + 4$, where the first term accounts for the blowup in middle occurrences and the second term for the blowup in first and last occurrences. It follows that B and N are defined inductively as follows.

$$B_4(1, j) = B_5(1, j) = B_2(j) = 2$$

$$B_4(i, 1) = 2^i$$

$$B_5(i, 1) = (2i - 3)2^i + 4$$

$$B_4(i, j) = B_4(i - 1, y) \cdot 2 \cdot y \quad \text{where } y = B_4(i, j - 1)$$

$$B_5(i, j) = B_5(i - 1, N_4(i, z)) \cdot (2 + 2^{-i+1})B_4(i, z) \cdot z \quad \text{where } z = B_5(i, j - 1)$$

$$N_4(1, j) = N_5(1, j) = N_2(j) = j$$

$$N_4(i, 1) = N_5(i, 1) = 1$$

$$N_4(i, j) = N_4(i - 1, y) + B_4(i - 1, y) \cdot 2 \cdot N_4(i, j - 1)$$

$$N_5(i, j) = N_5(i - 1, N_4(i, z)) + B_5(i - 1, N_4(i, z)) \cdot (2 + 2^{-i+1})B_4(i, z) \cdot N_5(i, j - 1)$$

The $2 + 2^{-i+1}$ factor in the definition of $B_5(i, j)$ and $N_5(i, j)$ comes from the fact that in the shuffling step, $S_2(N_4(i, z))$ is interpreted as having $|S_2(N_4(i, z))|/z$ blocks of length z , where

$$\frac{|S_2(N_4(i, z))|}{z} = \frac{2 \cdot N_4(i, z)}{z} = \frac{2 \cdot z \cdot B_4(i, z)}{z \cdot 2^i} = 2^{-i+1} B_4(i, z)$$

Lemma 6.1 *For $s \in \{4, 5\}$, $S_s(i, j)$ is an order- s Davenport-Schinzel sequence.*

Proof: We use brackets to indicate block boundaries in (forbidden) patterns, e.g., $[ba]ba$ is a pattern where the first ba appears in one block and the last ba appears outside that block. One can easily show by induction that $ba[ba] \not\prec S_s(i, j)$ and $[ba]ab \not\prec S_s(i, j)$ for all $s \in \{4, 5\}$, $i > 1$, $j \geq 1$. The base cases are trivial. When a is shuffled into the indicated block in a copy of $S_s(i, j - 1)$, all bs appear in that copy and all other as are shuffled into different copies, hence $[ba]$ cannot

be preceded by ba or followed by ab . This also implies that two symbols cannot both appear in two blocks of $S_s(i, j)$, for all $i > 1$. It follows that the patterns $ababab$ (and $abababa$) cannot be introduced into S_4 (and S_5) by the shuffling operation but must come from the composition (and 3-fold composition) operation. Suppose $ba \prec \beta$ for some block β in $S_4(i-1, y)$. It follows that composing β with $S_2(y)$ (a $baba$ -free sequence) does not introduce an $ababab$ pattern. (Substituting \underline{bab} for $ba \prec \beta$ and projecting onto $\{a, b\}$ yields sequences of the form $a^*b^*\underline{bab}b^*a^*$.)

Turning to S_5 , suppose $ab \prec \beta$ for some block β in S_{top} . If a and b are both middle symbols in β then, by the same argument, composing β with $S_{\text{mid}}^m = S_2(N_4(i, z))$ does not introduce an $ababab$ pattern much less an $abababa$ pattern. If both a, b are first then composing β with an order-4 DS sequence $S_{\text{mid}}^f = S_4(i, z)$ and projecting onto $\{a, b\}$ yields patterns of the form $\underline{a^*b^*}a^*b^*a^*a^*b^*$, where the underlined portion originated from β . The case when a and b are last is symmetric. The cases when a and b are of different types (first-middle, first-last, last-middle) are handled similarly. \square

We have shown that $\lambda_4(N_4(i, j), B_4(i, j)) \geq 2^i N_4(i, j)$ and $\lambda_5(N_5(i, j), B_5(i, j)) \geq ((2i-3)2^i + 4)N_5(i, j)$. Since any blocked sequence can be turned into a 2-sparse sequence by removing duplicates at block boundaries this also implies that $\lambda_4(N_4(i, j)) \geq 2^i N_4(i, j) - B_4(i, j) > (1 - 1/j)2^i N_4(i, j)$. Remember that all blocks in $S_4(i, j)$ have length exactly j . There is no such guarantee for S_5 , however. It is conceivable that it consists largely of long runs of identical symbols (each in a block of length 1), nearly *all* of which would be removed when converting it to a 2-sparse sequence. That is, statements of the form $\lambda_5(N_5(i, j)) \geq ((2i-3)2^i + 4)N_5(i, j) - B_5(i, j)$ become trivial if the $B_5(i, j)$ term dominates. Lemma 6.2 shows that for j sufficiently large this does not occur and therefore removing duplicates at block boundaries does not affect the length of $S_5(i, j)$ asymptotically.

Lemma 6.2 $N_5(i, j) \geq j \cdot B_5(i, j) / \xi(i)$, where $\xi(i) = 3^i 2^{\binom{i+1}{2}}$.

Proof: When $i = 1$ we have $N_5(1, j) = j \geq j \cdot B_5(1, j) / \xi(1) = 2j/6$. When $j = 1$ we have $N_5(i, 1) = 1 \geq B_5(i, 1) / \xi(i) = ((2i-3)2^i + 4) / 3^i 2^{\binom{i+1}{2}}$. Assuming the claim holds for all $(i', j') < (i, j)$ lexicographically,

$$\begin{aligned}
& N_5(i, j) \\
&= N_5(i-1, N_4(i, z)) + B_5(i-1, N_4(i, z)) \cdot (2 + 2^{-i+1})B_4(i, z) \cdot N_5(i, j-1) && \{\text{defn. of } N_5\} \\
&\geq N_5(i-1, N_4(i, z)) + \frac{1}{\xi(i)} B_5(i-1, N_4(i, z)) \cdot (2 + 2^{-i+1})B_4(i, z) \cdot (j-1)z && \{\text{ind., defn. of } z\} \\
&= N_5(i-1, N_4(i, z)) + \frac{j-1}{\xi(i)} B_5(i, j) && \{\text{defn. of } B_5\} \\
&\geq \frac{1}{\xi(i-1)} N_4(i, z) \cdot B_5(i-1, N_4(i, z)) + \frac{j-1}{\xi(i)} B_5(i, j) && \{\text{ind. hyp.}\} \\
&\geq \frac{1}{\xi(i-1) \cdot 2^i} \cdot z \cdot B_4(i, z) \cdot B_5(i-1, N_4(i, z)) + \frac{j-1}{\xi(i)} B_5(i, j) && \{N_4(i, z) = \frac{z}{2^i} B_4(i, z)\} \\
&\geq \frac{1}{\xi(i-1) \cdot 2^i \cdot 3} \cdot (2 + 2^{-i+1}) \cdot z \cdot B_4(i, z) \cdot B_5(i-1, N_4(i, z)) + \frac{j-1}{\xi(i)} B_5(i, j) && \{2 + 2^{-i+1} \leq 3\} \\
&= \frac{1}{\xi(i)} B_5(i, j) + \frac{j-1}{\xi(i)} B_5(i, j) = \frac{j}{\xi(i)} B_5(i, j) && \{\text{defn. of } B_5, \xi\}
\end{aligned}$$

\square

Theorem 6.3 For any n and m , $\lambda_5(n, m) = \Omega(n\alpha(n, m)2^{\alpha(n, m)})$ and $\lambda_5(n) = \Omega(n\alpha(n)2^{\alpha(n)})$.

Proof: Consider the sequence $S_5 = S_5(i, j)$, where $j \geq \xi(i)$, and let S'_5 be obtained by removing duplicates at block boundaries. It follows that S'_5 is 2-sparse and, from Lemma 6.2, that $|S'_5| \geq ((2i - 3)2^i + 3)N_5(i, j)$. It is straightforward to prove that $i = \alpha(N_5(i, j), B_5(i, j)) + O(1)$ and that $i = \alpha(N_5(i, j)) + O(1)$ when $j = \xi(i)$. \square

7 Upper Bounds on Fifth-Order Sequences

Recall from Section 4 that a derivation tree $\mathcal{T}(S)$ for a blocked sequence S is the composition of a global tree $\hat{\mathcal{T}} = \hat{\mathcal{T}}(\hat{S}')$ and local trees $\{\check{\mathcal{T}}_q\}_{q \leq \hat{m}}$, where $\check{\mathcal{T}}_q = \mathcal{T}(\check{S}_q)$. The composition is effected by identifying the q th leaf of $\hat{\mathcal{T}}$, call it x_q , with the root of $\check{\mathcal{T}}_q$, then populating the leaves of \mathcal{T} with the blocks of S .

7.1 Superimposed Derivation Trees

One can view $\mathcal{T}(S)$ as representing a hypothetical *process* for generating the sequence S , but it only represents this process at one granularity. For example, \hat{S}_q is the portion of \hat{S} at the leaf descendants of x_q in \mathcal{T} . The derivation tree \mathcal{T} does not let us inspect the structure of \hat{S}_q and provides no explanation for how \hat{S}_q came to be.

To reason about \hat{S}_q we could, of course, build a *new* derivation tree $\hat{\mathcal{T}}_q = \mathcal{T}(\hat{S}_q)$ just for \hat{S}_q . One can see that $\check{\mathcal{T}}_q$ and $\hat{\mathcal{T}}_q$ will be structurally identical if, in their inductive construction, we always choose block partitions in the same way. One can imagine *superimposing* $\hat{\mathcal{T}}_q$ onto $\check{\mathcal{T}}_q$, regarding both as being on the same node set but populated with different blocks.

In our actual analysis we do not consider the derivation tree for \hat{S}_q , which includes all global occurrences in S_q , but just those derivation trees for \acute{S}_q and \grave{S}_q , which are restricted to global symbols making their first and last appearance in S_q , respectively. Define $\acute{\mathcal{T}}[x_q] = \mathcal{T}(\acute{S}_q)$ and $\grave{\mathcal{T}}[x_q] = \mathcal{T}(\grave{S}_q)$ to be any derivation trees of \acute{S}_q and \grave{S}_q that are defined on the same node set as $\check{\mathcal{T}}_q$. Recall that x_q is the q th leaf of $\hat{\mathcal{T}}$.

One can think of the $\acute{\mathcal{T}}$ and $\grave{\mathcal{T}}$ derivation trees as filling in the gaps between wing nodes and quills. Suppose v were a leaf in some derivation tree \mathcal{T} whose block $\mathcal{B}(v)$ contains a symbol a . By definition $\text{qu}_{|a}(v)$ is a child of $\text{wi}_{|a}(v)$ in $\mathcal{T}_{|a}$. If v were a dove (or hawk) in $\mathcal{T}_{|a}$ then $\text{qu}_{|a}(v)$ would be identified with a leaf of $\acute{\mathcal{T}}[\text{wi}_{|a}(v)]$ (or a leaf of $\grave{\mathcal{T}}[\text{wi}_{|a}(v)]$) whose block contains a . However, *within* $\acute{\mathcal{T}}[\text{wi}_{|a}(v)]$ (or $\grave{\mathcal{T}}[\text{wi}_{|a}(v)]$), $\text{qu}_{|a}(v)$ could be a dove or hawk, feather or non-feather, wingtip or non-wingtip.

The new concept needed to tightly bound order-5 DS sequences is that of a *double-feather*. See Figure 7.

Definition 7.1 Let $\{\mathcal{T}\} \cup \{\acute{\mathcal{T}}[u], \grave{\mathcal{T}}[u]\}_{u \in \mathcal{T}}$ be a derivation tree ensemble. Let v be a dove leaf in \mathcal{T} for which $a \in \mathcal{B}(v)$, and let $\acute{\mathcal{T}} = \acute{\mathcal{T}}[\text{wi}_{|a}(v)]$. We call v a *double-feather* in $\mathcal{T}_{|a}$ if it is a feather (that is, it is the rightmost descendant of $\text{qu}_{|a}(v)$ in $\mathcal{T}_{|a}$) and $\text{qu}_{|a}(v)$ is either a dove feather or hawk wingtip in $\acute{\mathcal{T}}_{|a}$. The definition of double-feather is symmetric when v is a hawk, that is, we substitute $\grave{\mathcal{T}}$ for $\acute{\mathcal{T}}$ and swap the roles of left and right, dove and hawk.

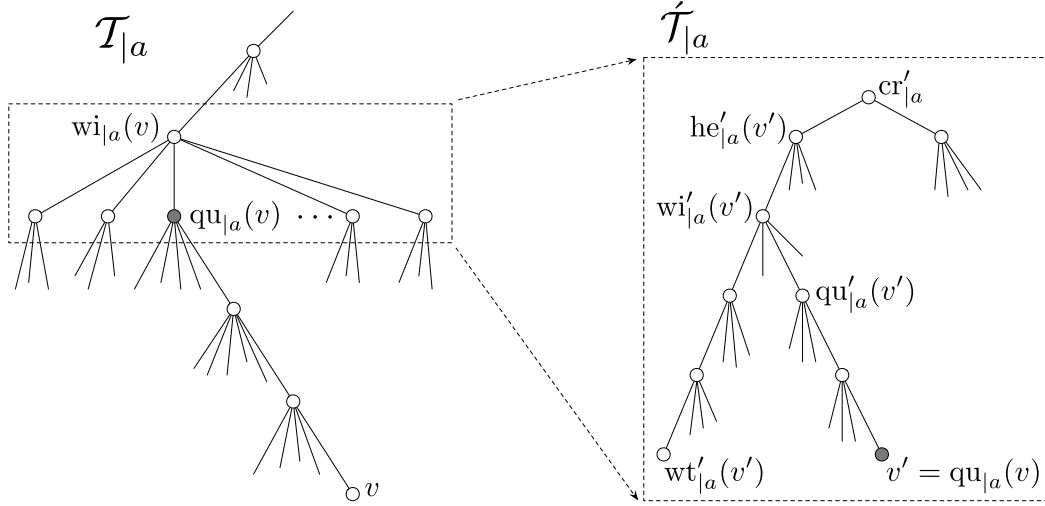

Figure 7: Left: a dove feather v in $\mathcal{T}|_a$. The quill and wing node of v are indicated. Right: the derivation tree $\hat{\mathcal{T}}|_a$ where $\hat{\mathcal{T}} = \hat{\mathcal{T}}[wi|_a(v)]$. Within $\hat{\mathcal{T}}|_a$ the leaf $v' = qu|_a(v)$ has its own wing node $wi'_a(v')$, quill $qu'_a(v')$, and so on. By virtue of v' being a dove feather in $\hat{\mathcal{T}}|_a$, v is a double-feather in $\mathcal{T}|_a$.

As with the term *feather*, *double-feather* is used to refer to leaf nodes in some derivation tree $\mathcal{T}|_a$ and the corresponding occurrences of a in the underlying sequence S . Lemma 7.2 is a more refined version of Lemma 4.3.

Lemma 7.2 *Let $\{\mathcal{T}\} \cup \{\hat{\mathcal{T}}[u], \check{\mathcal{T}}[u]\}_{u \in \mathcal{T}}$ be a derivation tree ensemble for some sequence S . Suppose that $v \in \mathcal{T}$ is a leaf and a, b are symbols in a block $\mathcal{B}(v)$ of S . If the following three criteria are satisfied then a and b are nested in $\mathcal{B}(v)$.*

- i. v is not a wingtip in either $\mathcal{T}|_a$ or $\mathcal{T}|_b$.
- ii. v is not a double-feather in either $\mathcal{T}|_a$ or $\mathcal{T}|_b$.
- iii. v is a dove in both $\mathcal{T}|_a$ and $\mathcal{T}|_b$ or a hawk in both $\mathcal{T}|_a$ and $\mathcal{T}|_b$.

Proof: We assume the claim is false, that a and b are interleaved in $\mathcal{B}(v)$. Without loss of generality, we can assume the following additional criteria.

- iv. $cr|_b$ is equal to or strictly ancestral to $cr|_a$.
- v. v is a dove in both $\mathcal{T}|_a$ and $\mathcal{T}|_b$.
- vi. \mathcal{T} is the smallest derivation tree for which Criteria (i–v) hold and where a and b are interleaved in $\mathcal{B}(v)$.

By Criterion (v) the leftmost descendent of $wi|_a(v)$ in $\mathcal{T}|_a$ is $wt|_a(v)$. Let u be its rightmost descendant. Criteria (i,ii) imply that

- vii. $v, wt|_a(v)$, and u are distinct nodes.

Criterion (i) states that v is distinct from $\text{wt}_{|a}(v)$. Consider the derivation tree $\hat{\mathcal{T}} = \hat{\mathcal{T}}[\text{wi}_{|a}(v)]$. The node u is the rightmost descendant (in \mathcal{T}_a) of the hawk wingtip of $\hat{\mathcal{T}}_{|a}$. It is therefore a double-feather, and distinct from v , by Criterion (ii).

Partition the sequence outside of $\mathcal{B}(v)$ into four intervals, namely I_1 : everything preceding the a in $\mathcal{B}(\text{wt}_{|a}(v))$, I_2 : everything from the end of I_1 to $\mathcal{B}(v)$, I_3 : everything from $\mathcal{B}(v)$ to the a in $\mathcal{B}(u)$, and I_4 : everything following I_3 . If a and b are not nested in $\mathcal{B}(v)$ then all remaining bs lie exclusively in I_1 and I_3 or exclusively in I_2 and I_4 . We claim

viii. I_1 and I_3 contain no occurrences of b .

If the contrary were true, that all occurrences of b outside $\mathcal{B}(v)$ were in I_1 and I_3 , then I_3 would contain $\text{rwt}_{|b}$, which is distinct from v according to Criterion (i). By Criterion (iv) $\text{cr}_{|b}$ is ancestral to $\text{cr}_{|a}$, which is strictly ancestral to $\text{wi}_{|a}(v)$, which is ancestral to both v and $\text{rwt}_{|b}$. This implies that v and $\text{rwt}_{|b}$ descend from the same child of $\text{cr}_{|b}$, namely, $\text{rhe}_{|b}$, which violates Criterion (v). Thus, $\text{wt}_{|b}(v)$ is the dove wingtip in \mathcal{T}_b and lies in interval I_2 .

Define $v' = \text{qu}_{|b}(v)$ to be v 's quill in \mathcal{T}_b . It is not necessarily the case that v' is distinct from v , though we can claim that

ix. v' is a strict descendant of $\text{wi}_{|a}(v)$ and $v = \text{fe}_{|b}(v)$ is a feather.

By definition quills are not wing nodes, so v' cannot be ancestral to $\text{wt}_{|b}(v)$. However, if v' were ancestral to $\text{wi}_{|a}(v)$ it would be ancestral to $\text{wt}_{|b}(v)$ as well, a contradiction. If v were distinct from $\text{fe}_{|b}(v)$, that is, if v were not the rightmost descendant of v' in \mathcal{T}_b , then $\text{fe}_{|b}(v)$ must, by Inference (viii), lie in interval I_4 . Since $\overline{\text{wt}}_{|a}(v)$ is not a descendant of $\text{wi}_{|a}(v)$ it must lie to the right of $\text{fe}_{|b}(v)$ in I_4 . However, this arrangement of nodes (namely $\text{wt}_{|a}(v)$, $\text{wt}_{|b}(v)$, v , $\text{fe}_{|b}(v)$, $\overline{\text{wt}}_{|a}(v)$, where $\text{wt}_{|a}(v)$ and $\text{wt}_{|b}(v)$ may be equal) shows that a and b are nested in $\mathcal{B}(v)$, hence $v = \text{fe}_{|b}(v)$ is a feather.

From Criterion (vi), Inference (ix), and Lemma 4.2 we shall infer that

x. $v = v'$.

Suppose $v \neq v'$. Lemma 4.2 implies that $a \in \mathcal{B}(v')$, as witnessed by the nodes $v, v', \text{cr}_{|a}, \text{cr}_{|b}$ on a leaf-to-root path. This means that somewhere in the inductive construction of \mathcal{T} we encountered a derivation tree \mathcal{T}^0 containing both $\text{cr}_{|a}$ and $\text{cr}_{|b}$, whose leaves are at the level of v' . However, \mathcal{T}^0 and v' satisfy the conditions of the lemma, namely $a, b \in \mathcal{B}(v')$ and v' is neither a wingtip nor double-feather nor hawk in both \mathcal{T}_a^0 and \mathcal{T}_b^0 . Since \mathcal{T}^0 is smaller than \mathcal{T} , Criterion (vi) implies that a and b are nested in $\mathcal{B}(v')$ with respect to \mathcal{T}^0 , which then implies that they are nested in $\mathcal{B}(v)$ with respect to \mathcal{T} as well. This contradicts the hypothesis that a and b are interleaved in $\mathcal{B}(v)$.

By definition v' is the child of $\text{wi}_{|b}(v)$ in \mathcal{T}_b but we have yet to deduce where $\text{wi}_{|b}(v)$ is relative to other nodes.

xi. $\text{wi}_{|b}(v)$ is ancestral to $\text{cr}_{|a}$.

Criterion (i) and Inference (viii) imply that some b appears in interval I_4 . All such bs must appear after $\overline{\text{wt}}_{|a}(v)$ for otherwise a and b would be nested in $\mathcal{B}(v)$. By Criterion (ii) v cannot be the rightmost descendant of $\text{wi}_{|b}(v)$, which is a double-feather. Thus, the rightmost descendant of $\text{wi}_{|b}(v)$ appears after the a in $\overline{\text{wt}}_{|a}(v)$, implying that $\text{wi}_{|b}(v)$ is ancestral to $\text{cr}_{|a}$.

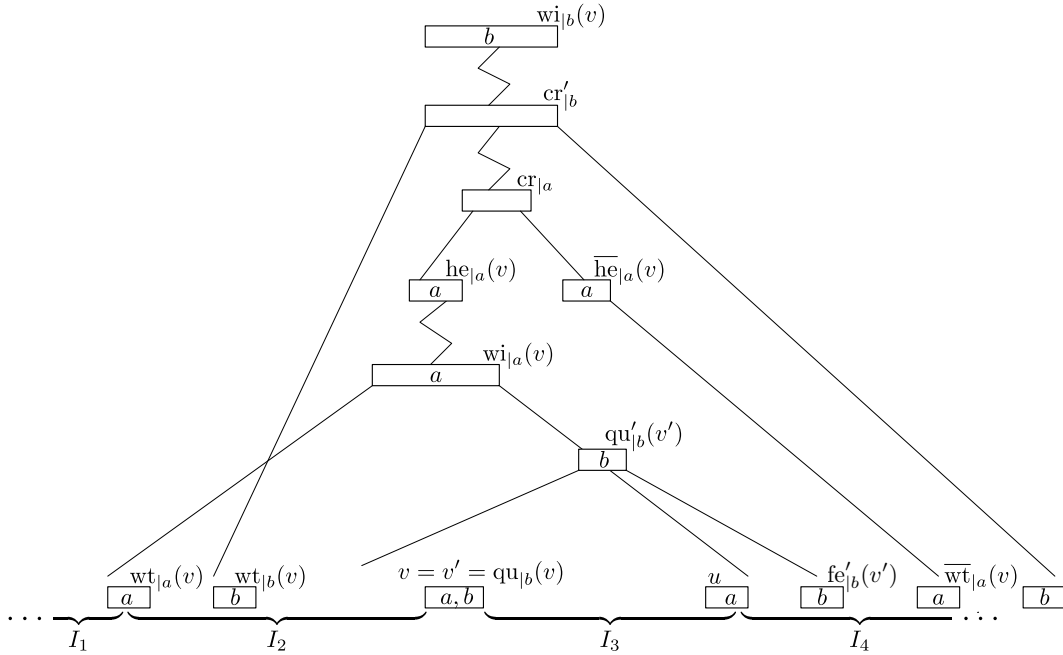

Figure 8: Here $v' = \text{qu}|_b(v)$ is v 's quill in $\mathcal{T}|_b$, and therefore a leaf of $\acute{\mathcal{T}} = \acute{\mathcal{T}}[\text{wi}|_b(v)]$. The tree $\acute{\mathcal{T}}|_b$ is rooted at the crown $\text{cr}'|_b$. Looking within $\acute{\mathcal{T}}|_b$, v' has its own quill $\text{qu}'|_b(v')$ and feather $\text{fe}'|_b(v')$. Since $\acute{\mathcal{T}}$ is topologically identical to a corresponding subtree of \mathcal{T} , we can talk sensibly about nodes in one tree being ancestral to nodes in the other. For example, it is deduced that $\text{cr}'|_b$ (in $\acute{\mathcal{T}}$) is ancestral to $\text{cr}|_a$ (in \mathcal{T}) and that $\text{wi}|_a(v)$ (in \mathcal{T}) is a strict ancestor of $\text{qu}'|_b(v')$ (in $\acute{\mathcal{T}}$).

Consider the derivation tree $\hat{\mathcal{T}} = \hat{\mathcal{T}}[\text{wi}_b(v)]$, the leaf-level of which coincides with the leaf-level of \mathcal{T} since $\text{qu}_b(v) = v' = v$. Let cr'_b be b 's crown in $\hat{\mathcal{T}}_b$, and let $\text{qu}'_b(v')$ and $\text{fe}'_b(v')$ be the quill and feather of v' in $\hat{\mathcal{T}}_b$.¹⁸ We deduce the following variants of Criteria (iv,v) and Inference (ix).

xii. cr'_b is ancestral to cr_a .

xiii. v' is a dove in $\hat{\mathcal{T}}_b$.

xiv. $\text{qu}'_b(v')$ is a strict descendant of $\text{wi}_a(v)$ and strict ancestor of u . Furthermore, $\text{fe}'_b(v')$ lies between u and $\overline{\text{wt}}_a(v)$.

Inference (xii) is just a restatement of Inference (xi) since all b s descending from $\text{wi}_b(v)$ are also descendants of cr'_b .¹⁹ Inference (xiii) follows from the fact that $\text{wt}_b(v)$ is also the dove wingtip in $\hat{\mathcal{T}}_b$ and that the least common ancestor of $\text{wt}_b(v)$ and v is a descendant of $\text{wi}_a(v)$ and therefore a strict descendant of cr'_b . We now turn to Inference (xiv). By Inference (xiii) the quill $\text{qu}'_b(v')$ must be an ancestor of v' but not $\text{wt}_b(v)$, so it must be a strict descendant of $\text{wi}_a(v)$. If v' were the rightmost descendant of $\text{qu}'_b(v')$ in $\hat{\mathcal{T}}_b$, then $v' = \text{fe}'_b(v')$ and v would be a double-feather in \mathcal{T} , contrary to Criterion (ii). Since I_3 is b -free, it must be that $\text{qu}'_b(v')$ is a strict descendant of $\text{wi}_a(v)$, a strict ancestor of u , and that $\text{fe}'_b(v')$ lies between u and $\overline{\text{wt}}_a(v)$. The blocks $\text{wt}_a(v)$, $\text{wt}_b(v)$, v , $\text{fe}'_b(v')$, and $\overline{\text{wt}}_a(v)$ certify that a and b are nested in $\mathcal{B}(v)$, a contradicting the hypothesis that they are not. \square

Remark 7.3 *Whereas Lemma 4.3 implicitly partitioned occurrences of global symbols into four categories: dove wingtips, hawk wingtips, feathers, and all remaining non-feathers, Lemma 7.2 further distinguishes dove non-feathers and hawk non-feathers. The reason for this is rather technical. If Criterion (iii) were dropped and v were a dove in \mathcal{T}_a and a hawk in \mathcal{T}_b , we could deduce that $\text{qu}'_b(v')$ is a strict descendant of $\text{wi}_a(v)$ and strict ancestor of $\text{wt}_a(v)$. However, we could not deduce that $a \in \mathcal{B}(\text{qu}'_b(v'))$ (that is, $\text{qu}'_b(v')$'s block in \mathcal{T}) since Lemma 4.2 only applies to symbols and blocks that exist in the same derivation tree. Note that $\hat{\mathcal{T}}[\text{wi}_b(v)]$ can be regarded as being superimposed on the subtree of \mathcal{T} rooted at $\text{wi}_b(v)$, but they are not identical derivation trees.*

As in Section 4 it is useful to define and reason about optimal derivation trees. For technical reasons it is convenient to only permit uniform block partitions with widths that are powers of two.

Definition 7.4 (Permissible block partitions) *Let S be a blocked sequence and $m = \llbracket S \rrbracket$ be its block count. A block partition $\{m_q\}_{1 \leq q \leq \hat{m}}$ is permissible if $m_q = 2^r$ for all $q < \hat{m}$, where $\hat{m} = \lceil m/2^r \rceil$ and $r \geq 1$ is an integer. A derivation tree $\mathcal{T}(S)$ is permissible if it was defined using only permissible block partitions.*

Note that if \mathcal{T}_0 and \mathcal{T}_1 are two permissible derivation trees for some sequence with m blocks, they must have exactly the same structure, though their nodes may be populated with different blocks. In particular, both are binary trees with height $\lceil \log m \rceil$, where one-child nodes may only exist on the rightmost root-to-leaf path if m is not a power of 2.

¹⁸Observe that $\text{qu}'_b(v')$ lies strictly between $v' = \text{qu}_b(v)$ and $\text{wi}_b(v)$ in \mathcal{T} , so its block contains b only with respect to $\hat{\mathcal{T}}$, not \mathcal{T} . In contrast, b appears in $\text{fe}'_b(v')$'s block in both \mathcal{T} and $\hat{\mathcal{T}}$.

¹⁹The assertion that cr'_b is ancestral to cr_a is only well defined if $\hat{\mathcal{T}}[\text{wi}_b(v)]$ can be regarded as a subtree of \mathcal{T} but populated with different blocks. This is why we do not permit corresponding derivation trees to have different structure.

7.2 Recurrences for Fifth-Order Sequences

Lemma 7.2 provides us with new criteria for nestedness. In order to write a new recurrence for λ_5 we need to know how many double-feathers an order-5 DS sequence can have, which depends on the number of dove and hawk feathers in an order-4 DS sequence.

Definition 7.5 (Optimal derivation trees)

- When S is an order-4 DS sequence let $\mathcal{T}^*(S)$ denote the permissible derivation tree that minimizes the number of feathers of a given type (dove or hawk). When S is an order-5 DS sequence let $\mathcal{E}^*(S) = \{\mathcal{T}^*(S)\} \cup \{\hat{\mathcal{T}}^*[u], \check{\mathcal{T}}^*[u]\}_{u \in \mathcal{T}^*(S)}$ denote the ensemble of permissible derivation trees that minimize the number of double-feathers in S .
- Define $\Phi'(n, m)$ to be the maximum number of feathers of one type (dove or hawk) in an order-4 DS sequence S with respect to $\mathcal{T}^*(S)$, where $\|S\| = n$ and $\llbracket S \rrbracket = m$.
- Define $\Phi''(n, m)$ to be the maximum number of double-feathers (of both types) in an order-5 DS sequence with respect to the ensemble $\mathcal{E}^*(S)$.

Recurrence 7.6 Let m and n be the block count and alphabet size. For any permissible block partition $\{m_q\}_{1 \leq q \leq \hat{m}}$ and any alphabet partition $\{\hat{n}\} \cup \{\check{n}_q\}_{1 \leq q \leq \hat{m}}$, we have

$$\begin{aligned} \Phi'(n, m) &= \Phi''(n, m) = 0 && \text{when } m \leq 2 \\ \Phi'(n, m) &\leq \sum_{q=1}^{\hat{m}} \Phi'(\check{n}_q, m_q) + \Phi'(\hat{n}, \hat{m}) + \lambda_3(\hat{n}, m) - \hat{n} \\ \Phi''(n, m) &\leq \sum_{q=1}^{\hat{m}} \Phi''(\check{n}_q, m_q) + \Phi''(\hat{n}, \hat{m}) + 2(\Phi'(\hat{n}, m) + \hat{n}) \end{aligned}$$

Proof: Consider an order-4 DS sequence S . Let $\hat{\mathcal{T}}^*$ and $\{\check{\mathcal{T}}_q^*\}_q$ be the optimal derivation trees of the global sequence \hat{S}' and local sequences $\{\check{S}_q\}$, and let \mathcal{T} be their composition. The number of dove feathers of local symbols is at most $\sum_q \Phi'(\check{n}_q, m_q)$. Every global dove feather in \hat{S} is either (i) the rightmost child of a dove feather in \hat{S}' , or (ii) a child of a left wingtip in \hat{S}' , excluding the leftmost such child, which is also a left wingtip in \hat{S} . Category (i) is counted by $\Phi'(\hat{n}, \hat{m})$ and Category (ii) is counted by $\lambda_3(\hat{n}, m) - \hat{n}$ since \hat{S} (the children of dove wingtips) is an order-3 DS sequence over an \hat{n} -letter alphabet. A symmetric analysis applies to hawk feathers, reversing the roles of left and right.

The analysis of $\Phi''(n, m)$ when S is an order-5 sequence is similar. After the block partition is selected, construct the optimal derivation tree ensemble $\mathcal{E}^*(\hat{S}') = \{\hat{\mathcal{T}}^*\} \cup \{\hat{\mathcal{T}}^*[u], \check{\mathcal{T}}^*[u]\}_{u \in \hat{\mathcal{T}}^*}$ for \hat{S}' and, separately, the optimal derivation tree ensemble $\mathcal{E}_q^*(\check{S}_q) = \{\check{\mathcal{T}}_q^*\} \cup \{\check{\mathcal{T}}_q^*[u], \hat{\mathcal{T}}_q^*[u]\}_{u \in \check{\mathcal{T}}_q^*}$ for each \check{S}_q separately. These ensembles are composed to form $\mathcal{E}(S) = \{\mathcal{T}\} \cup \{\hat{\mathcal{T}}^*[u], \check{\mathcal{T}}^*[u]\}_{u \in \mathcal{T}}$ in the obvious way. As usual, $\mathcal{T} = \mathcal{T}(S)$ is the composition of $\hat{\mathcal{T}}^*$ and the $\{\check{\mathcal{T}}_q^*\}$. The only nodes $u \in \mathcal{T}$ whose derivation trees $\hat{\mathcal{T}}^*[u]$ and $\check{\mathcal{T}}^*[u]$ are not well defined (that is, they are not already included in $\mathcal{E}^*(\hat{S}')$ or the $\{\mathcal{E}^*(\check{S}_q)\}$) are those at the leaf level of $\hat{\mathcal{T}}^*$ in \mathcal{T} . Define $\hat{\mathcal{T}}^*[x_q]$ and $\check{\mathcal{T}}^*[x_q]$ to be the optimal derivation trees for \hat{S}_q and \check{S}_q , respectively.

Now let us argue that the recurrence correctly bounds the number of double-feathers in S with respect to $\mathcal{E}(S)$. The summation $\sum_q \Phi''(\check{n}_q, m_q)$ counts double-feathers of local symbols. Every occurrence of a global double-feather in S is either (i) the rightmost child of a dove double-feather in \hat{S}' or the leftmost child of a hawk double-feather in \hat{S}' (with respect to $\mathcal{E}^*(\hat{S}')$), (ii) a dove feather in \hat{S}'_q or hawk feather in \check{S}'_q , for some q , with respect to $\hat{T}^*[x_q]$ or $\check{T}^*[x_q]$, or (iii) a hawk wingtip in \hat{S} or a dove wingtip in \check{S} . Category (i) is counted by $\Phi''(\hat{n}, \hat{m})$, Category (ii) by $\sum_q [\Phi'(\hat{n}_q, m_q) + \Phi'(\check{n}_q, m_q)] \leq 2 \cdot \Phi'(\hat{n}, m)$, and Category (iii) by $2\hat{n}$. \square

Recurrence 7.7 *Let m and n be the block count and alphabet size parameters. For any permissible block partition $\{m_q\}_{1 \leq q \leq \hat{m}}$ and alphabet partition $\{\hat{n}\} \cup \{\check{n}_q\}_{1 \leq q \leq \hat{m}}$,*

$$\lambda_5(n, m) \leq \sum_{q=1}^{\hat{m}} \lambda_5(\check{n}_q, m_q) + 2 \cdot \lambda_4(\hat{n}, m) + \lambda_3(\Phi''(\hat{n}, \hat{m}), m) + \lambda_2(\lambda_5(\hat{n}, \hat{m}), 2m - 1)$$

Proof: We adopt the usual notation for an order-5 sequence S with the following additions and modifications. Let \tilde{S}', \dot{S}' , and \ddot{S}' be the subsequences of \hat{S}' consisting of, respectively, double-feathers, non-double-feather doves, and non-double-feather hawks, all of which exclude wingtips, and let \tilde{S}, \dot{S} , and \ddot{S} be the subsequences of \hat{S} made up of their children. Recall that \dot{S} and \ddot{S} are the children of dove and hawk wingtips in \hat{S}' .

The contribution of local symbols to $|S|$ is bounded by $\sum_q \lambda_5(\check{n}_q, m_q)$. The global sequence \hat{S} is the union of five subsequences $\dot{S}, \check{S}, \tilde{S}, \dot{S}$, and \ddot{S} . Both \dot{S} and \check{S} are order-4 sequences, so $|\dot{S}| + |\check{S}| \leq 2 \cdot \lambda_4(\hat{n}, m)$. Since double-feathers are all middle occurrences in \hat{S}' , \tilde{S} is obtained by substituting for each block in \tilde{S}' an order-3 DS sequence, so $|\tilde{S}| \leq \lambda_3(|\tilde{S}'|, m) \leq \lambda_3(\Phi''(\hat{n}, \hat{m}), m)$.

According to Lemma 7.2, the blocks of \dot{S}' consist of *mutually* nested symbols. The argument from Recurrence 5.2 shows that \dot{S} is obtained by substituting an order-2 sequence for each block in \dot{S}' . The same is true for \ddot{S} as well, so

$$\begin{aligned} |\dot{S}| + |\ddot{S}| &\leq \lambda_2(|\dot{S}'|, m) + \lambda_2(|\ddot{S}'|, m) \\ &\leq \lambda_2(|\dot{S}'| + |\ddot{S}'|, 2m - 1) && \{\text{superadditivity of } \lambda_2\} \\ &< \lambda_2(|\hat{S}'|, 2m - 1) \\ &\leq \lambda_2(\lambda_5(\hat{n}, \hat{m}), 2m - 1) \end{aligned}$$

The last inequalities follow from fact that \dot{S}' and \ddot{S}' are disjoint subsequences of \hat{S}' , which is an order-5 DS sequence. \square

Recurrences 7.6 and 7.7 allow us to find closed-form bounds on the number of feathers and double-feathers, and on the length of order-5 DS sequences. Refer to Appendix C for proof of Lemma 7.8.

Lemma 7.8 *Let n and m be the alphabet size and block count. After a parameter $i \geq 1$ is chosen let $j \geq 1$ be minimum such that $m \leq a_{i,j}^c$, where $c = 3$ is fixed. We have the following upper bounds on $\Phi'(n, m)$, $\Phi''(n, m)$, and $\lambda_5(n, m)$.*

$$\begin{aligned}
\Phi'(n, m) &\leq \nu'_i(n + (cj)^2(m-1)) && \text{where } \nu'_i = 3\binom{i+1}{2} + 3 \\
\Phi''(n, m) &\leq \nu''_i(n + (cj)^3(m-1)) && \text{where } \nu''_i = 6\binom{i+2}{3} + 8i \\
\lambda_5(n, m) &\leq \mu_{5,i}(n + (cj)^3(m-1)) && \text{where } \mu_{5,i} = i2^{i+7}
\end{aligned}$$

7.3 Blocked versus 2-Sparse Order-5 Sequences

Lemma 7.8 states that for any i , $\lambda_5(n, m) < \mu_{5,i}(n + (3j_i)^3 m)$ where j_i is minimum such that $m \leq a_{i,j_i}^3$. Choose $\iota \geq 1$ be minimum such that $(3j_\iota)^3 \leq \max\{\frac{n}{m}, (3 \cdot 3)^3\}$. One can show that $\iota = \alpha(n, m) + O(1)$, implying that $\lambda_5(n, m) = O((n+m)\mu_{5,\iota}) = O((n+m)\alpha(n, m)2^{\alpha(n,m)})$, matching the construction from Section 6. According to Lemma 3.1(2,4) $\lambda_5(n) = O(\alpha(\alpha(n))) \cdot \lambda_5(n, 3n-1)$. In this Section we present a more efficient reduction from 2-sparse, order-5 DS sequences to blocked order-5 sequences, thereby removing the extra $\alpha(\alpha(n))$ factor.

Theorem 7.9 $\lambda_5(n) = O(n\alpha(n)2^{\alpha(n)})$ and $\lambda_5(n, m) = m + O(n\alpha(n, m)2^{\alpha(n,m)})$.

Proof: The second bound is asymptotically the same as $O((n+m)\alpha(n, m)2^{\alpha(n,m)})$ if $m = O(n)$. If not, we remove up to $m-1$ repeated symbols at block boundaries, yielding a 2-sparse, order-5 DS sequence. Our remaining task is therefore to prove that $\lambda_5(n) = O(n\alpha(n)2^{\alpha(n)})$.

Let S be a 2-sparse, order-5 DS sequence with $\|S\| = n$. Greedily partition S into maximal order-3 DS sequences $S_1 S_2 \cdots S_m$. According to Sharir's argument [73], $m \leq 2n-1$. See the proof of Lemma 3.1(2) in Appendix A. As usual, let $\tilde{S}, \hat{S} \prec S$ be the subsequences of local and global symbols, and let \hat{S}' be derived by contracting each interval to a single block. The number of global symbols is $\hat{n} = \|\hat{S}'\|$. In contrast to the situations we considered earlier, \tilde{S} and \hat{S} are *neither* 2-sparse nor partitioned into blocks.

Let $\mathcal{E}^*(\hat{S}') = \{\mathcal{T}^*(\hat{S}')\} \cup \{\hat{\mathcal{T}}^*[u], \check{\mathcal{T}}^*[u]\}_{u \in \mathcal{T}^*(\hat{S}')}$ be the optimal derivation tree ensemble for \hat{S}' . This ensemble categorizes all occurrences in \hat{S}' as (i) double-feathers, (ii) non-double-feather doves, (iii) non-double-feather hawks, (iv) dove wingtips, or (v) hawk wingtips. Furthermore, occurrences in \hat{S} inherit the category of their corresponding occurrence in \hat{S}' . Let $\tilde{S}', \dot{S}', \check{S}'$ be the subsequences of \hat{S}' in categories (i-iii) and let $\tilde{S}, \dot{S}, \check{S}, \acute{S}, \grave{S}$ be the subsequences of \hat{S} in categories (i-v), none of which are necessarily 2-sparse. Define $\tilde{S}^*, \dot{S}^*, \check{S}^*, \acute{S}^*, \grave{S}^*$ to be their maximal length 2-sparse subsequences, and define \check{S}^* to be the maximal length 2-sparse subsequence of \check{S} .

Lemma 3.1(2) and the arguments from Recurrence 7.7 imply that

$$|\tilde{S}^*| + |\dot{S}^*| + |\check{S}^*| + |\acute{S}^*| + |\grave{S}^*| \leq \lambda_3(\varphi, 2\varphi - 1) + 2 \cdot \lambda_5(\hat{n}, 2\hat{n} - 1) + 4 \cdot \lambda_4(\hat{n}, 2\hat{n} - 1) \quad (5)$$

$$\text{where } \varphi = \Phi''(\hat{n}, 2\hat{n} - 1)$$

The sequence \tilde{S}^* is obtained by substituting for each block in \tilde{S}' a 2-sparse, order-3 DS sequence. Since $|\tilde{S}^*| \leq \varphi$, by the superadditivity of λ_3 we have $|\tilde{S}^*| \leq \lambda_3(\varphi)$, which is at most $\lambda_3(\varphi, 2\varphi - 1)$ by Lemma 3.1(2). By the same reasoning, $|\acute{S}^*|$ and $|\grave{S}^*|$ are each at most $\lambda_4(\hat{n}) \leq 2 \cdot \lambda_4(\hat{n}, 2\hat{n} - 1)$ and $|\dot{S}^*| + |\check{S}^*| \leq \lambda_2(|\dot{S}'| + |\check{S}'|) < \lambda_2(|\hat{S}'|) < 2 \cdot \lambda_5(\hat{n}, 2\hat{n} - 1)$. We can also conclude that $|\check{S}^*| \leq \lambda_3(n - \hat{n}) \leq \lambda_3(n - \hat{n}, 2(n - \hat{n}) - 1)$.

In bounding various sequences above, the second argument of λ_s and Φ'' is never more than $2 \cdot \varphi$. Choose ι to be minimal such that $2 \cdot \varphi \leq a_{\iota,3}^3$, so $j = 3$ will be constant whenever we invoke Lemmas 5.3 and 7.8 with $s \leq 5$ and $c = 3$. It is straightforward to show that $\iota = \alpha(n) + O(1)$.

Observe that S can be constructed by shuffling its six non-2-sparse constituent subsequences $\tilde{S}, \dot{S}, \ddot{S}, \acute{S}, \grave{S}, \check{S}$ in some fashion that restores 2-sparseness. In other words, there is a 1-1 map between positions in S and positions in its six constituents, and a surjective map ψ from positions in S to positions in its 2-sparse constituents $\tilde{S}^*, \dot{S}^*, \ddot{S}^*, \acute{S}^*, \grave{S}^*, \check{S}^*$. Partition S into intervals $T_1 T_2 \cdots T_{\lceil |S|/h \rceil}$, each with length $h = \lceil \frac{\lambda_5(6)+1}{2} \rceil = O(1)$. The image of ψ on two consecutive intervals T_{p-1} and T_p (where $p < \lceil |S|/h \rceil$) cannot be identical, for otherwise $T_{p-1} T_p$ would be a 2-sparse, order-5 DS sequence with length $2h > \lambda_5(6)$ over a 6-letter alphabet, a contradiction. Therefore,

$$\begin{aligned} |S| &\leq h \cdot (|\check{S}^*| + |\tilde{S}^*| + |\dot{S}^*| + |\ddot{S}^*| + |\acute{S}^*| + |\grave{S}^*|) \\ &= h \cdot n \cdot O(\mu_{3,\iota} + \mu_{3,\iota} \nu''_\iota + \mu_{5,\iota} + \mu_{4,\iota}) \\ &= O(n \iota^{2^\iota}) \quad \{\text{Since } \mu_{3,\iota} = O(\iota), \nu''_\iota = O(\iota^3), \mu_{4,\iota} = O(2^\iota), \text{ and } \mu_{5,\iota} = O(\iota 2^\iota)\} \\ &= O(n \alpha(n) 2^{\alpha(n)}). \end{aligned}$$

□

8 Discussion and Open Problems

Davenport-Schinzel sequences have been applied almost exclusively to problems in combinatorial and computational geometry, with only a smattering of applications in other areas. For example, see [72, 9, 65, 66]. One explanation for this, which is undoubtedly true, is that there is a natural fit between geometric objects and their characterizations in terms of forbidden substructures.²⁰ An equally compelling explanation, in our opinion, is that DS sequences are simply underpublicized, and that the broader algorithms community is not used to analyzing algorithms and data structures with forbidden substructure arguments. We are optimistic that with increased awareness of DS sequences and their generalizations (e.g., forbidden 0-1 matrices) the *forbidden substructure method* [66] will become a standard tool in every algorithms researcher's toolbox.

Our bounds on Davenport-Schinzel sequences are sharp for every order s , leaving little room for improvement.²¹ However, there are many open problems on the geometric realizability of DS sequences and on various generalizations of DS sequences. The most significant realizability result is due to Wiernik and Sharir [86], who proved that the lower envelope of n line segments (that is, n linear functions, each defined over a different interval) has complexity $\Theta(\lambda_3(n)) = \Theta(n \alpha(n))$. It is an open question whether this result can be generalized to degree- s polynomials or polynomial segments. In particular, it may be that the lower envelope of any set of n degree- s polynomials has complexity $O(n)$, where s only influences the leading constant. Although our results do not address problems of geometric realizability, we suspect that modeling lower envelopes by derivation trees (rather than just sequences) will open up a new line of attack on these fundamental realizability problems.

²⁰E.g., in general position two lines do not share two points, three spheres do not share three points, degree- d polynomials do not have $d + 1$ zeros, and so on.

²¹That is, they cannot be expressed more tightly using a generic inverse-Ackermann function $\alpha(n)$. See Remark 1.1.

There are several challenging open problems in the realm of *generalized* Davenport-Schinzel sequences, the foremost one being to characterize the set of all linear forbidden subsequences: those σ for which $\text{Ex}(\sigma, n) = O(n)$ [52, 68]. Linear forbidden subsequences and minimally nonlinear ones were exhibited by Adamec, Klazar, and Valtr [2], Klazar and Valtr [53], and Pettie [70, 68, 67, 69]. It is also an open problem to characterize minimally non-linear forbidden 0-1 matrices [36]. Though far from being solved, there has been significant progress on this problem in the last decade [60, 81, 35, 38, 67, 68].

References

- [1] M. A. Abam, M. de Berg, and J. Gudmundsson. A simple and efficient kinetic spanner. *Comput. Geom.*, 43(3):251–256, 2010.
- [2] R. Adamec, M. Klazar, and P. Valtr. Generalized Davenport-Schinzel sequences with linear upper bound. *Discrete Math.*, 108(1-3):219–229, 1992.
- [3] P. Agarwal and M. Sharir. The number of congruent simplices in a point set. *Discrete & Computational Geometry*, 28:123–150, 2002.
- [4] P. Agarwal, M. Sharir, and P. Shor. Sharp upper and lower bounds on the length of general Davenport-Schinzel sequences. *J. Combin. Theory Ser. A*, 52:228–274, 1989.
- [5] P. K. Agarwal, H. Kaplan, and M. Sharir. Kinetic and dynamic data structures for closest pair and all nearest neighbors. *ACM Transactions on Algorithms*, 5(1), 2008.
- [6] G. Albers, L. J. Guibas, J. S. B. Mitchell, and T. Roos. Voronoi diagrams of moving points. *Int. J. Comput. Geometry Appl.*, 8(3):365–380, 1998.
- [7] A. Alon and B. Schieber. Optimal preprocessing for answering on-line product queries. Technical Report TR-71/87, Institute of Computer Science, Tel Aviv University, 1987.
- [8] N. Alon, H. Kaplan, G. Nivasch, M. Sharir, and S. Smorodinsky. Weak ϵ -nets and interval chains. *J. ACM*, 55(6), 2008.
- [9] S. Alstrup, P. W. Lauridsen, P. Sommerlund, and M. Thorup. Finding cores of limited length. In *Proceedings 5th International Workshop on Algorithms and Data Structures (WADS)*, pages 45–54, 1997.
- [10] H. Aonuma, H. Imai, K. Imai, and T. Tokuyama. Maximin location of convex objects in a polygon and related dynamic voronoi diagrams. In *Symposium on Computational Geometry*, pages 225–234, 1990.
- [11] B. Aronov, K. Buchin, M. Buchin, B. M. P. Jansen, T. de Jong, M. J. van Kreveld, M. Löffler, J. Luo, R. I. Silveira, and B. Speckmann. Connect the dot: Computing feed-links for network extension. *J. Spatial Information Science*, 3(1):3–31, 2011.
- [12] B. Aronov and M. de Berg. Unions of fat convex polytopes have short skeletons. *Discrete & Computational Geometry*, 48(1):53–64, 2012.

- [13] B. Aronov and D. Drusvyatskiy. Complexity of a single face in an arrangement of s -intersecting curves. *CoRR*, abs/1108.4336, 2011.
- [14] M. J. Atallah. Some dynamic computational geometry problems. *Computers & Mathematics with Applications*, 11(12):1171–1181, 1985.
- [15] J. Augustine, B. Putnam, and S. Roy. Largest empty circle centered on a query line. *Journal of Discrete Algorithms*, 8(2):143–153, 2010.
- [16] F. Aurenhammer and B. Jüttler. On computing the convex hull of (piecewise) curved objects. *Mathematics in Computer Science*, 6(3):261–266, 2012.
- [17] S. W. Bae and Y. Okamoto. Querying two boundary points for shortest paths in a polygonal domain. *Comput. Geom.*, 45(7):284–293, 2012.
- [18] A. Baltzan and M. Sharir. On the shortest paths between two convex polyhedra. *J. ACM*, 35(2):267–287, 1988.
- [19] M. W. Bern, D. Eppstein, P. E. Plassman, and F. F. Yao. Horizon theorems for lines and polygons. In Jacob E. Goodman, Richard Pollack, and William Steiger, editors, *Discrete and Computational Geometry: Papers from the DIMACS Special Year*, number 6 in DIMACS Ser. Discrete Math. and Theoretical Computer Science, pages 45–66. Amer. Math. Soc., 1991.
- [20] R.P. Berretty, K. Goldberg, M.H. Overmars, and A.F. van der Stappen. Trap design for vibratory bowl feeders. *The International Journal of Robotics Research*, 20(11):891–908, 2001.
- [21] R. E. Burkard and H. Dollani. Robust location problems with pos/neg weights on a tree. *Networks*, 38(2):102–113, 2001.
- [22] B. Chazelle. A minimum spanning tree algorithm with inverse-Ackermann type complexity. *J. ACM*, 47(6):1028–1047, 2000.
- [23] B. Chazelle and B. Rosenberg. The complexity of computing partial sums off-line. *Internat. J. Comput. Geom. Appl.*, 1(1):33–45, 1991.
- [24] J. Cibulka and J. Kynčl. Tight bounds on the maximum size of a set of permutations with bounded VC-dimension. *J. Combin. Theory Ser. A*, 119(7):1461–1478, 2012.
- [25] R. Cole and M. Sharir. Visibility problems for polyhedral terrains. *Journal of Symbolic Computation*, 7(1):11–30, 1989.
- [26] H. Davenport. A combinatorial problem connected with differential equations. II. *Acta Arith.*, 17:363–372, 1970/1971.
- [27] H. Davenport and A. Schinzel. A combinatorial problem connected with differential equations. *American J. Mathematics*, 87:684–694, 1965.
- [28] H. Davenport and A. Schinzel. A note on sequences and subsequences. *Elemente Der Mathematik*, 20:63–64, 1965.
- [29] M. de Berg. Better bounds on the union complexity of locally fat objects. In *Proceedings of the 26th ACM Symposium on Computational Geometry*, pages 39–47, 2010.

- [30] A. Dumitrescu, M. Sharir, and C. D. Tóth. Extremal problems on triangle areas in two and three dimensions. *J. Combin. Theory, Series A*, 116(7):1177–1198, 2009.
- [31] H. Edelsbrunner, J. Pach, J. T. Schwartz, and M. Sharir. On the lower envelope of bivariate functions and its applications. In *Proceedings 28th Annual Symposium on Foundations of Computer Science (FOCS)*, pages 27–37, 1987.
- [32] A. Efrat. The complexity of the union of (α, β) -covered objects. *SIAM J. Comput.*, 34(4):775–787, 2005.
- [33] E. Ezra and W. Mulzer. Convex hull of points lying on lines in $o(n \log n)$ time after preprocessing. *Symposium on Computational Geometry*, pages 11–20, 2012.
- [34] J. Fox, J. Pach, and A. Suk. The number of edges in k -quasi-planar graphs. *CoRR*, abs/1112.2361, 2011. To appear in *SIAM J. Discrete Mathematics*.
- [35] R. Fulek. Linear bound on extremal functions of some forbidden patterns in 0-1 matrices. *Discrete Mathematics*, 309:1736–1739, 2009.
- [36] Z. Füredi and P. Hajnal. Davenport-Schinzel theory of matrices. *Discrete Mathematics*, 103(3):233–251, 1992.
- [37] H. N. Gabow. A scaling algorithm for weighted matching on general graphs. In *Proceedings 26th IEEE Symposium on Foundations of Computer Science (FOCS)*, pages 90–100, 1985.
- [38] J. T. Geneson. Extremal functions of forbidden double permutation matrices. *J. Combin. Theory Ser. A*, 116(7):1235–1244, 2009.
- [39] L. J. Guibas, J. S. B. Mitchell, and T. Roos. Voronoi diagrams of moving points in the plane. In *Graph-Theoretic Concepts in Computer Science*, volume 570 of *Lecture Notes in Computer Science*, pages 113–125. 1992.
- [40] S. Har-Peled. Taking a walk in a planar arrangement. *SIAM J. Comput.*, 30(4):1341–1367, 2000.
- [41] S. Hart and M. Sharir. Nonlinearity of Davenport-Schinzel sequences and of generalized path compression schemes. *Combinatorica*, 6(2):151–177, 1986.
- [42] D. P. Huttenlocher and K. Kedem. Computing the minimum Hausdorff distance for point sets under translation. In *Symposium on Computational Geometry*, pages 340–349, 1990.
- [43] D. P. Huttenlocher, K. Kedem, and J. M. Kleinberg. Voronoi diagrams of rigidly moving sets of points. *Info. Proc. Lett.*, 43(4):217–223, 1992.
- [44] D. P. Huttenlocher, K. Kedem, and M. Sharir. The upper envelope of Voronoi surfaces and its applications. *Discrete & Computational Geometry*, 9:267–291, 1993.
- [45] O. Ilushin, G. Elber, D. Halperin, R. Wein, and M.-S. Kim. Precise global collision detection in multi-axis NC-machining. *Computer-Aided Design*, 37(9):909–920, 2005.
- [46] J. W. Jaromczyk and M. Kowaluk. Skewed projections with an application to line stabbing in \mathbb{R}^3 . In *Symposium on Computational Geometry*, pages 362–370, 1988.

- [47] H. Kaplan, N. Rubin, and M. Sharir. A kinetic triangulation scheme for moving points in the plane. *Computational Geometry*, 44(4):191–205, 2011.
- [48] M. M. Klawe. Superlinear bounds for matrix searching problems. *J. Algor.*, 13(1):55–78, 1992.
- [49] M. M. Klawe and D. J. Kleitman. An almost linear time algorithm for generalized matrix searching. *SIAM J. Discr. Math.*, 3(1):81–97, February 1990.
- [50] M. Klazar. A general upper bound in extremal theory of sequences. *Comment. Math. Univ. Carolin.*, 33(4):737–746, 1992.
- [51] M. Klazar. On the maximum lengths of Davenport-Schinzel sequences. In *Contemporary Trends in Discrete Mathematics, Štířín Castle 1997 (Czech Republic)*, American Mathematical Society, Providence RI, pages 169–178, 1999.
- [52] M. Klazar. Generalized Davenport-Schinzel sequences: results, problems, and applications. *Integers*, 2:A11, 2002.
- [53] M. Klazar and P. Valtr. Generalized Davenport-Schinzel sequences. *Combinatorica*, 14(4):463–476, 1994.
- [54] V. Koltun. Almost tight upper bounds for vertical decompositions in four dimensions. *J. ACM*, 51(5):699–730, 2004.
- [55] V. Koltun and M. Sharir. 3-Dimensional Euclidean Voronoi diagrams of lines with a fixed number of orientations. *SIAM J. Comput.*, 32(3):616–642, 2003.
- [56] P. Komjáth. A simplified construction of nonlinear Davenport-Schinzel sequences. *J. Combin. Theory Ser. A*, 49(2):262–267, 1988.
- [57] T. Lengauer and R. E. Tarjan. A fast algorithm for finding dominators in a flowgraph. *ACM Trans. Program. Lang. Syst.*, 1(1):121–141, 1979.
- [58] D. Leven and M. Sharir. On the number of critical free contacts of a convex polygonal object moving in two-dimensional polygonal space. *Discrete & Computational Geometry*, 2:255–270, 1987.
- [59] M. C. López-de-los Mozos, J. Puerto, and A. M. Rodríguez-Chía. Robust mean absolute deviation problems on networks with linear vertex weights. *Networks*, 2012.
- [60] A. Marcus and G. Tardos. Excluded permutation matrices and the Stanley-Wilf conjecture. *J. Combin. Theory Ser. A*, 107(1):153–160, 2004.
- [61] J. Matoušek, J. Pach, M. Sharir, S. Sifrony, and E. Welzl. Fat triangles determine linearly many holes. *SIAM J. Comput.*, 23(1):154–169, 1994.
- [62] E. Moet, C. Knauer, and M. van Kreveld. Visibility maps of segments and triangles in 3D. *Computational Geometry*, 39(3):163–177, 2008.
- [63] G. Nivasch. Improved bounds and new techniques for Davenport-Schinzel sequences and their generalizations. *J. ACM*, 57(3), 2010.

- [64] S. Pettie. An inverse-Ackermann type lower bound for online minimum spanning tree verification. *Combinatorica*, 26(2):207–230, 2006.
- [65] S. Pettie. Splay trees, Davenport-Schinzel sequences, and the deque conjecture. In *Proceedings 19th ACM-SIAM Symposium on Discrete Algorithms*, pages 1115–1124, 2008.
- [66] S. Pettie. Applications of forbidden 0-1 matrices to search tree- and path compression-based data structures. In *Proceedings 21st ACM-SIAM Symposium on Discrete Algorithms (SODA)*, pages 1457–1467, 2010.
- [67] S. Pettie. Degrees of nonlinearity in forbidden 0-1 matrix problems. *Discrete Mathematics*, 311:2396–2410, 2011.
- [68] S. Pettie. Generalized Davenport-Schinzel sequences and their 0-1 matrix counterparts. *J. Comb. Theory Ser. A*, 118(6):1863–1895, 2011.
- [69] S. Pettie. On the structure and composition of forbidden sequences, with geometric applications. In *Proceedings 27th Annual Symposium on Computational Geometry*, pages 370–379, 2011.
- [70] S. Pettie. Origins of nonlinearity in Davenport-Schinzel sequences. *SIAM J. Discrete Mathematics*, 25(1):211–233, 2011.
- [71] R. Raz. VC-dimension of sets of permutations. *Combinatorica*, 20(2):241–255, 2000.
- [72] A. Di Salvo and G. Proietti. Swapping a failing edge of a shortest paths tree by minimizing the average stretch factor. *Theoretical Computer Science*, 383(1):23–33, 2007.
- [73] M. Sharir. Almost linear upper bounds on the length of general Davenport-Schinzel sequences. *Combinatorica*, 7(1):131–143, 1987.
- [74] M. Sharir. Improved lower bounds on the length of Davenport-Schinzel sequences. *Combinatorica*, 8(1):117–124, 1988.
- [75] M. Sharir and P. Agarwal. *Davenport-Schinzel Sequences and their Geometric Applications*. Cambridge University Press, 1995.
- [76] M. Sharir, R. Cole, K. Kedem, D. Leven, R. Pollack, and S. Sifrony. Geometric applications of Davenport-Schinzel sequences. In *Proceedings 27th Annual Symposium on Foundations of Computer Science (FOCS)*, pages 77–86, 1986.
- [77] M. Sharir and S. Toledo. Extremal polygon containment problems. *Comput. Geom.*, 4:99–118, 1994.
- [78] A. Suk. k -quasi-planar graphs. In *Graph Drawing*, pages 266–277, 2011.
- [79] E. Szemerédi. On a problem of Davenport and Schinzel. *Acta Arith.*, 25:213–224, 1973/74.
- [80] B. Tagansky. A new technique for analyzing substructures in arrangements of piecewise linear surfaces. *Discrete & Computational Geometry*, 16:455–479, 1996.

- [81] G. Tardos. On 0-1 matrices and small excluded submatrices. *J. Combin. Theory Ser. A*, 111(2):266–288, 2005.
- [82] R. E. Tarjan. Efficiency of a good but not linear set merging algorithm. *J. ACM*, 22(2):215–225, 1975.
- [83] R. E. Tarjan. Applications of path compression on balanced trees. *J. ACM*, 26(4):690–715, 1979.
- [84] P. Valtr. Graph drawings with no k pairwise crossing edges. In *Proceedings 5th Int'l Symposium on Graph Drawing*, pages 205–218, 1997.
- [85] M.A. Wahid, M. Kaykobad, and M. Hasan. Kinetisation of view of 3D point set. In *Proceedings 13th International Conference on Computer and Information Technology (ICCIT)*, pages 325–330, 2010.
- [86] A. Wiernik and M. Sharir. Planar realizations of nonlinear Davenport-Schinzel sequences by segments. *Discrete Comput. Geom.*, 3(1):15–47, 1988.
- [87] A. C. Yao. Space-time tradeoff for answering range queries. In *Proc. 14th ACM Symposium on Theory of Computing (STOC)*, pages 128–136, 1982.

A Proof of Lemma 3.1

Recall the four parts of Lemma 3.1.

Restatement of Lemma 3.1 *Let $\gamma_s(n) : \mathbb{N} \rightarrow \mathbb{N}$ be a non-decreasing function such that $\lambda_s(n) \leq \gamma_s(n) \cdot n$.*

1. (Trivial) For $s \geq 1$, $\lambda_s(n, m) \leq m - 1 + \lambda_s(n)$.
2. (Sharir [73]) For $s \geq 3$, $\lambda_s(n) \leq \gamma_{s-2}(n) \cdot \lambda_s(n, 2n - 1)$. (This generalizes Hart and Sharir’s proof [41] for $s = 3$.)
3. (Sharir [73]) For $s \geq 2$, $\lambda_s(n) \leq \gamma_{s-1}(n) \cdot \lambda_s(n, n)$.
4. (New) For $s \geq 3$, $\lambda_s(n) = \gamma_{s-2}(\gamma_s(n)) \cdot \lambda_s(n, 3n - 1)$.

Proof: Removing at most $m - 1$ repeated symbols at block boundaries makes any sequence 2-sparse, which implies Part (1).

For Parts (2) and (3), consider the following method for greedily partitioning a 2-sparse, order- s DS sequence S with $\|S\| = n$. Write S as $S_1 S_2 \cdots S_m$, where S_1 is the longest order- $(s - 2)$ prefix of S , S_2 is the longest order- $(s - 2)$ prefix of the remainder of the sequence, and so on. Each S_q contains the first or last occurrence of some symbol, which implies $m \leq 2n - 1$ since S_1 must contain the first occurrence of at least two symbols. To see this, consider the symbol b which caused the termination of S_q , that is, S_q has order $s - 2$ but $S_q b$ contains an alternating subsequence $\sigma_s = aba \cdots ab$ or $ba \cdots ab$ with length s ; whether it starts with a depends on the parity of s . If S_q contained neither the first nor last occurrence of both a and b , S would contain an alternating

subsequence σ_{s+2} of length $s+2$, a contradiction. Obtain S' from S replacing each S_q with a block containing exactly one occurrence of each symbol in $\Sigma(S_q)$. Thus,

$$\begin{aligned}
|S| &= \sum_{q=1}^m |S_q| \leq \sum_{q=1}^m \gamma_{s-2}(\|S_q\|) \cdot \|S_q\| && \{S_q \text{ has order } s-2, \text{ defn. of } \gamma_{s-2}\} \\
&\leq \gamma_{s-2}(n) \cdot \sum_{q=1}^m \|S_q\| && \{\gamma_{s-2} \text{ is non-decreasing}\} \\
&= \gamma_{s-2}(n) \cdot |S'| \leq \gamma_{s-2}(n) \cdot \lambda_s(n, m) && \{S' \prec S \text{ has order } s\}
\end{aligned}$$

which proves Part (2). Part (3) is proved in the same way except that we partition S into order- $(s-1)$ DS sequences. In this case each S_q must contain the last occurrence of some symbol, so $m \leq n$. We turn now to Part (4).

Partition S into order- $(s-2)$ sequences $S_1 S_2 \cdots S_m$ as follows. After S_1, \dots, S_{q-1} have been selected, let S_q be the longest prefix of the remaining sequence that (i) has order $s-2$ and (ii) has length at most $\gamma_s(n)$. The number of such sequences that were terminated due to (i) is at most $2n-1$, by the same argument from Part (2). The number terminated due to (ii) is at most n since $|S| \leq \gamma_s(n) \cdot n$, so $m \leq 3n-1$. Obtain an m -block sequence S' in the usual way, by replacing each S_q with a block containing its alphabet. Thus,

$$\begin{aligned}
|S| &= \sum_{q=1}^m |S_q| \leq \sum_{q=1}^m \gamma_{s-2}(\|S_q\|) \cdot \|S_q\| && \{S_q \text{ has order } s-2, \text{ defn. of } \gamma_{s-2}\} \\
&\leq \gamma_{s-2}(\gamma_s(n)) \cdot \sum_{q=1}^m \|S_q\| && \{\gamma_s \text{ is non-decreasing, } \|S_q\| \leq |S_q| \leq \gamma_s(n)\} \\
&= \gamma_{s-2}(\gamma_s(n)) \cdot |S'| \leq \gamma_{s-2}(\gamma_s(n)) \cdot \lambda_s(n, m) && \{S' \prec S \text{ has order } s\}
\end{aligned}$$

□

Note that while Part (4) is stronger than Part (2), it requires an upper bound on $\gamma_s(n)$ to be applied, which is obtained by invoking Part (2). In the end it does not matter precisely what $\gamma_s(n)$ is. Once $\gamma_s(n)$ is known to be some primitive recursive function of $\alpha(n)$, it follows that $\gamma_{s-2}(\gamma_s(n)) = \gamma_{s-2}(\alpha(n)) + O(1)$.

B Proof of Lemma 5.3

Recall our definition of Ackermann's function: $a_{1,j} = 2^j$, $a_{i,1} = 2$, and $a_{i,j} = w \cdot a_{i-1,w}$ where $w = a_{i,j-1}$. Our task in this section is to prove the omnibus Lemma 5.3 in several stages.

Restatement of Lemma 5.3 *Let $s \geq 1$ be the order parameter, $c \geq s-2$ be a constant, and $i \geq 1$ be an arbitrary integer. The following upper bounds on λ_s and Φ_s hold for all $s \geq 1$ and all odd*

$s \geq 5$, respectively. Define j to be maximum such that $m \leq a_{i,j}^c$.

$$\begin{aligned}
\lambda_1(n, m) &= n + m - 1 & s &= 1 \\
\lambda_2(n, m) &= 2n + m - 2 & s &= 2 \\
\lambda_3(n, m) &\leq (2i + 2)n + (3i - 2)cj(m - 1) & s &= 3 \\
\lambda_s(n, m) &\leq \mu_{s,i}(n + (cj)^{s-2}(m - 1)) & \text{all } s &\geq 4 \\
\Phi_s(n, m) &\leq \nu_{s,i}(n + (cj)^{s-2}(m - 1)) & \text{odd } s &\geq 5
\end{aligned}$$

The values $\{\mu_{s,i}, \nu_{s,i}\}$ are defined as follows, where $t = \lfloor \frac{s-2}{2} \rfloor$.

$$\begin{aligned}
\mu_{s,i} &= \begin{cases} 2^{\binom{i+t+3}{t}} - 3(2(i+t+1))^t & \text{even } s \geq 4 \\ \frac{3}{2}(2(i+t+1))^{t+1} 2^{\binom{i+t+3}{t}} & \text{odd } s \geq 5 \end{cases} \\
\nu_{s,i} &= 4 \cdot 2^{\binom{i+t+3}{t}} & \text{odd } s &\geq 5
\end{aligned}$$

Overview. The proof is by induction on (s, i, j) with respect to any fixed $c \geq s - 2$. In Section B.1 we confirm that Lemma 5.3 holds when $i = 1$. In Section B.2 we discuss the role that Ackermann's function plays in selecting block partitions for Recurrences 3.3, 5.1, and 5.2. In Section B.3 we confirm Lemma 5.3 at $s = 3$. In Section B.4 we identify sufficient lower bounds on the elements of $\{\mu_{s,i}, \nu_{s,i}\}_{s \geq 2, i \geq 1}$, then, in Section B.5, prove that the particular ensemble $\{\mu_{s,i}, \nu_{s,i}\}_{s \geq 2, i \geq 1}$ proposed in Lemma 5.3 does, in fact, satisfy these lower bounds.

B.1 Base Cases

Lemma B.1 *Let n, m , and $s \geq 2$ be the alphabet size, block count, and order parameters. Given $i \geq 1$, let j' be minimum such that $m \leq a_{i,j'}$. Whether $i = 1$ and $j' \geq 1$ or $j' = 1$ and $i > 1$, we have*

$$\Phi_s(n, m) \leq \lambda_s(n, m) \leq 2^{s-1}n + j'^{s-2}(m - 1).$$

Proof: First note that $\Phi_s(n, m) \leq \lambda_s(n, m) - 2n$ holds trivially since, in the worst case, every occurrence in the sequence is a feather, except for the first and last occurrence of each letter.

At $s = 2$ the claim follows directly from Lemma 3.2. At $s \geq 3, j' = 1$, the claim is trivial since there are only $a_{i,1} = 2$ blocks and $\lambda_s(n, 2) = 2n$.

In the general case we have $s \geq 3$ and $j' > 1$. Let S be an order- s , m -block sequence over an n -letter alphabet, where $m \leq a_{1,j'} = 2^{j'}$. Let $S = S_1 S_2$ be the partition of S using a uniform block partition with width $a_{1,j'-1} = 2^{j'-1}$, so $\llbracket S_1 \rrbracket = a_{1,j'-1}$ and $\llbracket S_2 \rrbracket = m - a_{1,j'-1} \leq a_{1,j'-1}$. Note that $\hat{S}' = \beta_1 \beta_2$ consists of two blocks, where each β_q is some permutation of the global alphabet $\hat{\Sigma}$. Since

there are no middle occurrences in \hat{S}' or S we can apply a simplified version of Recurrence 3.3.

$$\begin{aligned}
& \lambda_s(n, m) \\
& \leq \sum_{q=1,2} \lambda_s(\hat{n}_q, \llbracket S_q \rrbracket) + \lambda_{s-1}(\hat{n}, \llbracket S_1 \rrbracket) + \lambda_{s-1}(\hat{n}, \llbracket S_2 \rrbracket) && \{\text{local, first, and last}\} \\
& \leq 2^{s-1}(n - \hat{n}) + (j' - 1)^{s-2}(m - 2) + 2(2^{s-2}\hat{n}) + (j' - 1)^{s-3}(m - 2) && \{\text{inductive hypothesis}\} \\
& < 2^{s-1}n + j'^{s-2}(m - 1)
\end{aligned}$$

The last inequality follows from the fact that when $s \geq 3$, $(j' - 1)^{s-2} + (j' - 1)^{s-3} \leq j'^{s-2}$. This concludes the induction. \square

If we introduce the ‘ c ’ parameter and define j to be minimum such that $m \leq a_{i,j}^c$, Lemma B.1 implies that $\lambda_s(n, m) \leq 2^{s-1}n + (cj)^{s-2}(m - 1)$ since $j' \leq cj$. Note that by definition of Ackermann’s function, $a_{1,j}^c = (2^j)^c = a_{1,cj}$ and $a_{i,1}^c = 2^c = a_{1,c}$.

Lemma B.1 implies the claims of Lemma 5.3 at $i = 1$. When $s = 3$, $2i + 2 = 4 = 2^{s-1}$ and $3i - 2 = 1$. When $s \geq 4$ is even, $\mu_{s,1} = 2^{\binom{t+4}{t}} - 3(2(t+2))^t \geq 2^{2t+1} = 2^{s-1}$. When $s \geq 5$ is odd, $\mu_{s,1} = \frac{3}{2}(2(t+2))^{t+1}2^{\binom{t+4}{t}} \geq 2^{2t+2} = 2^{s-1}$ and $\nu_{s,1} = 4 \cdot 2^{\binom{t+4}{t}} \geq 2^{2t+2} = 2^{s-1}$. The bounds above also imply that Lemma 5.3 holds at $j = 1$ and $i > 1$ since $a_{i,1}^c = a_{1,1}^c$ and both $\mu_{s,i}$ and $\nu_{s,i}$ are increasing in i .

B.2 Block Partitions and Inductive Hypotheses

When analyzing order- s DS sequences we express the block count m and partition size \hat{m} in terms of constant powers of Ackermann’s function $\{a_{i,j}^c\}$, where the constant $c \geq s - 2$ is fixed. Recall that once i is selected, j is minimal such that $m \leq a_{i,j}^c$. The base cases $i = 1$ and $j = 1$ have been handled so we can assume both are at least 2. Let $w = a_{i,j-1}$.

We always choose a uniform block partition $\{m_q\}_{1 \leq q \leq \hat{m}}$ with width w^c , that is, $m_q = w^c$ for all $q < \hat{m} = \lceil m/w^c \rceil$ and the leftover $m_{\hat{m}}$ may be smaller. When invoking the inductive hypothesis (Lemma 5.3) on the \hat{m} -block sequence \hat{S}' we use parameter $i - 1$. In all other invocations of the inductive hypothesis we use parameter i . When applied to any m_q -block sequences the ‘ j ’ parameter is decremented since $m_q \leq w^c = a_{i,j-1}^c$. When applied to a \hat{m} -block sequence the ‘ j ’ parameter is w since

$$\hat{m} = \lceil \frac{m}{w^c} \rceil \leq \left(\frac{a_{i,j}}{w} \right)^c = a_{i-1,w}^c.$$

Furthermore, in such an invocation the dependence on \hat{m} will always be at most linear in m since $(cw)^{s-2}(\hat{m} - 1) \leq (cw)^{s-2}(\lceil \frac{m}{w^c} \rceil - 1) \leq c^{s-2}(m - 1)$. This is the reason we require the lower bound $c \geq s - 2$.

If one is more familiar with the slowly growing row-inverses of Ackermann’s function, it may be helpful to remember that $cj = \log m - O(1)$ when $i = 1$ and that $j = \log^{[i-1]}(m) - O(1)$ when $i > 1$, the effect of the c parameter being negligible since $a_{i,j}$ and $a_{i,j}^c$ are essentially identical relative to any sufficiently slowly growing function.²² Thus, the bounds of Lemma 5.3 could be rephrased as $\lambda_s(n, m) \leq \mu_{s,i} \left(n + O \left(m (\log^{[i-1]}(m))^{s-2} \right) \right)$. Since $\mu_{s,i}$ is increasing in i , the best bounds are obtained by choosing i to be minimal such that $\log^{[i-1]}(m) = n/m + O(1)$.

²²Recall that $\log^{[i-1]}(m)$ is short for $\log^{*\dots*}(m)$ with $i - 1$ \star s.

B.3 Order $s = 3$

Lemma B.2 (Order $s = 3$) Let n and m be the alphabet size and block count of an order-3 DS sequence S . For any $i, c \geq 1$, define j to be minimum such that $m \leq a_{i,j}^c$. Then λ_3 is bounded by

$$\lambda_3(n, m) \leq (2i + 2)n + (3i - 2)cj(m - 1)$$

Proof: The base cases $i = 1$ and $j = 1$ have been handled already. Let $i, j > 1$ and $w = a_{i,j-1}$. We invoke Recurrence 3.3 with the uniform block partition $\{m_q\}_{1 \leq q \leq \hat{m}}$, where $\hat{m} = \lceil m/w^c \rceil$. (See Section B.2.)

$$\begin{aligned} \lambda_3(n, m) &\leq \sum_{q=1}^{\hat{m}} \lambda_3(\check{n}_q, m_q) + 2 \cdot \lambda_2(\hat{n}, m) + \lambda_1(\lambda_3(\hat{n}, \hat{m}) - 2\hat{n}, m) \\ &\leq (2i + 2)(n - \hat{n}) + (3i - 2)c(j - 1)(m - \hat{m}) && \{\text{ind. hyp.: local symbols}\} \\ &\quad + 4\hat{n} + 2(m - 1) && \{\text{global first and last occurrences}\} \\ &\quad + (2i - 2)\hat{n} + (3(i - 1) - 2)cw(\hat{m} - 1) + (m - 1) && \{\text{global middle occurrences}\} \\ &\leq (2i + 2)n + (3i - 2)cj(m - 1) \\ &\quad + \left[-(2i + 2) + 4 + (2i - 2) \right] \hat{n} + \left[-c(3i - 2) + (3i - 5) + 3 \right] (m - 1) \\ &\leq (2i + 2)n + (3i - 2)cj(m - 1) \end{aligned}$$

The last inequality holds since $c \geq s - 2 = 1$. \square

At $s = 2$ and $s = 3$ the terms involving n and m have different leading constants, namely 2 and 1 when $s = 2$ and $2i + 2$ and $3i - 2$ when $s = 3$. To provide some uniformity in the analyses below we will use the inequalities $\lambda_2(n, m) \leq \mu_{2,i}(n + m - 1)$ and $\lambda_3(n, m) \leq \mu_{3,i}(n + (cj)(m - 1))$ when invoking the inductive hypothesis at $i \geq 2$ and $s \in \{2, 3\}$, where $\mu_{2,i} = 2$ and $\mu_{3,i} = 3i$ by definition. Note that when $i \geq 2$, $\mu_{3,i} = 3i \geq \max\{2i + 2, 3i - 2\}$.

B.4 Lower Bounds on $\mu_{s,i}$ and $\nu_{s,i}$

Call an ensemble of values $\{\mu_{s',i'}, \nu_{s',i'}\}_{(s',i') \leq (s,i)}$ *happy* if $\lambda_{s'}(n, m) \leq \mu_{s',i'}(n + (cj)^{s'-2}(m - 1))$ and $\Phi_{s'}(n, m) \leq \nu_{s',i'}(n + (cj)^{s'-2}(m - 1))$, where c and j are defined as usual. (In the subscript ' \leq ' represents lexicographic ordering on tuples.) In Lemma B.3 we determine lower bounds on $\mu_{s,i}$ and $\nu_{s,i}$ in a happy ensemble. In Section B.5 we prove that the *specific* ensemble proposed in Lemma 5.3 is, in fact, happy.

Lemma B.3 Let $s \geq 4$ and $i \geq 2$. Define n, m, c , and j as usual. If $\{\mu_{s',i'}, \nu_{s',i'}\}_{(s',i') \leq (s,i-1)}$ is happy then $\{\mu_{s',i'}, \nu_{s',i'}\}_{(s',i') \leq (s,i)}$ is as well, so long as

$$\begin{aligned} \mu_{s,i} &\geq 2\mu_{s-1,i} + \mu_{s-2,i}\mu_{s,i-1} && \text{even } s \\ \mu_{s,i} &\geq 2\mu_{s-1,i} + \mu_{s-2,i}\nu_{s,i-1} + \mu_{s-3,i}\mu_{s,i-1} && \text{odd } s \\ \nu_{s,i} &\geq \nu_{s,i-1} + 2\mu_{s-1,i} && \text{odd } s \end{aligned}$$

Proof: When $s \geq 4$ is even, Recurrence 3.3 implies that

$$\begin{aligned}
\lambda_s(n, m) &\leq \sum_{q=1}^{\hat{m}} \lambda_s(\check{n}_q, m_q) + 2 \cdot \lambda_{s-1}(\hat{n}, m) + \lambda_{s-2}(\lambda_s(\hat{n}, \hat{m}), m) \\
&\leq \mu_{s,i}((n - \hat{n}) + (cj - 1)^{s-2}(m - \hat{m})) \quad \{\text{happiness of the ensemble}\} \\
&\quad + 2\mu_{s-1,i}(\hat{n} + (cj)^{s-3}(m - 1)) \\
&\quad + \mu_{s-2,i} \left(\mu_{s,i-1}(\hat{n} + (cw)^{s-2}(\hat{m} - 1)) + (cj)^{s-4}(m - 1) \right) \\
&\leq \mu_{s,i}(n + (cj)^{s-2}(m - 1)) \\
&\quad + \left[-\mu_{s,i} + 2\mu_{s-1,i} + \mu_{s-2,i}\mu_{s,i-1} \right] \cdot \hat{n} \tag{6} \\
&\quad + \left[-\mu_{s,i}c^{s-2}j^{s-3} + 2\mu_{s-1,i}(cj)^{s-3} + \mu_{s-2,i}\mu_{s,i-1}c^{s-2} + \mu_{s-2,i}(cj)^{s-4} \right] \cdot (m - 1) \tag{7} \\
&\leq \mu_{s,i}(n + (cj)^{s-2}(m - 1)) \tag{8}
\end{aligned}$$

Inequality (8) will be satisfied whenever (6) and (7) are non-positive, that is, when

$$\mu_{s,i} \geq 2\mu_{s-1,i} + \mu_{s-2,i}\mu_{s,i-1} \tag{9}$$

$$\mu_{s,i} \geq \frac{2\mu_{s-1,i}}{s-2} + \frac{\mu_{s-2,i}\mu_{s,i-1}}{2^{s-3}} + \frac{\mu_{s-2,i}}{2(s-2)^2} \tag{10}$$

Inequality (10) was obtained by dividing (7) through by $c^{s-2}j^{s-3}$ and noting that $c \geq s - 2 \geq 2$ and $j \geq 2$. Note that Inequality (10) is weaker than Inequality (9) since $\mu_{s,i} > \mu_{s-1,i} > \mu_{s-2,i}$, so it suffices to consider only the former.

When $s \geq 5$ is odd, Recurrence 5.2 implies that

$$\begin{aligned}
\lambda_s(n, m) &\leq \sum_{q=1}^{\hat{m}} \lambda_s(\check{n}_q, m_q) + 2 \cdot \lambda_{s-1}(\hat{n}, m) + \lambda_{s-2}(\Phi_s(\hat{n}, \hat{m}), m) + \lambda_{s-3}(\lambda_s(\hat{n}, \hat{m}), m) \\
&\leq \mu_{s,i}((n - \hat{n}) + (cj - 1)^{s-2}(m - \hat{m})) \quad \{\text{happiness of the ensemble}\} \\
&\quad + 2\mu_{s-1,i}(\hat{n} + (cj)^{s-3}(m - 1)) \\
&\quad + \mu_{s-2,i} \left(\nu_{s,i-1}(\hat{n} + (cw)^{s-2}(\hat{m} - 1)) + (cj)^{s-4}(m - 1) \right) \\
&\quad + \mu_{s-3,i} \left(\mu_{s,i-1}(\hat{n} + (cw)^{s-2}(\hat{m} - 1)) + (cj)^{s-5}(m - 1) \right) \\
&\leq \mu_{s,i}(n + (cj)^{s-2}(m - 1)) \\
&\quad + \left[-\mu_{s,i} + 2\mu_{s-1,i} + \mu_{s-2,i}\nu_{s,i-1} + \mu_{s-3,i}\mu_{s,i-1} \right] \cdot \hat{n} \tag{11} \\
&\quad + \left[-\mu_{s,i}c^{s-2}j^{s-3} + 2\mu_{s-1,i}(cj)^{s-3} + \mu_{s-2,i}\nu_{s,i-1}c^{s-2} \right. \\
&\quad \quad \left. + \mu_{s-2,i}(cj)^{s-4} + \mu_{s-3,i}\mu_{s,i-1}c^{s-2} + \mu_{s-3,i}(cj)^{s-5} \right] \cdot (m - 1) \tag{12} \\
&\leq \mu_{s,i}(n + (cj)^{s-2}(m - 1)) \tag{13}
\end{aligned}$$

Inequality (13) will be satisfied whenever (11) and (12) are non-positive, that is, when

$$\mu_{s,i} \geq 2\mu_{s-1,i} + \mu_{s-2,i}\nu_{s,i-1} + \mu_{s-3,i}\mu_{s,i-1} \quad (14)$$

$$\mu_{s,i} \geq \frac{2\mu_{s-1,i}}{s-2} + \frac{\mu_{s-2,i}\nu_{s,i-1}}{2^{s-3}} + \frac{\mu_{s-2,i}}{2(s-2)^2} + \frac{\mu_{s-3,i}\mu_{s,i-1}}{2^{s-3}} + \frac{\mu_{s-3,i}}{4(s-2)^3} \quad (15)$$

The denominators of Inequality (15) follow by dividing (12) through by $c^{s-2}j^{s-3}$ and noting that $c \geq s-2 \geq 3$ and $j \geq 2$. Inequality (15) is weaker than Inequality (14) since $\mu_{s-1,i} > \mu_{s-2,i} > \mu_{s-3,i}$ so it suffices to consider only Inequality (14).

Using similar calculations, one derives from Recurrence 5.1 the claimed lower bound on $\nu_{s,i}$.

$$\nu_{s,i} \geq \nu_{s,i-1} + 2\mu_{s-1,i} \quad (16)$$

□

B.5 The Happiness of the Ensemble

From this point on we argue the happiness of the *specific* ensemble $\{\mu_{s,i}, \nu_{s,i}\}$ stated in Lemma 5.3. We can say an individual value $\mu_{s,i}$ or $\nu_{s,i}$ is happy if it satisfies the appropriate lower bound inequality, either (10), (15), or (16).

Lemma B.4 *The ensemble $\{\mu_{s,i}, \nu_{s,i}\}$ defined in Lemma 5.3 is happy.*

Proof: All $\nu_{s,i}$ are happy since

$$\begin{aligned} \nu_{s,i-1} + 2\mu_{s-1,i} &< 4 \cdot 2^{\binom{i+t+2}{t}} + 2 \cdot 2^{\binom{i+t+3}{t}} && \{\text{by definition}\} \\ &\leq 4 \cdot 2^{\binom{i+t+3}{t}} = \nu_{s,i} && \{t \geq 1, 4 \cdot 2^{\binom{i+t+2}{t}} \leq 2 \cdot 2^{\binom{i+t+3}{t}}\} \end{aligned}$$

When $s = 4$ and $t = \lfloor \frac{s-2}{2} \rfloor = 1$ the expression for $\mu_{4,i}$ simplifies to $2^{i+4} - 6(i+2)$. The happiness of $\mu_{4,i}$ follows easily, as seen below.

$$\begin{aligned} 2\mu_{3,i} + \mu_{2,i}\mu_{4,i-1} &= 2(3i) + 2 \cdot (2^{i+3} - 6(i+1)) && \{\text{by definition}\} \\ &= 2^{i+4} + 6i - 12(i+1) \\ &= 2^{i+4} - 6(i+2) = \mu_{4,i} \end{aligned}$$

When $s = 5$ and $t = \lfloor \frac{s-2}{2} \rfloor = 1$, the expression for $\mu_{5,i}$ simplifies to $\frac{3}{2}(2(i+2))^2 2^{i+4}$, which lets us quickly certify the happiness of $\mu_{5,i}$.

$$\begin{aligned} 2\mu_{4,i} + \mu_{3,i}\nu_{5,i-1} + \mu_{2,i}\mu_{5,i-1} &= 2(2^{i+4} - 6(i+2)) + 3i \cdot 4 \cdot 2^{i+3} + 2 \cdot \frac{3}{2}(2(i+1))^2 2^{i+3} \\ &\leq \left(2 + 6i + \frac{3}{2}(2(i+1))^2\right) 2^{i+4} \\ &\leq \frac{3}{2}(2(i+2))^2 2^{i+4} = \mu_{5,i} \end{aligned}$$

We now turn to the happiness of $\mu_{s,i}$ for even $s \geq 6$. Note that when we invoke the definition of $\mu_{s-1,i}$ and $\mu_{s-2,i}$ their “ t ” parameter is $t-1 = \lfloor \frac{(s-1)-2}{2} \rfloor = \lfloor \frac{(s-2)-2}{2} \rfloor$.

$$\begin{aligned}
& 2\mu_{s-1,i} + \mu_{s-2,i}\mu_{s,i-1} \\
& \leq 2 \cdot \left[\frac{3}{2}(2(i+t))^t 2^{\binom{i+t+2}{t-1}} \right] + \left[2^{\binom{i+t+2}{t-1}} - 3(2(i+t))^{t-1} \right] \cdot \left[2^{\binom{i+t+2}{t}} - 3(2(i+t))^t \right] \\
& = \left[3(2(i+t))^t 2^{\binom{i+t+2}{t-1}} \right] + 2^{\binom{i+t+2}{t-1}} \left[2^{\binom{i+t+2}{t}} - 3(2(i+t))^t \right] - 3(2(i+t))^{t-1} \left[2^{\binom{i+t+2}{t}} - 3(2(i+t))^t \right] \\
& = 2^{\binom{i+t+2}{t-1}} 2^{\binom{i+t+2}{t}} - 3(2(i+t))^{t-1} \left[2^{\binom{i+t+2}{t}} - 3(2(i+t))^t \right] \\
& \leq 2^{\binom{i+t+3}{t}} - 3(2(i+t+1))^t = \mu_{s,i}
\end{aligned}$$

In other words, $\mu_{s,i}$ satisfies Inequality (9) when $s \geq 6$ is even. It also satisfies Inequality (14) at odd $s \geq 7$, which can be seen as follows. Note that the “ t ” parameter for $s-1$ is t , whereas it is $t-1$ for $s-2$ and $s-3$.

$$\begin{aligned}
& 2\mu_{s-1,i} + \mu_{s-2,i}\nu_{s,i-1} + \mu_{s-3,i}\mu_{s,i-1} \\
& \leq 2 \cdot 2^{\binom{i+t+3}{t}} + \frac{3}{2}(2(i+t))^t 2^{\binom{i+t+2}{t-1}} \cdot 4 \cdot 2^{\binom{i+t+2}{t}} + 2^{\binom{i+t+2}{t-1}} \cdot \frac{3}{2}(2(i+t))^{t+1} 2^{\binom{i+t+2}{t}} \\
& \leq \left[2 + \frac{3}{2}4 \cdot (2(i+t))^t + \frac{3}{2}(2(i+t))^{t+1} \right] \cdot 2^{\binom{i+t+3}{t}} \\
& \leq \left[2 + \frac{3}{2}(2(i+t))^t \cdot 2(i+t+2) \right] \cdot 2^{\binom{i+t+3}{t}} \\
& \leq \frac{3}{2}(2(i+t+1))^{t+1} \cdot 2^{\binom{i+t+3}{t}} = \mu_{s,i}
\end{aligned}$$

We have shown that $\{\mu_{s,i}\}$ and $\{\nu_{s,i}\}$ are happy over the full range of parameters. This concludes the proof of Lemma 5.3. \square

C Proof of Lemma 7.8

The proof of Lemma 7.8 closely mimics that of Lemma 5.3.

Restatement of Lemma 7.8 *Let n and m be the alphabet size and block count. After a parameter $i \geq 1$ is chosen let $j \geq 1$ be minimum such that $m \leq a_{i,j}^c$, where $c = 3$ is fixed. We have the following upper bounds on $\Phi'(n, m)$, $\Phi''(n, m)$, and $\lambda_5(n, m)$.*

$$\begin{aligned}
\Phi'(n, m) &\leq \nu'_i(n + (cj)^2(m-1)) && \text{where } \nu'_i = 3\binom{i+1}{2} + 3 \\
\Phi''(n, m) &\leq \nu''_i(n + (cj)^3(m-1)) && \text{where } \nu''_i = 6\binom{i+2}{3} + 8i \\
\lambda_5(n, m) &\leq \mu_{5,i}(n + (cj)^3(m-1)) && \text{where } \mu_{5,i} = i2^{i+7}
\end{aligned}$$

Proof: We use the following upper bounds on order-3 and order-4 DS sequences from Lemma 5.3.

$$\begin{aligned}
\lambda_3(n, m) &\leq \mu_{3,i}[n + (cj)(m-1)] && \text{where } \mu_{3,i} = 3i + 1 \geq \max\{2i + 2, 3i - 2\} \\
\lambda_4(n, m) &\leq \mu_{4,i}[n + (cj)^2(m-1)] && \text{where } \mu_{4,i} = 2^{i+4} - 6(i+2)
\end{aligned}$$

and, when $i = 1$,

$$\begin{aligned}\lambda_4(n, m) &\leq 2^3 n + (cj)^2(m-1) \\ \lambda_5(n, m) &\leq 2^4 n + (cj)^3(m-1)\end{aligned}\quad \text{See Lemma B.1.}$$

Base Cases. In the worst case every occurrence in an order-4 sequence is a dove (or hawk) feather, except for the first and last occurrence of each symbol, which are wingtips. This implies that

$$\begin{aligned}\Phi'(n, m) &\leq \lambda_4(n, m) - 2n \\ &\leq (2^3 - 2)n + (3j)^2(m-1) && \{\text{by Lemma B.1}\} \\ &\leq \nu'_1(n + (3j)^2(m-1)) && \{\text{since } \nu'_1 = 6\}\end{aligned}$$

The same argument implies that $\Phi''(n, m) \leq \lambda_5(n, m) - 2n \leq (2^4 - 2)n + (3j)^3(m-1)$, which is at most $\nu''_1(n + (3j)^3(m-1))$ since $\nu''_1 = 14$. This confirms the claimed bounds when $i = 1$. It also holds when $i > 1$ and $j = 1$ since $a_{i,1}^3 = a_{1,1}^3$ and all of ν'_i, ν''_i , and $\mu_{5,i}$ are increasing in i .

Inductive Cases. We can assume that $i, j > 1$. As in the proof of Lemma 5.3 we always apply Recurrence 7.6 with a uniform block partition $\{m_q\}_{1 \leq q \leq \hat{m}}$ with width w^c , where $w = a_{i,j-1}$, $\hat{m} = \lceil m/w^c \rceil$, and $c = 3$ is fixed.

According to Recurrence 7.6 and the inductive hypothesis we have:

$$\begin{aligned}\Phi'(n, m) &\leq \sum_{q=1}^{\hat{m}} \Phi'(\tilde{n}_q, m_q) + \Phi'(\hat{n}, \hat{m}) + \lambda_3(\hat{n}, m) - \hat{n} \\ &\leq \nu'_i \left[(n - \hat{n}) + (c(j-1))^2(m - \hat{m}) \right] \\ &\quad + \nu'_{i-1} \left[\hat{n} + (cw)^2(\hat{m} - 1) \right] \\ &\quad + \mu_{3,i} \left[\hat{n} + (cj)(m-1) \right] - \hat{n} && \{\text{inductive hypothesis}\} \\ &\leq \nu'_i \left[n + (cj)^2(m-1) \right] \\ &\quad + \left[-\nu'_i + \nu'_{i-1} + \mu_{3,i} - 1 \right] \cdot \hat{n} \\ &\quad + \left[-(c^2j)\nu'_i + (c^2/w)\nu'_{i-1} + (cj)\mu_{3,i} \right] \cdot (m-1) && (17) \\ &\leq \nu'_i \left[n + (cj)^2(m-1) \right] && (18)\end{aligned}$$

Inequality (17) follows from the fact that $(c(j-1))^2 \leq (cj)^2 - cj$ and that $(cw)^2(\hat{m} - 1) = (cw)^2(\lceil \frac{m}{w^c} \rceil - 1) \leq (c^2/w)(m-1)$. Inequality (18) will follow so long as ν'_i satisfies the following.

$$\nu'_i \geq \nu'_{i-1} + \mu_{3,i} - 1 = \nu'_{i-1} + 3i \quad (19)$$

One may confirm that $\nu'_i = 3\binom{i+1}{2} + 3$ satisfies (19). In a similar fashion we can obtain a lower bound on ν''_i as follows.

$$\begin{aligned}
\Phi''(n, m) &\leq \sum_{q=1}^{\hat{m}} \Phi''(\tilde{n}_q, m_q) + \Phi''(\hat{n}, \hat{m}) + 2(\Phi'(\hat{n}, m) + \hat{n}) \\
&\leq \nu_i'' \left[(n - \hat{n}) + (cj - 1)^3(m - \hat{m}) \right] \\
&\quad + \nu_{i-1}'' \left[\hat{n} + (cw)^3(\hat{m} - 1) \right] \\
&\quad + 2\nu_i' \left[\hat{n} + (cj)^2(m - 1) \right] + 2\hat{n} \quad \{\text{inductive hypothesis}\} \\
&\leq \nu_i'' \left[n + (cj)^3(m - 1) \right] \\
&\quad + \left[-\nu_i'' + \nu_{i-1}'' + 2\nu_i' + 2 \right] \cdot \hat{n} \\
&\quad + \left[-(c^3j^2)\nu_i'' + c^3\nu_{i-1}'' + (cj)^2 \cdot 2\nu_i' \right] \cdot (m - 1) \tag{20} \\
&\leq \nu_i'' \left[n + (cj)^3(m - 1) \right] \tag{21}
\end{aligned}$$

Inequality (20) follows since $(cj - 1)^3 \leq (cj)^3 - (cj)^2$ and $(cw)^3(\hat{m} - 1) \leq c^3(m - 1)$. Inequality (21) will follow from (20) if ν_i'' satisfies

$$\nu_i'' \geq \nu_{i-1}'' + 2\nu_i' + 2 = \nu_{i-1}'' + 6\binom{i+1}{2} + 8 \tag{22}$$

Again, one may confirm that $\nu_i'' = 6\binom{i+2}{3} + 8i$ satisfies (22). We are now ready to calculate a lower bound constraint on $\mu_{5,i}$. By Recurrence 7.7 and the inductive hypothesis we have

$$\begin{aligned}
\lambda_5(n, m) &\leq \sum_{q=1}^{\hat{m}} \lambda_5(\tilde{n}_q, m_q) + 2 \cdot \lambda_4(\hat{n}, m) + \lambda_3(\Phi''(\hat{n}, \hat{m}), m) + \lambda_2(\lambda_5(\hat{n}, \hat{m}), 2m - 1) \\
&\leq \mu_{5,i} \left[(n - \hat{n}) + (cj - 1)^3(m - \hat{m}) \right] + 2\mu_{4,i} \left[\hat{n} + (cj)^2(m - 1) \right] \\
&\quad + \mu_{3,i} \left[\nu_{i-1}'' \left[\hat{n} + (cw)^3(\hat{m} - 1) \right] + (cj)(m - 1) \right] \\
&\quad + 2\mu_{5,i-1} \left[\hat{n} + (cw)^3(\hat{m} - 1) \right] + 2(m - 1) \quad \{\text{inductive hypothesis}\} \\
&\leq \mu_{5,i} \left[n + (cj)^3(m - 1) \right] \\
&\quad + \left[-\mu_{5,i} + 2\mu_{4,i} + \mu_{3,i}\nu_{i-1}'' + 2\mu_{5,i-1} \right] \cdot \hat{n} \\
&\quad + \left[-(c^3j^2)\mu_{5,i} + 2(cj)^2\mu_{4,i} + c^3\mu_{3,i}\nu_{i-1}'' \right. \\
&\quad \quad \left. + (cj)\mu_{3,i} + 2(c^3)\mu_{5,i-1} + 2 \right] \cdot (m - 1) \\
&\leq \mu_{5,i} \left[n + (cj)^3(m - 1) \right] \tag{23}
\end{aligned}$$

Inequality (23) will hold so long as $\mu_{5,i}$ satisfies

$$\begin{aligned}
\mu_{5,i} &\geq 2\mu_{5,i-1} + 2\mu_{4,i} + \mu_{3,i}\nu_{i-1}'' \\
&= 2\mu_{5,i-1} + \left[2(2^{i+4} - 6(i+2)) + (3i+1) \left(6\binom{i+1}{3} + 8(i-1) \right) \right] \\
&= 2\mu_{5,i-1} + \left[2^{i+5} + (3i+1)(i+1)(i)(i-1) - 4(i+8) \right] \tag{24}
\end{aligned}$$

The bracketed term is less than 2^{i+7} , so it suffices to show that $\mu_{5,i} \geq 2\mu_{5,i-1} + 2^{i+7}$, when $i > 1$. One may confirm that $\mu_{5,i} = i \cdot 2^{i+7}$ satisfies (24).

□