

Notes on Algebraic Operads, Graph Complexes, and Willwacher's Construction

Vasily A. Dolgushev and Christopher L. Rogers

ABSTRACT. We give a detailed proof of T. Willwacher's theorem [42] which links the cohomology of the full graph complex \mathfrak{fGC} to the cohomology of the deformation complex of the operad \mathbf{Ger} , governing Gerstenhaber algebras. We also present various prerequisites required for understanding the material of [42]. In particular, we review operads, cooperads, and the cobar construction. We give a detailed exposition of the convolution Lie algebra and its properties. We prove a useful lifting property for maps from a dg operad obtained via the cobar construction. We describe in detail Willwacher's twisting construction, and then use it to work with various operads assembled from graphs, in particular, the full graph complex and its subcomplexes. These notes are loosely based on lectures given by the first author at the Graduate and Postdoc Summer School at the Center for Mathematics at Notre Dame (May 31 - June 4, 2011).

To Orit and Rosie

CONTENTS

1. Introduction	2
2. Trees	7
3. Operads, pseudo-operads, and their dual versions	11
4. Convolution Lie algebra	22
5. To invert, or not to invert: that is the question	27
6. Twisting of operads	33
7. The operad \mathbf{Gra} and its link to the operad \mathbf{Ger}	55
8. The full graph complex \mathfrak{fGC} : the first steps	58
9. Analyzing the dg operad \mathbf{TwGra}	62
10. The full graph complex \mathfrak{fGC} revisited	81
11. Deformation complex of \mathbf{Ger}	84

2000 *Mathematics Subject Classification*. Primary 18D50, 18G55.

V.A.D. was partially supported by the NSF grant DMS 0856196 and the grant FASI RF 14.740.11.0347.

C.L.R. was partially supported by the NSF grant DMS 0856196 and the German Research Foundation (DFG) through the Institutional Strategy of the University of Göttingen.

12. Tamarkin’s rigidity in the stable setting	90
13. Deformation complex of \mathbf{Ger} versus Kontsevich’s graph complex	103
Appendix A. Lemma on a quasi-isomorphism of filtered complexes	107
Appendix B. Harrison complex of the cocommutative coalgebra $S(V)$	108
Appendix C. Filtered dg Lie algebras. The Goldman-Millson theorem	111
Appendix D. Solutions to selected exercises	115
References	119

1. Introduction

In his seminal paper [22], M. Kontsevich constructed an L_∞ quasi-isomorphism from the graded Lie algebra PV_d of polyvector fields on the affine space \mathbb{R}^d to the differential graded (dg) Lie algebra of Hochschild cochains

$$(1.1) \quad C^\bullet(A) = \bigoplus_{m=0}^{\infty} \mathrm{Hom}(A^{\otimes m}, A)$$

for the polynomial algebra $A = \mathbb{R}[x^1, x^2, \dots, x^d]$. Among other things, this result implies that formal associative deformations of the algebra A can be described in terms of formal Poisson structures on \mathbb{R}^d .

According to [23], there exist many homotopy inequivalent L_∞ quasi-isomorphisms

$$(1.2) \quad PV_d \rightsquigarrow C^\bullet(A)$$

from PV_d to $C^\bullet(A)$. More precisely, the full graph complex \mathbf{fGC} (see Section 8) maps to the Chevalley-Eilenberg complex of PV_d and, using this map, one can define an action of the Lie algebra $H^0(\mathbf{fGC})$ on the homotopy classes of L_∞ quasi-isomorphisms (1.2).

In 1998, D. Tamarkin [20], [37] proposed a completely different approach to constructing L_∞ quasi-isomorphisms (1.2). His approach works for an arbitrary field \mathbb{K} of characteristic zero and it is based on several deep results such as a proof of Deligne’s conjecture on Hochschild complex [6], [25], [33], the formality for the operad of little discs [38], and the existence of a Drinfeld associator [8].

The main idea of Tamarkin’s approach to Kontsevich’s formality theorem is to use the existence of a \mathbf{Ger}_∞ -structure on the Hochschild complex $C^\bullet(A)$ (1.1), whose structure maps are expressed in terms of the cup product and insertions of cochains into a cochain. Showing the existence of such a \mathbf{Ger}_∞ -structure is the most difficult and the most interesting part of the proof. The construction of this \mathbf{Ger}_∞ -structure involves the choice of a Drinfeld associator. Furthermore, it is known [39] that different choices of Drinfeld associators result in homotopy inequivalent \mathbf{Ger}_∞ -structures.

According to [8], the set of Drinfeld associators forms a torsor (i.e. principle homogeneous space) for an infinite dimensional algebraic group \mathbf{GRT} , which is called the Grothendieck-Teichmueller group¹. This group is related to moduli of curves, to the absolute Galois group of the field of rationals, and to the theory of motives [11].

¹Following [1] we denote by \mathbf{GRT} the unipotent radical of the group introduced by Drinfeld.

In preprint [42], T. Willwacher established remarkable links² between three objects: the group GRT , the full graph complex fGC and the deformation complex of the operad Ger governing Gerstenhaber algebras. Using these links one can connect the above seemingly unrelated stories:

- Tamarkin’s approach to Kontsevich’s formality theorem based on the use of Drinfeld associators, and
- the action of the full graph complex fGC on L_∞ quasi-isomorphisms (1.2).

We refer the reader to [4], [5], and [41] for more details.

It is already clear that Willwacher’s results have important consequences for deformation quantization, and they will certainly play a very influential role in future research. The details presented in [42], however, are technically subtle and difficult to access – even for experts. Many intermediate steps in the proofs are either left for the reader, or embedded in remarks and comments throughout the text. Moreover, several key statements are proved for a particular case, and then used in their full generality.

The goal of these notes is to give a detailed proof of T. Willwacher’s theorem (See Theorem 13.2) which links the cohomology of the full graph complex fGC to the cohomology of the deformation complex of the operad Ger .

In addition, we also present here various prerequisites required for understanding the material of [42]. Thus, in Section 3, we review operads, cooperads, and the cobar construction. This construction assigns to a coaugmented cooperad \mathcal{C} a free operad $\text{Cobar}(\mathcal{C})$ with the differential defined in terms of the cooperad structure on \mathcal{C} . In Section 4, we give a detailed exposition of the convolution Lie algebra and its properties. In Section 5, we discuss homotopies of maps from $\text{Cobar}(\mathcal{C})$ and prove a useful lifting property for such maps.

In Section 6 we describe in detail Willwacher’s twisting construction Tw which assigns to a dg operad \mathcal{O} and a map³ (of dg operads)

$$(1.3) \quad \Lambda\text{Lie}_\infty \rightarrow \mathcal{O}$$

another dg operad $\text{Tw}\mathcal{O}$. We refer to $\text{Tw}\mathcal{O}$ as *the twisted version* of the (dg) operad \mathcal{O} .

Algebras over $\text{Tw}\mathcal{O}$ (satisfying minor technical conditions) can be identified with \mathcal{O} -algebras equipped with a chosen Maurer-Cartan element for the ΛLie_∞ -structure induced by the map (1.3). It is the twisting construction which gives us a convenient framework for working with various operads assembled from graphs, in particular, the full graph complex and its subcomplexes.

In Section 7, we introduce the operad Gra and define an embedding from the operad Ger to Gra .

In Section 8, we introduce the full graph complex fGC and its “connected part” $\text{fGC}_{\text{conn}} \subset \text{fGC}$. We also present a link between fGC and its subcomplex fGC_{conn} . This link allows us to reduce the question of computing cohomology of fGC to the question of computing cohomology of fGC_{conn} .

²We believe that the same link between the group GRT and the deformation complex of the operad Ger was established via different methods in paper [10] by B. Fresse.

³The dg operad ΛLie_∞ differs from the dg operad Lie_∞ governing L_∞ -algebras by a degree shift. Namely, ΛLie_∞ -structures on a cochain complex V are in bijection with Lie_∞ -structures on $s^{-1}V$.

Section 9 is devoted to a thorough analysis of the dg operad TwGra and its various suboperads. Several useful statements about suboperads of TwGra and the operad Ger are assembled in the commutative diagram (9.75) at the end of Section 9.

In Section 10, we use the results of the previous section to deduce deeper statements about the full graph complex fGC . In particular, we prove the decomposition theorem for the graph cohomology (see Theorem 10.4).

In Section 11, we introduce the deformation complex (11.2) of the operad Ger and prove a technical statement about this complex.

In Section 12, we consider the convolution Lie algebra $\text{Conv}(\text{Ger}^\vee, \text{Gra})$ with the differential coming from a natural composition $\text{Cobar}(\text{Ger}^\vee) \rightarrow \text{Ger} \rightarrow \text{Gra}$. We prove that the cohomology of $\text{Conv}(\text{Ger}^\vee, \text{Gra})$ is spanned by the class of a single given vector. In particular, $\text{Conv}(\text{Ger}^\vee, \text{Gra})$ does not have non-zero cohomology classes “coming from arities ≥ 3 ”. This statement is a version of Tamarkin’s rigidity theorem for the Gerstenhaber algebra PV_d of polyvector fields on \mathbb{K}^d , which is one of the corner stones of Tamarkin’s proof of Kontsevich’s formality theorem.

Section 13 is the culmination of our notes. In this section, we give a proof of Theorem 13.2 which links the cohomology of the “connected part” of the full graph complex fGC to the cohomology of the “connected part” of the deformation complex of the operad Ger . The cohomology of the full graph complex and the cohomology of the deformation complex of the operad Ger can be easily expressed in terms of the cohomology of their “connected parts”.

The proof of Theorem 13.2 is assembled from several building blocks. First, this proof relies on Corollary 9.25 which links the operad Ger to a suboperad of the dg operad TwGra . Second, it relies on technical Theorem 11.9 which is given in Subsection 11.2. This theorem states that the (extended) deformation complex of the operad Ger is quasi-isomorphic to a certain subcomplex. Finally, the proof of Theorem 13.2 relies on a version of Tamarkin’s rigidity (see Corollary 12.2).

We should remark that the proof of Theorem 13.2 given here is not different from the one outlined in Willwacher’s preprint [42]. We only make the logic “more linear” and fill in many omitted details.

Appendices A, B, C contain proofs of three useful statements: a lemma on a quasi-isomorphism between filtered complexes, the theorem on the Harrison homology of the cofree cocommutative coalgebra, and a version of the Goldman-Millson theorem [19]. Although all these statements are well known, it is hard to find in the literature proofs which are formulated in the desired generality.

Many minor steps in proofs are left as exercises, which are formulated in the body of the text. Appendix D at the end of the paper contains solutions to some of these exercises.

Theorem 13.2 accounts for only 30% of results of T. Willwacher’s preprint [42]. So we hope to write a separate paper, in which we will give a detailed proof of Willwacher’s theorem which links the full graph complex to the Lie algebra grt of the Grothendieck-Teichmüller group GRT .

In our exposition, we tried to follow (or rather not to follow) Serre’s suggestions from his famous lecture [36]. We hope that this text will be useful both for specialists working on operads and deformation quantization, and for graduate students interested in this subject.

Acknowledgment. We would like to thank Thomas Willwacher for numerous illuminating discussions. We are also thankful to Thomas for his patience with explaining to us various unwritten but implied claims in his paper [42]. These notes are loosely based on lectures given by V.A.D. at the Graduate and Postdoc Summer School at the Center for Mathematics at Notre Dame (May 31 - June 4, 2011). We would like to thank Samuel Evens and Michael Gekhtman for organizing such a wonderful summer school. We are thankful to our previous institution, the UC Riverside, in which we started discussing topics related to this paper. V.A.D. would like to thank Ezra Getzler for his kind offer to use his office during V.A.D.’s visit of Northwestern University in May of 2011. V.A.D. is also thankful to Brian Paljug for his remarks about early versions of the draft.

1.1. Notation and Conventions. The base field \mathbb{K} has characteristic zero. For a set X we denote by $\mathbb{K}\langle X \rangle$ the \mathbb{K} -vector space of finite linear combinations of elements in X .

The underlying symmetric monoidal category \mathfrak{C} is often the category $\mathbf{Ch}_{\mathbb{K}}$ of unbounded cochain complexes of \mathbb{K} -vector spaces or the category $\mathbf{grVect}_{\mathbb{K}}$ of \mathbb{Z} -graded \mathbb{K} -vector spaces. We will frequently use the ubiquitous combination “dg” (differential graded) to refer to algebraic objects in $\mathbf{Ch}_{\mathbb{K}}$. For a homogeneous vector v in a cochain complex (or a graded vector space), $|v|$ denotes the degree of v . We denote by \mathbf{s} (resp. \mathbf{s}^{-1}) the operation of suspension (resp. desuspension). Namely, for a cochain complex (or a graded vector space) \mathcal{V} , we have

$$(\mathbf{s}\mathcal{V})^{\bullet} = \mathcal{V}^{\bullet-1}, \quad (\mathbf{s}^{-1}\mathcal{V})^{\bullet} = \mathcal{V}^{\bullet+1}.$$

The notation $\mathbf{1}$ is reserved for the unit of the underlying symmetric monoidal category \mathfrak{C}

By a commutative algebra we always mean commutative and associative algebra. The notation \mathbf{Lie} (resp. \mathbf{Com} , \mathbf{Ger}) is reserved for the operad governing Lie algebras (resp. commutative algebras without unit, Gerstenhaber algebras without unit). Dually, the notation \mathbf{coLie} (resp. \mathbf{coCom}) is reserved for the cooperad governing Lie coalgebras (resp. cocommutative coalgebras without counit). The notation $\mathbf{CH}(x, y)$ is reserved for the Campbell-Hausdorff series in x and y .

The notation S_n is reserved for the symmetric group on n letters and $\mathbf{Sh}_{p_1, \dots, p_k}$ denotes the subset of (p_1, \dots, p_k) -shuffles in S_n , i.e. $\mathbf{Sh}_{p_1, \dots, p_k}$ consists of elements $\sigma \in S_n$, $n = p_1 + p_2 + \dots + p_k$ such that

$$\begin{aligned} \sigma(1) &< \sigma(2) < \dots < \sigma(p_1), \\ \sigma(p_1 + 1) &< \sigma(p_1 + 2) < \dots < \sigma(p_1 + p_2), \\ &\dots \\ \sigma(n - p_k + 1) &< \sigma(n - p_k + 2) < \dots < \sigma(n). \end{aligned}$$

For $i \leq j \leq n$ we denote by $\varsigma_{i,j}$ the following cycle in S_n

$$(1.4) \quad \varsigma_{i,j} = \begin{cases} (i, i+1, \dots, j-1, j) & \text{if } i < j, \\ \text{id} & \text{if } i = j. \end{cases}$$

It is clear that

$$(1.5) \quad \varsigma_{i,j}^{-1} = \begin{cases} (j, j-1, \dots, i+1, i) & \text{if } i < j, \\ \text{id} & \text{if } i = j. \end{cases}$$

For example, the set $\{\varsigma_{i,n}\}_{1 \leq i \leq n}$ is exactly the set $\text{Sh}_{n-1,1}$ of $(n-1, 1)$ -shuffles and $\{\varsigma_{1,i}^{-1}\}_{1 \leq i \leq n}$ is the set $\text{Sh}_{1,n-1}$ of $(1, n-1)$ -shuffles.

For a group G and a G -module W , the notation W^G (resp. W_G) is reserved for the subspace of G -invariants (resp. the quotient space of G -coinvariants).

For an operad \mathcal{O} (resp. a cooperad \mathcal{C}) and a cochain complex V , the notation $\mathcal{O}(V)$ (resp. $\mathcal{C}(V)$) is reserved for the free \mathcal{O} -algebra (resp. cofree \mathcal{C} -coalgebra). Namely,

$$(1.6) \quad \mathcal{O}(V) := \bigoplus_{n \geq 0} \left(\mathcal{O}(n) \otimes V^{\otimes n} \right)_{S_n},$$

$$(1.7) \quad \mathcal{C}(V) := \bigoplus_{n \geq 0} \left(\mathcal{C}(n) \otimes V^{\otimes n} \right)^{S_n}.$$

For an augmented operad \mathcal{O} (in $\text{Ch}_{\mathbb{K}}$) we denote by \mathcal{O}_o the kernel of the augmentation. Dually, for a coaugmented cooperad \mathcal{C} (in $\text{Ch}_{\mathbb{K}}$) we denote by \mathcal{C}_o the cokernel of the coaugmentation. (We refer the reader to Subsections 3.3.1 and 3.5.1 for more details.)

For a groupoid \mathcal{G} the notation $\pi_0(\mathcal{G})$ is reserved for the set of its isomorphism classes.

A directed graph (resp. graph) Γ is a pair $(V(\Gamma), E(\Gamma))$, where $V(\Gamma)$ is a finite non-empty set and $E(\Gamma)$ is a set of ordered (resp. unordered) pairs of elements of $V(\Gamma)$. Elements of $V(\Gamma)$ are called vertices and elements of $E(\Gamma)$ are called edges. We say that a directed graph (resp. graph) Γ is labeled if it is equipped with a bijection between the set $V(\Gamma)$ and the set of numbers $\{1, 2, \dots, |V(\Gamma)|\}$. We allow a graph with the empty set of edges.

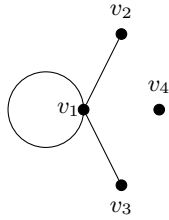

FIG.
1. A
graph Γ

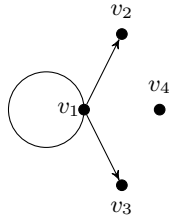

FIG.
2. A
directed
graph
 Γ'

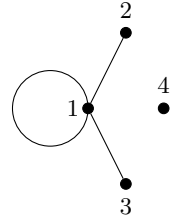

FIG.
3. A
labeled
graph
 Γ''

For example, the graph Γ on figure 1 has

$$V(\Gamma) = \{v_1, v_2, v_3, v_4\} \quad \text{and} \quad E(\Gamma) = \{\{v_1, v_1\}, \{v_2, v_1\}, \{v_1, v_3\}\}.$$

For the directed graph Γ' on figure 2 we have

$$V(\Gamma') = \{v_1, v_2, v_3, v_4\} \quad \text{and} \quad E(\Gamma') = \{(v_1, v_1), (v_1, v_2), (v_1, v_3)\}.$$

Finally, figure 3 gives us an example of a labeled graph.

A valency of a vertex v in a (directed) graph Γ is the total number of its appearances in the pairs $E(\Gamma)$. For example, vertex v_1 in the graph on figure 2 has valency 4.

2. Trees

A connected graph without cycles is called a tree. In this paper all trees are *planted*, i.e. each tree has a marked vertex (called the *root*) and this marked vertex has valency 1. (In particular, each tree has at least one edge.) The edge adjacent to the root vertex is called the *root edge*. Non-root vertices of valency 1 are called *leaves*. A vertex is called *internal* if it is neither a root nor a leaf. We always orient trees in the direction towards the root. Thus every internal vertex has at least 1 incoming edge and exactly 1 outgoing edge. An edge adjacent to a leaf is called *external*. We allow a degenerate tree, that is a tree with exactly two vertices (the root vertex and a leaf) connected by a single edge. A tree \mathbf{t} is called *planar* if, for every internal vertex v of \mathbf{t} , the set of edges terminating at v carries a total order.

Let us recall that for every planar tree \mathbf{t} the set $V(\mathbf{t})$ of all its vertices is equipped with a natural total order. To define this total order on $V(\mathbf{t})$ we introduce the function

$$(2.1) \quad \mathcal{N} : V(\mathbf{t}) \rightarrow V(\mathbf{t}).$$

To a non-root vertex v the function \mathcal{N} assigns the next vertex along the (unique) path connecting v to the root vertex. Furthermore \mathcal{N} sends the root vertex to the root vertex.

Let v_1, v_2 be two distinct vertices of \mathbf{t} . If v_1 lies on the path which connects v_2 to the root vertex then we declare that

$$v_1 < v_2.$$

Similarly, if v_2 lies on the path which connects v_1 to the root vertex then we declare that

$$v_2 < v_1.$$

If neither of the above options realize then there exist numbers k_1 and k_2 such that

$$(2.2) \quad \mathcal{N}^{k_1}(v_1) = \mathcal{N}^{k_2}(v_2)$$

but

$$\mathcal{N}^{k_1-1}(v_1) \neq \mathcal{N}^{k_2-1}(v_2).$$

Since the tree \mathbf{t} is planar the set of $\mathcal{N}^{-1}(\mathcal{N}^{k_1}(v_1))$ is equipped with a total order. Furthermore, since both vertices $\mathcal{N}^{k_1-1}(v_1)$ and $\mathcal{N}^{k_2-1}(v_2)$ belong to the set $\mathcal{N}^{-1}(\mathcal{N}^{k_1}(v_1))$, we may compare them with respect to this order.

We declare that, if $\mathcal{N}^{k_1-1}(v_1) < \mathcal{N}^{k_2-1}(v_2)$, then

$$v_1 < v_2.$$

Otherwise we set $v_2 < v_1$.

It is not hard to see that the resulting relation $<$ on $V(\mathbf{t})$ is indeed a total order.

The total order on $V(\mathbf{t})$ can be defined graphically. Indeed, draw a planar tree \mathbf{t} on the plane. Then choose a small tubular neighborhood of \mathbf{t} on the plane and walk along its boundary starting from a vicinity of the root vertex in the clockwise direction. On our way, we will meet each vertex of \mathbf{t} at least once. So we declare that $v_1 < v_2$ if the first occurrence of v_1 precedes the first occurrence of v_2 .

For example, consider the planar tree depicted on figure 4. Following the path drawn around this tree we get

$$r < v_1 < v_2 < v_3 < v_4 < v_5 < v_6 .$$

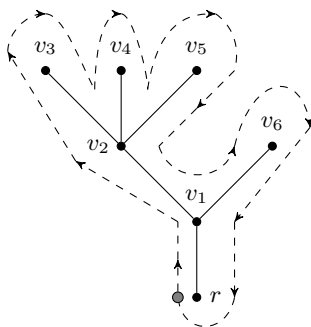

FIG. 4. We start walking around the planar tree from the gray circle

Keeping this order in mind, we can say things like “the first vertex”, “the second vertex”, and “the i -th vertex” of a planar tree \mathbf{t} . In fact, the first vertex of a tree is always its root vertex.

We have an obvious bijection between the set of edges $E(\mathbf{t})$ of a tree \mathbf{t} and the subset of vertices:

$$(2.3) \quad V(\mathbf{t}) \setminus \{\text{root vertex}\} .$$

This bijection assigns to a vertex v in (2.3) its outgoing edge.

Thus the canonical total order on the set (2.3) gives us a natural total order on the set of edges $E(\mathbf{t})$.

For our purposes we also extend the total orders on the sets $V(\mathbf{t}) \setminus \{\text{root vertex}\}$ and $E(\mathbf{t})$ to the disjoint union

$$(2.4) \quad V(\mathbf{t}) \setminus \{\text{root vertex}\} \sqcup E(\mathbf{t})$$

by declaring that a vertex is bigger than its outgoing edge. For example, the root edge is the minimal element in the set (2.4).

2.1. Groupoid of labeled planar trees. Let n be a non-negative integer. An n -labeled planar tree \mathbf{t} is a planar tree equipped with an injective map

$$(2.5) \quad \Gamma : \{1, 2, \dots, n\} \rightarrow L(\mathbf{t})$$

from the set $\{1, 2, \dots, n\}$ to the set $L(\mathbf{t})$ of leaves of \mathbf{t} . Although the set $L(\mathbf{t})$ has a natural total order we do not require that the map (2.5) is monotonous.

The set $L(\mathbf{t})$ of leaves of an n -labeled planar tree \mathbf{t} splits into the disjoint union of the image $l(\{1, 2, \dots, n\})$ and its complement. We call leaves in the image of l *labeled*.

A vertex x of an n -labeled planar tree \mathbf{t} is called *nodal* if it is neither a root vertex, nor a labeled leaf. We denote by $V_{\text{nod}}(\mathbf{t})$ the set of all nodal vertices of \mathbf{t} . Keeping in mind the canonical total order on the set of all vertices of \mathbf{t} we can say things like “the first nodal vertex”, “the second nodal vertex”, and “the i -th nodal vertex”.

EXAMPLE 2.1. An example of a 4-labeled planar tree is depicted on figure 5. On figures we use small white circles for nodal vertices and small black circles for

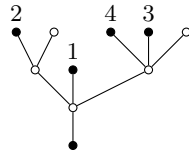

FIG. 5. A 4-labeled planar tree

labeled leaves and the root vertex.

For our purposes we need to upgrade the set of n -labeled planar trees to the groupoid $\text{Tree}(n)$. Objects of $\text{Tree}(n)$ are n -labeled planar trees and morphisms are non-planar isomorphisms of the corresponding (non-planar) trees compatible with labeling. The groupoid $\text{Tree}(n)$ is equipped with an obvious left action of the symmetric group S_n .

As far as we know the groupoid $\text{Tree}(n)$ was originally introduced by E. Getzler and M. Kapranov in [17]. However, here we do not exactly follow the notation from [17].

The notation $\text{Tree}_2(n)$ is reserved for the full sub-category of $\text{Tree}(n)$ whose objects are n -labeled planar trees with exactly 2 nodal vertices. It is not hard to see that every object in $\text{Tree}_2(n)$ has at most $n + 1$ leaves. Due to Exercise 2.2, isomorphism classes of $\text{Tree}_2(n)$ are in bijection with the union

$$(2.6) \quad \bigsqcup_{0 \leq p \leq n} \text{Sh}_{p, n-p}.$$

EXERCISE 2.2. Let us assign to a shuffle $\tau \in \text{Sh}_{p, n-p}$ the n -labeled planar tree depicted on figure 6. Prove that this assignment gives us a bijection between the

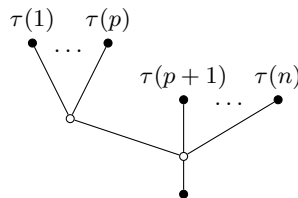

FIG. 6. Here τ is a $(p, n - p)$ -shuffle

set (2.6) and the set of isomorphism classes in $\text{Tree}_2(n)$.

REMARK 2.3. The groupoid $\text{Tree}_2(0)$ has exactly one object (see figure 7) and hence exactly one isomorphism class. The groupoid $\text{Tree}_2(1)$ has three objects and two isomorphism classes. Representatives of isomorphism classes in $\text{Tree}_2(1)$ are depicted on figures 8 and 9.



FIG. 7. The unique object in $\text{Tree}_2(0)$

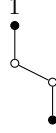

FIG. 8. A tree in $\text{Tree}_2(1)$



FIG. 9. A tree in $\text{Tree}_2(1)$

2.2. Insertions of trees. Let $\tilde{\mathbf{t}}$ be an n -labeled planar tree with a non-empty set of nodal vertices. If the i -th nodal vertex of $\tilde{\mathbf{t}}$ has m_i incoming edges then for every m_i -labeled planar tree \mathbf{t} we can define the insertion \bullet_i of the tree \mathbf{t} into the i -th nodal vertex of $\tilde{\mathbf{t}}$. The resulting planar tree $\tilde{\mathbf{t}}_{\bullet_i} \mathbf{t}$ is also n -labeled.

If $m_i = 0$ then $\tilde{\mathbf{t}}_{\bullet_i} \mathbf{t}$ is obtained via identifying the root edge of \mathbf{t} with edge originating at the i -th nodal vertex.

If $m_i > 0$ then the tree $\tilde{\mathbf{t}}_{\bullet_i} \mathbf{t}$ is built following these steps:

- First, we denote by $E_i(\tilde{\mathbf{t}})$ the set of edges terminating at the i -th nodal vertex of $\tilde{\mathbf{t}}$. Since $\tilde{\mathbf{t}}$ is planar, the set $E_i(\tilde{\mathbf{t}})$ comes with a total order;
- second, we erase the i -th nodal vertex of $\tilde{\mathbf{t}}$;
- third, we identify the root edge of \mathbf{t} with the edge of $\tilde{\mathbf{t}}$ which originates at the i -th nodal vertex;
- finally, we identify the edges of \mathbf{t} adjacent to labeled leaves with the edges in the set $E_i(\tilde{\mathbf{t}})$ following this rule: the external edge with label j gets identified with the j -th edge in the set $E_i(\tilde{\mathbf{t}})$. In doing this, we keep the same planar structure on \mathbf{t} , so, in general, branches of $\tilde{\mathbf{t}}$ move around.

EXAMPLE 2.4. Let $\tilde{\mathbf{t}}$ be the 4-labeled planar tree depicted on figure 5 and \mathbf{t} be the 3-labeled planar tree depicted on figure 10. Then the insertion $\tilde{\mathbf{t}}_{\bullet_1} \mathbf{t}$ of \mathbf{t} into the first nodal vertex of $\tilde{\mathbf{t}}$ is shown on figure 11. Figure 12 illustrates the construction algorithm of $\tilde{\mathbf{t}}_{\bullet_1} \mathbf{t}$ step by step.

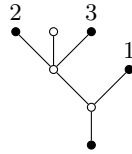

FIG. 10. A 3-labeled planar tree \mathbf{t}

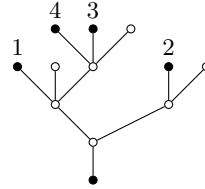

FIG. 11. The 4-labeled planar tree $\tilde{\mathbf{t}}_{\bullet_1} \mathbf{t}$

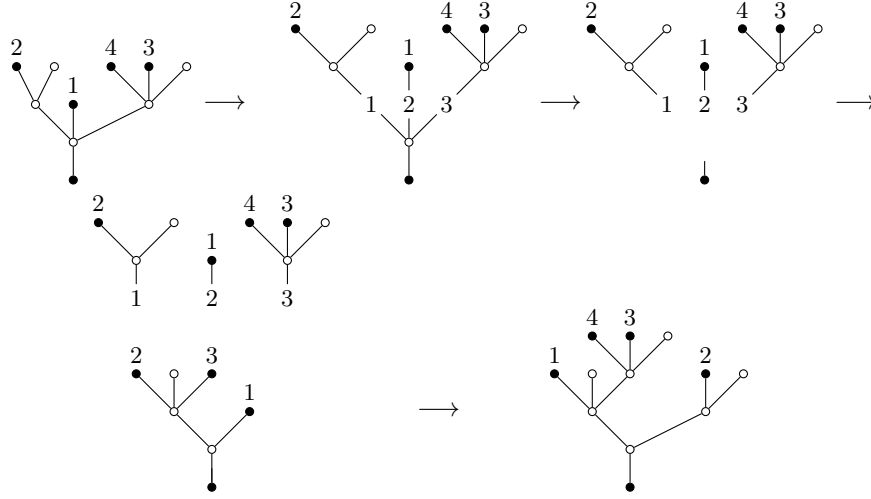

FIG. 12. Algorithm for constructing $\tilde{\mathbf{t}} \bullet_1 \mathbf{t}$

3. Operads, pseudo-operads, and their dual versions

3.1. Collections. By a *collection* we mean the sequence $\{P(n)\}_{n \geq 0}$ of objects of the underlying symmetric monoidal category \mathfrak{C} such that for each n , the object $P(n)$ is equipped with a left action of the symmetric group S_n .

Given a collection P we form covariant functors for $n \geq 0$

$$\underline{P}_n : \text{Tree}(n) \rightarrow \mathfrak{C}.$$

To an n -labelled planar tree \mathbf{t} the functor \underline{P}_n assigns the object

$$(3.1) \quad \underline{P}_n(\mathbf{t}) = \bigotimes_{x \in V_{\text{nod}}(\mathbf{t})} P(m(x)),$$

where $V_{\text{nod}}(\mathbf{t})$ is the set of all nodal vertices of \mathbf{t} , the notation $m(x)$ is reserved for the number of edges terminating at the vertex x , and the order of the factors in the right hand side of the equation agrees with the natural order on the set $V_{\text{nod}}(\mathbf{t})$.

To define the functor \underline{P}_n on the level of morphisms we use the actions of the symmetric groups and the structure of the symmetric monoidal category \mathfrak{C} in the obvious way.

EXAMPLE 3.1. Let \mathbf{t}_1 (resp. \mathbf{t}_2) be a 2-labeled planar tree depicted on figure 13 (resp. figure 14). There is a unique morphism λ from \mathbf{t}_1 to \mathbf{t}_2 in $\text{Tree}(2)$. For these trees we have

$$\underline{P}_2(\mathbf{t}_1) = P(2) \otimes P(3) \otimes P(0) \otimes P(0),$$

$$\underline{P}_2(\mathbf{t}_2) = P(2) \otimes P(0) \otimes P(3) \otimes P(0),$$

and the morphism

$$\underline{P}_2(\lambda) : P(2) \otimes P(3) \otimes P(0) \otimes P(0) \rightarrow P(2) \otimes P(0) \otimes P(3) \otimes P(0)$$

is the composition

$$\underline{P}_2(\lambda) = (1 \otimes \beta) \circ (\sigma_{12} \otimes \sigma_{13} \otimes 1 \otimes 1),$$

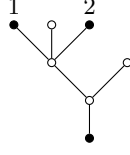

FIG. 13. A 2-labeled planar tree \mathbf{t}_1

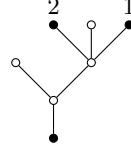

FIG. 14. A 2-labeled planar tree \mathbf{t}_2

where σ_{12} (resp. σ_{13}) is the corresponding transposition in S_2 (resp. in S_3) and β is the braiding

$$\beta : (P(3) \otimes P(0)) \otimes P(0) \rightarrow P(0) \otimes (P(3) \otimes P(0)).$$

3.2. Pseudo-operads. We now recall that a *pseudo-operad* is a collection $\{P(n)\}_{n \geq 0}$ equipped with multiplication maps

$$(3.2) \quad \mu_{\mathbf{t}} : \underline{P}_n(\mathbf{t}) \rightarrow P(n)$$

for all n -labeled trees \mathbf{t} and for all $n \geq 0$. These multiplications should satisfy the axioms which we list below.

First, we require that for the standard corolla \mathbf{q}_n (see figures 15, 16) the mul-



FIG. 15. The corolla \mathbf{q}_0

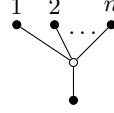

FIG. 16. The corolla \mathbf{q}_n for $n \geq 1$

tiplication map $\mu_{\mathbf{q}_n}$ is the identity morphism on $P(n)$

$$(3.3) \quad \mu_{\mathbf{q}_n} = \text{id}_{P(n)}.$$

Second, we require that the operations (3.2) are S_n -equivariant

$$(3.4) \quad \mu_{\sigma(\mathbf{t})} = \sigma \circ \mu_{\mathbf{t}}, \quad \forall \sigma \in S_n, \mathbf{t} \in \text{Tree}(n).$$

Third, for every morphism $\lambda : \mathbf{t} \rightarrow \mathbf{t}'$ in $\text{Tree}(n)$ we have

$$(3.5) \quad \mu_{\mathbf{t}'} \circ \underline{P}_n(\lambda) = \mu_{\mathbf{t}}.$$

Finally, we need to formulate the associativity axiom for multiplications (3.2). For this purpose we consider the following quadruple $(\tilde{\mathbf{t}}, i, m_i, \mathbf{t})$ where $\tilde{\mathbf{t}}$ is an n -labeled planar tree with k nodal vertices, $1 \leq i \leq k$, m_i is the number of edges terminating at the i -th nodal vertex of $\tilde{\mathbf{t}}$, and \mathbf{t} is an m_i -labeled planar tree.

The associativity axioms states that for each such quadruple $(\tilde{\mathbf{t}}, i, m_i, \mathbf{t})$ we have

$$(3.6) \quad \mu_{\tilde{\mathbf{t}}} \circ (\text{id} \otimes \cdots \otimes \text{id} \otimes \underbrace{\mu_{\mathbf{t}}}_{i\text{-th spot}} \otimes \text{id} \otimes \cdots \otimes \text{id}) \circ \beta_{\tilde{\mathbf{t}}, i, m_i, \mathbf{t}} = \mu_{\tilde{\mathbf{t}} \bullet_i \mathbf{t}}$$

where $\tilde{\mathbf{t}} \bullet_i \mathbf{t}$ is the n -labeled planar tree obtained by inserting \mathbf{t} into the i -th nodal vertex of $\tilde{\mathbf{t}}$ and $\beta_{\tilde{\mathbf{t}}, i, m_i, \mathbf{t}}$ is the isomorphism in \mathfrak{C} which is responsible for “putting tensor factors in the correct order”.

DEFINITION 3.2 (Definition 17, [32]). A pseudo-operad in $\mathbf{Ch}_{\mathbb{K}}$ (resp. $\mathbf{grVect}_{\mathbb{K}}$) is a collection P in $\mathbf{Ch}_{\mathbb{K}}$ (resp. $\mathbf{grVect}_{\mathbb{K}}$) equipped with maps

$$(3.11) \quad \circ_i : P(n) \otimes P(k) \rightarrow P(n+k-1), \quad 1 \leq i \leq n$$

satisfying the associativity axiom and equivariance axioms. The associativity axiom states that for all homogeneous vectors a, b, c in $P(n_a), P(n_b)$, and $P(n_c)$, respectively and for all $1 \leq i \leq n_a$ and $1 \leq j \leq n_a + n_b - 1$

$$(3.12) \quad (a \circ_i b) \circ_j c = \begin{cases} (-1)^{|b||c|} (a \circ_j c) \circ_{i+n_c-1} b & \text{if } j < i, \\ a \circ_i (b \circ_{j-i+1} c) & \text{if } i \leq j \leq i + n_b - 1, \\ (-1)^{|b||c|} (a \circ_{j-n_b+1} c) \circ_i b & \text{if } j \geq i + n_b. \end{cases}$$

The equivariance axioms state that for all $1 \leq p \leq n_b - 1$ and $1 \leq k \leq n_a - 1$ we have

$$(3.13) \quad a \circ_i (\sigma_p(\sigma_{p+1})b) = \sigma_{(p+i-1)(p+i)}(a \circ_i b),$$

$$(3.14) \quad (\sigma_{k(k+1)}a) \circ_i b = \begin{cases} \sigma_{k(k+1)}(a \circ_i b) & \text{if } k+1 < i \\ \varsigma_{i-1, i+n_b-1}(a \circ_{i-1} b) & \text{if } k+1 = i \\ \varsigma_{i, i+n_b}^{-1}(a \circ_{i+1} b) & \text{if } k+1 = i \\ \sigma_{(k+n_b-1)(k+n_b)}(a \circ_i b) & \text{if } k > i. \end{cases}$$

Here $\sigma_{i_1 i_2}$ denotes the transposition (i_1, i_2) and ς_{i_1, i_2} is the cycle defined in (1.4).

In [32] a pseudo-operad is called non-unital Markl's operad.

3.3. Operads. An operad is a pseudo-operad P with unit, that is a map

$$(3.15) \quad \mathbf{u} : \mathbf{1} \rightarrow P(1)$$

for which the compositions

$$(3.16) \quad \begin{aligned} P(n) &\cong P(n) \otimes \mathbf{1} \xrightarrow{\text{id} \otimes \mathbf{u}} P(n) \otimes P(1) \xrightarrow{\circ_i} P(n) \\ P(n) &\cong \mathbf{1} \otimes P(n) \xrightarrow{\mathbf{u} \otimes \text{id}} P(1) \otimes P(n) \xrightarrow{\circ_1} P(n) \end{aligned}$$

coincide with the identity map on $P(n)$.

Morphisms of pseudo-operads and operads are defined in the obvious way.

EXAMPLE 3.3. For an object \mathcal{V} of \mathfrak{C} we denote by $\text{End}_{\mathcal{V}}$ the following collection⁵

$$(3.17) \quad \text{End}_{\mathcal{V}}(n) = \text{Hom}(\mathcal{V}^{\otimes n}, \mathcal{V}).$$

This collection is equipped with the obvious structure of an operad. Namely, the elementary insertions

$$\circ_i : \text{End}_{\mathcal{V}}(n) \otimes \text{End}_{\mathcal{V}}(m) \rightarrow \text{End}_{\mathcal{V}}(n+m-1)$$

are defined by the equation

$$f \circ_i g := f \circ (\text{id}^{\otimes (i-1)} \otimes g \otimes \text{id}^{\otimes (n-i)})$$

⁵We tacitly assume that the symmetric monoidal category \mathfrak{C} has inner Hom.

and the unit

$$\mathbf{u} : \mathbf{1} \rightarrow \text{Hom}(\mathcal{V}, \mathcal{V})$$

corresponds to the isomorphism $\mathbf{1} \otimes \mathcal{V} \cong \mathcal{V}$. We call $\text{End}_{\mathcal{V}}$ the *endomorphism operad* of \mathcal{V} .

This example plays an important role because it is used in the definition of an algebra over an operad. Namely, an *algebra over an operad* P (in \mathfrak{C}) is an object \mathcal{V} of \mathfrak{C} together with an operad map

$$P \rightarrow \text{End}_{\mathcal{V}}.$$

It is not hard to see that an object \mathcal{V} in \mathfrak{C} is an algebra over an operad P if and only if \mathcal{V} is equipped with a collection of multiplication maps

$$(3.18) \quad \mu_{\mathcal{V}} : P(n) \otimes \mathcal{V}^{\otimes n} \rightarrow \mathcal{V} \quad n \geq 0,$$

satisfying the associativity axiom, the equivariance axiom and the unitality axiom formulated, for instance, in [32, Proposition 24].

EXERCISE 3.4. Let $\mathfrak{C} = \text{grVect}_{\mathbb{K}}$. Consider the collections

$$(3.19) \quad \text{Com}_u(n) = \mathbb{K},$$

and

$$(3.20) \quad \text{Com}(n) = \begin{cases} \mathbb{K} & \text{if } n \geq 1, \\ \mathbf{0} & \text{if } n = 0. \end{cases}$$

with the trivial S_n -action on $\text{Com}(n)$ (resp. $\text{Com}_u(n)$). The collections Com and Com_u are equipped with the obvious operad structures. For Com_u we have

$$\begin{aligned} \circ_i = \text{id} & : \text{Com}_u(n) \otimes \text{Com}_u(k) \cong \mathbb{K} \otimes \mathbb{K} \rightarrow \text{Com}_u(n+k-1) \cong \mathbb{K}, \\ \mathbf{u} = \text{id} & : \mathbb{K} \rightarrow \text{Com}_u(1) \cong \mathbb{K}, \end{aligned}$$

and for Com we have

$$\circ_i = \text{id} : \text{Com}(n) \otimes \text{Com}(k) \cong \mathbb{K} \otimes \mathbb{K} \rightarrow \text{Com}(n+k-1) \cong \mathbb{K},$$

if $k \neq 0$, and

$$\mathbf{u} = \text{id} : \mathbb{K} \rightarrow \text{Com}(1) \cong \mathbb{K}.$$

Show that Com_u -algebras (resp. Com -algebras) are exactly unital (resp. non-unital) commutative algebras.

EXERCISE 3.5. Let P and \mathcal{O} be operads (resp. pseudo-operad) in \mathfrak{C} . Show that the collection $P \otimes \mathcal{O}$ with

$$P \otimes \mathcal{O}(n) = P(n) \otimes \mathcal{O}(n)$$

is naturally an operad (resp. pseudo-operad). *For this exercise it may be more convenient to use Markl's definition [32, Definition 17].*

EXERCISE 3.6 (The operad Λ). Let $\mathfrak{C} = \text{grVect}_{\mathbb{K}}$ or $\mathfrak{C} = \text{Ch}_{\mathbb{K}}$. Consider the collection Λ

$$(3.21) \quad \Lambda(n) = \begin{cases} \mathbf{s}^{1-n} \text{sgn}_n & \text{if } n \geq 1 \\ \mathbf{0} & \text{if } n = 0 \end{cases}$$

with sgn_n being the sign representation of S_n . Let

$$\circ_i : \Lambda(n) \otimes \Lambda(k) \rightarrow \Lambda(n+k-1)$$

be the operations defined by

$$(3.22) \quad 1_n \circ_i 1_k = (-1)^{(1-k)(n-i)} 1_{n+k-1},$$

where 1_m denotes the generator $\mathbf{s}^{1-m} 1 \in \mathbf{s}^{1-m} \text{sgn}_m$. Prove that (3.22) together with the obvious unit map $\mathbf{u} = \text{id} : \mathbb{K} \rightarrow \Lambda(1) \cong \mathbb{K}$ equip the collection Λ with a structure of an operad. Show that Λ -algebra structures on \mathcal{V} are in bijection with Com-algebra structure on $\mathbf{s}^{-1}\mathcal{V}$.

EXERCISE 3.7. For an operad \mathcal{O} in the category $\text{Ch}_{\mathbb{K}}$ (resp. $\text{grVect}_{\mathbb{K}}$) we denote by $\Lambda\mathcal{O}$ the operad

$$(3.23) \quad \Lambda\mathcal{O} := \Lambda \otimes \mathcal{O}.$$

Show that $\Lambda\mathcal{O}$ -algebra structures on a cochain complex (resp. graded vector space) \mathcal{V} are in bijection with \mathcal{O} -algebra structures on $\mathbf{s}^{-1}\mathcal{V}$.

EXAMPLE 3.8. Let Lie be the operad which governs Lie algebras. An algebra over ΛLie in $\text{grVect}_{\mathbb{K}}$ is a graded vector space \mathcal{V} equipped with the binary operation:

$$\{, \} : \mathcal{V} \otimes \mathcal{V} \rightarrow \mathcal{V}$$

of degree -1 satisfying the identities:

$$\{v_1, v_2\} = (-1)^{|v_1||v_2|} \{v_2, v_1\},$$

$$\{\{v_1, v_2\}, v_3\} + (-1)^{|v_1|(|v_2|+|v_3|)} \{\{v_2, v_3\}, v_1\} + (-1)^{|v_3|(|v_1|+|v_2|)} \{\{v_3, v_1\}, v_2\} = 0,$$

where v_1, v_2, v_3 are homogeneous vectors in \mathcal{V} .

EXERCISE 3.9 (Free algebra over an operad \mathcal{O}). Let \mathcal{O} be an operad in the category $\text{Ch}_{\mathbb{K}}$ (resp. $\text{grVect}_{\mathbb{K}}$). Show that for every cochain complex (resp. graded vector space) \mathcal{V} the direct sum

$$(3.24) \quad \mathcal{O}(\mathcal{V}) := \bigoplus_{n=0}^{\infty} \left(\mathcal{O}(n) \otimes \mathcal{V}^{\otimes n} \right)_{S_n}$$

carries a natural structure of an algebra over \mathcal{O} . Prove that the \mathcal{O} -algebra $\mathcal{O}(\mathcal{V})$ is free. In other words, the assignment

$$\mathcal{V} \rightarrow \mathcal{O}(\mathcal{V})$$

upgrades to a functor which is left adjoint to the forgetful functor from the category of \mathcal{O} -algebras to the category $\text{Ch}_{\mathbb{K}}$ (resp. $\text{grVect}_{\mathbb{K}}$).

3.3.1. *Augmented operads.* In this subsection \mathfrak{C} is either $\text{Ch}_{\mathbb{K}}$ or $\text{grVect}_{\mathbb{K}}$.

Let us observe that the collection

$$(3.25) \quad * (n) = \begin{cases} \mathbb{K} & \text{if } n = 1 \\ \mathbf{0} & \text{otherwise} \end{cases}$$

is equipped with the unique structure of an operad. In fact, $*$ is the initial object in the category of operads (in \mathfrak{C}).

An augmentation of an operad \mathcal{O} is an operad morphism

$$\varepsilon : \mathcal{O} \rightarrow *.$$

Given a pseudo-operad P in \mathfrak{C} we can always form an operad by formally adjoining a unit. The resulting operad is naturally augmented.

Furthermore, the kernel of the augmentation for any augmented operad is naturally a pseudo-operad. According to [32, Proposition 21], these two constructions

give us an equivalence between the category of augmented operads and the category pseudo-operads.

For an augmented operad \mathcal{O} we denote by \mathcal{O}_\circ the kernel of its augmentation.

EXERCISE 3.10. Show that the operads Com and Lie have natural augmentations. Prove that the operad Com_u (from Exercise 3.4) does not admit an augmentation.

3.3.2. *Example: the operad Ger.* Let us recall that a *Gerstenhaber algebra* is a graded vector space V equipped with a commutative (and associative) product (without identity) and a degree -1 binary operation $\{ , \}$ which satisfies the following relations:

$$(3.26) \quad \{v_1, v_2\} = (-1)^{|v_1||v_2|} \{v_2, v_1\},$$

$$(3.27) \quad \{v, v_1 v_2\} = \{v, v_1\} v_2 + (-1)^{|v_1||v|+|v_1|} v_1 \{v, v_2\},$$

$$(3.28) \quad \{\{v_1, v_2\}, v_3\} + (-1)^{|v_1|(|v_2|+|v_3|)} \{\{v_2, v_3\}, v_1\} + (-1)^{|v_3|(|v_1|+|v_2|)} \{\{v_3, v_1\}, v_2\} = 0.$$

In particular, $(V, \{ , \})$ is a ΛLie -algebra.

To define spaces of the operad Ger governing Gerstenhaber algebras we introduce the free Gerstenhaber algebra Ger_n in n dummy variables a_1, a_2, \dots, a_n of degree 0. Next we set $\text{Ger}(0) = \mathbf{0}$ and $\text{Ger}(1) = \mathbb{K}$. Then we declare that, for $n \geq 2$, $\text{Ger}(n)$ is spanned by monomials of Ger_n in which each dummy variable a_i appears exactly once.

The symmetric group S_n acts on $\text{Ger}(n)$ by permuting the dummy variables and the elementary insertions are defined in the obvious way.

EXAMPLE 3.11. Let us consider the monomials $u = \{a_2, a_3\} a_1 \{a_4, a_5\} \in \text{Ger}(5)$ and $w = \{a_1, a_2\} \in \text{Ger}(2)$ and compute the insertions $u \circ_2 w$, $u \circ_4 w$ and $w \circ_1 u$. We get

$$\begin{aligned} u \circ_2 w &= -\{\{a_2, a_3\}, a_4\} a_1 \{a_5, a_6\}, & u \circ_4 w &= \{a_2, a_3\} a_1 \{\{a_4, a_5\}, a_6\}, \\ w \circ_1 u &= \{\{a_2, a_3\} a_1 \{a_4, a_5\}, a_6\} = \\ &= \{a_6, \{a_2, a_3\} a_1 \{a_4, a_5\}\} = \{a_6, \{a_2, a_3\}\} a_1 \{a_4, a_5\} \\ &\quad - \{a_2, a_3\} \{a_6, a_1\} \{a_4, a_5\} - \{a_2, a_3\} a_1 \{a_6, \{a_4, a_5\}\}. \end{aligned}$$

(Note that the insertions obey the usual Koszul rule for signs.)

It is easy to see that the operad Ger is generated by the monomials $a_1 a_2, \{a_1, a_2\} \in \text{Ger}(2)$ and algebras over the operad Ger are Gerstenhaber algebras. It is also easy to see that the monomial $\{a_1, a_2\}$ generates a suboperad of Ger isomorphic to ΛLie . The operad Ger carries the obvious augmentation.

We would like to remark that the space $\text{Ger}(n)$ is spanned by monomials $v \in \text{Ger}(n)$ of the form

$$(3.29) \quad v = v_1(a_{i_{11}}, a_{i_{12}}, \dots, a_{i_{1p_1}}) v_2(a_{i_{21}}, a_{i_{22}}, \dots, a_{i_{2p_2}}) \dots v_t(a_{i_{t1}}, a_{i_{t2}}, \dots, a_{i_{tp_t}}),$$

where v_1, v_2, \dots, v_t are ΛLie -words in p_1, p_2, \dots, p_t variables, respectively, without repetitions and

$$\{i_{11}, i_{12}, \dots, i_{1p_1}\} \sqcup \{i_{21}, i_{22}, \dots, i_{2p_2}\} \sqcup \dots \sqcup \{i_{t1}, i_{t2}, \dots, i_{tp_t}\}$$

is a partition of the set of indices $\{1, 2, \dots, n\}$. So, from now on, by a monomial in $\text{Ger}(n)$ we mean a monomial of the form (3.29).

EXERCISE 3.12. Consider the ordered partitions of the set $\{1, 2, \dots, n\}$

$$(3.30) \quad \{i_{11}, i_{12}, \dots, i_{1p_1}\} \sqcup \{i_{21}, i_{22}, \dots, i_{2p_2}\} \sqcup \dots \sqcup \{i_{t1}, i_{t2}, \dots, i_{tp_t}\}$$

satisfying the following properties:

- for each $1 \leq \beta \leq t$ the index $i_{\beta p_\beta}$ is the biggest among $i_{\beta 1}, \dots, i_{\beta(p_\beta-1)}$
- $i_{1p_1} < i_{2p_2} < \dots < i_{tp_t}$ (in particular, $i_{tp_t} = n$).

Prove that the monomials

$$(3.31) \quad \{a_{i_{11}}, \dots, \{a_{i_{1(p_1-1)}}, a_{i_{1p_1}}\}\} \dots \{a_{i_{t1}}, \dots, \{a_{i_{t(p_t-1)}}, a_{i_{tp_t}}\}\}$$

corresponding to all ordered partitions (3.30) satisfying the above properties form a basis of $\text{Ger}(n)$. Use this fact to show that

$$\dim(\text{Ger}(n)) = n!.$$

3.4. Pseudo-cooperads. Reversing the arrows in the definition of a pseudo-operad we get the definition of a pseudo-cooperad. More precisely, a pseudo-cooperad is a collection Q equipped with comultiplication maps

$$(3.32) \quad \Delta_{\mathbf{t}} : Q(n) \rightarrow \underline{Q}_n(\mathbf{t}),$$

which satisfy a similar list of axioms.

Just as for pseudo-operads, we have

$$(3.33) \quad \Delta_{\mathbf{q}_n} = \text{id}_{Q(n)},$$

where \mathbf{q}_n is the standard corolla (see figures 15, 16).

We also require that the operations (3.32) are S_n -equivariant

$$(3.34) \quad \Delta_{\sigma(\mathbf{t})} \circ \sigma = \Delta_{\mathbf{t}}, \quad \forall \sigma \in S_n, \mathbf{t} \in \text{Tree}(n).$$

For every morphism $\lambda : \mathbf{t} \rightarrow \mathbf{t}'$ in $\text{Tree}(n)$ we have

$$(3.35) \quad \Delta_{\mathbf{t}'} = \underline{Q}_n(\lambda) \circ \Delta_{\mathbf{t}}.$$

Finally, to formulate the coassociativity axiom for (3.32), we consider the following quadruple $(\tilde{\mathbf{t}}, i, m_i, \mathbf{t})$ where $\tilde{\mathbf{t}}$ is an n -labeled planar tree with k nodal vertices, $1 \leq i \leq k$, m_i is the number of edges terminating at the i -th nodal vertex of $\tilde{\mathbf{t}}$, and \mathbf{t} is an m_i -labeled planar tree.

The coassociativity axioms states that for each such quadruple $(\tilde{\mathbf{t}}, i, m_i, \mathbf{t})$ we have

$$(3.36) \quad (\text{id} \otimes \dots \otimes \text{id} \otimes \underbrace{\Delta_{\mathbf{t}}}_{i\text{-th spot}} \otimes \text{id} \otimes \dots \otimes \text{id}) \circ \Delta_{\tilde{\mathbf{t}}} = \beta_{\tilde{\mathbf{t}}, i, m_i, \mathbf{t}} \circ \Delta_{\tilde{\mathbf{t}} \bullet_i \mathbf{t}},$$

where $\tilde{\mathbf{t}} \bullet_i \mathbf{t}$ is the n -labeled planar tree obtained by inserting \mathbf{t} into the i -th nodal vertex of $\tilde{\mathbf{t}}$ and $\beta_{\tilde{\mathbf{t}}, i, m_i, \mathbf{t}}$ is the isomorphism in \mathfrak{C} which is responsible for “putting tensor factors in the correct order”.

Just as for pseudo-operads, a pseudo-cooperad structure on a collection Q is uniquely determined by the comultiplications:

$$(3.37) \quad \Delta_i := D_{\mathbf{t}_{\text{id}}^{n,k,i}} : Q(n+k-1) \rightarrow Q(n) \otimes Q(k),$$

where $\{\mathbf{t}_{\sigma}^{n,k,i}\}_{\sigma \in S_{n+k-1}}$ is the family of labeled planar trees depicted on figure 17.

The comultiplications (3.37) are called *elementary co-insertions*.

3.5. Cooperads. We recall that a cooperad is a pseudo-cooperad Q with counit, that is a map

$$(3.38) \quad \mathbf{u}^* : Q(1) \rightarrow \mathbf{1}$$

for which the compositions

$$(3.39) \quad \begin{aligned} Q(n) &\xrightarrow{\Delta_i} Q(n) \otimes Q(1) \xrightarrow{\text{id} \otimes \mathbf{u}^*} Q(n) \otimes \mathbf{1} \cong Q(n) \\ Q(n) &\xrightarrow{\Delta_1} Q(1) \otimes Q(n) \xrightarrow{\mathbf{u}^* \otimes \text{id}} \mathbf{1} \otimes Q(n) \cong Q(n) \end{aligned}$$

coincide with the identity map on $Q(n)$.

Morphisms of pseudo-cooperads and cooperads are defined in the obvious way.

Unfortunately there is no natural notion of “endomorphism cooperad”. So a coalgebra over a cooperad Q is defined as an object \mathcal{V} in \mathfrak{C} equipped with a collection of comultiplication maps

$$(3.40) \quad \Delta_{\mathcal{V}} : \mathcal{V} \rightarrow Q(n) \otimes \mathcal{V}^{\otimes n} \quad n \geq 0,$$

satisfying axioms which are dual to the associativity axiom, the equivariance axiom and the unitality axiom from [32, Proposition 24].

3.5.1. *Coaugmented cooperads.* In this subsection \mathfrak{C} is either $\text{Ch}_{\mathbb{K}}$ or $\text{grVect}_{\mathbb{K}}$.

It is not hard to see that the collection $*$ (3.25) is equipped with the unique cooperad structure. Furthermore, $*$ is the terminal object in the category of cooperads.

We say that a cooperad \mathcal{C} is coaugmented if we have a cooperad morphism

$$(3.41) \quad \varepsilon' : * \rightarrow \mathcal{C}.$$

Given a pseudo-cooperad \mathcal{C} we can always form a cooperad by formally adjoining a counit. The resulting cooperad is naturally coaugmented.

Furthermore, the cokernel of the coaugmentation for any coaugmented cooperad is naturally a pseudo-cooperad. Dualizing the line of arguments in [32, Proposition 21] we see that these two constructions give an equivalence between the category of coaugmented cooperads and the category of pseudo-cooperads.

For a coaugmented cooperad \mathcal{C} we will denote by \mathcal{C}_\circ the cokernel of the coaugmentation.

Just as for operads (see Exercise 3.5), the tensor product of two cooperads is naturally a cooperad. Furthermore, the collection Λ (3.21) introduced in Exercise 3.6 carries a cooperad structure with the following elementary co-insertions:

$$(3.42) \quad \Delta_i(1_{n+k-1}) = (-1)^{(1-k)(n-i)} 1_n \otimes 1_k,$$

where 1_m denotes the generator $\mathbf{s}^{1-m} \mathbf{1} \in \mathbf{s}^{1-m} \text{sgn}_m$.

For a cooperad \mathcal{C} in the category $\text{Ch}_{\mathbb{K}}$ or $\text{grVect}_{\mathbb{K}}$ we denote by $\Lambda \mathcal{C}$ the cooperad

$$(3.43) \quad \Lambda \mathcal{C} := \Lambda \otimes \mathcal{C}.$$

Just as for operads (see Exercise 3.7), it is easy to see that $\Lambda \mathcal{C}$ -coalgebra structures on a cochain complex (or a graded vector space) \mathcal{V} are in bijection with \mathcal{C} -coalgebra structures on $\mathbf{s}^{-1} \mathcal{V}$.

EXERCISE 3.13 (Cofree coalgebra over a cooperad \mathcal{C}). Let \mathcal{C} be a cooperad in the category $\text{Ch}_{\mathbb{K}}$ (resp. $\text{grVect}_{\mathbb{K}}$). Show that for every cochain complex (resp.

graded vector space) \mathcal{V} the direct sum

$$(3.44) \quad \mathcal{C}(\mathcal{V}) := \bigoplus_{n=0}^{\infty} \left(\mathcal{C}(n) \otimes \mathcal{V}^{\otimes n} \right)^{S_n}$$

carries a natural structure of a coalgebra over \mathcal{C} . Prove that the \mathcal{C} -coalgebra $\mathcal{C}(\mathcal{V})$ is cofree⁶. In other words, the assignment

$$\mathcal{V} \rightarrow \mathcal{C}(\mathcal{V})$$

upgrades to a functor which is right adjoint to the forgetful functor from the category of \mathcal{C} -coalgebras to the category $\mathbf{Ch}_{\mathbb{K}}$ (resp. $\mathbf{grVect}_{\mathbb{K}}$).

3.6. Free operad. In this section $\mathfrak{C} = \mathbf{Ch}_{\mathbb{K}}$ or $\mathbf{grVect}_{\mathbb{K}}$.

Let Q be a collection. Following [2, Section 5.8] the spaces $\{\Psi\mathbb{O}\mathbb{P}(Q)(n)\}_{n \geq 0}$ of the free pseudo-operad generated by the collection Q are

$$(3.45) \quad \Psi\mathbb{O}\mathbb{P}(Q)(n) = \operatorname{colim} \underline{Q}_n$$

where \underline{Q}_n is the functor from the groupoid $\mathbf{Tree}(n)$ to \mathfrak{C} defined in Subsection 3.1.

The pseudo-operad structure on $\Psi\mathbb{O}\mathbb{P}(Q)$ is defined in the obvious way using grafting of trees and the free operad $\mathbb{O}\mathbb{P}(Q)$ generated by Q is obtained from $\Psi\mathbb{O}\mathbb{P}(Q)$ by formally adjoining the unit.

Unfolding (3.45) we see that $\Psi\mathbb{O}\mathbb{P}(Q)(n)$ is the quotient of the direct sum

$$(3.46) \quad \bigoplus_{\mathbf{t} \in \mathbf{Tree}(n)} \underline{Q}_n(\mathbf{t})$$

by the subspace spanned by vectors of the form

$$(\mathbf{t}, X) - (\mathbf{t}', \underline{Q}_n(\lambda)(X))$$

where $\lambda : \mathbf{t} \rightarrow \mathbf{t}'$ is a morphism in $\mathbf{Tree}(n)$ and $X \in \underline{Q}_n(\mathbf{t})$.

Thus it is convenient to represent vectors in $\Psi\mathbb{O}\mathbb{P}(Q)$ and in $\mathbb{O}\mathbb{P}(Q)$ by labeled planar trees with nodal vertices decorated by vectors in Q . The decoration is subject to this rule: if $m(x)$ is the number of edges which terminate at a nodal vertex x then x is decorated by a vector $v_x \in Q(m(x))$.

If a decorated tree \mathbf{t}' is obtained from a decorated tree \mathbf{t} by applying an element $\sigma \in S_{m(x)}$ to incoming edges of a vertex x and replacing the vector v_x by $\sigma^{-1}(v_x)$ then \mathbf{t}' and \mathbf{t} represent the same vectors in $\Psi\mathbb{O}\mathbb{P}(Q)$ (and in $\mathbb{O}\mathbb{P}(Q)$).

EXAMPLE 3.14. Let Q be a collection. Figure 18 shows a 4-labeled planar tree \mathbf{t} decorated by vectors $v_1 \in Q(3)$, $v_2 \in Q(2)$ and $v_3 \in Q(1)$. Figure 19 shows another decorated tree with $v'_1 = \sigma_{23}(v_1)$ and $v'_2 = \sigma_{12}(v_2)$, where σ_{23} and σ_{12} are the corresponding transpositions in S_3 and S_2 , respectively. According to our discussion, these decorated trees represent the same vector in $\mathbb{O}\mathbb{P}(Q)(4)$.

REMARK 3.15. In view of the above description, generators $X \in Q(n)$ of the free operad $\mathbb{O}\mathbb{P}(Q)$ can be also written in the form

$$(\mathbf{q}_n, X),$$

where \mathbf{q}_n is the standard n -corolla (see figures 15, 16).

⁶All \mathcal{C} -coalgebras are assumed to be nilpotent in the sense of [20, Section 2.4.1].

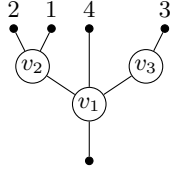

FIG. 18. A 4-labeled decorated tree \mathbf{t}

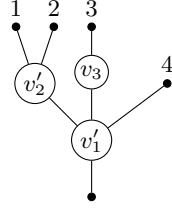

FIG. 19. A 4-labeled decorated tree $\tilde{\mathbf{t}}$. Here $v'_1 = \sigma_{23}(v_1)$ and $v'_2 = \sigma_{12}(v_2)$

3.7. Cobar construction. The underlying symmetric monoidal category \mathfrak{C} is the category $\mathbf{Ch}_{\mathbb{K}}$ of unbounded cochain complexes of \mathbb{K} -vector spaces.

The cobar construction \mathbf{Cobar} [9], [16], [18], [27, Section 6.5] is a functor from the category of coaugmented cooperads in $\mathbf{Ch}_{\mathbb{K}}$ to the category of augmented operads in $\mathbf{Ch}_{\mathbb{K}}$. It is used to construct free resolutions for operads.

Let \mathcal{C} be a coaugmented cooperad in $\mathbf{Ch}_{\mathbb{K}}$. As an operad in the category $\mathbf{grVect}_{\mathbb{K}}$, $\mathbf{Cobar}(\mathcal{C})$ is freely generated by the collection $\mathbf{s}\mathcal{C}_o$.

$$(3.47) \quad \mathbf{Cobar}(\mathcal{C}) = \mathbb{O}\mathbb{P}(\mathbf{s}\mathcal{C}_o),$$

where \mathcal{C}_o denotes the cokernel of the coaugmentation.

To define the differential $\partial^{\mathbf{Cobar}}$ on $\mathbf{Cobar}(\mathcal{C})$, we recall that $\mathbf{Tree}_2(n)$ is the full subcategory of $\mathbf{Tree}(n)$ which consists of n -labeled planar trees with exactly 2 nodal vertices and $\pi_0(\mathbf{Tree}_2(n))$ is the set of isomorphism classes in the groupoid $\mathbf{Tree}_2(n)$. Due to Exercise 2.2, the set $\pi_0(\mathbf{Tree}_2(n))$ is in bijection with $(p, n - p)$ -shuffles for all $0 \leq p \leq n$.

Since the operad $\mathbf{Cobar}(\mathcal{C})$ is freely generated by the collection $\mathbf{s}\mathcal{C}_o$, it suffices to define the differential $\partial^{\mathbf{Cobar}}$ on generators.

We have

$$\partial^{\mathbf{Cobar}} = \partial' + \partial'',$$

with

$$(3.48) \quad \partial'(X) = -\mathbf{s}\partial_{\mathcal{C}}\mathbf{s}^{-1}X,$$

and

$$(3.49) \quad \partial''(X) = - \sum_{z \in \pi_0(\mathbf{Tree}_2(n))} (\mathbf{s} \otimes \mathbf{s})(\mathbf{t}_z; \Delta_{\mathbf{t}_z}(\mathbf{s}^{-1}X)),$$

where $X \in \mathbf{s}\mathcal{C}_o(n)$, \mathbf{t}_z is any representative of the isomorphism class $z \in \pi_0(\mathbf{Tree}_2(n))$, and $\partial_{\mathcal{C}}$ is the differential on \mathcal{C} . The axioms of a pseudo-cooperad imply that the right hand side of (3.49) does not depend on the choice of representatives \mathbf{t}_z .

EXERCISE 3.16. Identity

$$\partial' \circ \partial' = 0$$

readily follows from $(\partial_{\mathcal{C}})^2 = 0$. Use the compatibility of the differential $\partial_{\mathcal{C}}$ with the cooperad structure and the coassociativity axiom (3.36) to deduce the identities

$$(3.50) \quad \partial' \circ \partial'' + \partial'' \circ \partial' = 0$$

and

$$(3.51) \quad \partial'' \circ \partial'' = 0.$$

4. Convolution Lie algebra

Let P (resp. Q) be a dg pseudo-operad (resp. a dg pseudo-cooperad). We consider the following cochain complex

$$(4.1) \quad \text{Conv}(Q, P) = \prod_{n \geq 0} \text{Hom}_{S_n}(Q(n), P(n)).$$

with the binary operation \bullet defined by the formula

$$(4.2) \quad f \bullet g(X) = \sum_{z \in \pi_0(\text{Tree}_2(n))} \mu_{\mathbf{t}_z}(f \otimes g \Delta_{\mathbf{t}_z}(X)),$$

$$f, g \in \text{Conv}(Q, P), \quad X \in Q(n),$$

where \mathbf{t}_z is any representative of the isomorphism class $z \in \pi_0(\text{Tree}_2(n))$. The axioms of pseudo-operad (resp. pseudo-cooperad) imply that the right hand side of (4.2) does not depend on the choice of representatives \mathbf{t}_z .

It follows directly from the definition that the operation \bullet is compatible with the differential on $\text{Conv}(Q, P)$ coming from Q and P . Furthermore, we claim that

PROPOSITION 4.1. *The bracket*

$$[f, g] = (f \bullet g - (-1)^{|f||g|} g \bullet f)$$

satisfies the Jacobi identity.

PROOF. We will prove the proposition by showing that the operation (4.2) satisfies the axiom of the pre-Lie algebra

$$(4.3) \quad (f \bullet g) \bullet h - f \bullet (g \bullet h) = (-1)^{|g||h|} (f \bullet h) \bullet g - (-1)^{|g||h|} f \bullet (h \bullet g),$$

where f, g, h are homogeneous vectors in $\text{Conv}(Q, P)$.

The expression $((f \bullet g) \bullet h - f \bullet (g \bullet h))(X)$ can be rewritten as

$$((f \bullet g) \bullet h - f \bullet (g \bullet h))(X) =$$

$$\sum_{z \in \pi_0(\text{Tree}_2(n))} \sum_{z' \in \pi_0(\text{Tree}_2(m_1(z)))} \mu_{\mathbf{t}_z} \circ (\mu_{\mathbf{t}_{z'}} \otimes \text{id}) \circ (f \otimes g \otimes h) \circ (\Delta_{\mathbf{t}_z'} \otimes \text{id}) \circ \Delta_{\mathbf{t}_z}(X) -$$

$$\sum_{z \in \pi_0(\text{Tree}_2(n))} \sum_{z' \in \pi_0(\text{Tree}_2(m_2(z)))} \mu_{\mathbf{t}_z} \circ (\text{id} \otimes \mu_{\mathbf{t}_{z'}}) \circ (f \otimes g \otimes h) \circ (\text{id} \otimes \Delta_{\mathbf{t}_{z'}}) \circ \Delta_{\mathbf{t}_z}(X),$$

where $m_1(z)$ (resp. $m_2(z)$) is the number of edges terminating at the first (resp. the second) nodal vertex of the planar tree \mathbf{t}_z .

Due to the axioms for the maps $\mu_{\mathbf{t}}$ and $\Delta_{\mathbf{t}}$, we get

$$((f \bullet g) \bullet h - f \bullet (g \bullet h))(X)$$

$$= \sum_{p, q \geq 0} \sum_{\tau \in \text{Sh}_{p, q, n-p-q}} \mu_{\mathbf{t}_\tau}((f \otimes g \otimes h) \Delta_{\mathbf{t}_\tau}(X))$$

where \mathbf{t}_τ is the n -labeled planar tree depicted on figure 20.

The set $\{\mathbf{t}_\tau \mid \tau \in \text{Sh}_{p, q, n-p-q}\}$ is stable under the obvious isomorphism λ which switches the second nodal vertex with the third one. Hence, we have

$$((f \bullet g) \bullet h - f \bullet (g \bullet h))(X) =$$

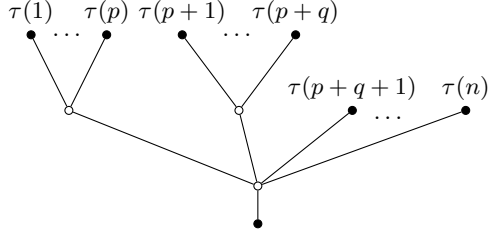
 FIG. 20. τ is a $(p, q, n - p - q)$ -shuffle

$$\sum_{p, q \geq 1} \sum_{\tau \in \text{Sh}_{p, q, n-p-q}} \mu_{\lambda(\mathbf{t}_\tau)} ((f \otimes g \otimes h) \Delta_{\lambda(\mathbf{t}_\tau)}(X)).$$

Using axioms (3.5) and (3.35) and the fact that f is equivariant with respect to the action of the symmetric group, we can rewrite the latter expression as follows

$$\begin{aligned} & ((f \bullet g) \bullet h - f \bullet (g \bullet h)) (X) = \\ & \sum_{p, q \geq 1} \sum_{\tau \in \text{Sh}_{p, q, n-p-q}} \mu_{\mathbf{t}_\tau} \circ \underline{P}_n(\lambda) \circ (f \otimes g \otimes h) \circ \underline{Q}_n(\lambda) \Delta_{\mathbf{t}_\tau}(X) = \\ & \sum_{p, q \geq 1} \sum_{\tau, \alpha} (-1)^{|X_2^{\tau, \alpha}| |X_3^{\tau, \alpha}|} \mu_{\mathbf{t}_\tau} \circ \underline{P}_n(\lambda) \circ (f \otimes g \otimes h) (\sigma_{12}(X_1^{\tau, \alpha}), X_3^{\tau, \alpha}, X_2^{\tau, \alpha}) = \\ (4.4) \quad & \sum_{p, q \geq 1} \sum_{\tau, \alpha} (-1)^{\varepsilon(\tau, \alpha, g, h)} \mu_{\mathbf{t}_\tau} \circ \underline{P}_n(\lambda) (\sigma_{12} f(X_1^{\tau, \alpha}), g(X_3^{\tau, \alpha}), h(X_2^{\tau, \alpha})) \end{aligned}$$

where σ_{12} is the transposition $(1, 2)$,

$$(4.5) \quad \Delta_{\mathbf{t}_\tau}(X) = \sum_{\alpha} (X_1^{\tau, \alpha}, X_2^{\tau, \alpha}, X_3^{\tau, \alpha}),$$

and

$$(4.6) \quad \varepsilon(\tau, \alpha, g, h) = |X_2^{\tau, \alpha}| |X_3^{\tau, \alpha}| + |h|(|X_1^{\tau, \alpha}| + |X_3^{\tau, \alpha}|) + |g| |X_1^{\tau, \alpha}|.$$

Applying $\underline{P}_n(\lambda)$ to $(\sigma_{12} f(X_1^{\tau, \alpha}), g(X_3^{\tau, \alpha}), h(X_2^{\tau, \alpha}))$ in (4.4) we get

$$\begin{aligned} & ((f \bullet g) \bullet h - f \bullet (g \bullet h)) (X) = \\ & \sum_{p, q \geq 1} \sum_{\tau, \alpha} (-1)^{\varepsilon(\tau, \alpha, g, h)} (-1)^{(|g| + |X_3^{\tau, \alpha}|)(|h| + |X_2^{\tau, \alpha}|)} \mu_{\mathbf{t}_\tau} (f(X_1^{\tau, \alpha}), h(X_2^{\tau, \alpha}), g(X_3^{\tau, \alpha})) = \\ & \sum_{p, q \geq 1} \sum_{\tau, \alpha} (-1)^{\tilde{\varepsilon}(\tau, \alpha, g, h)} \mu_{\mathbf{t}_\tau} ((f \otimes h \otimes g) \Delta_{\mathbf{t}_\tau}(X)), \end{aligned}$$

where

$$(4.7) \quad \tilde{\varepsilon}(\tau, \alpha, g, h) = \varepsilon(\tau, \alpha, g, h) + (|g| + |X_3^{\tau, \alpha}|)(|h| + |X_2^{\tau, \alpha}|) + |h| |X_1^{\tau, \alpha}| + |g| (|X_1^{\tau, \alpha}| + |X_2^{\tau, \alpha}|).$$

The direct computation shows that

$$\tilde{\varepsilon}(\tau, \alpha, g, h) = |g| |h| \pmod{2}$$

and the proposition follows. \square

4.1. A useful modification $\text{Conv}^\oplus(Q, P)$. Let us observe that for every dg pseudo-operad P and every dg pseudo-cooperad Q the subcomplex

$$(4.8) \quad \text{Conv}^\oplus(Q, P) := \bigoplus_{n \geq 0} \text{Hom}_{S_n}(Q(n), P(n)) \subset \text{Conv}(Q, P)$$

is closed with respect to the pre-Lie operation (4.2). Thus $\text{Conv}^\oplus(Q, P)$ is a dg Lie subalgebra of $\text{Conv}(Q, P)$.

We often use this subalgebra in our notes to prove facts about its completion $\text{Conv}(Q, P)$.

4.2. Example: the dg Lie algebra $\text{Conv}(\mathcal{C}_\circ, \text{End}_V)$. Let V be a cochain complex, \mathcal{C} be a coaugmented dg cooperad, and \mathcal{C}_\circ be the cokernel of the coaugmentation. We denote by $\mathcal{C}(V)$ the cofree \mathcal{C} -coalgebra cogenerated by V . Furthermore, we denote by p_V the natural projection

$$(4.9) \quad p_V : \mathcal{C}(V) \rightarrow V.$$

In this subsection we interpret $\text{Conv}(\mathcal{C}_\circ, \text{End}_V)$ as a subalgebra in the dg Lie algebra $\text{coDer}(\mathcal{C}(V))$ of coderivations of $\mathcal{C}(V)$.

Let us recall [16, Proposition 2.14] that the map

$$(4.10) \quad \mathcal{D} \mapsto p_V \circ \mathcal{D}$$

defines an isomorphism of cochain complexes

$$\text{coDer}(\mathcal{C}(V)) \cong \text{Hom}(\mathcal{C}(V), V).$$

Then we observe that coderivations $\mathcal{D} \in \text{coDer}(\mathcal{C}(V))$ satisfying the property

$$(4.11) \quad \mathcal{D}|_V = 0$$

form a dg Lie subalgebra of $\text{coDer}(\mathcal{C}(V))$. We denote this dg Lie subalgebra by $\text{coDer}'(\mathcal{C}(V))$.

Next, we remark that the formula

$$(4.12) \quad p \circ \mathcal{D}_f(\gamma; v_1, v_2, \dots, v_n) = f(\gamma)(v_1, v_2, \dots, v_n)$$

$$f \in \text{Conv}(\mathcal{C}_\circ, \text{End}_V), \quad \gamma \in \mathcal{C}_\circ(n), \quad v_1, v_2, \dots, v_n \in V$$

defines a map (of graded vector spaces)

$$(4.13) \quad f \mapsto \mathcal{D}_f : \text{Conv}(\mathcal{C}_\circ, \text{End}_V) \rightarrow \text{coDer}'(\mathcal{C}(V)).$$

Finally, we claim that⁷

PROPOSITION 4.2. *For every cochain complex V and for every coaugmented dg cooperad \mathcal{C} the map (4.13) is an isomorphism of dg Lie algebras*

$$\text{Conv}(\mathcal{C}_\circ, \text{End}_V) \cong \text{coDer}'(\mathcal{C}(V)).$$

A proof of this proposition is straightforward so we leave it as an exercise.

EXERCISE 4.3. Prove Proposition 4.2.

⁷Proposition 4.2 is a version of [16, Proposition 2.15].

4.3. What if $Q(n)$ is finite dimensional for all n ? Let us assume that the pseudo-cooperad Q satisfies the property

PROPERTY 4.4. For each n the graded vector space $Q(n)$ is finite dimensional.

Due to this property we have

$$(4.14) \quad \text{Conv}(Q, P) \cong \prod_{n \geq 0} (P(n) \otimes Q^*(n))^{S_n}.$$

where $Q^*(n)$ denotes the linear dual of the vector space $Q(n)$.

The collection $Q^* := \{Q^*(n)\}_{n \geq 0}$ is naturally a pseudo-operad and we can express the pre-Lie structure (4.2) in terms of elementary insertions on P and Q^* . Namely, given two vectors

$$X = \sum_{n \geq 0} v_n \otimes w_n, \quad X' = \sum_{n \geq 0} v'_n \otimes w'_n$$

in

$$\prod_{n \geq 0} (P(n) \otimes Q^*(n))^{S_n},$$

we have

$$(4.15) \quad X \bullet X' = \sum_{n \geq 1, m \geq 0} (-1)^{|v'_m||w_n|} \sum_{\sigma \in \text{Sh}_{m, n-1}} \sigma(v_n \circ_1 v'_m) \otimes \sigma(w_n \circ_1 w'_m).$$

4.4. The functors $\text{Conv}(Q, ?)$ and $\text{Conv}(?, P)$ preserve quasi-isomorphisms.

It often happens that a pseudo-cooperad Q is equipped with a cocomplete ascending filtration

$$(4.16) \quad \mathbf{0} = \mathcal{F}^0 Q \subset \mathcal{F}^1 Q \subset \mathcal{F}^2 Q \subset \dots$$

$$\text{colim}_m \mathcal{F}^m Q(n) = Q(n) \quad \forall n$$

which is compatible with comultiplications $\Delta_{\mathbf{t}}$ in the following sense:

$$(4.17) \quad \Delta_{\mathbf{t}}(\mathcal{F}^m Q(n)) \subset \bigoplus_{q_1 + q_2 + \dots + q_k = m} \mathcal{F}^{q_1} Q(r_1) \otimes \mathcal{F}^{q_2} Q(r_2) \otimes \dots \otimes \mathcal{F}^{q_k} Q(r_k),$$

where \mathbf{t} is an n -labeled planar tree with k nodal vertices and r_i is the number of edges terminating at the i -th nodal vertex of \mathbf{t} .

DEFINITION 4.5. If a pseudo-cooperad Q is equipped with such a filtration then we say that Q is cofiltered.

EXERCISE 4.6. Let us recall that a coaugmented (dg) cooperad \mathcal{C} is called reduced if

$$\mathcal{C}(0) = \mathbf{0}, \quad \text{and} \quad \mathcal{C}(1) = \mathbb{K}.$$

For every reduced coaugmented cooperad \mathcal{C} , the cokernel of the coaugmentation \mathcal{C}_o carries the ascending filtration “by arity”:

$$(4.18) \quad \mathcal{F}^m \mathcal{C}_o(n) = \begin{cases} \mathcal{C}_o(n) & \text{if } n \leq m + 1 \\ \mathbf{0} & \text{otherwise.} \end{cases}$$

Show that this filtration is cocomplete and compatible with comultiplications $\Delta_{\mathbf{t}}$ in the sense of (4.17).

For any dg operad P and for any cofiltered dg pseudo-cooperad Q the dg Lie algebra $\text{Conv}(Q, P)$ is equipped with the descending filtration

$$(4.19) \quad \text{Conv}(Q, P) = \mathcal{F}_1 \text{Conv}(Q, P) \supset \mathcal{F}_2 \text{Conv}(Q, P) \supset \mathcal{F}_3 \text{Conv}(Q, P) \supset \dots, \\ \mathcal{F}_m \text{Conv}(Q, P) = \{f \in \text{Conv}(Q, P) \mid f(X) = 0 \quad \forall X \in \mathcal{F}^{m-1}(Q)\}.$$

Inclusion (4.17) implies that the filtration on $\text{Conv}(Q, P)$ is compatible with the Lie bracket. Furthermore, since the filtration on Q is cocomplete, the filtration (4.19) is complete

$$(4.20) \quad \lim_m \text{Conv}(Q, P) / \mathcal{F}_m \text{Conv}(Q, P) = \text{Conv}(Q, P).$$

Any morphism of dg pseudo-operads

$$(4.21) \quad f : P \rightarrow P'.$$

induces the obvious map of dg Lie algebras

$$(4.22) \quad f_* : \text{Conv}(Q, P) \rightarrow \text{Conv}(Q, P').$$

We claim that

THEOREM 4.7. *If the map (4.21) is a quasi-isomorphism then so is the map (4.22). In addition, if Q is cofiltered, then the restriction of f_* onto $\mathcal{F}_m \text{Conv}(Q, P)$*

$$f_* \Big|_{\mathcal{F}_m \text{Conv}(Q, P)} : \mathcal{F}_m \text{Conv}(Q, P) \rightarrow \mathcal{F}_m \text{Conv}(Q, P')$$

is a quasi-isomorphism for all m .

PROOF. According to [40, Section 1.4], every cochain complex of \mathbb{K} -vector spaces is chain homotopy equivalent to its cohomology.

Therefore, there exist collections of maps

$$(4.23) \quad g_n : P'(n) \rightarrow P(n)$$

$$(4.24) \quad \chi_n : P(n) \rightarrow P(n)$$

$$(4.25) \quad \chi'_n : P'(n) \rightarrow P'(n)$$

such that

$$(4.26) \quad f_n \circ g_n - \text{id}_{P'(n)} = \partial \chi'_n + \chi'_n \partial,$$

and

$$(4.27) \quad g_n \circ f_n - \text{id}_{P(n)} = \partial \chi_n + \chi_n \partial.$$

In other words, $f_n \circ g_n$ (resp. $g_n \circ f_n$) is homotopic to $\text{id}_{P'(n)}$ (resp. $\text{id}_{P(n)}$).

In general, the set of maps $\{g_n\}_{n \geq 0}$ gives us neither a map of operads nor a map of the underlying collections. Similarly, the maps (4.24) and (4.25) may not be S_n -equivariant.

For this reason we switch from the set $\{g_n\}_{n \geq 0}$ to the set

$$(4.28) \quad \tilde{g}_n = \frac{1}{(n!)^2} \sum_{\sigma, \tau \in S_n} \sigma \circ g_n \circ \tau.$$

It is easy to see these new maps \tilde{g}_n give us a morphism of the underlying collections. Moreover, equations (4.26) and (4.27) imply the identities

$$(4.29) \quad f_n \circ \tilde{g}_n - \text{id}_{P'(n)} = \partial \tilde{\chi}'_n + \tilde{\chi}'_n \partial,$$

and

$$(4.30) \quad \tilde{g}_n \circ f_n - \text{id}_{P(n)} = \partial \tilde{\chi}_n + \tilde{\chi}_n \partial$$

with S_n -equivariant homotopy operators

$$(4.31) \quad \tilde{\chi}_n = \frac{1}{(n!)^2} \sum_{\sigma, \tau \in S_n} \sigma \circ \chi_n \circ \tau,$$

$$(4.32) \quad \tilde{\chi}'_n = \frac{1}{(n!)^2} \sum_{\sigma, \tau \in S_n} \sigma \circ \chi'_n \circ \tau.$$

Let us now consider the map

$$(4.33) \quad \tilde{g}_* : \text{Conv}(Q, P') \rightarrow \text{Conv}(Q, P)$$

In general \tilde{g}_* is not compatible with the Lie brackets. Regardless, using equations (4.29), (4.30) and S_n -equivariance of the homotopy operators (4.31), (4.32), it is not hard to see that the compositions $f_* \circ \tilde{g}_*$ and $\tilde{g}_* \circ f_*$ are homotopic to $\text{id}_{\text{Conv}(Q, P')}$ and $\text{id}_{\text{Conv}(Q, P)}$, respectively.

Thus f_* is indeed a quasi-isomorphism.

To prove the second statement we denote by f_*^m and \tilde{g}_*^m the restriction of f_* and \tilde{g}_* onto

$$\mathcal{F}_m \text{Conv}(Q, P) \quad \text{and} \quad \mathcal{F}_m \text{Conv}(Q, P')$$

respectively.

Using the same homotopy operators (4.31), (4.32), it is not hard to see that the compositions $f_*^m \circ \tilde{g}_*^m$ and $\tilde{g}_*^m \circ f_*^m$ are homotopic to $\text{id}_{\mathcal{F}_m \text{Conv}(Q, P')}$ and $\text{id}_{\mathcal{F}_m \text{Conv}(Q, P)}$, respectively.

Theorem 4.7 is proved. \square

EXERCISE 4.8. Using the ideas of the above proof, show that the (contravariant) functor $\text{Conv}(?, P)$ also preserves quasi-isomorphisms.

5. To invert, or not to invert: that is the question

Let \mathcal{C} be a coaugmented dg cooperad and \mathcal{C}_\circ be the cokernel of the coaugmentation. This section is devoted to the lifting property for maps from the dg operad $\text{Cobar}(\mathcal{C})$. The material contained in this section is an adaptation of constructions from [34] to the setting of dg operads.

First, we observe that, since $\text{Cobar}(\mathcal{C})$ is freely generated by $\mathfrak{s}\mathcal{C}_\circ$, any map of dg operads

$$(5.1) \quad F : \text{Cobar}(\mathcal{C}) \rightarrow \mathcal{O}$$

is uniquely determined by its restriction to generators:

$$F \Big|_{\mathfrak{s}\mathcal{C}_\circ} : \mathfrak{s}\mathcal{C}_\circ \rightarrow \mathcal{O}.$$

Hence, composing the latter map with the suspension operator \mathfrak{s} , we get a degree one element

$$(5.2) \quad \alpha_F \in \text{Conv}(\mathcal{C}_\circ, \mathcal{O})$$

in the dg Lie algebra $\text{Conv}(\mathcal{C}_\circ, \mathcal{O})$.

EXERCISE 5.1. Prove that the compatibility of F with the differentials on $\text{Cobar}(\mathcal{C})$ and \mathcal{O} is equivalent to the Maurer-Cartan equation for the element α_F (5.2) in $\text{Conv}(\mathcal{C}_\circ, \mathcal{O})$.

Thus we arrive at the following proposition

PROPOSITION 5.2. *For an arbitrary coaugmented dg cooperad \mathcal{C} and for an arbitrary dg operad \mathcal{O} , the correspondence*

$$F \mapsto \alpha_F$$

is a bijection between the set of maps (of dg operads) (5.1) and the set of Maurer-Cartan elements in $\text{Conv}(\mathcal{C}_\circ, \mathcal{O})$. \square

Combining Proposition 4.2 with 5.2 we deduce the following Corollary

COROLLARY 5.3. *For every coaugmented dg cooperad \mathcal{C} and for every cochain complex V the set of $\text{Cobar}(\mathcal{C})$ -algebra structures on V is in bijection with the set of Maurer-Cartan elements in the dg Lie algebra*

$$\text{coDer}'(\mathcal{C}(V)) := \left\{ \mathcal{D} \in \text{coDer}(\mathcal{C}(V)) \mid \mathcal{D}|_V = 0 \right\}. \square$$

5.1. Homotopies of maps from $\text{Cobar}(\mathcal{C})$. Let $\Omega^\bullet(\mathbb{K}) = \mathbb{K}[t] \oplus \mathbb{K}[t]dt$ be the polynomial de Rham algebra on the affine line with dt sitting in degree 1. We denote by

$$\mathcal{O}^I := \mathcal{O} \otimes \Omega^\bullet(\mathbb{K})$$

the dg operad with underlying collection

$$\{\mathcal{O}(n) \otimes \Omega^\bullet(\mathbb{K})\}_{n \geq 0}.$$

We also denote by p_0, p_1 the obvious maps of dg operads

$$(5.3) \quad \begin{aligned} p_0 : \mathcal{O}^I &\rightarrow \mathcal{O}, & p_0(X) &= X \Big|_{t=0, dt=0}, \\ p_1 : \mathcal{O}^I &\rightarrow \mathcal{O}, & p_1(X) &= X \Big|_{t=1, dt=0}. \end{aligned}$$

For our purposes we will use the following ‘‘pedestrian’’ definition of homotopy between maps $F, \tilde{F} : \text{Cobar}(\mathcal{C}) \rightarrow \mathcal{O}$.

DEFINITION 5.4. We say that maps of dg operads

$$F, \tilde{F} : \text{Cobar}(\mathcal{C}) \rightarrow \mathcal{O}$$

are homotopic if there exists a map of dg operads

$$H : \text{Cobar}(\mathcal{C}) \rightarrow \mathcal{O}^I$$

such that

$$F = p_0 \circ H \quad \text{and} \quad \tilde{F} = p_1 \circ H.$$

REMARK 5.5. Definition 5.4 leaves out many questions and some of these questions may be answered by constructing a closed model structure on a subcategory of dg operads satisfying certain technical conditions. Unfortunately, many dg operads which show up in applications do not satisfy required technical conditions. We hope that all such issues will be resolved in yet another ‘‘infinity’’ treatise [30] of J. Lurie.

We now state a theorem which characterizes homotopic maps from $\text{Cobar}(\mathcal{C})$ in terms of the corresponding Maurer-Cartan elements in $\text{Conv}(\mathcal{C}_\circ, \mathcal{O})$.

THEOREM 5.6. *Let \mathcal{O} be an arbitrary dg operad and \mathcal{C} be a coaugmented dg cooperad for which the pseudo-operad \mathcal{C}_\circ is cofiltered (see Definition 4.5) and the vector space*

$$(5.4) \quad \bigoplus_{n \geq 0} \mathcal{F}^m \mathcal{C}_\circ(n)$$

is finite dimensional for all m . Then two maps of dg operads

$$F, \tilde{F} : \text{Cobar}(\mathcal{C}) \rightarrow \mathcal{O}$$

are homotopic if and only if the corresponding Maurer-Cartan elements

$$\alpha_F, \alpha_{\tilde{F}} \in \text{Conv}(\mathcal{C}_\circ, \mathcal{O})$$

are isomorphic⁸.

PROOF. Let

$$(5.5) \quad \text{Conv}(\mathcal{C}_\circ, \mathcal{O})\{t\}$$

be the dg Lie subalgebra of $\text{Conv}(\mathcal{C}_\circ, \mathcal{O})[[t]]$ which consists of infinite series

$$(5.6) \quad f = \sum_{k=0}^{\infty} f_k t^k, \quad f_k \in \mathcal{F}_{m_k} \text{Conv}(\mathcal{C}_\circ, \mathcal{O})$$

satisfying the condition

$$(5.7) \quad m_1 \leq m_2 \leq m_3 \leq \dots \quad \lim_{k \rightarrow \infty} m_k = \infty.$$

Combining condition (5.7) together with the fact that the filtration on \mathcal{C}_\circ is cocomplete, we conclude that, for every $X \in \mathcal{C}_\circ(n)$ and for every f in (5.5), the sum

$$\sum_{k=0}^{\infty} f_k(X) t^k$$

has only finitely many non-zero terms.

Therefore, the formula

$$(5.8) \quad \Psi(f)(X) = \sum_{k=0}^{\infty} f_k(X) t^k, \quad X \in \mathcal{C}_\circ(n)$$

defines a map

$$\Psi : \text{Conv}(\mathcal{C}_\circ, \mathcal{O})\{t\} \rightarrow \text{Conv}(\mathcal{C}_\circ, \mathcal{O}[t]).$$

Let us now consider a vector $g \in \text{Conv}(\mathcal{C}_\circ, \mathcal{O}[t])$.

Since the vector spaces

$$\bigoplus_{n \geq 0} \mathcal{F}^{m-1} \mathcal{C}_\circ(n)$$

are finite dimensional, for each m there exists a positive integer N_m such that the polynomials

$$g(X) = \sum_{k \geq 0} g_k(X) t^k$$

⁸We view Maurer-Cartan elements as objects of the Deligne groupoid. See Appendix C for details.

have degrees $\leq N_m$ for all $X \in \mathcal{F}^{m-1}\mathcal{C}_\circ(n)$ and for all n . Moreover, the integers $\{N_m\}_{m \geq 1}$ can be chosen in such a way that

$$N_1 \leq N_2 \leq N_3 \leq \dots$$

Therefore, the formula:

$$(5.9) \quad \Psi'(g) = \sum_{k=0}^{\infty} \Psi'_k(g)t^k$$

$$\Psi'_k(g)(X) := g_k(X), \quad X \in \mathcal{C}_\circ$$

defines a map

$$\Psi' : \text{Conv}(\mathcal{C}_\circ, \mathcal{O}[t]) \rightarrow \text{Conv}(\mathcal{C}_\circ, \mathcal{O})\{t\}.$$

Furthermore, it is easy to see that Ψ' is the inverse of Ψ .

Thus the dg Lie algebras $\text{Conv}(\mathcal{C}_\circ, \mathcal{O}[t])$ and $\text{Conv}(\mathcal{C}_\circ, \mathcal{O})\{t\}$ are naturally isomorphic.

To prove the “only if” part we start with a map of dg operads

$$H : \text{Cobar}(\mathcal{C}) \rightarrow \mathcal{O}^I$$

which establishes a homotopy between F and \tilde{F} and let

$$(5.10) \quad \alpha_H = \alpha_H^{(1)} + \alpha_H^{(0)} dt \in \text{Conv}(\mathcal{C}_\circ, \mathcal{O}^I)$$

be the Maurer-Cartan element corresponding to H . Here $\alpha_H^{(1)}$ (resp. $\alpha_H^{(0)}$) is a degree 1 (resp. degree 0) vector in $\text{Conv}(\mathcal{C}_\circ, \mathcal{O}[t]) \cong \text{Conv}(\mathcal{C}_\circ, \mathcal{O})\{t\}$.

The Maurer-Cartan equation for α_H

$$dt \frac{d}{dt} \alpha_H + \partial \alpha_H + \frac{1}{2} [\alpha_H, \alpha_H] = 0$$

is equivalent to the pair of equations

$$(5.11) \quad \partial \alpha_H^{(1)} + \frac{1}{2} [\alpha_H^{(1)}, \alpha_H^{(1)}] = 0$$

and

$$(5.12) \quad \frac{d}{dt} \alpha_H^{(1)} = \partial \alpha_H^{(0)} - [\alpha_H^{(0)}, \alpha_H^{(1)}].$$

Using equations (5.11) and (5.12) we deduce from [4, Theorem C.1, App. C] that the Maurer-Cartan elements

$$\alpha_H^{(1)} \Big|_{t=0} \quad \text{and} \quad \alpha_H^{(1)} \Big|_{t=1}$$

in $\text{Conv}(\mathcal{C}_\circ, \mathcal{O})$ are connected by the action of the group

$$\exp \left(\text{Conv}(\mathcal{C}_\circ, \mathcal{O}) \right).$$

Since

$$\alpha_H^{(1)} \Big|_{t=0} = \alpha_F \quad \text{and} \quad \alpha_H^{(1)} \Big|_{t=1} = \alpha_{\tilde{F}}$$

we conclude that the “only if” part is proved.

We leave the easier “if” part as an exercise. (See Exercise 5.7 below.) \square

EXERCISE 5.7. Prove the “if” part of Theorem 5.6.

We now deduce the following corollary.

COROLLARY 5.8. *Let \mathcal{C} be a coaugmented dg cooperad which satisfies the conditions of Theorem 5.6. If $U : \mathcal{O} \rightarrow \mathcal{O}'$ is a quasi-isomorphism of dg operads then for every operad morphism $F' : \text{Cobar}(\mathcal{C}) \rightarrow \mathcal{O}'$ there exists a morphism $F : \text{Cobar}(\mathcal{C}) \rightarrow \mathcal{O}$ such that the diagram*

$$(5.13) \quad \begin{array}{ccc} & & \text{Cobar}(\mathcal{C}) \\ & \nearrow F & \downarrow F' \\ \mathcal{O} & \xrightarrow{U} & \mathcal{O}' \end{array}$$

commutes up to homotopy. Moreover the morphism F is determined uniquely up to homotopy.

PROOF. The map U induces the homomorphism of dg Lie algebras

$$U_* : \text{Conv}(\mathcal{C}_\circ, \mathcal{O}) \rightarrow \text{Conv}(\mathcal{C}_\circ, \mathcal{O}').$$

Due to Theorem 4.7 U_* is a quasi-isomorphism of dg Lie algebras. Moreover, the restriction of U_*

$$U_* \Big|_{\mathcal{F}_m \text{Conv}(\mathcal{C}_\circ, \mathcal{O})} : \mathcal{F}_m \text{Conv}(\mathcal{C}_\circ, \mathcal{O}) \rightarrow \mathcal{F}_m \text{Conv}(\mathcal{C}_\circ, \mathcal{O}')$$

is also a quasi-isomorphism of dg Lie algebras for all m .

Hence, Theorem C.2 from Appendix C implies that U_* induces a bijection between the isomorphism classes of Maurer-Cartan elements in $\text{Conv}(\mathcal{C}_\circ, \mathcal{O})$ and in $\text{Conv}(\mathcal{C}_\circ, \mathcal{O}')$.

Thus, the statements of the corollary follow immediately from Theorem 5.6. \square

5.2. Models for homotopy algebras. Developing the machinery of algebraic operads is partially motivated by the desire to blend together concepts of abstract algebra and concepts of homotopy theory [28], [30], [31].

Thus, in homotopy theory, the notions of Lie algebra, commutative algebra, and Gerstenhaber algebra are replaced by their ∞ -versions (a.k.a homotopy versions): L_∞ -algebras, Com_∞ -algebras and Ger_∞ -algebras, respectively. These are examples of *homotopy algebras*.

In this paper we will go into a general philosophy for homotopy algebras and instead limit ourselves to conventional definitions.

DEFINITION 5.9. An Lie $_\infty$ -algebra (a.k.a. L_∞ -algebra) is an algebra (in $\text{Ch}_\mathbb{K}$) over the operad

$$(5.14) \quad \text{Lie}_\infty = \text{Cobar}(\Lambda \text{coCom}).$$

DEFINITION 5.10. A Com $_\infty$ -algebra is an algebra (in $\text{Ch}_\mathbb{K}$) over the operad

$$(5.15) \quad \text{Com}_\infty = \text{Cobar}(\Lambda \text{coLie}).$$

Finally,

DEFINITION 5.11. A Ger $_\infty$ -algebra is an algebra (in $\text{Ch}_\mathbb{K}$) over the operad

$$(5.16) \quad \text{Ger}_\infty = \text{Cobar}(\text{Ger}^\vee),$$

where

$$(5.17) \quad \text{Ger}^\vee = (\Lambda^{-2} \text{Ger})^*,$$

and $*$ is the operation of taking linear dual.

The above definitions are partially motivated by the observation that the operads Lie_∞ , Com_∞ and Ger_∞ are free resolutions of the operads Lie , Com and Ger , respectively.

Thus the canonical quasi-isomorphism of dg operads

$$(5.18) \quad U_{\text{Lie}} : \text{Lie}_\infty = \text{Cobar}(\Lambda\text{coCom}) \rightarrow \text{Lie}$$

corresponds to the Maurer-Cartan element⁹

$$\alpha_{\text{Lie}} = [a_1, a_2] \otimes b_1 b_2 \in \text{Conv}(\Lambda\text{coCom}_\circ, \text{Lie}) \cong \prod_{n \geq 2} \left(\text{Lie}(n) \otimes \Lambda^{-1}\text{Com}(n) \right)^{S_n},$$

where $[a_1, a_2]$ (resp. $b_1 b_2$) denotes the canonical generator of $\text{Lie}(2)$ (resp. $\Lambda^{-1}\text{Com}(2)$).

Similarly, the canonical quasi-isomorphism of dg operads

$$(5.19) \quad U_{\text{Com}} : \text{Com}_\infty = \text{Cobar}(\Lambda\text{coLie}) \rightarrow \text{Com}$$

corresponds to the Maurer-Cartan element

$$\alpha_{\text{Com}} = a_1 a_2 \otimes \{b_1, b_2\} \in \text{Conv}(\Lambda\text{coLie}_\circ, \text{Com}) \cong \prod_{n \geq 2} \left(\text{Com}(n) \otimes \Lambda^{-1}\text{Lie}(n) \right)^{S_n},$$

where $a_1 a_2$ (resp. $\{b_1, b_2\}$) denotes the canonical generator of $\text{Com}(2)$ (resp. $\Lambda^{-1}\text{Lie}(2)$).

Finally the canonical quasi-isomorphism of dg operads

$$(5.20) \quad U_{\text{Ger}} : \text{Ger}_\infty = \text{Cobar}(\text{Ger}^\vee) \rightarrow \text{Ger}$$

corresponds to the Maurer-Cartan element

$$\alpha_{\text{Ger}} = a_1 a_2 \otimes \{b_1, b_2\} + \{a_1, a_2\} \otimes b_1 b_2 \in \text{Conv}(\text{Ger}_\circ^\vee, \text{Ger}) = \prod_{n \geq 2} \left(\text{Ger}(n) \otimes \Lambda^{-2}\text{Ger}(n) \right)^{S_n},$$

where $a_1 a_2$, $\{a_1, a_2\}$ are the canonical generators of $\text{Ger}(2)$ and $b_1 b_2$, $\{b_1, b_2\}$ are the canonical generators of $\Lambda^{-2}\text{Ger}(2)$.

We should remark that here, instead of Lie algebras and L_∞ -algebras we often deal with ΛLie_∞ -algebras. It is not hard to see that ΛLie_∞ -algebras are algebras in $\text{Ch}_\mathbb{K}$ over the operad

$$(5.21) \quad \Lambda\text{Lie}_\infty = \text{Cobar}(\Lambda^2\text{coCom}).$$

Furthermore, the canonical quasi-isomorphism

$$(5.22) \quad U_{\Lambda\text{Lie}} : \Lambda\text{Lie}_\infty = \text{Cobar}(\Lambda^2\text{coCom}) \rightarrow \Lambda\text{Lie}$$

corresponds to the Maurer-Cartan element

$$\alpha_{\Lambda\text{Lie}} = \{a_1, a_2\} \otimes b_1 b_2 \in \text{Conv}(\Lambda^2\text{coCom}_\circ, \Lambda\text{Lie}) \cong \prod_{n \geq 2} \left(\Lambda\text{Lie}(n) \otimes \Lambda^{-2}\text{Com}(n) \right)^{S_n},$$

where $\{a_1, a_2\}$ (resp. $b_1 b_2$) denotes the canonical generator of $\Lambda\text{Lie}(2)$ (resp. $\Lambda^{-2}\text{Com}(2)$).

⁹Recall that, due to Proposition 5.2, operads maps from $\text{Cobar}(\mathcal{C})$ to \mathcal{O} are identified with Maurer-Cartan element of $\text{Conv}(\mathcal{C}_\circ, \mathcal{O})$.

5.2.1. ΛLie_∞ -algebras. Let V be a cochain complex.

Since $\Lambda\text{Lie}_\infty = \text{Cobar}(\Lambda^2\text{coCom})$, Corollary 5.3 implies that ΛLie_∞ -algebra structure on V is a choice of degree 1 coderivation

$$\mathcal{D} \in \text{coDer}(\Lambda^2\text{coCom}(V))$$

satisfying the Maurer-Cartan equation

$$(5.23) \quad \partial\mathcal{D} + \frac{1}{2}[\mathcal{D}, \mathcal{D}] = 0$$

together with the condition

$$\mathcal{D}|_V = 0.$$

On the other hand, according to [16, Proposition 2.14], any coderivation of $\Lambda^2\text{coCom}(V)$ is uniquely determined by its composition $p_V \circ \mathcal{D}$ with the projection

$$p_V : \Lambda^2\text{coCom}(V) \rightarrow V.$$

Thus, since

$$\Lambda^2\text{coCom}(V) = \mathbf{s}^2 S(\mathbf{s}^{-2}V),$$

an ΛLie_∞ -structure on V is determined by the infinite sequence of multi-ary operations

$$(5.24) \quad \{, , \dots, \}_n = p_V \circ \mathcal{D} \mathbf{s}^{2n-2} : S^n(V) \rightarrow V, \quad n \geq 2$$

where the n -th operation $\{, , \dots, \}_n$ carries degree $3 - 2n$.

The Maurer-Cartan equation (5.23) is equivalent to the sequence of the following quadratic relations on operations (5.24):

$$(5.25) \quad \partial\{v_1, v_2, \dots, v_n\}_n + \sum_{i=1}^n (-1)^{|v_1| + \dots + |v_{i-1}|} \{v_1, \dots, v_{i-1}, \partial v_i, v_{i+1}, \dots, v_n\}_n +$$

$$\sum_{p=2}^{n-1} \sum_{\sigma \in \text{Sh}_{p, n-p}} (-1)^{\varepsilon(\sigma, v_1, \dots, v_n)} \{v_{\sigma(1)}, \dots, v_{\sigma(p)}\}_p, v_{\sigma(p+1)}, \dots, v_{\sigma(n)}\}_{n-p+1} = 0,$$

where ∂ is the differential on V and $(-1)^{\varepsilon(\sigma, v_1, \dots, v_n)}$ is the sign factor determined by the usual Koszul rule.

REMARK 5.12. Even though there is an obvious bijection between ΛLie_∞ -structures on V and L_∞ -structures on $\mathbf{s}^{-1}V$, it is often easier to deal with signs in formulas for ΛLie_∞ -structures.

6. Twisting of operads

Let \mathcal{O} be a dg operad equipped with a map

$$(6.1) \quad \widehat{\varphi} : \Lambda\text{Lie}_\infty \rightarrow \mathcal{O}.$$

Let V be an algebra over \mathcal{O} . Using the map $\widehat{\varphi}$, we equip V with an ΛLie_∞ -structure.

If we assume, in addition, that V is equipped with a complete descending filtration

$$(6.2) \quad V \supset F_1V \supset F_2V \supset F_3V \supset \dots, \quad V = \lim_k V / F_kV$$

and the \mathcal{O} -algebra structure on V is compatible with this filtration then we may define Maurer-Cartan elements of V as degree 2 elements $\alpha \in F_1 V$ satisfying the equation

$$(6.3) \quad \partial(\alpha) + \sum_{n \geq 2} \frac{1}{n!} \{\alpha, \alpha, \dots, \alpha\}_n = 0,$$

where ∂ is the differential on V and $\{\cdot, \cdot, \dots, \cdot\}_n$ is the n -th operation of the $\Lambda \text{Lie}_\infty$ -structure on V .

Given such a Maurer-Cartan element α we can twist the differential on V and insert α into various \mathcal{O} -operations on V . This way we get a new algebra structure on V .

It turns out that this new algebra structure is governed by an operad $\text{Tw}\mathcal{O}$ which is built from the pair $(\mathcal{O}, \widehat{\varphi})$.

This section is devoted to the construction of $\text{Tw}\mathcal{O}$.

6.1. Intrinsic derivations of an operad. Let \mathcal{O} be an dg operad. We recall that a \mathbb{K} -linear map

$$\delta : \bigoplus_{n \geq 0} \mathcal{O}(n) \rightarrow \bigoplus_{n \geq 0} \mathcal{O}(n)$$

is an *operadic derivation* if for every $a \in \mathcal{O}(n)$, $\delta(a) \in \mathcal{O}(n)$ and for all homogeneous vectors $a_1 \in \mathcal{O}(n)$, $a_2 \in \mathcal{O}(k)$

$$\delta(a_1 \circ_i a_2) = \delta(a_1) \circ_i a_2 + (-1)^{|\delta||a_1|} a_1 \circ_i \delta(a_2), \quad \forall 1 \leq i \leq n.$$

Let us now observe that the operation \circ_1 equips $\mathcal{O}(1)$ with a structure of a dg associative algebra. We consider $\mathcal{O}(1)$ as a dg Lie algebra with the Lie bracket being the commutator.

We claim that

PROPOSITION 6.1. *The formula*

$$(6.4) \quad \delta_b(a) = b \circ_1 a - (-1)^{|a||b|} \sum_{i=1}^n a \circ_i b$$

with

$$b \in \mathcal{O}(1), \quad \text{and} \quad a \in \mathcal{O}(n)$$

defines an operadic derivation of \mathcal{O} for every $b \in \mathcal{O}(1)$.

Operadic derivations of the form (6.4) are called *intrinsic*.

PROOF. Let $a_1 \in \mathcal{O}(n_1)$ and $a_2 \in \mathcal{O}(n_2)$. Then for every $b \in \mathcal{O}(1)$ and $1 \leq j \leq n_1$ we have

$$\begin{aligned} \delta_b(a_1 \circ_j a_2) &= b \circ_1 (a_1 \circ_j a_2) - (-1)^{(|a_1|+|a_2|)|b|} \sum_{i=1}^{n_1+n_2-1} (a_1 \circ_j a_2) \circ_i b = \\ &= (b \circ_1 a_1) \circ_j a_2 - (-1)^{|a_1||b|} \sum_{\substack{1 \leq i \leq n_1 \\ i \neq j}} (a_1 \circ_i b) \circ_j a_2 - (-1)^{(|a_1|+|a_2|)|b|} \sum_{i=1}^{n_2} a_1 \circ_j (a_2 \circ_i b) \\ &= (b \circ_1 a_1) \circ_j a_2 - (-1)^{|a_1||b|} \sum_{i=1}^{n_1} (a_1 \circ_i b) \circ_j a_2 \end{aligned}$$

$$\begin{aligned}
& +(-1)^{|a_1||b|}(a_1 \circ_j b) \circ_j a_2 - (-1)^{(|a_1|+|a_2|)|b|} \sum_{i=1}^{n_2} a_1 \circ_j (a_2 \circ_i b) \\
& = (b \circ_1 a_1) \circ_j a_2 - (-1)^{|a_1||b|} \sum_{i=1}^{n_1} (a_1 \circ_i b) \circ_j a_2 \\
& +(-1)^{|a_1||b|} a_1 \circ_j (b \circ_1 a_2) - (-1)^{(|a_1|+|a_2|)|b|} \sum_{i=1}^{n_2} a_1 \circ_j (a_2 \circ_i b) \\
& = \delta_b(a_1) \circ_j a_2 + (-1)^{|a_1||b|} a_1 \circ_j \delta_b(a_2).
\end{aligned}$$

Hence δ_b is indeed an operadic derivation of \mathcal{O} .

It remains to verify the identity

$$(6.5) \quad [\delta_{b_1}, \delta_{b_2}] = \delta_{[b_1, b_2]}$$

and we leave this step as an exercise. \square

EXERCISE 6.2. Verify identity (6.5).

6.2. Construction of the operad $\widetilde{\text{Tw}}\mathcal{O}$. Let us recall that, since $\Lambda\text{Lie}_\infty = \text{Cobar}(\Lambda^2\text{coCom})$, the morphism (6.1) is determined by a Maurer-Cartan element

$$(6.6) \quad \varphi \in \text{Conv}(\Lambda^2\text{coCom}_\circ, \mathcal{O}).$$

The n -th space of $\Lambda^2\text{coCom}_\circ$ is the trivial S_n -module placed in degree $2 - 2n$:

$$\Lambda^2\text{coCom}(n) = \mathfrak{s}^{2-2n}\mathbb{K}.$$

So we have

$$\text{Conv}(\Lambda^2\text{coCom}_\circ, \mathcal{O}) = \prod_{n \geq 2} \text{Hom}_{S_n}(\mathfrak{s}^{2-2n}\mathbb{K}, \mathcal{O}(n)) = \prod_{n \geq 2} \mathfrak{s}^{2n-2}(\mathcal{O}(n))^{S_n}.$$

For our purposes we will need to extend the dg Lie algebra $\text{Conv}(\Lambda^2\text{coCom}_\circ, \mathcal{O})$ to

$$(6.7) \quad \mathcal{L}_{\mathcal{O}} = \text{Conv}(\Lambda^2\text{coCom}, \mathcal{O}) = \prod_{n \geq 1} \text{Hom}_{S_n}(\mathfrak{s}^{2-2n}\mathbb{K}, \mathcal{O}(n)).$$

It is clear that

$$\mathcal{L}_{\mathcal{O}} = \prod_{n \geq 1} \mathfrak{s}^{2n-2}(\mathcal{O}(n))^{S_n}.$$

For $n, r \geq 1$ we realize the group S_r as the following subgroup of S_{r+n}

$$(6.8) \quad S_r \cong \{\sigma \in S_{r+n} \mid \sigma(i) = i, \quad \forall i > r\}.$$

In other words, for every $n \geq 1$, the group S_r may be viewed as subgroup of S_{r+n} permuting the first r letters. We set S_0 to be the trivial group.

Using this embedding of S_r into S_{n+r} we introduce the following collection ($n \geq 0$)

$$(6.9) \quad \widetilde{\text{Tw}}\mathcal{O}(n) = \prod_{r \geq 0} \text{Hom}_{S_r}(\mathfrak{s}^{-2r}\mathbb{K}, \mathcal{O}(r+n)).$$

It is clear that

$$\widetilde{\text{Tw}}\mathcal{O}(n) = \prod_{r \geq 0} \mathfrak{s}^{2r}(\mathcal{O}(r+n))^{S_r}.$$

To define an operad structure on (6.9) we denote by 1_r the generator $\mathbf{s}^{-2r} 1 \in \mathbf{s}^{-2r} \mathbb{K}$. Then the identity element \mathbf{u} in $\widetilde{\text{Tw}}\mathcal{O}(1)$ is given by

$$(6.10) \quad \mathbf{u}(1_r) = \begin{cases} \mathbf{u}_{\mathcal{O}} & \text{if } r = 0, \\ 0 & \text{otherwise,} \end{cases}$$

where $\mathbf{u}_{\mathcal{O}} \in \mathcal{O}(1)$ is the identity element for the operad \mathcal{O} .

Next, for $f \in \widetilde{\text{Tw}}\mathcal{O}(n)$ and $g \in \widetilde{\text{Tw}}\mathcal{O}(m)$, we define the i -th elementary insertion \circ_i $1 \leq i \leq n$ by the formula

$$(6.11) \quad f \circ_i g(1_r) = \sum_{p=0}^r \sum_{\sigma \in \text{Sh}_{p,r-p}} \mu_{\mathbf{t}_{\sigma,i}}(f(1_p) \otimes g(1_{r-p})).$$

where the tree $\mathbf{t}_{\sigma,i}$ is depicted on figure 21.

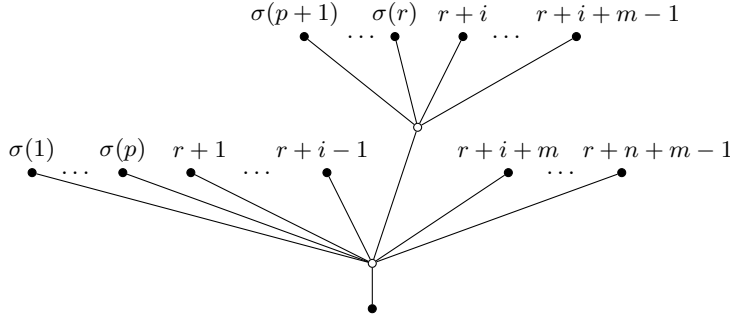

FIG. 21. Here σ is a $(p, r-p)$ -shuffle

To see that the element $f \circ_i g(1_r) \in \mathcal{O}(r+n+m-1)$ is S_r -invariant one simply needs to use the fact that every element $\tau \in S_r$ can be uniquely presented as the composition $\tau_{sh} \circ \tau_{p,r-p}$, where τ_{sh} is a $(p, r-p)$ -shuffle and $\tau_{p,r-p} \in S_p \times S_{r-p}$.

Let $f \in \widetilde{\text{Tw}}\mathcal{O}(n)$, $g \in \widetilde{\text{Tw}}\mathcal{O}(m)$, $h \in \widetilde{\text{Tw}}\mathcal{O}(k)$, $1 \leq i \leq n$, and $1 \leq j \leq m$. To check the identity

$$(6.12) \quad f \circ_i (g \circ_j h) = (f \circ_i g) \circ_{j+i-1} h$$

we observe that

$$\begin{aligned} f \circ_i (g \circ_j h)(1_r) &= \sum_{p=0}^r \sum_{\sigma \in \text{Sh}_{p,r-p}} \mu_{\mathbf{t}_{\sigma,i}}(f(1_p) \otimes (g \circ_j h)(1_{r-p})) \\ &= \sum_{p_1+p_2+p_3=r} \sum_{\sigma \in \text{Sh}_{p_1,p_2+p_3}} \sum_{\sigma' \in \text{Sh}_{p_2,p_3}} \mu_{\mathbf{t}_{\sigma,i}} \circ (1 \otimes \mu_{\mathbf{t}_{\sigma',j}})(f(1_{p_1}) \otimes g(1_{p_2}) \otimes h(1_{p_3})) \\ &= \sum_{p_1+p_2+p_3=r} \sum_{\tau \in \text{Sh}_{p_1,p_2,p_3}} \mu_{\mathbf{t}_{\tau,i,j}}(f(1_{p_1}) \otimes g(1_{p_2}) \otimes h(1_{p_3})), \end{aligned}$$

where the tree $\mathbf{t}_{\tau,i,j}$ is depicted on figure 22. Similar calculations show that

$$(f \circ_i g) \circ_{j+i-1} h = \sum_{p_1+p_2+p_3=r} \sum_{\tau \in \text{Sh}_{p_1,p_2,p_3}} \mu_{\mathbf{t}_{\tau,i,j}}(f(1_{p_1}) \otimes g(1_{p_2}) \otimes h(1_{p_3})),$$

with $\mathbf{t}_{\tau,i,j}$ being the tree depicted on figure 22.

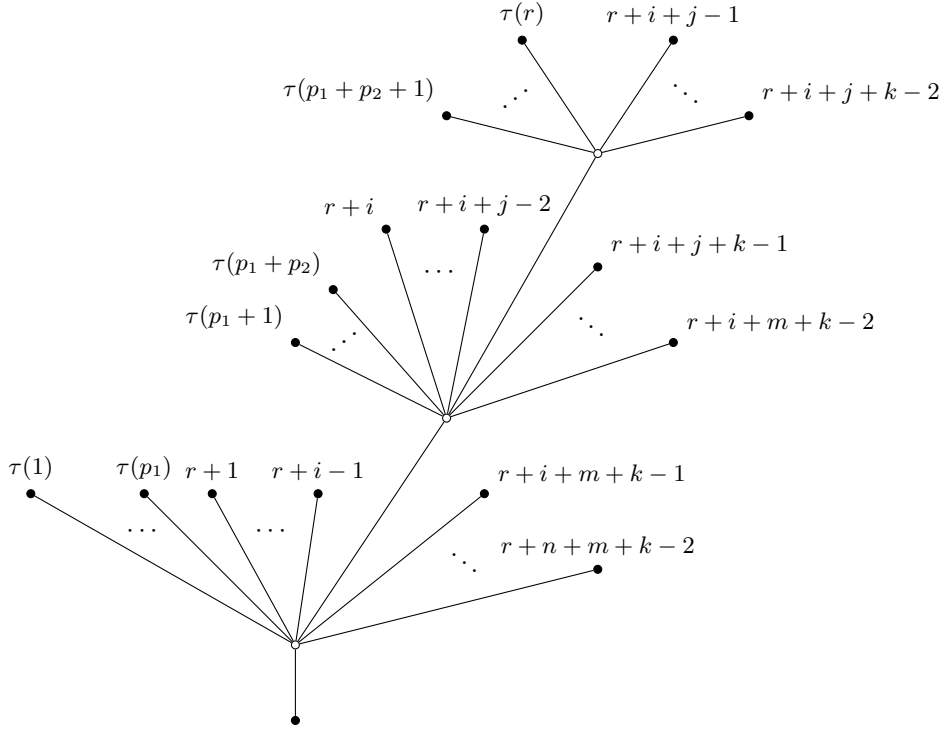

FIG. 22. Here τ is a (p_1, p_2, p_3) -shuffle and $r = p_1 + p_2 + p_3$

We leave the verification of the remaining axioms of the operad structure for the reader.

Our next goal is to define an auxiliary action of $\mathcal{L}_{\mathcal{O}}$ on the operad $\widetilde{\text{Tw}}\mathcal{O}$. For a vector $f \in \widetilde{\text{Tw}}\mathcal{O}(n)$ the action of $v \in \mathcal{L}_{\mathcal{O}}$ (6.7) on f is defined by the formula

$$(6.13) \quad v \cdot f(1_r) = -(-1)^{|v||f|} \sum_{p=1}^r \sum_{\sigma \in \text{Sh}_{p, r-p}} \mu_{\mathbf{t}'_{\sigma, p, r-p}}(f(1_{r-p+1}) \otimes v(1_p^{\epsilon})),$$

where 1_p^{ϵ} is the generator $\mathfrak{s}^{2-2p} 1 \in \Lambda^2 \text{coCom}(p) \cong \mathfrak{s}^{2-2p} \mathbb{K}$ and the tree $\mathbf{t}'_{\sigma, p, r-p}$ is depicted on figure 23.

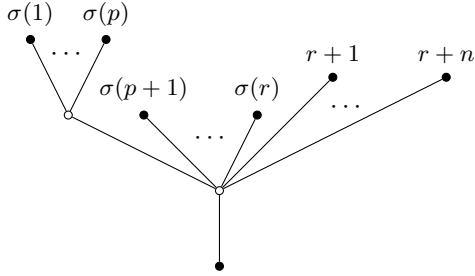

FIG. 23. Here σ is a $(p, r-p)$ -shuffle

We claim that

PROPOSITION 6.3. *Formula (6.13) defines an action of $\mathcal{L}_{\mathcal{O}}$ (6.7) on the operad $\widetilde{\text{Tw}}\mathcal{O}$.*

PROOF. A simple degree bookkeeping shows that the degree of $v \cdot f$ is $|v| + |f|$. Then we need to check that for two homogeneous vectors $v, w \in \mathcal{L}_{\mathcal{O}}$ we have

$$(6.14) \quad [v, w] \cdot f(1_r) = (v \cdot (w \cdot f))(1_r) - (-1)^{|v||w|} (w \cdot (v \cdot f))(1_r)$$

Using the definition of the operation \cdot and the associativity axiom for the operad structure on \mathcal{O} we get

$$(6.15) \quad \begin{aligned} & (v \cdot (w \cdot f))(1_r) - (-1)^{|v||w|} (w \cdot (v \cdot f))(1_r) = \\ & (-1)^{|f|(|v|+|w|)+|v||w|} \sum_{p \geq 1} \sum_{q \geq 0} \sum_{\tau \in \text{Sh}_{p,q,r-p-q}} \mu_{\mathbf{t}_\tau^{p,q}} (f(1_{r-p-q+1}) \otimes w(1_{q+1}^c) \otimes v(1_p^c)) \\ & + (-1)^{|f|(|v|+|w|)+|v||w|} \sum_{p,q \geq 1} \sum_{\tau \in \text{Sh}_{p,q,r-p-q}} \mu_{\tilde{\mathbf{t}}_\tau^{p,q}} (f(1_{r-p-q+2}) \otimes w(1_q^c) \otimes v(1_p^c)) \\ & - (-1)^{|v||w|} (v \leftrightarrow w), \end{aligned}$$

where the trees $\mathbf{t}_\tau^{p,q}$ and $\tilde{\mathbf{t}}_\tau^{p,q}$ are depicted on figures 24 and 25, respectively.

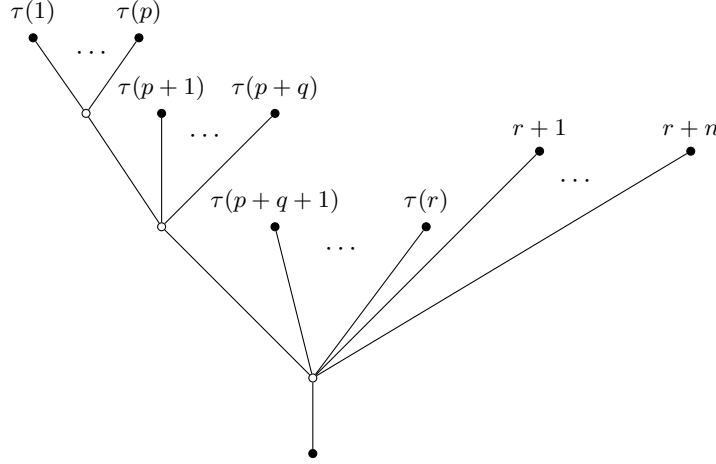

FIG. 24. The tree $\mathbf{t}_\tau^{p,q}$

Since $f(1_{r-p-q+2})$ is invariant with respect to the action of $S_{r-p-q+2}$ the sums involving $\mu_{\tilde{\mathbf{t}}_\tau^{p,q}}$ cancel each other.

Furthermore, it is not hard to see that the sums involving $\mu_{\mathbf{t}_\tau^{p,q}}$ form the expression

$$[v, w] \cdot f(1_r).$$

Thus equation (6.14) follows.

Due to Exercise 6.4 below, the operation $f \mapsto v \cdot f$ is an operadic derivation. Proposition 6.3 is proved. \square

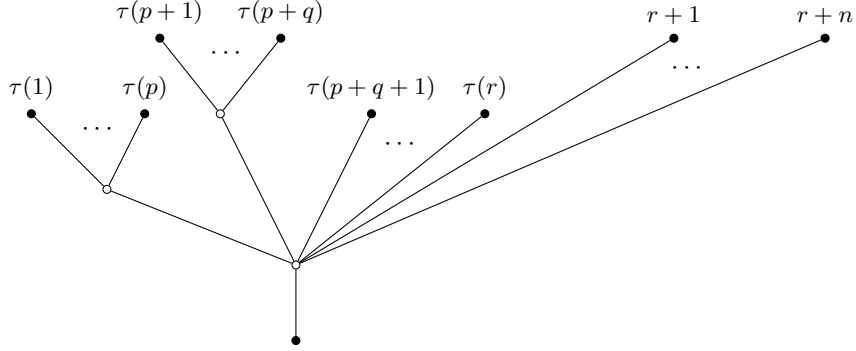
 FIG. 25. The tree $\tilde{\mathbf{t}}_r^{p,q}$

EXERCISE 6.4. Prove that for every triple of homogeneous vectors $f \in \widetilde{\text{Tw}}\mathcal{O}(n)$, $g \in \widetilde{\text{Tw}}\mathcal{O}(k)$, and $v \in \mathcal{L}_{\mathcal{O}}$ we have

$$v \cdot (f \circ_i g) = (v \cdot f) \circ_i g + (-1)^{|v||f|} f \circ_i (v \cdot g) \quad \forall 1 \leq i \leq n.$$

6.3. The action of $\mathcal{L}_{\mathcal{O}}$ on $\widetilde{\text{Tw}}\mathcal{O}$. Let us view $\widetilde{\text{Tw}}\mathcal{O}(1)$ as the dg Lie algebra with the bracket being commutator.

We have an obvious degree zero map

$$\kappa : \mathcal{L}_{\mathcal{O}} \rightarrow \widetilde{\text{Tw}}\mathcal{O}(1)$$

defined by the formula

$$(6.16) \quad \kappa(v)(1_r) = v(1_{r+1}^c),$$

where, as above, 1_r is the generator $\mathbf{s}^{-2r} 1 \in \mathbf{s}^{-2r} \mathbb{K}$ and 1_r^c is the generator $\mathbf{s}^{2-2r} 1 \in \Lambda^2 \text{coCom}(r) \cong \mathbf{s}^{2-2r} \mathbb{K}$.

We have the following proposition.

PROPOSITION 6.5. *Let us form the semi-direct product $\mathcal{L}_{\mathcal{O}} \ltimes \widetilde{\text{Tw}}\mathcal{O}(1)$ of the dg Lie algebras $\mathcal{L}_{\mathcal{O}}$ and $\widetilde{\text{Tw}}\mathcal{O}(1)$ using the action of $\mathcal{L}_{\mathcal{O}}$ on $\widetilde{\text{Tw}}\mathcal{O}$ defined in Proposition 6.3. Then the formula*

$$(6.17) \quad \Theta(v) = v + \kappa(v)$$

defines a Lie algebra homomorphism

$$\Theta : \mathcal{L}_{\mathcal{O}} \rightarrow \mathcal{L}_{\mathcal{O}} \ltimes \widetilde{\text{Tw}}\mathcal{O}(1).$$

PROOF. First, let us prove that for every pair of homogeneous vectors $v, w \in \mathcal{L}_{\mathcal{O}}$ we have

$$(6.18) \quad \kappa([v, w]) = [\kappa(v), \kappa(w)] + v \cdot \kappa(w) - (-1)^{|v||w|} w \cdot \kappa(v).$$

Indeed, unfolding the definition of κ we get¹⁰

$$(6.19) \quad \kappa([v, w])(1_r) = \sum_{p=1}^r \sum_{\tau \in \text{Sh}_{p, r-p}} v_{r-p+2}(w_p(\tau(1), \dots, \tau(p)), \tau(p+1), \dots, \tau(r), r+1)$$

¹⁰Here we use the notation (3.9) introduced in Subsection 3.2.

$$\begin{aligned}
& + \sum_{p=0}^r \sum_{\tau \in \text{Sh}_{p, r-p}} v_{r-p+1}(w_{p+1}(\tau(1), \dots, \tau(p), r+1), \tau(p+1), \dots, \tau(r)) \\
& \quad - (-1)^{|v||w|}(v \leftrightarrow w),
\end{aligned}$$

where $v_t = v(1_t^\natural)$ and $w_t = w(1_t^\natural)$.

The first sum in (6.19) equals

$$-(-)^{|v||w|}(w \cdot \kappa(v))(1_r).$$

Furthermore, since $v(1_t^\natural)$ is invariant under the action of S_t , we see that the second sum in (6.19) equals

$$(\kappa(v) \circ_1 \kappa(w))(1_r).$$

Thus equation (6.18) holds.

Now, using (6.18), it is easy to see that

$$\begin{aligned}
[v + \kappa(v), w + \kappa(w)] &= [v, w] + v \cdot \kappa(w) - (-1)^{|v||w|} w \cdot \kappa(v) + [\kappa(v), \kappa(w)] = \\
&= [v, w] + \kappa([v, w])
\end{aligned}$$

and the statement of proposition follows. \square

The following corollaries are immediate consequences of Proposition 6.5

COROLLARY 6.6. *For $v \in \mathcal{L}_{\mathcal{O}}$ and $f \in \widetilde{\text{Tw}}\mathcal{O}(n)$ the formula*

$$(6.20) \quad f \rightarrow v \cdot f + \delta_{\kappa(v)}(f)$$

defines an action of the Lie algebra $\mathcal{L}_{\mathcal{O}}$ on the operad $\widetilde{\text{Tw}}\mathcal{O}$.

COROLLARY 6.7. *For every Maurer-Cartan element $\varphi \in \mathcal{L}_{\mathcal{O}}$, the sum*

$$\varphi + \kappa(\varphi)$$

is a Maurer-Cartan element of the Lie algebra $\mathcal{L}_{\mathcal{O}} \times \widetilde{\text{Tw}}\mathcal{O}(1)$.

We finally give the definition of the operad $\text{Tw}\mathcal{O}$.

DEFINITION 6.8. Let \mathcal{O} be an operad in $\text{Ch}_{\mathbb{K}}$ and φ be a Maurer-Cartan element in $\mathcal{L}_{\mathcal{O}}$ (6.7) corresponding to an operad morphism $\widehat{\varphi}$ (6.1). Let us also denote by $\partial^{\mathcal{O}}$ the differential on $\widetilde{\text{Tw}}\mathcal{O}$ coming from the one on \mathcal{O} . We define the operad $\text{Tw}\mathcal{O}$ in $\text{Ch}_{\mathbb{K}}$ by declaring that $\text{Tw}\mathcal{O} = \widetilde{\text{Tw}}\mathcal{O}$ as operads in $\text{grVect}_{\mathbb{K}}$ and letting

$$(6.21) \quad \partial^{\text{Tw}} = \partial^{\mathcal{O}} + \varphi \cdot + \delta_{\kappa(\varphi)}$$

be the differential on $\text{Tw}\mathcal{O}$.

Corollaries 6.6 and 6.7 imply that ∂^{Tw} is indeed a differential on $\text{Tw}\mathcal{O}$.

REMARK 6.9. It is easy to see that, if $\mathcal{O}(0) = \mathbf{0}$ then the cochain complexes $s^{-2}\text{Tw}\mathcal{O}(0)$ and $\mathcal{L}_{\mathcal{O}}$ (6.7) are tautologically isomorphic.

6.4. Algebras over $\text{Tw}\mathcal{O}$. Let us assume that V is an algebra over \mathcal{O} equipped with a complete descending filtration (6.2). We also assume that the \mathcal{O} -algebra structure on V is compatible with this filtration.

Given a Maurer-Cartan element $\alpha \in F_1 V$ the formula

$$(6.22) \quad \partial^\alpha(v) = \partial(v) + \sum_{r=1}^{\infty} \frac{1}{r!} \varphi(1_{r+1}^c)(\underbrace{\alpha, \dots, \alpha}_{r \text{ times}}, v)$$

defines a new (twisted) differential on V .

We will denote by V^α the cochain complex V with this new differential.

In this setting we have the following theorem

THEOREM 6.10. *If V^α is the cochain complex obtained from V via twisting the differential by α then the formula*

$$(6.23) \quad f(v_1, \dots, v_n) = \sum_{r=0}^{\infty} \frac{1}{r!} f(1_r)(\alpha, \dots, \alpha, v_1, \dots, v_n)$$

$$f \in \text{Tw}\mathcal{O}(n), \quad v_i \in V, \quad 1_r = \mathbf{s}^{-2r} 1 \in \mathbf{s}^{-2r} \mathbb{K}$$

defines a $\text{Tw}\mathcal{O}$ -algebra structure on V^α .

PROOF. Let $f \in \text{Tw}\mathcal{O}(n)$, $g \in \text{Tw}\mathcal{O}(k)$,

$$f_r := f(1_r) \in (\mathcal{O}(r+n))^{S_r}, \quad \text{and} \quad g_r = g(1_r) \in (\mathcal{O}(r+k))^{S_r}.$$

Our first goal is to verify that

$$(6.24) \quad (-1)^{|g|(|v_i|+\dots+|v_{i-1}|)} f(v_1, \dots, v_{i-1}, g(v_i, \dots, v_{i+k-1}), v_{i+k}, \dots, v_{n+k-1})$$

$$= f \circ_i g(v_1, \dots, v_{n+k-1}).$$

The left hand side of (6.24) can be rewritten as

$$(-1)^{|g|(|v_i|+\dots+|v_{i-1}|)} f(v_1, \dots, v_{i-1}, g(v_i, \dots, v_{i+k-1}), v_{i+k}, \dots, v_{n+k-1}) =$$

$$\sum_{p,q \geq 0} \frac{(-1)^{|g|(|v_i|+\dots+|v_{i-1}|)}}{p!q!} f_p(\alpha, \dots, \alpha, v_1, \dots, v_{i-1}, g_q(\alpha, \dots, \alpha, v_i, \dots, v_{i+k-1}), v_{i+k}, \dots, v_{n+k-1}).$$

Using the obvious combinatorial identity

$$(6.25) \quad |\text{Sh}_{p,q}| = \frac{(p+q)!}{p!q!}$$

we rewrite the left hand side of (6.24) further

$$\text{L.H.S. of (6.24)} =$$

$$\sum_{p,q \geq 0} \frac{(-1)^{|g|(|v_i|+\dots+|v_{i-1}|)}}{(p+q)!} |\text{Sh}_{p,q}| f_p(\alpha, \dots, \alpha, v_1, \dots, v_{i-1}, g_q(\alpha, \dots, \alpha, v_i, \dots, v_{i+k-1}), v_{i+k}, \dots, v_{n+k-1}) =$$

$$\sum_{r=0}^{\infty} \frac{1}{r!} \sum_{p=0}^r \sum_{\sigma \in \text{Sh}_{p,r-p}} \sigma \circ \varrho_{r,p,i} (f_p \circ_{p+i} g_{r-p})(\underbrace{\alpha, \dots, \alpha}_{r \text{ arguments}}, v_1, \dots, v_{n+k-1}),$$

where $\varrho_{r,p,i}$ is the following permutation in S_r

$$(6.26) \quad \varrho_{r,p,i} = \begin{pmatrix} p+1 & \dots & p+i-1 & p+i & \dots & r+i-1 \\ r+1 & \dots & r+i-1 & p+1 & \dots & r \end{pmatrix}.$$

Thus

$$\text{L.H.S. of (6.24)} = f \circ_i g(v_1, \dots, v_{n+k-1})$$

and equation (6.24) holds.

Next, we need to show that

$$(6.27) \quad \partial^{\text{Tw}}(f)(v_1, \dots, v_n) = \partial^\alpha f(v_1, \dots, v_n) \\ - (-1)^{|f|} \sum_{i=1}^n (-1)^{|v_i| + \dots + |v_{i-1}|} f(v_1, \dots, v_{i-1}, \partial^\alpha(v_i), v_{i+1}, \dots, v_n)$$

The right hand side of (6.27) can be rewritten as

$$\begin{aligned} & \text{R.H.S. of (6.27) =} \\ & \sum_{p \geq 0} \frac{1}{p!} \partial f_p(\alpha, \dots, \alpha, v_1, \dots, v_n) + \sum_{p \geq 0, q \geq 1} \frac{1}{p!q!} \varphi_q(\alpha, \dots, \alpha, f_p(\alpha, \dots, \alpha, v_1, \dots, v_n)) \\ & - (-1)^{|f|} \sum_{i=1}^n \sum_{p \geq 0} \frac{(-1)^{|v_i| + \dots + |v_{i-1}|}}{p!} f_p(\alpha, \dots, \alpha, v_1, \dots, v_{i-1}, \partial(v_i), v_{i+1}, \dots, v_n) \\ & - (-1)^{|f|} \sum_{i=1}^n \sum_{p \geq 0, q \geq 1} \frac{(-1)^{|v_i| + \dots + |v_{i-1}|}}{p!q!} f_p(\alpha, \dots, \alpha, v_1, \dots, v_{i-1}, \varphi_q(\alpha, \dots, \alpha, v_i), v_{i+1}, \dots, v_n) \end{aligned}$$

where $f_p = f(1_p)$ and $\varphi_q = \varphi(1_q^c)$.

Let us now add to and subtract from the right hand side of (6.27) the sum

$$- (-1)^{|f|} \sum_{p \geq 0} \frac{1}{p!} f_{p+1}(\partial\alpha, \alpha, \dots, \alpha, v_1, \dots, v_n).$$

We get

$$\begin{aligned} & \text{R.H.S. of (6.27) =} \\ & \sum_{p \geq 0} \frac{1}{p!} \partial f_p(\alpha, \dots, \alpha, v_1, \dots, v_n) - (-1)^{|f|} \sum_{p \geq 0} \frac{1}{p!} f_{p+1}(\partial\alpha, \alpha, \dots, \alpha, v_1, \dots, v_n) \\ & - (-1)^{|f|} \sum_{i=1}^n \sum_{p \geq 0} \frac{(-1)^{|v_i| + \dots + |v_{i-1}|}}{p!} f_p(\alpha, \dots, \alpha, v_1, \dots, v_{i-1}, \partial(v_i), v_{i+1}, \dots, v_n) \\ & \quad + (-1)^{|f|} \sum_{p \geq 0} \frac{1}{p!} f_{p+1}(\partial\alpha, \alpha, \dots, \alpha, v_1, \dots, v_n) \\ & \quad + \sum_{p \geq 0, q \geq 1} \frac{1}{p!q!} \varphi_q(\alpha, \dots, \alpha, f_p(\alpha, \dots, \alpha, v_1, \dots, v_n)) \\ & - (-1)^{|f|} \sum_{i=1}^n \sum_{p \geq 0, q \geq 1} \frac{(-1)^{|v_i| + \dots + |v_{i-1}|}}{p!q!} f_p(\alpha, \dots, \alpha, v_1, \dots, v_{i-1}, \varphi_q(\alpha, \dots, \alpha, v_i), v_{i+1}, \dots, v_n) = \\ & \quad (\partial^\circ f)(v_1, \dots, v_n) \\ & \quad + (-1)^{|f|} \sum_{p \geq 0} \frac{1}{p!} f_{p+1}(\partial\alpha, \alpha, \dots, \alpha, v_1, \dots, v_n) \\ & \quad + \sum_{p \geq 0, q \geq 1} \frac{1}{p!q!} \varphi_q(\alpha, \dots, \alpha, f_p(\alpha, \dots, \alpha, v_1, \dots, v_n)) \\ & - (-1)^{|f|} \sum_{i=1}^n \sum_{p \geq 0, q \geq 1} \frac{(-1)^{|v_i| + \dots + |v_{i-1}|}}{p!q!} f_p(\alpha, \dots, \alpha, v_1, \dots, v_{i-1}, \varphi_q(\alpha, \dots, \alpha, v_i), v_{i+1}, \dots, v_n). \end{aligned}$$

Due to the Maurer-Cartan equation for α

$$\partial(\alpha) + \frac{1}{q!} \varphi_q(\alpha, \alpha, \dots, \alpha) = 0$$

we have

$$\begin{aligned} &+(-1)^{|f|} \sum_{p \geq 0} \frac{1}{p!} f_{p+1}(\partial\alpha, \alpha, \dots, \alpha, v_1, \dots, v_n) = \\ &-(-1)^{|f|} \sum_{p \geq 0, q \geq 2} \frac{1}{p!q!} f_{p+1}(\varphi_q(\alpha, \dots, \alpha), \alpha, \dots, \alpha, v_1, \dots, v_n). \end{aligned}$$

Hence, using (6.25) we get

$$\begin{aligned} &\text{R.H.S. of (6.27) =} \\ &(\partial^{\mathcal{O}} f)(v_1, \dots, v_n) + (\varphi \cdot f)(v_1, \dots, v_n) \\ &+\kappa(\varphi) \circ_1 f(v_1, \dots, v_n) - (-1)^{|f|} f \circ_1 \kappa(\varphi)(v_1, \dots, v_n). \end{aligned}$$

Theorem 6.10 is proved. \square

Let us now observe that the dg operad $\text{Tw}\mathcal{O}$ is equipped with complete descending filtration. Namely,

$$(6.28) \quad \mathcal{F}_k \text{Tw}\mathcal{O}(n) = \{f \in \text{Tw}\mathcal{O}(n) \mid f(1_r) = 0 \quad \forall r < k\}$$

It is clear that the operad structure on $\text{Tw}\mathcal{O}$ is compatible with this filtration.

The endomorphism operad End_V also carries a complete descending filtration since so does V .

For this reason it makes sense to give this definition:

DEFINITION 6.11. A filtered $\text{Tw}\mathcal{O}$ -algebra is a cochain complex V equipped with a complete descending filtration for which the operad map

$$\text{Tw}\mathcal{O} \rightarrow \text{End}_V$$

is compatible with the filtrations.

It is easy to see that the $\text{Tw}\mathcal{O}$ -algebra V^α from Theorem 6.10 is a filtered $\text{Tw}\mathcal{O}$ -algebra in the sense of this definition.

Thus Theorem 6.10 gives us a functor to the category of filtered $\text{Tw}\mathcal{O}$ -algebras from the category of pairs

$$(V, \alpha),$$

where V is a filtered cochain complex equipped with an action of the operad \mathcal{O} and α is a Maurer-Cartan element in $\mathcal{F}_1 V$.

According to [7] this functor establishes an equivalence of categories.

6.5. A useful modification $\text{Tw}^\oplus\mathcal{O}$. In practice the morphism (6.1) often comes from the map (of dg operads)

$$j : \Lambda\text{Lie} \rightarrow \mathcal{O}.$$

In this case, the above construction of twisting is well defined for the suboperad $\text{Tw}^\oplus(\mathcal{O}) \subset \text{Tw}\mathcal{O}$ with

$$(6.29) \quad \text{Tw}^\oplus(\mathcal{O})(n) = \bigoplus_{r \geq 0} \mathfrak{s}^{2r}(\mathcal{O}(r+n))^{S_r}.$$

It is not hard to see that the Maurer-Cartan element

$$\varphi \in \text{Conv}(\Lambda^2 \text{coCom}, \mathcal{O})$$

corresponding to the composition

$$j \circ U_{\Lambda \text{Lie}} : \text{Cobar}(\Lambda^2 \text{coCom}) \rightarrow \mathcal{O}$$

is given by the formula:

$$(6.30) \quad \varphi = j(\{a_1, a_2\}) \otimes b_1 b_2.$$

Hence

$$(6.31) \quad \mathcal{L}_{\mathcal{O}}^{\oplus} = \bigoplus_{r \geq 0} \mathfrak{s}^{2r-2}(\mathcal{O}(r))^{S_r}$$

is a sub- dg Lie algebra of $\mathcal{L}_{\mathcal{O}}$ (6.7).

Specifying general formula (6.21) to this particular case, we see that the differential ∂^{Tw} on (6.29) is given by the equation:

$$(6.32) \quad \begin{aligned} \partial^{\text{Tw}}(v) = & -(-1)^{|v|} \sum_{\sigma \in \text{Sh}_{2, r-1}} \sigma(v \circ_1 j(\{a_1, a_2\})) + \sum_{\tau \in \text{Sh}_{1, r}} \tau(j(\{a_1, a_2\}) \circ_2 v) \\ & -(-1)^{|v|} \sum_{\tau' \in \text{Sh}_{r, 1}} \sum_{i=1}^n \tau' \circ \varsigma_{r+1, r+i}(v \circ_{r+i} j(\{a_1, a_2\})), \end{aligned}$$

where

$$v \in \mathfrak{s}^{2r}(\mathcal{O}(r+n))^{S_r},$$

and $\varsigma_{r+1, r+i}$ is the cycle $(r+1, r+2, \dots, r+i)$.

REMARK 6.12. We should remark that, when we apply elementary insertions in the right hand side of (6.32), we view v and $j(\{a_1, a_2\})$ as vectors in $\mathcal{O}(r+n)$ and $\mathcal{O}(2)$ respectively. The resulting sum in the right hand side of (6.32) is viewed as a vector in $\text{Tw}\mathcal{O}(n)$.

6.6. Example: The operad TwGer . Let Ger be the operad which governs Gerstenhaber algebras (see Subsection 3.3.2). Since ΛLie receives a quasi-isomorphism (5.22) from $\Lambda \text{Lie}_{\infty}$ and embeds into Ger , we have a canonical map

$$(6.33) \quad \Lambda \text{Lie}_{\infty} \rightarrow \text{Ger}.$$

This section is devoted to the dg operad TwGer which is associated to the operad Ger and the map (6.33).

According to the general procedure of twisting

$$(6.34) \quad \mathcal{L}_{\text{Ger}} = \text{Conv}(\Lambda^2 \text{coCom}, \text{Ger}) = \prod_{r=1}^{\infty} \mathfrak{s}^{2r-2}(\text{Ger}(r))^{S_r}$$

and the Maurer-Cartan element $\alpha \in \mathcal{L}_{\text{Ger}}$ corresponding to the map (6.33) equals

$$(6.35) \quad \alpha = \{a_1, a_2\}.$$

The graded vector space $\text{TwGer}(n)$ is the product

$$(6.36) \quad \text{TwGer}(n) = \prod_{r \geq 0} \mathfrak{s}^{2r}(\text{Ger}(r+n))^{S_r}.$$

Furthermore, adapting (6.32) to this case we get

$$(6.37) \quad \partial^{\text{Tw}}(v) = -(-1)^{|v|} \sum_{\sigma \in \text{Sh}_{2, r-1}} \sigma(v \circ_1 \{a_1, a_2\}) + \sum_{\tau \in \text{Sh}_{1, r}} \tau(\{a_1, a_2\} \circ_2 v) \\ - (-1)^{|v|} \sum_{\tau' \in \text{Sh}_{r, 1}} \sum_{i=1}^n \tau' \circ \varsigma_{r+1, r+i}(v \circ_{r+i} \{a_1, a_2\}),$$

where

$$v \in \mathfrak{s}^{2r}(\text{Ger}(r+n))^{S_r},$$

and $\varsigma_{r+1, r+i}$ is the cycle $(r+1, r+2, \dots, r+i)$.

EXERCISE 6.13. Prove that for every $v \in \mathfrak{s}^{2r}\text{Ger}(r+n)$

$$(6.38) \quad r \leq |v| + n - 1.$$

Similarly, prove that, for every vector $v \in \mathfrak{s}^{2r-2}\text{Ger}(r)$

$$(6.39) \quad r \leq |v| + 1.$$

Inequalities (6.38) and (6.39) imply that

$$(6.40) \quad \text{TwGer}(n) = \bigoplus_{r=0}^{\infty} \mathfrak{s}^{2r}(\text{Ger}(r+n))^{S_r}$$

and

$$(6.41) \quad \mathcal{L}_{\text{Ger}} = \bigoplus_{r=1}^{\infty} \mathfrak{s}^{2r-2}(\text{Ger}(r))^{S_r}.$$

In other words, $\text{Tw}^{\oplus}\text{Ger} = \text{TwGer}$ and $\mathcal{L}_{\text{Ger}}^{\oplus} = \mathcal{L}_{\text{Ger}}$.

To give a simpler description of the cochain complexes $\text{TwGer}(n)$ (6.40) we consider the free Gerstenhaber algebra

$$\text{Ger}(a, a_1, \dots, a_n)$$

in n variables a_1, \dots, a_n of degree zero and one additional variable a of degree 2.

We introduce the following (degree 1) derivation

$$(6.42) \quad \delta(a) = \frac{1}{2}\{a, a\}, \quad \delta(a_i) = 0 \quad \forall 1 \leq i \leq n$$

of $\text{Ger}(a, a_1, \dots, a_n)$ and observe that

$$\delta^2 = 0$$

in virtue of the Jacobi identity.

Then we denote by \mathcal{G}_n the subspace

$$(6.43) \quad \mathcal{G}_n \subset \text{Ger}(a, a_1, \dots, a_n)$$

spanned by monomials in which each variable a_1, a_2, \dots, a_n appears exactly once. It is obvious that \mathcal{G}_n is a subcomplex of $\text{Ger}(a, a_1, \dots, a_n)$.

We claim that

PROPOSITION 6.14. *The cochain complex \mathcal{G}_n is isomorphic to $\text{TwGer}(n)$.*

PROOF. Indeed, given a monomial $v \in \mathcal{G}_n$ of degree r in a we shift the indices of a_i up by r and replace the r factors a in v by a_1, a_2, \dots, a_r in an arbitrary order. This way we get a monomial $v' \in \text{Ger}(r+n)$. It is easy to see that the formula

$$(6.44) \quad f(v) = \sum_{\sigma \in S_r} \mathbf{s}^{2r} \sigma(v')$$

defines a linear map of vector spaces

$$f : \mathcal{G}_n \rightarrow \text{TwGer}(n) = \bigoplus_{r=0}^{\infty} \mathbf{s}^{2r} (\text{Ger}(r+n))^{S_r}.$$

For example,

$$f(\{a, a\}a_1) = \{a_1, a_2\}a_3 + \{a_2, a_1\}a_3, \quad f(\{a, a_1\}aa_2) = \{a_1, a_3\}a_2a_4 + \{a_2, a_3\}a_1a_4.$$

It is not hard to see that f is an isomorphism of graded vector spaces. Furthermore, f is compatible with the differentials due to the following exercise.

EXERCISE 6.15. Show that the map

$$f : \mathcal{G}_n \rightarrow \text{TwGer}(n) = \bigoplus_{r=0}^{\infty} \mathbf{s}^{2r} (\text{Ger}(r+n))^{S_r}$$

defined by (6.44) is compatible with the differentials ∂^{Tw} and δ . In other words,

$$(6.45) \quad f(\delta v) = \partial^{\text{Tw}} f(v) \quad \forall v \in \mathcal{G}_n.$$

Thus the proposition is proved. \square

Proposition 6.14 implies that every vector $v \in \text{Ger}(n) \subset \text{TwGer}(n)$ is ∂ -closed. Therefore, the obvious embedding

$$(6.46) \quad i : \text{Ger} \rightarrow \text{TwGer}$$

is a map of dg operads.

We claim that¹¹

THEOREM 6.16. *The map (6.46) is a quasi-isomorphism of dg operads. In particular, the dg Lie algebra $\text{Conv}(\Lambda^2 \text{coCom}, \text{Ger})$ is acyclic.*

PROOF. Let us observe that $\Lambda \text{Lie}(a, a_1, \dots, a_n)$ is a subcomplex of $\text{Ger}(a, a_1, \dots, a_n)$. Moreover,

$$(6.47) \quad \text{Ger}(a, a_1, \dots, a_n) = \underline{\mathcal{S}}(\Lambda \text{Lie}(a, a_1, \dots, a_n)),$$

where $\underline{\mathcal{S}}$ is the notation for the truncated symmetric algebra.

Let us denote by

$$(6.48) \quad \Lambda \text{Lie}'(a, a_1, \dots, a_n)$$

the subspace of $\Lambda \text{Lie}(a, a_1, \dots, a_n)$ which is spanned by monomials involving each variable in the set $\{a_1, a_2, \dots, a_n\}$ at most once. It is clear that $\Lambda \text{Lie}'(a, a_1, \dots, a_n)$ is a subcomplex in $\Lambda \text{Lie}(a, a_1, \dots, a_n)$. Hence, the subspace

$$(6.49) \quad \text{Ger}'(a, a_1, \dots, a_n) := \underline{\mathcal{S}}(\Lambda \text{Lie}'(a, a_1, \dots, a_n))$$

is a subcomplex of $\text{Ger}(a, a_1, \dots, a_n)$.

¹¹This statement is also proved in [7].

We will prove every cocycle in $\text{Ger}'(a, a_1, \dots, a_n)$ is cohomologous to a (unique) cocycle in the intersection

$$\text{Ger}'(a, a_1, \dots, a_n) \cap \text{Ger}(a_1, \dots, a_n)$$

and then we will deduce statements of the theorem.

Let us, first, show that every cocycle in $\Lambda\text{Lie}'(a, a_1, \dots, a_n)$ is cohomologous to a cocycle in the intersection

$$\Lambda\text{Lie}'(a, a_1, \dots, a_n) \cap \Lambda\text{Lie}(a_1, \dots, a_n).$$

For this purpose we consider a non-empty ordered subset $\{i_1 < i_2 < \dots < i_k\}$ of $\{1, 2, \dots, n\}$ and denote by

$$(6.50) \quad \Lambda\text{Lie}''(a, a_{i_1}, \dots, a_{i_k})$$

the subcomplex of $\Lambda\text{Lie}'(a, a_1, \dots, a_n)$ which is spanned by ΛLie -monomials in $\Lambda\text{Lie}(a, a_{i_1}, \dots, a_{i_k})$ involving each variable in the set $\{a_{i_1}, \dots, a_{i_k}\}$ exactly once.

It is clear that $\Lambda\text{Lie}'(a, a_1, \dots, a_n)$ splits into the direct sum of subcomplexes:

$$(6.51) \quad \Lambda\text{Lie}'(a, a_1, \dots, a_n) = \mathbb{K}\langle a, \{a, a\} \rangle \oplus \bigoplus_{\{i_1 < i_2 < \dots < i_k\}} \Lambda\text{Lie}''(a, a_{i_1}, \dots, a_{i_k}),$$

where the summation runs over all non-empty ordered subsets $\{i_1 < i_2 < \dots < i_k\}$ of $\{1, 2, \dots, n\}$.

It is not hard to see that the subcomplex $\mathbb{K}\langle a, \{a, a\} \rangle$ is acyclic. Thus our goal is to show that every cocycle in $\Lambda\text{Lie}''(a, a_{i_1}, \dots, a_{i_k})$ is cohomologous to cocycle in the intersection

$$\Lambda\text{Lie}''(a, a_{i_1}, \dots, a_{i_k}) \cap \Lambda\text{Lie}(a_{i_1}, \dots, a_{i_k}).$$

To prove this fact we consider the tensor algebra

$$(6.52) \quad T(\mathbb{K}\langle \mathbf{s}^{-1} a, \mathbf{s}^{-1} a_{i_1}, \mathbf{s}^{-1} a_{i_2}, \dots, \mathbf{s}^{-1} a_{i_{k-1}} \rangle)$$

in the variables $\mathbf{s}^{-1} a, \mathbf{s}^{-1} a_{i_1}, \mathbf{s}^{-1} a_{i_2}, \dots, \mathbf{s}^{-1} a_{i_{k-1}}$ and denote by

$$(6.53) \quad T'(\mathbf{s}^{-1} a, \mathbf{s}^{-1} a_{i_1}, \mathbf{s}^{-1} a_{i_2}, \dots, \mathbf{s}^{-1} a_{i_{k-1}})$$

the subspace of (6.52) which is spanned by monomials involving each variable from the set $\{\mathbf{s}^{-1} a_{i_1}, \mathbf{s}^{-1} a_{i_2}, \dots, \mathbf{s}^{-1} a_{i_{k-1}}\}$ exactly once.

It is not hard to see that the formula

$$(6.54) \quad \nu(x_{j_1} \otimes x_{j_2} \otimes \dots \otimes x_{j_N}) = \{\mathbf{s} x_{j_1}, \{\mathbf{s} x_{j_2}, \{\dots \{\mathbf{s} x_{j_N}, a_{i_k}\}\}\}\}$$

defines an isomorphism of the graded vector spaces

$$\nu : T'(\mathbf{s}^{-1} a, \mathbf{s}^{-1} a_{i_1}, \mathbf{s}^{-1} a_{i_2}, \dots, \mathbf{s}^{-1} a_{i_{k-1}}) \xrightarrow{\cong} \Lambda\text{Lie}''(a, a_{i_1}, \dots, a_{i_k}).$$

Let us denote by δ_T a degree 1 derivation of the tensor algebra (6.52) defined by the equations

$$(6.55) \quad \delta_T(\mathbf{s}^{-1} a_{i_t}) = 0, \quad \delta_T(\mathbf{s}^{-1} a) = \mathbf{s}^{-1} a \otimes \mathbf{s}^{-1} a.$$

It is not hard to see that $(\delta_T)^2 = 0$. Thus, δ_T is a differential on the tensor algebra (6.52).

The subspace (6.53) is obviously a subcomplex of (6.52). Furthermore, using the following consequence of Jacobi identity

$$\{a, \{a, X\}\} = -\frac{1}{2}\{\{a, a\}, X\}, \quad \forall X \in \Lambda\text{Lie}(a, a_1, \dots, a_n),$$

it is easy to show that

$$\delta \circ \nu = \nu \circ \delta_T.$$

Thus ν is an isomorphism from the cochain complex

$$(T'(\mathbf{s}^{-1} a, \mathbf{s}^{-1} a_{i_1}, \mathbf{s}^{-1} a_{i_2}, \dots, \mathbf{s}^{-1} a_{i_{k-1}}), \delta_T)$$

to the cochain complex

$$(\Lambda \text{Lie}''(a, a_{i_1}, \dots, a_{i_k}), \delta).$$

To compute cohomology of the cochain complex

$$(6.56) \quad \left(T(\mathbb{K}\langle \mathbf{s}^{-1} a, \mathbf{s}^{-1} a_{i_1}, \mathbf{s}^{-1} a_{i_2}, \dots, \mathbf{s}^{-1} a_{i_{k-1}} \rangle), \delta_T \right)$$

we observe that the truncated tensor algebra

$$(6.57) \quad \underline{T}_{\mathbf{s}^{-1} a} := \underline{T}(\mathbb{K}\langle \mathbf{s}^{-1} a \rangle)$$

form an acyclic subcomplex of (6.56).

We also observe that the cochain complex (6.56) splits into the direct sum of subcomplexes

$$(6.58) \quad T(\mathbb{K}\langle \mathbf{s}^{-1} a, \mathbf{s}^{-1} a_{i_1}, \mathbf{s}^{-1} a_{i_2}, \dots, \mathbf{s}^{-1} a_{i_{k-1}} \rangle) = T(\mathbb{K}\langle \mathbf{s}^{-1} a_{i_1}, \mathbf{s}^{-1} a_{i_2}, \dots, \mathbf{s}^{-1} a_{i_{k-1}} \rangle) \oplus \bigoplus_{m \geq 2, p_1, \dots, p_m} V_{a_\bullet}^{\otimes p_1} \otimes \underline{T}_{\mathbf{s}^{-1} a} \otimes V_{a_\bullet}^{\otimes p_2} \otimes \underline{T}_{\mathbf{s}^{-1} a} \otimes \dots \otimes V_{a_\bullet}^{\otimes p_{m-1}} \otimes \underline{T}_{\mathbf{s}^{-1} a} \otimes V_{a_\bullet}^{\otimes p_m},$$

where V_{a_\bullet} is the cochain complex

$$V_{a_\bullet} := \mathbb{K}\langle \mathbf{s}^{-1} a_{i_1}, \mathbf{s}^{-1} a_{i_2}, \dots, \mathbf{s}^{-1} a_{i_{k-1}} \rangle$$

with the zero differential and the summation runs over all combinations (p_1, \dots, p_m) of integers satisfying the conditions

$$p_1, p_m \geq 0, \quad p_2, \dots, p_{m-1} \geq 1.$$

By Künneth's theorem all the subcomplexes

$$V_{a_\bullet}^{\otimes p_1} \otimes \underline{T}_{\mathbf{s}^{-1} a} \otimes V_{a_\bullet}^{\otimes p_2} \otimes \underline{T}_{\mathbf{s}^{-1} a} \otimes \dots \otimes V_{a_\bullet}^{\otimes p_{m-1}} \otimes \underline{T}_{\mathbf{s}^{-1} a} \otimes V_{a_\bullet}^{\otimes p_m}$$

are acyclic. Hence for every cocycle c in (6.56) there exists a vector c_1 in (6.56) such that

$$c - \delta_T(c_1) \in T(\mathbb{K}\langle \mathbf{s}^{-1} a_{i_1}, \mathbf{s}^{-1} a_{i_2}, \dots, \mathbf{s}^{-1} a_{i_{k-1}} \rangle).$$

Combining this observation with the fact that the subcomplex (6.53) is a direct summand in (6.56), we conclude that, for every cocycle c in (6.53) there exists a vector c_1 in (6.53) such that

$$c - \delta_T(c_1) \in T'(\mathbf{s}^{-1} a, \mathbf{s}^{-1} a_{i_1}, \mathbf{s}^{-1} a_{i_2}, \dots, \mathbf{s}^{-1} a_{i_{k-1}}) \cap T(\mathbb{K}\langle \mathbf{s}^{-1} a_{i_1}, \mathbf{s}^{-1} a_{i_2}, \dots, \mathbf{s}^{-1} a_{i_{k-1}} \rangle).$$

Since the map ν (6.54) is an isomorphism from the cochain complex (6.53) with the differential δ_T to the cochain complex (6.50) with the differential δ , we deduce that every cocycle in (6.50) is cohomologous to a unique cocycle in the intersection

$$\Lambda \text{Lie}''(a, a_{i_1}, \dots, a_{i_k}) \cap \Lambda \text{Lie}(a_{i_1}, \dots, a_{i_k}).$$

Therefore every cocycle in $\Lambda \text{Lie}'(a, a_1, \dots, a_n)$ is cohomologous to a unique cocycle in the intersection

$$\Lambda \text{Lie}'(a, a_1, \dots, a_n) \cap \Lambda \text{Lie}(a_1, \dots, a_n).$$

Combining the latter observation with decomposition (6.49) we conclude that every cocycle in $\text{Ger}'(a, a_1, \dots, a_n)$ is cohomologous to a (unique) cocycle in the intersection

$$\text{Ger}'(a, a_1, \dots, a_n) \cap \text{Ger}(a_1, \dots, a_n).$$

Thus, using the isomorphism

$$\mathcal{G}_n \cong \text{TwGer}(n)$$

together with the fact that the cochain complex \mathcal{G}_n is a direct summand in $\text{Ger}'(a, a_1, \dots, a_n)$, we deduce the first statement of Theorem 6.16.

On the other hand, since $\text{Ger}(0) = \mathbf{0}$, Remark 6.9 implies that

$$\text{Conv}(\Lambda^2 \text{coCom}, \text{Ger}) \cong \mathfrak{s}^{-2} \text{TwGer}(0).$$

Hence the second statement of Theorem 6.16 follows as well.

The theorem is proved. \square

6.7. The dg Lie algebra $\text{Conv}^\oplus(\text{Ger}^\vee, \mathcal{O})$. The filtration by Lie words of length 1. Let \mathcal{O} be a dg operad and ι be a map (of dg operads)

$$(6.59) \quad \iota : \text{Ger} \rightarrow \mathcal{O}.$$

(Here, we assume that $\mathcal{O}(0) = \mathbf{0}$.)

In this subsection we will describe an auxiliary construction related to the pair (\mathcal{O}, ι) . In these notes, we will use this construction twice. First, we will use it in the case when $\mathcal{O} = \text{Ger}$. Second, we will use it in the case when¹² $\mathcal{O} = \text{Gra}$.

Restricting ι to the suboperad ΛLie we get a morphism of dg operads

$$(6.60) \quad \mathfrak{j} = \iota \Big|_{\Lambda\text{Lie}} : \Lambda\text{Lie} \rightarrow \mathcal{O}.$$

Thus, following Section 6.5, we may construct the dg operad $\text{Tw}\mathcal{O}$ as well as its suboperad $\text{Tw}^\oplus(\mathcal{O}) \subset \text{Tw}\mathcal{O}$ (6.29).

On the other hand composing ι with U_{Ger} (5.20) we get a morphism

$$(6.61) \quad \iota \circ U_{\text{Ger}} : \text{Cobar}(\text{Ger}^\vee) \rightarrow \mathcal{O}.$$

It is not hard to see that the Maurer-Cartan element $\alpha \in \text{Conv}(\text{Ger}^\vee, \mathcal{O})$ corresponding to the morphism (6.61) is given by the formula

$$(6.62) \quad \alpha = \iota(\{a_1, a_2\}) \otimes b_1 b_2 + \iota(a_1 a_2) \otimes \{b_1, b_2\}.$$

Since $\alpha \in \text{Conv}^\oplus(\text{Ger}^\vee, \mathcal{O})$, it makes sense to consider the cochain complex

$$(6.63) \quad \text{Conv}^\oplus(\text{Ger}^\vee, \mathcal{O}) = \bigoplus_{n \geq 1} \left(\mathcal{O}(n) \otimes \Lambda^{-2} \text{Ger}(n) \right)^{S_n}$$

with the differential

$$(6.64) \quad \partial = [\alpha, \].$$

Let us denote by $\mathfrak{L}_1(w)$ the number of Lie words of length 1 in a monomial $w \in \Lambda^{-2} \text{Ger}(n)$. For example, $\mathfrak{L}_1(b_1 b_2) = 2$ and $\mathfrak{L}_1(\{b_1, b_2\}) = 0$.

Next we consider a vector $v \in \mathcal{O}(n)$ and observe that for every vector $v_i \otimes w_i$ in the linear combination

$$\partial \left(\sum_{\sigma \in S_n} \sigma(v) \otimes \sigma(w) \right)$$

¹²The operad Gra is introduced in Section 7 below.

we have $\mathfrak{L}_1(w_i) = \mathfrak{L}_1(w)$ or $\mathfrak{L}_1(w_i) = \mathfrak{L}_1(w) + 1$.

This observation allows us to introduce the following ascending filtration

$$(6.65) \quad \dots \subset \mathcal{F}^{m-1} \text{Conv}^\oplus(\text{Ger}^\vee, \mathcal{O}) \subset \mathcal{F}^m \text{Conv}^\oplus(\text{Ger}^\vee, \mathcal{O}) \subset \dots,$$

where $\mathcal{F}^m \text{Conv}^\oplus(\text{Ger}^\vee, \mathcal{O})$ consists of sums

$$\sum_i v_i \otimes w_i \in \bigoplus_n (\mathcal{O}(n) \otimes \Lambda^{-2} \text{Ger}(n))^{S_n}$$

which satisfy

$$\mathfrak{L}_1(w_i) - |v_i \otimes w_i| \leq m, \quad \forall i.$$

It is clear that the associated graded complex

$$(6.66) \quad \text{Gr Conv}^\oplus(\text{Ger}^\vee, \mathcal{O}) \cong \bigoplus_{n=1}^{\infty} \left(\mathcal{O}(n) \otimes \Lambda^{-2} \text{Ger}(n) \right)^{S_n}$$

as a graded vector space, and the differential ∂^{Gr} on $\text{Gr Conv}^\oplus(\text{Ger}^\vee, \mathcal{O})$ is obtained from the differential ∂ (6.64) on $\text{Conv}^\oplus(\text{Ger}^\vee, \mathcal{O})$ by keeping only terms which raise the number of Lie brackets of length 1 in the second tensor factors. For example, the adjoint action

$$[\iota(a_1 a_2) \otimes \{b_1, b_2\},]$$

of $\iota(a_1 a_2) \otimes \{b_1, b_2\}$ does not contribute to the differential ∂^{Gr} at all.

To give a convenient description of the cochain complex (6.66) we introduce the collection

$$(6.67) \quad \{\Lambda^{-2} \text{Ger}^\heartsuit(n)\}_{n \geq 0}$$

where

$$\Lambda^{-2} \text{Ger}^\heartsuit(0) = \mathfrak{s}^{-2} \mathbb{K}$$

and

$$\Lambda^{-2} \text{Ger}^\heartsuit(n), \quad n \geq 1$$

is the S_n -submodule of $\Lambda^{-2} \text{Ger}(n)$ spanned by monomials $w \in \Lambda^{-2} \text{Ger}(n)$ for which $\mathfrak{L}_1(w) = 0$.

Next, we introduce the cochain complex

$$(6.68) \quad \bigoplus_{n \geq 1} \left(\text{Tw}^\oplus \mathcal{O}(n) \otimes \Lambda^{-2} \text{Ger}^\heartsuit(n) \right)^{S_n} = \bigoplus_{r \geq 0} \bigoplus_{n \geq 1} \left((\mathfrak{s}^{2r} \mathcal{O}(r+n))^{S_r} \otimes \Lambda^{-2} \text{Ger}^\heartsuit(n) \right)^{S_n}$$

with the differential ∂^{Tw} coming from $\text{Tw} \mathcal{O}$.

We observe that the formula

$$(6.69) \quad \Upsilon_{\mathcal{O}} \left(\sum_i v_i \otimes w_i \right) := \sum_{\sigma \in \text{Sh}_{r,n}} \sum_i \sigma(v_i) \otimes \sigma(b_1 \dots b_r w_i(b_{r+1}, \dots, b_{r+n}))$$

$$\sum_i v_i \otimes w_i \in \left(\mathfrak{s}^{2r} \mathcal{O}(r+n)^{S_r} \otimes \Lambda^{-2} \text{Ger}^\heartsuit(n) \right)^{S_n}$$

defines a morphism of graded vector spaces

$$(6.70) \quad \Upsilon_{\mathcal{O}} : \bigoplus_{n \geq 0} \left(\text{Tw}^\oplus \mathcal{O}(n) \otimes \Lambda^{-2} \text{Ger}^\heartsuit(n) \right)^{S_n} \rightarrow \text{Gr Conv}^\oplus(\text{Ger}^\vee, \mathcal{O}).$$

We claim that

PROPOSITION 6.17. *The map $\Upsilon_{\mathcal{O}}$ (6.70) is an isomorphism of cochain complexes.*

PROOF. It is clear that (6.66) is spanned by vectors of the form

$$(6.71) \quad \sum_{\tau \in S_{r+n}} \tau(v) \otimes \tau(b_1 \dots b_r w(b_{r+1}, \dots, b_{r+n})),$$

where v is a vector in $\mathcal{O}(r+n)$, w is a monomial $\Lambda^{-2}\text{Ger}^{\heartsuit}(n)$, and numbers r, n vary within the range $r, n \geq 0, r+n \geq 1$.

Using the obvious identity

$$\begin{aligned} & \sum_{\tau \in S_{r+n}} \tau(v) \otimes \tau(b_1 \dots b_r w(b_{r+1}, \dots, b_{r+n})) = \\ & \sum_{\sigma \in \text{Sh}_{r,n}} \sigma \left(\sum_{(\tau', \tau'') \in S_r \times S_n \subset S_{r+n}} (\tau', \tau'')(v) \otimes b_1 \dots b_r (\tau'' w)(b_{r+1}, \dots, b_{r+n}) \right) \end{aligned}$$

we see that the formula

$$(6.72) \quad \tilde{\Upsilon}_{\mathcal{O}} \left(\sum_{\sigma \in S_{r+n}} \sigma(v) \otimes \sigma(b_1 \dots b_r w(b_{r+1}, \dots, b_{r+n})) \right) = \\ \sum_{\tau'' \in S_n} \tau'' \left(\sum_{\tau' \in S_r} \tau'(v) \right) \otimes \tau''(w)$$

gives us a well-defined map

$$(6.73) \quad \tilde{\Upsilon}_{\mathcal{O}} : \text{Gr Conv}^{\oplus}(\text{Ger}^{\vee}, \mathcal{O}) \rightarrow \bigoplus_{n \geq 0} \left(\text{Tw}\mathcal{O}(n) \otimes \Lambda^{-2}\text{Ger}^{\heartsuit}(n) \right)^{S_n}.$$

Furthermore, it is obvious that $\tilde{\Upsilon}_{\mathcal{O}}$ is the inverse of $\Upsilon_{\mathcal{O}}$.

Thus $\Upsilon_{\mathcal{O}}$ is an isomorphism of graded vector spaces.

Before proving that Υ is compatible with the differentials, let us recall that, for $i < j$, $\varsigma_{i,j}$ denotes the cycle $(i, i+1, \dots, j) \in S_n$ for any $n \geq j$. Furthermore, $S_{i, i+1, \dots, n}$ denotes the permutation group of the set $\{i, i+1, \dots, n\}$.

Let, as above, v be a vector in $\mathcal{O}(r+n)$ and w be a monomial in $\Lambda^{-2}\text{Ger}^{\heartsuit}(n)$. Due to the above consideration,

$$(6.74) \quad \sum_{\tau \in S_{r+n}} \tau(v) \otimes \tau(b_1 \dots b_r w(b_{r+1}, \dots, b_{r+n})) = \Upsilon_{\mathcal{O}} \left(\sum_{\lambda \in S_n} \lambda(\text{Av}_r(v)) \otimes \lambda(w) \right),$$

where

$$\text{Av}_r(v) = \sum_{\lambda_1 \in S_r} \lambda_1(v)$$

is viewed as a vector in $\text{Tw}\mathcal{O}(n)$.

Thus our goal is to show that

$$(6.75) \quad \partial^{\text{Gr}} \left(\sum_{\tau \in S_{r+n}} \tau(v) \otimes \tau(b_1 \dots b_r w(b_{r+1}, \dots, b_{r+n})) \right) =$$

$$\Upsilon_{\mathcal{O}} \left(\sum_{\lambda \in S_n} \partial^{\text{Tw}} \circ \lambda(\text{Av}_r(v)) \otimes \lambda(w) \right).$$

Collecting terms with $r+1$ Lie words of length 1 in the second tensor factors in

$$\left[\iota(\{a_1, a_2\}) \otimes b_1 b_2, \sum_{\tau \in S_{r+n}} \tau(v) \otimes \tau(b_1 \dots b_r w(b_{r+1}, \dots, b_{r+n})) \right]$$

and using the obvious identity

$$\begin{aligned} & \sum_{\tau \in S_{r+n}} \tau(v) \otimes \tau(b_1 \dots b_r w(b_{r+1}, \dots, b_{r+n})) = \\ & \sum_{\tau' \in S_{2,3,\dots,r+n}} \sum_{i=1}^{r+n} \tau'(\varsigma_{1,i}(v) \otimes \varsigma_{1,i}(b_1 \dots b_r w(b_{r+1}, \dots, b_{r+n}))) \end{aligned}$$

we get

$$\begin{aligned} (6.76) \quad & \partial^{\text{Gr}} \left(\sum_{\tau \in S_{r+n}} \tau(v) \otimes \tau(b_1 \dots b_r w(b_{r+1}, \dots, b_{r+n})) \right) = \\ & = \sum_{\sigma \in \text{Sh}_{r+n,1}} \sum_{\tau \in S_{r+n}} \sigma(\iota(\{a_1, a_2\}) \circ_1 \tau(v)) \otimes \sigma(\tau(b_1 \dots b_r w(b_{r+1}, \dots, b_{r+n})) b_{r+n+1}) \\ & \quad - (-1)^{|v|} \sum_{\lambda \in \text{Sh}_{2,r+n-1}} \sum_{\tau' \in S_{3,4,\dots,r+n+1}} \sum_{i=1}^r \lambda(\tau' \circ \theta_i(v \circ_i \iota(\{a_1, a_2\}))) \\ & \quad \otimes b_1 b_2 b_{\tau'(3)} \dots b_{\tau'(r+1)} w(b_{\tau'(r+2)}, \dots, b_{\tau'(r+1+n)}) \\ & \quad - (-1)^{|v|} \sum_{\lambda \in \text{Sh}_{2,r+n-1}} \sum_{\tau' \in S_{3,4,\dots,r+n+1}} \sum_{i=r+1}^{r+n} \lambda(\tau' \circ \theta_i(v \circ_i \iota(\{a_1, a_2\}))) \\ & \quad \otimes b_{\tau'(3)} \dots b_{\tau'(r+2)} b_1 w(b_{\tau'(r+3)}, \dots, b_{\tau'(i+1)}, b_2, b_{\tau'(i+2)}, \dots, b_{\tau'(r+1+n)}) \\ & \quad - (-1)^{|v|} \sum_{\lambda \in \text{Sh}_{2,r+n-1}} \sum_{\tau' \in S_{3,4,\dots,r+n+1}} \sum_{i=r+1}^{r+n} \lambda(\tau' \circ \theta_i(v \circ_i \iota(\{a_1, a_2\}))) \\ & \quad \otimes b_{\tau'(3)} \dots b_{\tau'(r+2)} b_2 w(b_{\tau'(r+3)}, \dots, b_{\tau'(i+1)}, b_1, b_{\tau'(i+2)}, \dots, b_{\tau'(r+1+n)}), \end{aligned}$$

where θ_i is the following permutation in S_{r+1+n}

$$(6.77) \quad \theta_i = \begin{pmatrix} 1 & 2 & \dots & i-1 & i & i+1 \\ 3 & 4 & \dots & i+1 & 1 & 2 \end{pmatrix}.$$

The first sum in the right hand side of (6.76) can be simplified as follows.

$$\begin{aligned} & \sum_{\sigma \in \text{Sh}_{r+n,1}} \sum_{\tau \in S_{r+n}} \sigma(\iota(\{a_1, a_2\}) \circ_1 \tau(v)) \otimes \sigma(\tau(b_1 \dots b_r w(b_{r+1}, \dots, b_{r+n})) b_{r+n+1}) = \\ (6.78) \quad & \sum_{\lambda \in S_{r+1+n}} \lambda(\iota(\{a_1, a_2\}) \circ_1 v) \otimes \lambda(b_1 \dots b_r w(b_{r+1}, \dots, b_{r+n}) b_{r+n+1}) = \\ & \sum_{\lambda \in S_{r+1+n}} \lambda \circ \varsigma_{1,r+1+n}(\iota(\{a_1, a_2\}) \circ_1 v) \otimes \lambda \circ \varsigma_{1,r+1+n}(b_1 \dots b_r w(b_{r+1}, \dots, b_{r+n}) b_{r+n+1}) = \end{aligned}$$

$$\begin{aligned}
& \sum_{\lambda \in S_{r+1+n}} \lambda(\iota(\{a_1, a_2\}) \circ_2 v) \otimes \lambda(b_1 \dots b_{r+1} w(b_{r+2}, \dots, b_{r+1+n})) = \\
& \sum_{\substack{(\lambda_1, \lambda_2) \in S_{r+1} \times S_n \\ \sigma \in \text{Sh}_{r+1, n}}} \sigma((\lambda_1, \lambda_2)(\iota(\{a_1, a_2\}) \circ_2 v) \otimes \lambda_2(b_1 \dots b_{r+1} w(b_{r+2}, \dots, b_{r+1+n}))) = \\
& \sum_{\substack{\tau \in \text{Sh}_{1, r} \\ \sigma \in \text{Sh}_{r+1, n}}} \sum_{\substack{\lambda'' \in S_{r+2, \dots, r+1+n} \\ \lambda' \in S_{2, \dots, r+1}}} \sigma(\tau \circ \lambda' \circ \lambda''(\iota(\{a_1, a_2\}) \circ_2 v) \\
& \quad \otimes b_1 \dots b_{r+1} w(b_{\lambda''(r+2)}, \dots, b_{\lambda''(r+1+n)})) .
\end{aligned}$$

Thus

$$(6.79) \quad \text{The first sum in the R.H.S. of (6.76)} =$$

$$\Upsilon_{\mathcal{O}} \left(\sum_{\tau \in \text{Sh}_{1, r}} \sum_{\lambda \in S_n} \tau(\{a_1, a_2\} \circ_2 \lambda(\text{Av}_r(v))) \otimes \lambda(w) \right) .$$

Using the symmetry of the bracket $\{ , \}$, we rewrite the second sum in the right hand side of (6.76) as follows

$$\begin{aligned}
& -(-1)^{|v|} \sum_{\lambda \in \text{Sh}_{2, r+n-1}}^{\tau' \in S_{3, 4, \dots, r+n+1}} \sum_{i=1}^r \lambda(\tau' \circ \theta_i(v \circ_i \iota(\{a_1, a_2\}))) \\
(6.80) \quad & \otimes b_1 b_2 b_{\tau'(3)} \dots b_{\tau'(r+1)} w(b_{\tau'(r+2)}, \dots, b_{\tau'(r+1+n)})) = \\
& -\frac{(-1)^{|v|}}{2} \sum_{\lambda \in S_{r+1+n}} \sum_{i=1}^r \lambda(\theta_i(v \circ_i \iota(\{a_1, a_2\})) \otimes b_1 b_2 b_3 \dots b_{r+1} w(b_{r+2}, \dots, b_{r+1+n})) = \\
& -\frac{(-1)^{|v|}}{2} \sum_{\sigma \in \text{Sh}_{r+1, n}} \sum_{\lambda' \in S_{r+1}}^{\lambda'' \in S_{r+2, \dots, r+1+n}} \sum_{i=1}^r \sigma \circ \lambda'' \circ \lambda'(\theta_i(v \circ_i \iota(\{a_1, a_2\}))) \\
& \quad \otimes b_1 b_2 \dots b_{r+1} w(b_{r+2}, \dots, b_{r+1+n})) = \\
& -(-1)^{|v|} \sum_{\sigma \in \text{Sh}_{r+1, n}} \sum_{\lambda_1 \in S_{3, \dots, r+1}}^{\tau \in \text{Sh}_{2, r-1} \quad \lambda_2 \in S_{r+2, \dots, r+1+n}} \sum_{i=1}^r \sigma \circ \tau(\lambda_2 \circ \lambda_1 \circ \theta_i(v \circ_i \iota(\{a_1, a_2\}))) \\
& \quad \otimes b_1 b_2 \dots b_{r+1} w(b_{\lambda_2(r+2)}, \dots, b_{\lambda_2(r+1+n)})) = \\
& -(-1)^{|v|} \sum_{\sigma \in \text{Sh}_{r+1, n}} \sum_{\lambda'_1 \in S_r}^{\tau \in \text{Sh}_{2, r-1} \quad \lambda_2 \in S_{r+2, \dots, r+1+n}} \sigma(\lambda_2 \circ \tau(\lambda'_1(v) \circ_1 \{a_1, a_2\}) \otimes b_1 b_2 \dots b_{r+1} w(b_{\lambda_2(r+2)}, \dots, b_{\lambda_2(r+1+n)})) ,
\end{aligned}$$

where θ_i is defined in (6.77).

Thus

$$(6.81) \quad \text{The second sum in the R.H.S. of (6.76)} =$$

$$-(-1)^{|v|} \Upsilon_{\mathcal{O}} \left(\sum_{\tau \in \text{Sh}_{2,r-1}} \sum_{\lambda \in S_n} \lambda \left(\tau(\text{Av}_r(v) \circ_1 \{a_1, a_2\}) \right) \otimes \lambda(w) \right),$$

where $\text{Av}_r(v)$ is viewed as a vector in $\mathcal{O}(r+n)$ and $\tau(\text{Av}_r(v) \circ_1 \{a_1, a_2\})$ is viewed as a vector in $\text{Tw}\mathcal{O}(n)$.

Due to Exercise 6.18 below,

(6.82) The combination of the last two sums in the R.H.S. of (6.76) =

$$-(-1)^{|v|} \Upsilon_{\mathcal{O}} \left(\sum_{\tau \in \text{Sh}_{r,1}} \sum_{\lambda \in S_n} \sum_{i=1}^n \lambda \left(\tau \circ \varsigma_{r+1,r+i}(\text{Av}_r(v) \circ_{r+i} \iota(\{a_1, a_2\})) \right) \otimes \lambda(w) \right),$$

where $\text{Av}_r(v)$ is viewed as a vector in $\mathcal{O}(r+n)$ and

$$\tau \circ \varsigma_{r+1,r+i}(\text{Av}_r(v) \circ_{r+i} \iota(\{a_1, a_2\}))$$

is viewed as a vector in $\text{Tw}\mathcal{O}(n)$.

Comparing (6.79), (6.81), and (6.82) with the second, the first and the third sums, respectively, in the right hand side of equation (6.32) from Section 6.5, we see that the equation (6.75) indeed holds.

Proposition 6.17 is proved. \square

EXERCISE 6.18. Let v be a vector in $\mathcal{O}(r+n)$ and w be a monomial in $\Lambda^{-2}\text{Ger}^{\heartsuit}(n)$. Prove that

(6.83) The combination of the last two sums in the R.H.S. of (6.76) =

$$-(-1)^{|v|} \Upsilon_{\mathcal{O}} \left(\sum_{\tau \in \text{Sh}_{r,1}} \sum_{\lambda \in S_n} \sum_{i=1}^n \lambda \left(\tau \circ \varsigma_{r+1,r+i}(\text{Av}_r(v) \circ_{r+i} \iota(\{a_1, a_2\})) \right) \otimes \lambda(w) \right),$$

where

$$\text{Av}_r(v) = \sum_{\lambda_1 \in S_r} \lambda_1(v).$$

Hint for Exercise 6.18: Using the symmetry of the bracket $\{ , \}$ we can rewrite the combination of the last two sums in the right hand side of (6.76) as follows:

(6.84) The combination of the last two sums in the R.H.S. of (6.76) =

$$\begin{aligned} & -(-1)^{|v|} \sum_{i=r+1}^{r+n} \sum_{\lambda \in S_{r+1+n}} \lambda \left(\theta_i(v \circ_i \iota(\{a_1, a_2\})) \right. \\ & \left. \otimes b_2 b_3 \dots b_{r+2} w(b_{r+3}, \dots, b_{i+1}, b_1, b_{i+2}, \dots, b_{r+1+n}) \right) = \\ & -(-1)^{|v|} \sum_{i=r+1}^{r+n} \sum_{\lambda \in S_{r+1+n}} \lambda \circ \varsigma_{1,i+1}^{-1} \left(\theta_i(v \circ_i \iota(\{a_1, a_2\})) \right. \\ & \left. \otimes b_2 b_3 \dots b_{r+2} w(b_{r+3}, \dots, b_{i+1}, b_1, b_{i+2}, \dots, b_{r+1+n}) \right) = \\ & -(-1)^{|v|} \sum_{i=r+1}^{r+n} \sum_{\lambda \in S_{r+1+n}} \lambda \left(\varsigma_{1,i}(v \circ_i \iota(\{a_1, a_2\})) \otimes b_1 b_2 \dots b_{r+1} w(b_{r+2}, \dots, b_{r+1+n}) \right) = \end{aligned}$$

$$\begin{aligned}
 & -(-1)^{|v|} \sum_{i=r+1}^{r+n} \sum_{\lambda \in S_{r+1+n}} \lambda \circ \varsigma_{1,r+1}^{-1} \left(\varsigma_{1,i} (v \circ_i \iota(\{a_1, a_2\})) \otimes b_1 b_2 \dots b_{r+1} w(b_{r+2}, \dots, b_{r+1+n}) \right) = \\
 & -(-1)^{|v|} \sum_{i=r+1}^{r+n} \sum_{\lambda \in S_{r+1+n}} \lambda \left(\varsigma_{r+1,i} (v \circ_i \iota(\{a_1, a_2\})) \otimes b_1 b_2 \dots b_{r+1} w(b_{r+2}, \dots, b_{r+1+n}) \right).
 \end{aligned}$$

7. The operad \mathbf{Gra} and its link to the operad \mathbf{Ger}

Let us recall from [42] the operad (in $\mathbf{grVect}_{\mathbb{K}}$) of labeled graphs \mathbf{Gra} .

To define the space $\mathbf{Gra}(n)$ (for $n \geq 1$) we introduce an auxiliary set \mathbf{gra}_n . An element of \mathbf{gra}_n is a labelled graph Γ with n vertices and with the additional piece of data: the set of edges of Γ is equipped with a total order. An example of an element in \mathbf{gra}_4 is shown on figure 26. We will often use Roman numerals to specify

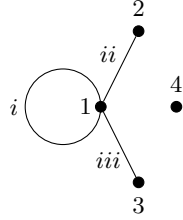

FIG. 26. The Roman numerals indicate that we chose the total order on the set of edges $(1, 1) < (1, 2) < (1, 3)$

total orders on sets of edges. Thus the Roman numerals on figure 26 indicate that we chose the total order $(1, 1) < (1, 2) < (1, 3)$.

The space $\mathbf{Gra}(n)$ (for $n \geq 1$) is spanned by elements of \mathbf{gra}_n , modulo the relation $\Gamma^\sigma = (-1)^{|\sigma|} \Gamma$ where the elements Γ^σ and Γ correspond to the same labelled graph but differ only by permutation σ of edges. We also declare that the degree of a graph Γ in $\mathbf{Gra}(n)$ equals $-e(\Gamma)$, where $e(\Gamma)$ is the number of edges in Γ . For example, the graph Γ on figure 26 has 3 edges. Thus its degree is -3 .

Finally, we set

$$(7.1) \quad \mathbf{Gra}(0) = \mathbf{0}.$$

REMARK 7.1. It clear that, if a graph $\Gamma \in \mathbf{gra}_n$ has multiple edges, then

$$\Gamma = -\Gamma$$

in $\mathbf{Gra}(n)$. Thus for every graph $\Gamma \in \mathbf{gra}_n$ with multiple edges $\Gamma = 0$ in $\mathbf{Gra}(n)$.

We will now define elementary insertions for the collection $\{\mathbf{Gra}(n)\}_{n \geq 0}$.

Let Γ and $\tilde{\Gamma}$ be graphs representing vectors in $\mathbf{Gra}(n)$ and $\mathbf{Gra}(m)$, respectively.

Let $1 \leq i \leq m$.

The vector $\tilde{\Gamma} \circ_i \Gamma \in \mathbf{Gra}(n + m - 1)$ is represented by the sum of graphs $\Gamma_\alpha \in \mathbf{gra}_{n+m-1}$

$$(7.2) \quad \tilde{\Gamma} \circ_i \Gamma = \sum_{\alpha} \Gamma_{\alpha},$$

where Γ_α is obtained by “plugging in” the graph Γ into the i -th vertex of the graph $\tilde{\Gamma}$ and reconnecting the edges incident to the i -th vertex of $\tilde{\Gamma}$ to vertices of Γ in all possible ways. (The index α refers to a particular way of connecting the edges incident to the i -th vertex of $\tilde{\Gamma}$ to vertices of Γ .) After reconnecting edges we label vertices of Γ_α as follows:

- we leave the same labels on the first $i - 1$ vertices of $\tilde{\Gamma}$;
- we shift all labels on vertices of Γ up by $i - 1$;
- finally, we shift the labels on the last $m - i$ vertices of $\tilde{\Gamma}$ up by $n - 1$.

To define the total order on edges of the graph Γ_α we declare that all edges of $\tilde{\Gamma}$ are smaller than all edges of the graph Γ .

EXAMPLE 7.2. Let $\tilde{\Gamma}$ (resp. Γ) be the graph depicted on figure 27 (resp. figure 28). The vector $\tilde{\Gamma} \circ_2 \Gamma$ is shown on figure 29.

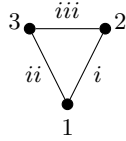

FIG. 27. A graph $\tilde{\Gamma} \in \text{gra}_3$



FIG. 28. A graph $\Gamma \in \text{gra}_2$

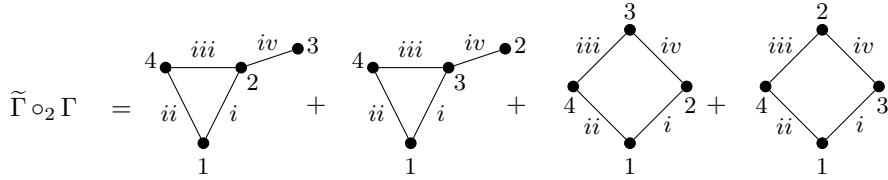

FIG. 29. The vector $\tilde{\Gamma} \circ_2 \Gamma \in \text{Gra}(4)$

The symmetric group S_n acts on $\text{Gra}(n)$ in the obvious way by rearranging the labels on vertices. It is not hard to see that insertions (7.2) together with this action of S_n give on Gra an operad structure with the identity element being the unique graph in gra_1 with no edges.

It is clear that if two graphs $\tilde{\Gamma}$ and Γ representing vectors in Gra do not have loops (i.e. cycles of length 1) then each graph in the linear combination $\tilde{\Gamma} \circ_i \Gamma$ does not have loops either. Thus, by discarding graphs with loops, we arrive at a suboperad Gra_\emptyset of Gra .

The graphs depicted below represent vectors in $\text{Gra}_\emptyset(2)$ and in $\text{Gra}(2)$.

$$(7.3) \quad \Gamma_{\bullet\bullet} = \begin{array}{c} 1 \quad 2 \\ \bullet \text{---} \bullet \end{array} \quad \Gamma_{\bullet\bullet} = \begin{array}{c} 1 \quad 2 \\ \bullet \quad \bullet \end{array}$$

Later they will play a special role.

7.1. “Graphical” interpretation of the operad Ger. Since Ger is generated by the monomials a_1a_2 , $\{a_1, a_2\} \in \text{Ger}(2)$, any map of operads

$$f : \text{Ger} \rightarrow \mathcal{O}$$

is uniquely determined by its values on a_1a_2 and $\{a_1, a_2\}$.

EXERCISE 7.3. Let $\Gamma_{\bullet\bullet}$ and $\Gamma_{\bullet\bullet}$ be the vectors in $\text{Gra}(2)$ introduced in (7.3). Prove that the assignment

$$(7.4) \quad \iota(a_1a_2) = \Gamma_{\bullet\bullet}, \quad \iota(\{a_1, a_2\}) = \Gamma_{\bullet\bullet}$$

defines a map of operads (in $\text{grVect}_{\mathbb{K}}$)

$$(7.5) \quad \iota : \text{Ger} \rightarrow \text{Gra}.$$

Notice that, one only has to check that

$$\begin{aligned} \iota((a_1a_2)a_3 - a_1(a_2a_3)) &= 0, \\ \iota(\{a_1, a_2a_3\} - \{a_1, a_2\}a_3 + a_2\{a_1, a_3\}) &= 0, \\ \iota(\{\{a_1, a_2\}, a_3\} + \{\{a_2, a_3\}, a_1\} + \{\{a_3, a_1\}, a_2\}) &= 0. \end{aligned}$$

We claim that

PROPOSITION 7.4. *The map of operads $\iota : \text{Ger} \rightarrow \text{Gra}$ is injective.*

PROOF. Recall that due to Exercise 3.12, the monomials

$$(7.6) \quad \{a_{i_{11}}, \dots, \{a_{i_{1(p_1-1)}}, a_{i_{1p_1}}\}\} \dots \{a_{i_{t1}}, \dots, \{a_{i_{t(p_t-1)}}, a_{i_{tp_t}}\}\}$$

corresponding to the ordered partitions (3.30) form a basis of $\text{Ger}(n)$.

Let us observe that for every ordered partition (3.30) the graph depicted on figure 30 enters the linear combination

$$\iota(\{a_{i_{11}}, \dots, \{a_{i_{1(p_1-1)}}, a_{i_{1p_1}}\}\} \dots \{a_{i_{t1}}, \dots, \{a_{i_{t(p_t-1)}}, a_{i_{tp_t}}\}\})$$

with the coefficient 1.

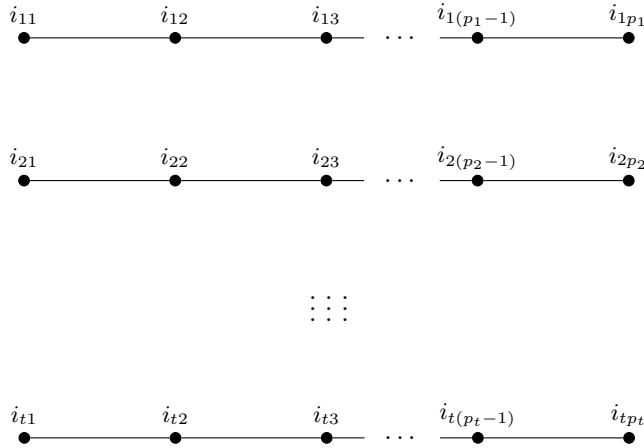

FIG. 30. The edges are ordered “left to right”, “top to bottom”

Since such graphs are linearly independent in $\text{Gra}(n)$, we conclude that ι is indeed injective.

The proposition is proved. □

8. The full graph complex fGC: the first steps

Let $\Gamma_{\bullet\bullet}$ and $\Gamma_{\bullet\bullet}$ be the vectors in $\text{Gra}(2)$ introduced in (7.3). Following Exercise 7.3 and Proposition 7.3 the formulas

$$\iota(\{a_1, a_2\}) = \Gamma_{\bullet\bullet}, \quad \iota(a_1 a_2) = \Gamma_{\bullet\bullet}$$

define an embedding ι of the operad Ger into the operad Gra .

Thus, restricting ι to the suboperad $\Lambda\text{Lie} \subset \text{Ger}$ we get an embedding

$$\Lambda\text{Lie} \hookrightarrow \text{Gra}.$$

Hence we have a canonical map of (dg) operads

$$(8.1) \quad \varphi_{\text{Gra}} : \Lambda\text{Lie}_\infty \rightarrow \text{Gra}.$$

Applying the general procedure of twisting (see Section 6) to the pair $(\text{Gra}, \varphi_{\text{Gra}})$ we get a dg operad TwGra and a dg Lie algebra

$$(8.2) \quad \mathcal{L}_{\text{Gra}} = \text{Conv}(\Lambda^2 \text{coCom}, \text{Gra})$$

which acts on the operad TwGra .

Following [42] we denote the dg Lie algebra \mathcal{L}_{Gra} by fGC. In other words,

$$(8.3) \quad \text{fGC} = \text{Conv}(\Lambda^2 \text{coCom}, \text{Gra})$$

The vector

$$(8.4) \quad \Gamma_{\bullet\bullet} \in \text{fGC}$$

is a Maurer-Cartan element in fGC and the differential on fGC is given by the formula:

$$(8.5) \quad \partial = \text{ad}_{\Gamma_{\bullet\bullet}}.$$

DEFINITION 8.1. The cochain complex fGC (8.3) with the differential (8.5) is called the *full graph complex*.

In this subsection we take a first few steps towards analyzing the cochain complex fGC.

Unfolding the definition of the convolution Lie algebra we get

$$(8.6) \quad \begin{aligned} \text{fGC} &= \prod_{n=1}^{\infty} \text{Hom}_{S_n}(\Lambda^2 \text{coCom}(n), \text{Gra}(n)) = \prod_{n=1}^{\infty} \text{Hom}_{S_n}(\mathfrak{s}^{2-2n} \mathbb{K}, \text{Gra}(n)) = \\ &= \prod_{n=1}^{\infty} \mathfrak{s}^{2n-2} (\text{Gra}(n))^{S_n}. \end{aligned}$$

In other words, vectors in fGC are infinite sums

$$(8.7) \quad \gamma = \sum_{n=1}^{\infty} \gamma_n$$

of S_n -invariant vectors $\gamma_n \in \mathfrak{s}^{2n-2} \text{Gra}(n)$.

The vector space

$$(8.8) \quad \mathfrak{s}^{2n-2} (\text{Gra}(n))^{S_n}$$

is spanned by vectors of the form

$$(8.9) \quad \text{Av}(\Gamma) = \sum_{\sigma \in S_n} \sigma(\Gamma)$$

where Γ is an element in \mathbf{gra}_n . In other words, formula (8.9) defines a surjective \mathbb{K} -linear map

$$(8.10) \quad \text{Av} : \mathbb{K}\langle \mathbf{gra}_n \rangle \rightarrow \mathfrak{s}^{2n-2}(\text{Gra}(n))^{S_n}.$$

To describe the kernel of the map Av , we observe that $\text{Av}(\Gamma) = 0$ if and only if the underlying unlabeled graph has an automorphism which induces an odd permutation on the set of edges. In this case we say that the element $\Gamma \in \mathbf{gra}_n$ is *odd*. Otherwise, we say that the element $\Gamma \in \mathbf{gra}_n$ is *even*. For example, the square depicted on figure 31 is odd and the pentagon depicted on figure 32 is even. It is obvious that the property of being even or odd depends only on the isomorphism class of the underlying unlabeled graph.

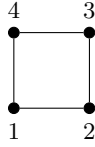

FIG. 31. We choose this order on the set of edges: $(1, 2) < (2, 3) < (3, 4) < (4, 1)$

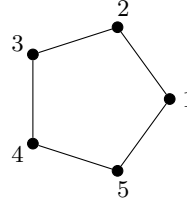

FIG. 32. We choose this order on the set of edges: $(1, 2) < (2, 3) < (3, 4) < (4, 5) < (5, 1)$

Let us consider a pair of even elements $\Gamma, \Gamma' \in \mathbf{gra}_n$ whose underlying unlabeled graphs are isomorphic. Any isomorphism of the underlying unlabeled graphs gives us a bijection from the set $E(\Gamma)$ of edges of Γ to the set $E(\Gamma')$ of edges of Γ' . Since both sets $E(\Gamma)$ and $E(\Gamma')$ are totally ordered, this bijection determines a permutation $\sigma \in S_m$ where $m = |E(\Gamma)|$. Furthermore, since Γ and Γ' are even, such permutations σ are either all even or all odd. In the later case, we say that even elements Γ and Γ' are *opposite* and the former case we say that even elements Γ and Γ' are *concordant*.

It is clear that

PROPOSITION 8.2. *The kernel of the map Av (8.10) is spanned by vectors of the form*

$$(8.11) \quad \Gamma, \quad \Gamma_1 - \Gamma_2, \quad \Gamma'_1 + \Gamma'_2,$$

where Γ is odd, (Γ_1, Γ_2) is a pair of concordant (even) graphs, and (Γ'_1, Γ'_2) is a pair of opposite (even) graphs. \square

In view of Proposition 8.2, we may identify the vector space (8.8) with the quotient of $\mathbb{K}\langle \mathbf{gra}_n \rangle$ by the subspace spanned by vectors (8.11).

The following proposition gives us a convenient description of the differential (8.5) on fGC:

PROPOSITION 8.3. For every (even) element $\Gamma \in \mathbf{gra}_n$ we have

$$(8.12) \quad \partial(\text{Av}(\Gamma)) = \text{Av}(\Gamma_{\bullet\bullet} \circ_1 \Gamma) - (-1)^{e(\Gamma)} \frac{1}{2} \sum_{i=1}^n \text{Av}(\Gamma \circ_i \Gamma_{\bullet\bullet})$$

where $e(\Gamma)$ is the number of edges of Γ . Moreover, if Γ is a connected (even) graph in \mathbf{gra}_n with at least one edge, then

$$(8.13) \quad \partial(\text{Av}(\Gamma)) = -\frac{(-1)^{e(\Gamma)}}{2} \sum_{i=1}^n \text{Av}(\Gamma'_i)$$

where Γ'_i is obtained from $\Gamma \circ_i \Gamma_{\bullet\bullet}$ by discarding all graphs in which either vertex i or vertex $i+1$ has valency 1.

PROOF. It is straightforward to verify the first claim by unfolding the definition of the Lie bracket on $\text{Conv}(\Lambda^2 \mathbf{coCom}, \mathbf{Gra})$. The second claim follows from the observation that

$$\text{Av}(\Gamma_{\bullet\bullet} \circ_1 \Gamma) = \frac{(-1)^{e(\Gamma)}}{2} \sum_{i=1}^n \text{Av}(\tilde{\Gamma}_i)$$

where $\tilde{\Gamma}_i$ is obtained from the linear combination $\Gamma \circ_i \Gamma_{\bullet\bullet}$ by keeping only the graphs in which either vertex i or vertex $i+1$ has valency 1. \square

EXERCISE 8.4. Let Γ_{\bullet} be the graph in \mathbf{gra}_1 which consists of a single vertex. Show that

$$(8.14) \quad \partial\Gamma_{\bullet} = \Gamma_{\bullet\bullet}$$

Let Γ_{\circ} be the graph in \mathbf{gra}_1 with consists of a single loop. Show that

$$\partial\Gamma_{\circ} = 0.$$

Thus Γ_{\circ} represents a degree -1 (non-trivial) cocycle in \mathbf{fGC} .

8.1. The subcomplex of cables. Let us denote by \mathcal{K}_- the subspace of \mathbf{fGC} which is spanned by vectors

$$\text{Av}(\Gamma)$$

where Γ is either the single vertex graph Γ_{\bullet} or a graph Γ_l^- depicted on figure 33 for $l \geq 2$. For example, $\Gamma_2^- = \Gamma_{\bullet\bullet}$.

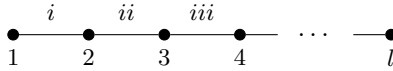

FIG. 33. The graph Γ_l^-

It is easy to see that the vectors $\text{Av}(\Gamma_l^-)$ have degrees

$$|\text{Av}(\Gamma_l^-)| = l - 1,$$

$$\text{Av}(\Gamma_l^-) = 0, \quad \text{if } l = 0, 3 \bmod 4,$$

and

$$\text{Av}(\Gamma_l^-) \neq 0, \quad \text{if } l = 1, 2 \bmod 4.$$

Furthermore, due to Exercise 8.6 below,

$$\partial\text{Av}(\Gamma_{4k+1}^-) = \text{Av}(\Gamma_{4k+2}^-)$$

for all $k \geq 1$.

Combining these observations with equation (8.14) we conclude that

PROPOSITION 8.5. *The subspace \mathcal{K}_- is subcomplex of fGC. Moreover \mathcal{K}_- is acyclic. \square*

We call \mathcal{K}_- the subcomplex of *cables*.

EXERCISE 8.6. Let Γ_l^- be the family of graphs for $l \geq 2$ defined on figure 33. Prove that for every $k \geq 1$

$$\partial \text{Av}(\Gamma_{4k+1}^-) = \text{Av}(\Gamma_{4k+2}^-).$$

8.2. The subcomplex of polygons. Let us denote by \mathcal{K}_\diamond the subspace of fGC which is spanned by vectors of the form

$$\text{Av}(\Gamma_m^\diamond),$$

where Γ_m^\diamond is the element of gra_m depicted on figure 34. For example, Γ_1^\diamond is the

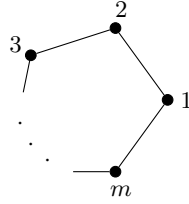

FIG. 34. The edges are ordered as follows $(1, 2) < (2, 3) < \dots < (m - 1, m) < (m, 1)$

graph Γ_\diamond in gra_1 which consists of a single loop.

Due to Exercise 8.7 below, \mathcal{K}_\diamond is a subcomplex of fGC with

$$(8.15) \quad H^\bullet(\mathcal{K}_\diamond) \cong \bigoplus_{q \geq 1} \mathfrak{s}^{4q-1} \mathbb{K}.$$

We call \mathcal{K}_\diamond the subcomplex of polygons.

EXERCISE 8.7. Show that the graph Γ_m^\diamond is odd if $m \not\equiv 1 \pmod 4$ and even if $m \equiv 1 \pmod 4$. Using equation (8.13), prove that for every $q \geq 0$

$$\text{Av}(\Gamma_{4q+1}^\diamond)$$

is a non-trivial cocycle of fGC of degree $4q - 1$.

8.3. The connected part fGC_{conn} of fGC. Let us denote by fGC_{conn} the subspace of fGC which consists of infinite sums

$$\gamma = \sum_{n=1}^{\infty} \gamma_n, \quad \gamma_n \in \mathfrak{s}^{2n-2}(\text{Gra}(n))^{S_n}$$

where γ_n is a linear combination of connected graphs in $\text{Gra}(n)$.

It is clear that fGC_{conn} is a Lie subalgebra of fGC and hence a subcomplex. It is also clear that

$$(8.16) \quad \text{fGC} = \mathfrak{s}^{-2} \widehat{S}(\mathfrak{s}^2 \text{fGC}_{\text{conn}}),$$

where \widehat{S} denotes the completed symmetric algebra. Thus the question of computing cohomology of \mathbf{fGC} reduces to the question of computing cohomology of its connected part $\mathbf{fGC}_{\text{conn}}$.

9. Analyzing the dg operad TwGra

According to the general procedure of twisting

$$(9.1) \quad \text{TwGra}(n) = \prod_{r=0}^{\infty} \mathbf{s}^{2r}(\text{Gra}(r+n))^{S_r}.$$

In other words, vectors in $\text{TwGra}(n)$ are infinite linear combinations

$$(9.2) \quad \gamma = \sum_{r=0}^{\infty} \gamma_r,$$

where γ_r is an S_r invariant vector in $\mathbf{s}^{2r}\text{Gra}(r+n)$.

It is clear that the first r vertices and the last n vertices in graphs of γ_r play different roles. We call the first r vertices *neutral* and the remaining n vertices *operational*. It is convenient to represent neutral (reps. operational) vertices on figures by small black circles (reps. small white circles). In this way, the same element of \mathbf{gra}_m may be treated as a vector in different spaces of the operad TwGra . For example, the graph on figure 35 represents a vector in $\text{TwGra}(0)$, the graph on figure 36 represents a vector in $\text{TwGra}(1)$, and the graph on figure 37 represents a vector in $\text{TwGra}(2)$.



FIG.
35. A
vector
in
 $\text{TwGra}(0)$



FIG.
36. A
vector
in
 $\text{TwGra}(1)$



FIG.
37. A
vector
in
 $\text{TwGra}(2)$

It is obvious that the vector space

$$\mathbf{s}^{2r}(\text{Gra}(r+n))^{S_r} \subset \text{TwGra}(n)$$

is spanned by vectors of the form

$$(9.3) \quad \text{Av}_r(\Gamma) = \sum_{\sigma \in S_r} \sigma(\Gamma),$$

where Γ is an element in \mathbf{gra}_{r+n} .

In other words, equation (9.3) defines a surjective map

$$(9.4) \quad \text{Av}_r : \mathbb{K}\langle \mathbf{gra}_{r+n} \rangle \twoheadrightarrow \mathbf{s}^{2r}(\text{Gra}(r+n))^{S_r}.$$

For an element $\Gamma \in \mathbf{gra}_{r+n}$ we denote by Γ^{oub} the partially labeled graph which is obtained from Γ by forgetting labels on neutral vertices and shifting labels on operational vertices down by r . Note that, since Γ^{oub} has unlabeled vertices, it may have non-trivial automorphisms.

It is obvious that $\text{Av}_r(\Gamma) = 0$ if and only if Γ^{oub} has an automorphism which induces an odd permutation on the set of edges. In this case, we say that an element $\Gamma \in \mathbf{gra}_{r+n}$ is *r-odd*. Otherwise, we say that Γ is *r-even*.

Let us consider two *r-even* elements $\Gamma, \Gamma' \in \mathbf{gra}_{r+n}$ whose underlying partially labeled graphs Γ^{oub} and $(\Gamma')^{\text{oub}}$ are isomorphic. Any isomorphism from Γ^{oub} to $(\Gamma')^{\text{oub}}$ gives us a bijection from the set $E(\Gamma)$ of edges of Γ to the set $E(\Gamma')$ of edges of Γ' . Since both sets $E(\Gamma)$ and $E(\Gamma')$ are totally ordered, this bijection determines a permutation $\sigma \in S_e$ where $e = |E(\Gamma)|$. Furthermore, since Γ and Γ' are *r-even*, such permutations σ are either all even or all odd. In the latter case, we say that *r-even* elements Γ and Γ' are *r-opposite* and in the former case we say that even elements Γ and Γ' are *r-concordant*.

It is clear that

PROPOSITION 9.1. *The kernel of the map Av_r (9.4) is spanned by vectors of the form*

$$(9.5) \quad \Gamma, \quad \Gamma_1 - \Gamma_2, \quad \Gamma'_1 + \Gamma'_2,$$

where Γ is *r-odd*, (Γ_1, Γ_2) is a pair of *r-concordant* (*r-even*) graphs, and (Γ'_1, Γ'_2) is a pair of *r-opposite* (*r-even*) graphs in \mathbf{gra}_{r+n} . \square

In the following proposition we give a convenient formula for the differential on TwGra .

PROPOSITION 9.2. *Let Γ be an *r-even* element in \mathbf{gra}_{r+n} . Then*

$$(9.6) \quad \partial^{\text{Tw}} \text{Av}_r(\Gamma) = \text{Av}_{r+1}(\Gamma_{\bullet\bullet} \circ_2 \Gamma) - (-1)^{e(\Gamma)} \text{Av}_{r+1} \left(\sum_{i=1}^n \varsigma_{r+1, r+i}(\Gamma \circ_{r+i} \Gamma_{\bullet\bullet}) \right) \\ - \frac{(-1)^{e(\Gamma)}}{2} \sum_{i=1}^r \text{Av}_{r+1}(\Gamma \circ_i \Gamma_{\bullet\bullet}),$$

where $e(\Gamma)$ is the number of edges of Γ , $\Gamma_{\bullet\bullet}$ is defined in (7.3), and $\varsigma_{r+1, r+i}$ is the cycle $(r+1, r+2, \dots, r+i) \in S_{r+1+n}$.

REMARK 9.3. We should remark that the vector $\partial^{\text{Tw}} \text{Av}_r(\Gamma)$ is a linear combination of graphs in \mathbf{gra}_{r+1+n} in which the first $r+1$ vertices are treated as neutral. Thus vertices with labels $r+1$ and $r+i+1$ in graphs in $\varsigma_{r+1, r+i}(\Gamma \circ_{r+i} \Gamma_{\bullet\bullet})$ come from $\Gamma_{\bullet\bullet}$. The vertex with label $r+1$ is treated as neutral and the vertex with label $r+i+1$ is treated as operational.

PROOF. Adapting general formula (6.32) to the case when $\mathcal{O} = \text{Gra}$ we get

$$(9.7) \quad \partial^{\text{Tw}} \text{Av}_r(\Gamma) = \sum_{\tau \in \text{Sh}_{1, r}} \tau(\Gamma_{\bullet\bullet} \circ_2 \text{Av}_r(\Gamma)) \\ - (-1)^{e(\Gamma)} \sum_{\tau' \in \text{Sh}_{r, 1}} \sum_{i=1}^n \tau' \circ \varsigma_{r+1, r+i}(\text{Av}_r(\Gamma) \circ_{r+i} \Gamma_{\bullet\bullet}) \\ - (-1)^{e(\Gamma)} \sum_{\lambda \in \text{Sh}_{2, r-1}} (\text{Av}_r(\Gamma) \circ_1 \Gamma_{\bullet\bullet}).$$

Using the obvious identity

$$\text{Av}_r(\Gamma) = \sum_{i=1}^r \sum_{\sigma' \in S_{2, \dots, r}} \sigma' \circ \varsigma_{1,i}(\Gamma),$$

axioms of operad, and S_2 -invariance of $\Gamma_{\bullet\bullet}$ we rewrite the last sum in (9.7) as follows

$$\begin{aligned} \sum_{\lambda \in \text{Sh}_{2, r-1}} \lambda(\text{Av}_r(\Gamma) \circ_1 \Gamma_{\bullet\bullet}) &= \sum_{i=1}^r \sum_{\sigma \in S_{r+1}}^{\sigma(i) < \sigma(i+1)} \sigma(\Gamma \circ_i \Gamma_{\bullet\bullet}) = \\ &= \frac{1}{2} \sum_{\sigma \in S_{r+1}} \sum_{i=1}^r \sigma(\Gamma \circ_i \Gamma_{\bullet\bullet}) = \frac{1}{2} \text{Av}_{r+1} \left(\sum_{i=1}^r \Gamma \circ_i \Gamma_{\bullet\bullet} \right). \end{aligned}$$

The first sum in the right hand side of (9.7) can be rewritten as

$$\begin{aligned} \sum_{\tau \in \text{Sh}_{1, r}} \tau(\Gamma_{\bullet\bullet} \circ_2 \text{Av}_r(\Gamma)) &= \sum_{\tau \in \text{Sh}_{1, r}} \sum_{\sigma' \in S_{2, \dots, r+1}} \tau \circ \sigma'(\Gamma_{\bullet\bullet} \circ_2 \Gamma) = \\ &= \sum_{\sigma \in S_{r+1}} (\Gamma_{\bullet\bullet} \circ_2 \Gamma) = \text{Av}_{r+1}(\Gamma_{\bullet\bullet} \circ_2 \Gamma), \end{aligned}$$

where $S_{2, \dots, r+1}$ denotes the permutation group of the set $\{2, \dots, r+1\}$.

As for the second sum in the right hand side of (9.7), we have

$$\begin{aligned} \sum_{\tau' \in \text{Sh}_{r, 1}} \sum_{i=1}^n \tau' \circ \varsigma_{r+1, r+i}(\text{Av}_r(\Gamma) \circ_{r+i} \Gamma_{\bullet\bullet}) &= \sum_{\tau' \in \text{Sh}_{r, 1}} \sum_{i=1}^n \sum_{\sigma' \in S_r} \tau' \circ \varsigma_{r+1, r+i} \circ \sigma'(\Gamma \circ_{r+i} \Gamma_{\bullet\bullet}) = \\ &= \sum_{i=1}^n \sum_{\sigma \in S_{r+1}} \sigma \circ \varsigma_{r+1, r+i}(\Gamma \circ_{r+i} \Gamma_{\bullet\bullet}) = \text{Av}_{r+1} \left(\sum_{i=1}^n \varsigma_{r+1, r+i}(\Gamma \circ_{r+i} \Gamma_{\bullet\bullet}) \right). \end{aligned}$$

Thus, equation (9.6) indeed holds. \square

9.1. The Euler characteristic trick. Let us consider sums (9.2) satisfying

PROPERTY 9.4. For every $r \geq 0$, each graph in the linear combination γ_r has Euler characteristic χ .

Using equation (9.6), it is not hard to see that the subspace of such sums is a subcomplex in $\text{TwGra}(n)$. We denote this subcomplex by

$$(9.8) \quad \text{TwGra}_\chi(n).$$

We claim that

PROPOSITION 9.5. *For every triple of integers $n \geq 0, m$ and χ the subspace $\text{TwGra}_\chi(n)^m$ of degree m vectors in $\text{TwGra}_\chi(n)$ is spanned by graphs with*

$$(9.9) \quad e = 2(n - \chi) + m$$

edges and

$$(9.10) \quad r = n + m - \chi$$

neutral vertices. In particular, the subspace $\text{TwGra}_\chi(n)^m$ is finite dimensional.

PROOF. Recall that for every graph $\Gamma \in \mathbf{gra}_{r+n}$ the vector $\text{Av}_r(\Gamma) \in \text{TwGra}(n)$ has degree

$$|\text{Av}_r(\Gamma)| = 2r - e,$$

where e is the number of edges of Γ .

Hence, if $\text{Av}_r(\Gamma) \in \text{TwGra}_\chi(n)^m$ then

$$(9.11) \quad m = 2r - e,$$

and

$$(9.12) \quad \chi = n + r - e.$$

Subtracting (9.11) from (9.12), we get

$$\chi - m = n - r.$$

Therefore,

$$r = n + m - \chi$$

and

$$e = 2n - 2\chi + m.$$

Thus the proposition follows from the fact that the number of graphs with a fixed number of vertices and a fixed number of edges is finite. \square

Proposition 9.5 has the following useful corollary.

COROLLARY 9.6. *The cochain complex $\text{TwGra}(n)$ decomposes into the product of sub-complexes*

$$(9.13) \quad \text{TwGra}(n) = \prod_{\chi \in \mathbb{Z}} \text{TwGra}_\chi(n).$$

PROOF. Let

$$\gamma = \sum_{r=1}^{\infty} \gamma_r, \quad \gamma_r \in \mathbf{s}^{2r}(\text{Gra}(r+n))^{S_r}$$

be a vector of degree m .

Equations (9.11) and (9.12) imply that for every r

$$\gamma_r \in \text{TwGra}_\chi(n)$$

where

$$\chi = n + m - r.$$

Thus

$$\text{TwGra}(n) \subset \prod_{\chi \in \mathbb{Z}} \text{TwGra}_\chi(n).$$

The inclusion

$$\prod_{\chi \in \mathbb{Z}} \text{TwGra}_\chi(n) \subset \text{TwGra}(n)$$

is proved in a similar way. \square

REMARK 9.7. We will often need to prove that any cocycle in $\text{TwGra}(n)$ or a similar cochain complex is cohomologous to a cocycle satisfying a certain property. Proposition 9.5 and Corollary 9.6 (or its corresponding versions) will allow us to reduce such questions to the corresponding questions for finite sums of graphs. We will refer to this maneuver as *the Euler characteristic trick*.

9.2. The suboperads $\mathbf{Graphs}^\sharp \subset \mathbf{fGraphs}^\sharp \subset \mathbf{TwGra}$. Let us denote by $\mathbf{fGraphs}^\sharp(n)$ the subspace of $\mathbf{TwGra}(n)$ which consists of linear combinations (9.2) satisfying

PROPERTY 9.8. If a connected component of a graph in γ_r for some $r > 0$ has no operational vertices then this connected component has at least one vertex of valency ≥ 3 .

REMARK 9.9. It is not hard to see that, if all vertices of a connected graph Γ have valencies ≤ 2 then Γ is isomorphic to one of the graphs in the list: Γ_\bullet , Γ_l^- (see figure 33), or Γ_m° (see figure 34). In other words, $\mathbf{fGraphs}^\sharp(n)$ is obtained from $\mathbf{TwGra}(n)$ by “throwing away” graphs which have connected components Γ_\bullet , Γ_l^- (see figure 33), or Γ_m° (see figure 34) with all neutral vertices.

Let us also denote by $\mathbf{Graphs}^\sharp(n)$ the subspace of $\mathbf{TwGra}(n)$ which consists of linear combinations (9.2) whose neutral vertices all have valencies ≥ 3 .

We claim that

PROPOSITION 9.10. *Both $\mathbf{Graphs}^\sharp(n)$ and $\mathbf{fGraphs}^\sharp(n)$ are subcomplexes of $\mathbf{TwGra}(n)$*

$$(9.14) \quad \mathbf{Graphs}^\sharp(n) \subset \mathbf{fGraphs}^\sharp(n) \subset \mathbf{TwGra}(n).$$

Moreover, the collections

$$\{\mathbf{Graphs}^\sharp(n)\}_{n \geq 0}, \quad \{\mathbf{fGraphs}^\sharp(n)\}_{n \geq 0}$$

are suboperads of \mathbf{TwGra} .

PROOF. The only non-obvious statement in this proposition is that the subspace $\mathbf{Graphs}^\sharp(n)$ is closed with respect to the differential $\partial^{\mathbf{Tw}}$.

So let us denote by Γ an r -even graph in \mathbf{gra}_{r+n} whose neutral vertices all have valencies ≥ 3 and analyze the right hand side of (9.6).

All graphs in the first linear combination in the right hand side of (9.6) have a univalent neutral vertex. However, it is not hard to see that they cancel with the corresponding terms in the second and the third linear combinations in the right hand side of (9.6).

Graphs with bivalent neutral vertices come from both the second and third linear combinations of the right hand side of (9.6). Again, it is not hard to see that these contributions cancel each other.

The proposition is proved. \square

The goal of this subsection is to prove that

PROPOSITION 9.11. *The embedding*

$$(9.15) \quad \mathbf{emb}_1^\sharp : \mathbf{Graphs}^\sharp(n) \hookrightarrow \mathbf{fGraphs}^\sharp(n)$$

is a quasi-isomorphism.

PROOF. Let us denote by $\mathbf{graphs}^\sharp(n)$ (resp. $\mathbf{fgraphs}^\sharp(n)$) the subcomplex of $\mathbf{Graphs}^\sharp(n)$ (resp. $\mathbf{fGraphs}^\sharp(n)$) which consists of **finite** linear combinations (9.2) in $\mathbf{Graphs}^\sharp(n)$ (resp. $\mathbf{fGraphs}^\sharp(n)$). In other words,

$$(9.16) \quad \mathbf{graphs}^\sharp(n) := \mathbf{Graphs}^\sharp(n) \cap \mathbf{Tw}^\oplus \mathbf{Gra}, \quad \mathbf{fgraphs}^\sharp(n) := \mathbf{fGraphs}^\sharp(n) \cap \mathbf{Tw}^\oplus \mathbf{Gra}.$$

Next we observe that the cochain complexes $\mathbf{Graphs}^\sharp(n)$ and $\mathbf{fGraphs}^\sharp(n)$ admit decompositions with respect to the Euler characteristic

$$\mathbf{Graphs}^\sharp(n) = \prod_{\chi \in \mathbb{Z}} \mathbf{Graphs}^\sharp(n) \cap \mathbf{TwGra}_\chi(n), \quad \mathbf{fGraphs}^\sharp(n) = \prod_{\chi \in \mathbb{Z}} \mathbf{fGraphs}^\sharp(n) \cap \mathbf{TwGra}_\chi(n)$$

and Proposition 9.5 implies that the subspace of elements of fixed degree in $\mathbf{Graphs}^\sharp(n) \cap \mathbf{TwGra}_\chi(n)$ and in $\mathbf{fGraphs}^\sharp(n) \cap \mathbf{TwGra}_\chi(n)$ is spanned by a finite number of graphs.

Thus, in virtue of Remark 9.7, it suffices to prove that the embedding

$$(9.17) \quad \mathbf{graphs}^\sharp(n) \hookrightarrow \mathbf{fgraphs}^\sharp(n)$$

is a quasi-isomorphism.

Let Γ be an element in \mathbf{gra}_{r+n} such that $\mathbf{Av}_r(\Gamma)$ represents a vector in $\mathbf{fgraphs}^\sharp(n)$. Let us denote by $\nu_2(\Gamma)$ the number of neutral vertices having valency 2.

It is clear that the linear combination

$$\partial^{\mathbf{Tw}} \mathbf{Av}(\Gamma)$$

may involve only graphs Γ' with $\nu_2(\Gamma') = \nu_2(\Gamma)$ or $\nu_2(\Gamma') = \nu_2(\Gamma) + 1$.

Thus we may introduce on the complex $\mathbf{fgraphs}^\sharp(n)$ an ascending filtration

$$(9.18) \quad \dots \subset \mathcal{F}^{m-1} \mathbf{fgraphs}^\sharp(n) \subset \mathcal{F}^m \mathbf{fgraphs}^\sharp(n) \subset \mathcal{F}^{m+1} \mathbf{fgraphs}^\sharp(n) \subset \dots$$

where $\mathcal{F}^m \mathbf{fgraphs}^\sharp(n)$ consists of vectors $\gamma \in \mathbf{fgraphs}^\sharp(n)$ which only involve graphs Γ satisfying the inequality

$$\nu_2(\Gamma) - |\gamma| \leq m.$$

It is clear that

$$\mathcal{F}^m \mathbf{fgraphs}^\sharp(n)$$

does not have non-zero vectors in degree $< -m$. Therefore, the filtration (9.18) is locally bounded from the left. Furthermore, since $\mathbf{fgraphs}^\sharp(n)$ consists of finite sums of graphs,

$$\mathbf{fgraphs}^\sharp(n) = \bigcup_m \mathcal{F}^m \mathbf{fgraphs}^\sharp(n).$$

In other words, the filtration (9.18) is cocomplete.

It is also clear that the differential $\partial^{\mathbf{Gr}}$ on the associated graded complex

$$(9.19) \quad \mathbf{Gr}(\mathbf{fgraphs}^\sharp(n)) = \bigoplus_m \mathcal{F}^m \mathbf{fgraphs}^\sharp(n) / \mathcal{F}^{m-1} \mathbf{fgraphs}^\sharp(n).$$

is obtained from $\partial^{\mathbf{Tw}}$ by keeping only the terms which raise the number of the bivalent neutral vertices.

Thus, since $\mathbf{graphs}^\sharp(n)$ is a subcomplex of $\mathbf{fgraphs}^\sharp(n)$, we conclude that

$$\mathbf{graphs}^\sharp(n)^k \subset \mathcal{F}^{-k} \mathbf{fgraphs}^\sharp(n)^k \cap \ker \partial^{\mathbf{Gr}},$$

where $\mathbf{graphs}^\sharp(n)^k$ (resp. $\mathcal{F}^{-k} \mathbf{fgraphs}^\sharp(n)^k$) denotes the subspace of degree k vectors in $\mathbf{graphs}^\sharp(n)$ (resp. in $\mathcal{F}^{-k} \mathbf{fgraphs}^\sharp(n)$).

To complete the proof of the proposition, we need the following technical lemma which is proved in Subsection 9.2.2 below.

LEMMA 9.12. *For the filtration (9.18) on $\mathbf{fgraphs}^\sharp(n)$ we have*

$$(9.20) \quad H^k \left(\mathcal{F}^m \mathbf{fgraphs}^\sharp(n) / \mathcal{F}^{m-1} \mathbf{fgraphs}^\sharp(n) \right) = 0$$

for all $m > -k$. Moreover,

$$(9.21) \quad \mathbf{graphs}^\sharp(n)^k = \mathcal{F}^{-k} \mathbf{fgraphs}^\sharp(n)^k \cap \ker \partial^{\mathrm{Gr}}.$$

It is easy to see that the restriction of (9.18) to the subcomplex $\mathbf{graphs}^\sharp(n)$ gives us the “silly” filtration:

$$(9.22) \quad \mathcal{F}^m \mathbf{graphs}^\sharp(n)^k = \begin{cases} \mathbf{graphs}^\sharp(n)^k & \text{if } m \geq -k, \\ \mathbf{0} & \text{otherwise.} \end{cases}$$

The associated graded complex $\mathrm{Gr}(\mathbf{graphs}^\sharp(n))$ for this filtration has the zero differential.

Since

$$\mathcal{F}^m \mathbf{fgraphs}^\sharp(n)^k = \mathbf{0} \quad \forall m < -k,$$

we have

$$\mathcal{F}^{-k} \mathbf{fgraphs}^\sharp(n)^k \cap \ker \partial^{\mathrm{Gr}} = H^k(\mathcal{F}^{-k} \mathbf{fgraphs}^\sharp(n) / \mathcal{F}^{-k-1} \mathbf{fgraphs}^\sharp(n)).$$

Thus, Lemma 9.12 implies that, the embedding (9.17) induces a quasi-isomorphism of cochain complexes

$$\mathrm{Gr}(\mathbf{graphs}^\sharp(n)) \xrightarrow{\sim} \mathrm{Gr}(\mathbf{fgraphs}^\sharp(n)).$$

On the other hand, both filtrations (9.18) and (9.22) are locally bounded from the left and cocomplete.

Therefore the embedding (9.17) satisfies all the conditions of Lemma A.3 from Appendix A and Proposition 9.11 follows. \square

9.2.1. *An alternative description of $\mathrm{Gr}(\mathbf{fgraphs}^\sharp(n))$.* In order to prove Lemma 9.12 we need a convenient description of the associated graded complex (9.19).

For this purpose we introduce three cochain complexes:

- The first cochain complex is the tensor algebra

$$(9.23) \quad T_a = T(\mathbb{K}\langle a \rangle)$$

in a single variable a carrying degree 1 with the differential δ defined by the formula

$$(9.24) \quad \delta(a) = a^2.$$

- The second cochain complex is the truncation of the above tensor algebra

$$(9.25) \quad \underline{T}_a = \underline{T}(\mathbb{K}\langle a \rangle) = \mathbb{K}\langle a \rangle \oplus \mathbb{K}\langle a \otimes a \rangle \oplus \mathbb{K}\langle a \otimes a \otimes a \rangle \oplus \dots$$

with the same differential (9.24).

- Finally, the third cochain complex

$$(9.26) \quad L = \mathbb{K}\langle \{\mathfrak{l}_n\}_{n>0, n=0,1 \bmod 4} \rangle$$

has the basis vector $\{\mathfrak{l}_n\}_{n>0, n=0,1 \bmod 4}$ carrying degrees

$$|\mathfrak{l}_n| = n - 2.$$

The differential on (9.26) is given by the formulas:

$$(9.27) \quad \delta(\mathfrak{l}_{4k}) = -\mathfrak{l}_{4k+1}, \quad \delta(\mathfrak{l}_{4k+1}) = 0.$$

It is easy to see that the cochain complex $(\underline{T}_a, \delta)$ is acyclic,

$$(9.28) \quad H^\bullet(T_a) = \begin{cases} \mathbb{K} & \text{if } \bullet = 0, \\ \mathbf{0} & \text{otherwise,} \end{cases}$$

and

$$(9.29) \quad H^\bullet(L) = \begin{cases} \mathbb{K} & \text{if } \bullet = -1, \\ \mathbf{0} & \text{otherwise.} \end{cases}$$

Moreover $H^0(T_a, \delta)$ is spanned by the class of 1 and $H^{-1}(L)$ is spanned by the cohomology class of \mathbf{l}_1 .

Next, to every pair of non-negative integers r, n satisfying $r + n > 0$ we assign an auxiliary groupoid $\text{Frame}_{r,n}$. An object of this groupoid is a labeled directed graph \mathfrak{J} with $r + n$ vertices and with an additional piece of data: the set $E(\mathfrak{J})$ of edges of \mathfrak{J} is equipped with a total order. For our purposes, we call the first r vertices neutral and the last n vertices operational. (On figures we use small black circles (resp. small white circles) for neural (resp. operational) vertices.) Each object $\mathfrak{J} \in \text{Frame}_{r,n}$ obeys the following properties:

- \mathfrak{J} does not have bivalent neutral vertices;
- \mathfrak{J} does not have a connected component which consists of a single neutral vertex;
- \mathfrak{J} does not have a connected component which consists of a single edge which connects two neutral vertices;
- each edge adjacent to a univalent neutral vertex (if any) of \mathfrak{J} originates at this univalent neutral vertex;
- the set $E(\mathfrak{J})$ is ordered in such a way that edges adjacent to univalent neutral vertices (if any) are smaller than all the remaining edges;
- finally, loops of \mathfrak{J} (if any) are bigger than all the remaining edges.

Objects of the groupoid $\text{Frame}_{r,n}$ are called *frames*.

A morphism from a frame \mathfrak{J} to a frame \mathfrak{J}' is an isomorphism of the underlying graphs which respects labels only on the operational vertices and respects neither labels on neutral vertices, nor the total order on the set of edges, nor the directions of edges.

EXAMPLE 9.13. Let \mathfrak{J} be the frame in $\text{Frame}_{3,4}$ depicted on figure 38. Let g_1 be the automorphism of \mathfrak{J} which swaps the first edge with the second edge and g_2 be the automorphism of \mathfrak{J} which swaps the fifth edge with the sixth edge. It is obvious that $\text{Aut}(\mathfrak{J})$ is generated by g_1 and g_2 . Moreover, $\text{Aut}(\mathfrak{J}) \cong S_2 \times S_2$.

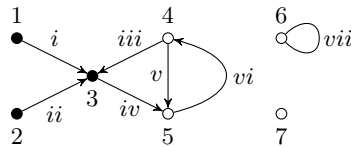

FIG. 38. As above, we use Roman numerals to specify the total order on the set of edges

The total number of edges e of any frame \mathfrak{J} splits into the sum

$$e = e_{\bullet} + e_{\circ} + e_{-},$$

where e_{\bullet} is the number of edges of \mathfrak{J} adjacent to univalent neutral vertices (if any), e_{\circ} is the number of loops of \mathfrak{J} and e_{-} is the number of the remaining edges. Thus, for the frame \mathfrak{J} on figure 38 we have $e_{\bullet} = 2$, $e_{\circ} = 1$, and $e_{-} = 4$.

For every frame $\mathfrak{J} \in \text{Frame}_{r,n}$ we construct a linear map

$$(9.30) \quad F_{\mathfrak{J}} : \mathbf{s}^{2r-2e_{\bullet}}(\underline{T}_a)^{\otimes e_{\bullet}} \otimes (\mathbf{s}^{-1}T_a)^{\otimes e_{-}} \otimes L^{\otimes e_{\circ}} \rightarrow \text{Gr}(\mathbf{fgraphs}^{\sharp}(n)).$$

Namely, given a collection of monomials $a^{k_1}, a^{k_2}, \dots, a^{k_{e_{\bullet}+e_{-}}}$ with $k_i > 0$ for all $i \leq k_{e_{\bullet}}$ and vectors $l_{k_{e_{\bullet}+e_{-}+1}}, \dots, l_{k_e}$ in L we form a graph $\Gamma \in \mathbf{gra}_{(r+r')_+n}$ with

$$r' = \sum_{i=1}^{e_{\bullet}} (k_i - 1) + \sum_{i=e_{\bullet}+1}^{e_{\bullet}+e_{-}} k_i + \sum_{i=e_{\bullet}+e_{-}+1}^e (k_i - 1)$$

following these steps:

- first, for each $1 \leq i \leq e_{\bullet}$, we divide the i -th edge into k_i sub-edges;
- second, for each $e_{\bullet} < i \leq e_{\bullet} + e_{-}$, we divide the i -th edge into $k_i + 1$ sub-edges;
- third, for each $e_{\bullet} + e_{-} < i \leq e$, we divide the i -th edge¹³ into k_i sub-edges;
- we declare that the additional r' vertices obtained in the above steps are neutral, label them by numbers $r + 1, r + 2, \dots, r + r'$ in an arbitrary possible way and shift labels on all operational vertices up by r' ;
- we order the set $E(\Gamma)$ of edges of Γ in the following way¹⁴: if $s_1, s_2 \in E(\Gamma)$ are parts of different edges of \mathfrak{J} then $s_1 < s_2$ provided s_1 is a part of a smaller edge; if $s_1, s_2 \in E(\Gamma)$ are parts of the same edge of \mathfrak{J} which is not a loop then $s_1 < s_2$ provided s_1 is closer to the origin of its edge; finally, we order sub-edges of each loop of \mathfrak{J} by choosing one of the two possible directions of walking around the loop.

We will refer to this graph Γ as the graph *reconstructed* from the monomial

$$(a^{k_1}, a^{k_2}, \dots, a^{k_{e_{\bullet}+e_{-}}}, l_{k_{e_{\bullet}+e_{-}+1}}, \dots, l_{k_e}) \in \mathbf{s}^{2r-2e_{\bullet}}(\underline{T}_a)^{\otimes e_{\bullet}} \otimes (\mathbf{s}^{-1}T_a)^{\otimes e_{-}} \otimes L^{\otimes e_{\circ}}$$

using the frame \mathfrak{J} .

It is not hard to see that the equation

$$(9.31) \quad F_{\mathfrak{J}}(a^{k_1}, a^{k_2}, \dots, a^{k_{e_{\bullet}+e_{-}}}, l_{k_{e_{\bullet}+e_{-}+1}}, \dots, l_{k_e}) = \sum_{\sigma \in S_{r+r'}} \sigma(\Gamma)$$

defines a (degree zero) map of graded vector spaces (9.30).

EXAMPLE 9.14. Let \mathfrak{J} be the frame in $\text{Frame}_{3,4}$ depicted on figure 38. Then

$$F_{\mathfrak{J}}(a, a^3, a, 1, 1, a, l_4) = \sum_{\sigma \in S_{10}} \sigma(\Gamma),$$

where Γ is the element in \mathbf{gra}_{10+4} depicted on figure 39.

¹³Note that, for each $e_{\bullet} + e_{-} < i \leq e$ the i -th edge is necessarily a loop.

¹⁴The order on the set $E(\Gamma)$ is defined up to an even permutation.

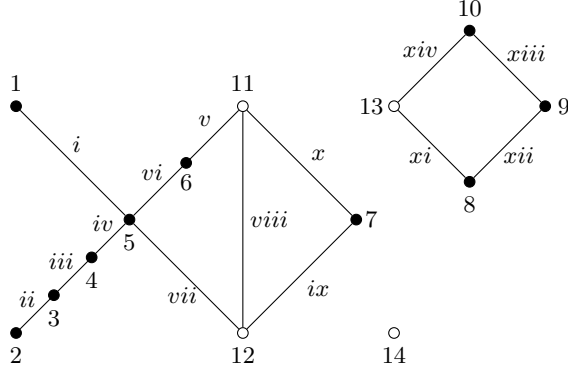

FIG. 39. The graph $\Gamma \in \mathbf{gra}_{10+4}$ corresponding to the vector $(a, a^3, a, 1, 1, a, \mathfrak{l}_4)$

Let us denote by ∂^{Gr} the differential on the associated graded complex $\text{Gr}(\mathbf{fgraphs}^\sharp(n))$. It is clear from the definition of the filtration (9.18) on $\mathbf{fgraphs}^\sharp(n)$ that ∂^{Gr} is obtained from ∂^{Tw} by keeping only the terms which raise the number of the bivalent neutral vertices. Hence the image of the map $F_{\mathfrak{I}}$ is closed with respect to the action the differential ∂^{Gr} . Furthermore, going through the steps of the definition of $F_{\mathfrak{I}}$, it is not hard to verify that

$$(9.32) \quad \partial^{\text{Gr}} \circ F_{\mathfrak{I}} = F_{\mathfrak{I}} \circ \delta.$$

Our next goal is to describe the kernel of the map $F_{\mathfrak{I}}$. For this purpose, we introduce the semi-direct product

$$(9.33) \quad S_e \ltimes (S_2)^e$$

of the groups S_e and $(S_2)^e$ with the multiplication rule:

$$(9.34) \quad (\tau; \sigma_1, \dots, \sigma_e) \cdot (\lambda; \sigma'_1, \dots, \sigma'_e) = (\tau\lambda; \sigma_{\lambda(1)}\sigma'_1, \dots, \sigma_{\lambda(e)}\sigma'_e).$$

Next we observe that the group $\text{Aut}(\mathfrak{I})$ admits an obvious homomorphism to the subgroup

$$(9.35) \quad (S_{e_\bullet} \times S_{e_-} \times S_{e_\circ}) \times (\{\text{id}\}^{e_\bullet} \times (S_2)^{e_-} \times \{\text{id}\}^{e_\circ})$$

of (9.33), where $\{\text{id}\}$ denotes the trivial group. Namely, this homomorphism assigns to an element $g \in \text{Aut}(\mathfrak{I})$ the string

$$(\tau; \sigma_1, \dots, \sigma_e), \quad \tau \in S_e, \sigma_1, \dots, \sigma_e \in S_2$$

in (9.33) according to this rule: $\tau(i) = j$ if the automorphism g sends the i -th edge to the j -th edge; σ_i is non-trivial (for $e_\bullet + 1 \leq i \leq e_\bullet + e_-$) if g sends the i -th edge to the j -th edge and the directions of these edges are opposite. It is clear that this homomorphism lands in the subgroup (9.35).

The group (9.35) acts on the graded vector space

$$(9.36) \quad \mathfrak{s}^{2r-2e_\bullet} (\underline{T}_a)^{\otimes e_\bullet} \otimes (\mathfrak{s}^{-1} T_a)^{\otimes e_-} \otimes L^{\otimes e_\circ}.$$

Namely, if σ is the non-trivial element of S_2 and $e_\bullet < i \leq e_\bullet + e_-$ then

$$(1, \dots, 1, \underbrace{\sigma}_{i\text{-th spot}}, 1, \dots, 1)(a^{k_1}, a^{k_2}, \dots, a^{k_{e_\bullet+e_-}}, \mathfrak{l}_{k_{e_\bullet+e_-+1}}, \dots, \mathfrak{l}_{k_e}) =$$

$$(-1)^{\frac{k_i(k_i+1)}{2}}(a^{k_1}, a^{k_2}, \dots, a^{k_{e_\bullet+e_-}}, \mathfrak{l}_{k_{e_\bullet+e_-+1}}, \dots, \mathfrak{l}_{k_e}).$$

Furthermore, for every $\tau \in S_{e_\bullet} \times S_{e_-} \times S_{e_\circ}$ we set

$$\begin{aligned} & \tau(a^{k_1}, a^{k_2}, \dots, a^{k_{e_\bullet+e_-}}, \mathfrak{l}_{k_{e_\bullet+e_-+1}}, \dots, \mathfrak{l}_{k_e}) = \\ & (-1)^{\varepsilon(\tau, k_1, \dots, k_e)}(a^{k_{\tau^{-1}(1)}}, a^{k_{\tau^{-1}(2)}}, \dots, a^{k_{\tau^{-1}(e_\bullet+e_-)}}, \mathfrak{l}_{k_{\tau^{-1}(e_\bullet+e_-+1)}}, \dots, \mathfrak{l}_{k_{\tau^{-1}(e)}}), \end{aligned}$$

where the sign factor $(-1)^{\varepsilon(\tau, k_1, \dots, k_e)}$ is determined by the usual Koszul rule.

Thus the graded vector space (9.36) is equipped with a left action of the group $\text{Aut}(\mathfrak{J})$.

EXAMPLE 9.15. Let us consider the frame \mathfrak{J} depicted on figure 38. Let g_1 be the generator of $\text{Aut}(\mathfrak{J})$ which swaps the first edge with the second edge and let g_2 be the generator of $\text{Aut}(\mathfrak{J})$ which swaps the fifth edge with the sixth edge. Then for the vector $(a, a^3, a, 1, 1, a, \mathfrak{l}_4)$ we have

$$(9.37) \quad g_1(a, a^3, a, 1, 1, a, \mathfrak{l}_4) = -(a^3, a, a, 1, 1, a, \mathfrak{l}_4),$$

and

$$(9.38) \quad g_2(a, a^3, a, 1, 1, a, \mathfrak{l}_4) = -(a, a^3, a, 1, a, 1, \mathfrak{l}_4).$$

The sign in (9.37) comes from the fact that a “jumps” over a^3 and the sign in (9.38) appears due to the fact that the fifth edge and the sixth edge carry opposite directions.

We can now describe the kernel of the map $F_{\mathfrak{J}}$ (9.30).

CLAIM 9.16. *Let $\mathfrak{J} \in \text{Frame}_{r,n}$ be a frame with e edges*

$$e = e_\bullet + e_- + e_\circ,$$

where e_\bullet is the number of edges of \mathfrak{J} adjacent to univalent neutral vertices, e_\circ is the number of loops and $e_- = e - e_\bullet - e_\circ$. Then the kernel of $F_{\mathfrak{J}}$ is spanned by vectors of the form

$$(9.39) \quad X - g(X),$$

where X is a vector in (9.36) and g is an automorphism of \mathfrak{J} in $\text{Frame}_{r,n}$.

PROOF. Let Y be a monomial in (9.36) such that

$$(9.40) \quad F_{\mathfrak{J}}(Y) = 0.$$

The latter means that the graph $\Gamma \in \text{gra}_{(r+r')+n}$ which is constructed from the monomial Y using the frame \mathfrak{J} is $(r+r')$ -odd.

In other words, there exists an automorphism \tilde{g} of Γ which respects labels only on operational vertices and induces an odd permutation on the set of edges of Γ .

It is clear that \tilde{g} induces an automorphism g of the frame \mathfrak{J} . Furthermore, since \tilde{g} induces an odd permutation on the set of edges of Γ we have

$$Y = -g(Y).$$

Hence,

$$(9.41) \quad Y = \frac{1}{2}(Y - g(Y)).$$

Thus every monomial Y in (9.36) satisfying equation (9.40) belongs to the span of vectors of the form (9.39).

Let us now consider a linear combination

$$(9.42) \quad c_1 Y_1 + c_2 Y_2 + \cdots + c_m Y_m, \quad c_i \in \mathbb{K}$$

of monomials Y_1, \dots, Y_m in (9.36) such that

$$(9.43) \quad \sum_i c_i F_{\mathfrak{J}}(Y_i) = 0.$$

Due to the above observation about monomials satisfying (9.40) we may assume, without loss of generality, that

$$F_{\mathfrak{J}}(Y_i) \neq 0 \quad \forall 1 \leq i \leq m.$$

We may also assume, without loss of generality, that the graphs $\{\Gamma_i\}_{1 \leq i \leq m}$ reconstructed from the monomial $\{Y_i\}_{1 \leq i \leq m}$ have the same number of neutral vertices $r + r'$.

Thus, for every $1 \leq i \leq m$, the graph $\Gamma_i \in \mathbf{gra}_{(r+r')_+n}$ is $(r + r')$ -even.

Combining this observation with Proposition 9.1 we conclude that the number m is even and the set of graphs $\{\Gamma_i\}_{1 \leq i \leq m}$ splits into pairs

$$(\Gamma_{i_t}, \Gamma_{i'_t}), \quad t \in \{1, \dots, m/2\}$$

such that for every t the graphs Γ_{i_t} and $\Gamma_{i'_t}$ are either $(r + r')$ -opposite or $(r + r')$ -concordant. For every pair $(\Gamma_{i_t}, \Gamma_{i'_t})$ of $(r + r')$ -opposite graphs we have

$$(9.44) \quad c_{i_t} = c_{i'_t}.$$

For every pair $(\Gamma_{i_t}, \Gamma_{i'_t})$ of $(r + r')$ -concordant graphs we have

$$(9.45) \quad c_{i_t} = -c_{i'_t}.$$

Let e_t denote the number of edges of Γ_{i_t} (or $\Gamma_{i'_t}$) and let \tilde{g}_t be the isomorphism from Γ_{i_t} to $\Gamma_{i'_t}$ which induces an odd or even permutation in S_{e_t} depending on whether Γ_{i_t} and $\Gamma_{i'_t}$ are $(r + r')$ -opposite or $(r + r')$ -concordant. Let g_t be the automorphism of the frame \mathfrak{J} which is induced by the isomorphism \tilde{g}_t .

Equations (9.44) and (9.45) imply that

$$\sum_{i=1}^m c_i Y_i = \sum_{t=1}^{m/2} c_{i_t} (Y_{i_t} - g_t(Y_{i_t})).$$

In other words, the linear combination (9.42) belongs to the span of vectors of the form (9.39) and the claim follows. \square

Now we are ready to give a convenient description of the associated graded complex $\mathrm{Gr}(\mathbf{fgraphs}^\sharp(n))$.

CLAIM 9.17. *Let us choose a representative \mathfrak{J}_z for every isomorphism class $z \in \pi_0(\mathbf{Frame}_{r,n})$. Let e_{\bullet}^z be the number of edges of \mathfrak{J}_z adjacent to univalent neutral vertices, e_{\circ}^z be the number of loops of \mathfrak{J}_z and*

$$e_{-}^z = |E(\mathfrak{J}_z)| - e_{\bullet}^z - e_{\circ}^z.$$

Then the cochain complex $\mathrm{Gr}(\mathbf{fgraphs}^\sharp(n))$ splits into the direct sum

$$(9.46) \quad \bigoplus_{r \geq 0} \bigoplus_{z \in \pi_0(\mathbf{Frame}_{r,n})} \mathbf{s}^{2r-2e_{\bullet}^z} \left((\mathcal{T}_a)^{\otimes e_{\bullet}^z} \otimes (\mathbf{s}^{-1} T_a)^{\otimes e_{-}^z} \otimes L^{\otimes e_{\circ}^z} \right)_{\mathrm{Aut}(\mathfrak{J}_z)}.$$

PROOF. Let us recall that the map $F_{\mathfrak{J}_z}$ (9.30) is a morphism from the cochain complex

$$\mathfrak{s}^{2r-2e_z} (\underline{T}_a)^{\otimes e_z} \otimes (\mathfrak{s}^{-1} T_a)^{\otimes e_z} \otimes L^{\otimes e_z}$$

with the differential δ to $\text{Gr}(\mathbf{fgraphs}^\sharp(n))$.

Thus, Claim 9.16 implies that $F_{\mathfrak{J}_z}$ induces an isomorphism from the cochain complex of coinvariants

$$\mathfrak{s}^{2r-2e_z} \left((\underline{T}_a)^{\otimes e_z} \otimes (\mathfrak{s}^{-1} T_a)^{\otimes e_z} \otimes L^{\otimes e_z} \right)_{\text{Aut}(\mathfrak{J}_z)}$$

to the subcomplex

$$\text{Im}(F_{\mathfrak{J}_z}) \subset \text{Gr}(\mathbf{fgraphs}^\sharp(n)).$$

On the other hand, the cochain complex $\text{Gr}(\mathbf{fgraphs}^\sharp(n))$ is obviously the direct sum

$$(9.47) \quad \text{Gr}(\mathbf{fgraphs}^\sharp(n)) = \bigoplus_{r \geq 0} \bigoplus_{z \in \pi_0(\text{Frame}_{r,n})} \text{Im}(F_{\mathfrak{J}_z}).$$

Thus, the desired statement follows. \square

9.2.2. *Proof of Lemma 9.12.* We will now use the above description of the cochain complex $\text{Gr}(\mathbf{fgraphs}^\sharp(n))$ to prove Lemma 9.12.

First, we observe that, since the cochain complex \underline{T}_a is acyclic, the direct summand

$$(9.48) \quad \text{Im}(F_{\mathfrak{J}})$$

of $\text{Gr}(\mathbf{fgraphs}^\sharp(n))$ is acyclic for every frame \mathfrak{J} with at least one univalent neutral vertex.

So let us consider a frame \mathfrak{J} with $e_\bullet = 0$.

It is easy to see that the cochain complex

$$(9.49) \quad \mathfrak{s}^{2r} \left((\mathfrak{s}^{-1} T_a)^{\otimes e_-} \otimes L^{\otimes e_o} \right)_{\text{Aut}(\mathfrak{J})}$$

is concentrated in degrees

$$\geq 2r - e_- - e_o.$$

Furthermore, using (9.28), (9.29), Künneth's theorem, and the fact that the cohomology functor commutes with taking coinvariants, we conclude that every cocycle X in (9.49) of degree $> 2r - e_- - e_o$ is trivial and the space

$$(9.50) \quad H^{2r-e_- - e_o} \left(\mathfrak{s}^{2r} \left((\mathfrak{s}^{-1} T_a)^{\otimes e_-} \otimes L^{\otimes e_o} \right)_{\text{Aut}(\mathfrak{J})} \right) = \mathbb{K}$$

is spanned by the class of the vector

$$(9.51) \quad \mathfrak{s}^{2r} (\mathfrak{s}^{-1} 1)^{\otimes e_-} \otimes (1_1)^{\otimes e_o}.$$

Since images of cocycles X in (9.49) of degrees $> 2r - e_- - e_o$ lie in

$$\left(\mathcal{F}^m \mathbf{fgraphs}^\sharp(n) / \mathcal{F}^{m-1} \mathbf{fgraphs}^\sharp(n) \right)^k$$

for $m > -k$ and images of the vectors (9.51) belong to $\mathbf{graphs}^\sharp(n)^{2r-e_- - e_o}$, Lemma 9.12 follows from Claim 9.17.

9.3. We are getting rid of loops. Let us denote by $\text{Graphs}_{\emptyset}^{\sharp}(n)$ the subspace of $\text{Graphs}^{\sharp}(n)$ which consists of vectors in $\text{Graphs}^{\sharp}(n)$ involving exclusively graphs without loops.

Since the differential ∂^{Tw} “does not create” loops, the subspace $\text{Graphs}_{\emptyset}^{\sharp}(n)$ is a subcomplex of $\text{Graphs}^{\sharp}(n)$ for every n . Moreover the collection

$$(9.52) \quad \text{Graphs}_{\emptyset}^{\sharp} = \{\text{Graphs}_{\emptyset}^{\sharp}(n)\}_{n \geq 0}$$

is obviously a suboperad Graphs^{\sharp} .

The goal of this section is to prove that

PROPOSITION 9.18. *The embedding*

$$(9.53) \quad \text{emb}_2^{\sharp} : \text{Graphs}_{\emptyset}^{\sharp} \hookrightarrow \text{Graphs}^{\sharp}$$

is a quasi-isomorphism (of dg operads).

PROOF. Let us introduce the subcomplex $\text{graphs}_{\emptyset}^{\sharp}(n)$ of $\text{Graphs}_{\emptyset}^{\sharp}(n)$ which consists of finite sums of graphs, i.e.

$$(9.54) \quad \text{graphs}_{\emptyset}^{\sharp}(n) := \text{Graphs}_{\emptyset}^{\sharp}(n) \cap \text{Tw}^{\oplus} \text{Gra}(n).$$

We will prove that the embedding

$$(9.55) \quad \text{graphs}_{\emptyset}^{\sharp}(n) \hookrightarrow \text{graphs}^{\sharp}(n)$$

is a quasi-isomorphism of cochain complexes. Then the desired statement can be easily deduced from this fact using the Euler characteristic trick (see Remark 9.7).

Let Γ be a r -even graph in gra_{r+n} whose first r vertices have valency ≥ 3 . Let us denote by $\text{tp}_r(\Gamma)$ the number of loops (if any) of Γ which are based on a trivalent vertex whose label $\leq r$. For example, the graph $\Gamma \in \text{gra}_{3+3}$ depicted on figure 40 has $\text{tp}_3(\Gamma) = 1$. Indeed, the vertex with label 1 supports a loop but it has valency 4; the vertex with label 2 does not support a loop; finally, the vertex with label 3 supports a loop and has valency 3.

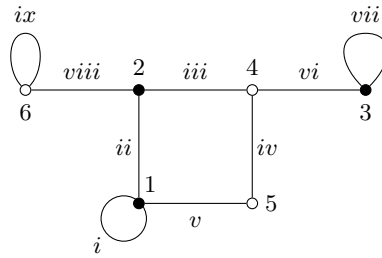

FIG. 40. It is the vertex with label 3 which contributes to $\text{tp}_3(\Gamma)$

It is obvious that the expression

$$\partial^{\text{Tw}}(\text{Av}_r(\Gamma))$$

involves graphs $\Gamma' \in \text{gra}_{(r+1)+n}$ with $\text{tp}_{r+1}(\Gamma') = \text{tp}_r(\Gamma)$ or $\text{tp}_{r+1}(\Gamma') = \text{tp}_r(\Gamma) + 1$.

Thus the cochain complex $\text{graphs}^{\sharp}(n)$ carries the following ascending filtration

$$(9.56) \quad \dots \subset \mathcal{F}^{m-1} \text{graphs}^{\sharp}(n) \subset \mathcal{F}^m \text{graphs}^{\sharp}(n) \subset \mathcal{F}^{m+1} \text{graphs}^{\sharp}(n) \subset \dots$$

where $\mathcal{F}^m \mathbf{graphs}^\sharp(n)$ is spanned by vectors in $\mathbf{graphs}^\sharp(n)$ of the form

$$\mathrm{Av}_r(\Gamma) \quad \Gamma \in \mathbf{gra}_{r+n}$$

with

$$\mathrm{tp}_r(\Gamma) - |\mathrm{Av}_r(\Gamma)| \leq m.$$

It is clear that the differential ∂^{tp} on the associated graded complex

$$(9.57) \quad \mathrm{Gr}(\mathbf{graphs}^\sharp(n)) = \bigoplus_m \mathcal{F}^m \mathbf{graphs}^\sharp(n) / \mathcal{F}^{m-1} \mathbf{graphs}^\sharp(n)$$

is obtained from ∂^{Tw} by keeping only terms which raise the number of loops based on trivalent neutral vertices.

It is also clear that the restriction of (9.56) to the subcomplex $\mathbf{graphs}_{\emptyset}^\sharp(n)$ gives us the “silly” filtration

$$(9.58) \quad \mathcal{F}^m \mathbf{graphs}_{\emptyset}^\sharp(n)^k = \begin{cases} \mathbf{graphs}_{\emptyset}^\sharp(n)^k & \text{if } m \geq -k, \\ \mathbf{0} & \text{otherwise} \end{cases}$$

with the associated graded complex $\mathrm{Gr}(\mathbf{graphs}_{\emptyset}^\sharp(n))$ carrying the zero differential.

It is not hard to see that the cochain complex $\mathrm{Gr}(\mathbf{graphs}^\sharp(n))$ splits into the direct sum of subcomplexes

$$(9.59) \quad \mathrm{Gr}(\mathbf{graphs}^\sharp(n)) \cong \mathrm{Gr}(\mathbf{graphs}_{\emptyset}^\sharp(n)) \oplus \mathbf{graphs}_{\circlearrowleft}^\sharp(n),$$

where $\mathbf{graphs}_{\circlearrowleft}^\sharp(n)$ is spanned by vectors in $\mathbf{graphs}^\sharp(n)$ of the form

$$\mathrm{Av}_r(\Gamma), \quad \Gamma \in \mathbf{gra}_{r+n}$$

with Γ having at least one loop.

Let Γ be graph in \mathbf{gra}_{r+n} for which $\mathrm{Av}_r(\Gamma) \in \mathbf{graphs}_{\circlearrowleft}^\sharp(n)$ and let $V_{\circlearrowleft}^r(\Gamma)$ denote the following subset of vertices of Γ

$$(9.60) \quad V_{\circlearrowleft}^r(\Gamma) = \{v \in V(\Gamma) \mid v \text{ carries label } \leq r, \text{ has valency } > 3, \text{ and supports a loop}\} \cup \{v \in V(\Gamma) \mid v \text{ carries label } > r \text{ and supports a loop}\}.$$

For example, if Γ is the graph depicted on figure 40 then $V_{\circlearrowleft}^3(\Gamma)$ consists of vertices labeled by 1 and 6.

Collecting terms in (9.6) which raise the number of loops based on trivalent neutral vertices we see that

$$(9.61) \quad \partial^{\mathrm{tp}}(\mathrm{Av}_r(\Gamma)) = \begin{cases} - \sum_{v \in V_{\circlearrowleft}(\Gamma)} \mathrm{Av}_{r+1}(\mathrm{Tp}_v(\Gamma)), & \text{if } V_{\circlearrowleft}(\Gamma) \text{ is non-empty} \\ 0 & \text{if } V_{\circlearrowleft}(\Gamma) = \emptyset, \end{cases}$$

where $\mathrm{Tp}_v(\Gamma)$ is a graph in $\mathbf{gra}_{(r+1)+n}$ obtained from Γ by

- shifting labels on all vertices of Γ up by 1;
- removing the loop based at the vertex v ;
- attaching to v the piece



- declaring that the loop based at first neutral vertex takes the spot of the removed loop in $E(\Gamma)$ and the edge connecting the first neutral vertex to v is the smallest in $E(\text{Tp}_v(\Gamma))$.

Let Γ be graph in gra_{r+n} for which $\text{Av}_r(\Gamma) \in \text{graphs}^\#_{\circlearrowleft}(n)$ and let $V_{\text{tp}}^r(\Gamma)$ denote the set of trivalent vertices (if any) which support loops and carry labels $\leq r$. We denote by h the linear map of degree -1

$$h : \text{graphs}^\#_{\circlearrowleft}(n) \rightarrow \text{graphs}^\#_{\circlearrowleft}(n)$$

defined by formula

$$(9.62) \quad h(\text{Av}_r(\Gamma)) := \begin{cases} - \sum_{v \in V_{\text{tp}}^r(\Gamma)} \text{Av}_{r-1}(\text{Tp}_v^*(\Gamma)), & \text{if } V_{\text{tp}}^r(\Gamma) \text{ is non-empty} \\ 0 & \text{if } V_{\text{tp}}^r(\Gamma) = \emptyset, \end{cases}$$

where $\text{Tp}_v^*(\Gamma)$ is a vector in $\text{Gra}(r-1+n)$ obtained from Γ by

- switching the label on v with the label 1 on the first vertex of Γ (provided v is not the first vertex);
- changing the order of the edges of Γ such that the single edge e_v connecting v to another vertex becomes the smallest one (this step may produce the sign factor (-1) in front of Γ);
- removing the edge e_v together with the vertex v and attaching the vacated loop to the other end of e_v ;
- shifting labels on all the remaining vertices down by 1.

For example, if Γ is the graph depicted on figure 40 then

$$(9.63) \quad h(\text{Av}_3(\Gamma)) = -\text{Av}_2(\Gamma'),$$

where Γ' is the vector in $\text{Gra}(5)$ depicted on figure 41.

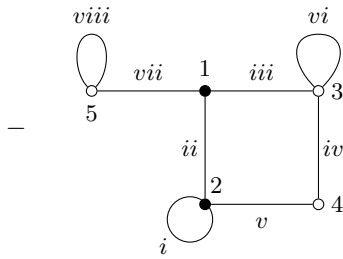

FIG. 41. The vector Γ' defining $h(\text{Av}_3(\Gamma))$

Figure 42 illustrates intermediate steps in the construction of Γ' .

Let Γ be a graph in gra_{r+n} such that $\text{Av}_r(\Gamma) \in \text{graphs}^\#_{\circlearrowleft}(n)$. Using the fact that Γ has no bivalent neutral vertices, it is not hard to show that the operations ∂^{tp} and h satisfy the identity

$$(9.64) \quad \partial^{\text{tp}} \circ h(\text{Av}_r(\Gamma)) + h \circ \partial^{\text{tp}}(\text{Av}_r(\Gamma)) = \lambda_\Gamma \text{Av}_r(\Gamma),$$

where λ_Γ is the number of loops of Γ .

Therefore, the cochain complex

$$(\text{graphs}^\#_{\circlearrowleft}(n), \partial^{\text{tp}})$$

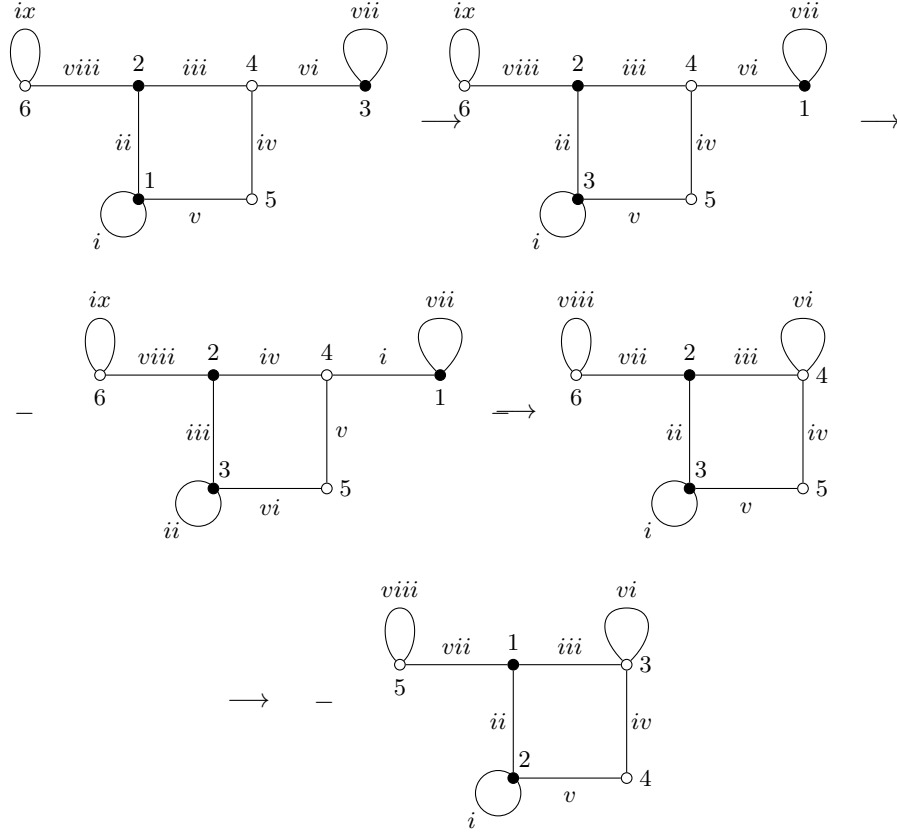

FIG. 42. Intermediate steps in the construction of Γ'

is acyclic and hence the embedding (9.55) induces a quasi-isomorphism of cochain complexes:

$$\text{Gr}(\text{graphs}_{\emptyset}^{\sharp}(n)) \xrightarrow{\sim} \text{Gr}(\text{graphs}^{\sharp}(n)).$$

On the other hand, both filtrations (9.56) and (9.58) are cocomplete and locally bounded from the left. Thus Lemma A.3 from Appendix A implies that the embedding (9.55) is a quasi-isomorphism. Hence so is the embedding

$$\text{Graphs}_{\emptyset}^{\sharp}(n) \hookrightarrow \text{Graphs}^{\sharp}(n).$$

Proposition 9.18 is proved. □

9.4. The suboperads $\text{Graphs}_{\emptyset} \subset \text{Graphs} \subset \text{fGraphs} \subset \text{TwGra}$. In this subsection we introduce yet another series of suboperads of TwGra

$$\text{Graphs}_{\emptyset} \subset \text{Graphs} \subset \text{fGraphs} \subset \text{TwGra}.$$

We will show that the embeddings

$$\text{Graphs}_{\emptyset} \hookrightarrow \text{Graphs},$$

$$\text{Graphs} \hookrightarrow \text{fGraphs}$$

are quasi-isomorphisms of dg operads.

We denote by $\mathbf{fGraphs}(n)$ the subspace of $\mathbf{TwGra}(n)$ which consists of linear combinations (9.2) satisfying

PROPERTY 9.19. For every r , each graph in the linear combination γ_r has no connected components which involve exclusively neutral vertices.

For example, it means that

$$\mathbf{fGraphs}(0) = \mathbf{0}.$$

We denote by $\mathbf{Graphs}(n)$ the subspace of $\mathbf{fGraphs}(n)$ which consists of sums of graphs with neutral vertices having valencies ≥ 3 .

Finally, $\mathbf{Graphs}_{\emptyset}(n)$ is the subspace of $\mathbf{Graphs}(n)$ which consists of sums of graphs without loops.

It is easy to see that for every n , $\mathbf{Graphs}_{\emptyset}(n)$, $\mathbf{Graphs}(n)$, and $\mathbf{fGraphs}(n)$ are subcomplexes of $\mathbf{TwGra}(n)$. Moreover, collections

$$(9.65) \quad \mathbf{fGraphs} = \{\mathbf{fGraphs}(n)\}_{n \geq 0},$$

$$(9.66) \quad \mathbf{Graphs} = \{\mathbf{Graphs}(n)\}_{n \geq 0},$$

and

$$(9.67) \quad \mathbf{Graphs}_{\emptyset} = \{\mathbf{Graphs}_{\emptyset}(n)\}_{n \geq 0}$$

are suboperads of \mathbf{TwGra} .

We claim that

PROPOSITION 9.20. *The embeddings*

$$(9.68) \quad \mathbf{emb}_1 : \mathbf{Graphs} \hookrightarrow \mathbf{fGraphs}$$

and

$$(9.69) \quad \mathbf{emb}_2 : \mathbf{Graphs}_{\emptyset} \hookrightarrow \mathbf{Graphs}$$

are quasi-isomorphisms of dg operads.

PROOF. It clear that the cone

$$\mathbf{Cone}(\mathbf{emb}_1) = \mathbf{Graphs} \oplus \mathbf{s fGraphs}$$

of the embedding (9.68) is a direct summand in the cone $\mathbf{Cone}(\mathbf{emb}_1^{\sharp})$ of

$$\mathbf{emb}_1^{\sharp} : \mathbf{Graphs}^{\sharp} \hookrightarrow \mathbf{fGraphs}^{\sharp}.$$

Thus the desired statement about the embedding \mathbf{emb}_1 follows from Proposition 9.11 above and Claim A.1 given in Appendix A.

Similarly the cone

$$\mathbf{Cone}(\mathbf{emb}_2) = \mathbf{Graphs}_{\emptyset} \oplus \mathbf{Graphs}$$

of the embedding (9.69) is a direct summand in the cone $\mathbf{Cone}(\mathbf{emb}_2^{\sharp})$ of

$$\mathbf{emb}_2^{\sharp} : \mathbf{Graphs}_{\emptyset}^{\sharp} \hookrightarrow \mathbf{Graphs}^{\sharp}.$$

Thus, using Proposition 9.18 above and Claim A.1 given in Appendix A, it is easy to prove that \mathbf{emb}_2 is a quasi-isomorphism. \square

9.5. The master diagram for the dg operad TwGra . Let \mathcal{O} be a (dg) operad which receives a morphism from ΛLie_∞ . Let us observe that we have the obvious embedding

$$(9.70) \quad \text{emb}_{\mathcal{O}} : \mathcal{O} \hookrightarrow \text{Tw}\mathcal{O}$$

$$\text{emb}_{\mathcal{O}}(v)(\mathbf{s}^{-2r} 1) = \begin{cases} v & \text{if } r = 0, \\ 0 & \text{otherwise,} \end{cases}$$

which is compatible with the operad structure but may not be compatible with the differentials.

We denote by $\Gamma_{\circ-\circ} \in \text{TwGra}(2)$ (resp. $\Gamma_{\circ\circ} \in \text{TwGra}(2)$) the images of $\Gamma_{\bullet-\bullet}$ and $\Gamma_{\bullet\bullet}$ with respect to the embedding

$$\text{emb}_{\text{Gra}} : \text{Gra} \rightarrow \text{TwGra}.$$

Namely,

$$(9.71) \quad \Gamma_{\circ-\circ} = \begin{array}{c} 1 \quad 2 \\ \circ - \circ \end{array},$$

and

$$(9.72) \quad \Gamma_{\circ\circ} = \begin{array}{c} 1 \quad 2 \\ \circ \quad \circ \end{array}.$$

Although emb_{Gra} is not compatible with the differential ∂^{Tw} , the vectors $\Gamma_{\circ-\circ}, \Gamma_{\circ\circ} \in \text{TwGra}(2)$ are ∂^{Tw} -closed (see Exercise 9.26 below).

Therefore, the composition of embeddings ι (7.5) and emb_{Gra}

$$(9.73) \quad \iota' = \text{emb}_{\text{Gra}} \circ \iota : \text{Ger} \hookrightarrow \text{TwGra}$$

is a morphism of dg operads. Furthermore, it is obvious that ι' lands in the suboperad $\text{Graphs}_{\emptyset}$.

It turns out that the map ι' satisfies the following remarkable property¹⁵:

THEOREM 9.21 (M. Kontsevich, [24], Section 3.3.4). *The embedding*

$$(9.74) \quad \iota' : \text{Ger} \hookrightarrow \text{Graphs}_{\emptyset}$$

induces an isomorphism

$$\text{Ger} \cong H^*(\text{Graphs}_{\emptyset}).$$

REMARK 9.22. It is obvious that the map (9.74) lands in the suboperad $\text{graphs}_{\emptyset} \subset \text{Graphs}_{\emptyset}$ with

$$\text{graphs}_{\emptyset}(n) = \text{Graphs}_{\emptyset}(n) \cap \text{Tw}^{\oplus} \text{Gra}(n).$$

The arguments given in [24, Section 3.3.4] or [26] allow us to prove that the embedding

$$\iota' : \text{Ger} \hookrightarrow \text{graphs}_{\emptyset}$$

is a quasi-isomorphism of dg operads. The desired statement about (9.74) can be easily deduced from this fact using the Euler characteristic trick.

We now assemble all the above results about suboperads of TwGra into the following theorem:

¹⁵For a more detailed proof of this fact we refer the reader to paper [26] by P. Lambrechts and I. Volic.

THEOREM 9.23. *The suboperads $\mathbf{fGraphs}^\sharp$, \mathbf{Graphs}^\sharp , $\mathbf{Graphs}_\emptyset^\sharp$, $\mathbf{fGraphs}$, \mathbf{Graphs} and $\mathbf{Graphs}_\emptyset$ of \mathbf{TwGra} introduced in Sections 9.2 and 9.4 fit into the following commutative diagram:*

$$(9.75) \quad \begin{array}{ccccccc} & & \mathbf{Graphs}_\emptyset^\sharp & \xrightarrow{\sim} & \mathbf{Graphs}^\sharp & \xrightarrow{\sim} & \mathbf{fGraphs}^\sharp & \hookrightarrow & \mathbf{TwGra} \\ & & \uparrow & & \uparrow & & \uparrow & & \\ \mathbf{Ger} & \xrightarrow{\sim} & \mathbf{Graphs}_\emptyset & \xrightarrow{\sim} & \mathbf{Graphs} & \xrightarrow{\sim} & \mathbf{fGraphs} & & \end{array}$$

Here the arrow \hookrightarrow denotes an embedding and the arrow $\xrightarrow{\sim}$ denotes an embedding which induces an isomorphism on the level of cohomology. \square

We refer to (9.75) as the master diagram for the dg operad \mathbf{TwGra} . Theorem 9.23 has the following obvious corollary

COROLLARY 9.24. *The embedding*

$$(9.76) \quad \iota' : \mathbf{Ger} \hookrightarrow \mathbf{fGraphs}$$

induces an isomorphism on the level of cohomology. \square

Let us observe that the map ι' lands in the suboperad $\mathbf{fgraphs} \subset \mathbf{fGraphs}$ for which

$$(9.77) \quad \mathbf{fgraphs}(n) := \mathbf{fGraphs}(n) \cap \mathbf{Tw}^\oplus \mathbf{Gra}(n).$$

Furthermore, using the Euler characteristic trick, it is not hard to deduce from Corollary 9.24 that

COROLLARY 9.25. *The embedding*

$$(9.78) \quad \iota' : \mathbf{Ger} \hookrightarrow \mathbf{fgraphs}$$

induces an isomorphism on the level of cohomology. \square

EXERCISE 9.26. Prove that the vectors $\Gamma_{\circ\circ}, \Gamma_{\circ\circ} \in \mathbf{TwGra}(2)$ defined in (9.71) and (9.72), respectively, satisfy the conditions

$$\partial^{\mathbf{Tw}} \Gamma_{\circ\circ} = \partial^{\mathbf{Tw}} \Gamma_{\circ\circ} = 0.$$

10. The full graph complex \mathbf{fGC} revisited

Let us recall that $\mathbf{Gra}(0) = \mathbf{0}$. Hence, due to Remark 6.9, we have a tautological isomorphism

$$(10.1) \quad \mathbf{fGC} \cong \mathbf{s}^{-2} \mathbf{TwGra}(0)$$

between the full graph complex \mathbf{fGC} (8.3) and the cochain complex $\mathbf{s}^{-2} \mathbf{TwGra}(0)$.

Here we will use the isomorphism (10.1) together with the results of Sections 9.2 and 9.3 to deduce various useful facts about the full graph complex \mathbf{fGC} .

Recall that vectors of \mathbf{fGC} are infinite sums

$$(10.2) \quad \gamma = \sum_{n=1}^{\infty} \gamma_n$$

of S_n -invariant vectors $\gamma_n \in \mathbf{s}^{2n-2} \mathbf{Gra}(n)$.

We denote by

$$(10.3) \quad \mathbf{fGC}_{\geq 3} \subset \mathbf{fGC}$$

the subspace of sums (10.2) satisfying

PROPERTY 10.1. For every n , each connected component of a graph in γ_n has at least one vertex of valency ≥ 3 .

We also denote by \mathbf{GC} the subspace of sums (9.2) which involve exclusively graphs whose vertices all have valencies ≥ 3 . It is obvious that $\mathbf{GC} \subset \mathbf{fGC}_{\geq 3}$.

Comparing $\mathbf{fGC}_{\geq 3}$ and \mathbf{GC} with the suboperads $\mathbf{fGraphs}^\sharp$ and \mathbf{Graphs}^\sharp from Section 9.2 we see that

$$(10.4) \quad \mathbf{fGC}_{\geq 3} \cong \mathbf{s}^{-2}\mathbf{fGraphs}^\sharp(0), \quad \mathbf{GC} \cong \mathbf{s}^{-2}\mathbf{Graphs}^\sharp(0).$$

In particular, \mathbf{GC} and $\mathbf{fGC}_{\geq 3}$ are subcomplexes of \mathbf{fGC} .

Let us denote by \mathbf{GC}_\emptyset the subspace of vectors in \mathbf{GC} involving exclusively graphs without loops. It is clear that \mathbf{GC}_\emptyset is a subcomplex of \mathbf{GC} . Moreover,

$$(10.5) \quad \mathbf{GC}_\emptyset \cong \mathbf{s}^{-2}\mathbf{Graphs}_\emptyset^\sharp(0),$$

where $\mathbf{Graphs}_\emptyset^\sharp$ is the suboperad of \mathbf{TwGra} introduced in Section 9.3.

Thus, Propositions 9.11, 9.18 imply that

COROLLARY 10.2. *The embeddings*

$$(10.6) \quad \mathbf{emb}_{\mathbf{GC}} : \mathbf{GC} \hookrightarrow \mathbf{fGC}_{\geq 3}$$

and

$$(10.7) \quad \mathbf{emb}_\emptyset : \mathbf{GC}_\emptyset \hookrightarrow \mathbf{GC}$$

are quasi-isomorphisms of cochain complexes. \square

Let us denote by $\mathbf{fGC}_{\geq 3, \text{conn}}$, $\mathbf{GC}_{\text{conn}}$, and $\mathbf{GC}_{\emptyset, \text{conn}}$ the ‘‘connected’’ versions of the subcomplexes $\mathbf{fGC}_{\geq 3}$, \mathbf{GC} and \mathbf{GC}_\emptyset , respectively. Namely,

$$(10.8) \quad \begin{aligned} \mathbf{fGC}_{\geq 3, \text{conn}} &:= \mathbf{fGC}_{\geq 3} \cap \mathbf{fGC}_{\text{conn}}, \\ \mathbf{GC}_{\text{conn}} &:= \mathbf{GC} \cap \mathbf{fGC}_{\text{conn}}, \\ \mathbf{GC}_{\emptyset, \text{conn}} &:= \mathbf{GC}_\emptyset \cap \mathbf{fGC}_{\text{conn}}, \end{aligned}$$

where $\mathbf{fGC}_{\text{conn}}$ is the subcomplex of \mathbf{fGC} introduced in Section 8.3.

For the subcomplexes (10.8) we have

PROPOSITION 10.3. *The embeddings*

$$(10.9) \quad \mathbf{emb}_{\mathbf{GC}, \text{conn}} : \mathbf{GC}_{\text{conn}} \hookrightarrow \mathbf{fGC}_{\geq 3, \text{conn}}$$

and

$$(10.10) \quad \mathbf{emb}_{\emptyset, \text{conn}} : \mathbf{GC}_{\emptyset, \text{conn}} \hookrightarrow \mathbf{GC}_{\text{conn}}$$

are quasi-isomorphisms of cochain complexes.

PROOF. It is easy to see that the cone of the embedding $\mathbf{emb}_{\mathbf{GC}, \text{conn}}$ (resp. $\mathbf{emb}_{\emptyset, \text{conn}}$) is a direct summand in the cone of the embedding $\mathbf{emb}_{\mathbf{GC}}$ (resp. \mathbf{emb}_\emptyset).

Thus the desired statements follow from Corollary 10.2 above and Claim A.1 from Appendix A. \square

Let us observe that, if all vertices of a connected graph Γ have valencies ≤ 2 , then Γ is isomorphic to one of the graphs in the list: Γ_\bullet , Γ_l^- (see figure 33), or Γ_m° (see figure 34). Hence, fGC_{conn} decomposes as

$$(10.11) \quad \text{fGC}_{\text{conn}} = \text{fGC}_{\geq 3, \text{conn}} \oplus \mathcal{K}_\diamond \oplus \mathcal{K}_-,$$

where \mathcal{K}_- (resp. \mathcal{K}_\diamond) is the subcomplex of cables (resp. polygons) introduced in Subsection 8.1 (resp. Subsection 8.2).

Therefore, using Proposition 8.5 and isomorphism (8.15) we deduce that

$$(10.12) \quad H^\bullet(\text{fGC}_{\text{conn}}) \cong H^\bullet(\text{fGC}_{\geq 3, \text{conn}}) \oplus \bigoplus_{q \geq 1} \mathfrak{s}^{4q-1} \mathbb{K}.$$

Thus we arrive at the main result of this section.

THEOREM 10.4 (T. Willwacher, [42]). *Let fGC_{conn} be the “connected part” of the full graph complex fGC (8.3). Moreover, let $\text{GC}_{\emptyset, \text{conn}}$ be the subcomplex of vectors in fGC_{conn} involving exclusively graphs Γ satisfying these two properties:*

- Γ does not have loops;
- each vertex of Γ has valency ≥ 3 .

Then

$$(10.13) \quad H^\bullet(\text{fGC}) \cong \mathfrak{s}^{-2} \widehat{S}(\mathfrak{s}^2 H^\bullet(\text{fGC}_{\text{conn}})),$$

and

$$(10.14) \quad H^\bullet(\text{fGC}_{\text{conn}}) \cong H^\bullet(\text{GC}_{\emptyset, \text{conn}}) \oplus \bigoplus_{q \geq 1} \mathfrak{s}^{4q-1} \mathbb{K},$$

where \widehat{S} is the notation for the completed symmetric algebra.

PROOF. The first decomposition (10.13) is obtained by applying the Künneth theorem to (8.16). The second decomposition (10.14) is obtained by applying Proposition 10.3 to the isomorphism (10.12). \square

EXERCISE 10.5. Using equation (8.13), prove that for every even trivalent graph $\Gamma \in \text{gra}_n$ the vector

$$(10.15) \quad \text{Av}(\Gamma) = \sum_{\sigma \in S_n} \sigma(\Gamma)$$

is a cocycle in fGC . Show that the tetrahedron depicted on figure 43 represents a non-trivial (degree zero) cocycle in fGC .

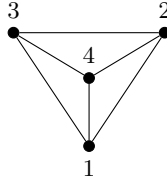

FIG. 43. We may choose this order on the set of edges: $(1, 2) < (1, 3) < (1, 4) < (2, 3) < (2, 4) < (3, 4)$

11. Deformation complex of Ger

Let us consider the following graded Lie algebra

$$(11.1) \quad \text{Conv}(\text{Ger}_\circ^\vee, \text{Ger}).$$

Due to (5.17) we have

$$(11.2) \quad \text{Conv}(\text{Ger}_\circ^\vee, \text{Ger}) = \prod_{n \geq 2} (\text{Ger}(n) \otimes \Lambda^{-2}\text{Ger}(n))^{S_n}.$$

The operad $\Lambda^{-2}\text{Ger}$ is generated by the vectors b_1b_2 and $\{b_1, b_2\}$ in $\Lambda^{-2}\text{Ger}(2)$. Moreover, the vectors b_1b_2 and $\{b_1, b_2\}$ carry the degrees 2 and 1, respectively:

$$(11.3) \quad |b_1b_2| = 2, \quad |\{b_1, b_2\}| = 1.$$

Following Section 5.2, the canonical map $\text{Cobar}(\text{Ger}^\vee) \rightarrow \text{Ger}$ (5.20) corresponds to the Maurer-Cartan element¹⁶

$$(11.4) \quad \alpha = a_1a_2 \otimes \{b_1, b_2\} + \{a_1, a_2\} \otimes b_1b_2 \in \text{Conv}(\text{Ger}_\circ^\vee, \text{Ger}).$$

Thus, using this Maurer-Cartan element, we can equip the graded Lie algebra (11.2) with the differential

$$(11.5) \quad \partial = [\alpha, \].$$

According to [34], the cochain complex (11.2) with the differential (11.5) ‘‘governs’’ deformations of the operad structure on Ger . So we refer to (11.2) as the *deformation complex* of the operad Ger .

EXERCISE 11.1. Verify the identity

$$[\alpha, \alpha] = 0$$

by a direct computation.

For our purposes it is convenient to extend the deformation complex of Ger to

$$(11.6) \quad \text{Conv}(\text{Ger}^\vee, \text{Ger}) = \prod_{n \geq 1} (\text{Ger}(n) \otimes \Lambda^{-2}\text{Ger}(n))^{S_n}.$$

Vectors in the cochain complex (11.6) are formal infinite sum

$$(11.7) \quad \sum_{n=1}^{\infty} \gamma_n,$$

where each γ_n is an S_n -invariant vector in $\text{Ger}(n) \otimes \Lambda^{-2}\text{Ger}(n)$. For example,

$$a_1a_2 \otimes \{b_1, b_2\}$$

is a degree 1 vector in (11.6).

It is obvious that

$$\text{Conv}(\text{Ger}^\vee, \text{Ger}) = \mathbb{K}\langle a_1 \otimes b_1 \rangle \oplus \text{Conv}(\text{Ger}_\circ^\vee, \text{Ger})$$

and

$$\partial(a_1 \otimes b_1) = \alpha.$$

Thus

$$(11.8) \quad H^\bullet(\text{Conv}(\text{Ger}_\circ^\vee, \text{Ger})) = H^\bullet(\text{Conv}(\text{Ger}^\vee, \text{Ger})) \oplus \mathfrak{s}\mathbb{K},$$

¹⁶From now on we omit the subscript Ger in the notation for the Maurer-Cartan element α_{Ger} .

where the additional degree 1 class is represented by the Maurer-Cartan element (11.4).

Using the map ι (7.5), we embed $\text{Conv}(\text{Ger}^\vee, \text{Ger})$ into the vector space

$$(11.9) \quad \prod_{n \geq 1} \text{Gra}(n) \otimes \Lambda^{-2} \text{Gra}(n)$$

and represent vectors in (11.9) by formal linear combinations of labeled graphs with two types of edges: solid edges for left tensor factors and dashed edges for right tensor factors.

For example, the Maurer-Cartan element (11.4) corresponds to the linear combination of graphs depicted on figure 44 and the vector

$$\{a_1, a_2\} \otimes \{b_1, b_2\}$$

corresponds to the graph depicted on figure 45

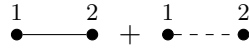

FIG. 44. The Maurer-Cartan element in the deformation complex of Ger



FIG. 45. The graph corresponding to the vector $\{a_1, a_2\} \otimes \{b_1, b_2\}$

DEFINITION 11.2. We say that a monomial $X \in \text{Ger}(n) \otimes \Lambda^{-2} \text{Ger}(n)$ is connected if its image in (11.9) is a linear combination of connected graphs. We denote by $\text{Conv}(\text{Ger}^\vee, \text{Ger})_{\text{conn}}$ the subspace of $\text{Conv}(\text{Ger}^\vee, \text{Ger})$ which consists of sums (11.7) involving exclusively connected monomials.

EXAMPLE 11.3. According to the above definition the monomials

$$\{a_1, a_2\} \otimes \{b_1, b_2\}, \quad a_1 a_2 \otimes \{b_1, b_2\}, \quad \{a_1, a_2\} \otimes b_1 b_2, \quad a_2 \{a_1, a_3\} \otimes b_1 \{b_2, b_3\}$$

are connected while the monomials

$$a_1 a_2 \otimes b_1 b_2, \quad a_2 \{a_1, a_3\} \otimes b_2 \{b_1, b_3\}$$

are disconnected.

It is not hard to see that $\text{Conv}(\text{Ger}^\vee, \text{Ger})_{\text{conn}}$ is a subcomplex of $\text{Conv}(\text{Ger}^\vee, \text{Ger})$. Furthermore, we have

$$(11.10) \quad \text{Conv}(\text{Ger}^\vee, \text{Ger}) = \mathfrak{s}^{-2} \widehat{S}(\mathfrak{s}^2 \text{Conv}(\text{Ger}^\vee, \text{Ger})_{\text{conn}}),$$

where \widehat{S} stands for the completed symmetric algebra.

REMARK 11.4. A simple degree bookkeeping shows that for every monomial $X \in \text{Ger}(n) \otimes \Lambda^{-2} \text{Ger}(n)$

$$|X| \geq 0.$$

Thus,

$$(11.11) \quad H^{<0}(\text{Conv}(\text{Ger}^\vee, \text{Ger})_{\text{conn}}) = H^{<0}(\text{Conv}(\text{Ger}^\vee, \text{Ger})) = \mathbf{0}.$$

11.1. Decomposition of $\text{Conv}(\text{Ger}^\vee, \text{Ger})$ with respect to the Euler characteristic. Let us denote by $\mathfrak{b}(v)$ the total number of Lie brackets in the Gerstenhaber monomial $v \in \text{Ger}(n)$ or $v \in \Lambda^{-2}\text{Ger}(n)$. Using the embedding of $\text{Ger}(n) \otimes \Lambda^{-2}\text{Ger}(n)$ into $\text{Gra}(n) \otimes \Lambda^{-2}\text{Gra}(n)$ we introduce the notion of Euler characteristic for monomials in $\text{Ger}(n) \otimes \Lambda^{-2}\text{Ger}(n)$:

DEFINITION 11.5. Let v and w be monomials in $\text{Ger}(n)$ and $\Lambda^{-2}\text{Ger}(n)$, respectively. We call the number

$$\chi(v \otimes w) := n - \mathfrak{b}(v) - \mathfrak{b}(w)$$

the *Euler characteristic* of the monomial $v \otimes w \in \text{Ger}(n) \otimes \Lambda^{-2}\text{Ger}(n)$.

We observe that for every sum

$$\sum_i v_i \otimes w_i \in \left(\text{Ger}(n) \otimes \Lambda^{-2}\text{Ger}(n) \right)^{S_n}$$

of monomials with the same Euler characteristic χ , each monomial in the linear combination

$$\partial \left(\sum_i v_i \otimes w_i \right)$$

also has Euler characteristic χ . Thus sums (11.7) in which each γ_n is a linear combination of monomials of Euler characteristic χ form a subcomplex of $\text{Conv}(\text{Ger}^\vee, \text{Ger})$. We denote this subcomplex by

$$(11.12) \quad \text{Conv}(\text{Ger}^\vee, \text{Ger})_\chi.$$

We claim that

PROPOSITION 11.6. *For every pair of integers m, χ the subspace $\text{Conv}(\text{Ger}^\vee, \text{Ger})_\chi^m$ of degree m vectors in $\text{Conv}(\text{Ger}^\vee, \text{Ger})_\chi$ is a subspace in*

$$\text{Ger}(n) \otimes \Lambda^{-2}\text{Ger}(n)$$

where

$$(11.13) \quad n = m - \chi + 2.$$

In particular, $\text{Conv}(\text{Ger}^\vee, \text{Ger})_\chi^m$ is finite dimensional.

PROOF. Let $v \otimes w$ be a monomial in $\text{Ger}(n) \otimes \Lambda^{-2}\text{Ger}(n)$ of degree m and Euler characteristic χ .

Let t_v (resp. t_w) be the number of Lie words in the monomial v (resp. in the monomial w). For example, if $v = \{a_2, a_4\}a_1a_7\{\{a_3, a_5\}, a_6\}$ then $t_v = 4$.

It is not hard to see that

$$(11.14) \quad |v| = t_v - n, \quad |w| = n + t_w - 2,$$

and

$$(11.15) \quad \mathfrak{b}(v) = n - t_v, \quad \mathfrak{b}(w) = n - t_w.$$

Hence

$$(11.16) \quad m = t_v + t_w - 2.$$

and

$$(11.17) \quad \chi = t_v + t_w - n.$$

Using equations (11.16) and (11.17) we deduce that

$$n = m - \chi + 2.$$

Thus a combination “degree and Euler characteristic” determines the arity n uniquely via equation (11.13). Furthermore, since $\text{Ger}(n) \otimes \Lambda^{-2}\text{Ger}(n)$ is finite dimensional, so is $\text{Conv}(\text{Ger}^\vee, \text{Ger})_\chi^m$.

The proposition is proved. \square

Proposition 11.6 has the following useful corollary.

COROLLARY 11.7. *The cochain complex $\text{Conv}(\text{Ger}^\vee, \text{Ger})$ splits into the following product of its subcomplexes:*

$$(11.18) \quad \text{Conv}(\text{Ger}^\vee, \text{Ger}) = \prod_{\chi \in \mathbb{Z}} \text{Conv}(\text{Ger}^\vee, \text{Ger})_\chi.$$

PROOF. Let

$$\gamma = \sum_{n=1}^{\infty} \gamma_n, \quad \gamma_n \in \left(\text{Ger}(n) \otimes \Lambda^{-2}\text{Ger}(n) \right)^{S_n}$$

be a homogeneous vector of degree m in $\text{Conv}(\text{Ger}^\vee, \text{Ger})$.

Equation (11.13) implies that for every n

$$\gamma_n \in \text{Conv}(\text{Ger}^\vee, \text{Ger})_\chi$$

with $\chi = m + 2 - n$. Thus,

$$\text{Conv}(\text{Ger}^\vee, \text{Ger}) \subset \prod_{\chi \in \mathbb{Z}} \text{Conv}(\text{Ger}^\vee, \text{Ger})_\chi.$$

The other inclusion

$$\prod_{\chi \in \mathbb{Z}} \text{Conv}(\text{Ger}^\vee, \text{Ger})_\chi \subset \text{Conv}(\text{Ger}^\vee, \text{Ger})$$

is proved similarly. \square

The combination of Proposition 11.6 and Corollary 11.7 will allow us to reduce questions about cocycles in $\text{Conv}(\text{Ger}^\vee, \text{Ger})$ to the corresponding questions about cocycles in its subcomplex¹⁷ $\text{Conv}^\oplus(\text{Ger}^\vee, \text{Ger})$.

11.2. We are getting rid of Lie words of length 1. Let us recall that, for a monomial $w \in \Lambda^{-2}\text{Ger}(n)$, the notation $\mathfrak{L}_1(w)$ is reserved for the number of Lie words in w of length = 1. For example, $\mathfrak{L}_1(b_1b_2) = 2$ and $\mathfrak{L}_1(\{b_1, b_2\}) = 0$.

Let us also recall that for the collection $\{\Lambda^{-2}\text{Ger}^\heartsuit(n)\}_{n \geq 0}$ (6.67)

$$\Lambda^{-2}\text{Ger}^\heartsuit(0) = \mathfrak{s}^{-2}\mathbb{K}$$

and

$$\Lambda^{-2}\text{Ger}^\heartsuit(n), \quad n \geq 1$$

is the S_n -submodule of $\Lambda^{-2}\text{Ger}(n)$ spanned by monomials $w \in \Lambda^{-2}\text{Ger}(n)$ for which $\mathfrak{L}_1(w) = 0$.

Using this collection, we introduce the subspace of $\text{Conv}(\text{Ger}^\vee, \text{Ger})$

$$(11.19) \quad \Xi := \prod_{n \geq 2} \left(\text{Ger}(n) \otimes \Lambda^{-2}\text{Ger}^\heartsuit(n) \right)^{S_n},$$

¹⁷The functor Conv^\oplus was introduced in Section 4.1.

which will play an important role in establishing a link between the deformation complex (11.1) of Ger and the full graph complex fGC (8.3).

We reserve the notation Ξ_{conn} for the ‘‘connected part’’ of Ξ :

$$(11.20) \quad \Xi_{\text{conn}} := \Xi \cap \text{Conv}(\text{Ger}^\vee, \text{Ger})_{\text{conn}} .$$

Furthermore,

$$(11.21) \quad \Xi^\oplus := \Xi \cap \text{Conv}^\oplus(\text{Ger}^\vee, \text{Ger})$$

and

$$(11.22) \quad \Xi_{\text{conn}}^\oplus := \Xi_{\text{conn}} \cap \text{Conv}^\oplus(\text{Ger}^\vee, \text{Ger}) \cap \text{Conv}(\text{Ger}^\vee, \text{Ger})_{\text{conn}}$$

We claim that

PROPOSITION 11.8. *The subspaces Ξ , Ξ_{conn} , Ξ^\oplus , and Ξ_{conn}^\oplus are subcomplexes of*

$$\text{Conv}(\text{Ger}^\vee, \text{Ger}) .$$

PROOF. Let

$$(11.23) \quad X = \sum_{n=2}^{\infty} v_n \otimes w_n$$

be a vector in Ξ .

The bracket

$$[a_1 a_2 \otimes \{b_1, b_2\}, X]$$

is obviously a vector in Ξ . So we need to prove that the vector

$$(11.24) \quad [\{a_1, a_2\} \otimes b_1 b_2, X]$$

belongs Ξ .

We have

$$(11.25) \quad \begin{aligned} & [\{a_1, a_2\} \otimes b_1 b_2, v_n \otimes w_n] = \\ & \sum_{i=1}^{n+1} \varsigma_{i,n+1}(\{v_n, a_{n+1}\}) \otimes \varsigma_{i,n+1}(w_n b_{n+1}) - \\ & (-1)^{|v_n|} \sum_{\sigma \in \text{Sh}_{2,n-1}} \sigma(v_n \circ_1 \{a_1, a_2\}) \otimes \sigma(w_n \circ_1 b_1 b_2), \end{aligned}$$

where $\varsigma_{i,n+1}$ is the cycle $(i, i+1, \dots, n+1)$ in S_{n+1} .

Using the defining identities of the Gerstenhaber algebra, it is not hard to prove that unwanted terms in (11.25) cancel each other. \square

We will need the following Theorem.

THEOREM 11.9. *The embeddings*

$$(11.26) \quad \Xi \hookrightarrow \text{Conv}(\text{Ger}^\vee, \text{Ger}),$$

$$(11.27) \quad \Xi_{\text{conn}} \hookrightarrow \text{Conv}(\text{Ger}^\vee, \text{Ger})_{\text{conn}},$$

and

$$(11.28) \quad \Xi^\oplus \hookrightarrow \text{Conv}^\oplus(\text{Ger}^\vee, \text{Ger})$$

are quasi-isomorphisms of cochain complexes.

PROOF. We will prove that the embedding (11.28) is a quasi-isomorphism of cochain complexes. Then we will deduce that the embeddings (11.26) and (11.27) are also quasi-isomorphisms.

Let us recall from Section 6.7 that $\text{Conv}^\oplus(\text{Ger}^\vee, \text{Ger})$ has the following ascending filtration

$$(11.29) \quad \dots \subset \mathcal{F}^{m-1} \text{Conv}^\oplus(\text{Ger}^\vee, \text{Ger}) \subset \mathcal{F}^m \text{Conv}^\oplus(\text{Ger}^\vee, \text{Ger}) \subset \dots,$$

where $\mathcal{F}^m \text{Conv}^\oplus(\text{Ger}^\vee, \text{Ger})$ consists of sums

$$\sum_i v_i \otimes w_i \in \bigoplus_n (\text{Ger}(n) \otimes \Lambda^{-2} \text{Ger}(n))^{S_n}$$

which satisfy

$$\mathfrak{L}_1(w_i) - |v_i \otimes w_i| \leq m, \quad \forall i.$$

The restriction of (11.29) to the subcomplex Ξ^\oplus gives us the “silly” filtration

$$(11.30) \quad \mathcal{F}^m(\Xi^\oplus)^k = \begin{cases} (\Xi^\oplus)^k & \text{if } m \geq -k, \\ \mathbf{0} & \text{if } m < -k \end{cases}$$

with the zero differential on the associated graded complex

$$(11.31) \quad \text{Gr } \Xi^\oplus \cong \bigoplus_{n \geq 2} (\text{Ger}(n) \otimes \Lambda^{-2} \text{Ger}^\heartsuit(n))^{S_n}.$$

Due to Proposition 6.17 in Section 6.7, the formula¹⁸

$$(11.32) \quad \Upsilon_{\text{Ger}} \left(\sum_i v_i \otimes w_i \right) := \sum_{\sigma \in \text{Sh}_{r,n}} \sum_i \sigma(v_i(a_1, \dots, a_{r+n})) \otimes \sigma(b_1 \dots b_r w_i(b_{r+1}, \dots, b_{r+n}))$$

$$\sum_i v_i \otimes w_i \in (\mathfrak{s}^{2r} \text{Ger}(r+n)^{S_r} \otimes \Lambda^{-2} \text{Ger}^\heartsuit(n))^{S_n}$$

defines an isomorphism of cochain complexes

$$(11.33) \quad \Upsilon_{\text{Ger}} : \bigoplus_{n \geq 1} (\text{TwGer}(n) \otimes \Lambda^{-2} \text{Ger}^\heartsuit(n))^{S_n} \rightarrow \text{Gr } \text{Conv}^\oplus(\text{Ger}^\vee, \text{Ger}),$$

where the differential on the source comes from the differential ∂^{Tw} on TwGer .

It is easy to see that the natural map

$$(11.34) \quad \text{Gr } \Xi^\oplus \hookrightarrow \bigoplus_{n \geq 1} (\text{TwGer}(n) \otimes \Lambda^{-2} \text{Ger}^\heartsuit(n))^{S_n}$$

induced by the embedding (6.46) fits into the commutative diagram

$$\begin{array}{ccc} \text{Gr } \Xi^\oplus & & \\ \downarrow & \searrow & \\ \bigoplus_{n \geq 1} (\text{TwGer}(n) \otimes \Lambda^{-2} \text{Ger}^\heartsuit(n))^{S_n} & \xrightarrow{\Upsilon_{\text{Ger}}} & \text{Gr } \text{Conv}^\oplus(\text{Ger}^\vee, \text{Ger}), \end{array}$$

¹⁸Recall that, due to Exercise 6.13, $\text{TwGer} = \text{Tw}^\oplus \text{Ger}$.

where the slanted arrow is the canonical embedding of $\text{Gr } \Xi^\oplus$ into $\text{Gr } \text{Conv}^\oplus(\text{Ger}^\vee, \text{Ger})$.

On the other hand, using Künneth's theorem and Theorem 6.16 together with the fact that, in characteristic zero, the cohomology commutes with taking invariants we deduce that the embedding (11.34) is a quasi-isomorphism of cochain complexes.

Therefore the embedding (11.28) induces a quasi-isomorphism of the associated graded complexes.

Thus, since the filtrations (11.29) and (11.30) are locally bounded and cocomplete, we deduce from Lemma A.3 that the embedding (11.28) is also a quasi-isomorphism of cochain complexes.

Combining this fact with Proposition 11.6 and Corollary 11.7 we conclude that the embedding (11.26) is a quasi-isomorphism of cochain complexes.

Since the cone of the map (11.27) is the direct summand in the cone of the map (11.26), the embedding (11.27) is also a quasi-isomorphism by Claim A.1.

Theorem 11.9 is proved. \square

12. Tamarkin's rigidity in the stable setting

Let us consider the Lie algebra

$$(12.1) \quad \text{Conv}(\text{Ger}^\vee, \text{Gra}) = \prod_{n \geq 1} (\text{Gra}(n) \otimes \Lambda^{-2} \text{Ger}(n))^{S_n}.$$

The map of operads (7.5) induces a homomorphism of Lie algebras

$$(12.2) \quad \iota_* : \text{Conv}(\text{Ger}^\vee, \text{Ger}) \rightarrow \text{Conv}(\text{Ger}^\vee, \text{Gra}).$$

In particular, the vector¹⁹

$$(12.3) \quad \iota_*(\alpha) = \Gamma_{\bullet\bullet} \otimes b_1 b_2 + \Gamma_{\bullet\bullet} \otimes \{b_1, b_2\}$$

is a Maurer-Cartan element in (12.1) and the formula

$$(12.4) \quad \partial = [\iota_*(\alpha), \]$$

defines a differential on the Lie algebra (12.1).

Using map (7.5) once again we can embed (12.1) into (11.9). Thus, by analogy with (11.10), we have

$$(12.5) \quad \text{Conv}(\text{Ger}^\vee, \text{Gra}) = \mathfrak{s}^{-2} \widehat{S}(\mathfrak{s}^2 \text{Conv}(\text{Ger}^\vee, \text{Gra})_{\text{conn}})$$

where $\text{Conv}(\text{Ger}^\vee, \text{Gra})_{\text{conn}}$ is the subcomplex of $\text{Conv}(\text{Ger}^\vee, \text{Gra})$ which consists of formal linear combinations of connected monomials in $\text{Conv}(\text{Ger}^\vee, \text{Gra})$.

The goal of this section is to prove the following theorem²⁰

THEOREM 12.1. *For the cooperad Ger^\vee and the operad Gra we have*

$$(12.6) \quad H^m(\text{Conv}(\text{Ger}^\vee, \text{Gra})) = \begin{cases} \mathbb{K} & \text{if } m = 1 \\ \mathbf{0} & \text{otherwise.} \end{cases}$$

Furthermore, $H^1(\text{Conv}(\text{Ger}^\vee, \text{Gra}))$ is spanned by the cohomology class of the vector $\Gamma_{\bullet\bullet} \otimes b_1 b_2$.

¹⁹The vectors $\Gamma_{\bullet\bullet}, \Gamma_{\bullet\bullet} \in \text{Gra}(2)$ are defined in (7.3).

²⁰Another version of this theorem is proved in [5].

The proof of this theorem is given below in Subsection 12.6. It is based on auxiliary constructions which are described in Subsections 12.2, 12.3, 12.4, and 12.5.

Before proceeding to these constructions, we will give a couple of useful corollaries of Theorem 12.1 and discuss its relation to Tamarkin's rigidity from [20, Subsection 5.4.5.].

First, we claim that

COROLLARY 12.2. *For the cochain complex $\text{Conv}(\text{Ger}^\vee, \text{Gra})_{\text{conn}}$ we have*

$$(12.7) \quad H^m(\text{Conv}(\text{Ger}^\vee, \text{Gra})_{\text{conn}}) = \begin{cases} \mathbb{K} & \text{if } m = 1 \\ \mathbf{0} & \text{otherwise.} \end{cases}$$

Furthermore, $H^1(\text{Conv}(\text{Ger}^\vee, \text{Gra})_{\text{conn}})$ is spanned by the cohomology class of the vector $\Gamma_{\bullet\bullet} \otimes b_1 b_2$.

PROOF. Due to Theorem 12.1, every cocycle $c \in \text{Conv}(\text{Ger}^\vee, \text{Gra})$ is cohomologous to a cocycle of the form

$$(12.8) \quad \lambda \Gamma_{\bullet\bullet} \otimes b_1 b_2, \quad \lambda \in \mathbb{K}$$

On the other hand, the subcomplex $\text{Conv}(\text{Ger}^\vee, \text{Gra})_{\text{conn}}$ is a direct summand in $\text{Conv}(\text{Ger}^\vee, \text{Gra})$. Therefore every cocycle $c \in \text{Conv}(\text{Ger}^\vee, \text{Gra})_{\text{conn}}$ is cohomologous to a cocycle of the form (12.8).

Thus, since the cocycle

$$\Gamma_{\bullet\bullet} \otimes b_1 b_2 \in \text{Conv}(\text{Ger}^\vee, \text{Gra})_{\text{conn}}$$

is non-trivial the desired statement about cohomology of $\text{Conv}(\text{Ger}^\vee, \text{Gra})_{\text{conn}}$ follows. \square

Following the terminology of Section 4.4 the Lie algebra $\text{Conv}(\text{Ger}^\vee, \text{Gra})$ is equipped with the descending filtration ‘‘by arity’’:

$$(12.9) \quad \mathcal{F}_m \text{Conv}(\text{Ger}^\vee, \text{Gra}) := \{f \in \text{Conv}(\text{Ger}^\vee, \text{Gra}) \mid f(w) = 0 \quad \forall w \in \text{Ger}(n), n \leq m\}.$$

In other words,

$$(12.10) \quad \mathcal{F}_m \text{Conv}(\text{Ger}^\vee, \text{Gra}) = \prod_{n \geq m+1} \left(\text{Gra}(n) \otimes \Lambda^{-2} \text{Ger}(n) \right)^{S_n}.$$

Furthermore, since the Maurer-Cartan element (12.3) belongs to $\mathcal{F}_1 \text{Conv}(\text{Ger}^\vee, \text{Gra})$, the differential (12.4) is compatible with the filtration (12.9).

Theorem 12.1 implies that

COROLLARY 12.3. *The cochain complex*

$$\mathcal{F}_2 \text{Conv}(\text{Ger}^\vee, \text{Gra}) = \prod_{n \geq 3} \left(\text{Gra}(n) \otimes \Lambda^{-2} \text{Ger}(n) \right)^{S_n}$$

with the differential (12.4) is acyclic.

PROOF. Let c be a cocycle in $\mathcal{F}_2 \text{Conv}(\text{Ger}^\vee, \text{Gra})$.

Due to Theorem 12.1 there exists a vector $c_1 \in \text{Conv}(\text{Ger}^\vee, \text{Gra})$ and a scalar $\lambda \in \mathbb{K}$ such that

$$(12.11) \quad c = \lambda \Gamma_{\bullet\bullet} \otimes b_1 b_2 + \partial(c_1).$$

On the other hand, it is easy to see that $\Gamma_{\bullet\bullet\bullet} \otimes b_1 b_2$ represents a non-trivial cocycle in the quotient

$$\text{Conv}(\text{Ger}^\vee, \text{Gra}) / \mathcal{F}_2 \text{Conv}(\text{Ger}^\vee, \text{Gra}).$$

Hence $\lambda = 0$ and c is exact. \square

12.1. Why rigidity? Let PV_d be the graded vector space of polyvector fields on the affine space \mathbb{K}^d . This graded vector space carries the canonical structure of a Gerstenhaber algebra. The multiplication is the exterior multiplication of polyvector fields and the Lie bracket is the well-known Schouten bracket.

Let recall from [42] or [4, Section 3.5] that the operad Gra acts on PV_d . Moreover, the vector $\Gamma_{\bullet\bullet\bullet}$ (resp. $\Gamma_{\bullet\bullet}$) gives us the Schouten bracket (resp. the exterior multiplication) on PV_d .

Let us suppose that we are interested in Ger_∞ -structures \mathcal{Q} on PV_d which satisfy these two properties:

- \mathcal{Q} factors through the canonical map $\text{Gra} \rightarrow \text{End}_{\text{PV}_d}$;
- the binary operations of \mathcal{Q} on PV_d coincide with the Schouten bracket and the exterior multiplication.

Using Corollary 12.3, it is not hard to prove that any Ger_∞ -structure \mathcal{Q} on PV_d satisfying the above properties is homotopy equivalent to the canonical Gerstenhaber algebra structure on PV_d .

This property is an analog of the rigidity²¹ of the Gerstenhaber algebra PV_d of polyvector fields in the homotopy category. We refer the reader to [5] for more details.

12.2. Decomposition of $\text{Conv}(\text{Ger}^\vee, \text{Gra})$ with respect to the Euler characteristic. Let χ be an integer and let c be a vector

$$c \in \text{Conv}(\text{Ger}^\vee, \text{Gra})$$

for which the image

$$1 \otimes \iota(c) \in \prod_{n \geq 1} \text{Gra}(n) \otimes \Lambda^{-2} \text{Gra}(n)$$

is a (possibly infinite) sum of graphs whose Euler characteristic²² equals χ . We denote by

$$\text{Conv}(\text{Ger}^\vee, \text{Gra})_\chi$$

the subspace of such vectors. For example, both summands in $\iota \otimes \iota(\alpha)$ have Euler characteristic 1. Hence

$$\iota_*(\alpha) \in \text{Conv}(\text{Ger}^\vee, \text{Gra})_1.$$

It is not hard to see that, for every integer χ , the subspace $\text{Conv}(\text{Ger}^\vee, \text{Gra})_\chi$ is a subcomplex of $\text{Conv}(\text{Ger}^\vee, \text{Gra})$.

Let us recall that we represent vectors in the space

$$(12.12) \quad \text{Gra}(n) \otimes \Lambda^{-2} \text{Gra}(n)$$

by linear combinations of labeled graphs with two types of edges: solid edges for left tensor factors and dashed edges for right tensor factors.

²¹This rigidity property is one of the corner stones of Tamarikin's proof [20], [37] of Kontsevich's formality theorem [22].

²²As above, both solid and dashed edges enter with the same weight.

Let us denote by

$$(12.13) \quad (\text{Gra}(n) \otimes \Lambda^{-2}\text{Gra}(n))_e$$

the subspace of (12.12) which is spanned by graphs whose total number of edges (solid and dashed) equals e . It is obvious that the subspace (12.13) is finite dimensional.

We have the following proposition.

PROPOSITION 12.4. *For every pair of integers m, χ the subspace $\text{Conv}(\text{Ger}^\vee, \text{Gra})_\chi^m$ of degree m vectors in $\text{Conv}(\text{Ger}^\vee, \text{Gra})_\chi$ is isomorphic to the subspace of (12.13) with*

$$(12.14) \quad n = m - \chi + 2$$

and

$$(12.15) \quad e = m - 2\chi + 2.$$

In particular, $\text{Conv}(\text{Ger}^\vee, \text{Gra})_\chi^m$ is finite dimensional.

PROOF. Let Γ be an graph in gra_n representing a vector in $\text{Gra}(n)$ and w be a monomial in $\Lambda^{-2}\text{Ger}(n)$. As above, t_w denotes the total number of Lie monomials and $\mathfrak{b}(w)$ denotes the the total number of brackets in w .

Let us suppose that $\Gamma \otimes w$ carries degree m and $\Gamma \otimes \iota(w)$ has Euler characteristic χ . In other words,

$$m = -e_\Gamma + |w|$$

and

$$(12.16) \quad \chi = n - e_\Gamma - \mathfrak{b}(w),$$

where e_Γ is the number of edges of Γ .

Due to equations (11.14) and (11.15)

$$(12.17) \quad |w| = n + t_w - 2, \quad t_w = n - \mathfrak{b}(w).$$

Therefore,

$$m = n + t_w - 2 - e_\Gamma = 2n - \mathfrak{b}(w) - e_\Gamma - 2 = n + \chi - 2.$$

Thus

$$(12.18) \quad n = m - \chi + 2.$$

Using (12.16) and (12.18) we deduce that

$$e_\Gamma + \mathfrak{b}(w) = m - 2\chi + 2.$$

Hence $\Gamma \otimes \iota(w)$ is a vector in (12.13) with numbers n and e given by equations (12.14) and (12.15).

Thus, the proposition follows from the fact that the map

$$\iota : \Lambda^{-2}\text{Ger}(n) \rightarrow \Lambda^{-2}\text{Gra}(n)$$

is injective. □

Proposition 12.4 has the following useful corollary.

COROLLARY 12.5. *The cochain complex $\text{Conv}(\text{Ger}^\vee, \text{Gra})$ splits into the following product of its subcomplexes:*

$$(12.19) \quad \text{Conv}(\text{Ger}^\vee, \text{Gra}) = \prod_{\chi \in \mathbb{Z}} \text{Conv}(\text{Ger}^\vee, \text{Gra})_\chi.$$

PROOF. The proof of this statement is very similar to that of Corollary 11.7. So we leave it as an exercise for the reader. \square

EXERCISE 12.6. Prove Corollary 12.5.

Just as for TwGra and $\text{Conv}(\text{Ger}^\vee, \text{Ger})$, the combination of Proposition 12.4 and Corollary 12.5 will allow us to reduce questions about cocycles in $\text{Conv}(\text{Ger}^\vee, \text{Gra})$ to the corresponding questions about cocycles in its subcomplex

$$(12.20) \quad \text{Conv}^\oplus(\text{Ger}^\vee, \text{Gra}) := \bigoplus_{n \geq 1} (\text{Gra}(n) \otimes \Lambda^{-2} \text{Ger}(n))^{S_n}.$$

12.3. An alternative description of $\text{Gra}(n)$. Let e be a positive integer and

$$(12.21) \quad \{\rho_1, \rho'_1, \rho_2, \rho'_2, \dots, \rho_e, \rho'_e\}$$

be a set of auxiliary variables with degrees $|\rho_i| = -1$ and $|\rho'_i| = 0$.

We will need the symmetric algebra

$$(12.22) \quad S(V_e) = \mathbb{K} \oplus V_e \oplus S^2(V_e) \oplus S^3(V_e) \oplus \dots$$

of the vector space

$$(12.23) \quad V_e = \mathbb{K}\langle \rho_1, \rho'_1, \rho_2, \rho'_2, \dots, \rho_e, \rho'_e \rangle,$$

spanned by elements on the set (12.21).

We view $S(V_e)$ as the cocommutative coalgebra with the standard comultiplication.

Let us denote by $T_n(S(V_e))$ the subspace

$$(12.24) \quad T_n(S(V_e)) \subset (S(V_e))^{\otimes n}$$

of $(S(V_e))^{\otimes n}$ which is spanned by monomials

$$(12.25) \quad X_1 \otimes X_2 \otimes \dots \otimes X_n$$

in which each variable from the set (12.21) appears exactly once.

For example, if $e = 3$ then

$$\rho'_1 \rho_2 \otimes \rho'_2 \rho_1 \otimes 1 \otimes \rho_3 \rho'_3 \in T_4(S(V_e)), \quad \rho'_1 \rho_2 \rho'_3 \otimes \rho'_2 \rho_1 \rho_3 \in T_2(S(V_e)),$$

and

$$\rho_1 \rho_2 \rho_3 \otimes 1 \otimes \rho'_2 \rho_1 \otimes \rho_3 \rho'_3 \notin T_4(S(V_e)), \quad \rho_1 \rho_2 \rho'_3 \otimes \rho'_1 \rho_3 \notin T_2(S(V_e)).$$

It makes sense to include the degenerate case $e = 0$ in our consideration. If $e = 0$ then the set (12.21) is empty,

$$S(V_e) = \mathbb{K},$$

and

$$T_n(S(V_e)) = \mathbb{K}^{\otimes n} \cong \mathbb{K}.$$

Given a monomial (12.25) we form a labeled graph Γ' with n vertices and e directed edges following these two steps:

- we declare that edge i originates at the j -th vertex if the factor X_j involves the variable ρ_i ;
- we declare that edge i terminates at the k -th vertex if the factor X_k involves the variable ρ'_i .

Since each variable in the set (12.21) appears in the monomial (12.25) exactly once, these two steps give us a labeled graph with n vertices and with e directed edges.

Notice that we use indices of the variables (12.21) to keep track of edges of Γ' . This bijection between the set of edges of Γ' and natural numbers $1, 2, \dots, e$ plays a purely auxiliary role and we do not keep it for Γ' as a piece of additional data.

It is more important to observe that the set $E(\Gamma')$ of edges of Γ' is equipped with an order up to an even permutation. This order is defined by the following rule:

- if the initial vertex of edge i_1 carries a smaller label than the initial vertex of edge i_2 then we set $i_1 < i_2$;
- if edges i_1 and i_2 originate from the same vertex (say, vertex j) and ρ_{i_1} stands to the left from ρ_{i_2} in the factor X_j then we also set $i_1 < i_2$.

For example, the monomial $\rho'_1\rho_2 \otimes \rho'_2\rho_1 \otimes 1 \otimes \rho_3\rho'_3$ corresponds to the labeled directed graph Γ' depicted on figure 46.

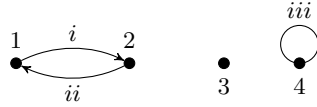

FIG. 46. The directed labeled graph corresponding to the monomial $\rho'_1\rho_2 \otimes \rho'_2\rho_1 \otimes 1 \otimes \rho_3\rho'_3$

Let us denote by Γ the undirected graph (with an order on the set of edges up to an even permutation) which is obtained from Γ' by forgetting the directions. It is clear that the formula

$$(12.26) \quad \Theta(X_1 \otimes X_2 \otimes \dots \otimes X_n) = \Gamma$$

defines a surjective map of graded vector spaces

$$(12.27) \quad \Theta : \bigoplus_{e \geq 0} T_n(S(V_e)) \rightarrow \text{Gra}(n).$$

For example, $\Theta(\rho'_1\rho_2 \otimes \rho'_2\rho_1 \otimes 1 \otimes \rho_3\rho'_3) = 0$ because the graph Γ corresponding to the monomial $\rho'_1\rho_2 \otimes \rho'_2\rho_1 \otimes 1 \otimes \rho_3\rho'_3$ has double edges.

To describe the kernel of (12.27) we recall, from Subsection 9.2.1, the group (9.33)

$$(12.28) \quad S_e \times (S_2)^e$$

with the multiplication law defined by equation (9.34).

Let us equip the graded vector space (12.24) with a left action of the group (12.28).

For this purpose, we declare that elements $\tau \in S_e$ and

$$\sigma_j = (\text{id}, \dots, \text{id}, \underbrace{(12)}_{j\text{-th spot}}, \text{id}, \dots, \text{id}) \in (S_2)^e$$

act on generators (12.21) as

$$\tau(\rho_i) = \rho_{\tau(i)}, \quad \tau(\rho'_i) = \rho'_{\tau(i)},$$

and

$$\sigma_j(\rho_i) = \begin{cases} \rho_i & \text{if } i \neq j \\ \rho'_i & \text{if } i = j, \end{cases} \quad \sigma_j(\rho'_i) = \begin{cases} \rho'_i & \text{if } i \neq j \\ \rho_i & \text{if } i = j, \end{cases}$$

respectively.

Next, we extend the action of elements $\{\sigma_j\}_{1 \leq j \leq e}$ to the space (12.24) by incorporating appropriate sign factor which appear if odd variables ρ_1, \dots, ρ_e “move around”. Finally, we declare that elements of S_e act by automorphisms (of the commutative algebra) $S(V_e)$ and then extend the action of S_e to the space (12.24) by the formula:

$$\tau(X_1 \otimes X_2 \otimes \cdots \otimes X_n) = \tau(X_1) \otimes \tau(X_2) \otimes \cdots \otimes \tau(X_n).$$

For example, the transposition $(23) \in S_3$ sends the vector $\rho'_1 \rho_2 \otimes \rho'_2 \rho_1 \otimes 1 \otimes \rho_3 \rho'_3$ to the vector

$$\rho'_1 \rho_3 \otimes \rho'_3 \rho_1 \otimes 1 \otimes \rho_2 \rho'_2$$

and the element σ_1 sends the vector $\rho'_1 \rho_2 \otimes \rho'_2 \rho_1 \otimes 1 \otimes \rho_3 \rho'_3$ to the vector

$$-\rho_1 \rho_2 \otimes \rho'_2 \rho'_1 \otimes 1 \otimes \rho_3 \rho'_3.$$

The sign factor in the action of σ_1 appeared because the variables ρ_1 and ρ_2 changed their order.

Due to Exercise 12.8 below the kernel of Θ (12.27) is spanned by vectors of the form

$$(12.29) \quad (X_1 \otimes X_2 \otimes \cdots \otimes X_n) - g(X_1 \otimes X_2 \otimes \cdots \otimes X_n), \quad g \in S_e \times (S_2)^e.$$

Hence, we conclude that

PROPOSITION 12.7. *The map Θ (12.27) induces an isomorphism of graded vector spaces*

$$\text{Gra}(n) \cong \bigoplus_{e \geq 0} \left(T_n(S(V_e)) \right)_{S_e \times (S_2)^e},$$

where $\left(T_n(S(V_e)) \right)_{S_e \times (S_2)^e}$ denotes the space of coinvariants in (12.24). \square

EXERCISE 12.8. Prove that the kernel of the map Θ (12.27) is spanned by vectors of the form (12.29). *Hint: First, prove that, if a monomial (12.25) corresponds to a graph with multiple edges, then this monomial belongs to the span of vectors of the form (12.29). Second, consider linear combinations of monomials (12.25) each of which does not belong to the kernel of Θ .*

EXAMPLE 12.9. We mentioned above that

$$\Theta(\rho'_1 \rho_2 \otimes \rho'_2 \rho_1 \otimes 1 \otimes \rho_3 \rho'_3) = 0.$$

For the monomial $\rho'_1 \rho_2 \otimes \rho'_2 \rho_1 \otimes 1 \otimes \rho_3 \rho'_3$ we have

$$\sigma_1(\rho'_1 \rho_2 \otimes \rho'_2 \rho_1 \otimes 1 \otimes \rho_3 \rho'_3) = -\rho_1 \rho_2 \otimes \rho'_2 \rho'_1 \otimes 1 \otimes \rho_3 \rho'_3$$

$$\sigma_2(\rho_1 \rho_2 \otimes \rho'_2 \rho'_1 \otimes 1 \otimes \rho_3 \rho'_3) = \rho_1 \rho'_2 \otimes \rho_2 \rho'_1 \otimes 1 \otimes \rho_3 \rho'_3$$

and

$$\varsigma_{12}(\rho_1 \rho'_2 \otimes \rho_2 \rho'_1 \otimes 1 \otimes \rho_3 \rho'_3) = \rho_2 \rho'_1 \otimes \rho_1 \rho'_2 \otimes 1 \otimes \rho_3 \rho'_3,$$

where ς_{12} is the transposition (12) in S_3 .

Hence,

$$\varsigma_{12}\sigma_2\sigma_1(\rho'_1\rho_2 \otimes \rho'_2\rho_1 \otimes 1 \otimes \rho_3\rho'_3) = -(\rho'_1\rho_2 \otimes \rho'_2\rho_1 \otimes 1 \otimes \rho_3\rho'_3).$$

Thus

$$\rho'_1\rho_2 \otimes \rho'_2\rho_1 \otimes 1 \otimes \rho_3\rho'_3 = \frac{1}{2}(\rho'_1\rho_2 \otimes \rho'_2\rho_1 \otimes 1 \otimes \rho_3\rho'_3 - \varsigma_{12}\sigma_2\sigma_1(\rho'_1\rho_2 \otimes \rho'_2\rho_1 \otimes 1 \otimes \rho_3\rho'_3)).$$

In other words, the monomial $\rho'_1\rho_2 \otimes \rho'_2\rho_1 \otimes 1 \otimes \rho_3\rho'_3$ belongs to the subspace spanned by vectors of the form (12.29).

12.4. An auxiliary cochain complex $\Lambda^{-2}\text{Ger}(S(V_e))$. Let us consider the free $\Lambda^{-2}\text{Ger}$ -algebra generated by $S(V_e)$

$$(12.30) \quad \Lambda^{-2}\text{Ger}(S(V_e)).$$

Using the reduced comultiplication:

$$(12.31) \quad \tilde{\Delta}(X) = \Delta(X) - 1 \otimes X - X \otimes 1$$

on $S(V_e)$ we introduce on (12.30) the degree 1 derivation δ defined by the formula

$$(12.32) \quad \delta(X) = -\sum_i \{X'_i, X''_i\}$$

where $X \in S(V_e)$ and X'_i, X''_i are tensor factors in

$$\tilde{\Delta}(X) = \sum_i X'_i \otimes X''_i.$$

For example, since

$$\tilde{\Delta}(v) = 0 \quad \forall v \in V_e \subset S(V_e)$$

we have

$$\delta(v) = 0 \quad \forall v \in V_e \subset S(V_e).$$

The Jacobi identity implies that

$$\delta^2 = 0.$$

Thus δ is a differential on (12.30).

It is clear that the free $\Lambda^{-1}\text{Lie}$ -algebra $\Lambda^{-1}\text{Lie}(S(V_e))$ is a subcomplex of (12.30). Furthermore,

$$(12.33) \quad \Lambda^{-2}\text{Ger}(S(V_e)) \cong \mathfrak{s}^{-2}S(\mathfrak{s}^2\Lambda^{-1}\text{Lie}(S(V_e)))$$

as cochain complexes.

On the other hand, Theorem B.1 from Appendix²³ B implies that for every cocycle $c \in \Lambda^{-1}\text{Lie}(S(V_e))$ there exists a vector $c_1 \in \Lambda^{-1}\text{Lie}(S(V_e))$ and a vector $v \in V_e$ such that

$$c = v + \delta(c_1).$$

Furthermore, each non-zero vector $v \in V_e$ is a non-trivial cocycle in $\Lambda^{-1}\text{Lie}(S(V_e))$.

Therefore, due to Künneth's theorem,

$$(12.34) \quad H^\bullet(\Lambda^{-2}\text{Ger}(S(V_e)), \delta) \cong \mathfrak{s}^{-2}S(\mathfrak{s}^2V_e)$$

and the space

$$H^\bullet(\Lambda^{-2}\text{Ger}(S(V_e)), \delta)$$

²³Since formulas (12.32) and (B.5) for the differentials differ only by the overall sign factor, Theorem B.1 can be applied in this case.

is spanned by the cohomology classes of the vectors

$$(12.35) \quad b_1 \dots b_n \otimes (v_1 \otimes \dots \otimes v_n),$$

where $v_i \in V_e$ and $b_1 \dots b_n$ is the generator of $\Lambda^{-2}\mathrm{Com}(n) \subset \Lambda^{-2}\mathrm{Ger}(n)$.

Thus we arrive at the following statement.

PROPOSITION 12.10. *For any cocycle*

$$c \in \Lambda^{-2}\mathrm{Ger}(S(V_e))$$

there exists a vector $c_1 \in \Lambda^{-2}\mathrm{Ger}(S(V_e))$ such that the difference

$$c - \delta(c_1)$$

belongs to the linear span of (12.35). Furthermore, a vector

$$Y \in \mathfrak{s}^{-2}S(\mathfrak{s}^2V_e)$$

is δ -exact if and only if $Y = 0$. \square

12.4.1. *A equivalent description of (12.30) in terms of invariants.* Let $\mathcal{G}'(V_e)$ denote the following graded vector space

$$(12.36) \quad \mathcal{G}'(V_e) := \bigoplus_n \left(\Lambda^{-2}\mathrm{Ger}(n) \otimes (S(V_e))^{\otimes n} \right)_{S_n}.$$

Since our base field has characteristic zero, this graded vector space is isomorphic to

$$(12.37) \quad \Lambda^{-2}\mathrm{Ger}(S(V_e)) = \bigoplus_n \left(\Lambda^{-2}\mathrm{Ger}(n) \otimes (S(V_e))^{\otimes n} \right)_{S_n}.$$

For example, one may define an isomorphism \mathfrak{J} from (12.37) to (12.36) by the formula:

$$(12.38) \quad \mathfrak{J}(w; X_1 \otimes \dots \otimes X_n) = \sum_{\sigma \in S_n} (-1)^{\varepsilon(\sigma)} (\sigma(w); X_{\sigma^{-1}(1)} \otimes \dots \otimes X_{\sigma^{-1}(n)}),$$

where $w \in \Lambda^{-2}\mathrm{Ger}(n)$, $X_i \in S(V_e)$, the sign factor $(-1)^{\varepsilon(\sigma)}$ comes from the usual Koszul rule, and $(w; X_1 \otimes \dots \otimes X_n)$ represents a vector in

$$\left(\Lambda^{-2}\mathrm{Ger}(n) \otimes (S(V_e))^{\otimes n} \right)_{S_n}.$$

Let

$$\sum_t (w_t; X_1^t \otimes \dots \otimes X_n^t)$$

be a vector in

$$\left(\Lambda^{-2}\mathrm{Ger}(n) \otimes (S(V_e))^{\otimes n} \right)_{S_n}$$

and let δ' be a degree 1 operation on $\mathcal{G}'(V_e)$ given by the equation:

$$(12.39) \quad \delta' \left(\sum_t (w_t; X_1^t \otimes \dots \otimes X_n^t) \right) = \sum_t \sum_{\sigma \in \mathrm{Sh}_{n,1}} \sigma(\{w_t, b_{n+1}\}; X_1^t \otimes \dots \otimes X_n^t \otimes 1) - \sum_t \sum_{\tau \in \mathrm{Sh}_{2,n-1}} (-1)^{|w_t|} \tau(w_t \circ_1 \{b_1, b_2\}; \Delta X_1^t \otimes X_2^t \otimes \dots \otimes X_n^t).$$

A direct but tedious computation shows that

$$(12.40) \quad \mathfrak{J} \circ \delta = 2\delta' \circ \mathfrak{J}.$$

In other words, δ' (12.39) is a differential on (12.36) and the cohomology of the cochain complex

$$(12.41) \quad (\mathcal{G}'(V_e), \delta')$$

is isomorphic to the cohomology of (12.30) with the differential (12.32).

For our purpose, we need to switch to yet another cochain complex $\mathcal{G}(V_e)$ isomorphic to (12.41). This new cochain complex is obtained from $\mathcal{G}'(V_e)$ by exchanging the order of the tensor factors. Namely,

$$(12.42) \quad \mathcal{G}(V_e) := \bigoplus_n \left((S(V_e))^{\otimes n} \otimes \Lambda^{-2}\text{Ger}(n) \right)^{S_n}.$$

The differential $\tilde{\delta}$ induced on (12.42) by the natural isomorphism between (12.36) and (12.42) is given by the formula:

$$(12.43) \quad \tilde{\delta} \left(\sum_t (X_1^t \otimes \cdots \otimes X_n^t; w_t) \right) = \\ \sum_t \sum_{\sigma \in \text{Sh}_{n,1}} (-1)^{|X_1^t| + \cdots + |X_n^t|} \sigma(X_1^t \otimes \cdots \otimes X_n^t \otimes 1; \{w_t, b_{n+1}\}) \\ - \sum_t \sum_{\tau \in \text{Sh}_{2,n-1}} (-1)^{|w_t| + |X_1^t| + \cdots + |X_n^t|} \tau(\Delta X_1^t \otimes X_2^t \otimes \cdots \otimes X_n^t; w_t \circ_1 \{b_1, b_2\}).$$

Thus Proposition 12.10 implies the following statement.

COROLLARY 12.11. *For any cocycle*

$$c \in \mathcal{G}(V_e)$$

there exists a vector $c_1 \in \mathcal{G}(V_e)$ such that the difference

$$c - \tilde{\delta}(c_1)$$

belongs to the linear span of vectors of the form

$$(12.44) \quad \sum_{\sigma \in S_n} (v_1 \otimes \cdots \otimes v_n; b_1 \dots b_n),$$

where $v_1, v_2, \dots, v_n \in V_e$ and $b_1 \dots b_n$ is the generator of $\Lambda^{-2}\text{Com}(n) \subset \Lambda^{-2}\text{Ger}(n)$. Furthermore, a linear combination Y of vectors of the form (12.44) is $\tilde{\delta}$ -exact if and only if $Y = 0$. \square

12.5. The associated graded complex $\text{Gr Conv}^{\oplus}(\text{Ger}^{\vee}, \text{Gra})$. Let us recall that $\mathfrak{b}(w)$ denotes the total number of Lie brackets in a monomial $w \in \Lambda^{-2}\text{Ger}(n)$.

Let

$$\sum_i v_i \otimes w_i$$

be a vector in

$$\left(\text{Gra}(n) \otimes \Lambda^{-2}\text{Ger}(n) \right)^{S_n}$$

such that the number $k_{\mathfrak{b}} = \mathfrak{b}(w_i)$ is the same for every monomial w_i .

It is obvious that for every monomial w'_j in

$$\partial(v \otimes w) = \sum_j v'_j \otimes w'_j$$

we have $\mathfrak{b}(w'_j) = k_{\mathfrak{b}}$ or $\mathfrak{b}(w'_j) = k_{\mathfrak{b}} + 1$.

This observation allows us to introduce an ascending filtration

$$(12.45) \quad \dots \subset \mathcal{F}_{\mathfrak{b}}^{m-1} \text{Conv}^{\oplus}(\text{Ger}^{\vee}, \text{Gra}) \subset \mathcal{F}_{\mathfrak{b}}^m \text{Conv}^{\oplus}(\text{Ger}^{\vee}, \text{Gra}) \subset \dots$$

where $\mathcal{F}_{\mathfrak{b}}^m \text{Conv}^{\oplus}(\text{Ger}^{\vee}, \text{Gra})$ is spanned by homogeneous vectors

$$\gamma = \sum_i v_i \otimes w_i \in \text{Conv}(\text{Ger}^{\vee}, \text{Gra})$$

in which each monomial w_i satisfies the inequality

$$\mathfrak{b}(w_i) - |\gamma| \leq m.$$

It is clear that the differential $\partial^{\text{Gr}_{\mathfrak{b}}}$ on the associated graded complex

$$(12.46) \quad \text{Gr}_{\mathfrak{b}} \text{Conv}^{\oplus}(\text{Ger}^{\vee}, \text{Gra})$$

is obtained from the differential ∂ (12.4) by keeping only the terms which raise the number of Lie brackets in the second tensor factors. Namely,

$$(12.47) \quad \partial^{\text{Gr}_{\mathfrak{b}}} = [\Gamma_{\bullet\bullet} \otimes \{b_1, b_2\},] .$$

Our goal is to give a convenient description of the associated graded complex (12.46) using the map Θ (12.27) introduced in Subsection 12.3 and the cochain complex (12.42) introduced in Subsection 12.4.1.

First, we observe that, as a graded vector space,

$$(12.48) \quad \text{Gr}_{\mathfrak{b}} \text{Conv}^{\oplus}(\text{Ger}^{\vee}, \text{Gra}) \cong \bigoplus_{n \geq 1} \left(\text{Gra}(n) \otimes \Lambda^{-2} \text{Ger}(n) \right)^{S_n} .$$

Thus, due to Proposition 12.7, the map Θ (12.27) induces an isomorphism of graded vector spaces

$$(12.49) \quad \bigoplus_{n \geq 1} \bigoplus_{e \geq 0} \left(\left(T_n(S(V_e)) \otimes \Lambda^{-2} \text{Ger}(n) \right)_{S_e \times (S_2)^e} \right)^{S_n} \cong \text{Gr}_{\mathfrak{b}} \text{Conv}^{\oplus}(\text{Ger}^{\vee}, \text{Gra})$$

Since the action of the group $S_e \times (S_2)^e$ commutes with the action of S_n we conclude that Θ induces an isomorphism of graded vector spaces:

$$(12.50) \quad \Theta' : \bigoplus_{e \geq 0} \left(\bigoplus_{n \geq 1} \left(T_n(S(V_e)) \otimes \Lambda^{-2} \text{Ger}(n) \right)^{S_n} \right)_{S_e \times (S_2)^e} \rightarrow \text{Gr}_{\mathfrak{b}} \text{Conv}^{\oplus}(\text{Ger}^{\vee}, \text{Gra}) .$$

On the other hand,

$$(12.51) \quad \bigoplus_{n \geq 1} \left(T_n(S(V_e)) \otimes \Lambda^{-2} \text{Ger}(n) \right)^{S_n}$$

is a subspace in the cochain complex $\mathcal{G}(V_e)$ (12.42).

We claim that

PROPOSITION 12.12. *The subspace (12.51) is a direct summand in the cochain complex $\mathcal{G}(V_e)$ (12.42) with the differential $\tilde{\delta}$ (12.43). Furthermore, the isomorphism (12.50) is compatible with the differentials.*

PROOF. Let us recall, from Subsection 12.3, that V_e is the graded vector space of finite linear combinations of variables from the set (12.21).

The subspace (12.51) is spanned by vectors of the form

$$(12.52) \quad \sum_{\sigma \in S_n} \sigma(X_1 \otimes X_2 \otimes \cdots \otimes X_n; w)$$

where $w \in \Lambda^{-2}\text{Ger}(n)$ and

$$(12.53) \quad X_1 \otimes X_2 \otimes \cdots \otimes X_n$$

is a monomial in $(S(V_e))^{\otimes n}$ satisfying

PROPERTY 12.13. Each variable from the set (12.21) appears in (12.53) exactly once.

It is clear that this subspace is closed with respect to $\tilde{\delta}$ (12.43). Moreover, the cochain complex $\mathcal{G}(V_e)$ splits into the direct sum of (12.51) and the subcomplex spanned by vectors of the form (12.52) for which (12.53) does not satisfy Property 12.13.

To prove equation

$$(12.54) \quad \partial^{\text{Gr}_b} \circ \Theta' = \Theta' \circ \tilde{\delta}$$

we consider a monomial (12.53) satisfying Property 12.13 and a vector $w \in \Lambda^{-2}\text{Ger}(n)$. We denote by Γ the graph in gra_n which corresponds to the monomial (12.53).

Going through the construction of the map Θ it is easy to verify that

$$(12.55) \quad (\Theta \otimes 1) \circ \tilde{\delta} \left(\sum_{\sigma \in S_n} (-1)^{\varepsilon(\sigma)} X_{\sigma^{-1}(1)} \otimes X_{\sigma^{-1}(2)} \otimes \cdots \otimes X_{\sigma^{-1}(n)} \otimes \sigma(w) \right) =$$

$$\sum_{\lambda \in \text{Sh}_{n,1}} (-1)^{|\Gamma|} \sum_{\sigma \in S_n} \lambda(\Gamma_{\bullet\bullet} \circ_1 \sigma(\Gamma)) \otimes \lambda(\{\sigma(w), b_{n+1}\}) -$$

$$- \sum_{\tau \in \text{Sh}_{2,n-1}} (-1)^{|\Gamma|+|w|} \sum_{\sigma \in S_n} \tau(\sigma(\Gamma) \circ_1 \Gamma_{\bullet\bullet}) \otimes \tau(\sigma(w) \circ_1 \{b_1, b_2\}).$$

Since the right hand side of (12.55) equals

$$\left[\Gamma_{\bullet\bullet} \otimes \{b_1, b_2\}, \sum_{\sigma \in S_n} \sigma(\Gamma) \otimes \sigma(w) \right]$$

equation (12.54) follows. \square

Combining Corollary 12.11 with Proposition 12.12 we deduce

COROLLARY 12.14. *For the associated graded complex (12.46) we have*

$$(12.56) \quad H^\bullet(\text{Gr}_b \text{Conv}^\oplus(\text{Ger}^\vee, \text{Gra})) = \begin{cases} \mathbb{K} & \text{if } \bullet = 1 \\ \mathbf{0} & \text{otherwise.} \end{cases}$$

Furthermore,

$$H^1(\text{Gr}_b \text{Conv}^\oplus(\text{Ger}^\vee, \text{Gra}))$$

is spanned by the cohomology class of the vector represented by $\Gamma_{\bullet\bullet} \otimes b_1 b_2$.

PROOF. Since the cochain complex (12.51) is a direct summand in $\mathcal{G}(V_e)$ and the cohomology commutes with taking coinvariants, Corollary 12.11 implies that the cohomology of the cochain complex

$$(12.57) \quad \left(\bigoplus_{n \geq 1} \left(T_n(S(V_e)) \otimes \Lambda^{-2} \text{Ger}(n) \right)^{S_n} \right)_{S_e \times (S_2)^e}$$

is spanned by the classes of vectors of the form

$$(12.58) \quad \sum_{\sigma \in S_{2e}} \sigma(\rho_1 \otimes \rho'_1 \otimes \rho_2 \otimes \rho'_2 \otimes \cdots \otimes \rho_e \otimes \rho'_e ; b_1 \dots b_{2e}),$$

$b_1 \dots b_{2e}$ is the generator of $\Lambda^{-2} \text{Com}(2e) \subset \Lambda^{-2} \text{Ger}(2e)$.

Since variables ρ_1, \dots, ρ_e are odd, it is not hard to see that (12.58) represents the zero vector in the coinvariants (12.57) whenever $e > 1$.

On the other hand, the map Θ' (12.50) sends the vector

$$(12.59) \quad (\rho_1 \otimes \rho'_1 ; b_1 b_2) + (\rho'_1 \otimes \rho_1 ; b_1 b_2)$$

to the non-trivial cocycle

$$2\Gamma_{\bullet\bullet} \otimes b_1 b_2.$$

Hence, the corollary follows from Proposition 12.12. \square

12.6. Proof of Theorem 12.1. Let us denote by \mathcal{H} the subcomplex of $\text{Conv}^\oplus(\text{Ger}^\vee, \text{Gra})$

$$(12.60) \quad \mathcal{H} = \mathbb{K}\langle \Gamma_{\bullet\bullet} \otimes b_1 b_2 \rangle$$

spanned by the single cocycle $\Gamma_{\bullet\bullet} \otimes b_1 b_2$.

By construction, the cochain complex \mathcal{H} carries the zero differential. Moreover, restricting (12.45) on \mathcal{H} we get the “silly” filtration

$$(12.61) \quad \mathcal{F}^m \mathcal{H}^k = \begin{cases} \mathcal{H}^k & \text{if } m \geq -k, \\ \mathbf{0} & \text{otherwise} \end{cases}$$

with

$$(12.62) \quad \text{Gr } \mathcal{H} \cong \mathcal{H}.$$

Corollary 12.14 implies that the embedding

$$(12.63) \quad \mathcal{H} \hookrightarrow \text{Conv}^\oplus(\text{Ger}^\vee, \text{Gra})$$

induces a quasi-isomorphism on the level of associated graded complexes.

Since the filtrations on $\text{Conv}^\oplus(\text{Ger}^\vee, \text{Gra})$ and \mathcal{H} are bounded from the left and cocomplete, Lemma A.3 from Appendix A implies that the embedding (12.63) is quasi-isomorphism of cochain complexes.

Combining this fact with Proposition 12.4 and Corollary 12.5 we conclude that the embedding

$$(12.64) \quad \mathcal{H} \hookrightarrow \text{Conv}(\text{Ger}^\vee, \text{Gra})$$

is also a quasi-isomorphism of cochain complexes.

Since \mathcal{H} is spanned by the cocycle $\Gamma_{\bullet\bullet} \otimes b_1 b_2$, Theorem 12.1 is proved. \square

13. Deformation complex of Ger versus Kontsevich's graph complex

This section is the culmination of our text. Using the results proved above, we establish here a link between the (extended) deformation complex $\text{Conv}(\text{Ger}^\vee, \text{Ger})$ (11.6) of the operad Ger and full graph complex fGC (See Definition 8.1.)

First, recall that, due to decompositions (8.16) and (11.10), the cohomology of the cochain complex fGC (resp. $\text{Conv}(\text{Ger}^\vee, \text{Ger})$) can be expressed in terms of the cohomology of its “connected part” fGC_{conn} (resp. $\text{Conv}(\text{Ger}^\vee, \text{Ger})_{\text{conn}}$). Namely,

$$(13.1) \quad H^\bullet(\text{fGC}) \cong \mathfrak{s}^{-2} \widehat{S}(\mathfrak{s}^2 H^\bullet(\text{fGC}_{\text{conn}})),$$

and

$$(13.2) \quad H^\bullet(\text{Conv}(\text{Ger}^\vee, \text{Ger})) \cong \mathfrak{s}^{-2} \widehat{S}(\mathfrak{s}^2 H^\bullet(\text{Conv}(\text{Ger}^\vee, \text{Ger})_{\text{conn}})).$$

Let us denote by \mathfrak{R} the natural map of graded vector spaces

$$(13.3) \quad \mathfrak{R} : \text{Conv}(\text{Ger}^\vee, \text{Gra})_{\text{conn}} \rightarrow \text{fGC}_{\text{conn}} = \text{Conv}(\Lambda^2 \text{coCom}, \text{Gra})_{\text{conn}}$$

given by the formula

$$\mathfrak{R}(f) = f \Big|_{\Lambda^2 \text{coCom}}.$$

It is not hard to see that \mathfrak{R} is a map of cochain complexes. We observe that the map of dg Lie algebras ι_* (12.2)

$$\iota_* : \text{Conv}(\text{Ger}^\vee, \text{Ger}) \rightarrow \text{Conv}(\text{Ger}^\vee, \text{Gra}).$$

satisfies the following property

$$\mathfrak{R}(\iota_*(X)) = 0, \quad \forall X \in \Xi_{\text{conn}},$$

where Ξ_{conn} is defined in (11.20).

Therefore, restricting ι_* to the subcomplex Ξ_{conn} we get a map of cochain complexes

$$(13.4) \quad \psi := \iota_* \Big|_{\Xi_{\text{conn}}} : \Xi_{\text{conn}} \rightarrow \ker \mathfrak{R}.$$

We claim that

PROPOSITION 13.1. *The map ψ (13.4) is a quasi-isomorphism of cochain complexes.*

Let us postpone the proof of this proposition to Subsection 13.1 and deduce a link between the cohomology of $\text{Conv}(\text{Ger}^\vee, \text{Gra})_{\text{conn}}$ and the cohomology of fGC_{conn} .

Recall that, due to Corollary 12.2, $H^\bullet(\text{Conv}(\text{Ger}^\vee, \text{Gra})_{\text{conn}})$ is spanned by the cohomology class of the vector $\Gamma_{\bullet\bullet} \otimes b_1 b_2$.

Therefore, if we set

$$(13.5) \quad \text{Conv}(\text{Ger}^\vee, \text{Gra})_{\text{conn}}^+ = \mathbb{K} \oplus \text{Conv}(\text{Ger}^\vee, \text{Gra})_{\text{conn}}$$

and extend the differential ∂ to $\text{Conv}^+(\text{Ger}^\vee, \text{Gra})_{\text{conn}}$ by declaring that for $1 \in \mathbb{K}$

$$(13.6) \quad \partial(1) = \Gamma_{\bullet\bullet} \otimes b_1 b_2,$$

then we get an acyclic cochain complex

$$(\text{Conv}(\text{Ger}^\vee, \text{Gra})_{\text{conn}}^+, \partial).$$

Similarly, we “add” to the graph complex $\mathbf{fGC}_{\text{conn}}$ a one-dimensional vector space

$$(13.7) \quad \mathbf{fGC}_{\text{conn}}^+ = \mathbb{K} \oplus \mathbf{fGC}_{\text{conn}}$$

and extend the differential by declaring that for $1 \in \mathbb{K}$

$$\partial(1) = \Gamma_{\bullet \bullet \bullet}$$

Due to Exercise 8.4 from Section 8 we have

$$\partial \Gamma_{\bullet} = \Gamma_{\bullet \bullet},$$

where Γ_{\bullet} is the graph with the single vertex and no edges. Therefore,

$$(13.8) \quad H^{\bullet}(\mathbf{fGC}_{\text{conn}}^+) \cong H^{\bullet}(\mathbf{fGC}_{\text{conn}}) \oplus \mathbb{K}\langle \phi \rangle,$$

where ϕ is the cohomology class represented by the cocycle

$$\Gamma_{\bullet} - 1 \in \mathbf{fGC}_{\text{conn}}^+.$$

The map \mathfrak{R} (13.3) extends in the obvious way to the morphism of cochain complexes:

$$(13.9) \quad \mathfrak{R}^+ : \text{Conv}(\text{Ger}^{\vee}, \text{Gra})_{\text{conn}}^+ \rightarrow \mathbf{fGC}_{\text{conn}}^+.$$

Furthermore,

$$\ker(\mathfrak{R}^+) = \ker(\mathfrak{R}).$$

Thus we arrive at the diagram

$$(13.10) \quad \begin{array}{ccccccc} & & \text{Conv}(\text{Ger}^{\vee}, \text{Ger})_{\text{conn}} & & & & \\ & & \uparrow \text{emb}_{\Xi} & & & & \\ & & \Xi_{\text{conn}} & & & & \\ & & \downarrow \psi & & & & \\ \mathbf{0} & \longrightarrow & \ker(\mathfrak{R}) & \longrightarrow & \text{Conv}(\text{Ger}^{\vee}, \text{Gra})_{\text{conn}}^+ & \longrightarrow & \mathbf{fGC}_{\text{conn}}^+ \longrightarrow \mathbf{0} \end{array}$$

The bottom row of this diagram is an exact sequence of cochain complexes. The top vertical arrow emb_{Ξ} is a quasi-isomorphism due to Theorem 11.9. The vertical arrow ψ is also a quasi-isomorphism due to Proposition 13.1. Finally the cochain complex $\text{Conv}(\text{Ger}^{\vee}, \text{Gra})_{\text{conn}}^+$ in the middle of the exact sequence is acyclic.

Using diagram (13.10), we can now prove the main theorem of these notes.

THEOREM 13.2 (T. Willwacher, [42]). *If $\mathbf{fGC}_{\text{conn}}$ is the “connected part” of the full graph complex \mathbf{fGC} (8.3) and $\text{Conv}(\text{Ger}^{\vee}, \text{Ger})_{\text{conn}}$ is the “connected part” of the extended deformation complex $\text{Conv}(\text{Ger}^{\vee}, \text{Ger})$ (11.6) of the operad Ger then*

$$(13.11) \quad H^{\bullet+1}(\text{Conv}(\text{Ger}^{\vee}, \text{Ger})_{\text{conn}}) \cong H^{\bullet}(\mathbf{fGC}_{\text{conn}}) \oplus \mathbb{K}.$$

PROOF. Since the cochain complex $\text{Conv}(\text{Ger}^{\vee}, \text{Gra})_{\text{conn}}^+$ in (13.10) is acyclic, the connecting homomorphism induces an isomorphism

$$H^{\bullet}(\mathbf{fGC}_{\text{conn}}^+) \cong H^{\bullet+1}(\ker(\mathfrak{R})).$$

On the other hand,

$$H^{\bullet}(\ker(\mathfrak{R})) \cong H^{\bullet}(\Xi_{\text{conn}}) \cong H^{\bullet}(\text{Conv}(\text{Ger}^{\vee}, \text{Ger})_{\text{conn}})$$

because both ψ and $\text{emb}_{\Xi_{\text{conn}}}$ are quasi-isomorphisms.

Therefore,

$$(13.12) \quad H^{\bullet+1}(\text{Conv}(\text{Ger}^{\vee}, \text{Ger})_{\text{conn}}) \cong H^{\bullet}(\text{fGC}_{\text{conn}}^+).$$

Thus, using the isomorphism (13.8), we arrive at the desired result (13.11). \square

REMARK 13.3. The above proof gives us a concrete isomorphism from

$$(13.13) \quad H^{\bullet}(\text{fGC}_{\text{conn}}) \oplus \mathbb{K}$$

to

$$(13.14) \quad H^{\bullet+1}(\text{Conv}(\text{Ger}^{\vee}, \text{Ger})_{\text{conn}}).$$

Chasing through diagram (13.10), it is not hard to see that the vector $1 \in \mathbb{K}$ in the second summand of (13.13) is sent, via this isomorphism, to the class represented by the cocycle

$$a_1 a_2 \otimes \{b_1, b_2\}$$

or the cocycle

$$-\{a_1, a_2\} \otimes b_1 b_2$$

in $\text{Conv}(\text{Ger}^{\vee}, \text{Ger})_{\text{conn}}$.

REMARK 13.4. According to [39], the Lie algebra \mathfrak{grt} of the Grothendieck-Teichmueller group GRT embeds into $H^0(\text{Conv}(\text{Ger}^{\vee}, \text{Ger}))$. Since \mathfrak{grt} is infinite dimensional [8], the spaces $H^0(\text{Conv}(\text{Ger}^{\vee}, \text{Ger}))$ and $H^0(\text{fGC})$ are also infinite dimensional.

13.1. Proof of Proposition 13.1. Let us prove that the map

$$(13.15) \quad \psi \Big|_{\Xi_{\text{conn}}^{\oplus}} : \Xi_{\text{conn}}^{\oplus} \rightarrow \ker(\mathfrak{A}) \cap \text{Conv}(\text{Ger}^{\vee}, \text{Gra})_{\text{conn}}^{\oplus}$$

is a quasi-isomorphism of cochain complexes.

For this purpose we apply the general construction of Section 6.7 to the case when $\mathcal{O} = \text{Gra}$.

Following Section 6.7, the cochain complex $\text{Conv}(\text{Ger}^{\vee}, \text{Gra})_{\text{conn}}^{\oplus}$ carries the ascending filtration

$$(13.16) \quad \dots \subset \mathcal{F}^{m-1} \text{Conv}^{\oplus}(\text{Ger}^{\vee}, \text{Gra}) \subset \mathcal{F}^m \text{Conv}^{\oplus}(\text{Ger}^{\vee}, \text{Gra}) \subset \dots,$$

where $\mathcal{F}^m \text{Conv}^{\oplus}(\text{Ger}^{\vee}, \text{Gra})$ consists of sums

$$\sum_i v_i \otimes w_i \in \bigoplus_n (\text{Gra}(n) \otimes \Lambda^{-2} \text{Ger}(n))^{S_n}$$

which satisfy

$$\mathfrak{L}_1(w_i) - |v_i \otimes w_i| \leq m, \quad \forall i.$$

Furthermore, due to Proposition 6.17, the formula

$$(13.17) \quad \Upsilon_{\text{Gra}} \left(\sum_i v_i \otimes w_i \right) := \sum_{\sigma \in \text{Sh}_{r,n}} \sum_i \sigma(v_i) \otimes \sigma(b_1 \dots b_r w_i(b_{r+1}, \dots, b_{r+n}))$$

$$\sum_i v_i \otimes w_i \in \left(\mathfrak{s}^{2r} \text{Gra}(r+n)^{S_r} \otimes \Lambda^{-2} \text{Ger}^{\heartsuit}(n) \right)^{S_n}$$

defines an isomorphism of cochain complexes

$$(13.18) \quad \Upsilon_{\text{Gra}} : \bigoplus_{n \geq 0} \left(\text{Tw}^{\oplus} \text{Gra}(n) \otimes \Lambda^{-2} \text{Ger}^{\heartsuit}(n) \right)^{S_n} \rightarrow \text{Gr Conv}^{\oplus}(\text{Ger}^{\vee}, \text{Gra}),$$

where the differential on

$$\bigoplus_{n \geq 0} \left(\text{Tw}^{\oplus} \text{Gra}(n) \otimes \Lambda^{-2} \text{Ger}^{\heartsuit}(n) \right)^{S_n}$$

comes from the differential ∂^{Tw} on $\text{Tw}^{\oplus} \text{Gra}(n)$.

Let us restrict the filtration (13.16) to the subcomplex

$$\ker(\mathfrak{A}) \cap \text{Conv}(\text{Ger}^{\vee}, \text{Gra})_{\text{conn}}^{\oplus}$$

and recall that the n -th space

$$(13.19) \quad \mathbf{fgraphs}(n) := \mathbf{fGraphs}(n) \cap \text{Tw}^{\oplus} \text{Gra}(n)$$

of the dg operad $\mathbf{fgraphs}$ is spanned by vectors of the form

$$\sum_{\sigma \in S_r} \sigma(\Gamma),$$

where the graph $\Gamma \in \mathbf{gra}_{r+n}$ has no connected components which involve exclusively neutral vertices (i.e. vertices with labels $\leq r$).

It is not hard to see that the restriction of Υ_{Gra} to

$$\bigoplus_{n \geq 2} \left(\mathbf{fgraphs}(n) \otimes \Lambda^{-2} \text{Ger}^{\heartsuit}(n) \right)_{\text{conn}}^{S_n}$$

gives us an isomorphism

$$(13.20) \quad \Upsilon' : \bigoplus_{n \geq 2} \left(\mathbf{fgraphs}(n) \otimes \Lambda^{-2} \text{Ger}^{\heartsuit}(n) \right)_{\text{conn}}^{S_n} \rightarrow \text{Gr} \left(\ker(\mathfrak{A}) \cap \text{Conv}(\text{Ger}^{\vee}, \text{Gra})_{\text{conn}}^{\oplus} \right)$$

of cochain complexes.

On the other hand, Corollary 9.25 implies that the natural embedding

$$(13.21) \quad \Xi^{\oplus} \hookrightarrow \bigoplus_{n \geq 2} \left(\mathbf{fgraphs}(n) \otimes \Lambda^{-2} \text{Ger}^{\heartsuit}(n) \right)^{S_n}$$

is a quasi-isomorphism of cochain complexes.

Therefore, since the cone of the embedding

$$(13.22) \quad \Xi_{\text{conn}}^{\oplus} \hookrightarrow \bigoplus_{n \geq 2} \left(\mathbf{fgraphs}(n) \otimes \Lambda^{-2} \text{Ger}^{\heartsuit}(n) \right)_{\text{conn}}^{S_n}$$

is a direct summand in the cone of the embedding (13.21), the map (13.22) is also a quasi-isomorphism.

This observation allows us to conclude that the map (13.15) induces a quasi-isomorphism on the level of associated graded complexes.

Since the filtration (13.16) is locally bounded and cocomplete, Lemma A.3 implies that (13.15) is indeed a quasi-isomorphism of cochain complexes.

Thus, using the Euler characteristic trick, we conclude that the map ψ (13.4) is also a quasi-isomorphism of cochain complexes.

Proposition 13.1 is proved. \square

Appendix A. Lemma on a quasi-isomorphism of filtered complexes

Let us recall that a cone $\text{Cone}(f)$ of a morphism of cochain complexes $f : C \rightarrow K$ is the cochain complex

$$C \oplus \mathbf{s}K$$

with the differential

$$\partial^{\text{Cone}}(v_1 + \mathbf{s}v_2) = \partial(v_1) + \mathbf{s}f(v_1) - \mathbf{s}\partial(v_2),$$

where we denote by ∂ the differentials on both complexes C and K .

Let us also recall a claim which follows easily from Lemma 3 in [12, Section III.3.2]:

CLAIM A.1. *A morphism $f : C \rightarrow K$ of cochain complexes is a quasi-isomorphism if and only if the cochain complex $\text{Cone}(f)$ is acyclic. \square*

Let C be a cochain complex equipped with an ascending filtration:

$$\dots \subset \mathcal{F}^{m-1}C \subset \mathcal{F}^m C \subset \mathcal{F}^{m+1}C \subset \dots$$

We say that the filtration on C is *cocomplete* if

$$(A.1) \quad C = \bigcup_m \mathcal{F}^m C.$$

Furthermore, we say that the filtration on C is *locally bounded from the left* if for every degree d there exists an integers m_d such that

$$(A.2) \quad \mathcal{F}^{m_d} C^d = \mathbf{0}.$$

Let us denote by $\text{Gr}(C)$ the associated graded cochain complex

$$(A.3) \quad \text{Gr}(C) := \bigoplus_m \mathcal{F}^m C / \mathcal{F}^{m-1} C.$$

We will need the following claim.

CLAIM A.2. *Let C be a cochain complex equipped with a cocomplete ascending filtration which is locally bounded from the left. If $\text{Gr}(C)$ is acyclic then so is C .*

PROOF. Let v be cocycle in C of degree d . Our goal is to show that there exists a vector $w \in C^{d-1}$ such that

$$v = \partial w.$$

Since the filtration on C is cocomplete there exists an integer m such that

$$v \in \mathcal{F}^m C^d.$$

Therefore v represents a cocycle in the quotient

$$\mathcal{F}^m C^d / \mathcal{F}^{m-1} C^d.$$

On the other hand, $\text{Gr}(C)$ is acyclic. Hence there exists a vector $w_m \in \mathcal{F}^m C^{d-1}$ such that

$$(A.4) \quad v - \partial(w_m) \in \mathcal{F}^{m-1} C^d.$$

The latter implies that the vector $v - \partial(w_m)$ represents a cocycle in the quotient

$$\mathcal{F}^{m-1} C^d / \mathcal{F}^{m-2} C^d.$$

Hence, there exists a vector $w_{m-1} \in \mathcal{F}^{m-1} C^{d-1}$ such that

$$(A.5) \quad v - \partial(w_m) - \partial(w_{m-1}) \in \mathcal{F}^{m-2} C^d.$$

Continuing this process, we conclude that there exists a sequence of vectors

$$w_k \in \mathcal{F}^k C^{d-1}, \quad k \leq m$$

such that for every $k < m$ we have

$$(A.6) \quad v - \partial(w_m + w_{m-1} + \cdots + w_k) \in \mathcal{F}^{k-1} C^d.$$

Since the filtration on C is locally bounded from the left there exists an integer $k_d < m$ such that $\mathcal{F}^{k_d-1} C^d = \mathbf{0}$ and we get

$$v - \partial(w_m + w_{m-1} + \cdots + w_{k_d}) = 0.$$

The desired statement is proved. \square

We are now ready to prove the following generalization of Claim A.2.

LEMMA A.3. *Let C and K be cochain complexes equipped with cocomplete ascending filtrations which are locally bounded from the left. Let $f : C \rightarrow K$ be a morphism of cochain complexes compatible with the filtrations. If the induced map of cochain complexes*

$$\mathrm{Gr}(f) : \mathrm{Gr}(C) \rightarrow \mathrm{Gr}(K)$$

is a quasi-isomorphism then so is f .

PROOF. Let us introduce the obvious ascending filtration on the cone of f

$$\cdots \subset \mathcal{F}^{m-1} \mathrm{Cone}(f) \subset \mathcal{F}^m \mathrm{Cone}(f) \subset \mathcal{F}^{m+1} \mathrm{Cone}(f) \subset \cdots,$$

$$(A.7) \quad \mathcal{F}^m \mathrm{Cone}(f) = \mathcal{F}^m C \oplus \mathbf{s}\mathcal{F}^m K.$$

The differential ∂^{Cone} is compatible with the filtration (A.7) because f is compatible with the filtrations on C and K .

It is obvious that the filtration (A.7) is cocomplete and locally bounded from the left. Furthermore, it is not hard to see that

$$\mathrm{Gr}(\mathrm{Cone}(f)) = \mathrm{Cone}(\mathrm{Gr}(f)).$$

Therefore, Claim A.1 implies that $\mathrm{Gr}(\mathrm{Cone}(f))$ is acyclic.

Combining this observation with Claim A.2 we conclude that $\mathrm{Cone}(f)$ is also acyclic. Therefore, applying Claim A.1 once again, we deduce the statement of the lemma. \square

REMARK A.4. Lemma A.3 is often used in the literature under the folklore name ‘‘standard spectral sequence argument’’. Unfortunately, a clean proof of this fact based on the use of a spectral sequence is very cumbersome.

Appendix B. Harrison complex of the cocommutative coalgebra $S(V)$

Let V be a finite dimensional graded vector space. We consider the symmetric algebra

$$(B.1) \quad S(V)$$

as the cocommutative coalgebra with the standard comultiplication:

$$\Delta(v_1 \cdots v_n) = 1 \otimes (v_1 \cdots v_n) +$$

$$(B.2) \quad \sum_{p=1}^{n-1} \sum_{\sigma \in \mathrm{Sh}_{p, n-p}} (-1)^{\varepsilon(\sigma, v_1, \dots, v_n)} v_{\sigma(1)} \cdots v_{\sigma(p)} \otimes v_{\sigma(p+1)} \cdots v_{\sigma(n)} + (v_1 \cdots v_n) \otimes 1,$$

where v_1, \dots, v_n are homogeneous vectors in V and the sign factor $(-1)^{\varepsilon(\sigma, v_1, \dots, v_n)}$ is determined by the standard Koszul rule.

We denote by $\tilde{\Delta}$ the reduced comultiplication which is define by the formula

$$(B.3) \quad \tilde{\Delta}(X) = \Delta(X) - X \otimes 1 - 1 \otimes X$$

For example, $\tilde{\Delta}(1) = -1 \otimes 1$ and $\tilde{\Delta}(v) = 0$ for all $v \in V$.

Let us consider the free $\Lambda^{-1}\text{Lie}$ -algebra

$$(B.4) \quad \Lambda^{-1}\text{Lie}(S(V))$$

generated by $S(V)$.

Let us denote by X'_i and X''_i the tensor factors of

$$\tilde{\Delta}(X) = \sum_i X'_i \otimes X''_i$$

for a vector $X \in S(V)$ and introduce the degree 1 derivation δ of the free $\Lambda^{-1}\text{Lie}$ -algebra (B.4) by setting

$$(B.5) \quad \delta(X) = \sum_i \{X'_i, X''_i\}.$$

Due to the Jacobi identity

$$\delta^2 = 0.$$

Hence δ is a differential on (B.4) and we call

$$(B.6) \quad (\Lambda^{-1}\text{Lie}(S(V)), \delta)$$

the *Harrison complex* of $S(V)$.

It is easy to see that each non-zero vector $v \in V \subset \Lambda^{-1}\text{Lie}(S(V))$ is a non-trivial cocycle in (B.6).

The following theorem and its various versions²⁴ are often referred to as “well-known”.

THEOREM B.1. *For the Harrison complex (B.6) we have*

$$H^\bullet(\Lambda^{-1}\text{Lie}(S(V)), \delta) \cong V.$$

More precisely, for every cocycle c in (B.6) there exists a vector $v \in V \subset \Lambda^{-1}\text{Lie}(S(V))$ and a vector c_1 in (B.6) such that

$$c = v + \delta(c_1)$$

Furthermore, a vector $v \in V \subset \Lambda^{-1}\text{Lie}(S(V))$ is an exact cocycle in (B.6) if and only if $v = 0$.

PROOF. To prove this theorem we embed the suspension

$$(B.7) \quad \mathfrak{s} \Lambda^{-1}\text{Lie}(S(V)) = \text{Lie}(\mathfrak{s}S(V))$$

of (B.6) into the tensor algebra

$$(B.8) \quad T(\mathfrak{s}S(V))$$

generated by $\mathfrak{s}S(V)$.

The differential δ on (B.7) can be extended to (B.8) in the obvious way:

$$(B.9) \quad \delta(\mathfrak{s}X) = 2\mathfrak{s} \otimes \mathfrak{s}(\tilde{\Delta}(X)).$$

²⁴For a version of Theorem B.1 we refer the reader to [29, Section 3.5]. Another version of this theorem can also be deduced from statements in [35, Appendix B].

To compute the cohomology of $(T(\mathfrak{s}S(V)), \delta)$ we consider the restricted dual complex

$$(B.10) \quad (T(\mathfrak{s}^{-1}S(V')), \delta'),$$

where V' is the linear dual of V .

Since $T(\mathfrak{s}S(V))$ is a free associative algebra, it is convenient to view (B.10) as the cofree coassociative coalgebra with the comultiplication given by deconcatenation. Furthermore, since δ is a derivation of (B.8), δ' is coderivation. Therefore, δ' is uniquely determined by its composition $p \circ \delta'$ with the projection

$$p : T(\mathfrak{s}^{-1}S(V')) \rightarrow \mathfrak{s}^{-1}S(V').$$

It is easy to see that

$$(B.11) \quad p \circ \delta'(\mathfrak{s}^{-1}X_1 \otimes \cdots \otimes \mathfrak{s}^{-1}X_n) = \begin{cases} (-1)^{|X_1|-1} 2 \mathfrak{s}^{-1} \mu(X_1, X_2) & \text{if } n = 2 \\ 0 & \text{otherwise.} \end{cases}$$

Here X_1, \dots, X_n are homogeneous vectors in $S(V')$ and the map

$$\mu : S(V') \otimes S(V') \rightarrow S(V')$$

is defined by the formula

$$(B.12) \quad \mu(X_1, X_2) = X_1X_2 - \varepsilon(X_1)X_2 - X_1\varepsilon(X_2),$$

where ε is the augmentation $\varepsilon : S(V') \rightarrow \mathbb{K}$ of $S(V')$.

Using (B.11), it is not hard to see that (B.10) is the Hochschild chain complex with the reversed grading and with rescaled differential

$$C_{-\bullet}(S(V'), \mathbb{K}).$$

Hence, due to the Hochschild-Kostant-Rosenberg theorem [21], we have

$$(B.13) \quad H^\bullet(T(\mathfrak{s}^{-1}S(V')), \delta') \cong S(\mathfrak{s}^{-1}V').$$

If we view $S(\mathfrak{s}^{-1}V')$ as the subspace of $T(\mathfrak{s}^{-1}V')$ which is, in turn, a subspace of (B.10), then the Hochschild-Kostant-Rosenberg theorem can be restated as follows. For every cocycle c in (B.10) there exists a vector $X \in S(\mathfrak{s}^{-1}V')$ and a vector c_1 in (B.10) such that

$$c = X + \delta'(c_1).$$

Every vector $X \in S(\mathfrak{s}^{-1}V')$ is a cocycle in (B.10) and $X \in S(\mathfrak{s}^{-1}V')$ is an exact cocycle if and only if $X = 0$.

Let us now go back to the cochain complex (B.8) with the differential (B.9). Let us consider $S(\mathfrak{s}V)$ as the subspace of

$$T(\mathfrak{s}V) \subset T(\mathfrak{s}S(V)).$$

It is clear that every vector in $S(\mathfrak{s}V)$ is a cocycle in (B.8).

Dualizing the above statement about cocycles in (B.10) we deduce the following.

CLAIM B.2. *For every cocycle $c \in T(\mathfrak{s}S(V))$ there exists a vector $X \in S(\mathfrak{s}V)$ and a vector $c_1 \in T(\mathfrak{s}S(V))$ such that*

$$c = X + \delta(c_1).$$

Furthermore, a vector $X \in S(\mathfrak{s}V)$ is a trivial cocycle in (B.8) if and only if $X = 0$.

□

Let us now observe that, due to the PBW theorem, we have the isomorphism of graded vector spaces

$$(B.14) \quad T(\mathfrak{s}S(V)) \cong S(\mathrm{Lie}(\mathfrak{s}S(V)))$$

Moreover, the differential δ is compatible with this isomorphism. In other words, the cochain complex (B.8) is isomorphic to the symmetric algebra of the cochain complex (B.7).

Since the cochain complex $S(\mathrm{Lie}(\mathfrak{s}S(V)))$ splits into the direct sum

$$S(\mathrm{Lie}(\mathfrak{s}S(V))) = \mathbb{K} \oplus \mathrm{Lie}(\mathfrak{s}S(V)) \oplus \bigoplus_{m \geq 2} S^m(\mathrm{Lie}(\mathfrak{s}S(V)))$$

the statement of the theorem follows easily from Claim B.2. \square

Appendix C. Filtered dg Lie algebras. The Goldman-Millson theorem

In this section we prove a version of the Goldman-Millson theorem [19] which is often used in applications.

We consider a Lie algebra \mathcal{L} in the category $\mathrm{Ch}_{\mathbb{K}}$ equipped with a descending filtration

$$(C.1) \quad \mathcal{L} = \mathcal{F}_1\mathcal{L} \supset \mathcal{F}_2\mathcal{L} \supset \mathcal{F}_3\mathcal{L} \supset \dots$$

which is compatible with the Lie bracket (and the differential).

We assume that \mathcal{L} is complete with respect to this filtration. Namely,

$$(C.2) \quad \mathcal{L} = \lim_k \mathcal{L} / \mathcal{F}_k\mathcal{L}.$$

We call such Lie algebras *filtered*.

Condition (C.2) and equality $\mathcal{L} = \mathcal{F}_1\mathcal{L}$ guarantee that the subalgebra \mathcal{L}^0 of degree zero elements in \mathcal{L} is a pro-nilpotent Lie algebra (in the category of \mathbb{K} -vector spaces). Hence, \mathcal{L}^0 can be exponentiated to a pro-unipotent group which we denote by

$$(C.3) \quad \exp(\mathcal{L}^0).$$

We recall that a *Maurer-Cartan element* of \mathcal{L} is a degree 1 vector $\alpha \in \mathcal{L}$ satisfying the equation

$$(C.4) \quad \partial\alpha + \frac{1}{2}[\alpha, \alpha] = 0,$$

where ∂ denotes the differential on \mathcal{L} .

For a vector $\xi \in \mathcal{L}^0$ and a Maurer-Cartan element α we consider the new degree 1 vector $\tilde{\alpha} \in \mathcal{L}$ which is given by the formula

$$(C.5) \quad \tilde{\alpha} = \exp(\mathrm{ad}_{\xi})\alpha - \frac{\exp(\mathrm{ad}_{\xi}) - 1}{\mathrm{ad}_{\xi}}\partial\xi,$$

where the expressions

$$\exp(\mathrm{ad}_{\xi}) \quad \text{and} \quad \frac{\exp(\mathrm{ad}_{\xi}) - 1}{\mathrm{ad}_{\xi}}$$

are defined in the obvious way using the Taylor expansions of the functions

$$e^x \quad \text{and} \quad \frac{e^x - 1}{x}$$

around the point $x = 0$, respectively.

Conditions (C.2) and $\mathcal{L} = \mathcal{F}_1\mathcal{L}$ guarantee that the right hand side of equation (C.5) is defined.

It is known (see, e.g. [3, Appendix B] or [19]) that, for every Maurer-Cartan element α and for every degree zero vector $\xi \in \mathcal{L}$, the vector $\tilde{\alpha}$ in (C.5) is also a Maurer-Cartan element. Furthermore, formula (C.5) defines an action of the group (C.3) on the set of Maurer-Cartan elements of \mathcal{L} .

The transformation groupoid $\text{MC}(\mathcal{L})$ corresponding to this action is called the *Deligne groupoid* of the Lie algebra \mathcal{L} . This groupoid and its higher versions were studied extensively by E. Getzler in [14] and [15].

REMARK C.1. The transformation groupoid $\text{MC}(\mathcal{L})$ may be defined without imposing the assumption $\mathcal{L} = \mathcal{F}_1\mathcal{L}$. In this more general case, the group (C.3) should be replaced by

$$\exp(\mathcal{F}_1\mathcal{L}^0).$$

Let

$$\varphi : \mathcal{L} \rightarrow \tilde{\mathcal{L}}$$

be a homomorphism of two filtered dg Lie algebras.

It is obvious that for every Maurer-Cartan element $\alpha \in \mathcal{L}$ the vector $\varphi(\alpha)$ is a Maurer-Cartan element of $\tilde{\mathcal{L}}$. Moreover the assignment

$$\alpha \rightarrow \varphi(\alpha)$$

extends to the functor

$$(C.6) \quad \varphi_* : \text{MC}(\mathcal{L}) \rightarrow \text{MC}(\tilde{\mathcal{L}})$$

between the corresponding Deligne groupoids.

The following statement is a version of the famous Goldman-Millson theorem [19].

THEOREM C.2. *Let $\varphi : \mathcal{L} \rightarrow \tilde{\mathcal{L}}$ be a quasi-isomorphism of filtered dg Lie algebras. If the restriction*

$$\varphi \Big|_{\mathcal{F}_m\mathcal{L}} : \mathcal{F}_m\mathcal{L} \rightarrow \mathcal{F}_m\tilde{\mathcal{L}}$$

is a quasi-isomorphism for all m then the functor (C.6) induces a bijection

$$(C.7) \quad \varphi_* : \pi_0(\text{MC}(\mathcal{L})) \rightarrow \pi_0(\text{MC}(\tilde{\mathcal{L}}))$$

from the isomorphism classes of Maurer-Cartan elements in \mathcal{L} to the isomorphism classes of Maurer-Cartan elements in $\tilde{\mathcal{L}}$.

PROOF. Using the conditions of the theorem and Exercise C.3 given below, it is not hard to see that φ induces a quasi-isomorphism

$$\text{Gr}(\varphi) : \mathcal{F}_m\mathcal{L}/\mathcal{F}_{m+1}\mathcal{L} \rightarrow \mathcal{F}_m\tilde{\mathcal{L}}/\mathcal{F}_{m+1}\tilde{\mathcal{L}}$$

for all m .

In order to prove that the map (C.7) is surjective we need to show that for every Maurer-Cartan element $\beta \in \tilde{\mathcal{L}}$ there exists a vector $\xi \in \tilde{\mathcal{L}}^0$ and a Maurer-Cartan element $\alpha \in \mathcal{L}$ such that

$$(C.8) \quad \exp(\xi)(\beta) = \varphi(\alpha).$$

The Maurer-Cartan equation $\partial\beta + [\beta, \beta]/2 = 0$ implies that β represents a cocycle in

$$\mathcal{F}_1\tilde{\mathcal{L}}/\mathcal{F}_2\tilde{\mathcal{L}}.$$

Hence there exists $\alpha_1 \in \mathcal{F}_1\mathcal{L}^1$ and $\xi_1 \in \mathcal{F}_1\tilde{\mathcal{L}}^0$ such that

$$(C.9) \quad \partial\alpha_1 \in \mathcal{F}_2\mathcal{L}$$

and

$$(C.10) \quad \beta - \partial\xi_1 - \varphi(\alpha_1) \in \mathcal{F}_2\tilde{\mathcal{L}}.$$

Let us denote by β_1 the Maurer-Cartan element

$$\beta_1 = \exp(\xi_1)(\beta).$$

Inclusion (C.10) implies that

$$(C.11) \quad \beta_1 - \varphi(\alpha_1) \in \mathcal{F}_2\tilde{\mathcal{L}}.$$

We showed that there exists a vector $\xi_1 \in \mathcal{F}_1\tilde{\mathcal{L}}^0$ and a vector $\alpha_1 \in \mathcal{F}_1\mathcal{L}^1$ such that for

$$\beta_1 = \exp(\xi_1)(\beta)$$

we have inclusion (C.11) and the inclusion

$$(C.12) \quad \partial\alpha_1 + \frac{1}{2}[\alpha_1, \alpha_1] \in \mathcal{F}_2\mathcal{L},$$

which follows from (C.9). Inclusions (C.11) and (C.12) form the base of our induction.

Now we assume that there exist vectors

$$\xi_k \in \mathcal{F}_k\tilde{\mathcal{L}}^0, \quad 1 \leq k \leq m$$

and $\alpha_m \in \mathcal{F}_1\mathcal{L}$ such that

$$(C.13) \quad \partial\alpha_m + \frac{1}{2}[\alpha_m, \alpha_m] \in \mathcal{F}_{m+1}\mathcal{L},$$

and

$$(C.14) \quad \beta_m - \varphi(\alpha_m) \in \mathcal{F}_{m+1}\tilde{\mathcal{L}},$$

where

$$(C.15) \quad \beta_m = \exp(\xi_m) \dots \exp(\xi_1)(\beta).$$

Let us consider the vector

$$(C.16) \quad (\partial\varphi(\alpha_m) + \frac{1}{2}[\varphi(\alpha_m), \varphi(\alpha_m)]) - \partial(\varphi(\alpha_m) - \beta_m)$$

in $\mathcal{F}_{m+1}\tilde{\mathcal{L}}^2$.

Using the Maurer-Cartan equation for β_m we can rewrite (C.16) as

$$\begin{aligned} (\partial\varphi(\alpha_m) + \frac{1}{2}[\varphi(\alpha_m), \varphi(\alpha_m)]) - \partial(\varphi(\alpha_m) - \beta_m) &= \frac{1}{2}([\varphi(\alpha_m), \varphi(\alpha_m)] - [\beta_m, \beta_m]) = \\ &= \frac{1}{2}([\varphi(\alpha_m), \varphi(\alpha_m)] - [\varphi(\alpha_m), \beta_m] + [\varphi(\alpha_m), \beta_m] - [\beta_m, \beta_m]) = \\ &= \frac{1}{2}([\varphi(\alpha_m), \varphi(\alpha_m) - \beta_m] + [\varphi(\alpha_m) - \beta_m, \beta_m]). \end{aligned}$$

Thus (C.14) implies that vector (C.16) belongs to $\mathcal{F}_{m+2}\tilde{\mathcal{L}}^2$.

On the other hand, applying the differential ∂ to the vector

$$(\partial\varphi(\alpha_m) + \frac{1}{2}[\varphi(\alpha_m), \varphi(\alpha_m)])$$

and using (C.13) together with the Jacobi identity we conclude that

$$\partial \left(\partial\varphi(\alpha_m) + \frac{1}{2}[\varphi(\alpha_m), \varphi(\alpha_m)] \right) \in \mathcal{F}_{m+2}\tilde{\mathcal{L}}^3.$$

Combining this observation with the fact that vector (C.16) belongs to $\mathcal{F}_{m+2}\tilde{\mathcal{L}}^2$ we deduce that

$$\varphi\left(\partial\alpha_m + \frac{1}{2}[\alpha_m, \alpha_m]\right)$$

represents an exact cocycle in

$$\mathcal{F}_{m+1}\tilde{\mathcal{L}}/\mathcal{F}_{m+2}\tilde{\mathcal{L}}.$$

Therefore, there exists a vector $\gamma_{m+1} \in \mathcal{F}_{m+1}\mathcal{L}^1$ such that

$$(C.17) \quad \partial\gamma_{m+1} + \partial\alpha_m + \frac{1}{2}[\alpha_m, \alpha_m] \in \mathcal{F}_{m+2}\mathcal{L}.$$

Let us denote by α'_{m+1} the vector

$$\alpha'_{m+1} = \alpha_m + \gamma_{m+1}.$$

Combining (C.17) with the fact that vector (C.16) belongs to $\mathcal{F}_{m+2}\tilde{\mathcal{L}}^2$ we conclude that

$$\partial(\beta_m - \varphi(\alpha'_{m+1})) \in \mathcal{F}_{m+2}\tilde{\mathcal{L}}.$$

In other words, $\beta_m - \varphi(\alpha'_{m+1})$ represents a cocycle in

$$\mathcal{F}_{m+1}\tilde{\mathcal{L}}/\mathcal{F}_{m+2}\tilde{\mathcal{L}}.$$

Therefore, there exists a vector $\xi_{m+1} \in \mathcal{F}_{m+1}\tilde{\mathcal{L}}^0$ and a vector $\gamma'_{m+1} \in \mathcal{F}_{m+1}\mathcal{L}^1$ such that

$$(C.18) \quad \partial\gamma'_{m+1} \in \mathcal{F}_{m+2}\mathcal{L}^2$$

and

$$(C.19) \quad \beta_m - \partial\xi_{m+1} - \varphi(\alpha_{m+1}) - \varphi(\gamma'_{m+1}) \in \mathcal{F}_{m+2}\tilde{\mathcal{L}}.$$

We set

$$\alpha_{m+1} = \alpha'_{m+1} + \gamma'_{m+1}$$

and

$$\beta_{m+1} = \exp(\xi_{m+1})(\beta_m).$$

Combining (C.17) together with (C.18) and (C.19) we see that α_{m+1} , β_{m+1} and ξ_{m+1} satisfy the inductive assumption for m replaced by $m+1$.

Thus, we conclude that, there exist sequences of vectors

$$\alpha_m \in \mathcal{F}_1\mathcal{L}^1, \quad \alpha_{m+1} - \alpha_m \in \mathcal{F}_{m+1}\mathcal{L}^1, \quad m \geq 1$$

and

$$\xi_m \in \mathcal{F}_m\tilde{\mathcal{L}}^0, \quad m \geq 1$$

such that inclusions (C.13) and (C.14) hold for all m .

Since the filtrations on \mathcal{L} and $\tilde{\mathcal{L}}$ are complete the sequence $\{\alpha_m\}_{m \geq 1}$ converges to a vector $\alpha \in \mathcal{L}^1$ and the sequence

$$\left\{ \text{CH}\left(\xi_m, \dots, \text{CH}\left(\xi_3, \text{CH}\left(\xi_2, \xi_1\right)\right) \dots \right) \right\}_{m \geq 1}$$

converges to a vector $\xi \in \tilde{\mathcal{L}}^0$ such that

$$\partial\alpha + \frac{1}{2}[\alpha, \alpha] = 0$$

and

$$\exp(\xi)(\beta) = \varphi(\alpha).$$

We proved that the map (C.7) is surjective.

Due to Exercise C.4 below the map (C.7) is also injective. Thus the theorem is proved. \square

EXERCISE C.3. If the rows in the commutative diagram of cochain complexes

$$\begin{array}{ccccccccc} 0 & \longrightarrow & A & \longrightarrow & B & \longrightarrow & C & \longrightarrow & 0 \\ & & \downarrow & & \downarrow & & \downarrow & & \\ 0 & \longrightarrow & A' & \longrightarrow & B' & \longrightarrow & C' & \longrightarrow & 0 \end{array}$$

are exact and any 2 vertical maps are quasi-isomorphisms, then show that the third vertical map is also a quasi-isomorphism. *Hint: Consider the 5-lemma (Sec. II.5 in [12]).*

EXERCISE C.4. Prove that the map (C.7) is injective.

Appendix D. Solutions to selected exercises

Solution of Exercise 5.1. We need only to consider generators of $\mathbb{O}\mathbb{P}(\mathbf{s}\mathcal{C}_o)$ i.e. $(\mathbf{q}_n, \mathbf{s}X)$, where \mathbf{q}_n is the standard n -corolla, and $X \in \mathcal{C}_o(n)$.

By definition,

$$(D.1) \quad F(\partial^{\text{Cobar}}(\mathbf{q}_n, \mathbf{s}X)) = \partial^{\mathcal{O}} F((\mathbf{q}_n, \mathbf{s}X))$$

if and only if

$$(D.2) \quad \alpha_F(\partial^{\mathcal{C}} X) + \partial^{\mathcal{O}} \alpha_F(X) - F(\partial''(\mathbf{q}_n, \mathbf{s}X)) = 0,$$

where $\alpha_F \in \text{Conv}(\mathcal{C}, \mathcal{O})$ is the degree 1 map $\alpha_F(X) = F((\mathbf{q}_n, \mathbf{s}X))$, and

$$(D.3) \quad \partial''(\mathbf{q}_n, \mathbf{s}X) = - \sum_{z \in \pi_0(\text{Tree}_2(n))} (\mathbf{s} \otimes \mathbf{s})(\mathbf{t}_z; \Delta_{\mathbf{t}_z}(X)).$$

By definition of the differential on $\text{Conv}(\mathcal{C}, \mathcal{O})$, Eq. (D.2) holds if and only if

$$(D.4) \quad (\partial \alpha_F)(X) - F(\partial''(\mathbf{q}_n, \mathbf{s}X)) = 0,$$

Next, expanding the right-hand side of Eq. (D.3) gives:

$$\partial''(\mathbf{q}_n, \mathbf{s}X) = - \sum_{z \in \pi_0(\text{Tree}_2(n))} \sum_{\alpha} (-1)^{|X_{\alpha}^1|} (\mathbf{t}_z; \mathbf{s}X_{\alpha}^1 \otimes \mathbf{s}X_{\alpha}^2),$$

where X_{α}^1 and X_{α}^2 are tensor factors in

$$\Delta_{\mathbf{t}_z}(X) = \sum_{\alpha} X_{\alpha}^1 \otimes X_{\alpha}^2.$$

Let p_z be the number of edges terminating at the second nodal vertex of \mathbf{t}_z and let

$$\tilde{\mu}_{\mathbf{t}_z} : \mathbb{O}\mathbb{P}(\mathbf{s}\mathcal{C}_o)(n - p_z + 1) \otimes \mathbb{O}\mathbb{P}(\mathbf{s}\mathcal{C}_o)(p_z) \rightarrow \mathbb{O}\mathbb{P}(\mathbf{s}\mathcal{C}_o)(n)$$

be the multiplication map for the tree \mathbf{t}_z . By definition of multiplication for the free operad, we have

$$(\mathbf{t}_z; \mathbf{s}X_{\alpha}^1 \otimes \mathbf{s}X_{\alpha}^2) = \tilde{\mu}_{\mathbf{t}_z}((\mathbf{q}_{n-p_z+1}, \mathbf{s}X_{\alpha}^1) \otimes (\mathbf{q}_{p_z}, \mathbf{s}X_{\alpha}^2))$$

Since F is a map of operads, we have the following equalities:

$$\begin{aligned}
F(\partial''(\mathbf{q}_n, \mathbf{s}X)) &= - \sum_{z \in \pi_0(\text{Tree}_2(n))} \sum_{\alpha} (-1)^{|X_{\alpha}^1|} F(\tilde{\mu}_{\mathbf{t}_z}((\mathbf{q}_{n-p_z+1}, \mathbf{s}X_{\alpha}^1) \otimes (\mathbf{q}_{p_z}, \mathbf{s}X_{\alpha}^2))) \\
&= - \sum_{z \in \pi_0(\text{Tree}_2(n))} \sum_{\alpha} (-1)^{|X_{\alpha}^1|} \mu_{\mathbf{t}_z}(F(\mathbf{q}_{n-p_z+1}, \mathbf{s}X_{\alpha}^1) \otimes F(\mathbf{q}_{p_z}, \mathbf{s}X_{\alpha}^2)) \\
&= - \sum_{z \in \pi_0(\text{Tree}_2(n))} \sum_{\alpha} (-1)^{|X_{\alpha}^1|} \mu_{\mathbf{t}_z}(\alpha_F(X_{\alpha}^1) \otimes \alpha_F(X_{\alpha}^2)) \\
&= - \sum_{z \in \pi_0(\text{Tree}_2(n))} \mu_{\mathbf{t}_z}(\alpha_F \otimes \alpha_F \circ \Delta_{\mathbf{t}_z}(X)) \\
&= -\alpha_F \bullet \alpha_F(X) \\
&= -\frac{1}{2}[\alpha_F, \alpha_F](X).
\end{aligned}$$

By substituting this last equality into Eq. (D.4), we see Eq. (D.1) holds if and only if the Maurer-Cartan equation

$$\partial\alpha_F + \frac{1}{2}[\alpha_F, \alpha_F] = 0$$

holds for α_F . ◀

Solution of Exercise 5.7. Assume the Maurer-Cartan elements α_F and $\alpha_{\tilde{F}}$ corresponding to the maps $F, \tilde{F}: \text{Cobar}(\mathcal{C}) \rightarrow \mathcal{O}$ are isomorphic as objects of the Deligne groupoid. By definition (see Eq. (C.5)) this implies that there exists a degree 0 element $\xi \in \text{Conv}(\mathcal{C}_o, \mathcal{O})$ such that

$$\alpha_{\tilde{F}} = \exp(\text{ad}_{\xi})\alpha_F - \frac{\exp(\text{ad}_{\xi}) - 1}{\text{ad}_{\xi}}\partial\xi.$$

Define $\alpha(t) \in \text{Conv}(\mathcal{C}_o, \mathcal{O})[[t]]$ to be:

$$\alpha(t) = \exp(-t\text{ad}_{\xi})\alpha_F - \frac{\exp(-t\text{ad}_{\xi}) - 1}{\text{ad}_{\xi}}\partial\xi.$$

Since α_F and ξ are elements of $\mathcal{F}_1\text{Conv}(\mathcal{C}_o, \mathcal{O})$, and the bracket and differential are compatible with the filtration, we conclude that

$$\alpha(t) \in \text{Conv}(\mathcal{C}_o, \mathcal{O})\{t\}.$$

Note $\alpha(0) = \alpha_F$ and $\alpha(1) = \alpha_{\tilde{F}}$. Differentiation of $\alpha(t)$ gives:

$$\begin{aligned}
\frac{d\alpha(t)}{dt} &= -\text{ad}_{\xi}(\exp(-t\text{ad}_{\xi})\alpha_F) + \exp(-t\text{ad}_{\xi})\partial\xi \\
&= -\text{ad}_{\xi}(\exp(-t\text{ad}_{\xi})\alpha_F) + \exp(-t\text{ad}_{\xi})\partial\xi - \partial\xi + \partial\xi \\
&= -\text{ad}_{\xi}(\exp(-t\text{ad}_{\xi})\alpha_F) - \frac{-\text{ad}_{\xi}}{\text{ad}_{\xi}}\left(\exp(-t\text{ad}_{\xi})\partial\xi - \partial\xi\right) + \partial\xi \\
&= -\text{ad}_{\xi}\left(\exp(-t\text{ad}_{\xi})\alpha_F - \frac{\exp(-t\text{ad}_{\xi}) - 1}{\text{ad}_{\xi}}\partial\xi\right) + \partial\xi \\
&= \partial\xi - [\xi, \alpha(t)].
\end{aligned}$$

Thus, applying Prop. C.1 of [4], we conclude that

$$\partial\alpha(t) + \frac{1}{2}[\alpha(t), \alpha(t)] = 0$$

for all t .

Hence, equations (5.10), (5.11), and (5.12), which are described in the “only if” part of the proof, imply that

$$\alpha_H = \alpha(t) + \xi dt \in \text{Conv}(\mathcal{C}_o, \mathcal{O}^I)$$

is a Maurer-Cartan element that corresponds to a homotopy $H: \text{Cobar}(\mathcal{C}) \rightarrow \mathcal{O}^I$ between F and \tilde{F} . ◀

Solution of Exercise 6.15. The space

$$\mathfrak{s}^{2r}(\text{Ger}(r+n))^{S_r}$$

is spanned by vectors of the form

$$(D.5) \quad \text{Av}(w) = \sum_{\sigma \in S_r} \sigma(w)$$

where w is a monomial in $\mathfrak{s}^{2r}\text{Ger}(r+n)$.

It is clear that

$$f^{-1}(\text{Av}(w)) = w(\underbrace{a, a, \dots, a}_{r \text{ times}}, a_1, \dots, a_n).$$

So our goal is to show that

$$(D.6) \quad \partial^{\text{Tw}}(\text{Av}(w)) = \sum_{\sigma \in S_{r+1}} \sum_{i=1}^r \frac{(-1)^{e_i}}{2} w(a_{\sigma(1)}, \dots, a_{\sigma(i-1)}, \{a_{\sigma(i)}, a_{\sigma(i+1)}\}, a_{\sigma(i+2)}, \dots, a_{\sigma(r+1)}, a_{r+2}, \dots, a_{r+1+n}),$$

where the sign factor $(-1)^{e_i}$ comes from swapping the odd operator $\{a_{\sigma(i)}, \}$ with the corresponding number of brackets.

Following the definition of ∂^{Tw} (6.37) we get

$$(D.7) \quad \begin{aligned} \partial^{\text{Tw}}(\text{Av}(w)) &= \sum_{\tau \in \text{Sh}_{1,r}} \sum_{\sigma \in S_{2,\dots,r+1}} \tau(\{a_1, w(a_{\sigma(2)}, \dots, a_{\sigma(r+1)}, a_{r+2}, \dots, a_{r+1+n})\}) \\ &- \sum_{i=1}^n \sum_{\sigma \in S_r} \sum_{\tau' \in \text{Sh}_{r,1}} (-1)^{e_{r+i}} \tau'(w(a_{\sigma(1)}, \dots, a_{\sigma(r)}, a_{r+2}, \dots, a_{r+i}, \{a_{r+1}, a_{r+i+1}\}, a_{r+i+2}, \dots, a_{r+1+n})) \\ &\quad - (-1)^{|w|} \sum_{\tau \in \text{Sh}_{2,r-1}} \tau(w \circ_1 \{a_1, a_2\}) = \\ &\sum_{\sigma \in S_{r+1}} \{a_{\sigma(1)}, w(a_{\sigma(2)}, \dots, a_{\sigma(r+1)}, a_{r+2}, \dots, a_{r+1+n})\} \\ &- \sum_{i=1}^n \sum_{\sigma \in S_{r+1}} (-1)^{e_{r+i}} w(a_{\sigma(1)}, \dots, a_{\sigma(r)}, a_{r+2}, \dots, a_{r+i}, \{a_{\sigma(r+1)}, a_{r+i+1}\}, a_{r+i+2}, \dots, a_{r+1+n}) \\ &- \sum_{\tau \in \text{Sh}_{2,r-1}} \sum_{\sigma \in S_{3,\dots,r+1}} \sum_{i=1}^r (-1)^{e_i} \tau \circ \sigma(w(a_3, \dots, a_{i+1}, \{a_1, a_2\}, a_{i+2}, \dots, a_{r+1+n})), \end{aligned}$$

where we used the obvious identity

(D.8)

$$\text{Av}(w) = \sum_{\sigma \in S_{2, \dots, r}} \sum_{i=1}^r w(a_{\sigma(2)}, \dots, a_{\sigma(i)}, a_1, a_{\sigma(i+1)}, \dots, a_{\sigma(r)}, a_{r+1}, \dots, a_{r+n}).$$

Using the defining identities of Gerstenhaber algebra we simplify (D.7) further

(D.9)

$$\begin{aligned} \partial^{\text{Tw}}(\text{Av}(w)) &= \\ & \sum_{\sigma \in S_{r+1}} \sum_{i=2}^{r+1} (-1)^{e_i} w(a_{\sigma(2)}, \dots, a_{\sigma(i-1)}, \{a_{\sigma(1)}, a_{\sigma(i)}\}, a_{\sigma(i+1)}, \dots, a_{\sigma(r+1)}, a_{r+2}, \dots, a_{r+1+n}) \\ & - \sum_{\sigma \in S_{r+1}} \sum_{i=1}^r (-1)^{e_i} w(a_{\sigma(3)}, \dots, a_{\sigma(i+1)}, \{a_{\sigma(1)}, a_{\sigma(2)}\}, a_{\sigma(i+2)}, \dots, a_{\sigma(r+1)}, a_{r+2}, \dots, a_{r+1+n}) = \\ & \sum_{\sigma \in S_{r+1}} \sum_{i=2}^{r+1} (-1)^{e_i} w(a_{\sigma(2)}, \dots, a_{\sigma(i-1)}, \{a_{\sigma(1)}, a_{\sigma(i)}\}, a_{\sigma(i+1)}, \dots, a_{\sigma(r+1)}, a_{r+2}, \dots, a_{r+1+n}) \\ & - \sum_{\sigma \in S_{r+1}} \sum_{i=1}^r \frac{(-1)^{e_i}}{2} w(a_{\sigma(3)}, \dots, a_{\sigma(i+1)}, \{a_{\sigma(1)}, a_{\sigma(2)}\}, a_{\sigma(i+2)}, \dots, a_{\sigma(r+1)}, a_{r+2}, \dots, a_{r+1+n}) = \\ & \sum_{\sigma \in S_{r+1}} \sum_{i=1}^r \frac{(-1)^{e_i}}{2} w(a_{\sigma(3)}, \dots, a_{\sigma(i+1)}, \{a_{\sigma(1)}, a_{\sigma(2)}\}, a_{\sigma(i+2)}, \dots, a_{\sigma(r+1)}, a_{r+2}, \dots, a_{r+1+n}) = \\ & \sum_{\sigma \in S_{r+1}} \sum_{i=1}^r \frac{(-1)^{e_i}}{2} w(a_{\sigma(1)}, \dots, a_{\sigma(i-1)}, \{a_{\sigma(i)}, a_{\sigma(i+1)}\}, a_{\sigma(i+2)}, \dots, a_{\sigma(r+1)}, a_{r+2}, \dots, a_{r+1+n}). \end{aligned}$$

Thus equation (D.6) indeed holds and the desired statement follows. ◀

Solution of Exercise 9.26. According to the formula for ∂^{Tw} given in Eq. (9.6) we have

$$(D.10) \quad \partial^{\text{Tw}}\Gamma_{\circ\circ} = \text{Av}_1(\Gamma_{\bullet\bullet} \circ_2 \Gamma_{\circ\circ}) - \text{Av}_1(\Gamma_{\circ\circ} \circ_1 \Gamma_{\bullet\bullet} + \varsigma_{1,2}(\Gamma_{\circ\circ} \circ_2 \Gamma_{\bullet\bullet})),$$

where $\varsigma_{1,2}$ is the cycle $(12) \in S_3$. Recall that, in the right hand side of (D.10), both graphs $\Gamma_{\bullet\bullet}$ and $\Gamma_{\circ\circ}$ are viewed as vectors in $\text{Gra}(2)$, while the final result of the computation is treated as a vector in $\text{TwGra}(2)$. In particular, the colors of vertices play a role only for the final result of the computation. (See also Remark 9.3.)

Expanding the terms on the right hand side gives the following equalities:

$$\begin{aligned} \Gamma_{\bullet\bullet} \circ_2 \Gamma_{\circ\circ} &= \begin{array}{c} \bullet \text{---} \circ \\ 1 \quad 2 \end{array} \quad \begin{array}{c} \circ \\ 3 \end{array} \quad + \quad \begin{array}{c} \bullet \text{---} \circ \\ 1 \quad 3 \end{array} \quad \begin{array}{c} \circ \\ 2 \end{array} \\ \Gamma_{\circ\circ} \circ_1 \Gamma_{\bullet\bullet} &= \begin{array}{c} \bullet \text{---} \circ \\ 1 \quad 2 \end{array} \quad \begin{array}{c} \circ \\ 3 \end{array} \\ \varsigma_{1,2}(\Gamma_{\circ\circ} \circ_2 \Gamma_{\bullet\bullet}) &= \begin{array}{c} \bullet \text{---} \circ \\ 1 \quad 3 \end{array} \quad \begin{array}{c} \circ \\ 2 \end{array} \end{aligned}$$

Hence, all terms cancel on the right hand side of Eq. (D.10), and therefore $\partial^{\text{Tw}}\Gamma_{\circ\circ} = 0$.

Next, applying the differential ∂^{Tw} to $\Gamma_{\circ\circ} \in \text{TwGra}(2)$, we get

$$(D.11) \quad \partial^{\text{Tw}}\Gamma_{\circ\circ} = \text{Av}_1(\Gamma_{\bullet\bullet} \circ_2 \Gamma_{\circ\circ}) + \text{Av}_1(\Gamma_{\circ\circ} \circ_1 \Gamma_{\bullet\bullet} + \varsigma_{1,2}(\Gamma_{\circ\circ} \circ_2 \Gamma_{\bullet\bullet})).$$

We expand the terms on the right hand side, being mindful of the ordering on edges, and Remark 9.3.

$$\begin{aligned}
 \Gamma_{\bullet\bullet} \circ_2 \Gamma_{\circ\circ} &= \begin{array}{c} i \\ \bullet \text{---} \bullet \\ 1 \quad 2 \end{array} \circ_2 \begin{array}{c} ii \\ \circ \text{---} \circ \\ 1 \quad 2 \end{array} = \begin{array}{c} i \quad ii \\ \bullet \text{---} \circ \text{---} \circ \\ 1 \quad 2 \quad 3 \end{array} + \begin{array}{c} i \quad ii \\ \bullet \text{---} \circ \text{---} \circ \\ 1 \quad 3 \quad 2 \end{array} \\
 \Gamma_{\circ\circ} \circ_1 \Gamma_{\bullet\bullet} &= \begin{array}{c} i \\ \circ \text{---} \circ \\ 1 \quad 2 \end{array} \circ_1 \begin{array}{c} ii \\ \bullet \text{---} \bullet \\ 1 \quad 2 \end{array} = \begin{array}{c} ii \quad i \\ \bullet \text{---} \circ \text{---} \circ \\ 1 \quad 2 \quad 3 \end{array} + \begin{array}{c} ii \quad i \\ \circ \text{---} \bullet \text{---} \circ \\ 2 \quad 1 \quad 3 \end{array} \\
 \varsigma_{1,2}(\Gamma_{\circ\circ} \circ_2 \Gamma_{\bullet\bullet}) &= \varsigma_{1,2}(\begin{array}{c} i \\ \circ \text{---} \circ \\ 1 \quad 2 \end{array} \circ_2 \begin{array}{c} ii \\ \bullet \text{---} \bullet \\ 1 \quad 2 \end{array}) = \begin{array}{c} i \quad ii \\ \circ \text{---} \circ \text{---} \bullet \\ 2 \quad 3 \quad 1 \end{array} + \begin{array}{c} i \quad ii \\ \circ \text{---} \bullet \text{---} \circ \\ 2 \quad 1 \quad 3 \end{array}
 \end{aligned}$$

By definition of the operad Gra , we have the following equalities in $\text{Gra}(1+2)$:

$$\begin{aligned}
 \begin{array}{c} i \quad ii \\ \bullet \text{---} \bullet \text{---} \bullet \\ 1 \quad 2 \quad 3 \end{array} &= - \begin{array}{c} ii \quad i \\ \bullet \text{---} \bullet \text{---} \bullet \\ 1 \quad 2 \quad 3 \end{array} \\
 \begin{array}{c} i \quad ii \\ \bullet \text{---} \bullet \text{---} \bullet \\ 1 \quad 3 \quad 2 \end{array} &= - \begin{array}{c} i \quad ii \\ \bullet \text{---} \bullet \text{---} \bullet \\ 2 \quad 3 \quad 1 \end{array} \\
 \begin{array}{c} ii \quad i \\ \bullet \text{---} \bullet \text{---} \bullet \\ 2 \quad 1 \quad 3 \end{array} &= - \begin{array}{c} i \quad ii \\ \bullet \text{---} \bullet \text{---} \bullet \\ 2 \quad 1 \quad 3 \end{array}
 \end{aligned}$$

Thus, in $\text{TwGra}(2)$, we have:

$$\begin{aligned}
 \begin{array}{c} i \quad ii \\ \bullet \text{---} \circ \text{---} \circ \\ 1 \quad 2 \quad 3 \end{array} &= - \begin{array}{c} ii \quad i \\ \bullet \text{---} \circ \text{---} \circ \\ 1 \quad 2 \quad 3 \end{array} \\
 \begin{array}{c} i \quad ii \\ \bullet \text{---} \circ \text{---} \circ \\ 1 \quad 3 \quad 2 \end{array} &= - \begin{array}{c} i \quad ii \\ \circ \text{---} \circ \text{---} \bullet \\ 2 \quad 3 \quad 1 \end{array} \\
 \begin{array}{c} ii \quad i \\ \circ \text{---} \bullet \text{---} \circ \\ 2 \quad 1 \quad 3 \end{array} &= - \begin{array}{c} i \quad ii \\ \circ \text{---} \bullet \text{---} \circ \\ 2 \quad 1 \quad 3 \end{array}
 \end{aligned}$$

Hence, all terms on the right hand side of Eq. (D.11) cancel, and therefore $\partial^{\text{Tw}}\Gamma_{\circ\circ} = 0$. \blacktriangleleft

References

1. A. Alekseev and C. Torossian, The Kashiwara-Vergne conjecture and Drinfeld’s associators, *Annals of Math.* **175**, 2 (2012) 415–463; arXiv:0802.4300.
2. C. Berger and I. Moerdijk, Axiomatic homotopy theory for operads, *Comment. Math. Helv.* **78**, 4 (2003) 805–831; arXiv:math/0206094.
3. H. Bursztyn, V. Dolgushev, and S. Waldmann, Morita equivalence and characteristic classes of star products, accepted to *J. Reine Angew. Math.*; arXiv:0909.4259.
4. V.A. Dolgushev, Stable formality quasi-isomorphisms for Hochschild cochains I, arXiv:1109.6031.
5. V.A. Dolgushev, Stable formality quasi-isomorphisms for Hochschild cochains II, in preparation.
6. V. A. Dolgushev, D. E. Tamarkin, and B. L. Tsygan, Proof of Swiss Cheese Version of Deligne’s Conjecture, *Int. Math. Res. Notices* **2011** (2011) 4666–4746.
7. V.A. Dolgushev and T. H. Willwacher, Compatibility of solutions of Deligne’s conjecture with twisting, in preparation.

8. V.G. Drinfeld, On quasitriangular quasi-Hopf algebras and on a group that is closely connected with $\text{Gal}(\overline{\mathbb{Q}}/\mathbb{Q})$. (Russian) *Algebra i Analiz* **2**, 4 (1990) 149–181; translation in *Leningrad Math. J.* **2**, 4 (1991) 829–860.
9. B. Fresse, Koszul duality of operads and homology of partition posets, in "Homotopy theory and its applications (Evanston, 2002)", *Contemp. Math.* **346** (2004) 115–215.
10. B. Fresse, Operads and Grothendieck-Teichmueller groups, the text is available at <http://math.univ-lille1.fr/~fresse/Recherches.html>
11. H. Furusho, Four groups related to associators, Preprint: arXiv:1108.3389.
12. S.I. Gelfand and Yu. I. Manin, *Methods of homological algebra*. Second edition. *Springer Monographs in Mathematics*. Springer-Verlag, Berlin, 2003.
13. M. Gerstenhaber, The cohomology structure of an associative ring, *Annals of Math.*, **78** (1963) 267–288.
14. E. Getzler, A Darboux theorem for Hamiltonian operators in the formal calculus of variations, *Duke Math. J.* **111** (2002) 535–560.
15. E. Getzler, Lie theory for nilpotent L_∞ -algebras, *Ann. of Math. (2)* **170**, 1 (2009) 271–301.
16. E. Getzler and J.D.S. Jones, Operads, homotopy algebra and iterated integrals for double loop spaces, hep-th/9403055.
17. E. Getzler and M. M. Kapranov, Cyclic operads and cyclic homology, *Geometry, topology, and physics*, 167–201, *Conf. Proc. Lecture Notes Geom. Topology, IV*, Int. Press, Cambridge, MA, 1995.
18. V. Ginzburg and M. Kapranov, Koszul duality for operads, *Duke Math. J.* **76**, 1 (1994) 203–272.
19. W. M. Goldman and J.J. Millson, The deformation theory of representations of fundamental groups of compact Kähler manifolds, *Inst. Hautes Etudes Sci. Publ. Math.*, **67** (1988) 43–96.
20. V. Hinich, Tamarkin's proof of Kontsevich formality theorem, *Forum Math.* **15**, 4 (2003) 591–614; math.QA/0003052.
21. G. Hochschild, B. Kostant, and A. Rosenberg, Differential forms on regular affine algebras, *Trans. Amer. Math. Soc.* **102** (1962) 383–408.
22. M. Kontsevich, Deformation quantization of Poisson manifolds, *Lett. Math. Phys.*, **66** (2003) 157–216; q-alg/9709040.
23. M. Kontsevich, Formality conjecture, *Deformation theory and symplectic geometry* (Ascona, 1996), 139–156, *Math. Phys. Stud.*, 20, Kluwer Acad. Publ., Dordrecht, 1997.
24. M. Kontsevich, Operads and motives in deformation quantization, Moshé Flato (1937–1998). *Lett. Math. Phys.* **48**, 1 (1999) 35–72.
25. M. Kontsevich and Y. Soibelman, Deformations of algebras over operads and the Deligne conjecture, *Proceedings of the Moshé Flato Conference Math. Phys. Stud.* **21**, 255–307, Kluwer Acad. Publ., Dordrecht, 2000.
26. P. Lambrechts and I. Volic, Formality of the little N -disks operad, arXiv:0808.0457
27. J.-L. Loday and B. Vallette, Algebraic Operads, *Grundlehren der mathematischen Wissenschaften*, **346**, Springer-Verlag, 2012.
28. Tom Leinster, Homotopy algebras for operads, arXiv:math/0002180.
29. J.-L. Loday, Cyclic homology, *Grundlehren der Mathematischen Wissenschaften* 301. Springer-Verlag, Berlin, 1998.
30. J. Lurie, Higher Algebra, draft is available at <http://www.math.harvard.edu/~lurie/>
31. M. Markl, Homotopy algebras are homotopy algebras, *Forum Math.* **16**, 1 (2004) 129–160.
32. M. Markl, Operads and PROPs, *Handbook of algebra*. Vol. 5, 87–140, Elsevier/North-Holland, Amsterdam, 2008; arXiv:math/0601129.
33. J. E. McClure and J. H. Smith, A solution of Deligne's Hochschild cohomology conjecture, *Contemp. Math.* **293** (2002) 153–193, Amer. Math. Soc., Providence, RI; math.QA/9910126.
34. S. Merkulov and B. Vallette, Deformation theory of representations of prop(erad)s I and II, *J. Reine Angew. Math.* **634** (2009) 51–106; **636** (2009), 123–174.
35. D. Quillen, Rational homotopy theory, *Ann. of Math. (2)* **90** (1969) 205–295.
36. J.-P. Serre, How to Write Mathematics Badly, The lecture is currently available at http://www.dailymotion.com/video/xf88b5_jean-pierre-serre-writing-mathemati_tech
37. D. Tamarkin, Another proof of M. Kontsevich formality theorem, math.QA/9803025.
38. D. Tamarkin, Formality of chain operad of small squares, *Lett. Math. Phys.* **66**, 1-2 (2003) 65–72; math.QA/9809164.

39. D. Tamarkin, Action of the Grothendieck-Teichmüller group on the operad of Gerstenhaber algebras, arXiv:math/0202039.
40. C. A. Weibel, An introduction to homological algebra, *Cambridge Studies in Advanced Mathematics*, 38. Cambridge University Press, Cambridge, 1994.
41. T. Willwacher, A Note on Br-infinity and KS-infinity formality, arXiv:1109.3520.
42. T. Willwacher, M. Kontsevich's graph complex and the Grothendieck-Teichmüller Lie algebra, arXiv:1009.1654.

DEPARTMENT OF MATHEMATICS, TEMPLE UNIVERSITY,, WACHMAN HALL RM. 638, 1805 N. BROAD ST., PHILADELPHIA PA, 19122 USA
E-mail address: `vald@temple.edu`

COURANT RESEARCH CENTRE, "HIGHER ORDER STRUCTURES IN MATHEMATICS", UNIVERSITY OF GÖTTINGEN, BUNSENSTRASSE 3-5, D-37073 GÖTTINGEN, GERMANY
E-mail address: `crogers@uni-math.gwdg.de`