

Pencils of cubics with eight base points lying in convex position in $\mathbb{R}P^2$

Séverine Fiedler-Le Touzé

March 14, 2022

Abstract

To a generic configuration of eight points in convex position in the real plane, we associate a *list* consisting of the following information: for all of the 56 conics determined by five of the points, we specify the position of each of the three remaining points, inside or outside. We prove that the number of possible lists, up to the action of D_8 on the set of points, is 47, and we give two possible ways of encoding these lists. A generic complex pencil of cubics has twelve singular (nodal) cubics and nine distinct base points, any eight of them determine the ninth one, hence the pencil. If the base points are real, exactly eight of these singular cubics are distinguished, that is to say real with a loop containing some base points. We call combinatorial cubic a topological type (cubic, base points), and combinatorial pencil the sequence of eight successive combinatorial distinguished cubics. Let us choose representants of the 47 orbits. In most cases, but four exceptions, a list determines a unique combinatorial pencil. We get a complete classification of the combinatorial pencils of cubics with eight base points in convex position. Up to the action of D_8 on the set of points, there are 43 such pencils.

1 Pencils of cubics

1.1 Preliminaries

Given nine generic points in $\mathbb{C}P^2$, there exists one single cubic passing through them. Given eight generic points in $\mathbb{C}P^2$, there exists a one-parameter family of cubics passing through them. We will call such a family a *pencil of cubics*. Let F_0 and F_1 be two cubics of a pencil \mathcal{P} . They intersect at a ninth point. As the other cubics of \mathcal{P} are linear combinations of F_0 and F_1 , they all pass through this ninth point. We call these nine points the *base points* of \mathcal{P} . If eight of the base points are real, the pencil is real, and hence the ninth base point is also real. A pencil of cubics is a line in the space $\mathbb{C}P^9$ of complex cubics. Let Δ be the discriminantal hypersurface of $\mathbb{C}P^9$, formed by the singular cubics. The hypersurface Δ is of degree 12. Hence, a generic pencil of cubics intersects Δ transversally at 12 regular points. Otherwise stated, a generic pencil \mathcal{P} has

exactly 12 singular (nodal) cubics. A non-generic pencil will be called *singular pencil*. Let \mathcal{P} be a real pencil with nine real base points and denote the real part of \mathcal{P} by $\mathbb{R}\mathcal{P}$. Let $n \leq 12$ be the number of real singular cubics of \mathcal{P} . Let C_3 be one of these cubics. The double point P of C_3 is *isolated* if the tangents to C_3 at P are non-real, otherwise P is *non-isolated*. If P is non-isolated, $C_3 \setminus P = \mathcal{J} \cup \mathcal{O}$, where $[\mathcal{J} \cup P] \neq 0$ and $[\mathcal{O} \cup P] = 0$ in $H_1(\mathbb{R}P^2)$. We say that \mathcal{O} is the loop and \mathcal{J} is the odd component of C_3 . Notice that the loop \mathcal{O} is convex. The estimation of n presented hereafter is due to V.Kharlamov, see [2].

One has: $n = n_1 + n_2 + n_3$, where n_1 is the number of cubics with an isolated double point, n_2 is the number of cubics with a loop containing no base points, and n_3 is the number of cubics with a loop containing some base points. To evaluate n , one recalculates the Euler characteristic of $\mathbb{R}P^2$, fibering $\mathbb{R}P^2$ with the cubics of $\mathbb{R}\mathcal{P}$. Each isolated double point, and each base point contributes by $+1$; and each non-isolated double point contributes by -1 , so that one gets:

$$1 = \chi(\mathbb{R}P^2) = 9 + n_1 - (n - n_1)$$

So, $n - 2n_1 = 8$. Thus, $n = 8, 10$ or 12 and correspondingly, $n_1 = 0, 1$ or 2 .

Consider a motion in $\mathbb{R}\mathcal{P}$ starting from a cubic with an isolated double point. If we choose the direction of the motion properly, an oval appears, grows, and attaches itself to the odd component, forming a loop that contains no base point. Conversely, starting from a cubic with a loop containing no base point, one can move in the pencil so that there appears a cubic with an oval. As this oval lies inside of the loop, it shrinks when one moves further, and degenerates into an isolated double point. Thus, $n_2 = n_1$ and $n_3 = 8$ independently of n . Let us call the eight cubics of the third type the *distinguished cubics* of \mathcal{P} . We shall picture $\mathbb{R}\mathcal{P}$ by a circle, divided in eight portions by the eight distinguished cubics. Let us remark that this number $n_3 = 8$ is the Welschinger invariant W_3 , see [9]. The number of real rational plane curves of degree d going through $3d-1$ generic points of $\mathbb{R}P^2$ is always finite. Let c_1 be the number of such curves with an even number of isolated nodes, and c_2 be the number of such curves with an odd number of isolated nodes. Welschinger proved that the difference $W_d = c_1 - c_2$ does not depend on the choice of the $3d-1$ points. Let $1, \dots, 8$ be eight generic points in $\mathbb{R}P^2$, determining a pencil of cubics \mathcal{P} . Let 9 be the ninth base point, and C_3 be a real cubic of \mathcal{P} . We call *combinatorial cubic* C_3 the topological type of $(C_3, 1, \dots, 9)$, and *combinatorial pencil* the cyclic sequence of the successive eight combinatorial distinguished cubics. From now on, the same notation $\mathcal{P} = \mathcal{P}(1, \dots, 8)$ will refer to the (real part of the) pencil of cubics determined by $1, \dots, 8$, and to the combinatorial pencil. It will always be clear from the context whether we speak of a combinatorial or of an actual pencil.

Theorem 1 *Up to the action of D_8 , eight generic points $1, \dots, 8$ lying in convex position in $\mathbb{R}P^2$ may realize 43 combinatorial pencils $\mathcal{P}(1, \dots, 8)$.*

1.2 Singular pencils

Let \mathcal{P} be an (actual) pencil of cubics with only real base points. Move these points till \mathcal{P} degenerates into a singular pencil \mathcal{P}_{sing} . The degeneration is generic if and only if \mathcal{P}_{sing} intersects Δ transversally at 10 regular points and

1. \mathcal{P}_{sing} is tangent to Δ at one regular point, or
2. \mathcal{P}_{sing} crosses transversally a stratum of codimension 1 of Δ

In both cases, two singular cubics C_3^1 and C_3^2 of \mathcal{P} come together to yield one singular cubic C_3^0 of \mathcal{P}_{sing} . The cubic C_3^0 is necessarily real, the cubics C_3^1 and C_3^2 are either both real or complex conjugated. Let F be a generic cubic of Δ with node at some point p , then $T_F\Delta = \{F + G \mid G(p) = 0\}$. Therefore, \mathcal{P}_{sing} satisfies the condition 1) if and only if \mathcal{P}_{sing} has a double base point, at p . Otherwise stated, \mathcal{P}_{sing} is obtained from \mathcal{P} by letting two base points A and B of \mathcal{P} come together. Move A towards B along the line (AB) . For simplicity, we assume that B is the origin $(0,0)$ of the plane, and the direction is the x -axis. The condition that some cubic H passes through A and B becomes at the limit: $H(0,0) = 0$ and $\frac{\partial H}{\partial x}(0,0) = 0$. All of the cubics of \mathcal{P}_{sing} but one are tangent to the x -axis. A unique cubic C_3^0 is singular at $A = B$ (for this cubic, the other partial derivative $\frac{\partial H}{\partial y}(0,0)$ is also equal to 0). In case 2), the cubic C_3^0 must be reducible (product of a line and a conic), or have a cusp. If C_3^0 is reducible, the genericity imposes that three of the base points lie on the line, and the other six lie on the conic. If C_3^0 has a cusp, the cubics C_3^1 and C_3^2 are either non-distinguished real cubics, one with a loop, the other with an isolated double point, or complex conjugated. See Figure 1, where the various possible types for the degeneration $\mathcal{P} \rightarrow \mathcal{P}_{sing}$ have been denoted by 1a, 1b, 2a, 2b, 2c, 2d. In the right-hand part of the figure, the dotted crosses symbolize the non-real nodes of the cubics C_3^1 and C_3^2 . Moving further, one gets a new pencil \mathcal{P}' . The cubic C_3^0 is replaced by a new pair of nodal cubics C_3^3, C_3^4 . If $\mathcal{P} \rightarrow \mathcal{P}_{sing}$ realizes one of the types 1a, 1b, 2a or 2b, $\mathcal{P}' \rightarrow \mathcal{P}_{sing}$ is of the same type, whereas the types 2c and 2d are swapped.

Let us describe more precisely the case 1). We call *elementary arc* AB an arc connecting A to B and containing no other base point. As \mathcal{P} can degenerate into \mathcal{P}_{sing} letting A and B come together, some cubics of \mathcal{P} must have an elementary arc AB . Start from such a cubic and move in any direction in $\mathbb{R}\mathcal{P}$. At some moment, the mobile arc AB must glue to another arc, and then disappear. Thus \mathcal{P} has two distinguished cubics corresponding to the openings of the arc AB . We call *singular elementary arc* AB the non-smooth arc AB of either of these cubics. For 1a, these two cubics are C_3^1 and C_3^2 , they come together to yield the cubic C_3^0 , which has a non-isolated double point at $A = B$. All three combinatorial cubics C_3^0, C_3^1 and C_3^2 are identical outside of a neighbourhood of $A \cup B$. Note that the pair of cubics C_3^1, C_3^2 divide the pencil $\mathbb{R}\mathcal{P}$ in two portions, in one portion, the cubics have an elementary arc AB , in the other they have none. The latter portion disappears in the motion $\mathcal{P} \rightarrow \mathcal{P}_{sing}$. For 1b, the two cubics corresponding to the opening of AB divide the pencil in two portions,

the cubics in each portion have respectively one and two elementary arc(s) AB . The cubics of the latter portion have all an oval passing through A, B , and no other base point. When the motion reaches \mathcal{P}_{sing} , a nodal cubic C_3^0 appears inside of this portion. Percoursing this portion, one sees the oval shrink till it becomes an isolated node. Then the oval reappears on the other side and grows.

Let us finally mention that eight points in $\mathbb{R}P^2$ determine a pencil of cubics, with a ninth base point, if and only if no four of the eight points are aligned, and no seven are coconic. If three of the points are aligned, the ninth base point lies on the conic determined by the five others; if six points are coconic, the ninth base point is on the line determined by the other two: the pencil is singular. If four points are aligned, one gets a pencil of reducible cubics, product of the line and the pencil of conics determined by the other four points. If seven points are coconic, one gets again a pencil of reducible cubics, product of the conic and the pencil of lines through the remaining point. If two points coincide, say A and B , one gets a one-parameter family of singular pencils: consider the cubic C_3^0 through $1, \dots, 8$, with node at $A = B$. The ninth point 9 may be chosen anywhere on this cubic. Finally, six generic points $1, \dots, 6$ in $\mathbb{R}P^2$ determine six rational pencils, with respective nodes at $1, \dots, 6$. Each pencil has five reducible cubics. Let us call *combinatorial cubic* C_3 a topological type $(C_3, 1, \dots, 6)$ and *combinatorial pencil* the cyclic sequence of five combinatorial reducible cubics. Up to the action of \mathcal{S}_6 on $1, \dots, 6$, there are four lists of six combinatorial pencils, [6].

2 Configurations of eight points lying in convex position in $\mathbb{R}P^2$, lists of conics

2.1 Mutual position of points and conics

We say that n points lie in convex position in $\mathbb{R}P^2$ if there exists a line $L \subset \mathbb{R}P^2$ such that the n points lie in convex position in the affine plane $\mathbb{R}P^2 \setminus L$. Note that any set of $n \leq 5$ points in $\mathbb{R}P^2$ lie in convex position. Consider $n \geq 5$ generic points lying in strictly convex position in $\mathbb{R}P^2$, say $1, \dots, n$. Let $L(1, \dots, n)$ be the list of the $\binom{n}{5}$ conics through five of these points, enhanced for each conic, with the position of each of the remaining $n - 5$ points (inside or outside). So a (generic) list, written in full extent, consists of $(n - 5) \times \binom{n}{5}$ elementary data of the type $k < C_2$ (k lies inside of the conic C_2) or $k > C_2$ (k lies outside of C_2). In section 4, we will consider also non-generic configuration of points $1, \dots, 8$ with six of them on a conic, and the corresponding non-generic lists

How many different possibilities can be realized by $L(1, \dots, n)$ when one lets the points $1, \dots, n$ move?

For $n = 6$, note that the condition $6 > 12345$ is equivalent to $5 < 12346$. One single elementary data determines $L(1, \dots, 6)$. There are two lists: $6 < 12345$ and $6 > 12345$. We write shortly: $\sharp L(1, \dots, 6) = 2$. The two lists, written in full extent are displayed in Figure 2.

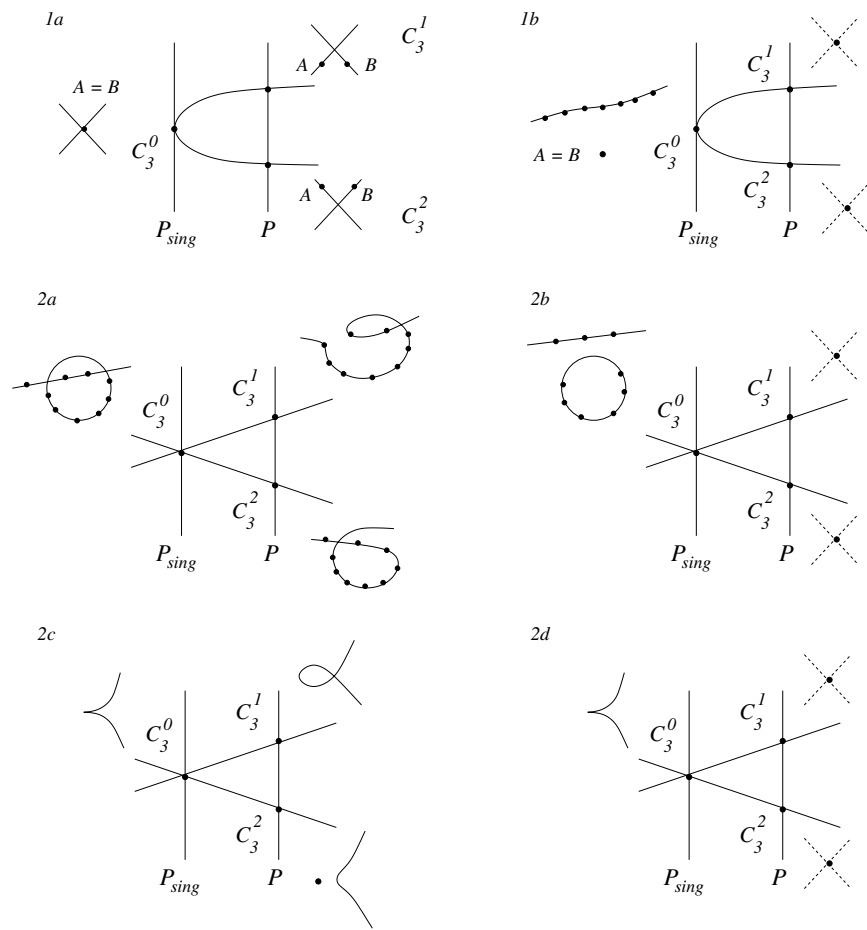

Figure 1: The degeneration of \mathcal{P} into \mathcal{P}_{sing}

$L(1, \dots, 6)$				
C_2	in	out	in	out
12345	6			6
12346		5	5	
12356	4			4
12456		3	3	
13456	2			2
23456		1	1	

Figure 2: The two lists $L(1, \dots, 6)$

Let now $n = 7$. Let C_3 be a cubic passing through the points $1, \dots, 7$. By abuse of language we will also call *cubic* C_3 the topological type of $(C_3, 1, \dots, 7)$. Let F be the equation of C_3 and p be a point among $1, \dots, 7$. The condition $F(p) = 0$ is a linear equation in the coefficients of F . If p is a singular point of C_3 , one gets two supplementary linear equations: $\frac{\partial F}{\partial x}(p) = 0$ and $\frac{\partial F}{\partial y}(p) = 0$. Thus, as $1, \dots, 7$ are generic, there exists exactly one real nodal cubic passing through $1, \dots, 7$ and having p as double point. Let $S(1, \dots, 7)$ be the list of the seven nodal cubics passing through the points $1, \dots, 7$, one of them being the double point. Denote by $C_3(k)$ the cubic with node at k . We may ask the same question as above, replacing $L(1, \dots, 7)$ by $S(1, \dots, 7)$.

Proposition 1 $\natural L(1, \dots, 7) = \natural S(1, \dots, 7) = 14$.

The fourteen lists $S(1, \dots, 7)$ are denoted by $1\pm, 2\pm, \dots, 7\pm$, they are all equivalent up to the action of the dihedral group D_7 .

The combinatorial informations $S(1, \dots, 7)$ and $L(1, \dots, 7)$ are equivalent, and determined by only two elementary data: $S(1, \dots, 7) = 1+$ if and only if $7 < 23456$ and $1 > 23456$.

The lists $1+$ and $1-$ are shown in Figure 3; the other lists $n\pm$ are obtained from $1\pm$ performing on $1, \dots, 7$ the cyclic permutation that replaces 1 by n . (The double point of the last cubic in each list may be an isolated node or a crossing. If it is a crossing, the loop is attached to the arc 61 of the odd branch, as shown in the Figure, or to the arc 12.) Note that any of the five non-extremal cubics of the list $S(1, \dots, 7)$ determines the whole of this list. Let us denote by $C_3(k)$ the cubic with node at k .

Proof: The first six points $1, \dots, 6$ may realize two different lists $L(1, \dots, 6)$.

For either of them, there are seven possible positions of the point 7 with respect to the set of conics passing through five points among $1, \dots, 6$. One checks easily that the data $L(1, \dots, 6)$, *position of 7* determines the list $L(1, \dots, 7)$. Thus, $\natural L(1, \dots, 7) = 14$.

Let $1, \dots, 7$ be such that $7 < 23456$ and $1 > 23456$, see Figure 4. One may move 1, preserving the convex position, towards 23456 till 1 reaches this conic. The cubic $C_3(k)$ with $k = 2, 3, 4, 5$ or 6 is obtained as perturbation of the reducible cubic $k7 \cup 23456$ letting 1 move back to the outside of 23456 (in Figure 4, we show the case $k = 3$). The condition 1 *moves to the outside of 23456* is equivalent to 6 *moves to the inside of 12345*. The cubic $C_3(1)$ is obtained perturbing the reducible cubic $17 \cup 12345$. Assume that the cubic $C_3(7)$ has a loop, passing through some other of the seven points. This cubic cuts then $C_3(6)$ at more than nine points, contradicting Bezout's theorem. Applying now Bezout's theorem with lines, we see that if $C_3(7)$ has a loop, it is attached to one of the arcs 61 or 12 of the pseudo-line. We have constructed $1+$, cyclic permutations and symmetries allow to obtain thirteen other lists. As of now, we have proved that: $\natural L(1, \dots, 7) = 14$, two elementary data of $L(1, \dots, 7)$ determine $S(1, \dots, 7)$, and $\natural S(1, \dots, 7) \geq 14$. Hence $\natural S(1, \dots, 7) = 14$, the data $L(1, \dots, 7)$ and $S(1, \dots, 7)$ are equivalent.

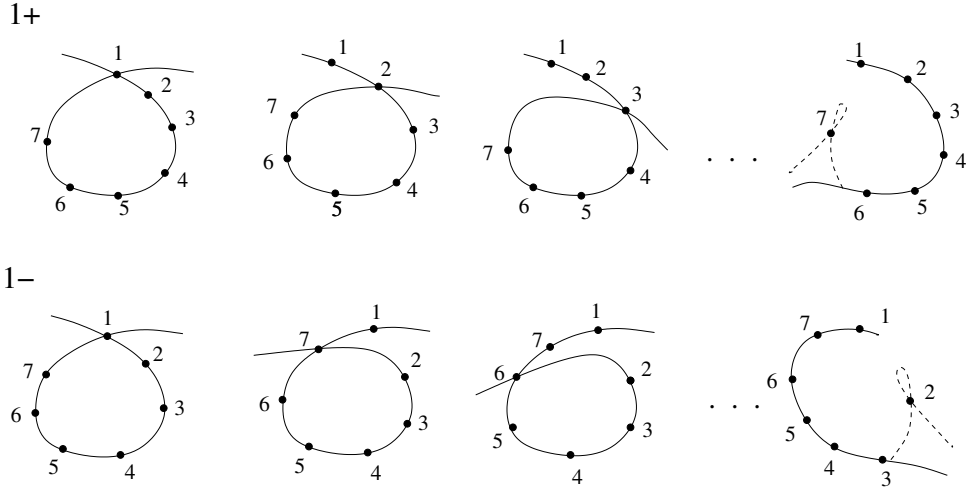

Figure 3: The lists 1+ and 1-

The correspondences between the fourteen lists $S(1, \dots, 7)$ and $L(1, \dots, 7)$ (written in full extent) are displayed in Figures 38-39. (For convenience, we have gathered some of the tabulars in the end.)

Another proof of this proposition, using cremona transformations, is presented in [5]. Let A, B be two consecutive points in a configuration $1, \dots, 7$ realizing a generic list, and let C_2 be the conic through the other five points. By definition, the *distance* $A \rightarrow B$ is 0 if A, B lie both inside or both outside of C_2 ; +1 if $A < C_2$ and $B > C_2$; -1 if $A > C_2$ and $B < C_2$. For the list 1+, one has thus $1 \rightarrow 2 = \dots = 6 \rightarrow 7 = 0$, and $7 \rightarrow 1 = +1$.

The first non trivial case is $n = 8$. It will turn out that the least number of elementary data necessary to determine a list $L(1, \dots, 8)$ depends on the list. Let us denote by \hat{i} the list determined by all of the points but i . The list $L(1, \dots, 8)$ may be encoded by the octuple of sublists $(\hat{1}, \hat{2}, \dots, \hat{8})$ with $\hat{i} = k \pm, k \in \{1, \dots, \hat{i}, \dots, 8\}$. Consider the group D_8 of symmetries of the octagon, generated by the cyclic permutation $a = +1$ and the symmetry with respect to the axis $\sigma = 15$, see Figure 5.

$$D_8 = \{a, \sigma | a^8 = id, \sigma^2 = id, a\sigma = \sigma a^{-1}\}$$

Theorem 2 *Up to the action of D_8 , eight generic points $1, \dots, 8$ lying in convex position may realize 47 different lists $L(1, \dots, 8)$. The total number of generic lists is $752 = 47 \times 16$.*

This theorem will be proved in two steps, in sections 2.2 (restriction part) and 2.6 (construction part).

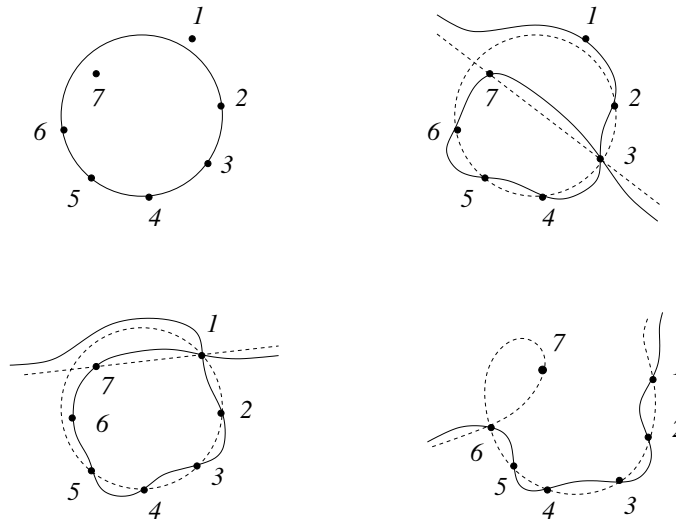

Figure 4: Construction of the list 1+

15	26	37	48	(+1)(15)	(+1)(26)	(+1)(37)	(+1)(48)
$1 \leftrightarrow 1$	$1 \leftrightarrow 3$	$1 \leftrightarrow 5$	$1 \leftrightarrow 7$	$1 \leftrightarrow 2$	$1 \leftrightarrow 4$	$1 \leftrightarrow 6$	$1 \leftrightarrow 8$
$2 \leftrightarrow 8$	$2 \leftrightarrow 2$	$2 \leftrightarrow 4$	$2 \leftrightarrow 6$	$3 \leftrightarrow 8$	$2 \leftrightarrow 3$	$2 \leftrightarrow 5$	$2 \leftrightarrow 7$
$3 \leftrightarrow 7$	$4 \leftrightarrow 8$	$3 \leftrightarrow 3$	$3 \leftrightarrow 5$	$4 \leftrightarrow 7$	$5 \leftrightarrow 8$	$3 \leftrightarrow 4$	$3 \leftrightarrow 6$
$4 \leftrightarrow 6$	$5 \leftrightarrow 7$	$6 \leftrightarrow 8$	$4 \leftrightarrow 4$	$5 \leftrightarrow 6$	$6 \leftrightarrow 7$	$7 \leftrightarrow 8$	$4 \leftrightarrow 5$
$5 \leftrightarrow 5$	$6 \leftrightarrow 6$	$7 \leftrightarrow 7$	$8 \leftrightarrow 8$				

Figure 5: Action of D_8

2.2 Admissible lists

Let $1, \dots, 8$ lie in convex position and $\{A, \dots, G\} = \{1, \dots, 7\}$. Move 8, leaving the other points fixed and preserving the convex position. Consider an event of the form 8 crosses a conic $ABCDE$, it induces a change of the list \hat{G} . The remaining point F may lie inside or outside of the conic $ABCDE$, depending on the list $L(1, \dots, 7)$ (see upper and lower part of Figure 6). So there are: 21 choices for the conic $ABCDE$, two choices of G , and two possible positions of the last point F with respect to $ABCDE$. Hence in total 84 possibilities. Figure 6 gathers all of these possibilities, showing how the cubic of \hat{G} with double point at C changes when 8 crosses $ABCDE$. This cubic determines the whole list \hat{G} . The point 8 (not represented) may be placed in six different ways on each cubic, according to the cyclic ordering of the set of points $\{8, A, B, C, D, E, F\}$. Assume for example that 8 is situated between A and B in the cyclic ordering. When 8 enters $ABCDE$, one has: $\hat{G} : E- \rightarrow A+$ (if F inside of $ABCDE$), and $\hat{G} : F- \rightarrow F+$ (if F outside of $ABCDE$). For each $G \in \{1, \dots, 7\}$, we find two possible chains of degenerations of \hat{G} while moving the point 8. The chain starting with $8\pm$ will be denoted by $\hat{G} \pm (8)$. For each $\hat{8} \in \{1\pm, \dots, 7\pm\}$ and each $G \in \{1, \dots, 7\}$ one watches which of the two possible chains is realized, see Figure 7. For each list $\hat{8} \in \{1\pm, 2\pm, 3\pm, 4+\}$, we draw a diagram whose rows are the chains of degenerations of $\hat{1}, \dots, \hat{7}$. (We drop the other cases $\hat{8} \in \{7\pm, 6\pm, 5\pm, 4-\}$, that can be deduced from the first ones by the action of D_8). Let C_2 and C'_2 be two adjacent conics in a column, we add a vertical arrow from C_2 to C'_2 if the following holds: 8 outside of C_2 implies 8 outside of C'_2 . See Figures 40-46.

Chasing in the diagrams, we may find all of the admissible orbits, for the action of D_8 , realizable by the lists $L(1, \dots, 8)$. The explicit lists $L(1, \dots, 8)$ obtained in this procedure are gathered in Figures 9-14. We denote these lists by L_1, \dots, L_{95} , according to their appearance order. Note that we cannot completely rule out redundancies: we get sometimes several representants of the same orbit. So, we choose for each orbit one representant that we write with normal fonts, the equivalent lists are written in bold. The lists written in normal fonts will be called for convenience *principal lists*, even if their choice is not canonical.

Figures 9-10 show the 64 admissible lists with $\hat{8} = 1+$. The first and the last are deduced one from the other by ± 1 . The 15 lists with $\hat{5} = 6+$ are mapped onto the 15 lists with $\hat{3} = 4+$ by $+3$. The group of six lists with $\hat{2} = 1-$ splits into two subgroups that are mapped one onto the other by the symmetry 15. The group of 20 lists with $\hat{4} = 3-$ splits into two subgroups that are mapped one onto the other by 26. The group of six lists with $\hat{6} = 5-$ splits into two subgroups that are mapped one onto the other by 37. Up to the action of D_8 , there are 32 admissible lists with $\hat{8} = 1+$. Set now $\hat{8} = 1-$. First thing we rule out the orbit of $\hat{8} = 1+$, that is to say any list which is mapped by some element of D_8 onto a list with $\hat{8} = 1+$. In other words, we set: $\hat{1} \neq 2+, 8-, \hat{2} \neq 3+, 1-, \hat{3} \neq 4+, 2-, \hat{4} \neq 5+, 3-, \hat{5} \neq 6+, 4-, \hat{6} \neq 7+, 5-$ and $\hat{7} \neq 8+, 6-$. Figure 11 shows the six new admissible lists obtained. They split into two groups that are mapped one onto the other by 15, so we are left with only three new orbits. For $\hat{8} = 2+$ we rule out the orbits of $\hat{8} = 1\pm$, that is we set: $\hat{1} \neq 2\pm, 8\pm, \hat{2} \neq 3\pm, 1\pm,$

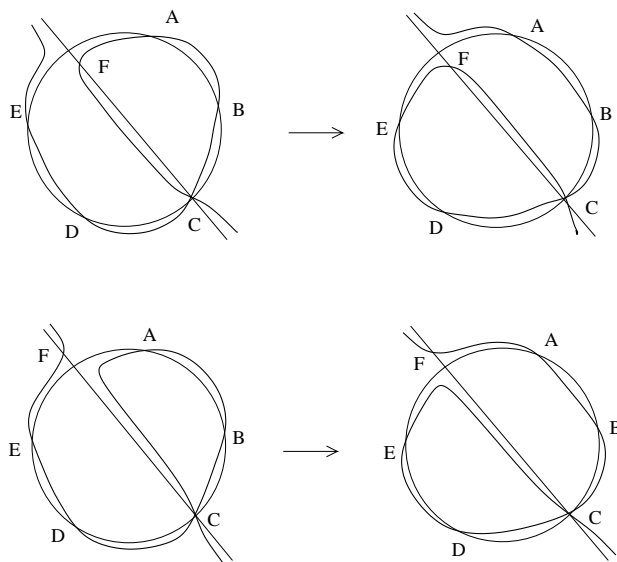

Figure 6: Degenerations of the list \hat{G}

$\hat{3} \neq 4\pm, 2\pm$, $\hat{4} \neq 5\pm, 3\pm$, $\hat{5} \neq 6\pm, 4\pm$, $\hat{6} \neq 7\pm, 5\pm$ and $\hat{7} \neq 8\pm, 6\pm$. Figure 12 shows the four new admissible lists with $\hat{\delta} = 2+$. They split into two groups that are mapped one onto the other by 15, we get two new orbits. Set now $\hat{\delta} = 2-$. Once we have ruled out the orbits of $\hat{\delta} = 1\pm, 2+$, we get the 13 new admissible lists shown in Figure 13. Some of them are deduced from each other by $\pm 2, 15$ or 26 so that there are only eight new orbits. Let $\hat{\delta} = 3+$, once we have ruled out the orbits of $\hat{\delta} = 1\pm, 2\pm$, we find no new admissible lists. For $\hat{\delta} = 3-$, after excluding the orbits of $\hat{\delta} = 1\pm, 2\pm, 3+$, we get the eight new admissible lists shown in Figure 14. They split into two groups that are mapped one onto the other by ± 2 , the first group splits in two subgroups that are mapped one onto the other by 15. We get two new orbits. At last, let $\hat{\delta} = 4+$, once we have excluded the orbits of $\hat{\delta} = 1\pm, 2\pm, 3\pm$, we find no new admissible lists.

The total number of admissible orbits is 47. One checks easily that the 16 lists in each orbit are all distinct: assume that a principal list, say with $\hat{\delta} = 1+$, is invariant for some element of D_8 , say $(+1)$. This list verifies: $\hat{\delta} = 1+$ and $\hat{1} = 2+$. There is no such list. The total number of admissible lists is thus $47 \times 16 = 752$. The non-generic lists invariant for some elements of D_8 will be studied in section 4.3.

2.3 Extremal lists

Consider a configuration of eight points $1, \dots, 8$ lying in convex position in the plane. Any piece of information $\hat{P} = n\pm$, with $P \in \{1, \dots, 8\}$ is equivalent to a statement of the form $F < C_2$ and $G > C_2$, where F, G are two points among $1, \dots, 8$, different from P . For example, $\hat{8} = 1+$ if and only if $7 < 23456$ and

	$\hat{8}$
$\hat{1}+$	1+, 2+, 2-, 4+, 4-, 6+, 6-
$\hat{1}-$	1-, 3+, 3-, 5+, 5-, 7+, 7-
$\hat{2}+$	1+, 1-, 2-, 4+, 4-, 6+, 6-
$\hat{2}-$	2+, 3+, 3-, 5+, 5-, 7+, 7-
$\hat{3}+$	1+, 1-, 3+, 4+, 4-, 6+, 6-
$\hat{3}-$	2+, 2-, 3-, 5+, 5-, 7+, 7-
$\hat{4}+$	1+, 1-, 3+, 3-, 4-, 6+, 6-
$\hat{4}-$	2+, 2-, 4+, 5+, 5-, 7+, 7-
$\hat{5}+$	1+, 1-, 3+, 3-, 5+, 6+, 6-
$\hat{5}-$	2+, 2-, 4+, 4-, 5-, 7+, 7-
$\hat{6}+$	1+, 1-, 3+, 3-, 5+, 5-, 6-
$\hat{6}-$	2+, 2-, 4+, 4-, 6+, 7+, 7-
$\hat{7}+$	1+, 1-, 3+, 3-, 5+, 5-, 7+
$\hat{7}-$	2+, 2-, 4+, 4-, 6+, 6-, 7-

Figure 7: Possible values of $\hat{8}$ for the chains $\hat{n}\pm = \hat{n} \pm (8), n = 1, \dots, 7$

1 > 23456. The correspondences for $P = 8$ are indicated with bold types in the tabulars of Figures 38-39, the other cases are easily deduced from these by the action of D_8 . We say that a list is *maximal* (or *minimal*) for some $F \in 1, \dots, 8$ if F lies outside (or inside) of all the conics determined by five of the other seven points. Say $F = 8$, then for each possible $\hat{8} = n\pm$, there is one maximal and one minimal list. The maximal list $\max(\hat{8} = n\pm)$ is obtained from the given diagram $\hat{8} = n\pm$ taking for all \hat{m} with $m = 1, \dots, 7$ the labels above the first column of horizontal arrows. The minimal list $\min(\hat{8} = n\pm)$ is obtained from the given diagram $\hat{8} = n\pm$ taking for all \hat{m} with $m = 1, \dots, 7$ the labels above the last column of horizontal arrows. These notations are consistent with D_8 . The extremal lists are easily realizable as follows: start from a configuration of eight points lying on the same conic C_2 . Move first 8, either to the interior or to the exterior of C_2 . Then, move two further points F and G , one to the interior and the other to the exterior of C_2 , so as to obtain the desired list $\hat{8}$. The extremal lists are distributed in 12 orbits: two are both maximal and minimal, five are only maximal, five are only minimal. Note that $\max(\hat{1} = n\pm)$ and $\max(\hat{1} = (10 - n)\mp)$ are deduced one from the other by 15. We denote the orbit of these two lists shortly by $(n\pm, (10 - n)\mp)$. The maximal orbits $(2+, 8-)$ and $(3+, 7-)$ are also minimal: $\max(\hat{1} = 8-) = \min(\hat{2} = 1-)$ and $\max(\hat{1} = 3+) = \min(\hat{2} = 1+)$. The principal extremal lists are: $L_2 = \min(\hat{7} = 5-)$, $L_3 = \min(\hat{7} = 5+)$, $L_5 = \min(\hat{7} = 3-)$, $L_{32} = \max(\hat{1} = 8+)$, $L_{48} = \max(\hat{1} = 6-)$, $L_{56} = \max(\hat{1} = 6+)$, $L_{64} = \max(\hat{1} = 2+) = \min(\hat{8} = 1+)$, $L_{65} = \max(\hat{1} = 7-) = \min(\hat{8} = 1-)$, $L_{66} = \max(\hat{1} = 7+)$, $L_{67} = \max(\hat{1} = 5-)$, $L_{71} = \min(\hat{1} = 4+)$, and $L_{72} = \min(\hat{1} = 4-)$.

$$\begin{array}{cccccccc}
8+ & \xrightarrow{23456} & 6- & \xrightarrow{23457} & 6+ & \xrightarrow{23467} & 4- & \xrightarrow{23567} & 4+ & \xrightarrow{24567} & 2- & \xrightarrow{34567} & 2+ \\
1+ & \xrightarrow{23456} & 6- & \xrightarrow{23457} & 6+ & \xrightarrow{23467} & 4- & \xrightarrow{23567} & 4+ & \xrightarrow{24567} & 2- & \xrightarrow{34567} & 2+
\end{array}$$

Figure 8: The chains $\hat{1} + (8)$ and $\hat{8} + (1)$

2.4 Another encoding for the lists and their orbits

For the lists $L(1, \dots, 8)$, we define the *distance* between consecutive points A, B in the cyclic ordering. Let $(A, \dots, H) = (1, \dots, 8)$ up to some cyclic permutation and reversion. The distance $A \rightarrow B$ is the number of conics passing through five points among C, D, E, F, G, H that separate A from B , multiplied by -1 if A is the outermost of the two points. To determine a distance $A \rightarrow B$, one needs only to look at the sublists \hat{A} and \hat{B} of $L(1, \dots, 8)$, as explained in the following example. Let us find out the distance $8 \rightarrow 1$ in the two cases: $\hat{1} = 8+$, $\hat{8} = 1+$ and $\hat{1} = 8+$, $\hat{8} = 6+$. One has: $7 < 23456$, letting 8 (resp. 1) cross the sequence of six conics determined by $2, \dots, 7$ yields the chain $\hat{1} + (8)$ (resp. $\hat{8} + (1)$), see Figure 8. For $\hat{1} = 8+$, $\hat{8} = 1+$, both points 8 and 1 lie outside of all six conics, $8 \rightarrow 1 = 0$, for $\hat{1} = 8+$, $\hat{8} = 6+$, one has $8 > 23456$, and $23467 < 1 < 23457$, thus $8 \rightarrow 1 = -2$.

Note that the distance $A \rightarrow B$ is equal to 0 if and only if: $\hat{A} = B\epsilon$, $\hat{B} = A\epsilon$ or $\hat{A} = \hat{B} = N\epsilon$, with $N \in \{C, \dots, H\}$.

The tabulars of Figures 15-16 give the values of these invariants for all of the 47 successive principal lists L_n , and their sum σ . Note that the 47 octuples $(1 \rightarrow 2, \dots, 8 \rightarrow 1)$ listed in Figures 15-16 are all different. Furthermore, their orbits under the action of D_8 are also all distinct. Observing the tabulars allows to derive the following:

Proposition 2 *Any list $L(1, \dots, 8)$ is determined by the octuple $(1 \rightarrow 2, 2 \rightarrow 3, \dots, 8 \rightarrow 1)$. Each orbit is determined by an octuple of integer numbers (ranging between -6 and $+6$), defined up to cyclic permutation, and reversion with change of all signs. The absolute value $|\sigma|$ is an invariant of the orbits, that takes all of the even values between 0 and 8. The numbers of orbits realizing $|\sigma| = 0, 2, 4, 6, 8$ are respectively: 14, 12, 16, 4 and 1.*

We have thus a new encoding for the lists and the orbits.

2.5 Isotopies of octuples of points

Consider the space $(\mathbb{R}P^2)^8$ stratified by the lines and conics.

Proposition 3 *The octuples of points realizing a given list $L(1, \dots, 8)$ lie all in the same chamber of $(\mathbb{R}P^2)^8$. This chamber is adjacent to the deep stratum, formed by the configurations of eight coconic points.*

$\hat{1}$	8+	8+	8+	8+	8+	8+	8+	8+
$\hat{2}$	8+	8+	8+	8+	8+	8+	8+	8+
$\hat{3}$	8+	8+	8+	8+	8+	8+	8+	8+
$\hat{4}$	8+	8+	8+	8+	6-	6-	6+	3-
$\hat{5}$	8+	8+	6-	6+	6-	6+	6+	3-
$\hat{6}$	8+	5-	5-	5+	5-	5+	3-	3-
$\hat{7}$	8+	5-	5+	5+	3-	3-	3-	3-
$\hat{1}$	8+	8+	8+	8+	8+	8+	8+	8+
$\hat{2}$	8+	8+	8+	8+	8+	8+	8+	8+
$\hat{3}$	6-	6-	6-	6-	6+	6+	4-	4+
$\hat{4}$	6-	6-	6+	3-	6+	3-	3-	3+
$\hat{5}$	6-	6+	6+	3-	6+	3-	3+	3+
$\hat{6}$	5-	5+	3-	3-	3+	3+	3+	3+
$\hat{7}$	3+	3+	3+	3+	3+	3+	3+	3+
$\hat{1}$	8+	8+	8+	8+	8+	8+	8+	8+
$\hat{2}$	6-	6-	6-	6-	6-	6-	6-	6-
$\hat{3}$	6-	6-	6-	6-	6+	6+	4-	4+
$\hat{4}$	6-	6-	6+	3-	6+	3-	3-	3+
$\hat{5}$	6-	6+	6+	3-	6+	3-	3+	3+
$\hat{6}$	5-	5+	3-	3-	3+	3+	3+	3+
$\hat{7}$	1-	1-	1-	1-	1-	1-	1-	1-
$\hat{1}$	8+	8+	8+	8+	8+	8+	8+	8+
$\hat{2}$	6+	6+	6+	6+	4-	4-	4+	1-
$\hat{3}$	6+	6+	4-	4+	4-	4+	4+	1-
$\hat{4}$	6+	3-	3-	3+	3-	3+	1-	1-
$\hat{5}$	6+	3-	3+	3+	1-	1-	1-	1-
$\hat{6}$	1-	1-	1-	1-	1-	1-	1-	1-
$\hat{7}$	1-	1-	1-	1-	1-	1-	1-	1-

Figure 9: $\hat{8} = 1+$, lists L_1, \dots, L_{32}

$\hat{1}$	6-	6-	6-	6-	6-	6-	6-	6-
$\hat{2}$	6-	6-	6-	6-	6-	6-	6-	6-
$\hat{3}$	6-	6-	6-	6-	6+	6+	4-	4+
$\hat{4}$	6-	6-	6+	3-	6+	3-	3-	3+
$\hat{5}$	6-	6+	6+	3-	6+	3-	3+	3+
$\hat{6}$	5-	5+	3-	3-	3+	3+	3+	3+
$\hat{7}$	1+	1+	1+	1+	1+	1+	1+	1+

$\hat{1}$	6-	6-	6-	6-	6-	6-	6-	6-
$\hat{2}$	6+	6+	6+	6+	4-	4-	4+	1-
$\hat{3}$	6+	6+	4-	4+	4-	4+	4+	1-
$\hat{4}$	6+	3-	3-	3+	3-	3+	1-	1-
$\hat{5}$	6+	3-	3+	3+	1-	1-	1-	1-
$\hat{6}$	1-	1-	1-	1-	1-	1-	1-	1-
$\hat{7}$	1+	1+	1+	1+	1+	1+	1+	1+

$\hat{1}$	6+	6+	6+	6+	6+	6+	6+	6+
$\hat{2}$	6+	6+	6+	6+	4-	4-	4+	1-
$\hat{3}$	6+	6+	4-	4+	4-	4+	4+	1-
$\hat{4}$	6+	3-	3-	3+	3-	3+	1-	1-
$\hat{5}$	6+	3-	3+	3+	1-	1-	1-	1-
$\hat{6}$	1+	1+	1+	1+	1+	1+	1+	1+
$\hat{7}$	1+	1+	1+	1+	1+	1+	1+	1+

$\hat{1}$	4-	4-	4-	4-	4+	4+	2-	2+
$\hat{2}$	4-	4-	4+	1-	4+	1-	1-	1+
$\hat{3}$	4-	4+	4+	1-	4+	1-	1+	1+
$\hat{4}$	3-	3+	1-	1-	1+	1+	1+	1+
$\hat{5}$	1+	1+	1+	1+	1+	1+	1+	1+
$\hat{6}$	1+	1+	1+	1+	1+	1+	1+	1+
$\hat{7}$	1+	1+	1+	1+	1+	1+	1+	1+

Figure 10: $\hat{8} = 1+$, lists L_{33}, \dots, L_{64}

$\hat{1}$	7-	7+	5-	5+	3-	3+
$\hat{2}$	1+	1+	1+	1+	1+	1+
$\hat{3}$	1+	1+	1+	1+	1+	1-
$\hat{4}$	1+	1+	1+	1+	1-	1-
$\hat{5}$	1+	1+	1+	1-	1-	1-
$\hat{6}$	1+	1+	1-	1-	1-	1-
$\hat{7}$	1+	1-	1-	1-	1-	1-

Figure 11: $\hat{8} = 1-$, lists L_{65}, \dots, L_{70}

$\hat{1}$	4+	4-	6+	6-
$\hat{2}$	8-	8-	8-	8-
$\hat{3}$	8-	8-	8-	8-
$\hat{4}$	2+	8-	8-	8-
$\hat{5}$	2+	2+	8-	8-
$\hat{6}$	2+	2+	2+	8-
$\hat{7}$	2+	2+	2+	2+

Figure 12: $\hat{8} = 2+$, lists L_{71}, \dots, L_{74}

$\hat{1}$	4+	4+	6-	4+	4+	4-	6+
$\hat{2}$	8+	4-	8+	6-	6+	8+	8+
$\hat{3}$	8-	8-	8-	8-	8-	8-	8-
$\hat{4}$	2+	2+	8-	2+	2+	8-	8-
$\hat{5}$	2+	2-	8-	2+	2+	2+	8-
$\hat{6}$	2+	2-	8-	2+	2-	2+	2+
$\hat{7}$	2+	2-	2+	2-	2-	2+	2+

$\hat{1}$	6+	6+	4-	6-	4-	4-
$\hat{2}$	6-	6+	4-	6-	6-	6+
$\hat{3}$	8-	8-	8-	8-	8-	8-
$\hat{4}$	8-	8-	8-	8-	8-	8-
$\hat{5}$	8-	8-	2-	8-	2+	2+
$\hat{6}$	2+	2-	2-	8-	2+	2-
$\hat{7}$	2-	2-	2-	2-	2-	2-

Figure 13: $\hat{8} = 2-$, lists L_{75}, \dots, L_{87}

$\hat{1}$	5+	5+	5-	5+	5-	5-	5+	5-
$\hat{2}$	7+	5-	7+	5-	7+	5-	7+	5-
$\hat{3}$	7-	7+	7-	7-	7+	7-	7+	7+
$\hat{4}$	1+	1+	1+	1+	1+	1+	1+	1+
$\hat{5}$	1-	1-	1+	1-	1+	1+	1-	1+
$\hat{6}$	1-	3+	1-	3+	1-	3+	1-	3+
$\hat{7}$	3+	3-	3+	3+	3-	3+	3-	3-

Figure 14: $\hat{8} = 3-$, lists L_{88}, \dots, L_{95}

n	$1 \rightarrow 2$	$2 \rightarrow 3$	$3 \rightarrow 4$	$4 \rightarrow 5$	$5 \rightarrow 6$	$6 \rightarrow 7$	$7 \rightarrow 8$	$8 \rightarrow 1$	σ
2	0	0	0	0	-1	0	5	0	4
3	0	0	0	1	0	-1	4	0	4
4	0	0	0	2	0	0	4	0	6
5	0	0	-1	0	0	-2	3	0	0
6	0	0	-1	1	0	-1	3	0	2
7	0	0	-2	0	1	0	3	0	2
8	0	0	-3	0	0	0	3	0	0
10	0	1	0	1	0	-2	2	0	2
11	0	1	-1	0	1	-1	2	0	2
12	0	1	-2	0	0	-1	2	0	0
13	0	2	0	0	2	0	2	0	6
14	0	2	-1	0	1	0	2	0	4
15	0	3	0	-1	0	0	2	0	4
18	-1	0	0	1	0	-3	1	0	-2
19	-1	0	-1	0	1	-2	1	0	-2
20	-1	0	-2	0	0	-2	1	0	-4
21	-1	1	0	0	2	-1	1	0	2
22	-1	1	-1	0	1	-1	1	0	0
23	-1	2	0	-1	0	-1	1	0	0
25	-2	0	0	0	3	0	1	0	2
26	-2	0	-1	0	2	0	1	0	0
32	-5	0	0	0	0	0	1	0	-4
34	0	0	0	1	0	-4	0	1	-2
35	0	0	-1	0	1	-3	0	1	-2
36	0	0	-2	0	0	-3	0	1	-4
37	0	1	0	0	2	-2	0	1	2
38	0	1	-1	0	1	-2	0	1	0
41	-1	0	0	0	3	-1	0	1	2
48	-4	0	0	0	0	-1	0	1	-4
49	0	0	0	0	4	0	0	2	6
56	-3	0	0	0	1	0	0	2	0
64	0	0	0	0	0	0	0	6	6

Figure 15: Distances $A \rightarrow B$ for the principal lists with $\hat{8} = 1+$

n	$1 \rightarrow 2$	$2 \rightarrow 3$	$3 \rightarrow 4$	$4 \rightarrow 5$	$5 \rightarrow 6$	$6 \rightarrow 7$	$7 \rightarrow 8$	$8 \rightarrow 1$	σ
65	-1	0	0	0	0	0	-1	6	4
66	-2	0	0	0	0	1	0	5	4
67	-3	0	0	0	-1	0	0	4	0
71	5	0	1	0	0	0	0	-2	4
72	4	0	0	-1	0	0	0	-3	0
75	4	-1	1	0	0	0	1	-1	4
78	3	-2	1	0	0	-1	0	-1	0
80	3	-1	0	-1	0	0	1	-2	0
82	1	-2	0	0	1	-1	0	-3	-4
83	0	-3	0	0	2	0	0	-3	-4
84	0	-4	0	-2	0	0	0	-2	-8
86	2	-2	0	-1	0	-1	0	-2	-4
87	1	-3	0	-1	1	0	0	-2	-4
88	-2	1	-1	1	0	1	-1	1	0
92	-1	0	-2	0	-1	2	0	2	0

Figure 16: Distances $A \rightarrow B$ for the principal lists with $\hat{8} \neq 1+$

Proof: Let $1, \dots, 8$ realize some list L . Denote by h_t a homothety centered at any point P different from $1, \dots, 8$, with rate t . The homotheties $h_t, t \in [1, \infty]$ give rise to an isotopy of $1, \dots, 8$. During this isotopy, the list L is preserved, except for the end-point when the mobile points $1, \dots, 8$ become all aligned. They are also on some reducible conic. The configuration is thus on the deep stratum. Move in this stratum so that the conic becomes non-reducible. With a slight perturbation, we can make the isotopy generic, in other words, it is completely contained in the same chamber except for the end-point. Consider now two configurations realizing the same list. Perform for each of them a generic isotopy till all of the eight points lie on the same conic. Up to an affine transformation mapping one conic onto the other and an isotopy along this conic, we may assume that both isotopies have the same end-point. So we have a path connecting the two configurations and having one single non-generic point. Perturb the path in a neighbourhood of this point. In this neighbourhood, all of the walls intersect pairwise transversally. There are two possible perturbations, one crosses all of the walls twice, the other crosses no wall at all. \square

2.6 Elementary changes and inductive constructions

In this section, we finish the proof of Theorem 2. Let us call *elementary change* the change induced on a list $L = L(1, \dots, 8)$ letting one point among $1, \dots, 8$ cross a conic determined by five others, in some direction. Up to the action of D_8 , there are 19 elementary changes, see Figures 17-18. A pair $(\hat{N} = Q\pm, \hat{M} = R\pm)$ involved in some elementary change is called *elementary pair*. There are in

total 224 elementary changes and correspondingly 224 elementary pairs, see Figures 47-48.

Proposition 4 *Let $1, \dots, 8$ be eight points in convex position, realizing a list L . Let A, B be two of these points, consecutive for the cyclic ordering.*

1. *If $A \rightarrow B = 0$, one may move the set of points, shifting A towards B , till $A = B$, without degeneration of the list $L(1, \dots, 8)$ inbetween.*
2. *If $A \rightarrow B = \pm n$, with $n > 0$, the points A and B are separated from each other by n of the six conics determined by C, D, E, F, G, H . One may move the set of points, shifting A towards B , till $A = B$, in such a way that the list $L(1, \dots, 8)$ undergoes exactly n degenerations, corresponding to the n conics.*

Proof: For any pair of consecutive points P, Q among $1, \dots, 8$, denote by $[PQ]$ the affine segment PQ belonging to the convex hull of the eight points. Move A towards B as prescribed, leaving the other points fixed. The point A moves inside of a triangle BHR supported by the lines (BC) , (BH) , (GH) , where $R = (BC) \cap (GH)$. In most cases, one may find a path connecting the starting point A to B inside of the triangle, that doesn't cut any one of the 15 conics passing through B and four other points among C, \dots, H . The exception is the following: let C_2 be one of the conics $BDEFG$, $BDEFH$, $BDEGH$, $BDFGH$ or $BEFGH$. If A, C lie both outside of C_2 , and the second intersection of C_2 with the line BC is on the edge BR of the triangle, then any path $8 \rightarrow 1$ must cross C_2 . Assume now that we may move all of the points at the same time. We perform an isotopy in $(\mathbb{R}P^2)^8$ inside of the chamber of L , towards the deep stratum. When the octuple of points gets close enough to this stratum, the exceptional case can no longer occur: let C_2 be any one of the five conics, and assume that A, C lie both outside of C_2 , then the second intersection of C_2 with the line (BC) lies on the segment $[BC]$. \square .

Proposition 5 *The elementary changes are always realizable: for each elementary pair appearing in an existing list L , one may perform the corresponding elementary change to realize a new list.*

Proof: Recall that a statement of the form 6 crosses 12345 from the inside to the outside is equivalent to 5 crosses 12346 from the outside to the inside. All of the 19 elementary changes but one may be thus interpreted as motions of a point A towards a consecutive point B such that $A \rightarrow B \neq 0$, till A crosses the first conic separating it from B . The only exception is the third change: $\hat{1} : 8- \rightarrow 3+$, $\hat{2} : 1- \rightarrow 1+$. So, for any elementary pair of L that is not in the orbit of $(\hat{1} = 8-, \hat{2} = 1-)$, the corresponding elementary change is realizable. Let now L have the elementary pair $(\hat{1} = 8-, \hat{2} = 1-)$. Note that $\hat{1} = 8-$ belongs to the chain $\hat{1} - (8)$, and $\hat{2} = 1-$ belongs to the chain $\hat{2} + (8)$. Using Figure 7, we deduce that $\hat{8} = 1-$; using Figure 41, we

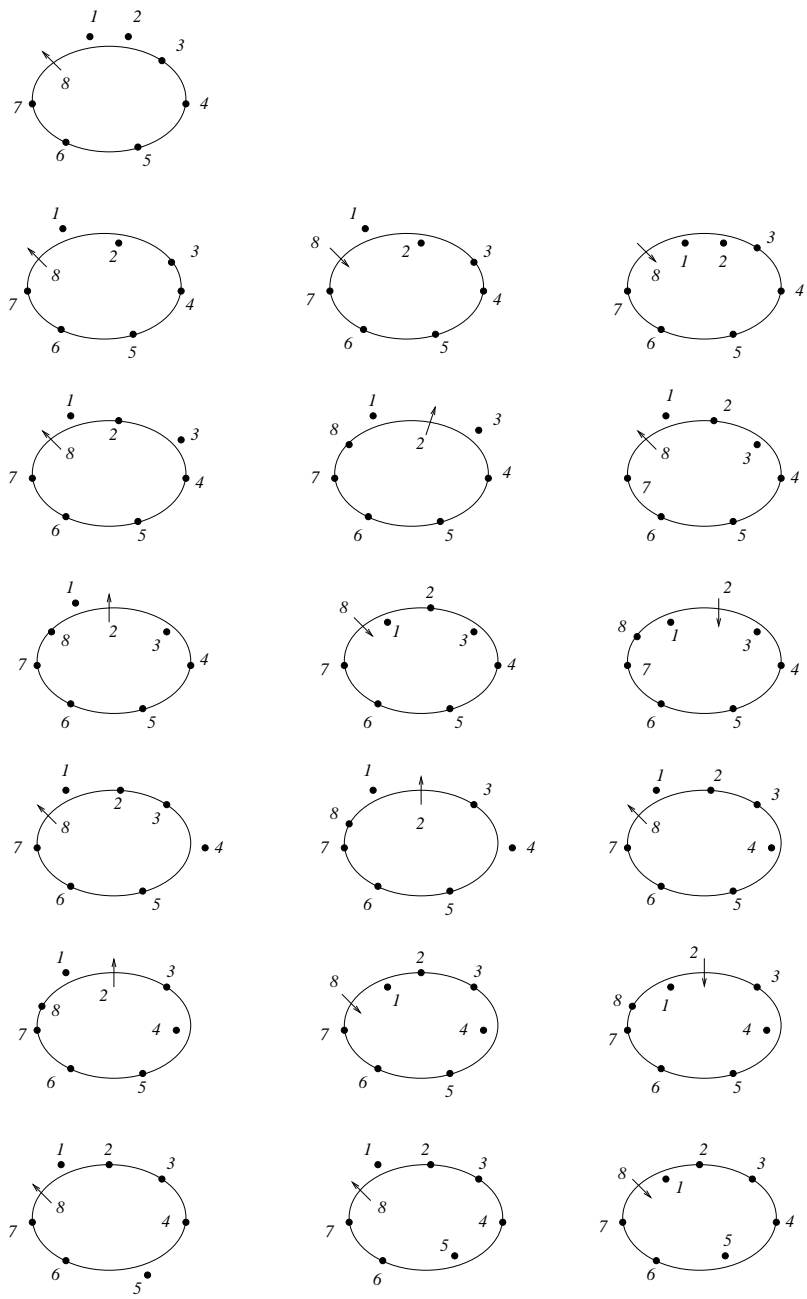

Figure 17: Elementary changes

$$\begin{array}{l}
\hat{1} : 2+ \rightarrow 2- \\
\hat{2} : 1+ \rightarrow 1- \\
\\
\hat{1} : 3+ \rightarrow 8- \quad \hat{1} : 8- \rightarrow 3+ \quad \hat{1} : 8- \rightarrow 3+ \\
\hat{2} : 1+ \rightarrow 1- \quad \hat{2} : 1- \rightarrow 1+ \quad \hat{2} : 8- \rightarrow 3+ \\
\\
\hat{1} : 3- \rightarrow 3+ \quad \hat{1} : 3+ \rightarrow 3- \quad \hat{1} : 2- \rightarrow 4+ \\
\hat{3} : 1+ \rightarrow 1- \quad \hat{3} : 1- \rightarrow 1+ \quad \hat{3} : 1+ \rightarrow 1- \\
\\
\hat{1} : 4+ \rightarrow 2- \quad \hat{1} : 4+ \rightarrow 2- \quad \hat{1} : 2- \rightarrow 4+ \\
\hat{3} : 1- \rightarrow 1+ \quad \hat{3} : 8- \rightarrow 2+ \quad \hat{3} : 2+ \rightarrow 8- \\
\\
\hat{1} : 4+ \rightarrow 4- \quad \hat{1} : 4- \rightarrow 4+ \quad \hat{1} : 5+ \rightarrow 3- \\
\hat{4} : 1+ \rightarrow 1- \quad \hat{4} : 1- \rightarrow 1+ \quad \hat{4} : 1+ \rightarrow 1- \\
\\
\hat{1} : 3- \rightarrow 5+ \quad \hat{1} : 3- \rightarrow 5+ \quad \hat{1} : 5+ \rightarrow 3- \\
\hat{4} : 1- \rightarrow 1+ \quad \hat{4} : 8- \rightarrow 2+ \quad \hat{4} : 2+ \rightarrow 8- \\
\\
\hat{1} : 5- \rightarrow 5+ \quad \hat{1} : 4- \rightarrow 6+ \quad \hat{1} : 6+ \rightarrow 4- \\
\hat{5} : 1+ \rightarrow 1- \quad \hat{5} : 1+ \rightarrow 1- \quad \hat{5} : 8- \rightarrow 2+
\end{array}$$

Figure 18: Representants of the 19 orbits of elementary changes

see that $\hat{N} = 1-$ for $N = 3, \dots, 7$. The list is $\max(\hat{1} = 8-)$. The point 8 lies inside of all the conics determined by 1 and four points among $2, \dots, 7$. Up to some isotopy towards the deep stratum, we may assume that the conic 34567 has its second intersection point with the line (17) on the affine segment [17]. Denote by T the triangle supported by the lines (67), (71), (12) containing 8. One may move 8 towards [17] in T , preserving the list, till 8 reaches 34567. \square

Start from a list that is already realized, we will say that we perform the change (\hat{N}, \hat{M}) without further precision, as there is no ambiguity possible. Any principal list may be obtained from an extremal list by some sequence of elementary changes and actions of elements of D_8 . See Figure 19 where n stands for a list L_n (as in Figures 15-16) and each row is a new sequence whose first list was already realized. These sequences are chosen so as to reach all of the principal lists with the least possible number of starting lists (note that some intermediate lists are also extremal). This finishes the proof of Theorem 2. \square

1	$(\hat{6}, \hat{7})$	2	$(\hat{5}, \hat{7})$	3	$(\hat{5}, \hat{6})$	4	$(\hat{4}, \hat{7})$	6	$(\hat{4}, \hat{6})$	7	$(\hat{4}, \hat{5})$	8	
6	$(\hat{5}, \hat{6})$	5	(37)	9									
9	$(\hat{5}, \hat{6})$	10	$(\hat{4}, \hat{6})$	11	$(\hat{4}, \hat{5})$	12	$(\hat{3}, \hat{6})$	14	$(\hat{4}, \hat{5})$	13			
14	$(\hat{3}, \hat{5})$	15											
3	(37)	17	$(\hat{5}, \hat{6})$	18	$(\hat{4}, \hat{6})$	19	$(\hat{4}, \hat{5})$	20	$(\hat{3}, \hat{6})$	22	$(\hat{3}, \hat{5})$	23	
22	$(\hat{4}, \hat{5})$	21	$(\hat{2}, \hat{6})$	25	$(\hat{4}, \hat{5})$	26							
2	(37)	33	$(\hat{5}, \hat{6})$	34	$(\hat{4}, \hat{6})$	35	$(\hat{4}, \hat{5})$	36	$(\hat{3}, \hat{6})$	38			
35	$(\hat{3}, \hat{6})$	37	$(\hat{2}, \hat{6})$	41	$(\hat{1}, \hat{6})$	49							
65	$(\hat{1}, \hat{7})$	66	$(\hat{1}, \hat{6})$	67									
71	$(\hat{1}, \hat{4})$	72											
71	$(\hat{2}, \hat{8})$	75	$(\hat{2}, \hat{7})$	78									
75	$(\hat{1}, \hat{4})$	80	$(\hat{2}, \hat{7})$	86	$(\hat{2}, \hat{6})$	87	$(\hat{2}, \hat{5})$	84					
87	$(\hat{1}, \hat{5})$	83	$(\hat{2}, \hat{6})$	82									
87	$(\hat{3}, \hat{8})$	(-1)	88	(15)	90	$(\hat{3}, \hat{7})$	92						
			or	$(\hat{1}, \hat{5})$									

Figure 19: Inductive construction of the principal lists

3 Link between lists and pencils

3.1 Nodal lists

A configuration of eight points lying on a nodal cubic C_3 , one of them being the node, is not generic. Up to the action of D_8 , there are eight possible combinatorial cubics C_3 , see Figure 20 where the successive cubics are denoted by $(1\pm, 1)_{nod}$, $(1-, k)_{nod}$ for $k = 8, \dots, 2$. Note that the encoding is consistent with the action of D_8 .

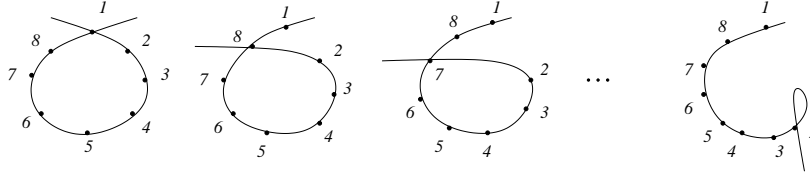

Figure 20: The cubics $(1\pm, 1)_{nod}$, $(1-, 8)_{nod}, \dots, (1-, 2)_{nod}$

Definition 1 A list $L(1, \dots, 8) = (\hat{1}, \hat{2}, \dots, \hat{8})$ is nodal if it is realizable by $1, \dots, 8$ on a nodal cubic with double point at one of these points.

Proposition 6 Up to the action of the group D_8 , $\sharp L(1, \dots, 8)_{nodal} = 4$. The nodal orbits are the maximal orbits $(8-, 2+)$, $(8+, 2-)$, $(6-, 4+)$, $(6+, 4-)$. Here are representants of each orbit along with the corresponding nodal cubics.

$$L(1, \dots, 8) = (\hat{1}, \hat{2}, \dots, \hat{8}) = \max(\hat{1} = 8-), \text{ realizable with } (1\pm, 1)_{nod}, (1-, k)_{nod}, k = 2, \dots, 8,$$

$\max(\hat{1} = 8+)$, realizable with $(1\pm, 1)_{nod}$ and $(1-, 8)_{nod}$,
 $\max(\hat{1} = 6-)$ and $\max(\hat{1} = 6+)$, both realizable with $(1\pm, 1)_{nod}$.

Proof: Let $1, \dots, 8$ lie in convex position on some nodal cubic C_3 , one of these points being the node. Up to the action of D_8 , we may assume that C_3 is one of the cubics $(1\pm, 1)_{nod}$, $(1-, k)_{nod}$, $k = 2 \dots 8$. If $C_3 = (1\pm, 1)_{nod}$, one has $\hat{i} \in \{1\pm\}$ for all $i \in \{2, \dots, 8\}$. Using the two diagrams $\hat{8} = 1\pm$ of Figures 40-41, one finds 14 possibilities for the list $L(1, \dots, 8)$, namely the maximal lists $\max(\hat{1} = n\pm)$, $n = 2, \dots, 8$. One has $\hat{1} = 8+ \iff 7 < 23456$ and $8 > 23456$. One can choose the points $2, \dots, 8$ on the loop of C_3 so that this condition is achieved. One has $\hat{1} = 7- \iff 8 < 23456$ and $7 > 23456$. By Bezout's theorem between 23456 and $(1\pm, 1)_{nod}$, one cannot choose the points $1, \dots, 8$ on the loop of this cubic verifying this condition. Finishing this argument with the other possible values of $\hat{1}$, one finds that $1, \dots, 8$ may be chosen on $(1\pm, 1)_{nod}$ so as to realize the eight lists $\max(\hat{1} = n\pm)$, with $n = 2, 4, 6, 8$.

Similarly, one proves that $1, \dots, 8$ on the cubic $C_3 = (1-, 8)_{nod}$ can realize exactly the first two lists $\max(\hat{1} = 8\pm)$; and points $1, \dots, 8$ on any cubic $C_3 = (1-, k)_{nod}$, $k \in \{2, \dots, 7\}$ must realize the first list $\max(\hat{1} = 8-)$. \square

Given two points P, Q among $1, \dots, 8$, we denote by (\hat{P}, Q) the cubic of the list \hat{P} with double point at Q .

Proposition 7 *The three conditions hereafter are equivalent:*

1. *The list $L(1, \dots, 8)$ determines the (combinatorial) pencil $\mathcal{P}(1, \dots, 8)$,*
2. *The list $L(1, \dots, 8)$ is not nodal,*
3. *$\forall G \in \{1, \dots, 8\}, \forall C_3$ cubic of \hat{G} , the position of G with respect to C_3 is determined by $L(1, \dots, 8)$.*

Proof: $-2 \Rightarrow -1$: let $L(1, \dots, 8)$ be a nodal list. Up to the action of D_8 , we may assume it is one of the four lists in Proposition 6. Any one of these lists is realizable with the eight points on a nodal cubic $C_3 = (1\pm, 1)_{nod}$. The points $1, \dots, 8$ give rise to a singular pencil \mathcal{P}_{sing} with $1 = 9$. Perturb the pencil moving 1 away from the node onto the odd component or onto the loop of C_3 (leaving the other seven points fixed). In the generic pencil obtained, C_3 is replaced by a pair of distinguished cubics C_3^1, C_3^2 or C_3^3, C_3^4 , see Figure 21. Using Bezout's theorem, we see easily that these two pairs of cubics cannot belong to the same pencil.

$2 \Rightarrow 3$: according to Proposition 3, any two configurations of points realizing the same list may be connected by a path inside of their common chamber of $(\mathbb{R}P^2)^8$. As $L(1, \dots, 8)$ is not nodal, none of the points G may cross any cubic of the list \hat{G} .

$3 \Rightarrow 1$: consider a configuration of points realizing a list $L(1, \dots, 8)$ and giving rise to some pencil \mathcal{P} . Move the configuration preserving the list,

the combinatorial pencil degenerates only if some base point A among $1, \dots, 8$ comes together with 9. But this amounts to say that each point $G \neq A \in \{1, \dots, 8\}$ comes onto the cubic (\hat{G}, A) . \square

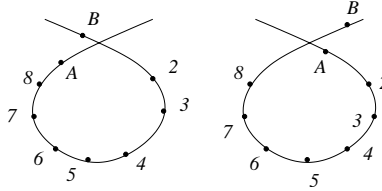

Figure 21: $C_3^1, C_3^2: (A, B) = (1, 9), C_3^3, C_3^4: (A, B) = (9, 1)$

Propositions 4 and 7 imply immediately:

Proposition 8 *Let $1, \dots, 8$ be eight points in convex position, realizing a non-nodal list L . Let A, B be two of these points, consecutive for the cyclic ordering. We may move the set of points, shifting A towards B , in such a way that the combinatorial pencil does not degenerate till $A = B$ (if $A \rightarrow B = 0$) or till A reaches the first of the n conics separating A from B (if $A \rightarrow B \neq 0$).*

3.2 Pairs of distinguished cubics

In what follows, we call cubic C_3 a combinatorial cubic $(C_3, 1, \dots, 8)$ (the position of 9 is not yet specified). We define an encoding for distinguished cubics, that is consistent with the action of D_8 . Let $(1-, N), N = 3, \dots, 8$ be the cubic obtained from $(1-, N)_{nod}$, shifting N away from the node X onto the arc $X2$ of the loop, and let $(N, 1-), N = 3, \dots, 7$ be the cubic obtained from $(1-, N)_{nod}$, shifting N away from the node onto the arc $X1$ of the odd component, see Figure 22. For $(P, Q) = (3, 4), (4, 5), \dots, (8, 1)$, denote by $(1-, PQ)$, the cubic obtained from $(1-, P)_{nod}$ (or $(1-, Q)_{nod}$) shifting the node X away from P (or Q) into the interior of the arc PQ . Let $(1-, E)$ (E stands for *end*) be the cubic that could be defined as $(1-, N)$, with $N = 2$ or as $(1-, PQ)$, with $(P, Q) = (2, 3)$. We chose the specific notation to avoid double notation for one single cubic type. The cubics encoded hereabove are called *cubics of the family $1-$* . At last, denote by $(81, L)$ and $(81, C)$ the first and the second cubic in Figure 23. The letters L and C stand respectively for *loop* and *odd component*.

In section 5 where we classify the pencils, we will consider combinatorial cubics $(C_3, 1, \dots, 9)$. To encode them, we use the notation defined here for $(C_3, 1, \dots, 8)$, enhanced with the position of 9. The cubic $C_3 = (C_3, 1, \dots, 8)$ is divided into 9 successive arcs by the points $1, \dots, 8, X$. If $C_3 = (81, L)$, then 9 lies on the arc XX . If C_3 is of the family $N\epsilon$, percource C_3 starting from N in the direction ϵ , and write which oriented arc contains 9, see Figures 35-37.

Let $1, \dots, 8$ realize a list L and a pencil \mathcal{P} . Assume we know L and not \mathcal{P} . We explain hereafter how to determine pairs of distinguished cubics of \mathcal{P} .

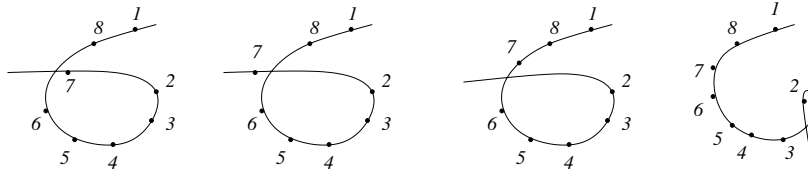

Figure 22: Cubics $(1-, 7)$, $(7, 1-)$, $(1-, 67)$ and $(1-, E)$

The position of 9 is not specified, it can sometimes be found using Bezout's theorem. Move $1, \dots, 8$, shifting 8 towards 1 till 8 reaches 1 (if $8 \rightarrow 1 = 0$) or 8 reaches the first of the six conics separating it from 1 (if $8 \rightarrow 1 \neq 0$), see Proposition 4. The only other base point of the pencil that moves is 9. *Assume that in the motion, the eight points are never on a cubic with node at one of them.* This condition is always achieved if the list is non-nodal. More generally, if the condition is achieved for a given set of points $1, \dots, 8$, if $8 \rightarrow 1 \neq 0$, we say that the corresponding elementary change is realizable starting from this set of points. The mobile pencil $\mathcal{P}(1, \dots, 8)$ is preserved all along, except in the end, when it becomes a singular pencil \mathcal{P}_{sing} . Let C_3^0, C_3^1 and C_3^2 be the three singular cubics involved, see section 1.2. A *close pair* is a pair $\hat{A} = B\epsilon, \hat{B} = A\epsilon$ or $\hat{A} = \hat{B} = N\epsilon$, with A, B consecutive. Up to the action of D_8 there are seven close pairs: $\hat{8} = 1+, \hat{1} = 8+, \hat{8} = \hat{1} = N+, N = 2, \dots, 7$.

1. If $8 \rightarrow 1 = 0$, the singular cubic C_3^0 , with double point at $8 = 1$, is identical to both $(\hat{8}, 1)$ and $(\hat{1}, 8)$ (auxiliary cubics). The close pairs $\hat{8} = \hat{1} = 2+$ or $7-$ (deduced one from the other by $(+1)(48)$) are *inessential*: one does not know a priori whether the double points of the auxiliary cubics are isolated or not. Therefore, the cubics C_3^1, C_3^2 may be non-real. There are in total 16 inessential close pairs (one orbit). For the other close pair $(\hat{1}, \hat{8})$ (essential close pairs), the auxiliary cubics have each a non-isolated double point. All along the motion $8 \rightarrow 1$, the position of 1 with respect to $(\hat{1}, 8)$ and the position of 8 with respect to $(\hat{8}, 1)$ are preserved. Using Bezout's theorem with these cubics, one finds out the corresponding pair C_3^1, C_3^2 . In all of the cases, any one of the four combinatorial data: cubic $(\hat{1}, 8)$ enhanced with the position of 1, cubic $(\hat{8}, 1)$ enhanced with the position of 8, cubic C_3^1 , and cubic C_3^2 determines the other three. The close pairs $(\hat{8} = 1+, \hat{1} = 8+)$ and $(\hat{8} = 1-, \hat{1} = 8-)$ give the same three admissible pairs C_3^1, C_3^2 , they are shown in the upper part of Figure 23, along with the auxiliary cubics.

$$\begin{aligned} & (81, L), (81, C) \\ & (8+, 1), (8-, 78) \\ & (1+, 12), (1-, 8) \end{aligned}$$

The other close pairs $(\hat{8}, \hat{1})$ give each rise to two admissible pairs C_3^1, C_3^2 , see the tabular hereafter, where N ranges from 3 to 6. Note that all of

these cubics C_3^1, C_3^2 are distinguished. The case $\hat{8} = \hat{1} = 7+$ is shown in the lower part of Figure 23.

$$\begin{array}{cccc}
\hat{8} = \hat{1} = 7+ & \hat{8} = \hat{1} = 2- & \hat{8} = \hat{1} = N+ & \hat{8} = \hat{1} = N- \\
(7+, 8), (1, 7+) & (2-, 8), (12, C) & (N+, 1), (8, N+) & (N-, 8), (1, N-) \\
(78, C), (7+, 1) & (2-, 1), (8, 2-) & (N+, 8), (1, N+) & (N-, 1), (8, N-)
\end{array}$$

2. If $8 \rightarrow 1 \neq 0$, one has $C_3 = C_2 \cup (1P), P \in \{2, \dots, 7\}$. If: $P = 2$ and both 1 and 2 are outside of $C_2 = 34567$, then one does not know a priori whether the double points of the reducible cubic C_3^0 are real or complex conjugated. Therefore, the cubics C_3^1, C_3^2 may be non-real. Let 8 goes to the outside of $C_2 = 34567$, $1, 2 > 34567$, the elementary change is: $\hat{1} : 2- \rightarrow 2+, \hat{2} : 1- \rightarrow 1+$, it is *inessential*. There are in total 16 inessential elementary changes (one orbit). In the other cases, either cubic C_3^1, C_3^2 may be obtained from the reducible cubic C_3^0 by perturbing one of the double points of C_3^0 . All of the pairs obtained are distinguished cubics. Indeed, let s be the intersection of the line $(1P)$ with the interior of C_2 , and let s_1, s_2 be the two arcs of C_2 on either side of $(1P)$. The loop of each cubic C_3^1, C_3^2 is obtained perturbing one of the $s_i \cup s, i \in \{1, 2\}$, and both $s_i \cup s$ contain some points among $1, \dots, 8$. We give an example in Figure 24, the elementary pair is $(\hat{1} : 5+, \hat{5} : 8-)$, the corresponding pair of distinguished cubics is $(5, 8-), (5+, 1)$.

The first elementary change $\hat{1} : 2- \rightarrow 2+, \hat{2} : 1- \rightarrow 1+$ in Figures 17-18 is inessential. The changes of distinguished cubics corresponding to the last 18 elementary changes are displayed in Figure 25. We say that these changes are *essential*. An elementary pair appearing in some (in)essential elementary change will be called (in)essential elementary pair. Up to the action of D_8 , two pairs are both elementary and close: $(\hat{1} = 8+, \hat{8} = 1+)$ (essential only as close pair), and $(\hat{1} = \hat{8} = 2+)$ (essential only as elementary pair). If a list L is non-nodal, each essential elementary pair of L gives a pair of distinguished cubics, see Figure 25, and each essential close pair of L gives two or three admissible pairs of distinguished cubics. The rest of the list allows to determine which pair of cubics is actually realized.

3.3 Simultaneous changes of lists and pencils, exceptions

Let $1, \dots, 8$ be eight generic points lying in strictly convex position in $\mathbb{R}P^2$, realizing a list $L(1, \dots, 8)$ and a pencil $\mathcal{P} = \mathcal{P}(1, \dots, 8)$. Move the eight points, keeping them distinct and strictly convex. At some moment, a degeneration $\mathcal{P} \rightarrow \mathcal{P}_{sing}$ occurs, after which one gets a new pencil \mathcal{P}' , see section 1.2. We are interested only in the degeneration that affect the combinatorial pencil, so we leave aside the cases 1b, 2b, 2c, 2d. When the list undergoes an elementary change, six of the eight chosen base points become coconic, 9 becomes aligned with the other two. If the change is essential, the new pencil \mathcal{P}' is obtained from

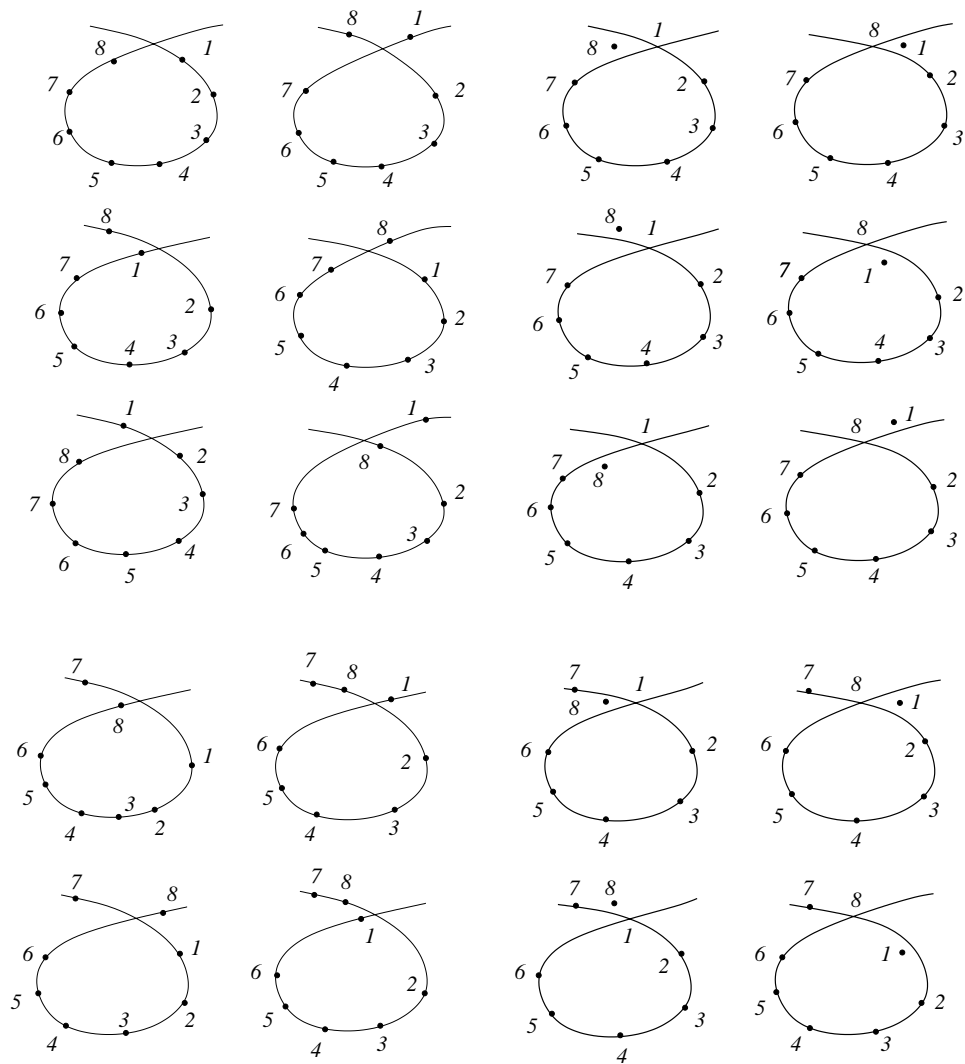

Figure 23: Cubics obtained with the close pairs ($\hat{8} = 1\pm, \hat{1} = 8\pm$), and ($\hat{8} = \hat{1} = 7+$)

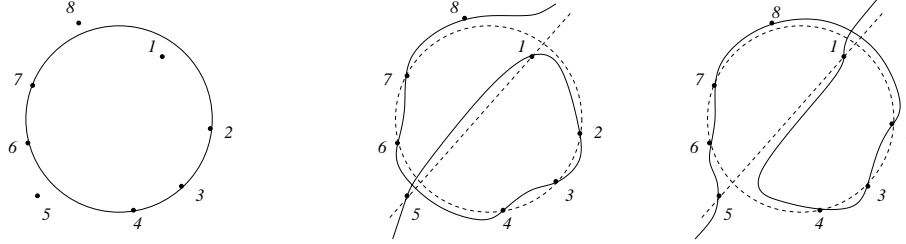

Figure 24: Cubics obtained with the elementary pair $(\hat{1} : 5+, \hat{5} : 8-)$

$(1+, 2) \rightarrow (1-, E)$	$(1-, E) \rightarrow (1+, 2)$	$(8-, 2) \rightarrow (23, L)$
$(1, 3+) \rightarrow (1+, 12)$	$(1+, 12) \rightarrow (1, 3+)$	$(81, L) \rightarrow (3+, 1)$
$(3, 1+) \rightarrow (3, 1-)$	$(3, 1-) \rightarrow (3, 1+)$	$(1+, 3) \rightarrow (1-, 3)$
$(1, 3-) \rightarrow (1, 3+)$	$(1, 3+) \rightarrow (1, 3-)$	$(12, C) \rightarrow (1, 4+)$
$(1-, 3) \rightarrow (1+, 3)$	$(8-, 3) \rightarrow (2+, 3)$	$(2+, 3) \rightarrow (8-, 3)$
$(1, 4+) \rightarrow (12, C)$	$(4+, 1) \rightarrow (2-, 1)$	$(2-, 1) \rightarrow (4+, 1)$
$(4, 1+) \rightarrow (4, 1-)$	$(4, 1-) \rightarrow (4, 1+)$	$(1+, 4) \rightarrow (1-, 4)$
$(1, 4+) \rightarrow (1, 4-)$	$(1, 4-) \rightarrow (1, 4+)$	$(1, 5+) \rightarrow (1, 3-)$
$(1-, 4) \rightarrow (1+, 4)$	$(8-, 4) \rightarrow (2+, 4)$	$(2+, 4) \rightarrow (8-, 4)$
$(1, 3-) \rightarrow (1, 5+)$	$(3-, 1) \rightarrow (5+, 1)$	$(5+, 1) \rightarrow (3-, 1)$
$(5, 1+) \rightarrow (5, 1-)$	$(1+, 5) \rightarrow (1-, 5)$	$(8-, 5) \rightarrow (2+, 5)$
$(1, 5-) \rightarrow (1, 5+)$	$(1, 4-) \rightarrow (1, 6+)$	$(6+, 1) \rightarrow (4-, 1)$

Figure 25: Changes of pairs of distinguished cubics

\mathcal{P} by replacing the pair of distinguished cubics C_3^1, C_3^2 by a new pair C_3^3, C_3^4 (case 2a). If the change is inessential, we are in case 2a or 2b. In case 2a, one only of the two cubics C_3^1, C_3^2 is distinguished, and one recovers the same pair of combinatorial cubics after the degeneration (left to the reader). Performing an inessential change on the list doesn't change the pencil. Conversely, one may sometimes change the pencil without changing the list. The degeneration occurs letting one of the first eight base points A come together with 9 (1a). The cubic C_3^0 of \mathcal{P}_{sing} passes through $1, \dots, 8$ and has a node at one of these points, the corresponding list $L(1, \dots, 8)$ is nodal. Move further, the new generic pencil \mathcal{P}' is deduced from \mathcal{P} swapping the positions of A and 9 on all of the eight distinguished (combinatorial) cubics. Performing an inessential change on a nodal list yields again a nodal list. So, if a pencil is realizable by two different lists, these lists are both non-nodal or both nodal. In the latter case, we say that the pencil is *nodal*.

4 Lists with configurations of six coconic points, pencils with reducible cubics

4.1 Lists obtained perturbing four reducible cubics

Among the principal lists, exactly ten have a set of four disjoint elementary pairs. The lists L_n with $n = 11, 12, 13, 14, 19, 20, 21, 22$, have each disjoint elementary pairs $(\hat{1}, \hat{8}), (\hat{2}, \hat{7}), (\hat{3}, \hat{6}), (\hat{4}, \hat{5})$. Each of the two lists L_n with $n = 88, 92$ has disjoint elementary pairs $(\hat{1}, \hat{5}), (\hat{2}, \hat{6}), (\hat{3}, \hat{7}), (\hat{4}, \hat{8})$. We explain hereafter how to realize these lists directly.

Consider a pair of ellipses intersecting at four points, 1, 3, 5, 7, see Figure 26. Denote by 9 the intersection of the diagonal lines 15 and 37. Draw a vertical and a horizontal line, both passing through 9. Let 4, 8, 2, 6 be four supplementary points chosen such as: 4, 8 are the intersections of the vertical line with one ellipse; 2, 6 are the intersections of the horizontal line with the other ellipse; each pair of points lying on one ellipse is in the interior of the other. By construction, the points $1, \dots, 8$ lie in convex position. Moreover, there exist two supplementary conics passing through six points: 234678 and 124568. As a matter of fact, the pencil of cubics \mathcal{P} determined by $1, \dots, 8$ has 9 as ninth base point and four distinguished cubics, all of them reducible: $498 \cup 123567$, $296 \cup 134578$, $397 \cup 124568$ and $195 \cup 234678$. Let us perturb the pencil, moving slightly the points 8 and 9. As 1, 2, 3, 5, 6, 7 are on a conic, 8, 4 and 9 must stay aligned. The point 8 leaves the three conics 23467, 12456, 13457. Letting 8 cross each conic from the inside to the outside yields the following elementary moves: Conic 23467: $(\hat{1} = 5-, \hat{5} = 1+) \rightarrow (\hat{1} = 5+, \hat{5} = 1-)$. Conic 12456: $(\hat{3} = 7-, \hat{7} = 3+) \rightarrow (\hat{3} = 7+, \hat{7} = 3-)$. Conic 13457: $(\hat{2} = 7+, \hat{6} = 1-) \rightarrow (\hat{2} = 5-, \hat{6} = 3+)$. Let us now move 3 away from the conic 12567. Letting 3 cross 12567 from the inside to the outside yields the following elementary move: $(\hat{4} = 7-, \hat{8} = 5+) \rightarrow (\hat{4} = 1+, \hat{8} = 3-)$. The first perturbation may be done so as to realize six different positions of 8 with respect to the set of conics 23467,

12456, 13457. Then, move 3 to the outside of 12567. We obtain the first five lists, and the last list of Figure 14, among which we find L_{88} and L_{92} .

Consider a pair of ellipses intersecting at four points 2, 4, 5, 7, see Figure 27. Denote by 9 the intersection of the lines 27 and 45. Draw a line Δ passing through 9 and cutting the ellipses on their arcs 57 and 24. Let 6 and 3 be the intersections of Δ with one ellipse, chosen so that these points lie outside of the second ellipse. Draw a line Δ' passing through 9 and cutting the second ellipse at two points 8, 1 on the arc 72. One may choose Δ' in such a way that the points 1, ... 8 lie in convex position. By construction, there exist two supplementary conics passing through six of the points: 123678 and 134568. The pencil of cubics \mathcal{P} determined by 1, ..., 8 has 9 as ninth base point and four distinguished cubics, all of them reducible: $189 \cup 234567$, $369 \cup 124578$, $459 \cup 123678$ and $279 \cup 134568$. Let us perturb the pencil, moving the points 8 and 9. The point 8 leaves the three conics 13456, 12457, 12367. Letting 8 cross each conic from the inside to the outside yields the following elementary moves: Conic 13456: $(\hat{2} = 6-, \hat{7} = 1-) \rightarrow (\hat{2} = 8+, \hat{7} = 3+)$. Conic 12457: $(\hat{3} = 6+, \hat{6} = 3+) \rightarrow (\hat{3} = 6-, \hat{6} = 3-)$. Conic 12367: $(\hat{4} = 3-, \hat{5} = 3-) \rightarrow (\hat{4} = 6+, \hat{5} = 6+)$. Let us now move 7 away from the conic 23456. Letting 7 cross 23456 from the inside to the outside yields the following elementary move: $(\hat{1} = 8+, \hat{8} = 1+) \rightarrow (\hat{1} = 8-, \hat{8} = 1-)$. The first perturbation may be done so as to realize six different positions of 8 with respect to the set of conics 13456, 12457, 12367. Then, move 7 to the inside of 23456. We obtain the lists $L_{11}, L_{12}, L_{14}, L_{19}, L_{21}, L_{22}$. Starting again from the pencil with four reducible cubics we realize the two missing lists as follows. List L_{13} : move first 7 to the outside of 12458 and the inside of 12368; then, move 8 to the outside of 13456. List L_{20} : move first 6 to the outside of 23457 and the inside of 12378; then move 8 to the outside of 12457.

Proposition 9 *Let 1, ... 8 be eight points lying in convex position in the plane and let k be the number of conics passing through exactly six of them. One has $k \leq 4$. If $k = 4$, then the points realize, up to the action of D_8 , one of the two non-generic lists shown in Figures 26-27. The orbit of the first list has two elements, the orbit of the second list has eight elements.*

Proof: Perturbing slightly the configuration 1, ... 8 must yield a generic list with four distinct elementary pairs, otherwise stated a list that is in the orbit of some of the 10 lists L_n . Up to the action of D_8 , the original configuration 1, ... 8 must be as shown in Figure 26 or 27. The list l of Figure 26 is encoded by the data: $2, 6 < 134578$, $4, 8 < 123567$, $1, 5 > 234678$, $3, 7 > 124568$. This list is invariant by the action of id , 15, 26, 37, 48, +2, -2, +4. The list l' of Figure 27 is encoded by the data: $1, 8 > 234567$, $5, 4 < 123678$, $2, 7 < 134568$, $3, 6 > 124578$. This list is invariant by the action of $(+1)(48)$. \square

A pencil of cubics with eight base points lying in convex position in the real plane (no seven of them being coconic) has at most four reducible cubics,

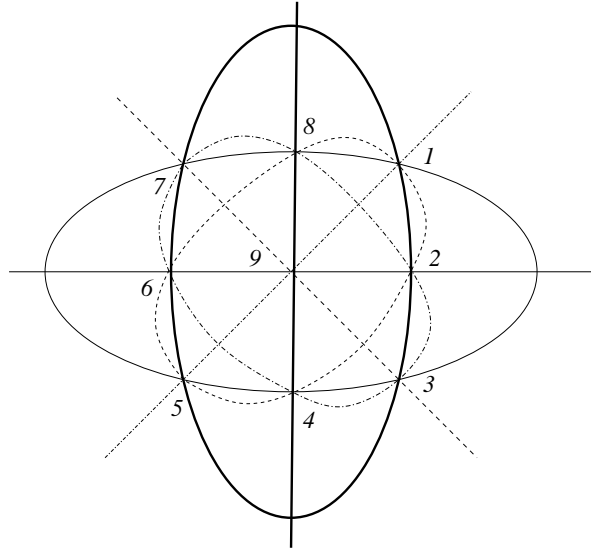

Figure 26: First configuration of points with four reducible cubics

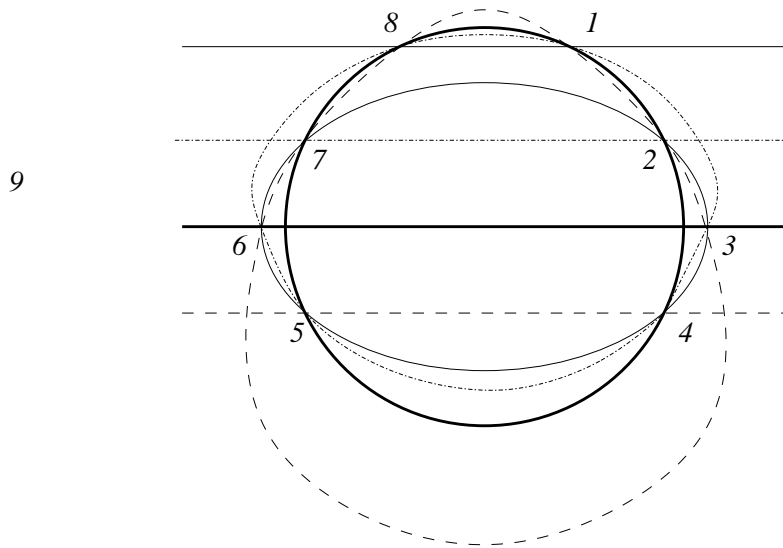

Figure 27: Second configuration of points with four reducible cubics

the corresponding four lines pass all through the ninth base point. In the next section, we drop the condition of convexity and search for more singular pencils.

4.2 A singular pencil with base points in non-convex position

Let us say that a cubic is *completely reducible* if it is the product of three lines. A complex pencil contains at most four such cubics [7], [8], the corresponding twelve lines and the nine base points are such that: each point lies on four lines and each line passes through three points. Recall that the nine inflection points of a complex cubic C_3 realize such a configuration. The *Hessian pencil* associated to C_3 is the pencil generated by C_3 and its Hessian, based at the inflection points of C_3 . The Hessian pencils realize the upper bound of four completely reducible cubics.

Let us now go back to pencils with only real base points. A pencil with nine real base points cannot have four completely reducible cubics: the Sylvester-Gallai theorem states that given n points in the real plane, they are either all collinear or there exists a line containing exactly two of them (see e.g.[1]). Consider the pencil generated by the two completely reducible cubics (one bold, one dotted) in Figure 28, the base points are denoted by A, \dots, I . We recover an elementary proof of Pascal's theorem: assume that G, H, I are on a line, and let C_2 be a conic passing through five of the other base points. Then, the cubic $(GHI) \cup C_2$ belongs to the pencil, otherwise stated, A, B, C, D, E, F are coconic. Conversely, if A, \dots, F are coconic, then G, H, I are aligned. The particular case where C_2 is the product of two lines is Pappus' theorem, the pencil here has three completely reducible cubics.

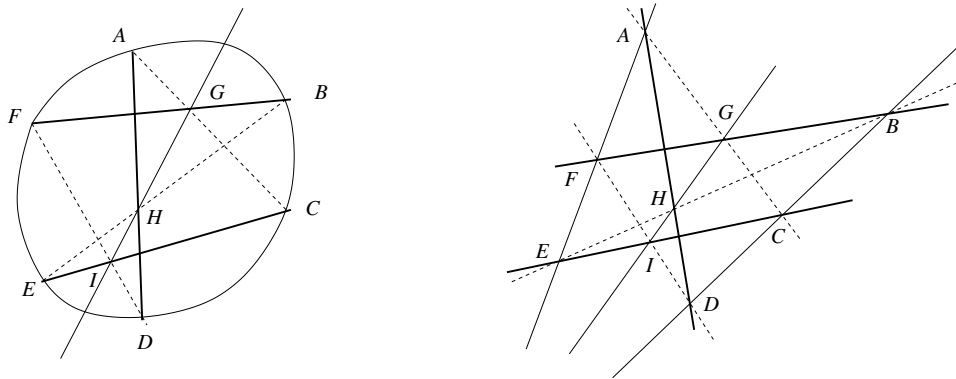

Figure 28: Pascal's and Pappus' theorems

Let us now search for a pencil having the maximal number of six reducible cubics. Each of the corresponding six lines must pass through exactly three base points. If one point lies on four of these lines, then a fifth line intersects these four at four base points, contradiction. If each base point lies on at

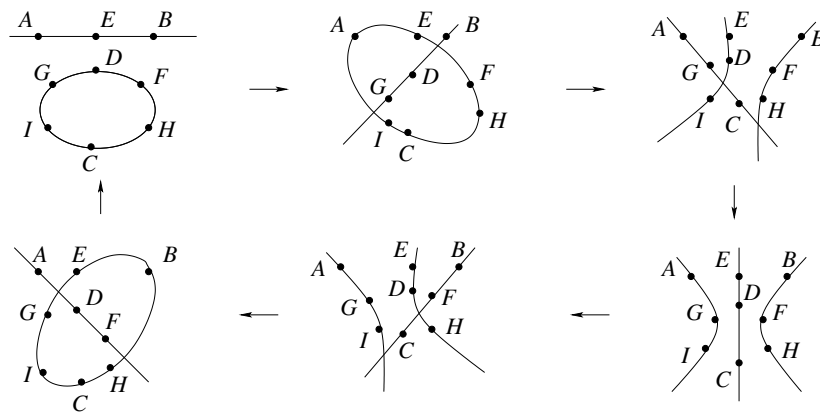
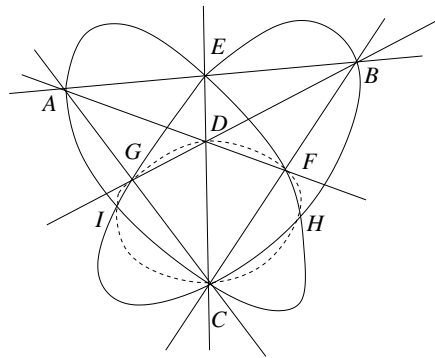

Figure 29: Pencil with six reducible cubics

most two lines, draw five lines, each of them passes through four base points, contradiction again. Thus, one point lies on exactly three lines, six other base points are distributed pairwise on these lines. Draw two further lines, they must intersect at one of these six points, otherwise they would pass each through four base points. We get thus the following distribution of the base points on the lines and the conics: four points A, B, C, D lie each on three lines and three conics, three points D, E, F lie each on two lines and four conics and the other two points H, I lie each on six conics. Assume that H, I are also real. Up to the action of the symmetric group \mathcal{S}_4 on the first chosen base points A, B, C, D , the sequence of reducible cubics is as shown in Figure 29. Note that the non-singular cubics of the pencil are all disconnected.

4.3 Symmetric lists

We proved in section 2.2 that a generic list is preserved by no element of D_8 , otherwise stated, each orbit contains 16 lists. Let us now search for the non-generic lists that are invariant for some element of D_8 , we met two of them, l and l' , in section 4.2. Let λ_0 be the list 12345678 consisting of eight coconic points. We say that a list is *almost generic* if it has one unique configuration of six coconic points.

Proposition 10 *Each element of D_8 leaves some non-generic lists invariant: (± 1) and (± 3) : λ_0 ; (± 2) and (± 4) : λ_0, l and $(+1)l$; $(+1)(48)$: $\lambda_0, l', (+4)l' = (+1)(26)l'$; 15: λ_0 , four lists with seven coconic points, two lists with each four sets of six coconic points, ten lists with each three sets of six coconic points, two lists with each two sets of six coconic points and 24 almost generic lists, divided in two groups of 12 that are mapped one onto the other by $(+4)$ (or equivalently 37). All of these lists have a conic 234678. See description ahead and Figures 30-32.*

In what follows, a stands for a cyclic permutation, and σ for a symmetry 15, 26, 37 or 48. Recall that any two cyclic permutations commute, whereas $a\sigma = \sigma(-a)$. Let m be a cyclic permutation, and L be a list such that $m \cdot L = L$. Any list L' in the orbit of L is also invariant under the action of m and $-m$. Up to the action of D_8 , we may assume that L contains a conic $C_2 = 123456, 123457, 123467$ or 123567 . Moreover, L contains the images of this conic by $m, m \circ m \dots$ and if $P < C_2$, then $m \cdot P < m \cdot C_2$. One finds out easily that $(\pm 1), (\pm 3)$ preserve only λ_0 , whereas $(\pm 2), (\pm 4)$ preserve each three lists: λ_0, l and $(+1)l$. A list invariant by $(+1)(48)$ must contain the conics 124578, 134568, 123678 and 234567. Thus, $(+1)(48)$ preserves three lists: λ_0, l' and $(+4)l' = (+1)(26)l'$. A list invariant by 15 must contain a conic 234678. Let us first look for the almost generic lists. Let L be such a list, the orbit of L contains eight elements, each symmetry σ leaves two of them invariant. If $\sigma \cdot L' = L'$, one may perturb L' in two ways to get generic lists that are deduced from one another by σ . The 16 generic lists thus obtained form an orbit of D_8 . We select all of the principal lists having an elementary pair (\hat{N}, \hat{M}) , with $(N, M) = (1, 5), (2, 6), (3, 7)$ or $(4, 8)$,

and such that the non-generic list obtained making the six points different from N, M coconic is invariant by the symmetry NM . Up to cyclic permutations, we get thus 24 almost generic lists invariant by 15, they split in two groups of 12 that are deduced from one another by the action of +4 (or 37). These lists may be obtained also as perturbations of more singular lists invariant by 15.

1. If 1 or 5 lies on 234678

- (a) One list with eight coconic points: $\lambda_0 = 12345678$
- (b) Four lists with seven coconic points: $5 < 1234678, 5 > 1234678, 1 < 2345678, 1 > 2345678$.

2. If $1 > 234678$ and $5 < 234678$

- (a) Four almost generic lists l_1, l_2, l_3, l_4
- (b) Three lists $\lambda_1, \lambda_2, \lambda_3$ having each two more configurations of six coconic points:

$$\begin{aligned} \lambda_1 : 123456, 145678; & \quad \lambda_2 : 123457, 135678; \\ & \quad \lambda_3 : 123458, 125678 \end{aligned}$$

3. If $1 < 234678$ and $5 > 234678$

- (a) Four almost generic lists $l'_i = (+4)(l_i)$
- (b) Three lists $\lambda'_i = (+4)(\lambda_i)$ having each two more configurations of six coconic points:

$$\begin{aligned} \lambda'_1 : 123458, 125678; & \quad \lambda'_2 : 123457, 135678; \\ & \quad \lambda'_3 : 123456, 145678 \end{aligned}$$

4. If $1 > 234678$ and $5 > 234678$

- (a) Eight almost generic lists $l_5, l_6, l_7, l_8, l'_5, l'_6, l'_7, l'_8$,
- (b) Four lists having each one more configuration of six coconic points:

$$\begin{aligned} \lambda_4 : 123578; & \quad \lambda_5 = (+4)(L_4) : 134567; \\ & \quad \lambda_6, \lambda_7 = (+4)(L_6) : 124568 \end{aligned}$$

- (c) Two lists having each two more configurations of six coconic points:

$$\lambda_8, \lambda_9 = (+4)(\lambda_8) : 123567, 134578$$

- (d) One list with three more configurations of six coconic points:

$$\lambda_{10} = l : 124568, 134578, 123567$$

5. $1 < 234678$ and $5 < 234678$

- (a) Eight almost generic lists $l_9, l_{10}, l_{11}, l_{12}, l'_9, l'_{10}, l'_{11}, l'_{12}$
- (b) Four lists having each one more configuration of six coconic points:

	l_1	l_2	l_3	l_4
$\hat{1}$	$6+ \leftrightarrow 4-$	$6+ \leftrightarrow 4-$	$6+ \leftrightarrow 4-$	$6+ \leftrightarrow 4-$
$\hat{2}$	$1-$	$4-$	$4+$	$4-$
$\hat{3}$	$1-$	$4+$	$4+$	$4-$
$\hat{4}$	$1-$	$3+$	$1-$	$3-$
$\hat{5}$	$1- \leftrightarrow 1+$	$1- \leftrightarrow 1+$	$1- \leftrightarrow 1+$	$1- \leftrightarrow 1+$
$\hat{6}$	$1+$	$7-$	$1+$	$7+$
$\hat{7}$	$1+$	$6-$	$6-$	$6+$
$\hat{8}$	$1+$	$6+$	$6-$	$6+$
	l'_1	l'_2	l'_3	l'_4
$\hat{1}$	$5- \leftrightarrow 5+$	$5- \leftrightarrow 5+$	$5- \leftrightarrow 5+$	$5- \leftrightarrow 5+$
$\hat{2}$	$5+$	$3-$	$5+$	$3+$
$\hat{3}$	$5+$	$2-$	$2-$	$2+$
$\hat{4}$	$5+$	$2+$	$2-$	$2+$
$\hat{5}$	$2+ \leftrightarrow 8-$	$2+ \leftrightarrow 8-$	$2+ \leftrightarrow 8-$	$2+ \leftrightarrow 8-$
$\hat{6}$	$5-$	$8-$	$8+$	$8-$
$\hat{7}$	$5-$	$8+$	$8+$	$8-$
$\hat{8}$	$5-$	$7+$	$5-$	$7-$

Figure 30: Almost generic symmetric lists (first)

$$\lambda_{11} : 123578; \quad \lambda_{12} = (+4)(\lambda_{11}) : 134567;$$

$$\lambda_{13}, \lambda_{14} = (+4)(\lambda_{13}) : 124568$$

(c) Two lists having each two more configurations of six coconic points:

$$\lambda_{15}, \lambda_{16} = (+4)(\lambda_{15}) : 123567, 134578$$

(d) One list having three more configurations of six coconic points:

$$\lambda_{17} = (+1)(\lambda_{10}) = (+1)(l) : 124568, 123567, 134578$$

	l_5	l_6	l_7	l_8
$\hat{1}$	$5- \leftrightarrow 5+$	$5- \leftrightarrow 5+$	$5- \leftrightarrow 5+$	$5- \leftrightarrow 5+$
$\hat{2}$	$1+$	$7+$	$7+$	$7-$
$\hat{3}$	$1+$	$7-$	$7+$	$1+$
$\hat{4}$	$1+$	$1+$	$1+$	$1+$
$\hat{5}$	$1+ \leftrightarrow 1-$	$1+ \leftrightarrow 1-$	$1+ \leftrightarrow 1-$	$1+ \leftrightarrow 1-$
$\hat{6}$	$1-$	$1-$	$1-$	$1-$
$\hat{7}$	$1-$	$3+$	$3-$	$1-$
$\hat{8}$	$1-$	$3-$	$3-$	$3+$

	l'_5	l'_6	l'_7	l'_8
$\hat{1}$	$5- \leftrightarrow 5+$	$5- \leftrightarrow 5+$	$5- \leftrightarrow 5+$	$5- \leftrightarrow 5+$
$\hat{2}$	$5-$	$5-$	$5-$	$5-$
$\hat{3}$	$5-$	$7+$	$7-$	$5-$
$\hat{4}$	$5-$	$7-$	$7-$	$7+$
$\hat{5}$	$1+ \leftrightarrow 1-$	$1+ \leftrightarrow 1-$	$1+ \leftrightarrow 1-$	$1+ \leftrightarrow 1-$
$\hat{6}$	$5+$	$3+$	$3+$	$3-$
$\hat{7}$	$5+$	$3-$	$3+$	$5+$
$\hat{8}$	$5+$	$5+$	$5+$	$5+$

Figure 31: Almost generic symmetric lists (second)

	l_9	l_{10}	l_{11}	l_{12}
$\hat{1}$	$6+ \leftrightarrow 4-$	$6+ \leftrightarrow 4-$	$6+ \leftrightarrow 4-$	$6+ \leftrightarrow 4-$
$\hat{2}$	$8+$	$6-$	$6+$	$8-$
$\hat{3}$	$8-$	$8+$	$8+$	$8-$
$\hat{4}$	$8-$	$8-$	$8+$	$8-$
$\hat{5}$	$8- \leftrightarrow 2+$	$8- \leftrightarrow 2+$	$8- \leftrightarrow 2+$	$8- \leftrightarrow 2+$
$\hat{6}$	$2+$	$2+$	$2-$	$2+$
$\hat{7}$	$2+$	$2-$	$2-$	$2+$
$\hat{8}$	$2-$	$4+$	$4-$	$2+$

	l'_9	l'_{10}	l'_{11}	l'_{12}
$\hat{1}$	$6+ \leftrightarrow 4-$	$6+ \leftrightarrow 4-$	$6+ \leftrightarrow 4-$	$6+ \leftrightarrow 4-$
$\hat{2}$	$6+$	$6+$	$6-$	$6+$
$\hat{3}$	$6+$	$6-$	$6-$	$6+$
$\hat{4}$	$6-$	$8+$	$8-$	$6+$
$\hat{5}$	$8- \leftrightarrow 2+$	$8- \leftrightarrow 2+$	$8- \leftrightarrow 2+$	$8- \leftrightarrow 2+$
$\hat{6}$	$4+$	$2-$	$2+$	$4-$
$\hat{7}$	$4-$	$4+$	$4+$	$4-$
$\hat{8}$	$4-$	$4-$	$4+$	$4-$

Figure 32: Almost generic symmetric lists (third)

5 Classification of the pencils of cubics

5.1 Nodal pencils

We will use the method exposed in section 3.2 to construct the nodal pencils. Let T be the triangle (12), (67), (17) containing 8. The condition that $1, \dots, 8$ realizes the list $\max(\hat{1} = 8-)$ splits into eight disjoint subconditions. There is an ordering $14567 > (\hat{8}, 1) > (\hat{8}, 7) > (\hat{8}, 6) > \dots > (\hat{8}, 2) > 34567$ in T : the point 8 lies between two consecutive of these curves. When 8 lies on a cubic $(\hat{8}, N)$, otherwise stated, when the eight chosen base points are on a cubic $(1-, N)_{nod}$, the pencil is singular, with $9 = N$. By Bezout's theorem with the cubics $(\hat{8}, N)$, the degeneration $9 = 8$ may occur only if 8 lies between $(\hat{8}, 1)$ and $(\hat{8}, 7)$. Start with 8 between 14567 and $(\hat{8}, 1)$, the elementary change 8 goes to the outside of 14567, $2, 3 < 14567$ writes: $\hat{2} : 1- \rightarrow 4+, \hat{3} : 1- \rightarrow 4+$, it is realizable. The essential elementary pair $(\hat{2} = 1-, \hat{3} = 1-)$ gives thus two cubics: $(1-, 3)$, $(12, L)$. The ninth base point 9 must lie on the odd component of $(12, L)$, by Bezout's theorem, it lies then on the arc $1X$ of $(1-, 3)$. We have $3 \rightarrow 4 = 0$, the close pair $(\hat{3} = 1-, \hat{4} = 1-)$ gives two admissible pairs of cubics: $(3, 1-), (1-, 4)$ or $(1-, 3), (4, 1-)$. We know already that $(1-, 3)$ belongs to the pencil, so the correct pair is the first one. Using the other pairs of consecutive points A, B with $A \rightarrow B = 0$, we get other cubics: the pair 4, 5 gives again $(4, 1-)$ and a new cubic $(1-, 5)$, the pairs 5, 6 and 6, 7 give $(6, 1-)$ and $(1-, 7)$. Note that 2, 3 gives $(\hat{2} = 1-, \hat{3} = 1-)$, inessential as close pair. The position of 9 on each cubic is again obtained with Bezout's theorem. Up to now, we have six cubics. Note that all of them have an arc 81, so the missing cubics correspond to the openings of this arc. Starting from $(12, L)$, move into the portion formed of cubics with ovals. The next distinguished cubic will be $(81, L)$, the overnext is $(81, C)$. The complete pencil is shown in the first row of Figure 35. Let now 8 percourse a path p crossing successively $(\hat{8}, 1)$ and $(\hat{8}, 7)$. We will prove that at some moment, 8 must indeed come together with 9. Letting 8 cross $(\hat{8}, 1)$ changes the pencil swapping the positions of 1 and 9 on all combinatorial cubics, see second row of Figure 35. The point 8 lies now in the zone between the arcs 17 of $(\hat{8}, 1)$ and $(\hat{8}, 7)$, this zone is divided in an upper and a lower part by the path p . Applying Bezout's theorem with $(\hat{8}, 1)$ and $(1-, 81), 2X$ on one hand, and with $(\hat{8}, 7)$ and $(1-, 7), 18$ on the other hand, we get that 9 lies also in this zone. When 8 percourses the path p from $(\hat{8}, 1)$ and $(\hat{8}, 7)$, the point 9 moves from 1 to 7. Let 9 cross p at some point P and assume that at this moment, 8 has the position Q . Assume first that Q lies ahead from P , see Figure 33. When 8 had previously the position P , the point 9 was in still in the upper zone. But on the other hand, 9 must have been positioned at Q . This is a contradiction. One gets a similar contradiction taking Q behind P on the path. So, at some moment, one must have $9 = 8$. Letting 8 cross successively $(\hat{8}, 1), \dots, (\hat{8}, 2)$, we obtain in total the first nine pencils of Figure 35, they are drawn in Figure 34 where

$$(G, H, I, A, B, C, D, E, F) = (9, 2, 3, 4, 5, 6, 7, 8, 1), (1, 2, 3, 4, 5, 6, 7, 8, 9), \\ (1, 2, 3, 4, 5, 6, 7, 9, 8), (1, 2, 3, 4, 5, 6, 9, 7, 8), (1, 2, 3, 4, 5, 9, 6, 7, 8),$$

(1, 2, 3, 4, 9, 5, 6, 7, 8), (1, 2, 3, 9, 4, 5, 6, 7, 8), (1, 2, 9, 3, 4, 5, 6, 7, 8),
 (1, 9, 2, 3, 4, 5, 6, 7, 8).

If 8 lies outside of the loop of $(\hat{8}, 1)$, then one gets the pencil with $G = 9$. If 8 lies between $(\hat{8}, 1)$ and $(\hat{8}, 7)$, one gets the next two pencils with $(E, F) = (8, 9)$ and $(9, 8)$. The other positions of 8 give rise to the other pencils, switching successively 9 with $7, 6, \dots, 2$.

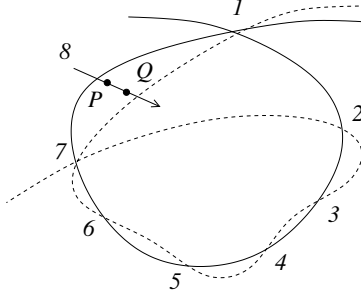

Figure 33: The path p

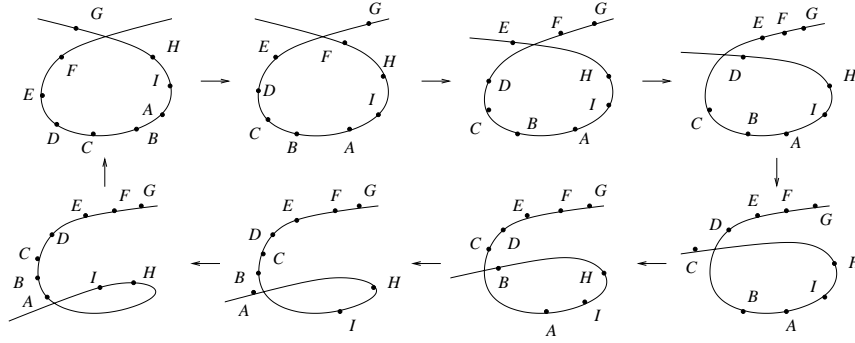

Figure 34: Nodal pencils obtained from the list $\max(\hat{1} = 8-)$

Let $1, \dots, 8$ realize $\max(\hat{1} = 8-)$. The inessential elementary change $\hat{1} : 8- \rightarrow 8+, \hat{8} : 1- \rightarrow 1+$ (7 enters the conic 23456, 1, 8 outside of 23456) is realizable if and only if the points realize one of the first three nodal pencils. Let $1, \dots, 8$ realize one of these pencils, we may move 8 leaving the other points fixed, till the eight points lie on a cubic $(1\pm, 1)_{nod}$ or $(1-, 8)_{nod}$, see Figure 20. The conic 23456 has a sixth intersection point P with the loop of the cubic. The point P lies on some arc AB where A and B are two consecutive points among $1, \dots, 7$. If we move B towards A on the cubic, P moves in the opposite direction, at some moment one has $P = B$ (the cubic and the conic have an ordinary tangency point), then the positions of the two points are swapped. So, up to some swaps like this, we may arrange that P lies on the arc 67 of the cubic. Move 7 towards 6 along the cubic till 7 crosses 23456, we are done. Let now $1, \dots, 8$ realize one

of the other six pencils. The sixth intersection point of 23456 with the cubic (7, 1-) is on the loop of this cubic, whereas 7 is on the odd component. The elementary change is not realizable.

The elementary change $\hat{1} : 8- \rightarrow 8+$, $\hat{8} : 1- \rightarrow 1+$ replaces $\max(\hat{1} = 8-)$ by $\max(\hat{1} = 8+)$, and leaves the combinatorial pencil unchanged. The nodal list $\max(\hat{1} = 8+)$ is thus realizable by the three pencils of Figure 34 with

$$(G, H, I, A, B, C, D, E, F) = (9, 2, 3, 4, 5, 6, 7, 8, 1), (1, 2, 3, 4, 5, 6, 7, 8, 9), \\ (1, 2, 3, 4, 5, 6, 7, 9, 8)$$

The elementary change $\hat{1} : 8+ \rightarrow 6-$, $\hat{7} : 1- \rightarrow 1+$ (8 enters the conic 23456, 7 inside and 1 outside of 23456) is realizable only for the first two pencils. For both, perform the change of pairs: $(1-, 7), (81, C) \rightarrow (1+, 7), (1, 6-)$, one gets the two pencils corresponding to the nodal list $\max(\hat{1} = 6-)$. The elementary change $\hat{1} : 6- \rightarrow 6+$, $\hat{6} : 1- \rightarrow 1+$ (8 enters the conic 23457, 1, 6 outside of 23457) may be performed on both previous pencils replacing the pair $(6, 1-), (1, 6-)$ by the pair $(6, 1+), (1, 6+)$, the new pencils obtained realize the nodal list $\max(\hat{1} = 6+)$.

5.2 Proof of Theorem 1

We will now classify the pencils of cubics with eight base points lying in convex position, up to the action of D_8 on these points. Representants of each of the 43 equivalence classes obtained are shown in Figures 35-37. The upper nine pencils in Figure 35 are the nodal pencils obtained from the list $\max(\hat{1} = 8-) = (15) \cdot L_{64}$. The first three of them correspond also to the list $\max(\hat{1} = 8+) = L_{32}$. The next two pencils after the blank line correspond to the list $\max(\hat{1} = 6-) = L_{48}$. The last two pencils after the second blank line correspond to the list $\max(\hat{1} = 6+) = L_{56}$. The nodal lists give rise in total to 13 orbits of pencils, see Figure 35. Recall that two lists that are obtained from one another by an inessential change must be both nodal or both non-nodal. For any non-nodal list L_n , denote by \mathcal{P}_n the corresponding pencil of cubics. Hereafter, $(\hat{5}, \hat{6})$ stand always for the same elementary change ($\hat{5} : 6- \rightarrow 6+, \hat{6} : 5- \rightarrow 5+$); and $(\hat{1}, \hat{8})$ stands for $(\hat{1} : 8+ \rightarrow 8-, \hat{8} : 1+ \rightarrow 1-)$. One has:

$$(\hat{5}, \hat{6}) \cdot L_3 = L_4, \\ 26 \circ (+1)(48) \circ (\hat{1}, \hat{8}) \cdot L_4 = (+3) \circ (\hat{1}, \hat{8}) \cdot L_4 = L_{15}, \\ (\hat{5}, \hat{6}) \circ 37 \cdot L_3 = (\hat{5}, \hat{6}) \cdot L_{17} = L_{18}.$$

Thus $\mathcal{P}_4 = \mathcal{P}_3$; $\mathcal{P}_{15} = (+3) \cdot \mathcal{P}_4$; $\mathcal{P}_{18} = 37 \cdot \mathcal{P}_3$. One has:

$$(\hat{5}, \hat{6}) \cdot L_5 = L_6, \\ (\hat{5}, \hat{6}) \circ 37 \cdot L_5 = (\hat{5}, \hat{6}) \cdot L_9 = L_{10}, \\ 26 \circ (+1)(48) \circ (\hat{1}, \hat{8}) \cdot L_6 = (+3) \circ (\hat{1}, \hat{8}) \cdot L_6 = L_{23}.$$

Thus, $\mathcal{P}_6 = \mathcal{P}_5$; $\mathcal{P}_{10} = 37 \cdot \mathcal{P}_5$; $\mathcal{P}_{23} = (+3) \cdot \mathcal{P}_6$. One has $(\hat{5}, \hat{6}) \circ 37 \cdot L_2 = L_{34}$. Thus, $\mathcal{P}_{34} = 37 \cdot \mathcal{P}_2$. Finally, $(+1)(48) \circ (\hat{1}, \hat{8}) \cdot L_n = L_m$ for $(n, m) = (7, 26), (8, 25), (11, 22), (12, 21), (13, 20), (14, 19)$. Thus $\mathcal{P}_m = (+1)(48) \cdot \mathcal{P}_n$. The non-nodal principal lists split into two subsets: 28 lists with $\hat{8} = 1+$ and 15

lists with $\hat{\delta} \neq 1+$. The first set gives rise to 15 orbits of pencils. In the second set, there is a one-to-one correspondence between the lists and the equivalence classes of pencils, see Figures 36-37, one gets also 15 pencils. There are in total $13 + 15 + 15 = 43$ equivalence classes of pencils.

To construct the non-nodal pencils in the easiest way, we may follow the sequences of elementary changes from Figure 19, with four starting lists: L_2 , L_{65} , L_{71} , L_{88} . Construct directly the starting pencils corresponding to L_{65} , L_{71} , L_{88} using again the method exposed in section 3.2. To get the starting pencil corresponding to L_2 in the shortest way, observe that the list L_2 is obtained from the (non-principal and nodal) list L_1 by an elementary change $(\hat{6}, \hat{7})$. The list $L_1 = \max(\hat{\delta} = 1+) = (+1)(48) \max(\hat{1} = 8-)$ corresponds to nine pencils. However, the elementary change $(\hat{6}, \hat{7})$ is realizable only for the first of them, shown in the first row of Figure 36. \square

Pencils of cubics were applied in [5] to solve an interpolation problem, and in [3], [4] to study the isotopy types realizable by some real algebraic curves in $\mathbb{R}P^2$.

(12, L)	(81, L)	(81, C)	(1-, 7)	(6, 1-)	(1-, 5)	(4, 1-)	(1-, 3)
XX	XX	18	$X1$	61	$X1$	41	$X1$
(1+, 12)	(1-, 81)	(81, C)	(1-, 7)	(6, 1-)	(1-, 5)	(4, 1-)	(1-, 3)
$8X$	$2X$	$X1$	18	18	18	18	18
(1+, 12)	(1-, 8)	(1-, 78)	(1-, 7)	(6, 1-)	(1-, 5)	(4, 1-)	(1-, 3)
78	$X7$	$X1$	$8X$	87	87	87	87
(1+, 12)	(1-, 8)	(7, 1-)	(1-, 67)	(6, 1-)	(1-, 5)	(4, 1-)	(1-, 3)
67	76	$X6$	$2X$	$7X$	76	76	76
(1+, 12)	(1-, 8)	(7, 1-)	(1-, 6)	(1-, 56)	(1-, 5)	(4, 1-)	(1-, 3)
56	65	65	$X5$	$X1$	$6X$	65	65
(1+, 12)	(1-, 8)	(7, 1-)	(1-, 6)	(5, 1-)	(1-, 45)	(4, 1-)	(1-, 3)
45	54	54	54	$X4$	$2X$	$5X$	54
(1+, 12)	(1-, 8)	(7, 1-)	(1-, 6)	(5, 1-)	(1-, 4)	(1-, 34)	(1-, 3)
34	43	43	43	43	$X3$	$X1$	$4X$
(1+, 12)	(1-, 8)	(7, 1-)	(1-, 6)	(5, 1-)	(1-, 4)	(3, 1-)	(1-, E)
23	32	32	32	32	32	$X2$	$2X$
(1+, 12)	(1-, 8)	(7, 1-)	(1-, 6)	(5, 1-)	(1-, 4)	(3, 1-)	(1-, E)
$X2$	28	$2X$	26	$2X$	24	$2X$	$X2$
(12, L)	(81, L)	(1+, 7)	(1, 6-)	(6, 1-)	(1-, 5)	(4, 1-)	(1-, 3)
XX	XX	$X1$	16	61	$X1$	41	$X1$
(1+, 12)	(1-, 18)	(1+, 7)	(1, 6-)	(6, 1-)	(1-, 5)	(4, 1-)	(1-, 3)
$8X$	$2X$	12	$X1$	18	18	18	18
(12, L)	(81, L)	(1+, 7)	(6, 1+)	(1, 6+)	(1-, 5)	(4, 1-)	(1-, 3)
XX	XX	$X1$	61	16	$X1$	41	$X1$
(1+, 12)	(1-, 18)	(1+, 7)	(6, 1+)	(1, 6+)	(1-, 5)	(4, 1-)	(1-, 3)
$8X$	$2X$	12	12	$X1$	18	18	18

Figure 35: Pencils $\max(\hat{1} = 8-)$, $\max(\hat{1} = 8+)$, $\max(\hat{1} = 6-)$, $\max(\hat{1} = 6+)$

(78, <i>L</i>)	(81, <i>L</i>)	(81, <i>C</i>)	(8+, 2)	(3, 8+)	(8+, 4)	(5, 8+)	(8+, 6)	1
<i>XX</i>	<i>XX</i>	18	X8	38	X8	58	X8	
(56, <i>L</i>)	(81, <i>L</i>)	(81, <i>C</i>)	(8+, 2)	(3, 8+)	(8+, 4)	(5, 8+)	(5-, 7)	2
<i>XX</i>	<i>XX</i>	18	X8	38	X8	58	X5	
(56, <i>L</i>)	(81, <i>L</i>)	(81, <i>C</i>)	(8+, 2)	(3, 8+)	(8+, 4)	(5+, 7)	(56, <i>C</i>)	3, 4
<i>XX</i>	<i>XX</i>	18	X8	38	X8	X5	65	
(56, <i>L</i>)	(81, <i>L</i>)	(81, <i>C</i>)	(8+, 2)	(3, 8+)	(3-, 7)	(6-, 4)	(56, <i>C</i>)	6, 5
<i>XX</i>	<i>XX</i>	18	X8	38	X3	X6	65	
(56, <i>L</i>)	(81, <i>L</i>)	(81, <i>C</i>)	(8+, 2)	(3, 8+)	(3-, 7)	(6, 3-)	(6+, 4)	7
<i>XX</i>	<i>XX</i>	18	X8	38	X3	63	X6	
(34, <i>L</i>)	(81, <i>L</i>)	(81, <i>C</i>)	(8+, 2)	(3, 8+)	(3-, 7)	(6, 3-)	(3-, 5)	8
<i>XX</i>	<i>XX</i>	18	X8	38	X3	63	X3	
(18, <i>L</i>)	(65, <i>L</i>)	(6+, 4)	(6, 3-)	(3, 6-)	(3+, 7)	(8+, 2)	(18, <i>C</i>)	11
<i>XX</i>	<i>XX</i>	X6	63	36	X3	X8	81	
(18, <i>L</i>)	(34, <i>L</i>)	(3-, 5)	(6, 3-)	(3, 6-)	(3+, 7)	(8+, 2)	(18, <i>C</i>)	12
<i>XX</i>	<i>XX</i>	X3	63	36	X3	X8	81	
(18, <i>L</i>)	(34, <i>L</i>)	(3-, 5)	(3, 6+)	(6, 3+)	(3+, 7)	(8+, 2)	(18, <i>C</i>)	14
<i>XX</i>	<i>XX</i>	X3	36	63	X3	X8	81	
(18, <i>L</i>)	(65, <i>L</i>)	(6+, 4)	(3, 6+)	(6, 3+)	(3+, 7)	(8+, 2)	(18, <i>C</i>)	13
<i>XX</i>	<i>XX</i>	X6	36	63	X3	X8	81	
(18, <i>L</i>)	(65, <i>L</i>)	(6+, 4)	(6, 3-)	(3, 6-)	(6-, 2)	(1, 6-)	(1+, 7)	35
<i>XX</i>	<i>XX</i>	X6	63	36	X6	16	X1	
(18, <i>L</i>)	(34, <i>L</i>)	(3-, 5)	(6, 3-)	(3, 6-)	(6-, 2)	(1, 6-)	(1+, 7)	36
<i>XX</i>	<i>XX</i>	X3	63	36	X6	16	X1	
(18, <i>L</i>)	(34, <i>L</i>)	(3-, 5)	(3, 6+)	(6, 3+)	(6-, 2)	(1, 6-)	(1+, 7)	38
<i>XX</i>	<i>XX</i>	X3	36	63	X6	16	X1	
(18, <i>L</i>)	(65, <i>L</i>)	(6+, 4)	(3, 6+)	(6, 3+)	(6-, 2)	(1, 6-)	(1+, 7)	37
<i>XX</i>	<i>XX</i>	X6	36	63	X6	16	X1	
(18, <i>L</i>)	(65, <i>L</i>)	(6+, 4)	(3, 6+)	(6+, 2)	(6, 1-)	(1, 6-)	(1+, 7)	41
<i>XX</i>	<i>XX</i>	X6	36	X6	61	16	X1	
(18, <i>L</i>)	(65, <i>L</i>)	(6+, 4)	(3, 6+)	(6+, 2)	(1, 6+)	(6, 1+)	(1+, 7)	49
<i>XX</i>	<i>XX</i>	X6	36	X6	16	61	X1	

Figure 36: Pencils with $\hat{\delta} = 1+$

(1+, 2) 82	(3, 1+) 8X	(1+, 4) 84	(5, 1+) 8X	(1+, 6) 86	(7, 1+) 8X	(1, 7-) 8X	(1-, 8) 28	65
(1+, 2) 82	(3, 1+) 8X	(1+, 4) 84	(5, 1+) 8X	(1+, 6) 86	(1, 7+) 6X	(7, 1-) 2X	(1-, 8) 28	66
(1+, 2) 82	(3, 1+) 8X	(1+, 4) 84	(5, 1+) 8X	(1, 5-) 6X	(1-, 6) 26	(7, 1-) 2X	(1-, 8) 28	67
(4, 2+) 1X	(2+, 5) 15	(6, 2+) 1X	(2+, 7) 17	(8, 2+) 1X	(2, 8-) 1X	(8-, 3) 13	(4+, 1) 31	71
(4-, 1) 51	(2+, 5) 15	(6, 2+) 1X	(2+, 7) 17	(8, 2+) 1X	(2, 8-) 1X	(8-, 3) 13	(4, 8-) 1X	72
(4, 2+) 1X	(2+, 5) 15	(6, 2+) 1X	(2+, 7) 17	(2, 8+) 7X	(8, 2-) 3X	(8-, 3) 13	(4+, 1) 31	75
(4, 2+) 1X	(2+, 5) 15	(6, 2+) 1X	(2, 6-) 7X	(2-, 7) 37	(8, 2-) 3X	(8-, 3) 13	(4+, 1) 31	78
(4-, 1) 51	(2+, 5) 15	(6, 2+) 1X	(2+, 7) 17	(2, 8+) 7X	(8, 2-) 3X	(8-, 3) 13	(4, 8-) 1X	80
(4-, 1) 51	(2+, 5) 15	(6, 2+) 1X	(2, 6-) 7X	(2-, 7) 37	(8, 2-) 3X	(8-, 3) 13	(4, 8-) 1X	86
(4-, 1) 51	(2+, 5) 15	(2, 6+) 5X	(6, 2-) 3X	(2-, 7) 37	(8, 2-) 3X	(8-, 3) 13	(4, 8-) 1X	87
(4-, 1) 51	(2, 4-) 5X	(2-, 5) 35	(6, 2-) 3X	(2-, 7) 37	(8, 2-) 3X	(8-, 3) 13	(4, 8-) 1X	84
(8-, 5) 15	(6+, 1) 51	(2, 6+) 5X	(6, 2-) 3X	(2-, 7) 37	(8, 2-) 3X	(8-, 3) 13	(4, 8-) 1X	83
(8-, 5) 15	(6+, 1) 51	(6, 2+) 1X	(2, 6-) 7X	(2-, 7) 37	(8, 2-) 3X	(8-, 3) 13	(4, 8-) 1X	82
(5, 1-) 2X	(1, 5+) 4X	(1+, 4) 84	(3-, 8) 48	(3, 7-) 8X	(7, 3+) 2X	(7+, 2) 62	(1-, 6) 26	88
(1, 5-) 6X	(5, 1+) 8X	(1+, 4) 84	(3-, 8) 48	(7, 3-) 4X	(3, 7+) 6X	(7+, 2) 62	(1-, 6) 26	92

Figure 37: Pencils with $\hat{8} \neq 1+$

$\hat{8}$	1+		1-		2+		2-		3+		3-		4+	
C_2	in	out	in	out	in	out	in	out	in	out	in	out	in	out
23456	7	1		1,7	1,7		1,7		1,7		1,7		1,7	
23457		1,6	6	1	1	6	1	6	6	1	6	1	1	6
23467	5	1		1,5	1,5		1,5		1,5		1,5		1,5	
23567		1,4	4	1	1	4	1	4	4	1	4	1	1	4
24567	3	1		1,3	1,3		1,3		1,3		1,3		1,3	
34567		1,2	2	1	1	2		1,2	1,2		1,2		1,2	1,2
13456	2,7		2,7			2,7	7	2	2	7	2	7	7	2
13457	2	6	2	6	6	2		2,6	2,6		2,6		2,6	2,6
13467	2,5		2,5			2,5	5	2	2	5	2	5	5	2
13567	2	4	2	4	4	2		2,4	2,4		2,4		2,4	2,4
14567	2,3		2,3			2,3	3	2	2	3		2,3	2,3	
12456	7	3	7	3	3	7	3	7	7	3		3,7	3,7	
12457		3,6		3,6	3,6		3,6		3,6	6	3	3	3	6
12467	5	3	5	3	3	5	3	5	5	3		3,5	3,5	
12567		3,4		3,4	3,4		3,4		3,4	4	3	3	4	
12356	4,7		4,7			4,7		4,7	4,7		4,7		4,7	4,7
12357	4	6	4	6	6	4	6	4	4	6	4	6	6	4
12367	4,5		4,5			4,5		4,5	4,5		4,5		4,5	4,5
12346	7	5	7	5	5	7	5	7	7	5	7	5	5	7
12347		5,6		5,6	5,6		5,6		5,6		5,6		5,6	5,6
12345	6,7		6,7			6,7		6,7	6,7		6,7		6,7	6,7

Figure 38: The lists $\hat{8} = L(1, \dots, 7)$

6 Tabulars

$\hat{8}$	4-		5+		5-		6+		6-		7+		7-	
C_2	in	out	in	out	in	out	in	out	in	out	in	out	in	out
23456	1,7			1,7		1,7	1,7		1,7			1,7	1	7
23457	1	6	6	1	6	1	1	6		1,6	1,6		1,6	
23467	1,5			1,5	1	5	5	1	5	1	1	5	1	5
23567		1,4	1,4		1,4			1,4		1,4	1,4		1,4	
24567	3	1	1	3	1	3	3	1	3	1	1	3	1	3
34567		1,2	1,2		1,2			1,2		1,2	1,2		1,2	
13456	7	2	2	7	2	7	7	2	7	2	2	7		2,7
13457		2,6	2,6		2,6			2,6	2	6	6	2	6	2
13467	5	2	2	5		2,5	2,5		2,5			2,5		2,5
13567	2	4	4	2	4	2	2	4	2	4	4	2	4	2
14567	2,3			2,3		2,3	2,3		2,3			2,3		2,3
12456	3,7			3,7		3,7	3,7		3,7			3,7	3	7
12457	3	6	6	3	6	3	3	6		3,6	3,6		3,6	
12467	3,5			3,5	3	5	5	3	5	3	3	5	3	5
12567		3,4	3,4		3,4			3,4		3,4	3,4		3,4	
12356	7	4	4	7	4	7	7	4	7	4	4	7		4,7
12357		4,6	4,6		4,6			4,6	4	6	6	4	6	4
12367	5	4	4	5		4,5	4,5		4,5			4,5		4,5
12346	5	7	7	5		5,7	5,7		5,7			5,7	5	7
12347	5,6			5,6	6	5	5	6		5,6	5,6		5,6	
12345		6,7	6,7		6,7			6,7	7	6	6	7		6,7

Figure 39: The lists $\hat{8} = L(1, \dots, 7)$, continued

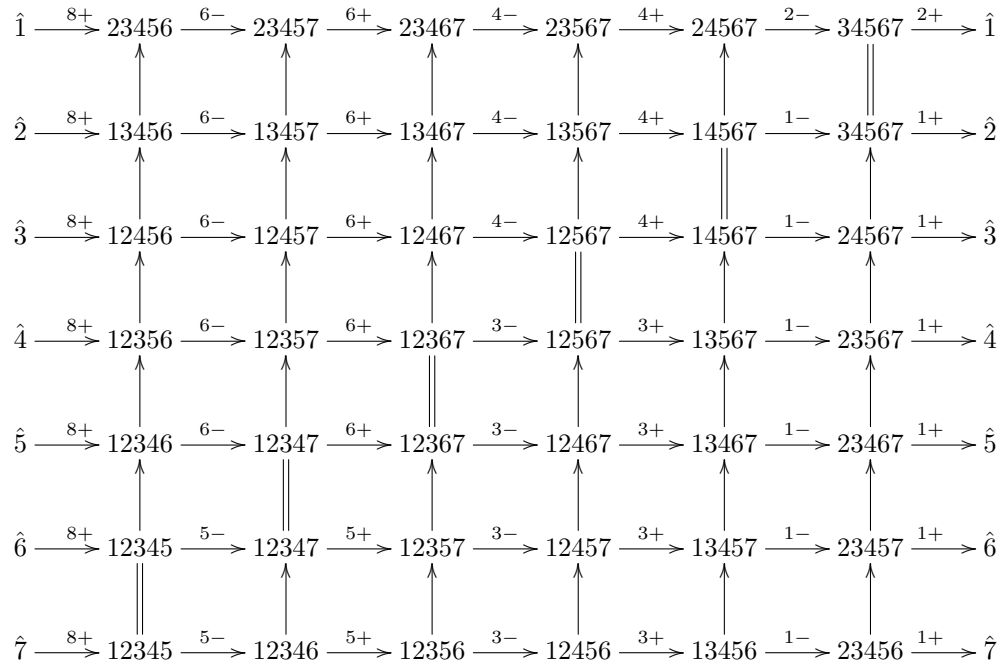

Figure 40: $\hat{8} = 1+$

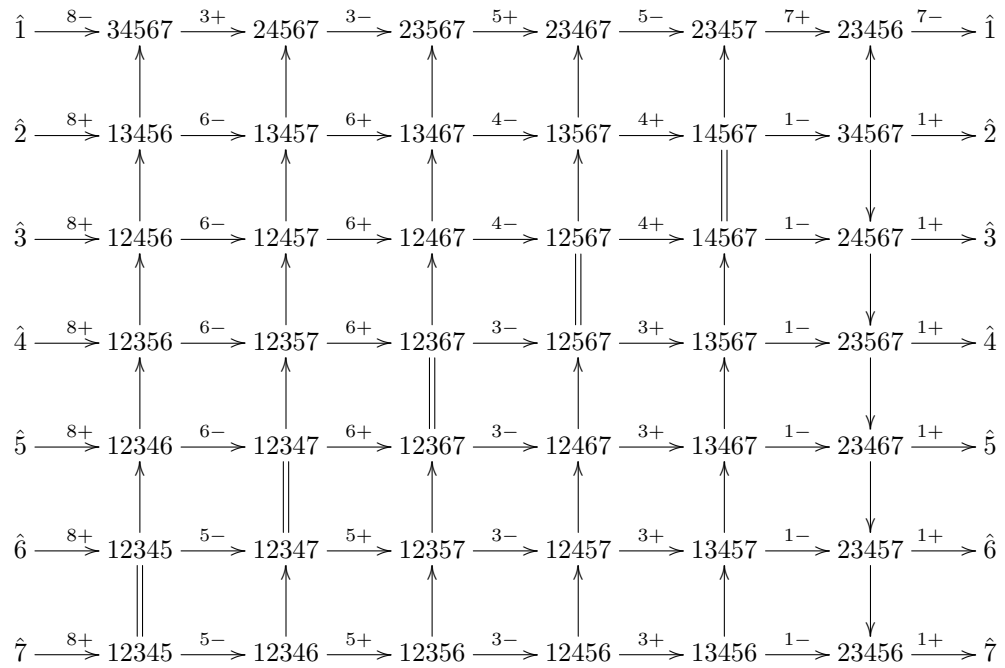

Figure 41: $\hat{8} = 1^-$

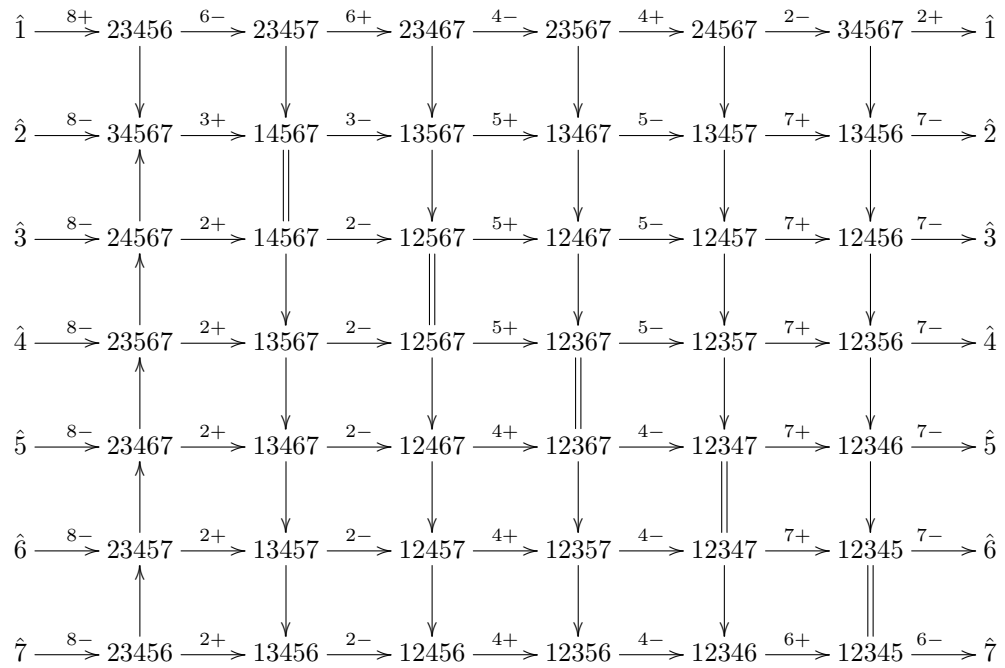

Figure 42: $\hat{8} = 2+$

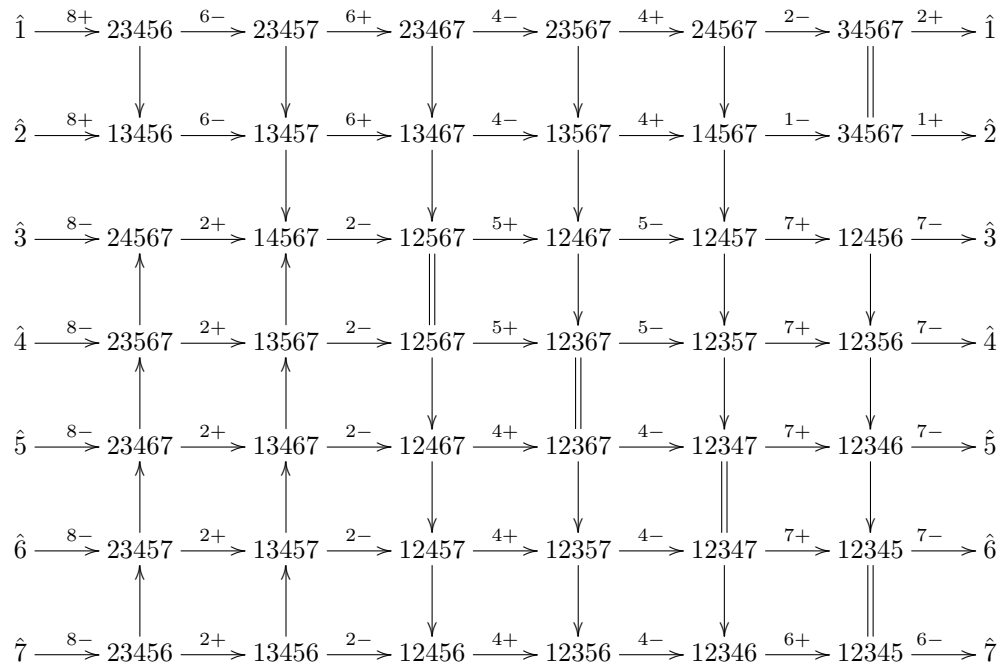

Figure 43: $\hat{8} = 2-$

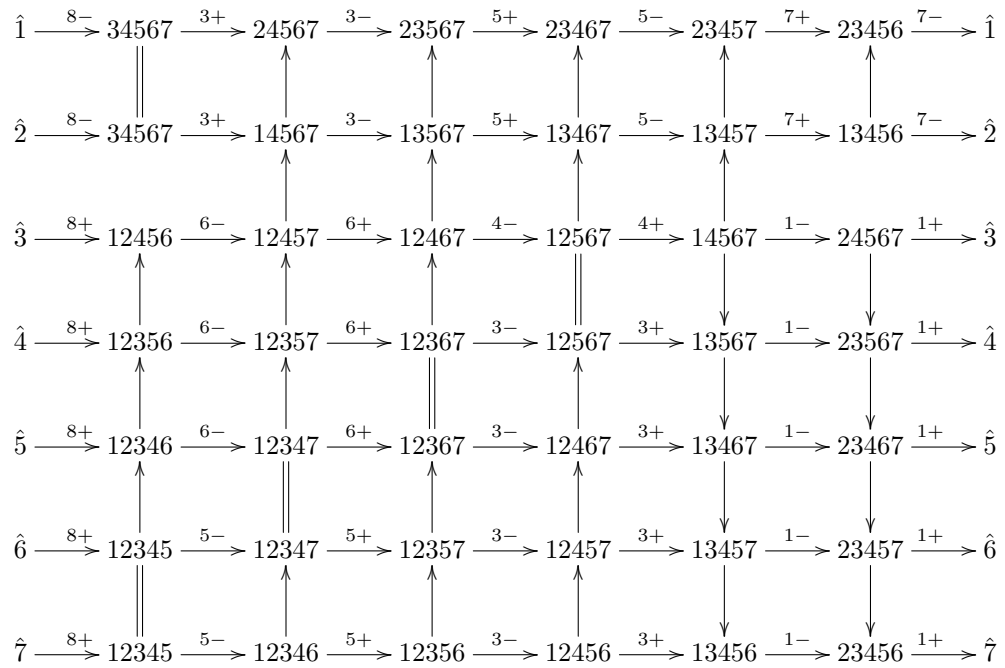

Figure 44: $\hat{8} = 3+$

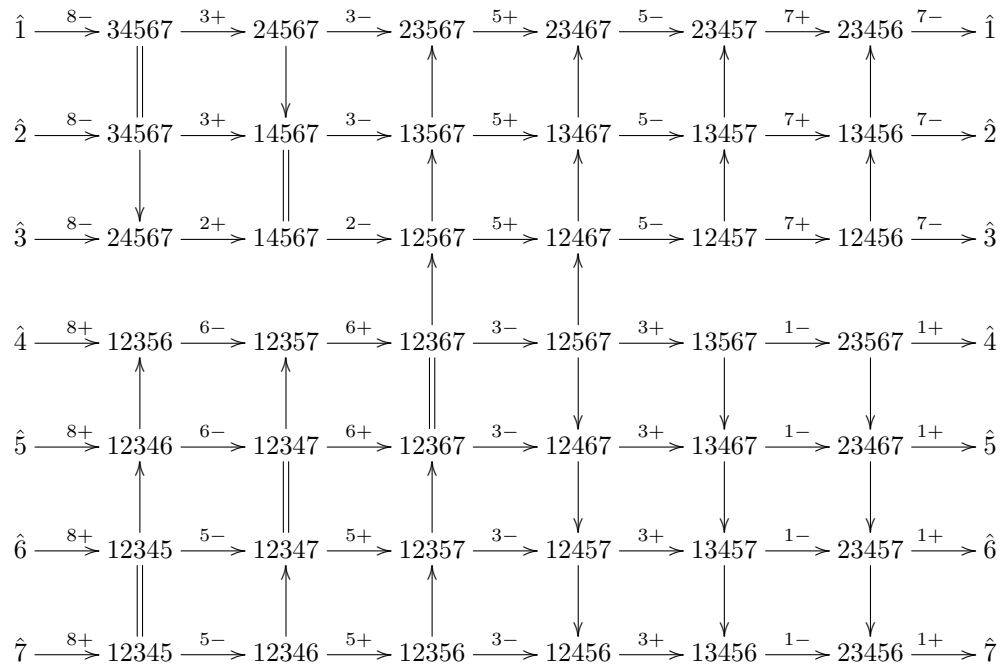

Figure 45: $\hat{8} = 3-$

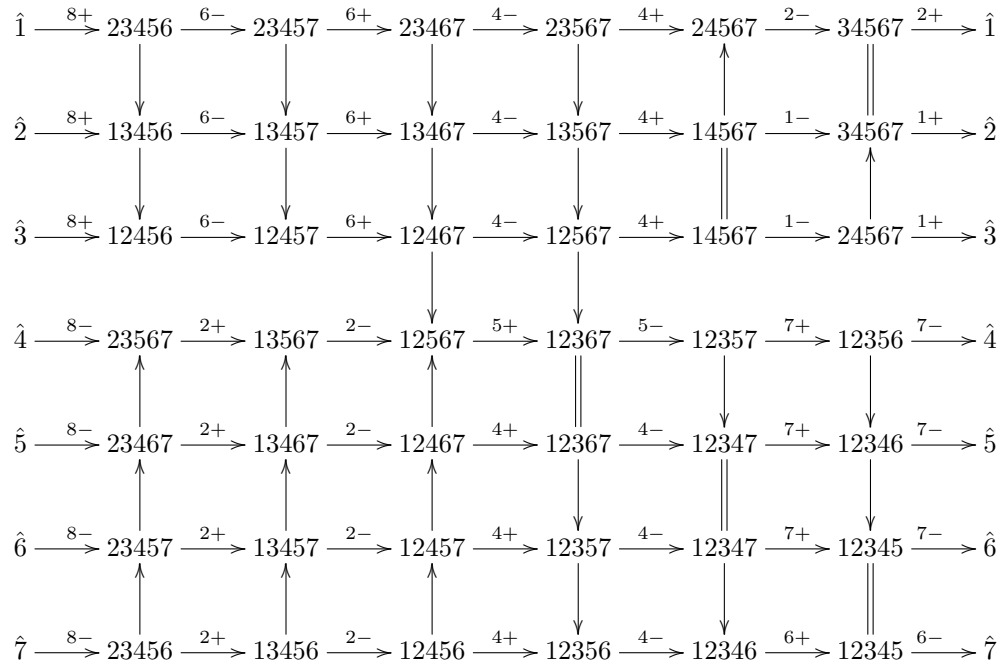

Figure 46: $\hat{8} = 4+$

$\hat{1}$	$3+ \leftrightarrow 8-$	$3+ \leftrightarrow 8-$	$2+ \leftrightarrow 2-$	$2+ \leftrightarrow 2-$
$\hat{2}$	$3+ \leftrightarrow 8-$	$1+ \leftrightarrow 1-$	$3+ \leftrightarrow 8-$	$1+ \leftrightarrow 1-$
$\hat{1}$	$3- \leftrightarrow 3+$	$3- \leftrightarrow 3+$	$2- \leftrightarrow 4+$	$2- \leftrightarrow 4+$
$\hat{3}$	$2+ \leftrightarrow 8-$	$1+ \leftrightarrow 1-$	$2+ \leftrightarrow 8-$	$1+ \leftrightarrow 1-$
$\hat{1}$	$5+ \leftrightarrow 3-$	$5+ \leftrightarrow 3-$	$4+ \leftrightarrow 4-$	$4+ \leftrightarrow 4-$
$\hat{4}$	$2+ \leftrightarrow 8-$	$1+ \leftrightarrow 1-$	$2+ \leftrightarrow 8-$	$1+ \leftrightarrow 1-$
$\hat{1}$	$5- \leftrightarrow 5+$	$5- \leftrightarrow 5+$	$4- \leftrightarrow 6+$	$4- \leftrightarrow 6+$
$\hat{5}$	$2+ \leftrightarrow 8-$	$1+ \leftrightarrow 1-$	$2+ \leftrightarrow 8-$	$1+ \leftrightarrow 1-$
$\hat{1}$	$7+ \leftrightarrow 5-$	$7+ \leftrightarrow 5-$	$6+ \leftrightarrow 6-$	$6+ \leftrightarrow 6-$
$\hat{6}$	$2+ \leftrightarrow 8-$	$1+ \leftrightarrow 1-$	$2+ \leftrightarrow 8-$	$1+ \leftrightarrow 1-$
$\hat{1}$	$7- \leftrightarrow 7+$	$7- \leftrightarrow 7+$	$6- \leftrightarrow 8+$	$6- \leftrightarrow 8+$
$\hat{7}$	$2+ \leftrightarrow 8-$	$1+ \leftrightarrow 1-$	$2+ \leftrightarrow 8-$	$1+ \leftrightarrow 1-$
$\hat{1}$	$2+ \leftrightarrow 7-$	$2+ \leftrightarrow 7-$	$8+ \leftrightarrow 8-$	$8+ \leftrightarrow 8-$
$\hat{8}$	$2+ \leftrightarrow 7-$	$1+ \leftrightarrow 1-$	$2+ \leftrightarrow 7-$	$1+ \leftrightarrow 1-$
$\hat{2}$	$3- \leftrightarrow 3+$	$3- \leftrightarrow 3+$	$1- \leftrightarrow 4+$	$1- \leftrightarrow 4+$
$\hat{3}$	$1- \leftrightarrow 4+$	$2- \leftrightarrow 2+$	$1- \leftrightarrow 4+$	$2- \leftrightarrow 2+$
$\hat{2}$	$5+ \leftrightarrow 3-$	$5+ \leftrightarrow 3-$	$4+ \leftrightarrow 4-$	$4+ \leftrightarrow 4-$
$\hat{4}$	$1- \leftrightarrow 3+$	$2- \leftrightarrow 2+$	$1- \leftrightarrow 3+$	$2- \leftrightarrow 2+$
$\hat{2}$	$5- \leftrightarrow 5+$	$5- \leftrightarrow 5+$	$4- \leftrightarrow 6+$	$4- \leftrightarrow 6+$
$\hat{5}$	$1- \leftrightarrow 3+$	$2- \leftrightarrow 2+$	$1- \leftrightarrow 3+$	$2- \leftrightarrow 2+$
$\hat{2}$	$7+ \leftrightarrow 5-$	$7+ \leftrightarrow 5-$	$6+ \leftrightarrow 6-$	$6+ \leftrightarrow 6-$
$\hat{6}$	$1- \leftrightarrow 3+$	$2- \leftrightarrow 2+$	$1- \leftrightarrow 3+$	$2- \leftrightarrow 2+$
$\hat{2}$	$7- \leftrightarrow 7+$	$7- \leftrightarrow 7+$	$6- \leftrightarrow 8+$	$6- \leftrightarrow 8+$
$\hat{7}$	$1- \leftrightarrow 3+$	$2- \leftrightarrow 2+$	$1- \leftrightarrow 3+$	$2- \leftrightarrow 2+$
$\hat{2}$	$1+ \leftrightarrow 7-$	$1+ \leftrightarrow 7-$	$8+ \leftrightarrow 8-$	$8+ \leftrightarrow 8-$
$\hat{8}$	$1- \leftrightarrow 3+$	$2- \leftrightarrow 2+$	$1- \leftrightarrow 3+$	$2- \leftrightarrow 2+$
$\hat{3}$	$4- \leftrightarrow 4+$	$4- \leftrightarrow 4+$	$2- \leftrightarrow 5+$	$2- \leftrightarrow 5+$
$\hat{4}$	$2- \leftrightarrow 5+$	$3- \leftrightarrow 3+$	$2- \leftrightarrow 5+$	$3- \leftrightarrow 3+$

Figure 47: Elementary changes

$\hat{3}$	$6+ \leftrightarrow 4-$	$6+ \leftrightarrow 4-$	$5+ \leftrightarrow 5-$	$5+ \leftrightarrow 5-$
$\hat{5}$	$2- \leftrightarrow 4+$	$3- \leftrightarrow 3+$	$2- \leftrightarrow 4+$	$3- \leftrightarrow 3+$
$\hat{3}$	$6- \leftrightarrow 6+$	$6- \leftrightarrow 6+$	$5- \leftrightarrow 7+$	$5- \leftrightarrow 7+$
$\hat{6}$	$2- \leftrightarrow 4+$	$3- \leftrightarrow 3+$	$2- \leftrightarrow 4+$	$3- \leftrightarrow 3+$
$\hat{3}$	$8+ \leftrightarrow 6-$	$8+ \leftrightarrow 6-$	$7+ \leftrightarrow 7-$	$7+ \leftrightarrow 7-$
$\hat{7}$	$2- \leftrightarrow 4+$	$3- \leftrightarrow 3+$	$2- \leftrightarrow 4+$	$3- \leftrightarrow 3+$
$\hat{3}$	$8- \leftrightarrow 8+$	$8- \leftrightarrow 8+$	$7- \leftrightarrow 1+$	$7- \leftrightarrow 1+$
$\hat{8}$	$2- \leftrightarrow 4+$	$3- \leftrightarrow 3+$	$2- \leftrightarrow 4+$	$3- \leftrightarrow 3+$
$\hat{4}$	$5- \leftrightarrow 5+$	$5- \leftrightarrow 5+$	$3- \leftrightarrow 6+$	$3- \leftrightarrow 6+$
$\hat{5}$	$3- \leftrightarrow 6+$	$4- \leftrightarrow 4+$	$3- \leftrightarrow 6+$	$4- \leftrightarrow 4+$
$\hat{4}$	$7+ \leftrightarrow 5-$	$7+ \leftrightarrow 5-$	$6+ \leftrightarrow 6-$	$6+ \leftrightarrow 6-$
$\hat{6}$	$3- \leftrightarrow 5+$	$4- \leftrightarrow 4+$	$3- \leftrightarrow 5+$	$4- \leftrightarrow 4+$
$\hat{4}$	$7- \leftrightarrow 7+$	$7- \leftrightarrow 7+$	$6- \leftrightarrow 8+$	$6- \leftrightarrow 8+$
$\hat{7}$	$3- \leftrightarrow 5+$	$4- \leftrightarrow 4+$	$3- \leftrightarrow 5+$	$4- \leftrightarrow 4+$
$\hat{4}$	$1+ \leftrightarrow 7-$	$1+ \leftrightarrow 7-$	$8+ \leftrightarrow 8-$	$8+ \leftrightarrow 8-$
$\hat{8}$	$3- \leftrightarrow 5+$	$4- \leftrightarrow 4+$	$3- \leftrightarrow 5+$	$4- \leftrightarrow 4+$
$\hat{5}$	$6- \leftrightarrow 6+$	$6- \leftrightarrow 6+$	$4- \leftrightarrow 7+$	$4- \leftrightarrow 7+$
$\hat{6}$	$4- \leftrightarrow 7+$	$5- \leftrightarrow 5+$	$4- \leftrightarrow 7+$	$5- \leftrightarrow 5+$
$\hat{5}$	$8+ \leftrightarrow 6-$	$8+ \leftrightarrow 6-$	$7+ \leftrightarrow 7-$	$7+ \leftrightarrow 7-$
$\hat{7}$	$4- \leftrightarrow 6+$	$5- \leftrightarrow 5+$	$4- \leftrightarrow 6+$	$5- \leftrightarrow 5+$
$\hat{5}$	$8- \leftrightarrow 8+$	$8- \leftrightarrow 8+$	$7- \leftrightarrow 1+$	$7- \leftrightarrow 1+$
$\hat{8}$	$4- \leftrightarrow 6+$	$5- \leftrightarrow 5+$	$4- \leftrightarrow 6+$	$5- \leftrightarrow 5+$
$\hat{6}$	$7- \leftrightarrow 7+$	$7- \leftrightarrow 7+$	$5- \leftrightarrow 8+$	$5- \leftrightarrow 8+$
$\hat{7}$	$5- \leftrightarrow 8+$	$6- \leftrightarrow 6+$	$5- \leftrightarrow 8+$	$6- \leftrightarrow 6+$
$\hat{6}$	$1+ \leftrightarrow 7-$	$1+ \leftrightarrow 7-$	$8+ \leftrightarrow 8-$	$8+ \leftrightarrow 8-$
$\hat{8}$	$5- \leftrightarrow 7+$	$6- \leftrightarrow 6+$	$5- \leftrightarrow 7+$	$6- \leftrightarrow 6+$
$\hat{7}$	$8- \leftrightarrow 8+$	$8- \leftrightarrow 8+$	$6- \leftrightarrow 1+$	$6- \leftrightarrow 1+$
$\hat{8}$	$6- \leftrightarrow 1+$	$7- \leftrightarrow 7+$	$6- \leftrightarrow 1+$	$7- \leftrightarrow 7+$

Figure 48: Elementary changes, continued

References

- [1] P. Borwein, W.O.J. Moser: A survey of Sylvester's problem's and its generalizations, *Aequationes Mathematicae* **40** (1), 111-135 (1990)
- [2] A.I. Degtyarev, V. M. Kharlamov: Topological properties of real algebraic varieties: Rokhlin's way, *Uspekhi Mat. Nauk* **55**, no. 4(334), 129-212 (2000).
- [3] S. Fiedler-Le Touzé: Orientations complexes des courbes algébriques réelles., These doctorale (2000).
- [4] S. Fiedler-Le Touzé, S. Orevkov: A flexible affine sextic which is algebraically unrealizable., *Journal of Algebraic Geometry* **11**, 293-310 (2002).
- [5] S. Fiedler-Le Touzé: Pencils of cubics as tools to solve an interpolation problem., *Applicable Algebra in Engineering, Communication and Computing*, vol. 18, 1-2 (February 2007).
- [6] S. Fiedler-Le Touzé: Rational pencils of cubics and configurations of six or seven points in $\mathbb{R}P^2$, arXiv[AG] 1210.7146
- [7] J. Stipins: On finite k-nets in the complex projective plane, Ph. D. thesis, The University of Michigan, 2007.
- [8] S. Yuzvinsky: A new bound on the number of special fibers in a pencil of curves., arXiv: 0801.1521v2[math.AG] (January 2008)
- [9] J-Y. Welschinger: Invariants of real rational symplectic 4-manifolds and lower bounds in real enumerative geometry, *C.R. Math. Acad. Sci. Paris* **336**, no. 4, 341-344 (2003).

severine.fiedler@live.fr