

EXPLICIT JENKINS–STREBEL REPRESENTATIVES OF ALL STRATA OF ABELIAN AND QUADRATIC DIFFERENTIALS

ANTON ZORICH

To G. A. Margulis on his 60th birthday

ABSTRACT. Moduli spaces of Abelian and quadratic differentials are stratified by multiplicities of zeroes; connected components of the strata correspond to ergodic components of the Teichmüller geodesic flow. It is known that the strata are not necessarily connected; the connected components were recently classified by M. Kontsevich and the author and by E. Lanneau. The strata can be also viewed as families of flat metrics with conical singularities and with $\mathbb{Z}/2\mathbb{Z}$ -holonomy.

For every connected component of each stratum of Abelian and quadratic differentials we construct an explicit representative which is a Jenkins–Strebel differential with a single cylinder. By an elementary variation of this construction we represent almost every Abelian (quadratic) differential in the corresponding connected component of the stratum as a polygon with identified pairs of edges, where combinatorics of identifications is explicitly described.

Specifically, the combinatorics is expressed in terms of a generalized permutation. For any component of any stratum of Abelian and quadratic differentials we construct a generalized permutation in the corresponding extended Rauzy class.

CONTENTS

1. Introduction	140
2. Representatives of strata of Abelian differentials	152
3. Representatives of strata of quadratic differentials	160
Appendix A. Adjacency of special strata	169
Appendix B. Rauzy operations for generalized permutations	172
Appendix C. Parity of a spin structure in terms of a permutation	177
Appendix D. Rauzy classes for small genera	181

Received October 1, 2007.

2000 *Mathematics Subject Classification*: 32G15, 30F30, 30F60, 37E05, 37E35, 37G99.

Key words and phrases: Teichmüller geodesic flow, moduli space of quadratic differentials, Jenkins–Strebel differential, spin structure, interval-exchange transformation, Rauzy class.

The work was partially supported by ANR grant BLAN06-3_138280, “Dynamics in Teichmüller space”.

1. INTRODUCTION

1.1. Flat surfaces versus Abelian and quadratic differentials. Consider a collection of vectors $\vec{v}_1, \dots, \vec{v}_n$ in \mathbb{R}^2 and construct from these vectors a broken line in a natural way: the j th edge of the broken line is represented by the vector \vec{v}_j . Construct another broken line starting at the same point as the initial one by taking the same vectors in the order $\vec{v}_{\pi^{-1}(1)}, \dots, \vec{v}_{\pi^{-1}(n)}$, where π^{-1} is a permutation of n elements. By construction, the two broken lines share the same endpoints; suppose that they bound a polygon like in Figure 1. Identifying the pairs of sides corresponding to the same vectors \vec{v}_j , $j = 1, \dots, n$, by parallel translations we obtain a surface endowed with a flat metric.

The flat metric is nonsingular outside of a finite number of cone-type singularities corresponding to the vertices of the polygon. By construction, the flat metric has trivial holonomy: a parallel transport of a vector along a closed path does not change the direction (and length) of the vector. This implies, in particular, that all cone angles at the singularities are integer multiples of 2π .

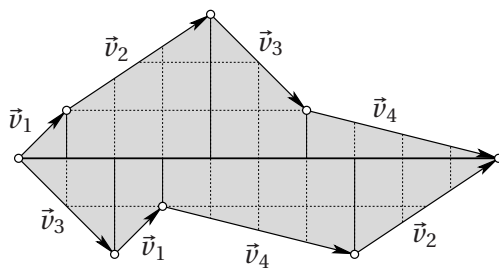

FIGURE 1. Identifying corresponding pairs of sides of this polygon by parallel translations we obtain a surface of genus two. The flat metric has trivial holonomy; it has a single conical singularity with cone angle 6π .

The polygon in our construction depends continuously on the vectors \vec{v}_j . This means that the combinatorial geometry of the resulting flat surface (the genus g , the number m and the types of the resulting conical singularities) does not change under small deformations of the vectors \vec{v}_j . This allows us to consider a flat surface as an element of a family of flat surfaces sharing common combinatorial geometry; here we do not distinguish isometric flat surfaces.

Choosing a tangent vector at some point of a surface we can transport this vector to any other point. When the surface has trivial holonomy the result does not depend on the path, so any direction is globally defined on the surface. It is convenient to include the choice of direction in the definition of a flat structure. In particular, we want to distinguish the flat structure represented by the polygon in Figure 1 and the one represented by the same polygon rotated by an angle which is not a multiple of 2π .

Consider a natural coordinate z in the complex plane. In this coordinate parallel translations which we use to identify the sides of the polygon in Figure 1

are represented as $z' = z + \text{const}$. Since this correspondence is holomorphic, it means that our flat surface S with punctured conical points inherits a complex structure. It is easy to check that the complex structure extends to the punctured points. Consider now a holomorphic 1-form dz in the complex plane. When we pass to the surface S the coordinate z is not globally defined anymore. However, since the changes of local coordinates are defined as $z' = z + \text{const}$, we see that $dz = dz'$. Thus, the holomorphic 1-form dz on \mathbb{C} defines a holomorphic 1-form ω on S which in local coordinates has the form $\omega = dz$. It is easy to check that the form ω has zeroes exactly at those points of S where the flat structure has conical singularities.

Conversely, one can show that a pair (Riemann surface, holomorphic 1-form) uniquely defines a flat structure of the type described above.

In an appropriate local coordinate w a holomorphic 1-form can be represented in a neighborhood of a zero as $w^d dw$, where the power d is called the *degree* of the zero. The form ω has a zero of degree d at a conical point with a cone angle $2\pi(d + 1)$. The sum of degrees $d_1 + \dots + d_m$ of zeroes of a holomorphic 1-form on a Riemann surface of genus g equals $2g - 2$. The moduli space \mathcal{H}_g of pairs (complex structure, holomorphic 1-form) is a \mathbb{C}^g -vector bundle over the moduli space \mathcal{M}_g of complex structures. The space \mathcal{H}_g can be naturally decomposed into strata $\mathcal{H}(d_1, \dots, d_m)$ enumerated by unordered¹ partitions of the number $2g - 2$ in a collection of positive integers $2g - 2 = d_1 + \dots + d_m$. Any holomorphic 1-form corresponding to a fixed stratum $\mathcal{H}(d_1, \dots, d_m)$ has exactly m zeroes, and d_1, \dots, d_m are the degrees of zeroes. Note that an individual stratum $\mathcal{H}(d_1, \dots, d_m)$ in general does not form a fiber bundle over \mathcal{M}_g .

More details on the geometry and topology of the strata (in particular studies of a natural Lebesgue measure and ergodicity of the Teichmüller geodesic flow) can be found in the fundamental papers of H. Masur [21] and W. Veech [25, 26, 27]. The bibliography on this subject currently contains hundreds of papers.

Similarly, closed flat surfaces with conical singularities, holonomy group $\mathbb{Z}/2\mathbb{Z}$, and a choice of a line field at some point correspond to meromorphic quadratic differentials with at most simple poles. Flat surfaces of this type can be also glued from polygons: the sides of the polygon are again distributed into pairs of parallel sides of equal lengths, but this time the sides might be identified either by a parallel translation or by a central symmetry, see Figure 2.

1.2. Interval-exchange transformations and Rauzy classes. Consider a flat surface S having trivial linear holonomy. Consider a family of parallel geodesics emitted from a transverse segment X and their first return to X . The resulting first-return map is called an *interval-exchange transformation* $T: X \rightarrow X$. This map is a piecewise isometry and it preserves the orientation. The example below illustrates how interval-exchange transformations can be defined in an intrinsic combinatorial way.

¹Not quite unordered: in this paper, the elements d_1 and d_m (the first one and the last one) play a distinguished role, see Convention 1 in the next section

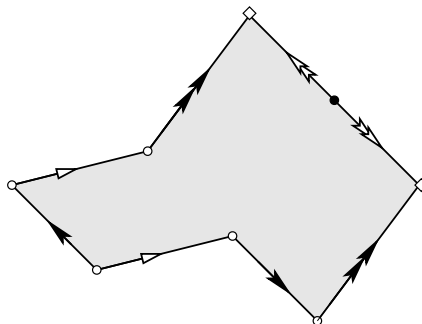

FIGURE 2. Identifying corresponding pairs of sides by isometries we obtain a flat surface of genus one with holonomy group $\mathbb{Z}/2\mathbb{Z}$. The associated quadratic differential belongs to the stratum $\mathcal{Q}(2, -1, -1)$.

Example 1. Consider the flat surface from Figure 3 and the first-return map of a geodesic flow in the vertical direction to a horizontal interval X . We see that this *vertical flow* splits at a cone point and thus the first-return map chops the horizontal interval X into several subintervals placing them back to X in a different order (without overlaps and preserving the orientation). Since in our particular case the cone angle at the single cone point is $6\pi = 3 \cdot 2\pi$ there are *three* vertical trajectories which hit the cone point. The corresponding points at which X is chopped are marked with bold dots. The remaining discontinuity point of X corresponds to a trajectory which hits the endpoint of X . Subintervals X_1, \dots, X_4 (counted from left to right) appear after the first-return map in the order X_3, X_1, X_4, X_2 . Thus, we can naturally associate a permutation

$$\pi = \begin{pmatrix} 1 & 2 & 3 & 4 \\ 3 & 1 & 4 & 2 \end{pmatrix} = (3, 1, 4, 2)^{-1} = (2, 4, 1, 3)$$

to the corresponding interval-exchange transformation.

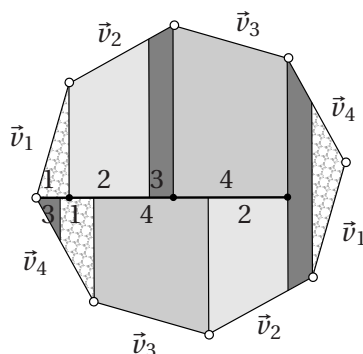

FIGURE 3. The first-return map $T: X \rightarrow X$ induced by the vertical flow on a transverse segment X is an interval-exchange transformation.

A permutation π of n elements $\{1, 2, \dots, n\}$ is called *irreducible* if it does not have any invariant proper subsets of the form $\{1, 2, \dots, k\}$, where $k < n$. Having an interval-exchange transformation $T: X \rightarrow X$ corresponding to an irreducible permutation one can always construct a *suspension* over the interval-exchange transformation T : a flat surface S and a horizontal segment $X \subset S$ inside it such that the first return of the vertical flow to X gives the initial interval-exchange transformation, see [21] or [25].

Figure 1 illustrates a construction of a suspension suggested in [21]. Namely, considering vectors $\vec{v}_1, \dots, \vec{v}_n$ as complex numbers we define the vector \vec{v}_k as

$$\vec{v}_k := |X_k| + \sqrt{-1} \cdot (\pi(k) - k), \quad k = 1, \dots, n,$$

where $|X_k|$ is the length of the k th subinterval, and π is a permutation defining the interval-exchange transformation. Irreducibility of the permutation π implies that two broken lines v_1, \dots, v_n and $v_{\pi^{-1}(1)}, \dots, v_{\pi^{-1}(n)}$ define a polygon, and, moreover, that the first broken line is located above the horizontal diagonal, and the second broken line is located below the horizontal diagonal as in Figure 1. By construction, the first-return map induced by the vertical flow on the horizontal diagonal coincides with the initial interval-exchange transformation.

It is easy to check that any two closed surfaces obtained as suspensions over two interval-exchange transformations sharing the same permutation belong to the same connected component of the same stratum $\mathcal{H}(d_1, \dots, d_m)$, see [25].

In our construction of a suspension S over an interval-exchange transformation $T: X \rightarrow X$, the endpoints of the segment X are located at cone points of the flat surface S . By construction, the cone angles at these cone points depend only on the permutation π (and not on lengths $|X_i|$, $i = 1, \dots, n$, of the subintervals being exchanged).

CONVENTION 1. Whenever we say in this article that *a permutation π represents a stratum $\mathcal{H}(d_1, \dots, d_m)$* , we always assume that the corresponding suspension has a singularity of degree d_1 at the left endpoint of X and one of degree d_m at the right endpoint of X .

A *saddle connection* is a geodesic segment joining a pair of cone singularities or a cone singularity to itself without any singularities in its interior. For the flat metrics as described above, regular closed geodesics always appear in families; any such family fills a maximal cylinder bounded on each side by a closed saddle connection or by a chain of parallel saddle connections.

Consider a flat surface S in some stratum $\mathcal{H}(d_1, \dots, d_m)$; by convention it is endowed with a distinguished vertical direction. Assume that the vertical direction is *minimal*, i.e., it does not admit any vertical saddle connection. Almost any surface in any stratum satisfies this condition, see [21, 25]. A minimal vertical flow endows any horizontal interval X embedded into S and having no singular points in its interior with an interval exchange of n , $n + 1$ or $n + 2$ subintervals, where $n = 2g + m - 1$, see, say, [25]. By convention, let us always choose the horizontal interval X so that the induced interval-exchange transformation has the minimal possible number n of subintervals being exchanged.

Taking a union of permutations realized on all horizontal segments satisfying the above condition we obtain a subset $\mathfrak{R}_{ex}(S) \in \mathfrak{S}_n$ of the set \mathfrak{S}_n of permutations of n elements. The following theorem is a slight reformulation of the results in [25].

THEOREM (W. A. Veech). *Consider a flat surface S with trivial holonomy. Suppose that the flow in the vertical direction on S is minimal. The set $\mathfrak{R}_{ex}(S)$ of permutations of $n = 2g + m - 1$ elements realized by interval-exchange transformations induced by the vertical flow on a flat surface S is the same for almost all flat surfaces S in any connected component of any stratum $\mathcal{H}(d_1, \dots, d_m)$. Denoting this set by \mathfrak{R}_{ex} we get an inclusion $\mathfrak{R}_{ex}(S_0) \subseteq \mathfrak{R}_{ex}$ for any surface S_0 in the same connected component of the stratum (provided minimality of the vertical flow on S_0).*

The sets $\mathfrak{R}_{ex}(S_1)$ and $\mathfrak{R}_{ex}(S_2)$ corresponding to surfaces S_1, S_2 (with minimal vertical flows) from different connected components or from different strata do not intersect.

A set \mathfrak{R}_{ex} as in the above theorem is called an *extended Rauzy class*. It contains only irreducible permutations. Conversely, let π be an irreducible permutation. We have seen, following constructions of H. Masur [21] and of W. Veech [25], that one can construct a suspension $S(\pi)$ over any interval-exchange transformation corresponding to an irreducible permutation π , and clearly $\pi \in \mathfrak{R}_{ex}(S(\pi))$. Hence, any irreducible permutation π belongs to an extended Rauzy class representing a connected component of a stratum embodying $S(\pi)$.

Thus, the set of all irreducible permutations decomposes into a disjoint union of extended Rauzy classes, and the theorem of Veech establishes a one-to-one correspondence between connected components of strata of Abelian differentials and extended Rauzy classes.

Actually, an extended Rauzy class has an alternative, purely combinatorial (and much more constructive) definition as a minimal collection of irreducible permutations invariant under three explicit combinatorial operations. Two operations were introduced by G. Rauzy in [24] and an additional one was introduced by W. A. Veech; see also Appendix B. Applying this combinatorial approach W. Veech and P. Arnoux have decomposed irreducible permutations of a small number of elements in extended Rauzy classes and have found the first examples $\mathcal{H}(4)$ and $\mathcal{H}(6)$ of strata having several connected components.

Remark. Some irreducible permutations give rise to strata with marked points. For example, if an interval-exchange transformation maps two consecutive intervals under exchange to two consecutive (in the same order) intervals, the corresponding suspension gets a “fake singularity”. We tacitly avoid this type of permutation in the current paper.

1.3. Analogs of interval-exchange transformations for quadratic differentials.

Generalized permutations. In many aspects the constructions of the previous section can be generalized to quadratic differentials. Consider a flat surface with holonomy group $\mathbb{Z}/2\mathbb{Z}$ and a an oriented segment X transverse to the vertical foliation. Since the vertical foliation is nonorientable, we emit trajectories from

X both in upward and downward directions. Making a slit along X we get two shores X^+ and X^- of the slit; we emit trajectories “downward” from the “bottom” shore X^- and “upward” from the “top” shore X^+ . We get a well-defined first-return map T which is a piecewise isometry of $X^+ \sqcup X^-$ to itself. Each of the two copies X^+ and X^- of X inherit an orientation of X . When the image of a subinterval gets to the opposite shore (as in the previous section) it preserves the orientation; when it gets to the same shore it changes the orientation.

Consider the natural partitions $X^+ = X_1 \sqcup \dots \sqcup X_r$ and $X^- = X_{r+1} \sqcup \dots \sqcup X_s$, where each X_i is a maximal subinterval of continuity of the map T . By construction, the map $T: X^+ \sqcup X^- \rightarrow X^+ \sqcup X^-$ is an involution which does not map any interval to itself, in particular, the total number s of subintervals is even, $s = 2n$. Denoting subintervals in each pair in involution by identical symbols we encode combinatorics of the map T by two lines of symbols in such way that every symbol appears exactly twice. We call such combinatorial data a *generalized permutation*.

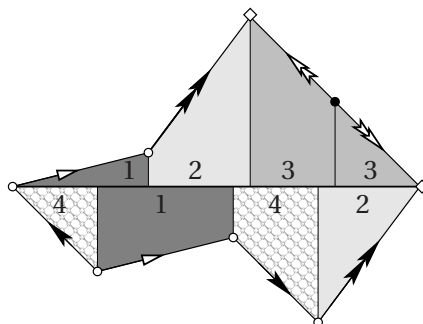

FIGURE 4. Generalized interval-exchange transformation.

Example. For a surface S and a horizontal segment X as in Figure 4 the vertical foliation defines on two shores of X a generalized interval-exchange transformation with a generalized permutation

$$\pi = \begin{pmatrix} 1 & 2 & 3 & 3 \\ 4 & 1 & 4 & 2 \end{pmatrix}.$$

Note, however, that the cardinalities of the upper and lower lines of a generalized permutation are in general different.

One can define an *irreducible* generalized permutation. This notion is not quite elementary: an adequate combinatorial definition was elaborated only recently by C. Boissy and E. Lanneau in [6]. We do not reproduce this definition since in our paper we basically consider only generalized permutations of a special form (2) below which are always irreducible.

Any irreducible generalized permutation defines a family of generalized interval-exchange transformations; every interval-exchange transformation in this family admits a suspension. Assume that our irreducible generalized permutation is not a *true* permutation. Then the flat surface S obtained as a suspension

has nontrivial holonomy group $\mathbb{Z}/2\mathbb{Z}$. The connected component of the stratum $\mathcal{Q}(d_1, \dots, d_m)$, embodying S is uniquely determined by the generalized permutation. The collection of generalized permutations of $n = 2g + m - 1$ symbols corresponding to a given connected component of a given stratum is again called an *extended Rauzy class*; it can be defined either implicitly by a theorem analogous to the theorem of W. A. Veech cited above, or by an effective combinatorial construction (minimal nonempty collection of irreducible generalized permutations invariant under Rauzy operations) due to C. Boissy and E. Lanneau. We refer the reader to their paper [6] for a comprehensive study of relations between the combinatorics, geometry and dynamics of generalized permutations and their Rauzy classes (see also the outline in Appendix B).

Generalizations of interval-exchange transformations corresponding to measured foliations on *nonorientable* surfaces were studied by C. Danthony and A. Nogueira in [8].

1.4. Jenkins–Strebel differentials with a single cylinder. An Abelian or a quadratic differential is called a *Jenkins–Strebel differential* if the union of critical leaves and critical points of its horizontal foliation is compact. Equivalently, a differential is Jenkins–Strebel if and only if any nonsingular horizontal leaf is closed. In other words, the corresponding flat surface is glued from a finite number of maximal flat cylinders filled with closed horizontal leaves. In this paper we consider the special case when the Jenkins–Strebel differential is represented by a *single* flat cylinder C filled by closed horizontal leaves. Note that all zeroes and poles (critical points of the horizontal foliation) of such differential are located on the boundary of this cylinder.

Each of the two boundary components ∂C^+ and ∂C^- of the cylinder is subdivided into a collection of horizontal saddle connections $\partial C^+ = X_{\alpha_1} \sqcup \dots \sqcup X_{\alpha_r}$ and $\partial C^- = X_{\alpha_{r+1}} \sqcup \dots \sqcup X_{\alpha_s}$. The subintervals are naturally organized in pairs of subintervals of equal length; subintervals in every pair are identified by a natural isometry which preserves the orientation of the surface. Denoting both subintervals in the pair representing the same saddle connection by the same symbol, we can naturally encode the combinatorics of identification of the boundaries of the cylinder by two lines of symbols,

$$(1) \quad \begin{array}{c} \overbrace{\alpha_1 \quad \dots \quad \alpha_r} \\ \underbrace{\alpha_{r+1} \quad \dots \quad \alpha_s} \end{array}$$

where symbols in each line are organized in a cyclic order. By construction, every symbol appears exactly twice. If all the symbols in each line are distinct, the resulting flat surface has trivial linear holonomy and corresponds to an Abelian differential. Otherwise a flat metric of the resulting closed surface has holonomy group $\mathbb{Z}/2\mathbb{Z}$; in the latter case it corresponds to a meromorphic quadratic differential with at most simple poles.

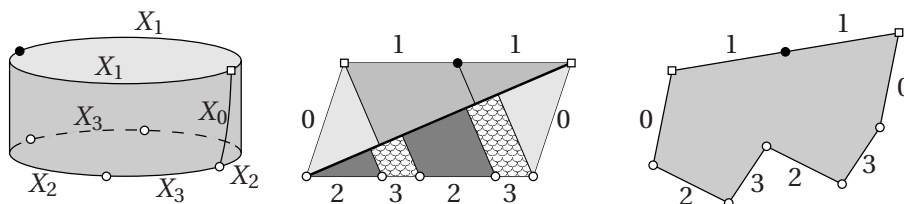

FIGURE 5. A Jenkins–Strebel differential with a single cylinder, one of its parallelogram patterns, and its deformation inside the embodying stratum.

Combinatorial data encoding identifications of the boundary components of the cylinder resembles a generalized permutation defined in the previous section. Choose a singular point on each of the two boundary components of the cylinder and join the two points by a geodesic segment X_{α_0} , as in Figure 5. For example, choose the left endpoint of X_{α_1} on the upper boundary component ∂C^+ and the left endpoint of $X_{\alpha_{r+1}}$ on the lower boundary component ∂C^- . Cutting our metric cylinder by X_{α_0} we unfold our flat surface into a parallelogram. Consider a diagonal of this parallelogram and a direction transverse to this diagonal. The induced generalized interval-exchange transformation corresponds to one of the following two generalized permutations

$$(2) \quad \begin{pmatrix} \alpha_0 & \alpha_1 & \dots & \alpha_r & & \\ & \alpha_{r+1} & \dots & \dots & \alpha_s & \alpha_0 \end{pmatrix} \quad \text{or} \quad \begin{pmatrix} & \alpha_1 & \dots & \alpha_r & & \alpha_0 \\ \alpha_0 & \alpha_{r+1} & \dots & \dots & \alpha_s & \end{pmatrix}$$

representing two possible choices of a diagonal of the parallelogram.

Example. Consider a Jenkins–Strebel differential with a single cylinder, a cutting segment X_0 and a diagonal of the resulting parallelogram as in Figure 5. The foliation orthogonal to the diagonal defines a generalized interval-exchange transformation on the two sides of the diagonal with a generalized permutation

$$(3) \quad \pi = \begin{pmatrix} 0 & 1 & 1 & & \\ 2 & 3 & 2 & 3 & 0 \end{pmatrix}.$$

Remark. Note that neither of the two lines of structure (1) has a distinguished element. Thus there is no distinguished generalized permutation associated to a Jenkins–Strebel differential with a single cylinder: before adding an extra symbol α_0 as in (2) we can cyclically move the elements in any of the two lines.

Moreover, if our flat surface is represented by a quadratic (and not Abelian) differential, there is no canonical way to assign the notions of “top” and “bottom” boundary components ∂C^+ and ∂C^- of the cylinder. Thus, there is no canonical choice between the two structures



Example. All generalized permutations below correspond to the same Jenkins–Strebel differential with a single cylinder:

$$\begin{pmatrix} 0, 1, 2, 1, 2, 3 \\ 3, 4, 4, 0 \end{pmatrix}, \begin{pmatrix} 0, 3, 1, 2, 1, 2 \\ 4, 3, 4, 0 \end{pmatrix}, \begin{pmatrix} 0, 4, 4, 3 \\ 3, 2, 1, 2, 1, 0 \end{pmatrix}, \begin{pmatrix} 0, 3, 4, 4 \\ 2, 1, 2, 1, 3, 0 \end{pmatrix}$$

1.5. From cylindrical generalized permutations to Jenkins–Strebel differentials and polygonal patterns of flat surfaces. It is convenient to formalize the combinatorial data above in the following definitions.

DEFINITION. Consider an alphabet $\{\alpha_0, \alpha_1, \dots\}$. A *generalized permutation* is an ordered pair

$$\begin{pmatrix} \alpha_{i_0} & \alpha_{i_1} & \dots & \alpha_{i_r} \\ \alpha_{i_{r+1}} & \dots & \dots & \dots & \alpha_{i_s} \end{pmatrix}$$

of nonempty finite words (usually called “lines”) $\{\alpha_{i_0}, \alpha_1, \dots, \alpha_{i_r}\}$, $\{\alpha_{i_{r+1}}, \dots, \alpha_{i_s}\}$ satisfying the following condition: every symbol present in at least one of the words appears exactly one more time either in the same word or in the other one.

A bijection between alphabets $\{\alpha_0, \alpha_1, \dots\}$ and $\{\beta_0, \beta_1, \dots\}$ (including a bijection of an alphabet to itself) induces natural bijection between generalized permutations in letters α_i and generalized permutations in letters β_i . Unless stated explicitly, we will identify the corresponding permutations.

DEFINITION. A generalized permutation is called *cylindrical* if the first symbol of one of the lines coincides with the last symbol of the complementary line (see (2)) and if, moreover, the set of all symbols in either of two lines does not form a proper subset of the set of symbols in a complementary line.

Note that we allow the unions of symbols in the lines of a cylindrical generalized permutation to coincide: in this case we get a true permutation.

From now on we shall consider only cylindrical generalized permutations. More general generalized permutations will reappear only in Section 3.8 and in the appendices. In particular, any cylindrical generalized permutation is necessarily *irreducible*, see [6]. For practical purposes, this means that we can always construct a “suspension” over a cylindrical generalized permutation; this construction is described in the next several paragraphs.

Consider a cylindrical generalized permutation π . Let $\{\beta_1, \dots, \beta_p\}$ be the symbols which are present only in the bottom line (as symbols “2, 3” in generalized permutation (3) above), and let $\{\gamma_1, \dots, \gamma_q\}$ be the symbols which are present only in the top line (as symbol “1” in the generalized permutation (3) above). Our definition of a cylindrical generalized permutation implies that either these sets are both empty, and so π is a true permutation, or they are both nonempty. We are especially interested in the latter case. Consider a generalized interval-exchange transformation T corresponding to π . We can choose any lengths for the subintervals being exchanged provided they satisfy the linear relation

$$(4) \quad |X_{\gamma_1}| + \dots + |X_{\gamma_p}| = |X_{\beta_1}| + \dots + |X_{\beta_q}|.$$

Clearly for any such generalized interval-exchange transformation we can perform a construction inverse to the one described in the previous section and realize a “suspension” by a Jenkins–Strebel differential with a single cylinder, such as in the middle and the left pictures in Figure 5. (This observation is due to E. Lanneau, [18].)

Finally, note that we can consider a parallelogram constructed in our suspension as a polygon similar to the ones in Figures 1 through 4. The polygon is obtained from two broken lines $\vec{v}_{\alpha_0}, \vec{v}_{\alpha_1}, \dots, \vec{v}_{\alpha_r}$ and $\vec{v}_{\alpha_{r+1}}, \vec{v}_{\alpha_1}, \dots, \vec{v}_{\alpha_s}, \vec{v}_{\alpha_0}$, where all the vectors different from \vec{v}_{α_0} are horizontal. These vectors satisfy a relation analogous to relation (4), namely:

$$\vec{v}_{\gamma_1} + \dots + \vec{v}_{\gamma_p} = \vec{v}_{\beta_1} + \dots + \vec{v}_{\beta_q}.$$

Deforming all the vectors slightly by a deformation respecting the above relation (see the right picture in Figure 5) we obtain a small open neighborhood of the initial Jenkins–Strebel differential in the embodying stratum $\mathcal{Q}(d_1, \dots, d_m)$. In other words, an open set of flat surfaces in $\mathcal{Q}(d_1, \dots, d_m)$ can be obtained by identification of pairs of corresponding sides of a polygon as on the right picture in Figure 5. The combinatorics of the polygon (and of the identifications of pairs of sides) is fixed by the initial generalized permutation π . Note that the property “a flat surface S can be glued from a polygon of fixed combinatorics π ” is $GL(2, \mathbb{R})$ -invariant. Thus, by ergodicity of the $SL(2; \mathbb{R})$ -action, we get the following simple observation.

PROPOSITION 1. *If a flat surface S can be unfolded to a polygon having combinatorial structure represented by a cylindrical generalized permutation, then almost any flat surface in the same connected component of the embodying stratum can be unfolded to a polygon sharing the same combinatorial structure.*

1.6. Goal of the paper. The main goal of the current paper is to explicitly construct a cylindrical generalized permutation representing any given connected component of any given stratum of Abelian or quadratic differentials. As was shown in the previous section, such a permutation immediately provides us with a Jenkins–Strebel differential with a single cylinder in the corresponding connected component, a polygonal representation of almost any flat surface in the corresponding connected component, and a representative of the corresponding extended Rauzy class. Our main tool is the geometry of ribbon graph representations of Jenkins–Strebel differentials (see [13] for more details) combined with elementary combinatorics of cylindrical permutations.

Remark. It was proved by A. Douady and J. Hubbard that Jenkins–Strebel differentials are dense in the principal stratum $\mathcal{Q}(1, \dots, 1)$ of quadratic differentials, see [9]. This result was strengthened in by H. Masur in [20] who proved that Jenkins–Strebel differentials *with a single cylinder* are also dense in $\mathcal{Q}(1, \dots, 1)$. The statement on the density of Jenkins–Strebel differentials with a *single cylinder* was extended by M. Kontsevich and the author to any stratum of Abelian differentials, see [16]. The latter proof was generalized by E. Lanneau in [18] for any stratum of meromorphic quadratic differentials with at most simple poles.

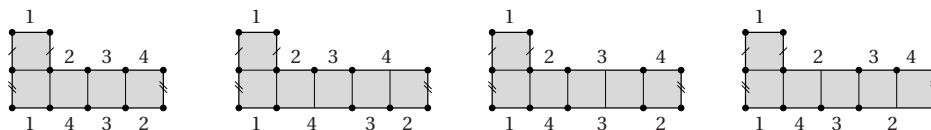

FIGURE 6. $GL(2, \mathbb{R})$ -orbits of these surfaces are closed and do not contain Jenkins–Strebel differentials with a single cylinder.

Nevertheless, a closed $SL(2, \mathbb{R})$ -invariant suborbifold of a stratum might contain no Jenkins–Strebel differentials with a single cylinder. As usual, counterexamples might be found among orbits of arithmetic Veech surfaces. For example, the four surfaces presented in Figure 6 belong to four distinct $SL(2, \mathbb{R})$ -orbits in the connected component $\mathcal{H}^{hyp}(4)$. These orbits contain correspondingly 15, 15, 10 and 10 square-tiled surfaces. None of them are composed of a single cylinder, which implies that none of the corresponding $SL(2, \mathbb{R})$ -orbits contain a Jenkins–Strebel differential with a single cylinder.

1.7. Idea of construction. We complete the introduction by an illustration of the main idea of our construction in a simple particular case. Consider a Jenkins–Strebel differential with a single cylinder. Suppose for simplicity that the resulting flat surface has trivial linear holonomy. In the previous section we have represented a Jenkins–Strebel differential as a cylinder with some identifications of the boundary.

Consider now another representation of the same Jenkins–Strebel differential, obtained by cutting the surface along a *regular* horizontal leaf passing along the “equator” of the cylinder. We get an oriented *flat ribbon graph* (see [13] for details) with two boundary components. Its skeleton is realized by an oriented graph of horizontal saddle connections of our Jenkins–Strebel differential.

Following a boundary component in the positive direction of the horizontal foliation we can trace the cyclic order in which we follow the saddle connections. For example, for the concrete ribbon graph in the top picture in Figure 7, we get

$$(5) \quad \begin{array}{l} \curvearrowright 1 \rightarrow 2 \rightarrow 3 \rightarrow 4 \rightarrow 5 \rightarrow 6 \rightarrow 7 \rightarrow 8 \curvearrowleft \\ \curvearrowright 4 \rightarrow 3 \rightarrow 2 \rightarrow 5 \rightarrow 8 \rightarrow 7 \rightarrow 6 \rightarrow 1 \curvearrowleft \end{array}$$

corresponding to the upper and lower boundary components ∂C^+ and ∂C^- , respectively. It is easy to pass from a ribbon graph representation to a cylinder representation and vice versa.

Note that the lengths of the saddle connections $|X_1|, \dots, |X_8|$ are independent variables, and we may deform them arbitrarily. We can even shrink one of the intervals $|X_1|, \dots, |X_8|$ completely and we still get a legitimate flat surface represented by a new Jenkins–Strebel differential with a single cylinder.

It is obvious from the ribbon graph representation (see the top picture in Figure 7) that in our example the Jenkins–Strebel differential belongs to the stratum $\mathcal{H}(1, 1, 1, 1)$. Let us denote the zeroes (vertices of the skeleton graph) as indicated

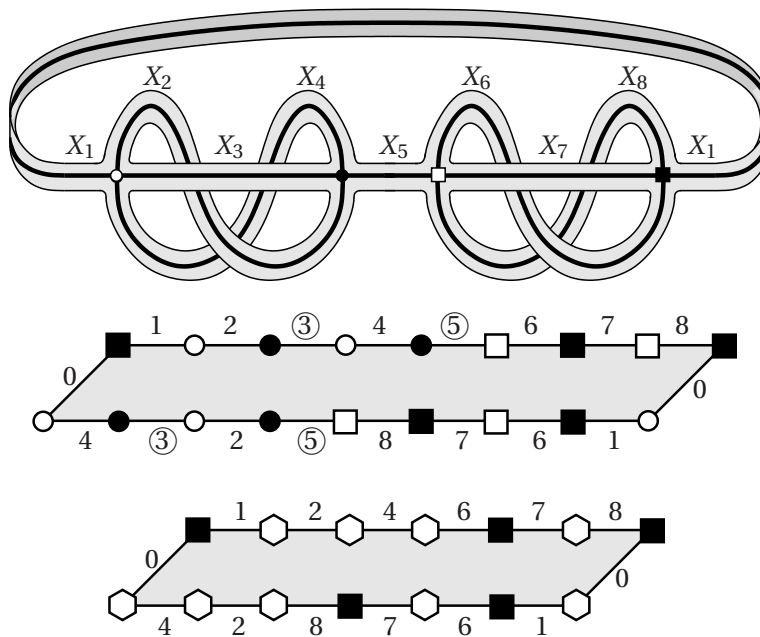

FIGURE 7. The ribbon graph representation of a Jenkins–Strebel differential with a single cylinder (top picture) versus the cylinder representation (middle picture). A Jenkins–Strebel differential with a single cylinder obtained from the initial one by contracting saddle connections X_3 and X_5 (bottom picture).

in Figure 7. Consider the following embedded chain of saddle connections joining these four zeroes:

$$\bullet \xrightarrow{X_3} \circ \xrightarrow{X_5} \square \xrightarrow{X_7} \blacksquare.$$

Shrinking the saddle connection X_3 we merge two simple zeroes and get a Jenkins–Strebel differential in the stratum $\mathcal{H}(2, 1, 1)$. Shrinking the saddle connections X_3 and X_7 we merge two pairs of simple zeroes and get a Jenkins–Strebel differential in the stratum $\mathcal{H}(2, 2)$. Shrinking the saddle connections X_3 and X_5 we merge three simple zeroes and get a Jenkins–Strebel differential in the stratum $\mathcal{H}(3, 1)$. Shrinking all three saddle connections X_3, X_5, X_7 we get a Jenkins–Strebel differential in $\mathcal{H}(4)$.

In terms of a cylinder representation these operations are simple: we just erase corresponding symbols in each of the two lines in (5). For example, the cylinder representation of the Jenkins–Strebel differential in $\mathcal{H}(3, 1)$ obtained by shrinking the saddle connections X_3 and X_5 is presented in the bottom picture

of Figure 7; it is encoded as

$$\left. \begin{array}{l} \curvearrowright 1 \rightarrow 2 \rightarrow 4 \rightarrow 6 \rightarrow 7 \rightarrow 8 \curvearrowleft \\ \curvearrowright 4 \rightarrow 2 \rightarrow 8 \rightarrow 7 \rightarrow 6 \rightarrow 1 \curvearrowleft \end{array} \right\}$$

Cutting the cylinder of the resulting surface by a segment X_0 we obtain a suspension over an interval-exchange transformation with permutation

$$\pi = \begin{pmatrix} 0 & 1 & 2 & 4 & 6 & 7 & 8 \\ & 4 & 2 & 8 & 7 & 6 & 1 & 0 \end{pmatrix},$$

or, after alignment and reenumeration,

$$\pi = \begin{pmatrix} 1 & 2 & 3 & 4 & 5 & 6 & 7 \\ 4 & 3 & 7 & 6 & 5 & 2 & 1 \end{pmatrix}.$$

Thus, the latter permutation represents the stratum $\mathcal{H}(3, 1)$.

Remark. In general, shrinking a saddle connection joining a pair of distinct zeroes may result in a degenerate surface: our saddle connection might have homologous ones (see [10] and [23] for details). Moreover, shrinking a saddle connection joining a zero to a simple pole for surfaces in the component $\mathcal{Q}^{irr}(9, -1)$ *always* yields a degenerate surface (see [18]). Our situation is special: horizontal saddle connections of an Abelian Jenkins–Strebel differential with a single cylinder are never homologous; for quadratic Jenkins–Strebel differentials it is easy to identify the homologous ones (see [23] for more details).

2. REPRESENTATIVES OF STRATA OF ABELIAN DIFFERENTIALS

We will separately consider Abelian and quadratic differentials. In each case we start by recalling a classification of connected components of the strata. Then for each connected component we construct a cylindrical generalized permutation of the form (2) representing the chosen connected component.

2.1. Classification of connected components: strata of Abelian differentials.

Connected components of strata of Abelian differentials are classified by the following two parameters, see [16].

For any $g \geq 2$ two special strata, namely $\mathcal{H}(2g-2)$ and $\mathcal{H}(g-1, g-1)$ contain *hyperelliptic* connected components $\mathcal{H}^{hyp}(2g-2)$ and $\mathcal{H}^{hyp}(g-1, g-1)$. A flat surface in the stratum $\mathcal{H}(2g-2)$ belongs to $\mathcal{H}^{hyp}(2g-2)$ if and only if the underlying Riemann surface is hyperelliptic. A flat surface in the stratum $\mathcal{H}(g-1, g-1)$ belongs to the component $\mathcal{H}^{hyp}(g-1, g-1)$ if and only if the underlying Riemann surface is hyperelliptic and the hyperelliptic involution interchanges the zeroes. In particular, according to this definition the locus of hyperelliptic flat surfaces in $\mathcal{H}(g-1, g-1)$ for which the hyperelliptic involution fixes the zeroes is located in one of the nonhyperelliptic connected components.

When all degrees of zeroes of an Abelian differential are even, *i.e.*, when the flat surface belongs to $\mathcal{H}(2d_1, \dots, 2d_m)$, one can associate to the flat surface a *parity of the spin-structure* which takes value zero or one depending only on the embodying connected component (see Appendix C).

For flat surfaces of genus four and higher, these two invariants take all possible values and classify the connected components. In small genera some values of these invariants are not realizable, so there are fewer connected components than in general.

THEOREM (M. Kontsevich and A. Zorich). *All connected components of any stratum of Abelian differentials on a complex curve of genus $g \geq 4$ are described by the following list:*

The stratum $\mathcal{H}(2g - 2)$ has three connected components: the hyperelliptic one, $\mathcal{H}^{hyp}(2g - 2)$, and two other components: $\mathcal{H}^{even}(2g - 2)$ and $\mathcal{H}^{odd}(2g - 2)$ corresponding to even and odd spin structures.

The stratum $\mathcal{H}(2l, 2l)$, $l \geq 2$ has three connected components: the hyperelliptic one, $\mathcal{H}^{hyp}(2l, 2l)$, and two other components: $\mathcal{H}^{even}(2l, 2l)$ and $\mathcal{H}^{odd}(2l, 2l)$.

All the other strata of the form $\mathcal{H}(2l_1, \dots, 2l_n)$, where all $l_i \geq 1$, have two connected components: $\mathcal{H}^{even}(2l_1, \dots, 2l_n)$ and $\mathcal{H}^{odd}(2l_1, \dots, 2l_n)$, corresponding to even and odd spin structures.

The strata $\mathcal{H}(2l - 1, 2l - 1)$, $l \geq 2$, have two connected components; one of them, $\mathcal{H}^{hyp}(2l - 1, 2l - 1)$, is hyperelliptic; the other one, $\mathcal{H}^{nonhyp}(2l - 1, 2l - 1)$, is not.

All other strata of Abelian differentials on complex curves of genera $g \geq 4$ are nonempty and connected.

The theorem below shows that in genera $g = 2, 3$ some components are missing with respect to the general case. Connected components in small genera were classified by W. A. Veech and by P. Arnoux using *Rauzy classes* (see Appendix B); the corresponding invariants (hyperellipticity and parity of the spin structure) were evaluated by M. Kontsevich and the author. In full generality the theorem below is proved in [16].

THEOREM. *The moduli space of Abelian differentials on a complex curve of genus $g = 2$ contains two strata: $\mathcal{H}(1, 1)$ and $\mathcal{H}(2)$. Each of them is connected and coincides with its hyperelliptic component.*

Each of the strata $\mathcal{H}(2, 2)$, $\mathcal{H}(4)$ of the moduli space of Abelian differentials on a complex curve of genus $g = 3$ has two connected components: the hyperelliptic one, and one having odd spin structure. The other strata are connected for genus $g = 3$.

2.2. Representatives of connected strata. We use the following natural convention in the statements of Propositions 2 – 10. Consider an ordered set $\{j_1, j_2, \dots\}$. For $n = 1$ the subcollection

$$\underbrace{j_1, \dots, j_{n-1}}_{n-1}$$

is defined to be empty.

Let d_1, \dots, d_m be an arbitrary collection of strictly positive integers satisfying the relation $d_1 + \dots + d_m = 2g - 2$.

PROPOSITION 2. *A permutation obtained by erasing symbols*

$$\underbrace{3, 5, \dots, 2d_1 - 1}_{d_1 - 1}, \underbrace{2d_1 + 3, \dots, 2(d_1 + d_2) - 1}_{d_2 - 1}, \underbrace{\dots}_{\dots},$$

$$\underbrace{\dots}_{\dots}, \underbrace{2(d_1 + \dots + d_{m-1}) + 3, \dots, 2(d_1 + \dots + d_m) - 1}_{d_m - 1}$$

in the permutation

$$\left(\begin{array}{cccccccccccc} 0 & 1 & 2 & \textcircled{3} & 4 & \textcircled{5} & 6 & \textcircled{7} & 8 & \dots & \textcircled{4g-7} & 4g-6 & \textcircled{4g-5} & 4g-4 \\ & & 4 & \textcircled{3} & 2 & \textcircled{5} & 8 & \textcircled{7} & 6 & \dots & \textcircled{4g-7} & 4g-4 & \textcircled{4g-5} & 4g-6 & 1 & 0 \end{array} \right),$$

represents the stratum $\mathcal{H}(d_1, \dots, d_m)$.

Note that for $g = 2$ the above permutation should be read as

$$\left(\begin{array}{ccccc} 0 & 1 & 2 & 3 & 4 \\ & & 4 & 3 & 2 & 1 & 0 \end{array} \right)$$

Proof. The proof is completely analogous to the one presented in Section 1.7 for the case $g = 3$. Namely, consider a Jenkins–Strebel differential with a single cylinder as in Figure 8. By construction, it belongs to the principal stratum $\mathcal{H}(1, \dots, 1)$

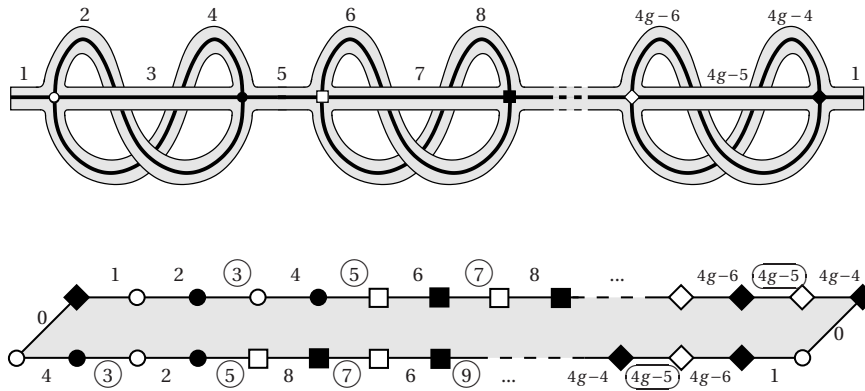

FIGURE 8. A Jenkins–Strebel differential with a single cylinder in the stratum $\mathcal{H}(1, \dots, 1)$ and its cylinder representation. The distinguished symbols $3, 5, \dots, 4g - 5$ enumerate the saddle connections chosen for contraction.

of Abelian differentials in genus g . The cylinder representation of this Jenkins–Strebel differential provides us with the above permutation representing the extended Rauzy class of the principal stratum. Note that an embedded chain of $2g - 1$ saddle connections

$$P_1 \xrightarrow{X_3} P_2 \xrightarrow{X_5} \dots \xrightarrow{X_{4g-5}} P_{2g-2}$$

joins all $2g - 2$ zeroes of the corresponding Abelian differential. Hence by contracting the saddle connections indexed by symbols from the groups indicated below,

$$\left\{ \underbrace{3, 5, \dots, 2d_1 - 1}_{d_1 - 1}, \quad 2d_1 + 1, \quad \underbrace{2d_1 + 3, \dots, 2(d_1 + d_2) - 1}_{d_2 - 1}, \quad 2(d_1 + d_2) + 1, \quad \dots, \right. \\ \left. \dots, \quad 2(d_1 + \dots + d_{m-1}) + 3, \quad \underbrace{2(d_1 + \dots + d_{m-1}) + 3, \dots, 2(d_1 + \dots + d_m) - 1}_{d_m - 1} \right\},$$

we merge zeroes P_1, \dots, P_{d_1} into a single zero of degree d_1 , zeroes $P_{d_1+1}, \dots, P_{d_1+d_2}$ into a single zero of degree d_2, \dots , zeroes $P_{d_1+\dots+d_{m-1}+1}, \dots, P_{d_1+\dots+d_m}$ into a single zero of degree d_m . A cylinder representation of the resulting Jenkins–Strebel differential provides us with a permutation obtained from the initial one by erasing the symbols enumerating the contracted saddle connections. \square

2.3. Representatives of components $\mathcal{H}^{odd}(2d_1, \dots, 2d_m)$. Let d_1, \dots, d_m be an arbitrary collection of strictly positive integers such that $d_1 + \dots + d_m = g - 1$, where $g \geq 3$.

PROPOSITION 3. *A permutation obtained by erasing symbols*

$$\underbrace{4, 7, \dots, 3d_1 - 2}_{d_1 - 1}, \quad \underbrace{3d_1 + 4, \dots, 3(d_1 + d_2) - 2}_{d_2 - 1}, \quad \dots, \\ \dots, \quad \underbrace{3(d_1 + \dots + d_{m-1}) + 4, \dots, 3(d_1 + \dots + d_m) - 2}_{d_m - 1}$$

in the permutation

$$(6) \begin{pmatrix} 0 & 1 & 2 & 3 & \textcircled{4} & 5 & 6 & \textcircled{7} & 8 & 9 & \dots & \textcircled{3g-5} & 3g-4 & 3g-3 \\ & & 3 & 2 & \textcircled{4} & 6 & 5 & \textcircled{7} & 9 & 8 & \dots & \textcircled{3g-5} & 3g-3 & 3g-4 & 1 & 0 \end{pmatrix},$$

represents the component $\mathcal{H}^{odd}(2d_1, \dots, 2d_m)$.

The proof is based on the following simple Lemma.

LEMMA 1. *A Jenkins–Strebel differential with a single cylinder as in Figure 9 belongs to the component $\mathcal{H}^{odd}(\underbrace{2, \dots, 2}_{g-1})$.*

Proof of Lemma 1. The fact that our Abelian differential belongs to the stratum $\mathcal{H}(\underbrace{2, \dots, 2}_{g-1})$ is obvious; it is only necessary to compute the parity of the spin structure of this differential, see [16] and Appendix C.

Consider the following collection of closed paths on our flat surface. On the k th repetitives pattern of the surface ($k = 1, \dots, g - 1$) we choose closed paths α_k, β_k as indicated in Figure 10. We complete this collection of paths with two paths α_g and β_g , where α_g is a closed geodesic as in Figure 10 and β_g follows the chain of saddle connections

$$X_1 \rightarrow X_4 \rightarrow X_7 \rightarrow \dots \rightarrow X_{3g-5} \rightarrow$$

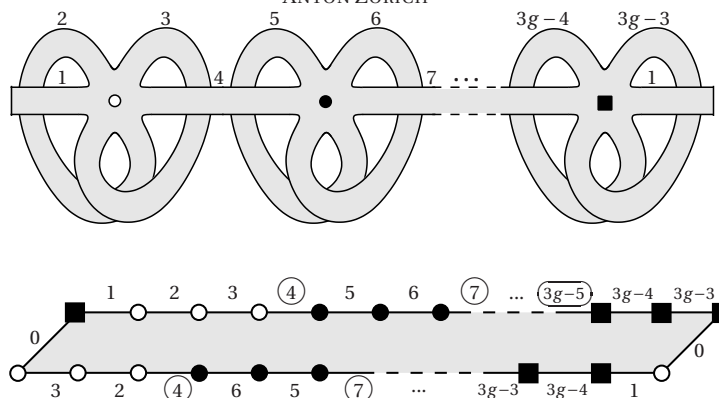

FIGURE 9. A Jenkins–Strebel differential with a single cylinder in the component $\mathcal{H}^{odd}(2, \dots, 2)$ and its cylinder representation. The distinguished symbols $4, 7, \dots, 3g - 5$ enumerate saddle connections chosen for contraction.

avoiding the zeroes as indicated in Figure 10. By construction, the paths α_k, β_k , $k = 1, \dots, g$, in each pair have simple transverse intersections, and paths from distinct pairs do not intersect. Hence, we have constructed a canonical basis of cycles.

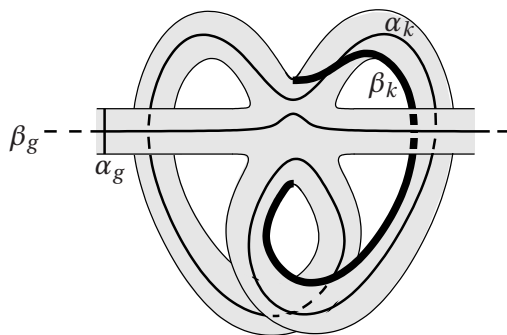

FIGURE 10. Construction of a convenient canonical basis of cycles.

A smooth path γ on a flat surface with trivial linear holonomy defines a natural Gauss map $\gamma \rightarrow S^1$ to a circle. Define $ind(\gamma)$ to be the index of the Gauss map modulo 2. It was proved in [16] that having realized a canonical basis of cycles by a collection of smooth connected closed curves avoiding singularities of a flat surface $S \in \mathcal{H}(2d_1, \dots, 2d_m)$ one can compute the parity of the spin structure as

$$(7) \quad \varphi(S) := \sum_{i=1}^g (ind(\alpha_i) + 1)(ind(\beta_i) + 1) \pmod{2}.$$

With the exception of the path β_g all paths in our family are everywhere transverse to the horizontal foliation. This implies that the corresponding indices $ind(\alpha_1) = ind(\beta_1) = \dots = ind(\alpha_g)$ are equal to zero. It is easy to see that $ind(\beta_g) =$

$g - 1$, since every time β_g passes near a zero, the image of the Gauss map makes a complete turn around the circle. Applying now formula (7) to our collection of paths we see that the parity of the spin structure is odd:

$$\varphi(S) = \sum_{i=1}^{g-1} (0+1)(0+1) + (0+1)((g-1)+1) = g-1 + g \equiv 1 \pmod{2}$$

Lemma 1 is proved. □

Proof of Proposition 3. A cylinder representation of our Jenkins–Strebel differential provides us with permutation (6) which by Lemma 1 represents the component $\mathcal{H}^{odd}(\underbrace{2, \dots, 2}_{g-1})$. Note that an embedded chain of $g - 1$ saddle connections

$$P_1 \xrightarrow{X_4} P_2 \xrightarrow{X_7} \dots \xrightarrow{X_{4g-5}} P_{g-1}$$

joins all $g - 1$ zeroes of the corresponding Abelian differential. Hence, contracting the saddle connections indexed by the symbols from the groups indicated in Proposition 3 we merge a group of zeroes P_1, \dots, P_{d_1} of degree 2 into a single zero of degree $2d_1$, a group of zeroes $P_{d_1+1}, \dots, P_{d_1+d_2}$ of degree 2 into a single zero of degree $2d_2, \dots$, and a group of zeroes $P_{d_1+\dots+d_{m-1}+1}, \dots, P_{d_1+\dots+d_{m-1}+d_m}$ of degree 2 into a single zero of degree $2d_m$. Hence the resulting flat surface belongs to the stratum $\mathcal{H}(2d_1, \dots, 2d_m)$.

Recall that merging the zeroes we do not change the parity of the spin structure, see [16]. (It also follows from formula (7) since deforming our flat surface we can deform the family of the paths in such a way that their indices do not change.) This implies that the spin structure of the resulting flat surface has odd parity.

A cylinder representation of the resulting Jenkins–Strebel differential provides us with a permutation obtained from permutation (6) by erasing the symbols enumerating the contracted saddle connections.

It remains to prove that in the two particular cases when we get a surface in the stratum $\mathcal{H}(2d, 2d)$ or $\mathcal{H}(2g-2)$ the resulting flat surface S does not belong to the hyperelliptic connected component as soon as $g \geq 3$. Consider the cylinder representation of the surface S :

$$\begin{array}{c} \left(\begin{array}{cccccc} 1 & 2 & 3 & \dots & 3g-4 & 3g-3 \end{array} \right) \\ \left(\begin{array}{cccccc} 1 & 3 & 2 & \dots & 3g-3 & 3g-4 \end{array} \right) \end{array}$$

By Proposition 5 in Section 2.5, this surface is not hyperelliptic. Proposition 3 is proved. □

2.4. Representatives of components $\mathcal{H}^{even}(2d_1, \dots, 2d_m)$. Consider a collection d_1, \dots, d_m of strictly positive integers satisfying a relation $d_1 + \dots + d_m = g - 1$, where $g \geq 4$.

PROPOSITION 4. *A permutation obtained by erasing symbols*

$$\underbrace{4, 7, \dots, 3d_1 - 2}_{d_1 - 1}, \underbrace{3d_1 + 4, \dots, 3(d_1 + d_2) - 2}_{d_2 - 1}, \underbrace{\dots}_{\dots},$$

$$\underbrace{\dots}_{\dots}, \underbrace{3(d_1 + \dots + d_{m-1}) + 4, \dots, 3(d_1 + \dots + d_m) - 2}_{d_m - 1}$$

in the permutation

$$(8) \begin{pmatrix} 0 & 1 & 2 & 3 & \textcircled{4} & 5 & 6 & \textcircled{7} & 8 & 9 & \dots & \textcircled{3g-5} & 3g-4 & 3g-3 \\ & & 6 & 5 & \textcircled{4} & 3 & 2 & \textcircled{7} & 9 & 8 & \dots & \textcircled{3g-5} & 3g-3 & 3g-4 & 1 & 0 \end{pmatrix},$$

represents the component $\mathcal{H}^{even}(2d_1, \dots, 2d_m)$.

The proof is based on the following simple Lemma.

LEMMA 2. *A Jenkins–Strebel differential with a single cylinder as in Figure 11 belongs to the component $\mathcal{H}^{even}(\underbrace{2, \dots, 2}_{g-1})$, where $g \geq 4$.*

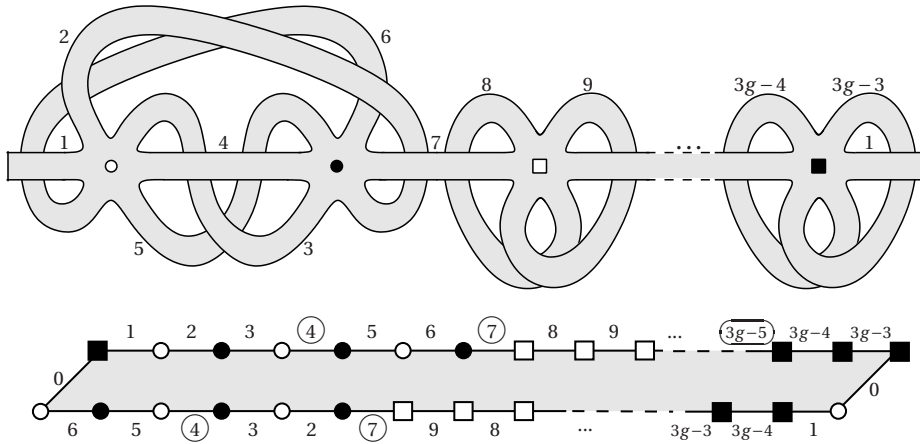

FIGURE 11. A Jenkins–Strebel differential with a single cylinder in the component $\mathcal{H}^{even}(2, \dots, 2)$ and its cylinder representation. The distinguished symbols $4, 7, \dots, 3g - 5$ enumerate the saddle connections chosen for contraction.

Proof. The proofs of Lemma 2 and of Proposition 4 are completely analogous to the ones of Lemma 1 and of Proposition 3 and we leave them to the reader as an exercise. \square

Remark. Note that by assumption we have $g \geq 4$, so Figure 11 contains at least one repetitive pattern as in Figure 10. Note that for $g = 2$ Figure 11 does not make sense. To define the Figure for $g = 3$ one has to consider it without repetitive patterns. By Proposition 5 the resulting Jenkins–Strebel differential belongs to $\mathcal{H}^{hyp}(2, 2)$. This is not a coincidence: any flat surface in $\mathcal{H}(2, 2)$ or in $\mathcal{H}(4)$

having even parity of the spin-structure necessarily belongs to the corresponding hyperelliptic component.

2.5. **Representatives of components** $\mathcal{H}^{hyp}(g-1, g-1)$ **and** $\mathcal{H}^{hyp}(2g-2)$.

PROPOSITION 5. *Let ω be an Abelian Jenkins–Strebel differential with a single cylinder. If it belongs to a hyperelliptic connected component, then a natural cyclic structure (1) on the set of horizontal saddle connections of ω has the following form:*

$$(9) \quad \begin{array}{cccccc} \curvearrowright & 1 & 2 & \dots & k-1 & k \\ \curvearrowright & k & k-1 & \dots & 2 & 1 \end{array}.$$

The Abelian differential ω belongs to $\mathcal{H}^{hyp}(2g-2)$ when $k = 2g - 1$ is odd and to $\mathcal{H}^{hyp}(g-1, g-1)$ when $k = 2g$ is even.

Proof. Deforming if necessary the lengths of the horizontal saddle connections (which does not change the connected component of ω) we may assume that they are all distinct (and strictly positive).

A hyperelliptic involution τ acts on any Abelian differential ω as $\tau^*\omega = -\omega$. Hence the induced isometry of the corresponding flat surface preserves the horizontal foliation and changes the orientation of the foliation. This implies that the isometry τ acts on the horizontal cylinder by an orientation-preserving involution interchanging the boundaries of the cylinder. Since zeroes are mapped to zeroes, horizontal saddle connections are isometrically mapped to horizontal saddle connections. Since their lengths are different, every saddle connection X_i is mapped to X_i for $i = 1, \dots, k$. This proves that the cyclic orders of the horizontal saddle connections on two components of the cylinder are inverse to each other, or, in other words, that the combinatorics of the cylinder representation of our Jenkins–Strebel differential are encoded by relation (9). A simple exercise shows that the corresponding flat surface belongs to $\mathcal{H}^{hyp}(2g-2)$ when $k = 2g - 1$ is odd and to $\mathcal{H}^{hyp}(g-1, g-1)$ when $k = 2g$ is even, and that in the latter case the symmetry of the cylinder (hyperelliptic involution) interchanges the two zeroes. \square

As a corollary we obtain the following proposition which was basically proved by W. A. Veech in [28] in slightly different terms.

PROPOSITION 6 (W. A. Veech). *The permutation*

$$\begin{pmatrix} 1 & 2 & \dots & 2g-1 & 2g \\ 2g & 2g-1 & \dots & 2 & 1 \end{pmatrix}$$

represents the component $\mathcal{H}^{hyp}(2g-2)$.

The permutation

$$\begin{pmatrix} 1 & 2 & \dots & 2g & 2g+1 \\ 2g+1 & 2g & \dots & 2 & 1 \end{pmatrix}$$

represents the component $\mathcal{H}^{hyp}(g-1, g-1)$.

Remark. The Rauzy class generated by the permutation

$$\begin{pmatrix} n & n-1 & \dots & 2 & 1 \\ 1 & 2 & \dots & n-1 & n \end{pmatrix}$$

was studied in the original paper [24] of Rauzy. In particular it was shown that its cardinality equals $2^{n-1} - 1$. Numerous results on hyperelliptic flat surfaces and on their polygonal representations were obtained in the paper of W. A. Veech [28].

3. REPRESENTATIVES OF STRATA OF QUADRATIC DIFFERENTIALS

In this section we consider meromorphic quadratic differentials with at most simple poles. The strata of quadratic differentials which are *not* global squares of Abelian differentials are denoted by $\mathcal{Q}(d_1, \dots, d_m, \underbrace{-1, \dots, -1}_p)$. By convention,

throughout Section 3 we will denote the degrees of the zeroes of a quadratic differential by d_k , *i.e.*, $d_k \geq 1$, $k = 1, \dots, m$. For brevity we shall often use the notation $\mathcal{Q}(d_1, \dots, d_m, -1^p)$ to indicate the number p of simple poles.

Empty strata. Any collection of zeroes of a meromorphic quadratic differential with $p \geq 0$ simple poles on a surface of genus $g \geq 0$ satisfies the relation

$$d_1 + \dots + d_m - p = 4g - 4.$$

In contrast with Abelian differentials where any collection of integer numbers satisfying an analogous relation defines a nonempty stratum, there are four exceptions for quadratic differentials. They are given by the following theorem, see [22].

THEOREM (H. Masur and J. Smillie). *Any collection d_1, \dots, d_m ; p of positive integers d_1, \dots, d_m and of a nonnegative integer p satisfying the relation*

$$d_1 + \dots + d_m - p = 4g - 4, \quad \text{with } g \geq 0$$

defines a nonempty stratum $\mathcal{Q}(d_1, \dots, d_m, -1^p)$ of meromorphic quadratic differentials with exception for the following four empty strata in genera one and two:

$$\mathcal{Q}(\emptyset), \quad \mathcal{Q}(1, -1), \quad \mathcal{Q}(3, 1), \quad \mathcal{Q}(4).$$

In particular, it follows from this theorem that any holomorphic quadratic differential without any zeroes on a surface of genus one, and any holomorphic quadratic differential with a single zero on a surface of genus two is a global square of a holomorphic 1-form.

Hyperelliptic connected components. Analogously to the case of Abelian differentials some strata of quadratic differentials contain *hyperelliptic* connected components. They are defined as families of quadratic differentials on hyperelliptic Riemann surfaces invariant under hyperelliptic involution, having specified collections of zeroes and poles and specified action of the involution on the set of zeroes and poles. They were described by E. Laneeau in [17].

THEOREM (E. Lanneau). *Hyperelliptic connected components of strata of meromorphic quadratic differentials with at most simple poles are described by the following list, where j, k are arbitrary nonnegative integer parameters.*

- Component $\mathcal{Q}^{hyp}(2j - 1, 2j - 1, 2k - 1, 2k - 1)$ of quadratic differentials on hyperelliptic Riemann surfaces, for which the quadratic differentials satisfy the additional requirement that the hyperelliptic involution interchanges the singularities corresponding to the pairs $2j - 1, 2j - 1$ and $2k - 1, 2k - 1$.
- Component $\mathcal{Q}^{hyp}(2j - 1, 2j - 1, 4k + 2)$ of quadratic differentials on hyperelliptic Riemann surfaces, for which the quadratic differentials satisfy the additional requirement that the hyperelliptic involution interchanges the singularities corresponding to the pair $2j - 1, 2j - 1$.
- Component $\mathcal{Q}^{hyp}(4j + 2, 4k + 2)$ of quadratic differentials on hyperelliptic Riemann surfaces. When $j = k$, quadratic differentials in this component satisfy the additional requirement that both zeroes are fixed points of the hyperelliptic involution.

3.1. Classification of connected components (after E. Lanneau). The classification of connected components for quadratic differentials was obtained by E. Lanneau in [18].

THEOREM (E. Lanneau). *All connected components of any stratum of meromorphic quadratic differentials with at most simple poles on a complex curve of genus $g \geq 3$ are described by the following list:*

Each of the four exceptional strata

$$\mathcal{Q}(9, -1), \mathcal{Q}(6, 3, -1), \mathcal{Q}(3, 3, 3, -1), \mathcal{Q}(12)$$

has exactly two connected components.

Each of the following strata

$$\begin{array}{ll} \mathcal{Q}(2j - 1, 2j - 1, 2k - 1, 2k - 1) & j \geq 0, k \geq 0, \quad j + k = g \\ \mathcal{Q}(2j - 1, 2j - 1, 4k + 2) & j \geq 0, k \geq 0, \quad j + k = g - 1 \\ \mathcal{Q}(4j + 2, 4k + 2) & j \geq 0, k \geq 0, \quad j + k = g - 2 \end{array}$$

has exactly two connected components, precisely one of which is hyperelliptic.

All other strata of meromorphic quadratic differentials with at most simple poles on complex curves of genera $g \geq 3$ are nonempty and connected.

Analogous to the case of Abelian differentials some components are missing in small genera.

THEOREM (M. Kontsevich; H. Masur and J. Smillie; E. Lanneau). *In genus 0 any stratum is nonempty and connected.*

In genus 1 strata $\mathcal{Q}(\emptyset)$ and $\mathcal{Q}(1, -1)$ are empty; all other strata are nonempty and connected.

In genus 2 strata $\mathcal{Q}(3, 1)$ and $\mathcal{Q}(4)$ are empty. Strata $\mathcal{Q}(6, -1^2)$ and $\mathcal{Q}(3, 3, -1^2)$ contain exactly two components, one component is hyperelliptic the other one is not. Any other stratum of meromorphic quadratic differentials with at most simple poles on a Riemann surface of genus 2 is nonempty and connected.

The part of the above theorem concerning genus 0 is due to M. Kontsevich, see [14]. The results concerning empty strata is due to H. Masur and J. Smillie, see [22]. The remaining part of the theorem is due to E. Lanneau, [18].

Remark. A simple invariant distinguishing components of the four exceptional strata

$$\mathcal{Q}(9, -1), \mathcal{Q}(6, 3, -1), \mathcal{Q}(3, 3, 3, -1), \mathcal{Q}(12)$$

has not been found yet. The fact that each of these strata contains exactly two connected components is proved by an explicit computation of corresponding extended Rauzy classes, see Section 3.8 where we also discuss some geometric properties distinguishing the corresponding pairs of connected components.

CONVENTION 2. Saying that a cylindrical generalized permutation π represents a stratum $\mathcal{Q}(d_1, \dots, d_m, -1^p)$ we always assume throughout this paper that the corresponding suspension as in Figure 4 has a singularity of degree d_1 at the left endpoint of X . We do not control anymore the degree at the right endpoint of X (as it was done for Abelian differentials).

3.2. Representatives of strata in genus 0. Let d_1, \dots, d_m be an arbitrary (possibly empty) collection of strictly positive integers, and let $p = d_1 + \dots + d_m + 4$.

PROPOSITION 7. A generalized permutation obtained by erasing symbols

$$\underbrace{3, 5, \dots, 2d_1 - 1}_{d_1 - 1}, \underbrace{2d_1 + 3, \dots, 2(d_1 + d_2) - 1}_{d_2 - 1}, \dots, \dots, \dots, \underbrace{2(d_1 + \dots + d_{m-1}) + 3, \dots, 2(d_1 + \dots + d_m) - 1}_{d_m - 1}$$

in the generalized permutation

$$\left(\begin{array}{ccccccc} & & & & 0, 2p - 6, 2p - 6 & & \\ 2, 2, 3, & 4, 4, 5, & \dots, & 2p - 8, 2p - 8, 2p - 7, & 2p - 7, 2p - 9, \dots, & 3, 1, & 1, 0 \end{array} \right)$$

represents the stratum $\mathcal{Q}(d_1, \dots, d_m, -1^p)$.

For an empty collection $\{d_1, \dots, d_m\} = \emptyset$ one has $p = 4$ and the permutation above should be read as

$$\begin{pmatrix} 0, 2, 2 \\ 1, 1, 0 \end{pmatrix}.$$

Proof. The proof is left to the reader as an exercise. □

3.3. Representatives of strata in genus 1.

PROPOSITION 8. Let d_1, \dots, d_m be a collection of strictly positive integers, such that $d_1 + \dots + d_m = p \geq 2$. A generalized permutation obtained by erasing symbols

$$\underbrace{2, 4, \dots, 2(d_1 - 1)}_{d_1 - 1}, \underbrace{2(d_1 + 1), \dots, 2(d_1 + d_2 - 1)}_{d_2 - 1}, \dots, \dots, \dots, \underbrace{2(d_1 + \dots + d_{m-1} + 1), \dots, 2(d_1 + \dots + d_m - 1)}_{d_m - 1}$$

in the generalized permutation

$$\begin{pmatrix} 0, 1, & 2, 3, 3, & 4, 5, 5, & \dots, & 2p-2, 2p-1, 2p-1 \\ & 2, 4, \dots, 2p-2, & 1, 2p, 2p, & 0 \end{pmatrix}$$

represents the stratum $\mathcal{Q}(d_1, \dots, d_m, -1^p)$.

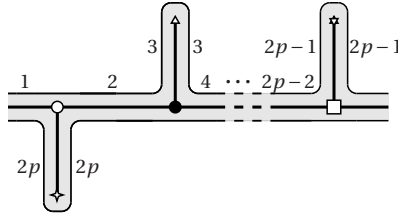

FIGURE 12. A Jenkins–Strebel differential with a single cylinder in the stratum $\mathcal{Q}(1^p, -1^p)$, $p \geq 2$, in genus 1

Proof. Note that by the theorem of H. Masur and J. Smillie cited in the beginning of Section 3 the strata $\mathcal{Q}(\emptyset)$ and $\mathcal{Q}(1, -1)$ are empty. Thus, a meromorphic quadratic differential with simple poles in genus $g = 1$ has at least $p = 2$ poles. This implies that the relation

$$|X_3| + \dots + |X_{2p-1}| = |X_{2p}|$$

for the lengths of horizontal saddle connections of a Jenkins–Strebel differential such as in Figure 12 always has a strictly positive solution. The resulting quadratic differential belongs to the stratum $\mathcal{Q}(1^p, -1^p)$.

Note that none of the distinguished saddle connections $X_2, X_4, \dots, X_{2p-2}$ is involved in the relation above. It means that contracting any subcollection of these distinguished saddle connections does not affect the lengths of any other saddle connection.

It remains to note that an embedded chain of $p - 1$ distinguished saddle connections

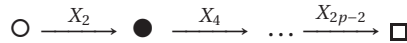

joins all p zeroes of our quadratic differential. □

3.4. Representatives of connected strata in genus 2.

PROPOSITION 9. *The generalized permutation*

$$\begin{pmatrix} 0, 6, 1, 5, 6, 4, 3 \\ 1, 2, 3, 4, 2, 5, 0 \end{pmatrix}$$

represents the stratum $\mathcal{Q}(1, 1, 1, 1)$. The generalized permutations obtained from this one by erasing symbols $\{1\}$ and $\{1, 3\}$ represent the strata $\mathcal{Q}(2, 1, 1)$ and $\mathcal{Q}(2, 2, 2)$, respectively.

Let d_1, \dots, d_m, p be a collection of strictly positive integers satisfying the relation $d_1 + \dots + d_m = p + 4$. A generalized permutation obtained by erasing symbols

$$\underbrace{1, 2, \dots, d_1 - 1}_{d_1 - 1}, \underbrace{d_1 + 1, \dots, d_1 + d_2 - 1}_{d_2 - 1}, \underbrace{\dots}_{\dots},$$

$$\underbrace{\dots}_{\dots}, \underbrace{d_1 + \dots + d_{m-1} + 1, \dots, d_1 + \dots + d_m - 1}_{d_m - 1}$$

in the generalized permutation

$$\left(\begin{array}{c} 0, 2p+6, 1, 2p+5, 2p+6, p+4, p+3 \\ 1, \dots, p+4, p+2, p+5, p+5, p+1, p+6, p+6, \dots, 3, 2p+4, 2p+4, 2, 2p+5, 0 \end{array} \right)$$

represents the stratum $\mathcal{Q}(d_1, \dots, d_m, -1^p)$.

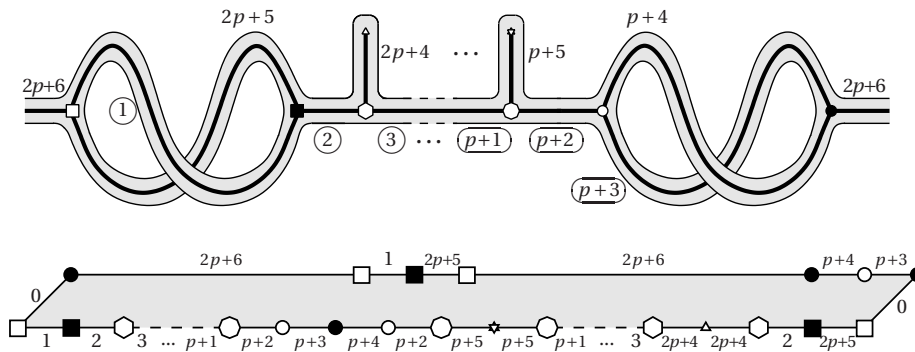

FIGURE 13. A Jenkins–Strebel differential with a single cylinder in the stratum $\mathcal{Q}(1^{p+4}, -1^p)$, $p \geq 0$, and its cylinder representation. Distinguished symbols $1, \dots, p + 3$ enumerate saddle connections chosen for contraction.

Proof. It follows from Figure 13 that the generalized permutation

$$\left(\begin{array}{c} 0, 6, 1, 5, 6, 4, 3 \\ 1, 2, 3, 4, 2, 5, 0 \end{array} \right)$$

represents the stratum $\mathcal{Q}(1, 1, 1, 1)$. The basic relation (4) between the lengths of horizontal saddle connections has the form $|X_6| = |X_2|$. Thus, we may contract any of X_1, X_3 or both of them without changing the lengths of other saddle connections. From Figure 13 we conclude that in this way we get generalized permutations representing strata $\mathcal{Q}(2, 1, 1)$ and $\mathcal{Q}(2, 2)$ correspondingly. Note that by the theorem of H. Masur and J. Smillie strata $\mathcal{Q}(3, 1)$ and $\mathcal{Q}(4)$ are empty. Hence we have represented all strata of holomorphic quadratic differentials in genus $g = 2$.

Consider now a Jenkins–Strebel quadratic differential with a single cylinder as in Figure 13 having at least one simple pole. Relation (4) between the lengths of horizontal saddle connections now has the form

$$|X_{2p+6}| = (|X_2| + |X_3| + \cdots + |X_{p+2}|) + (|X_{p+5}| + \cdots + |X_{2p+4}|)$$

and always admits strictly positive solutions. It is clear from Figure 13 that the corresponding Jenkins–Strebel quadratic differential has a single cylinder and belongs to the stratum $\mathcal{Q}(1^{p+4}, -1^p)$. It remains to note that the $p + 3$ saddle connections X_1, \dots, X_{p+3} join all $p + 4$ simple zeroes and that contracting any subcollection of these distinguished saddle connections yields a relation which still admits a strictly positive solution for the lengths of remaining ones. \square

3.5. Representatives of connected strata in genus $g \geq 3$. Let d_1, \dots, d_m be a collection of strictly positive integers, p a nonnegative integer, and let $g \geq 3$ be an integer. Assume that these integer data satisfy the relation $d_1 + \cdots + d_m - p = 4g - 4$.

Consider a generalized permutation represented by the following two strings of symbols (see also Figure 14). The top string has the form

$$\pi^{top} = (0, 1, 2, 3, V(0), \dots, V(g - 3), W(0), \dots, W(p - 1), 4g + p - 4).$$

Here the word $V(k)$ is composed of the following six symbols:

$$V(k) = 4 + 4k, 4g - 1 + p + 2k, 7 + 4k, 4g + p + 2k, 6 + 4k, 4g - 1 + p + 2k, 5 + 4k, 4g + p + 2k$$

and the word $W(l)$ is composed of the following three symbols:

$$W(l) = 4g - 4 + l, 6g + p - 5 + l, 6g + p - 5 + l.$$

By convention, when $p = 0$ the words $W(0), \dots, W(p - 1)$ are omitted in π^{top} .

The bottom string has the form

$$\pi^{bot} = (4g - 3 + p, 3, 4g - 2 + p, 2, 4g - 3 + p, 1, 4g - 2 + p, 4, 5, \dots, 4g - 4 + p, 0)$$

PROPOSITION 10. *For any genus $g \geq 3$, and any collection of integers d_1, \dots, d_m , p as above the generalized permutation obtained by erasing symbols*

$$\underbrace{1, 2, \dots, d_1 - 1}_{d_1 - 1}, \underbrace{d_1 + 1, \dots, d_1 + d_2 - 1}_{d_2 - 1}, \underbrace{\dots}_{\dots}, \underbrace{\dots}_{\dots}, \underbrace{d_1 + \cdots + d_{m-1} + 1, \dots, d_1 + \cdots + d_m - 1}_{d_m - 1}$$

in the generalized permutation $\left(\frac{\pi^{top}}{\pi^{bot}}\right)$ represents the stratum $\mathcal{Q}(d_1, \dots, d_m, -1^p)$.

Proof. Consider a Jenkins–Strebel quadratic differential with a single cylinder as in Figure 14. Relation (4) between the lengths of the horizontal saddle connections has the form

$$|X_{4g-3+p}| + |X_{4g-2+p}| = \left((|X_{4g-1+p}| + |X_{4g+p}|) + \cdots + (|X_{6g-7+p}| + |X_{6g-6+p}|) \right) + (|X_{6g+p-5}| + \cdots + |X_{6g+2p-6}|)$$

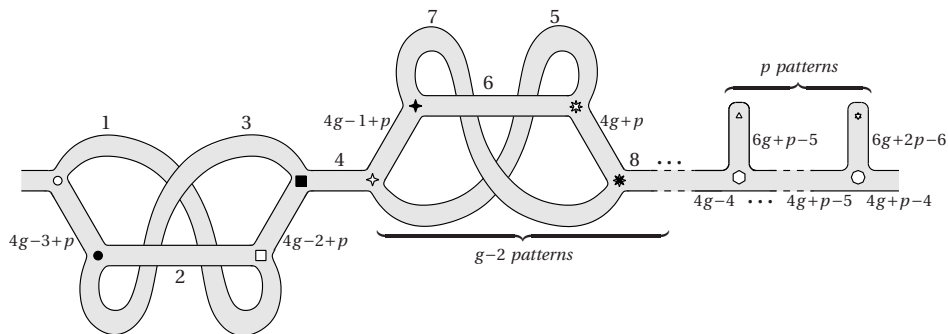

FIGURE 14. A Jenkins–Strebel differential with a single cylinder in the stratum $\mathcal{Q}(1^{4g+p-4}, -1^p)$, $p \geq 0$, in genus $g \geq 3$

Note that by convention the genus g is at least 3. Thus, even for $p = 0$, when the second sum in the right part of the equation is missing, the equation admits strictly positive solutions.

It is clear from Figure 14 that the corresponding Jenkins–Strebel quadratic differential has a single cylinder and belongs to the stratum $\mathcal{Q}(1^{4g+p-4}, -1^p)$. It remains to note that the $4g - 5 + p$ saddle connections X_1, \dots, X_{4g-5+p} join all $4g - 4 + p$ simple zeroes and that none of these saddle connections is involved in the relation. This implies that we can contract any subcollection of these distinguished saddle connections without affecting the remaining ones. \square

3.6. Representatives of hyperelliptic components. Representatives of hyperelliptic connected components of the strata of quadratic differentials were constructed by E. Lanneau in [18], Section 4.1. In the theorem below we slightly modify the original notations.

THEOREM (E. Lanneau). *For any pair of nonnegative integer parameters r, s the generalized permutation*

$$\begin{pmatrix} 0, A, 1, 2, \dots, s, A, s+1, s+2, \dots, s+r \\ s+r, \dots, s+2, s+1, B, s, \dots, 2, 1, B, 0 \end{pmatrix}$$

represents a Jenkins–Strebel quadratic differential with a single cylinder in a hyperelliptic connected component. The table below specifies the corresponding stratum.

Here “ A, B ” are just symbols of our alphabet. By convention when $r = 0$ (or when $s = 0$) the sequences $1, 2, \dots, r$ (correspondingly $r + 1, r + 2, \dots, r + s$) are empty.

r	s	Embodying stratum
$2j + 1$	$2k + 1$	$Q(4j + 2, 4k + 2)$
$2j$	$2k + 1$	$Q(2j - 1, 2j - 1, 4k + 2)$
$2j + 1$	$2k$	$Q(4j + 2, 2k - 1, 2k - 1)$
$2j$	$2k$	$Q(2j - 1, 2j - 1, 2k - 1, 2k - 1)$

We complete this section with a criterion of E. Lanneau [18] characterizing all cylindrical generalized permutations representing hyperelliptic connected components. This result will be used in the next section; it is analogous to Proposition 6 in Section 2.5.

PROPOSITION 11 (E. Lanneau). *Let q be a Jenkins–Strebel quadratic differential with a single cylinder. Suppose that it is not a global square of an Abelian differential. If it belongs to one of hyperelliptic connected components, then a natural cyclic structure (1) on the set of horizontal saddle connections of q has one of the following two forms: either it has the form*

$$(10) \quad \begin{array}{c} \overbrace{A \rightarrow 1 \rightarrow 2 \rightarrow \dots \rightarrow s \rightarrow A \rightarrow s + 1 \rightarrow \dots \rightarrow s + r} \\ \underbrace{s + r \rightarrow \dots \rightarrow s + 1 \rightarrow B \rightarrow s \rightarrow \dots \rightarrow 2 \rightarrow 1 \rightarrow B} \end{array}$$

as in the theorem above, or it has the form

$$(11) \quad \begin{array}{c} \overbrace{1 \rightarrow 2 \rightarrow \dots \rightarrow r + 1 \rightarrow 1 \rightarrow 2 \rightarrow \dots \rightarrow r + 1} \\ \underbrace{r + 2 \rightarrow r + 3 \rightarrow \dots \rightarrow r + s + 2 \rightarrow r + 2 \rightarrow r + 3 \rightarrow \dots \rightarrow r + s + 2} \end{array}$$

and the corresponding stratum is specified by the table above. (As before, “ A ” and “ B ” are symbols of the alphabet.)

3.7. Representatives of nonhyperelliptic components. We need to construct representatives of nonhyperelliptic components of the strata where such a component exists. Note that such components appear only in genus 2 and higher. We can apply Propositions 9 and 10 to obtain a representative of any stratum in genus 2 and higher, in particular of the stratum which contains a nonhyperelliptic component. It remains to prove that our candidate does not get to the hyperelliptic component of this stratum.

PROPOSITION 12. *For any nonconnected stratum of quadratic differentials containing a hyperelliptic component, the complementary nonhyperelliptic component can be represented by a Jenkins–Strebel differential with a single cylinder as in Propositions 9 and 10.*

Proof. By Theorems of M. Kontsevich and E. Lanneau stated in Section 3.1 any stratum in genera 0 and 1 is connected.

There are two disconnected strata $\mathcal{Q}(3, 3, -1^2)$ and $\mathcal{Q}(6, -1^2)$ in genus $g = 2$. The construction from Proposition 9 produces the following generalized permutations (and Jenkins–Strebel differentials with a single cylinder) representing these strata correspondingly:

$$\begin{pmatrix} 0, 10, 9, 10, 6 \\ 3, 6, 7, 7, 3, 8, 8, 9, 0 \end{pmatrix} \quad \text{and} \quad \begin{pmatrix} 0, 10, 9, 10, 6 \\ 6, 7, 7, 8, 8, 9, 0 \end{pmatrix}.$$

By Proposition 11 from the previous section the corresponding Jenkins–Strebel differentials belong to nonhyperelliptic components.

In genus $g \geq 3$ any stratum containing a hyperelliptic component also contains a nonhyperelliptic one. Consider such a stratum. We can reach it by applying the construction suggested by Proposition 10. Recall that relation (4) between the lengths of horizontal saddle connections has the form

$$\begin{aligned} |X_{4g-3+p}| + |X_{4g-2+p}| = & \left(|X_{4g-1+p}| + |X_{4g+p}| \right) + \cdots + \left(|X_{6g-7+p}| + |X_{6g-6+p}| \right) + \\ & + \left(|X_{6g+p-5}| + \cdots + |X_{6g+2p-6}| \right) \end{aligned}$$

Thus, Proposition 11 implies that our Jenkins–Strebel differential belongs to a nonhyperelliptic component. \square

3.8. Representatives of connected components of the four exceptional strata $\mathcal{Q}(9, -1)$, $\mathcal{Q}(6, 3, -1)$, $\mathcal{Q}(3, 3, 3, -1)$, $\mathcal{Q}(12)$.

PROPOSITION 13. *Each of the strata $\mathcal{Q}(9, -1)$, $\mathcal{Q}(6, 3, -1)$, $\mathcal{Q}(3, 3, 3, -1)$, and $\mathcal{Q}(12)$ contains exactly two connected components.*

Cylindrical generalized permutations representing these components and cardinalities of the corresponding extended Rauzy classes are given in Table 1.

Proof. This proposition can be obtained by a naive direct computation, which allows one to find all connected components of low-dimensional strata.

One can construct the sets of all irreducible generalized permutations (see [6] for a combinatorial definition) of up to 9 elements. These permutations can be sorted by which strata they represent. Having a set of irreducible permutations one can apply the combinatorial construction of the extended Rauzy class (see [6] and appendix B) to decompose this set into a disjoint union of extended Rauzy classes. This direct calculation shows that each of the four exceptional strata $\mathcal{Q}(9, -1)$, $\mathcal{Q}(6, 3, -1)$, $\mathcal{Q}(3, 3, 3, -1)$, and $\mathcal{Q}(12)$ has exactly two distinct connected components. \square

Remark. Actually, the initial computations were performed differently. Instead of working with extended Rauzy classes, which are really huge, it is more advantageous to find generalized permutations of some particular form, which are still present in every extended Rauzy class (say, those ones, for which both lines have the same length, see Lemma 5 in Appendix B). To prove that a stratum is connected it is sufficient to find all generalized permutations of this particular form

Genus $g = 3$

Component of a stratum	Cardinality of extended Rauzy class	Representative of extended Rauzy class
$Q^{irr}(3,3,3,-1)$	88374	$\begin{pmatrix} 0, 1, 2, 3, 4, 5, 1, 6, 2, 3, 4, 5, 6, 7 \\ 7, 8, 8, 0 \end{pmatrix}$
$Q^{irr}(6,3,-1)$	72172	$\begin{pmatrix} 0, 1, 2, 3, 4, 5, 1, 2, 3, 4, 5, 6 \\ 6, 7, 7, 0 \end{pmatrix}$
$Q^{irr}(9,-1)$	12366	$\begin{pmatrix} 0, 1, 2, 3, 4, 1, 2, 3, 4, 5 \\ 5, 6, 6, 0 \end{pmatrix}$
$Q^{reg}(3,3,3,-1)$	612838	$\begin{pmatrix} 0, 1, 2, 3, 4, 2, 3, 5, 5, 6 \\ 7, 1, 8, 7, 8, 4, 6, 0 \end{pmatrix}$
$Q^{reg}(6,3,-1)$	531674	$\begin{pmatrix} 0, 1, 2, 3, 1, 2, 4, 4, 5 \\ 6, 7, 6, 7, 3, 5, 0 \end{pmatrix}$
$Q^{reg}(9,-1)$	95944	$\begin{pmatrix} 0, 1, 2, 1, 2, 3, 3, 4 \\ 5, 6, 5, 6, 4, 0 \end{pmatrix}$

Genus $g = 4$

$Q^{irr}(12)$	146049	$\begin{pmatrix} 0, 1, 2, 3, 4, 5, 6, 5 \\ 7, 6, 4, 7, 3, 2, 1, 0 \end{pmatrix}$
$Q^{reg}(12)$	881599	$\begin{pmatrix} 0, 1, 2, 1, 2, 3, 4, 3, 4, 5 \\ 5, 6, 7, 6, 7, 0 \end{pmatrix}$

TABLE 1. Representatives of all connected components of the four exceptional strata $Q(9, -1)$, $Q(6, 3, -1)$, $Q(3, 3, 3, -1)$, $Q(12)$

corresponding to the given stratum, and then verify that all these generalized permutations are connected by some chains of operations a, b, c .

APPENDIX A. ADJACENCY OF SPECIAL STRATA

Currently there are no known simple invariants distinguishing pairs of connected components of the four exceptional strata. Of course having a flat surface in one of these strata one can consider an appropriate segment, consider the “first-return map” defined by a foliation in a transverse direction, figure out the resulting generalized permutation and then use a computer to check to which

of the two corresponding extended Rauzy classes it belongs. However, this approach is not very exciting.

A much more geometric approach uses *configurations of homologous saddle connections* (see [23] for a definition and for a geometric description). Some configurations are specific for flat surfaces in specific connected components. The classification of configurations of homologous saddle connections admissible for each individual connected component of the four exceptional strata is research in progress by E. Lanneau and C. Boissy.

We formulate here just one result to give a flavor of this approach. Basically, it says that for a quadratic differential in, say, $\mathcal{Q}^{reg}(9, -1)$ one can merge the simple pole and the zero and obtain a nondegenerate flat surface in $\mathcal{Q}(8)$, while merging the simple pole with the zero for a quadratic differential in $\mathcal{Q}^{irr}(9, -1)$ we necessarily degenerate the Riemann surface. This statement was conjectured by the author and proved by E. Lanneau in [18].

THEOREM (E. Lanneau). *Almost every quadratic differential in each component $\mathcal{Q}^{reg}(3, 3, 3, -1)$, $\mathcal{Q}^{reg}(6, 3, -1)$, $\mathcal{Q}^{reg}(9, -1)$ has infinitely many saddle connections of multiplicity one joining the simple pole with one of the zeroes.*

No quadratic differential in $\mathcal{Q}^{irr}(3, 3, 3, -1)$, $\mathcal{Q}^{irr}(6, 3, -1)$, $\mathcal{Q}^{irr}(9, -1)$ admits a saddle connection of multiplicity one joining the simple pole with one of the zeroes.

To prove the second part of the Theorem E. Lanneau suggests the following argument. The stratum $\mathcal{Q}(8)$ is connected. Hence, following [16] and applying classical deformation theory one concludes that any stratum $\mathcal{Q}(d_1, \dots, d_m, -1^p)$ in genus three has a unique connected component adjacent to the minimal stratum $\mathcal{Q}(8)$. By Proposition 13 each exceptional stratum $\mathcal{Q}(3, 3, 3, -1)$, $\mathcal{Q}(6, 3, -1)$, $\mathcal{Q}(9, -1)$ contains two connected components. Hence, one of the components in each pair is not adjacent to $\mathcal{Q}(8)$. We shall see that that these components are $\mathcal{Q}^{irr}(3, 3, 3, -1)$, $\mathcal{Q}^{irr}(6, 3, -1)$, $\mathcal{Q}^{irr}(9, -1)$ respectively.

To prove the remaining part of the theorem it is basically sufficient to present at least one surface with at least one saddle connection of multiplicity one. This is done using appropriate horizontal saddle connections for explicit examples of Jenkins–Strebel differentials with a single cylinder.

In the remaining part of this section we illustrate the technique of [16] and of [18] which uses Jenkins–Strebel differentials with a single cylinder to study adjacency of the strata. Following Lanneau [18] we describe adjacency of three regular and of three irregular components in genus 3.

Regular components. Our representatives of three “regular” connected components $\mathcal{Q}^{reg}(3, 3, 3, -1)$, $\mathcal{Q}^{reg}(6, 3, -1)$, $\mathcal{Q}^{reg}(9, -1)$ in genus three are obtained from the canonical generalized permutation representing one-cylinder Jenkins–Strebel differentials in $\mathcal{Q}(1^9, -1)$ by the construction described in Proposition 10. We present the corresponding generalized permutations in Table 2; we do not reenumerate the symbols to make modifications more traceable.

By construction, the associated Jenkins–Strebel differential in $\mathcal{Q}^{reg}(9, -1)$ can be obtained from the one in $\mathcal{Q}^{reg}(6, 3, -1)$ by contraction of the horizontal saddle connection X_6 , which results in merging the zeroes of degrees 6 and 3 into a single zero of degree 9. Similarly the Jenkins–Strebel differential in $\mathcal{Q}^{reg}(6, 3, -1)$ can be obtained from the one in $\mathcal{Q}^{reg}(3, 3, 3, -1)$ by contraction of the horizontal saddle connection X_3 , which results in merging a pair of zeroes of degree 3 into a single zero of degree 6. Thus, $\mathcal{Q}^{reg}(3, 3, 3, -1)$ is adjacent to $\mathcal{Q}^{reg}(6, 3, -1)$ which is in turn adjacent to $\mathcal{Q}^{reg}(9, -1)$.

$\mathcal{Q}(1^9, -1)$	$\begin{pmatrix} 0, \textcircled{1}, \textcircled{2}, 3, \textcircled{4}, 12, \textcircled{7}, 13, 6, 12, \textcircled{5}, 13, \textcircled{8}, 14, 14, & 9 \\ 10, 3, 11, \textcircled{2}, 10, \textcircled{1}, 11, \textcircled{4}, \textcircled{5}, 6, \textcircled{7}, \textcircled{8}, 9, & 0 \end{pmatrix}$
$\mathcal{Q}^{reg}(3, 3, 3, -1)$	$\begin{pmatrix} 0, \textcircled{3}, 12, 13, 6, 12, 13, 14, 14, & 9 \\ 10, \textcircled{3}, 11, 10, 11, 6, 9, & 0 \end{pmatrix}$
$\mathcal{Q}^{reg}(6, 3, -1)$	$\begin{pmatrix} 0, 12, 13, \textcircled{6}, 12, 13, 14, 14, & 9 \\ 10, 11, 10, 11, \textcircled{6}, 9, & 0 \end{pmatrix}$
$\mathcal{Q}^{reg}(9, -1)$	$\begin{pmatrix} 0, 12, 13, 12, 13, 14, 14, & 9 \\ 10, 11, 10, 11, 9, & 0 \end{pmatrix}$

TABLE 2. Adjacency of regular components of exceptional strata in genus 3.

Note that the basic relation (4) is the same for all cylindrical generalized permutations in Table 2. It has the following form:

$$|X_{10}| + |X_{11}| = |X_{12}| + |X_{13}| + |X_{14}|.$$

Thus, we can continuously contract the saddle connection X_{14} compensating this by increasing $|X_{13}|$ or $|X_{12}|$ or both; such deformation respects the relation above. Combinatorially this results in erasing the symbol “14” in the corresponding permutations, see Table 3.

Geometrically this means that the saddle connection X_{14} joining the simple pole to a corresponding zero has multiplicity one. Merging the simple pole with the corresponding zero we get nondegenerate Jenkins–Strebel differentials in the strata $\mathcal{Q}(3, 3, 2)$, $\mathcal{Q}(6, 2)$, $\mathcal{Q}(8)$ respectively. In our ribbon graph representation of Jenkins–Strebel differentials as in Figure 14 we continuously contract the appendix with a single simple pole compensating the missing length on the complementary component by making the saddle connection X_{13} longer. These considerations show, in particular, that regular connected components are adjacent to the minimal stratum $\mathcal{Q}(8)$, and hence, irregular components are not.

Irregular (irreducible) components. The connected component $\mathcal{Q}^{irr}(9, -1)$ is adjacent to $\mathcal{Q}^{irr}(6, 3, -1)$ which is in turn adjacent to $\mathcal{Q}^{irr}(3, 3, 3, -1)$. To verify

$\mathcal{Q}(3,3,2)$	$\begin{pmatrix} 0, 3, 12, 13, 6, 12, 13, 9 \\ 10, 3, 11, 10, 11, 6, 9, 0 \end{pmatrix}$
$\mathcal{Q}(6,2)$	$\begin{pmatrix} 0, 12, 13, 6, 12, 13, 9 \\ 10, 11, 10, 11, 6, 9, 0 \end{pmatrix}$
$\mathcal{Q}(8)$	$\begin{pmatrix} 0, 12, 13, 12, 13, 9 \\ 10, 11, 10, 11, 9, 0 \end{pmatrix}$

TABLE 3. Merging simple pole to a zero for regular components of exceptional strata in genus 3

this, it is sufficient to note that the generalized permutation representing the component $\mathcal{Q}^{irr}(6,3,-1)$ in Table 1 can be obtained from the one representing $\mathcal{Q}^{irr}(3,3,3,-1)$ by erasing the symbol “6” followed by reenumeration. Note that the saddle connection X_6 is not involved in the corresponding relation between lengths of horizontal saddle connections. Similarly the generalized permutation representing $\mathcal{Q}^{irr}(9,-1)$ in our table can be obtained from the one representing $\mathcal{Q}^{irr}(6,3,-1)$ by erasing the symbol “5” followed by reenumeration. The saddle connection X_5 is not involved in the corresponding relation between lengths of horizontal saddle connections.

APPENDIX B. RAUZY OPERATIONS FOR GENERALIZED PERMUTATIONS

The Rauzy operations a and b on permutations were introduced by G. Rauzy in [24]. The related dynamical system (a discrete analog of the Teichmüller geodesic flow) was extensively studied in the breakthrough paper [25] of W. A. Veech. This technique was developed and applied in [3, 4, 5, 7, 19, 32], and in other papers; see also surveys [29, 30, 31, 33].

In this section we extend the combinatorial definitions of Rauzy operations a and b to generalized permutations; see paper [6] of C. Boissy and E. Lanneau for a comprehensive study of the geometry, dynamics and combinatorics of generalized permutations and of Rauzy–Veech induction on generalized permutations.

Rauzy operations. Operations are not defined for a generalized permutation π when the rightmost entries of both lines of π are represented by the same symbol.

Rauzy operation a acts as follows. Denote by “0” the symbol representing the rightmost entry in the top line. Recall that every symbol appears in a generalized permutation exactly twice. To distinguish two appearances of the symbol “0” we denote by 0_1 the rightmost entry in the top line and by 0_2 its twin.

If 0_2 belongs to the bottom line, we erase the rightmost entry β_s of the bottom line and insert β_s to the right of 0_2 , as in the example below:

$$\left(\begin{array}{c} \alpha_1, \dots, \alpha_r, 0_1 \\ \beta_1, \dots, \beta_{k-1}, 0_2, \beta_k, \dots, \beta_{s-1}, \beta_s \end{array} \right) \xrightarrow{a} \left(\begin{array}{c} \alpha_1, \dots, \alpha_r, 0_1 \\ \beta_1, \dots, \beta_{k-1}, 0_2, \beta_s, \beta_k, \dots, \beta_{s-1} \end{array} \right)$$

If 0_2 belongs to the same line as 0_1 (i.e., to the top one), we have to apply an additional test. If the rightmost symbol β_s in the bottom line appears in this line twice and all other symbols of the bottom line appear in this line only once, the corresponding operation is not defined. Otherwise, we remove the rightmost symbol β_s in the bottom line and insert it to the left of 0_2 . Thus, β_s moves to the top line, as in the example below:

$$\left(\begin{array}{c} \dots, \alpha_k, 0_2, \alpha_{k+1}, \dots, \alpha_r, 0_1 \\ \beta_1, \dots, \beta_{s-1}, \beta_s \end{array} \right) \xrightarrow{a} \left(\begin{array}{c} \dots, \alpha_k, \beta_s, 0_2, \alpha_{k+1}, \dots, \alpha_r, 0_1 \\ \beta_1, \dots, \beta_{s-1} \end{array} \right)$$

Operation b is defined in complete analogy with operation a by interchanging the words “top” and “bottom” in the definition. Namely, it acts as:

$$\left(\begin{array}{c} \beta_1, \dots, \beta_{k-1}, 0_2, \beta_k, \dots, \beta_{s-1}, \beta_s \\ \alpha_1, \dots, \alpha_r, 0_1 \end{array} \right) \xrightarrow{b} \left(\begin{array}{c} \beta_1, \dots, \beta_{k-1}, 0_2, \beta_s, \beta_k, \dots, \beta_{s-1} \\ \alpha_1, \dots, \alpha_r, 0_1 \end{array} \right)$$

when 0_1 and 0_2 are in different lines, and it acts as:

$$\left(\begin{array}{c} \beta_1, \dots, \beta_{s-1}, \beta_s \\ \dots, \alpha_k, 0_2, \alpha_{k+1}, \dots, \alpha_r, 0_1 \end{array} \right) \xrightarrow{b} \left(\begin{array}{c} \beta_1, \dots, \beta_{s-1} \\ \dots, \alpha_k, \beta_s, 0_2, \alpha_{k+1}, \dots, \alpha_r, 0_1 \end{array} \right)$$

when they are both in the bottom line. In the second case the operation b is not defined when the rightmost symbol β_s in the top line appears in the top line twice and all other symbols of the top line appear in this line only once.

In addition to Rauzy operations a, b we define one more operation denoted by c . It reverses the elements in each line and then interchanges the lines:

$$\left(\begin{array}{c} \alpha_1, \alpha_2, \dots, \alpha_p \\ \beta_1, \beta_2, \dots, \beta_q \end{array} \right) \xrightarrow{c} \left(\begin{array}{c} \beta_p, \dots, \beta_2, \beta_1 \\ \alpha_p, \dots, \alpha_2, \alpha_1 \end{array} \right)$$

Rauzy operations have the following geometric interpretation. Consider a closed flat surface S represented by a meromorphic quadratic differential with at most simple poles. Consider a horizontal segment X , the “first-return map” of the vertical foliation to X in the sense of Section 1.3, and the corresponding generalized permutation π . Compare the lengths of the rightmost intervals in the top and in the bottom lines and denote the longer of two intervals by X_0 and the shorter one by X_{β_s} . Consider now a horizontal segment $X' \subset X$ obtained by shortening X on the right by chopping out of X a piece of length $|X_{\beta_s}|$. A generalized interval exchanged map induced by the vertical foliation on X' will be associated to a permutation $a(\pi)$ or $b(\pi)$ depending whether X_0 was in the top or in the bottom line.

Recall that the notion of “top” or “bottom” shores of a slit along X is a matter of convention: it depends on a choice of orientation of X which is not canonical for quadratic differentials. Choosing the opposite orientation of X we get a generalized interval-exchange transformation with generalized permutation $c(\pi)$.

Rauzy classes and extended Rauzy classes.

DEFINITION. A generalized permutation is called *irreducible* if it can be realized by a generalized interval-exchange transformation T satisfying the following conditions:

1. there exists a Riemann surface S and a meromorphic quadratic differential q with at most simple poles on it, such that the vertical foliation of q is minimal;
2. there exists an oriented horizontal segment X adjacent at its left endpoint to a singularity of q such that the first-return map of the vertical foliation to X induces the generalized interval-exchange transformation T .

This natural definition is however extremely inefficient. A purely combinatorial criterion for irreducibility of a generalized permutation was not known for quite a long time; it was recently elaborated by C. Boissy and E. Lanneau in [6].

It follows from the definition above that if π is irreducible, $a(\pi)$ and $b(\pi)$ are also irreducible (when the corresponding operation is applicable).

DEFINITION. A *Rauzy class* $\mathfrak{R}(\pi)$ of an irreducible generalized permutation π is a minimal set containing π and invariant under the Rauzy operations a, b .

Here invariance under operations a, b is understood in the sense “when applicable”: a Rauzy class may contain a generalized permutation for which one of the two operations is not applicable.

Up to this point there is not so much difference between combinatorial definitions of Rauzy operations and Rauzy classes of “true” permutations and “generalized” permutations (with the exception of the fact that for some generalized permutations one of the Rauzy operations might be not defined). There is, however, a radical difference with operation c . Namely, C. Boissy and E. Lanneau have observed that for an irreducible generalized permutation π the image $c(\pi)$ is not necessarily irreducible, while for true permutations the operation c preserves this property. Thus, in their definition of extended Rauzy classes C. Boissy and E. Lanneau make the corresponding correction (compared to “true” permutations):

DEFINITION (C. Boissy and E. Lanneau). An *extended Rauzy class* $\mathfrak{R}_{ex}(\pi)$ of an irreducible generalized permutation π is the intersection of a minimal set containing π and invariant under operations a, b, c with the set of irreducible generalized permutations.

Conjecturally an extended Rauzy class can be defined in the following alternative way. Let us modify the definition of the operation c by saying that $c(\pi)$ is not defined when $c(\pi)$ is not irreducible. Having an irreducible permutation π we

define a minimal set $\mathfrak{R}'_{ex}(\pi)$ containing π invariant under Rauzy operations a, b, c (where for some generalized permutations in $\mathfrak{R}'_{ex}(\pi)$ some operations might not be applicable).

CONJECTURE 1. *The sets $\mathfrak{R}_{ex}(\pi)$ and $\mathfrak{R}'_{ex}(\pi)$ coincide.*²

C. Boissy and E. Lanneau prove in [6] that for any generalized permutation π_1 in a Rauzy class $\mathfrak{R}(\pi_0)$ of an irreducible generalized permutation π_0 one has $\mathfrak{R}(\pi_0) = \mathfrak{R}(\pi_1)$. This implies that an extended Rauzy class (whichever of the two definitions above we choose) is a disjoint union of Rauzy classes.

In the statement of the conjecture below we allow a degree d_i in $\mathcal{Q}(d_1, \dots, d_m)$ to have value “ -1 ”; in this case it corresponds to a simple pole.

CONJECTURE 2. *Let an extended Rauzy class \mathfrak{R}_{ex} represent a connected component of a stratum $\mathcal{Q}(d_1, \dots, d_m)$ or of a stratum $\mathcal{H}(d_1, \dots, d_m)$. Let k be the number of pairwise distinct entries in $\{d_1, \dots, d_m\}$. Then \mathfrak{R}_{ex} is a disjoint union of exactly k nonempty Rauzy classes.*

For example, the extended Rauzy class representing the stratum $\mathcal{H}(2, 1, 1)$ is a disjoint union of two Rauzy classes. Permutations of the first one correspond to horizontal intervals adjacent on the left to a simple zero while permutations of the second Rauzy class correspond to horizontal intervals adjacent on the left to a zero of degree two. This conjecture is confirmed for all low-dimensional strata, see Appendix D.

Remark. Note that following Convention 1 in Section 1.2 and Convention 2 in Section 3.1 the first entry in a set (d_1, \dots, d_m) of singularity data defining a connected component of a stratum $\mathcal{H}(d_1, \dots, d_m)$ or of a stratum $\mathcal{Q}(d_1, \dots, d_m, -1^p)$ was distinguished: a cylindrical permutation representing the corresponding component was constructed in such way that the degree of a zero associated to the left endpoint was equal to d_1 . For example, Proposition 2 constructs representatives of distinct Rauzy classes for $\mathcal{H}(2, 1, 1)$ and for $\mathcal{H}(1, 2, 1)$.

For the strata of quadratic differentials we did not construct generalized permutations having simple poles associated to their left endpoints. This can easily be done by an appropriate cyclic move of an appropriate line in a cylindrical representation (1) of the corresponding permutation. Otherwise, modulo Conjecture 2 we have constructed representatives of all Rauzy classes (and not only extended Rauzy classes) of irreducible nondegenerate generalized permutations.

Inverse generalized permutations and balanced generalized permutations.

We complete this section with a short discussion of two notions related to generalized permutations.

DEFINITION. We say that a generalized permutation π^{-1} is *inverse* to a generalized permutation π if it can be obtained from π by interchanging the lines (up to a standard convention on equivalence of alphabets).

$$\pi = \begin{pmatrix} \alpha_1, \alpha_2, \dots, \alpha_p \\ \beta_1, \beta_2, \dots, \beta_q \end{pmatrix} \quad \pi^{-1} = \begin{pmatrix} \beta_1, \beta_2, \dots, \beta_q \\ \alpha_1, \alpha_2, \dots, \alpha_p \end{pmatrix}$$

²When the paper was already in press C. Boissy has announced a proof of this conjecture.

The operation of taking inverse interacts with the Rauzy operations in the following way:

$$(12) \quad a(\pi^{-1}) = (b(\pi))^{-1} \quad b(\pi^{-1}) = (a(\pi))^{-1} \quad c(\pi^{-1}) = (c(\pi))^{-1}$$

LEMMA 3. *The generalized permutations π and π^{-1} are simultaneously irreducible or not. When they are irreducible, they belong to the same extended Rauzy class.*

Proof. Consider a closed flat surface S represented by a meromorphic quadratic differential q with at most simple poles and some polygonal pattern Π for S . We can associate to S a conjugate flat surface \bar{S} , which is obtained by identifying the corresponding pairs of sides of the polygon $\bar{\Pi}$ obtained from Π by a symmetry with respect to the horizontal axes. The lemma above is equivalent to its geometric version below. \square

LEMMA 4. *The map $S \rightarrow \bar{S}$ preserves connected components of the strata.*

Proof. Clearly S and \bar{S} belong to the same stratum. By the result of W. Veech [28] which immediately generalizes to quadratic differentials, a surface in a hyperelliptic component can be represented by a centrally-symmetric polygonal pattern Π , where the central symmetry acts as a hyperelliptic involution. It is easy to see that the central symmetry of $\bar{\Pi}$ induces on \bar{S} a hyperelliptic involution which acts on singularities in the same way as the one associated to S . Hence if S belongs to a hyperelliptic component, so does \bar{S} .

Suppose that S belongs to a stratum $\mathcal{H}(2d_1, \dots, 2d_m)$. Consider a canonical basis of cycles on S realized by smooth simple closed curves avoiding singularities. The images of these curves under the pointwise map $S \rightarrow \bar{S}$ represent a canonical basis of cycles on \bar{S} . The indices of the corresponding curves (see Appendix C) counted modulo 2 are the same as the indices of the original curves. Thus, the surfaces S and \bar{S} share the same parity of the spin structure, see (13).

Suppose that S and \bar{S} belong to one of the exceptional strata $\mathcal{Q}(3, 3, 3, -1)$, $\mathcal{Q}(6, 3, -1)$, $\mathcal{Q}(9, -1)$. It follows from (12) that the operation of taking inverse bijectively maps an extended Rauzy class to an extended Rauzy class. We know from a direct computation that there are exactly two extended Rauzy classes associated to each of the four exceptional strata, and that the cardinalities in each pair are different, see Table 1. Hence, the operation of taking inverse maps all of these extended Rauzy classes to themselves and so the geometric realization $S \mapsto \bar{S}$ of this operation maps the connected components to themselves. \square

Remark. The Lemma above cannot be extended to all closed $GL(2, \mathbb{R})$ -invariant suborbifold of the moduli spaces. Counterexamples can be found among orbits of square-tiled surfaces (arithmetic Veech surfaces). Namely, the $GL(2, \mathbb{R})$ -orbits of the two rightmost surfaces in Figure 6 are distinct and the map $S \mapsto \bar{S}$ interchanges the two orbits.

DEFINITION. A generalized permutation π is called *balanced* if the lines of π have the same length:

$$\pi = \begin{pmatrix} \alpha_1, \alpha_2, \dots, \alpha_p \\ \beta_1, \beta_2, \dots, \beta_p \end{pmatrix}.$$

LEMMA 5. *The Rauzy class of any irreducible generalized permutation π contains a balanced generalized permutation.*

Proof. In the proof below we do not reenumerate the symbols of a generalized permutation after applying operations a and b .

Suppose that the bottom line of π is shorter than the top one. Suppose that the twin 0_2 of the rightmost element 0_1 in the bottom line is also located in the bottom line. Since the bottom line is shorter than the top one, the top line contains more than one pair of identical symbols, and hence operation b is applicable to π . Note that by applying the operation b we made the bottom line longer and the top one shorter while the twin 0_2 of the rightmost element 0_1 in the bottom line stayed in the bottom line. Recursively applying this argument we eventually get a balanced permutation.

Suppose now that the twin 0_2 of the rightmost element 0_1 in the bottom line is located in the top line. If our generalized permutation is a “true” permutation it is already balanced. If not, the bottom line contains at least one symbol β_k which has his twin in the bottom line. It follows from results [6] of C. Boissy and E. Lanneau on the dynamics of Rauzy–Veech induction that applying operations a and b in all possible ways we can eventually make every symbol appear in the rightmost position. Consider a chain of operations a and b which place β_k in the rightmost position and suppose that our chain does not contain a shorter one placing β_k in the rightmost position. By construction, the corresponding generalized permutation π' has β_k in the rightmost position in the bottom line and the twin of β_k also belongs to the bottom line. Hence, either our chain of operations a and b already contains a balanced generalized permutation, or we can apply our previous argument to π' to obtain one. \square

APPENDIX C. PARITY OF A SPIN STRUCTURE IN TERMS OF A PERMUTATION

Consider a permutation π representing a stratum of Abelian differentials of the form $\mathcal{H}(2d_1, \dots, 2d_m)$. In this section we describe how to compute the parity of the spin structure of a surface associated to the permutation π . For strata different from $\mathcal{H}(2g - 2)$ or $\mathcal{H}(2k, 2k)$, the parity of the spin structure determines a connected component $\mathcal{H}^{even}(2d_1, \dots, 2d_m)$ or $\mathcal{H}^{odd}(2d_1, \dots, 2d_m)$ represented by π .

There remains ambiguity with the strata $\mathcal{H}(2g - 2)$ or $\mathcal{H}(2k, 2k)$ since they contain three connected components when $g \geq 4$. The parity $\phi(S)$ of the spin structure for surfaces from hyperelliptic connected components of these strata

is expressed as follows, see [16]:

$$\phi(S) = \begin{cases} \left[\frac{g+1}{2} \right] \pmod{2} & \text{for } S \in \mathcal{H}_1^{\text{hyp}}(2g-2) \\ k+1 \pmod{2} & \text{for } S \in \mathcal{H}_1^{\text{hyp}}(2k, 2k) \end{cases}$$

where $[x]$ denotes the integer part of a number x .

Parity of the spin structure. Definition. Consider a flat surface S in a stratum $\mathcal{H}(2d_1, \dots, 2d_m)$. Consider a smooth simple closed curve γ on S such that γ does not pass through singularities of the flat metric. Our flat structure defines a trivialization of the tangent bundle to S that is punctured at the singularities. Thus, we can consider the Gauss map from γ to a unit circle; this map associates to a point x of γ the unit tangent vector $T_x\gamma$ at this point.

We define $\text{ind}(\gamma) \in \mathbb{Z}$ as the degree of the Gauss map. When we follow the curve tracing how the tangent vector turns with respect to the vertical direction, we observe a total change of the angle along the curve of $2\pi \cdot \text{ind}(\gamma)$.

Now take a symplectic homology basis $\{a_1, b_1, a_2, b_2, \dots, a_g, b_g\}$ in which the intersection matrix has the canonical form: $a_i \circ a_j = b_i \circ b_j = 0$, $a_i \circ b_j = \delta_{ij}$, $1 \leq i, j \leq g$. Though such basis is not unique, traditionally it is called a *canonical basis*. Consider a collection of smooth simple closed curves representing the chosen basis. Denote them by α_i, β_i respectively. Perturbing the curves α_i, β_i if necessary, we can make them avoid singularities of the metric.

When all zeroes of Abelian differential ω representing the flat structure have only even degrees we can define a *parity of the spin structure*

$$(13) \quad \phi(S) := \sum_{i=1}^g (\text{ind}(\alpha_i) + 1)(\text{ind}(\beta_i) + 1) \pmod{2}.$$

It follows from the results of D. Johnson [12] that the parity of the spin structure $\phi(S)$ depends neither on the choice of representatives nor on the choice of the canonical homology bases.

On the other hand, by results of M. Atiyah [2] the quantity $\phi(S)$ expressed in different terms is invariant under continuous deformations of the flat surface inside the stratum, which implies that it is an invariant of a connected component of the stratum (see [16] for details).

Generating family of cycles associated to an interval exchange map. Having an irreducible permutation π one can construct an interval exchange map $T: X \rightarrow X$, a flat surface S (suspension over T) and an embedding of X into a horizontal leaf on S such that the first-return map of the vertical flow to the horizontal segment X induces the interval-exchange transformation $T: X \rightarrow X$ with permutation π (see [21, 25] and Section 1.2).

For every interval X_i being exchanged consider a leaf of the vertical foliation launched at some interior point of X and follow it till the first return to X . Join the endpoints of the resulting vertical curve along the interval X . It is easy to

smoothen the resulting closed path to make it everywhere transverse to the horizontal direction, see Figure 15. Denote the resulting smooth simple closed curve by γ_i . Since γ_i is everywhere transverse to the horizontal direction, we get

$$(14) \quad \text{ind}(\gamma_i) = 0.$$

We denote by c_i the cycle represented by the oriented curve γ_i .

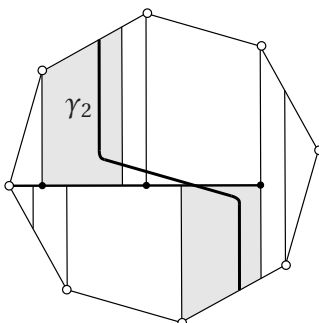

FIGURE 15. Construction of a generating family of cycles associated to an interval-exchange transformation.

LEMMA 6. *If the vertical foliation on S is minimal, then the cycles $\{c_1, \dots, c_n\}$ form a generating family in $H_1(S, \mathbb{Z})$. None of them is trivial.*

Proof. We leave the proof as an exercise to the reader. □

Algebraic definition. Given a permutation π we define the following skew-symmetric matrix $\Omega(\pi)$:

$$(15) \quad \Omega_{ij}(\pi) = \begin{cases} -1 & \text{if } i < j \text{ and } \pi^{-1}(i) > \pi^{-1}(j) \\ 1 & \text{if } i > j \text{ and } \pi^{-1}(i) < \pi^{-1}(j) \\ 0 & \text{otherwise} \end{cases}$$

LEMMA 7. *Let $T: X \rightarrow X$ be the interval-exchange transformation induced by the vertical flow on a surface S . Let π be the associated permutation, and let c_1, \dots, c_n be the “first return cycles” as in Figure 15. The matrix $\Omega(\pi)$ defines the intersection numbers of the cycles $\{c_1, \dots, c_n\}$:*

$$c_i \cdot c_j = \Omega_{ij}(\pi)$$

Proof. The proof immediately follows from Figure 15. □

From now on it is convenient to pass to the field \mathbb{Z}_2 . Note that the intersection form Ω becomes symmetric over \mathbb{Z}_2 .

Define a function $\Phi: H_1(S, \mathbb{Z}_2) \rightarrow \mathbb{Z}_2$ as follows. Fixing a cycle c , represent it by a simple closed curve γ . Deforming γ if necessary, we may assume it avoids singularities of the metric. Let

$$(16) \quad \Phi(c) := \text{ind}(\gamma) + 1 \pmod 2$$

The following theorem is a corollary of a corresponding theorem of D. Johnson, see [12].

THEOREM. *The function Φ is well-defined on $H_1(S, \mathbb{Z}_2)$. It is a quadratic form associated to the bilinear form Ω in the following sense:*

$$(17) \quad \Phi(c + c') = \Phi(c) + \Phi(c') + \Omega(c, c')$$

Recall that Ω is the intersection form, $\Omega(c, c') = c \cdot c'$. Note also that the parity $\phi(S)$ of the spin structure defined by (13) is expressed in terms of the quadratic form Φ :

$$\phi(S) = \sum_{i=1}^g \Phi(a_i) \Phi(b_i)$$

where $\{a_1, b_1, a_2, b_2, \dots, a_g, b_g\}$ is a canonical basis of cycles in $H_1(S, \mathbb{Z}_2)$. In other words, the parity $\phi(S)$ of the spin structure of a flat surface S associated to the permutation π is equal to the Arf-invariant of the quadratic form Φ on $H_1(S, \mathbb{Z}_2)$ (see [12, 1]).

Orthogonalization. The problem of evaluation of $\phi(S)$ can be reformulated now in terms of linear algebra over the field \mathbb{Z}_2 . We have a generating family of vectors $\{c_1, \dots, c_n\}$ in $H_1(S, \mathbb{Z}_2) \simeq (\mathbb{Z}_2)^{2g}$. By the construction suggested by Figure 15, all these cycles can be represented by curves γ_i that are everywhere transverse to the horizontal direction. Thus, applying (14) to definition (16) of $\Phi(c_i)$ we obtain the values of Φ on the vectors from this family:

$$\Phi(c_i) = 1 \quad \text{for } i = 1, \dots, n$$

We also know the values of the symplectic bilinear form Ω on every pair of vectors in this family. It remains to apply an orthogonalization procedure to construct a canonical basis $\{a_1, b_1, a_2, b_2, \dots, a_g, b_g\}$. As we construct new vectors, we can keep track of the values of the quadratic form Φ on them by repeatedly applying formula (17). Since we work over the field \mathbb{Z}_2 the formulae are especially simple.

We let $a_1 := c_1$. It follows from Lemma 6 that we can find an index j , where $1 \leq j \leq n$, such that $\Omega_{1j} \neq 0$. We let $b_1 := c_j$. Now we modify the remaining vectors to make them orthogonal to a_1, b_1 . Recall that we work over \mathbb{Z}_2 .

$$c'_i := c_i + \Omega_{ij}c_1 + \Omega_{i1}c_j \quad \text{for } i = 2, \dots, n, \quad \text{where } i \neq j.$$

Using (17) and simplifying the resulting expression we compute the values of Φ on these new vectors:

$$\Phi(c'_i) := \Phi(c_i) + \Omega_{ij}\Phi(c_1) + \Omega_{i1}\Phi(c_j) + \Omega_{i1}\Omega_{ij}.$$

Finally we compute the intersection matrix for the resulting family of vectors $\{c'_2, \dots, c'_{j-1}, c'_{j+1}, \dots, c'_n\}$. After simplification, we get:

$$c'_k \cdot c'_l = \Omega_{kl} + \Omega_{k1}\Omega_{lj} + \Omega_{kj}\Omega_{l1}.$$

Now let us remove from our family those vectors c'_i which are orthogonal to all other vectors of the family. If the resulting family is nonempty, reenumerate the vectors from this new family and proceed by induction.

APPENDIX D. RAUZY CLASSES FOR SMALL GENERA

For genus $g = 3$ the stratum of Abelian differentials of maximal dimension, *i.e.*, the principal stratum, has dimension 9. Thus, using extended Rauzy classes to describe connected components of the strata we deal with permutations of at most 9 elements, provided we study genera $g = 2$ and $g = 3$. The number of such permutations is small enough to construct the Rauzy classes explicitly (using a computer, of course).

Note that for the stratum $\mathcal{H}(4)$ in genus 3, the presence of two different extended Rauzy classes was proved by W. A. Veech in [27]; P. Arnoux proved that there are three different extended Rauzy classes corresponding to the stratum $\mathcal{H}(6)$.

In the tables below we present the list of all Rauzy classes determined by non-degenerate “true” permutations of at most 9 elements and by “generalized” permutations of at most 6 elements, see [15]. We indicate hyperellipticity and parity of the spin structure of corresponding components when they are defined. Horizontal lines separate extended Rauzy classes. For “true” permutations π we present only the second line in the canonical enumeration

$$\begin{pmatrix} 1 & 2 & \dots & n \\ \pi^{-1}(1) & \pi^{-1}(2) & \dots & \pi^{-1}(n) \end{pmatrix}.$$

Recall that a (generalized) permutation representing a stratum $\mathcal{H}(d_1, \dots, d_m)$ or $\mathcal{Q}(d_1, \dots, d_m)$ has a singularity of degree d_1 at the left endpoint of X . This is the reason why, say, the stratum $\mathcal{Q}(2, 1, -1^3)$ appears in our table three times (see also Conjecture 2).

The reader can find a *Mathematica* script generating a Rauzy class and an extended Rauzy class from a given generalized permutation on the author’s web site. The same web page contains scripts realizing most of the algorithms described in the present paper, including the ones which construct cylindrical generalized permutations defining Jenkins–Strebel differentials with a single cylinder representing a given connected component of a given stratum of Abelian or quadratic differentials.

Remark. By convention we identify generalized permutations which can be obtained one from another by reenumerations. Studying the dynamics of Rauzy induction it is sometimes more natural to avoid reenumeration, see [19, 30, 31].

However, under the second convention the Rauzy classes become larger and require more space in computer experiments. The cardinalities of Rauzy classes in the tables below are given under the first convention.

Strata of Abelian differentials

Genus $g = 2$

Representative of Rauzy class	Cardinality of Rauzy class	Degrees of zeros	Hyperelliptic or spin structure
(4, 3, 2, 1)	7	(2)	<i>hyperelliptic</i>
(5, 4, 3, 2, 1)	15	(1, 1)	<i>hyperelliptic</i>

Genus $g = 3$

(6, 5, 4, 3, 2, 1)	31	(4)	<i>hyperelliptic</i>
(4, 3, 6, 5, 2, 1)	134	(4)	<i>odd</i>
(4, 3, 7, 6, 5, 2, 1) (5, 4, 3, 7, 6, 2, 1)	509 261	(3, 1) (1, 3)	–
(7, 6, 5, 4, 3, 2, 1)	63	(2, 2)	<i>hyperelliptic</i>
(4, 3, 5, 7, 6, 2, 1)	294	(2, 2)	<i>odd</i>
(5, 4, 3, 8, 7, 6, 2, 1) (4, 3, 5, 8, 7, 6, 2, 1)	1258 919	(1, 2, 1) (2, 1, 1)	–
(5, 4, 3, 6, 9, 8, 7, 2, 1)	1255	(1, 1, 1, 1)	–

Genus $g = 4$

(8, 7, 6, 5, 4, 3, 2, 1)	127	(6)	<i>hyperelliptic</i>
(6, 5, 4, 3, 8, 7, 2, 1)	2327	(6)	<i>even</i>
(4, 3, 6, 5, 8, 7, 2, 1)	5209	(6)	<i>odd</i>
(5, 4, 3, 7, 6, 9, 8, 2, 1) (4, 3, 6, 5, 9, 8, 7, 2, 1)	10543 31031	(1, 5) (5, 1)	–
(7, 6, 5, 4, 3, 9, 8, 2, 1) (6, 5, 4, 3, 7, 9, 8, 2, 1)	3954 6614	(2, 4) (4, 2)	<i>even</i>
(4, 3, 5, 7, 6, 9, 8, 2, 1) (4, 3, 6, 5, 7, 9, 8, 2, 1)	8797 14709	(2, 4) (4, 2)	<i>odd</i>
(9, 8, 7, 6, 5, 4, 3, 2, 1)	255	(3, 3)	<i>hyperelliptic</i>
(4, 3, 7, 6, 5, 9, 8, 2, 1)	15568	(3, 3)	–
...

Strata of quadratic differentials

Genus $g = 0$

$\begin{pmatrix} 1, 2, 2 \\ 3, 3, 1 \end{pmatrix}$	4	(-1^4)
$\begin{pmatrix} 1, 2, 2 \\ 3, 3, 4, 4, 5, 5, 1 \end{pmatrix}$	10	$(1, -1^5)$
$\begin{pmatrix} 1, 2, 3, 3, 4, 4, 2 \\ 5, 5, 1 \end{pmatrix}$	22	$(-1^5, 1)$
$\begin{pmatrix} 1, 2, 2 \\ 3, 3, 4, 4, 5, 5, 6, 6, 1 \end{pmatrix}$	13	$(2, -1^6)$
$\begin{pmatrix} 1, 2, 3, 3, 4, 4, 5, 5, 2 \\ 6, 6, 1 \end{pmatrix}$	28	$(-1^6, 2)$

Genus $g = 2$

$\begin{pmatrix} 1, 2, 3, 2, 4 \\ 4, 5, 5, 3, 1 \end{pmatrix}$	440	$(5, -1)$	
$\begin{pmatrix} 1, 2, 3, 2, 4 \\ 5, 3, 4, 5, 1 \end{pmatrix}$	54	$(-1, 5)$	
$\begin{pmatrix} 1, 2, 3, 2, 4 \\ 4, 5, 5, 6, 6, 3, 1 \end{pmatrix}$	4832	$(6, -1^2)$	<i>non</i>
$\begin{pmatrix} 1, 2, 3, 2, 4 \\ 5, 3, 4, 6, 6, 5, 1 \end{pmatrix}$	1118	$(-1^2, 6)$	<i>non</i>
$\begin{pmatrix} 1, 2, 2, 3, 4, 5 \\ 5, 4, 3, 6, 6, 1 \end{pmatrix}$	347	$(6, -1^2)$	<i>hyp</i>
$\begin{pmatrix} 1, 2, 3, 4, 5, 2 \\ 6, 5, 4, 3, 6, 1 \end{pmatrix}$	60	$(-1^2, 6)$	<i>hyp</i>
$\begin{pmatrix} 1, 2, 3, 2, 4 \\ 5, 4, 5, 3, 1 \end{pmatrix}$	73	(2^2)	
$\begin{pmatrix} 1, 2, 3, 2, 4 \\ 5, 4, 5, 6, 6, 3, 1 \end{pmatrix}$	1666	$(3, 2, -1)$	
$\begin{pmatrix} 1, 2, 3, 2, 4 \\ 5, 4, 6, 6, 5, 3, 1 \end{pmatrix}$	1348	$(2, 3, -1)$	
$\begin{pmatrix} 1, 2, 3, 2, 4 \\ 5, 3, 6, 4, 6, 5, 1 \end{pmatrix}$	294	$(-1, 3, 2)$	
$\begin{pmatrix} 1, 2, 3, 2, 4, 5 \\ 5, 4, 6, 6, 3, 1 \end{pmatrix}$	2062	$(4, 1, -1)$	
$\begin{pmatrix} 1, 2, 3, 4, 2, 5 \\ 3, 5, 6, 6, 4, 1 \end{pmatrix}$	1076	$(1, 4, -1)$	
$\begin{pmatrix} 1, 2, 3, 2, 4, 5 \\ 6, 3, 5, 4, 6, 1 \end{pmatrix}$	260	$(-1, 4, 1)$	
$\begin{pmatrix} 1, 2, 3, 2, 4, 5 \\ 6, 5, 4, 6, 3, 1 \end{pmatrix}$	125	$(2, 1^2)$	
$\begin{pmatrix} 1, 2, 3, 4, 2, 5 \\ 3, 6, 5, 6, 4, 1 \end{pmatrix}$	220	$(1^2, 2)$	

Genus $g = 1$

$\begin{pmatrix} 1, 2, 3, 3 \\ 2, 4, 4, 1 \end{pmatrix}$	43	$(2, -1^2)$
$\begin{pmatrix} 1, 2, 3, 3 \\ 4, 2, 4, 1 \end{pmatrix}$	20	$(-1^2, 2)$
$\begin{pmatrix} 1, 2, 3, 3, 4, 4 \\ 2, 5, 5, 1 \end{pmatrix}$	198	$(3, -1^3)$
$\begin{pmatrix} 1, 2, 3, 3, 4, 4 \\ 5, 2, 5, 1 \end{pmatrix}$	120	$(-1^3, 3)$
$\begin{pmatrix} 1, 2, 3, 3, 4, 4, 5, 5 \\ 2, 6, 6, 1 \end{pmatrix}$	596	$(4, -1^4)$
$\begin{pmatrix} 1, 2, 3, 3, 4, 4, 5, 5 \\ 6, 2, 6, 1 \end{pmatrix}$	440	$(-1^4, 4)$
$\begin{pmatrix} 1, 2, 3, 4, 4 \\ 3, 2, 5, 5, 1 \end{pmatrix}$	128	$(1^2, -1^2)$
$\begin{pmatrix} 1, 2, 3, 4, 4 \\ 5, 3, 2, 5, 1 \end{pmatrix}$	34	$(-1^2, 1^2)$
$\begin{pmatrix} 1, 2, 3, 3, 4, 5, 5 \\ 4, 2, 6, 6, 1 \end{pmatrix}$	714	$(2, 1, -1^3)$
$\begin{pmatrix} 1, 2, 3, 4, 4, 5, 5 \\ 3, 2, 6, 6, 1 \end{pmatrix}$	514	$(1, 2, -1^3)$
$\begin{pmatrix} 1, 2, 3, 3, 4, 5, 5 \\ 6, 4, 2, 6, 1 \end{pmatrix}$	510	$(-1^3, 2, 1)$

Genus $g = 3$

$\begin{pmatrix} 1, 2, 3, 2, 3, 4 \\ 5, 6, 5, 6, 4, 1 \end{pmatrix}$	2590	(8)	
--	------	-------	--

Acknowledgments. This paper has grown from experiments performed at IHES in 1995–1996 by M. Kontsevich and the author, see [15]. In particular, the initial version of this paper was planned as an appendix to the paper [16].

I would like to thank Maxim Kontsevich for numerous valuable discussions of this subject; his ideas were at the origin of the study of the combinatorics, geometry and dynamics of generalized interval-exchange transformations.

I am very much indebted to Corentin Boissy and to Erwan Lanneau who have constructed a rigorous theory of generalized permutations and of their Rauzy classes. Without their work the present paper would make no sense.

I would like to thank Giovanni Forni, Boris Hasselblatt, Erwan Lanneau and the referee for an extremely careful reading of the manuscript and for numerous helpful comments.

I highly appreciate hospitality of Institut des Hautes Études Scientifiques and of Max–Planck–Institut für Mathematik at Bonn while preparing this paper.

REFERENCES

- [1] C. Arf, *Untersuchungen über quadratische Formen in Köpern der Charakteristik 2. I.*, J. Reine Angew. Math., **183** (1941), 148–167.
- [2] M. Atiyah, *Riemann surfaces and spin structures*, Ann. scient. École Norm. Sup. (4), **4** (1971), 47–62.
- [3] A. Avila, S. Gouezel and J.-C. Yoccoz, *Exponential mixing for the Teichmüller flow*, Publications Mathématiques de l’IHES, **104** (2006), 143–211.
- [4] A. Avila and G. Forni, *Weak mixing for interval-exchange transformations and translation flows*, Annals of Math., **165** (2007), 637–664.
- [5] A. Avila and M. Viana, *Simplicity of Lyapunov spectra: proof of the Zorich–Kontsevich conjecture*, Acta Math., **198** (2007), 1–56.
- [6] C. Boissy and E. Lanneau, *On Generalized interval exchange maps: Dynamics and geometry of the Rauzy–Veech induction*, E-print at arXiv:math.GT/0710.5614.
- [7] A. Bufetov, *Decay of Correlations for the Rauzy–Veech–Zorich Induction Map on the Space of Interval Exchange Transformations and the Central Limit Theorem for the Teichmüller Flow on the Moduli Space of Abelian Differentials*, Journal of AMS, **19** (2006), 579–623.
- [8] C. Danthony and A. Nogueira, *Measured foliations on nonorientable surfaces*, Ann. Scient. ÉNS, **23** (1990), 469–494.
- [9] A. Douady and J. Hubbard, *On the density of strebel differentials*, Inventiones Mathematicae, **30** (1975), 175–179.
- [10] A. Eskin, H. Masur and A. Zorich, *Moduli spaces of Abelian differentials: the principal boundary, counting problems and the Siegel–Veech constants*, Publications Mathématiques de l’IHES, **97** (2003), 61–179.
- [11] J. Hubbard and H. Masur, *Quadratic differentials and foliations*, Acta Mathematica, **142** (1979), 221–274.
- [12] D. Johnson, *Spin structures and quadratic forms on surfaces*, J. London Math. Soc. (2), **22** (1980), 365–373.
- [13] M. Kontsevich, *Intersection theory on the moduli space of curves and the matrix Airy function*, Communications in Math. Phys., **147** (1992), 1–23.
- [14] M. Kontsevich, *Lyapunov exponents and Hodge theory*, “The mathematical beauty of physics” (Saclay, 1996), (in Honor of C. Itzykson), Adv. Ser. Math. Phys., **24**, World Sci. Publishing, River Edge, NJ, (1997), 318–332.

- [15] M. Kontsevich and A. Zorich, *Lyapunov exponents and Hodge theory*, Preprint IHES M/97/13, pp. 1–16; protectarXiv:hep-th/9701164.
- [16] M. Kontsevich and A. Zorich, *Connected components of the moduli spaces of Abelian differentials with prescribed singularities*, *Inventiones mathematicae*, **153** (2003), 631–678.
- [17] E. Lanneau, *Hyperelliptic components of the moduli spaces of quadratic differentials with prescribed singularities*, *Comment. Math. Helv.*, **79** (2004), 471–501.
- [18] E. Lanneau, *Connected components of the strata of the moduli spaces of quadratic differentials*, to appear in *Annales de l'ENS*; E-print at protectarXiv:math.GT/0506136.
- [19] S. Marmi, P. Moussa and J.-C. Yoccoz *The cohomological equation for Roth-type interval exchange maps*, *Journal of AMS*, **18** (2005), 823–872.
- [20] H. Masur, *The Jenkins–Strebel differentials with one cylinder are dense*, *Commentarii Mathematici Helvetici*, **54** (1979), 179–184.
- [21] H. Masur, *Interval-exchange transformations and measured foliations*, *Annals of Math. (2)*, **115** (1982), 169–200.
- [22] H. Masur and J. Smillie, *Quadratic differentials with prescribed singularities and pseudo-Anosov diffeomorphisms*, *Comment. Math. Helvetici*, **68** (1993), 289–307.
- [23] H. Masur and A. Zorich, *Multiple saddle connections on flat surfaces and principal boundary of the moduli spaces of quadratic differentials*, to appear in *GAF* (2008); Eprint in protectarXiv:math.GT/0402197
- [24] G. Rauzy, *Echanges d'intervalles et transformations induites*, *Acta Arith.*, **34** (1979), 315–328.
- [25] W. A. Veech, *Gauss measures for transformations on the space of interval exchange maps*, *Annals of Mathematics*, **115** (1982), 201–242.
- [26] W. A. Veech, *The Teichmüller geodesic flow*, *Annals of Mathematics (2)*, **124** (1986), 441–530.
- [27] W. A. Veech, *Moduli spaces of quadratic differentials*, *Journal Analyse Math.*, **55** (1990), 117–171.
- [28] W. A. Veech, *Geometric realizations of hyperelliptic curves*, *Algorithms, fractals and dynamics* (Okayama/Kyoto 1992), 217–226, Plenum, New-York, 1995.
- [29] M. Viana, *Dynamics of interval exchange maps and Teichmüller flows*, *Lecture notes of graduate courses taught at IMPA in 2005 and 2007*, Preprint.
- [30] J.-C. Yoccoz, *Continued fraction algorithms for interval exchange maps: an introduction*, in collection “Frontiers in Number Theory, Physics and Geometry. Vol. 1: On random matrices, zeta functions and dynamical systems”; Ecole de physique des Houches, France, March 9–21 2003, P. Cartier; B. Julia; P. Moussa; P. Vanhove (Editors), Springer-Verlag, Berlin, 2006, 401–435.
- [31] J.-C. Yoccoz, *Echanges d'intervalles*, *Notes de cours donné au Collège de France en 2005*, Preprint.
- [32] A. Zorich *Finite Gauss measure on the space of interval-exchange transformations. Lyapunov exponents*, *Annals Inst. Fourier (Grenoble)*, **46** (1996), 325–370.
- [33] A. Zorich, *Flat surfaces*, in collection “Frontiers in Number Theory, Physics and Geometry. Vol. 1: On random matrices, zeta functions and dynamical systems”; Ecole de physique des Houches, France, March 9–21 2003, P. Cartier; B. Julia; P. Moussa; P. Vanhove (Editors), Springer-Verlag, Berlin, 2006, 439–586.

ANTON ZORICH <Anton.Zorich@univ-rennes1.fr>: IRMAR, Université Rennes 1, Campus de Beaulieu, 35042 Rennes, France. URL: <http://perso.univ-rennes1.fr/anton.zorich>

