

Ricci flow on open 3-manifolds and positive scalar curvature

Laurent Bessières, Gérard Besson and Sylvain Maillot

November 2, 2018

Abstract

We show that an orientable 3-dimensional manifold M admits a complete riemannian metric of bounded geometry and uniformly positive scalar curvature if and only if there exists a finite collection \mathcal{F} of spherical space-forms such that M is a (possibly infinite) connected sum where each summand is diffeomorphic to $S^2 \times S^1$ or to some member of \mathcal{F} . This result generalises G. Perelman's classification theorem for compact 3-manifolds of positive scalar curvature. The main tool is a variant of Perelman's surgery construction for Ricci flow.

1 Introduction

Thanks to G. Perelman's proof [Per02, Per03b, Per03a] of W. Thurston's Geometrisation Conjecture, the topological structure of compact 3-manifolds is now well understood in terms of the canonical geometric decomposition. The first step of this decomposition, which goes back to H. Kneser [Kne29], consists in splitting such a manifold as a connected sum of *prime* 3-manifolds, i.e. 3-manifolds which are not nontrivial connected sums themselves.

It has been known since early work of J. H. C. Whitehead [Whi35] that the topology of *open* 3-manifolds is much more complicated. Directly relevant to the present paper are counterexamples of P. Scott [ST89] and the third author [Mai08] which show that Kneser's theorem fails to generalise to open manifolds, even if one allows infinite connected sums.

Of course, we need to explain what we mean by a possibly infinite connected sum. If \mathcal{X} is a class of 3-manifolds, we will say that a 3-manifold M is a *connected sum* of members of \mathcal{X} if there exists a locally finite graph G and a map $v \mapsto X_v$ which associates to each vertex of G a copy of some manifold

in \mathcal{X} , such that by removing from each X_v as many 3-balls as vertices incident to v and gluing the thus punctured X_v 's to each other along the edges of G , one obtains a 3-manifold diffeomorphic to M . This is equivalent to the requirement that M should contain a locally finite collection of pairwise disjoint embedded 2-spheres \mathcal{S} such that the operation of cutting M along \mathcal{S} and capping-off 3-balls yields a disjoint union of 3-manifolds which are diffeomorphic to members of \mathcal{X} .¹

Note that restricting this definition to finite graphs and compact manifolds yields a slightly nonstandard definition of a connected sum. In the usual definition of a finite connected sum, one has a *tree* rather than a graph. It is well-known, however, that the graph of a finite connected sum (in the sense of the previous paragraph) can be made into a tree at the expense of adding extra $S^2 \times S^1$ factors. The more general definition we have chosen for this paper seems more natural in view of the surgery theory for Ricci flow. It can be shown that the two definitions are equivalent even when the graph is infinite; however, having a tree rather than a graph is only important for issues of *uniqueness*, which will not be tackled here.

The above-quoted articles [ST89, Mai08] provide examples of badly behaved open 3-manifolds, which are not connected sums of prime 3-manifolds. From the point of view of Riemannian geometry, it is natural to look for sufficient conditions for a Riemannian metric on an open 3-manifold M that rule out such exotic behaviour. One such condition was given by the third author in the paper [Mai07]. Here we shall consider Riemannian manifolds of positive scalar curvature. This class of manifolds has been extensively studied since the seminal work of A. Lichnerowicz, M. Gromov, B. Lawson, R. Schoen, S.-T. Yau and others (see e.g. the survey articles [Gro91, Ros07].)

Let (M, g) be a Riemannian manifold. We denote by $R_{\min}(g)$ the infimum of the scalar curvature of g . We say that g has *uniformly positive scalar curvature* if $R_{\min}(g) > 0$. Of course, if M is compact, then this amounts to insisting that g should have positive scalar curvature at each point of M .

A 3-manifold is *spherical* if it admits a metric of positive constant sectional curvature. M. Gromov and B. Lawson [GL80] have shown that any compact, orientable 3-manifold which is a connected sum of spherical manifolds and copies of $S^2 \times S^1$ carries a metric of positive scalar curvature. Perelman [Per03b], completing pioneering work of Schoen-Yau [SY79] and Gromov-Lawson [GL83], proved the converse.

In this paper, we are mostly interested in the noncompact case. We say that a Riemannian metric g on M has *bounded geometry* if it has bounded sectional curvature and injectivity radius bounded away from zero. It follows

¹See below for the precise definition of *capping-off*.

from the Gromov-Lawson construction that if M is a (possibly infinite) connected sum of spherical manifolds and copies of $S^2 \times S^1$ such that there are finitely many summands up to diffeomorphism, then M admits a complete metric of bounded geometry and uniformly positive scalar curvature. We show that the converse holds, generalising Perelman's theorem:

Theorem 1.1. *Let M be a connected, orientable 3-manifold which carries a complete riemannian metric of bounded geometry and uniformly positive scalar curvature. Then there is a finite collection \mathcal{F} of spherical manifolds such that M is a connected sum of copies of $S^2 \times S^1$ or members of \mathcal{F} .*

In fact, the collection \mathcal{F} depends only on bounds on the geometry and a lower bound for the scalar curvature (cf. Corollary 11.1.)

Our main tool is R. Hamilton's Ricci flow. Let us give a brief review of the analytic theory of Ricci flow on complete manifolds. The basic short time existence result is due to W.-X. Shi [Shi89]: if M is a 3-manifold and g_0 is a complete riemannian metric on M which has bounded sectional curvature, then there exists $\varepsilon > 0$ and a Ricci flow $g(\cdot)$ defined on $[0, \varepsilon)$ such that $g(0) = g_0$, and for each t , $g(t)$ is also complete of bounded sectional curvature.

For brevity, we say that a Ricci flow $g(\cdot)$ has a given property \mathcal{P} if for each time t , the riemannian metric $g(t)$ has property \mathcal{P} . Hence the solutions constructed by Shi are complete Ricci flows with bounded sectional curvature. This seems to be a natural setting for the analytical theory of Ricci flow.²

Uniqueness of complete Ricci flows with bounded sectional curvature is due to B.-L. Chen and X.-P. Zhu [CZ06].

We shall provide a variant of Perelman's surgery construction for Ricci flow, which has the advantage of being suitable for generalisations to open manifolds. Perelman's construction can be summarised as follows. Let M be a closed, orientable 3-manifold. Start with an arbitrary metric g_0 on M . Consider a maximal Ricci flow solution $\{g(t)\}_{t \in [0, T_{max})}$ with initial condition g_0 . If $T_{max} = +\infty$, there is nothing to do. Otherwise, one analyses the behaviour of $g(t)$ as t goes to T_{max} and finds an open subset $\Omega \subset M$ where a limiting metric can be obtained. If Ω is empty, then the construction stops. Otherwise the ends of Ω have a special geometry: they are so-called ε -horns. Removing neighbourhoods of those ends and capping-off 3-balls with nearly standard geometry, one obtains a new closed, possibly disconnected riemannian 3-manifold. Then one restarts Ricci flow from this new metric and iterates the construction. In order to prove that finitely many surgeries occur in any compact time interval, Perelman makes crucial use of the finiteness of the volume of the various riemannian manifolds involved.

²However, there have been attempts to generalise the theory beyond this framework, see e.g. [Xu09, Sim09].

When trying to generalise this construction to open manifolds, one encounters several difficulties. First, the above-mentioned volume argument breaks down. Second, a singularity with $\Omega = M$ could occur, i.e. there may exist a complete Ricci flow with bounded sectional curvature defined on some interval $[0, T)$ and maximal *among complete Ricci flows with bounded sectional curvature*, such that when t tends to T , $g(t)$ converges to, say, a metric of unbounded curvature \bar{g} . Then it is not known whether Ricci flow with initial condition \bar{g} exists at all, and even if it does, the usual tools like the maximum principle may no longer be available. One can imagine, for example, an infinite sequence of spheres of the same radius glued together by necks whose curvature is going to infinity. In this situation (M, \bar{g}) would have no horns to do surgery on.

In order to avoid those difficulties, we shall perform surgery *before* a singularity appears. To this end, we introduce a new parameter Θ , which determines when surgery must be done (namely when the supremum R_{\max} of the scalar curvature reaches Θ .) We do surgery on tubes rather than horns. Furthermore, we replace the volume argument for non-accumulation of surgeries by a *curvature* argument: the key point is that at each surgery time, R_{\max} drops by a definite factor (which for convenience we choose equal to $1/2$.) This, together with an estimate on the rate of curvature blow-up, is sufficient to bound from below the elapsed time between two consecutive surgeries.

The idea of doing surgery before singularity time is not new: it was introduced by R. Hamilton in his paper [Ham97] on 4-manifolds of positive isotropic curvature. Our construction should also be compared with that of G. Huisken and C. Sinestrari [HS09] for Mean Curvature Flow, where in particular there is a similar argument for non-accumulation of surgeries. Needless to say, we rely heavily on Perelman's work, in particular the notions of κ -noncollapsing and canonical neighbourhoods.

Our construction should have other applications. In fact, it has already been adapted by H. Huang [Hua09] to complete 4-dimensional manifolds of positive isotropic curvature, using work of B.-L. Chen, S.-H. Tang and X.-P. Zhu [CTZ08] in the compact case.

Remaining informal for the moment, we provisionally define a *surgical solution* as a sequence of Ricci flow solutions $\{(M_i, g_i(t))\}_{t \in [t_i, t_{i+1}]}$, with $0 = t_0 < \dots < t_i < \dots \leq +\infty$ is discrete in \mathbf{R} , such that M_{i+1} is obtained from M_i by splitting along a locally finite collection of pairwise disjoint embedded 2-spheres, capping-off 3-balls and removing components which are spherical or diffeomorphic to \mathbf{R}^3 , $S^2 \times S^1$, $S^2 \times \mathbf{R}$, $RP^3 \# RP^3$ or a punctured RP^3 . If M_{i+1} is nonempty, we further require that $R_{\min}(g_{i+1}) \geq R_{\min}(g_i)$ at time t_{i+1} . The formal definition of surgical solutions will be given in

Section 2.

The components that are removed at time t_{i+1} are said to *disappear*. If all components disappear, that is if $M_{i+1} = \emptyset$, we shall say that the surgical solution becomes *extinct* at time t_{i+1} . In that case, it is straightforward to reconstruct the topology of the original manifold M_0 as a connected sum of the disappearing components (cf. Proposition 2.3 below.) Since \mathbf{R}^3 , $S^2 \times \mathbf{R}$ and punctured RP^3 's are themselves connected sums of spherical manifolds (in fact infinite copies of S^3 and RP^3), the upshot is that M_0 is a connected sum of spherical manifolds and copies of $S^2 \times S^1$.

A simplified version of our main technical result follows.

Theorem 1.2. *Let M be an orientable 3-manifold. Let g_0 be a complete riemannian metric on M which has bounded geometry. Then there exists a complete surgical solution of bounded geometry defined on $[0, +\infty)$, with initial condition (M, g_0) .*

When in addition we assume that g_0 has uniformly positive scalar curvature, we get (from the maximum principle and the condition that surgeries do not decrease R_{\min}) an *a priori* lower bound for R_{\min} which goes to infinity in finite time. This implies that surgical solutions given by Theorem 1.2 are automatically extinct. As a consequence, any 3-manifold satisfying the hypotheses of Theorem 1.1 is a connected sum of spherical manifolds and copies of $S^2 \times S^1$. However, we also need to prove finiteness of the summands up to diffeomorphism. Below we state a more precise result, which will suffice for our needs.

We say that a riemannian metric g_1 is ε -*homothetic* to some riemannian metric g_2 if there exists $\lambda > 0$ such that λg_1 is ε -close to g_2 in the $C^{[\varepsilon^{-1}]+1}$ -topology. A riemannian metric which is ε -homothetic to a round metric (i.e. a metric of constant sectional curvature 1) is said to be ε -*round*.

Theorem 1.3. *For all $\rho_0, T > 0$ there exist $Q, \rho > 0$ such that if (M_0, g_0) is a complete riemannian orientable 3-manifold which has sectional curvature bounded in absolute value by 1 and injectivity radius greater than or equal to ρ_0 , then there exists a complete surgical solution defined on $[0, T]$, with initial condition (M_0, g_0) , sectional curvature bounded in absolute value by Q and injectivity radius greater than or equal to ρ and such that all spherical disappearing components have scalar curvature at least 1, and are 10^{-3} -round or diffeomorphic to S^3 or RP^3 .*

Let us explain why this stronger conclusion implies that there are only finitely many disappearing components up to diffeomorphism. By definition, nonspherical disappearing components belong to a finite number of diffeomorphism classes. Now by the Bonnet-Myers theorem, 10^{-3} -round components

with scalar curvature at least 1 have diameter bounded above by some universal constant. Putting this together with the bounds on sectional curvatures and injectivity radius, the assertion then follows from Cheeger's finiteness theorem.

Remark that there is an apparent discrepancy between Theorems 1.2 and 1.3 in that in the former, the surgical solution is defined on $[0, +\infty)$ whereas in the latter it is only defined on a compact interval. However, Theorem 1.2 can be formally deduced from Theorem 1.3 via iteration and rescalings (cf. remark at the end of Section 2.)

Throughout the paper, we use the following convention:

All 3-manifolds considered here are orientable.

Here is a concise description of the content of the paper: in Section 2, we give some definitions, in particular the formal definition of surgical solutions, and show how to deduce Theorem 1.1 from Theorem 1.3. The remainder of the article (except the last section) is devoted to the proof of Theorem 1.3. In Section 3, we discuss Hamilton-Ivey curvature pinching, the standard solution, and prove the Metric Surgery Theorem, which allows to perform surgery. In Section 4, we recall some definitions and results on κ -noncollapsing, κ -solutions, and canonical neighbourhoods, and fix some constants that will appear throughout the rest of the proof.

In Section 5, we introduce the important notion of (r, δ, κ) -surgical solutions. These are special surgical solutions satisfying various estimates, and with surgery performed in a special way, according to the construction of Section 3. We state an existence theorem for those solutions, Theorem 5.3, which implies Theorem 1.3. Then we reduce Theorem 5.3 to three propositions, called A, B, and C. Sections 6 through 10 are devoted to the proofs of Propositions A, B, C, together with some technical results that are needed in these proofs.

Section 11 deals with generalisations of Theorem 1.3. One of them is an equivariant version, Theorem 11.2, which implies a classification of 3-manifolds admitting metrics of uniformly positive scalar curvature whose universal cover has bounded geometry. We note that equivariant Ricci flow with surgery in the case of finite group actions on closed 3-manifolds has been studied by J. Dinkelbach and B. Leeb [DL09]. We follow in part their discussion; however, things are much simpler in our case, since we are mainly interested in the case of *free* actions. We also give a version of Theorem 5.3 with extra information on the long time behaviour. This may be useful for later applications. Finally, we review some global and local compactness results for Ricci flows in two appendices.

Acknowledgements The authors wish to thank the Agence Nationale de la Recherche for its support under the programs F.O.G. (ANR-07-BLAN-0251-01) and GROUPES (ANR-07-BLAN-0141). The third author thanks the Institut de Recherche Mathématique Avancée, Strasbourg who appointed him while this work was done.

We warmly thank Joan Porti for numerous fruitful exchanges. The idea of generalising Perelman’s work to open manifolds was prompted by conversations with O. Biquard and T. Delzant. We also thank Ch. Boehm, J. Dinkelbach, B. Leeb, T. Schick, B. Wilking and H. Weiss.

2 Surgical solutions

Let M be a possibly noncompact, possibly disconnected (orientable) 3-manifold.

2.1 Definitions

Definition. Let $I \subset \mathbf{R}$ be an interval. An *evolving Riemannian manifold* is a pair $\{(M(t), g(t))\}_{t \in I}$ where for each t , $M(t)$ is a (possibly empty, possibly disconnected) manifold and $g(t)$ a riemannian metric on $M(t)$. We say that it is *piecewise \mathcal{C}^1 -smooth* if there exists $J \subset I$, which is discrete as a subset of \mathbf{R} , such that the following conditions are satisfied:

- i. On each connected component of $I \setminus J$, $t \mapsto M(t)$ is constant, and $t \mapsto g(t)$ is \mathcal{C}^1 -smooth.
- ii. For each $t_0 \in J$, $M(t_0) = M(t)$ for any $t < t_0$ sufficiently close to t_0 and $t \rightarrow g(t)$ is left continuous at t_0 .
- iii. For each $t_0 \in J \setminus \{\sup I\}$, $t \rightarrow (M(t), g(t))$ has a right limit at t_0 , denoted $(M_+(t_0), g_+(t_0))$

A time $t \in I$ is *regular* if t has a neighbourhood in I where $M(\cdot)$ is constant and $g(\cdot)$ is \mathcal{C}^1 -smooth. Otherwise it is *singular*.

Definition. A piecewise \mathcal{C}^1 -smooth evolving Riemannian 3-manifold $\{(M(t), g(t))\}_{t \in I}$ is a *surgical solution* of the Ricci Flow equation

$$\frac{dg}{dt} = -2 \operatorname{Ric}_{g(t)} \tag{1}$$

if the following statements hold:

- i. Equation (1) is satisfied at all regular times;

- ii. For each singular time t we have $R_{\min}(g_+(t)) \geq R_{\min}(g(t))$;
- iii. For each singular time t there is a locally finite collection \mathcal{S} of disjoint embedded 2-spheres in $M(t)$ and a manifold M' such that
 - (a) M' is obtained from $M(t) \setminus \mathcal{S}$ by capping-off 3-balls;
 - (b) $M_+(t)$ is a union of connected components of M' and $g(t) = g_+(t)$ on $M(t) \cap M_+(t)$;
 - (c) Each component of $M' \setminus M_+(t)$ is spherical, or diffeomorphic to \mathbf{R}^3 , $S^2 \times S^1$, $S^2 \times \mathbf{R}$, $RP^3 \# RP^3$ or a punctured RP^3 .

A component of $M' \setminus M_+(t)$ is said to *disappear at time t* .

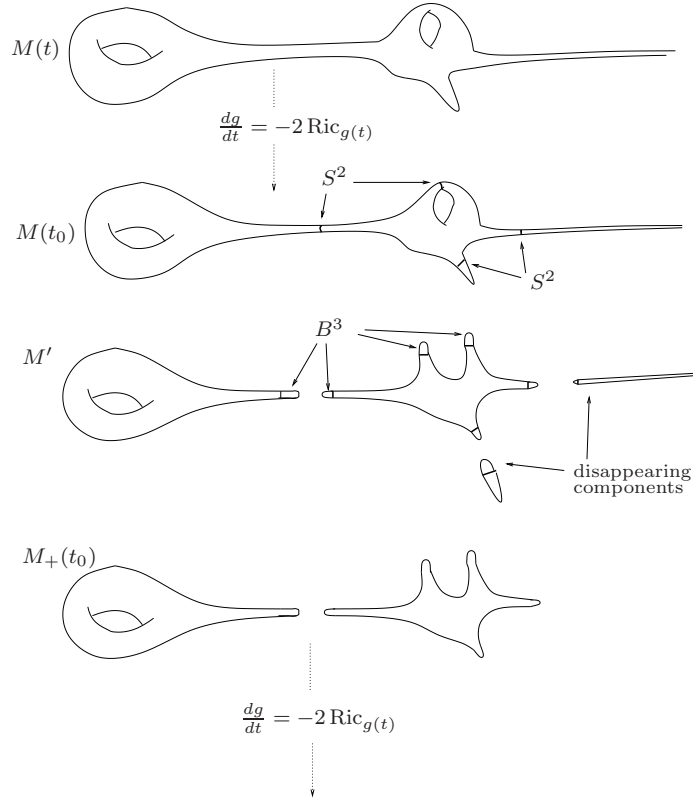

An evolving riemannian manifold $\{(M(t), g(t))\}_{t \in I}$ is *complete* (resp. *has bounded geometry*) if for each $t \in I$ such that $M(t) \neq \emptyset$, the riemannian manifold $(M(t), g(t))$ is complete (resp. *has bounded geometry*).

2.2 Deduction of Theorem 1.1 from Theorem 1.3

The purpose of this subsection is to explain how to deduce Theorem 1.1 from Theorem 1.3. For this, we need a result about the evolution of R_{\min} in

a surgical solution. For convenience, we take the convention that $R_{\min}(t)$ is $+\infty$ if $M(t)$ is empty.

Proposition 2.1. *Let $(M(\cdot), g(\cdot))$ be a complete 3-dimensional surgical solution with bounded sectional curvature defined on an interval $[0, T)$. Assume that $R_{\min}(0) \geq 0$. Then*

$$R_{\min}(t) \geq \frac{R_{\min}(0)}{1 - 2tR_{\min}(0)/3}.$$

Proof. Follows from the evolution equation for scalar curvature, the maximum principle for complete Ricci flows of bounded curvature [CLN06, Corollary 7.45] and the assumption that the minimum of scalar curvature is non-decreasing at singular times of surgical solutions. \square

Corollary 2.2. *For every $R_0 > 0$ there exists $T = T(R_0)$ such that the following holds. Let $(M(\cdot), g(\cdot))$ be a complete 3-dimensional surgical solution defined on $[0, T]$, with bounded sectional curvature, and such that $R_{\min}(0) \geq R_0$. Then $(M(\cdot), g(\cdot))$ is extinct.*

We now recall the definition of *capping-off 3-balls* to a 3-manifold.

Definition. Let M, M' be 3-manifolds. Let \mathcal{S} be a locally finite collection of embedded 2-spheres in M . One says that M' is obtained from $M \setminus \mathcal{S}$ by *capping-off 3-balls* if there exists a collection \mathcal{B} of 3-balls such that M' is the disjoint union

$$M' = M \setminus \mathcal{S} \bigsqcup \mathcal{B},$$

where each $S \in \mathcal{S}$ has a tubular neighbourhood $V \subset M$ such that $V \setminus S$ has two connected components V_-, V_+ and there exists $B_-, B_+ \in \mathcal{B}$ such that $V_- \bigsqcup B_-$ and $V_+ \bigsqcup B_+$ are 3-balls in M' . Conversely, each $B \in \mathcal{B}$ is included in such a 3-ball of M' .

Note that it is implicit in the above definition that there is an orientation preserving diffeomorphism, say $\phi_- : \partial B_- \rightarrow S \subset \partial V_-$, such that identifying ∂B_- to the corresponding boundary of V_- one obtains a 3-ball. From [Sma59], the differentiable structure of M' does not depend of the above diffeomorphisms. Moreover, if M' and M'' are obtained from $M \setminus \mathcal{S}$ by capping off 3-balls, one can choose the diffeomorphism from M' to M'' to be the identity on $M \cap M' = M \cap M''$.

We shall need the following topological lemma:

Proposition 2.3. *Let \mathcal{X} be a class of closed 3-manifolds. Let M be a 3-manifold. Suppose that there exists a finite sequence of 3-manifolds*

M_0, M_1, \dots, M_p such that $M_0 = M$, $M_p = \emptyset$, and for each i , M_i is obtained from M_{i-1} by splitting along a locally finite collection of pairwise disjoint, embedded 2-spheres, capping off 3-balls, and removing some components which are connected sums of members of \mathcal{X} . Then each component of M is a connected sum of members of \mathcal{X} .

Proof. We prove the result by induction on p . The case $p = 1$ is immediate from the definition of a connected sum.

Supposing that the proposition is true for some p , we consider a sequence M_0, M_1, \dots, M_{p+1} such that $M_0 = M$, $M_{p+1} = \emptyset$, and for each i , M_i is obtained from M_{i-1} by splitting along a locally finite collection of 2-spheres, capping off 3-balls, and removing some components which are connected sums of members of \mathcal{X} . By the induction hypothesis, M_1 is a connected sum of members of \mathcal{X} .

Let \mathcal{S} be the collection of 2-spheres involved in the process of turning M_0 into M_1 . Let \mathcal{B} be the collection of capped-off 3-balls. Let \mathcal{S}' be the collection of 2-spheres involved in the connected sum decomposition of M_1 . If $\mathcal{B} \cap \mathcal{S}'$ is empty, then the spheres of \mathcal{S}' actually live in M_0 , and the union of \mathcal{S} and \mathcal{S}' splits M_0 into prime summands homeomorphic to members of \mathcal{X} . This observation reduces our proof to the following claim:

Claim. \mathcal{S}' can be made disjoint from \mathcal{B} by an ambient isotopy.

Let us prove the claim. For each component B_i of \mathcal{B} , we fix a 3-ball B'_i contained in the interior of B_i and disjoint from \mathcal{S}' , and a collar neighbourhood U_i of ∂B_i in $M_1 \setminus B_i$. Since $\{B_i\}$ is locally finite, we may ensure that the U_i 's are pairwise disjoint. Choose an ambient isotopy of M_1 which takes B'_i onto B_i and B_i onto $B_i \cup U_i$ for each i . Then after this ambient isotopy, \mathcal{S}' is still locally finite, and is now disjoint from \mathcal{B} . \square

To see why these results imply Theorem 1.1, take a 3-manifold M and a complete metric g_0 of bounded geometry and uniformly positive scalar curvature on M . By rescaling if necessary we can assume that the bound on the curvature is 1. From the positive lower bound on $R_{\min}(g_0)$ we get an *a priori* upper bound T for the extinction time of a surgical solution, using Corollary 2.2. Applying Theorem 1.3, we get numbers Q, ρ and a surgical solution $(M(\cdot), g(\cdot))$ with initial condition (M, g_0) defined on $[0, T]$ satisfying the two additional conditions. This solution is extinct, and as we have already explained in the introduction, the disappearing components are connected sums of spherical manifolds and copies of $S^2 \times S^1$, the summands belonging to some finite collection which depends only on the bounds on the geometry. Let \mathcal{X} be the collection of prime factors of the disappearing components. Let $0 = t_0 < t_1 < t_2 < \dots < t_p = T$ be a set of regular

times of $(M(\cdot), g(\cdot))$ such that there is exactly one singular time between each pair of consecutive t_i 's. The conclusion of Theorem 1.1 now follows from Proposition 2.3 applied with $M_i = M(t_i)$.

2.3 More definitions

Notation Let $n \geq 2$ be an integer and (M, g) be a riemannian n -manifold.

For any $x \in M$, we denote by $\text{Rm}(x) : \Lambda^2 T_x M \rightarrow \Lambda^2 T_x M$ the curvature operator, and $|\text{Rm}(x)|$ its norm, which is also the maximum of the absolute values of the sectional curvatures at x . We let $R(x)$ denote the scalar curvature of x . The infimum (resp. supremum) of the scalar curvature of g on M is denoted by $R_{\min}(g)$ (resp. $R_{\max}(g)$).

We write $d : M \times M \rightarrow [0, \infty)$ for the distance function associated to g . For $r > 0$ we denote by $B(x, r)$ the open ball of radius r around x . Finally, if x, y are points of M , we denote by $[xy]$ a geodesic segment connecting x to y . This is a (common) abuse of notation, since such a segment is not unique in general.

For closeness of metrics we adopt the conventions of [BBB⁺, Section 0.6.1].

Let $\{(M(t), g(t))\}_{t \in I}$ be a surgical solution and $t \in I$. If t is singular, one sets $M_{\text{reg}}(t) := M(t) \cap M_+(t)$ and denotes by $M_{\text{sing}}(t)$ its complement, i.e. $M_{\text{sing}}(t) := M(t) \setminus M_{\text{reg}}(t) = M(t) \setminus M_+(t)$. If t is regular, then $M_{\text{reg}}(t) = M(t)$ and $M_{\text{sing}}(t) = \emptyset$.

At a singular time, connected components of $M_{\text{sing}}(t)$ belong to three types:

- i. components of $M(t)$ which are disappearing components of M' ,
- ii. closures of components of $M(t) \setminus \mathcal{S}$ which give, after being capped-off, disappearing components of M' , and
- iii. embedded 2-spheres of \mathcal{S} .

In particular, the boundary of $M_{\text{sing}}(t)$ is contained in \mathcal{S} .

We say that a pair $(x, t) \in M \times I$ is *singular* if $x \in M_{\text{sing}}(t)$; otherwise we call (x, t) *regular*.

Definition. Let t_0 be a time, $[a, b]$ be an interval containing t_0 and X be a subset of $M(t_0)$ such that for every $t \in [a, b]$, we have $X \subset M_{\text{reg}}(t)$. Then the set $X \times [a, b]$ is *unscathed*. Otherwise, we say that X is *scathed*.

Remarks.

- 1) In the definition of ‘unscathed’, we allow the final time slice to contain singular points, i.e. we may have $X \cap M_{\text{sing}}(b) \neq \emptyset$. The point is that if $X \times [a, b]$ is unscathed, then $t \mapsto g(t)$ evolves smoothly by the Ricci flow equation on all of $X \times [a, b]$.
- 2) Assume that $X \times [a, b]$ is scathed. Then there is $t \in [a, b)$ and $x \in X$ such that $x \notin M_{\text{reg}}(t)$. Assume that t is closest to t_0 with this property. If $t > t_0$ then $x \in M_{\text{sing}}(t)$ and disappears at time t unless $x \in \partial M_{\text{sing}}(t)$ or if the component of $M_{\text{sing}}(t)$ which contains x is a sphere $S \in \mathcal{S}$. If $t < t_0$, then $x \in M_+(t) \setminus M_{\text{reg}}(t)$ is in one of the 3-balls that are added at time t .

Notation For $t \in I$ and $x \in M(t)$ we use the notation $\text{Rm}(x, t)$, $R(x, t)$ to denote the curvature operator and the scalar curvature respectively. For brevity we set $R_{\min}(t) := R_{\min}(g(t))$ and $R_{\max}(t) := R_{\max}(g(t))$.

We use $d_t(\cdot, \cdot)$ for the distance function associated to $g(t)$. The ball of radius ρ around x for $g(t)$ is denoted by $B(x, t, \rho)$.

For the definition of closeness of evolving riemannian manifolds, we refer to [BBB⁺, Section 0.6.2.].

Definition. Let $t_0 \in I$ and $Q > 0$. The *parabolic rescaling* with factor Q at time t_0 is the evolving manifold $\{(\bar{M}(t), \bar{g}(t))\}$ where $\bar{M}(t) = M(t_0 + t/Q)$, and

$$\bar{g}(t) = Q g(t_0 + \frac{t}{Q}).$$

Finally we remark that Theorem 1.2 follows by iteration of Theorem 1.3 via parabolic rescalings. Hence in the sequel, we focus on proving Theorem 1.3.

3 Metric surgery

3.1 Curvature pinched toward positive

Let (M, g) be a 3-manifold and $x \in M$ be a point. We denote by $\lambda(x) \geq \mu(x) \geq \nu(x)$ the eigenvalues of the curvature operator $\text{Rm}(x)$. By our definition, all sectional curvatures lie in the interval $[\nu(x), \lambda(x)]$. Moreover, $\lambda(x)$ (resp. $\nu(x)$) is the maximal (resp. minimal) sectional curvature at x . If C is a real number, we sometimes write $\text{Rm}(x) \geq C$ instead of $\nu(x) \geq C$. Likewise, $\text{Rm}(x) \leq C$ means $\lambda(x) \leq C$.

It follows that the eigenvalues of the Ricci tensor are equal to $\lambda + \mu$, $\lambda + \nu$, and $\mu + \nu$; as a consequence, the scalar curvature $R(x)$ is equal to $2(\lambda(x) + \mu(x) + \nu(x))$.

For evolving metrics, we use the notation $\lambda(x, t)$, $\mu(x, t)$, and $\nu(x, t)$, and correspondingly write $\text{Rm}(x, t) \geq C$ for $\nu(x, t) \geq C$, and $\text{Rm}(x, t) \leq C$ for $\lambda(x, t) \leq C$.

Let ϕ be a nonnegative function. A metric g on M has ϕ -almost nonnegative curvature if $\text{Rm} \geq -\phi(R)$.

Now we consider a family of positive functions $(\phi_t)_{t \geq 0}$ defined as follows. Set $s_t := \frac{e^2}{1+t}$ and define $\phi_t : [-2s_t, +\infty) \rightarrow [s_t, +\infty)$ as the reciprocal of the function $s \mapsto 2s(\ln(s) + \ln(1+t) - 3)$.

Following [MT07], we use the following definition.

Definition. Let $I \subset [0, \infty)$ be an interval, $t_0 \in I$ and $\{g(t)\}_{t \in I}$ be an evolving metric on M . We say that $g(\cdot)$ has *curvature pinched toward positive at time t_0* if for all $x \in M$ we have

$$R(x, t_0) \geq -\frac{6}{4t_0 + 1}, \quad (2)$$

$$\text{Rm}(x, t_0) \geq -\phi_{t_0}(R(x, t_0)). \quad (3)$$

We say that $g(\cdot)$ has *curvature pinched toward positive* if it has curvature pinched toward positive at each $t \in I$.

Remark that if $|\text{Rm}(g(0))| \leq 1$, then $g(\cdot)$ has curvature pinched toward positive at time 0. Next we state a result due to Hamilton and Ivey in the compact case. For a proof of the general case, see [CCG⁺08, Section 5.1].

Proposition 3.1 (Hamilton-Ivey pinching estimate). *Let a, b be two real numbers such that $0 \leq a < b$. Let $(M, \{g(t)\}_{t \in [a, b]})$ be a complete Ricci flow with bounded curvature. If $g(\cdot)$ has curvature pinched toward positive at time a , then $\{g(t)\}_{t \in [a, b]}$ has curvature pinched toward positive.*

The following easy lemmas will be useful.

Lemma 3.2. *i) $\phi_t(s) = \frac{\phi_0((1+t)s)}{1+t}$.*

ii) $\frac{\phi_t(s)}{s}$ decreases to 0 as s tends to $+\infty$.

iii) $\frac{\phi_0(s)}{s} = \frac{1}{4}$ if $s = 4e^5$.

Proof. [BBB⁺, Lemma 2.4.6] □

The main purpose of Property ii) is to ensure that limits of suitably rescaled evolving metrics with curvature pinched toward positive have non-negative curvature operator (see Proposition 6.4). In the sequel we set $\bar{s} := 4e^5$.

Lemma 3.3 (Pinching Lemma). *Assume that $g(\cdot)$ has curvature pinched toward positive and let $t \geq 0$, $r > 0$ be such that $(1+t)r^{-2} \geq \bar{s}$. If $R(x, t) \leq r^{-2}$ then $|\text{Rm}(x, t)| \leq r^{-2}$.*

Proof. [BBB⁺, Lemma 2.4.7] □

3.2 The standard solution

We recall the definition we used in [BBB⁺] as initial condition of the standard solution. The functions f, u below are chosen in [BBB⁺, Section 5.1].

Definition. Let $d\theta^2$ denote the round metric of scalar curvature 1 on S^2 .

The *initial condition of the standard solution* is the riemannian manifold $\mathcal{S}_0 = (\mathbf{R}^3, \bar{g}_0)$, where the metric \bar{g}_0 is given in polar coordinates by:

$$\bar{g}_0 = e^{-2f(r)} g_u,$$

where

$$g_u = dr^2 + u(r)^2 d\theta^2.$$

We also define $\mathcal{S}_u := (\mathbf{R}^3, g_u)$. The origin of \mathbf{R}^3 , which is also the centre of spherical symmetry, will be denoted by p_0 .

In particular, $(B(0, 5), \bar{g}_0)$ has positive sectional curvatures (see [BBB⁺, Lemma 5.1.2]), and the complement of $B(0, 5)$ is isometric to $S^2 \times [0, +\infty)$.

Ricci flow with initial condition \mathcal{S}_0 has a maximal solution defined on $[0, 1)$, which is unique among complete flows of bounded sectional curvature [Per03b]. This solution is called the *standard solution*.

The *standard ε -neck* is the riemannian product $S^2 \times (-\varepsilon^{-1}, \varepsilon^{-1})$, where the S^2 factor is round of scalar curvature 1. Its metric is denoted by g_{cyl} . We fix a basepoint $*$ in $S^2 \times \{0\}$.

Definition. Let (M, g) be a riemannian 3-manifold and x be a point of M . A neighbourhood $N \subset M$ of x is called an *ε -neck centred at x* if (N, g, x) is ε -homothetic to $(S^2 \times (-\varepsilon^{-1}, \varepsilon^{-1}), g_{\text{cyl}}, *)$.

If N is an ε -neck and $\psi : N_\varepsilon \rightarrow N$ is a *parametrisation*, i.e. a diffeomorphism such that some rescaling of $\psi^*(g)$ is ε -close to g_{cyl} , then the sphere $\psi(S^2 \times \{0\})$ is called a *middle sphere* of N .

Definition. Let δ, δ' be positive numbers. Let g be a riemannian metric on M . Let (U, V, p, y) be a 4-tuple such that U is an open subset of M , V is a compact subset of U , $p \in \text{Int}V$, $y \in \partial V$. Then (U, V, p, y) is called a *marked (δ, δ') -almost standard cap* if there exists a δ' -isometry $\psi : B(p_0, 5 + \delta^{-1}) \rightarrow (U, R(y)g)$, sending $B(p_0, 5)$ to $\text{Int}V$ and p_0 to p . One calls V the *core* and p the *tip*.

3.3 The metric surgery theorem

Theorem 3.4 (Metric surgery). *There exist $\delta_0 > 0$ and a function $\delta' : (0, \delta_0] \ni \delta \mapsto \delta'(\delta) \in (0, \varepsilon_0/10]$ tending to zero as $\delta \rightarrow 0$, with the following property:*

Let ϕ be a nondecreasing, positive function; let $\delta \leq \delta_0$; let (M, g) be a riemannian 3-manifold with ϕ -almost nonnegative curvature, and $\{N_i\}$ be a locally finite collection of pairwise disjoint δ -necks in M . Let M' be a manifold obtained by cutting M along the middle spheres of the N_i 's and capping off 3-balls.

Then there exists a riemannian metric g_+ on M' such that:

- i. $g_+ = g$ on $M' \cap M$;*
- ii. For each component B of $M' \setminus M$, there exist $p \in \text{Int}B$ and $y \in \partial B$ such that $(N' \cup B, B, p, y)$ is a marked $(\delta, \delta'(\delta))$ -almost standard cap with respect to g_+ , where N' is the 'half' of N adjacent to B in M' ;*
- iii. g_+ has ϕ -almost nonnegative curvature.*

Remark. In the application of the above theorem, M_+ will be a submanifold of M' .

Proof. On $M' \cap M$ we set $g_+ := g$. On the added 3-balls we define g_+ as follows. Let $N \subset M$ be one of the δ -necks of the collection, and let S be its middle sphere. By definition there exists a diffeomorphism $\psi : S^2 \times (-\delta^{-1}, \delta^{-1}) \rightarrow N$ and a real number $\lambda > 0$ such that $\|\psi^* \lambda g - g_{\text{cyl}}\| < \delta$ in the $C^{[\delta^{-1}] + 1}$ -norm (see [BBB⁺] for the details). Note that for each $y \in N$ we have that $\lambda/R(y)$ is δ' -close to 1 for some universal $\delta'(\delta)$ tending to zero with δ .

Define $N_+ := \psi(S^2 \times [0, \delta^{-1}))$, i.e. N_+ is the right half of the neck. Let $\Sigma \subset M' \setminus M$ be the 3-ball that is capped-off to it and $\Phi : \partial\Sigma \rightarrow \partial N_+$ be the corresponding diffeomorphism. Our goal is to define g_+ on Σ in such a way that $(N_+ \cup_{\Phi} \Sigma, g_+)$ is a $(\delta, \delta'(\delta))$ -almost standard cap with ϕ -almost nonnegative curvature.

Let us introduce more notation. For $0 \leq r_1 \leq r_2$, we let $C[r_1, r_2]$ denote the annular region of \mathbf{R}^3 defined by the inequations $r_1 \leq r \leq r_2$ in polar coordinates. Observe that for all $3 \leq r_1 < r_2$, the restriction of g_u to $C[r_1, r_2]$ is isometric to the cylinder $S^2 \times [r_1, r_2]$ with scalar curvature 1. We consider $B := B(0, 5) \subset \mathcal{S}_u$.

Set $V_- := \psi(S^2 \times (-2, 0])$ and $V_+ := \psi(S^2 \times [0, 2))$. Restrict ψ on $S^2 \times (-2, \delta^{-1})$ to $V_- \cup N_+$, where $S^2 \times (-2, \delta^{-1})$ is now considered as the annulus $C(3, 5 + \delta^{-1}) \subset \mathcal{S}_u$.

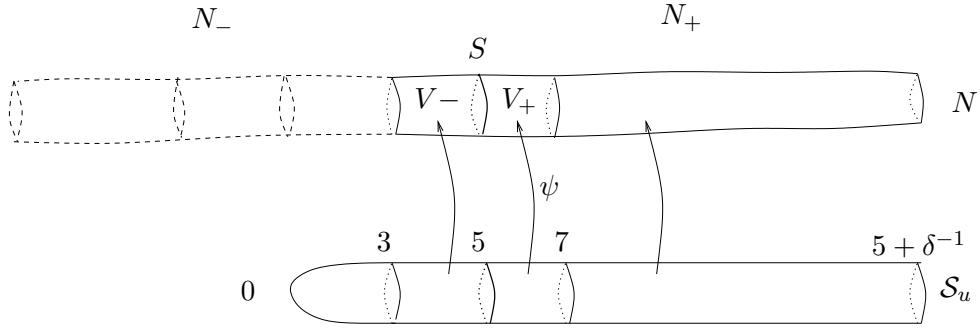

Let $\bar{g} := \psi^*(\lambda g)$ be the pulled-back rescaled metric on $C(3, 5 + \delta^{-1})$. Note that $\|\bar{g} - g_u\| < \delta$ on this set and that \bar{g} has ϕ -almost nonnegative curvature.

On $B(0, 5 + \delta^{-1})$ we define in polar coordinates

$$\bar{g}_+ := e^{-2f} (\chi g_u + (1 - \chi)\bar{g}) = \chi \bar{g}_0 + (1 - \chi)e^{-2f}\bar{g}$$

where $\chi : [0, 5 + \delta^{-1}] \rightarrow [0, 1]$ is a smooth function satisfying

$$\begin{cases} \chi \equiv 1 & \text{on } [0, 3] \\ \chi' < 0 & \text{on } (3, 4) \\ \chi \equiv 0 & \text{on } [4, 5 + \delta^{-1}]. \end{cases}$$

Note that

$$\begin{cases} \bar{g}_+ = \bar{g}_0 & \text{on } B(0, 3) \\ \bar{g}_+ = e^{-2f}\bar{g} & \text{on } C[4, 5] \\ \bar{g}_+ = \bar{g} & \text{on } C[5, 5 + \delta^{-1}]. \end{cases}$$

Finally set

$$\begin{cases} g_+ := (\psi^{-1})^*(\lambda^{-1}\bar{g}) = g & \text{on } N_+ \\ g_+ := \lambda^{-1}\bar{g}_+ & \text{on } B(0, 5). \end{cases}$$

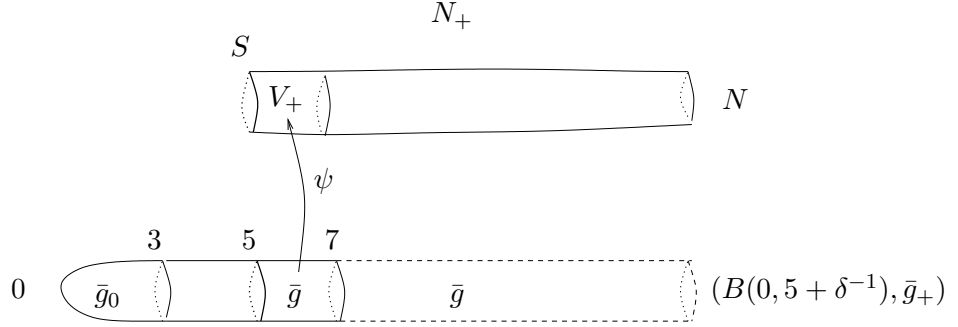

Let p be the origin and y be an arbitrary point of ∂B . There remains to show that $((N_+ \cup_{\psi|_{\partial B}} B, B, p, y), g_+)$ is a $(\delta, \delta'(\delta))$ -almost standard cap, and has ϕ -almost nonnegative curvature. It suffices clearly to consider g_+ on B , or \bar{g}_+ on $B(0, 5)$. This is tackled by the following proposition ([BBB⁺, Proposition 5.2.2]), applied to \bar{g} with the rescaled pinching function $s \mapsto \lambda^{-1}\phi(\lambda s)$:

Proposition 3.5. *There exists $\delta_1 > 0$ and a function $\delta' : (0, \delta_1] \rightarrow (0, \frac{\varepsilon_0}{10}]$ with limit zero at zero, having the following property: let ϕ be a nondecreasing positive function, $0 < \delta \leq \delta_1$ and \bar{g} be a metric on $C(3, 5) \subset \mathbf{R}^3$, with ϕ -almost nonnegative curvature, such that $\|\bar{g} - g_u\|_{C^{\lfloor \frac{1}{\delta} \rfloor + 1}} < \delta$ on $C(3, 5)$. Then the metric*

$$\bar{g}_+ = e^{-2f} (\chi g_u + (1 - \chi)\bar{g})$$

has ϕ -almost nonnegative curvature, and is $\delta'(\delta)$ -close to \bar{g}_0 on $B(0, 5)$.

Setting $\delta_0 := \delta_1$ completes the proof of Theorem 3.4. \square

4 κ -noncollapsing and canonical neighbourhoods

4.1 κ -noncollapsing

Let $\{(M(t), g(t))\}_{t \in I}$ be an evolving riemannian manifold. We say that a pair (x, t) is a *point in spacetime* if $t \in I$ and $x \in M(t)$. For convenience we denote by \mathcal{M} the set of all such points. A (backward) *parabolic neighbourhood* of a point (x, t) in spacetime is a set of the form

$$P(x, t, r, -\Delta t) := \{(x', t') \in \mathcal{M} \mid x' \in B(x, t, r), t' \in [t - \Delta t, t]\}.$$

In particular, the set $P(x, t, r, -r^2)$ is called a *parabolic ball* of radius r .

A parabolic neighbourhood $P(x, t, r, -\Delta t)$ is *unscathed* if $B(x, t, r) \times [t - \Delta t, t]$ is unscathed. In this case $P(x, t, r, -\Delta t) = B(x, t, r) \times [t - \Delta t, t]$.

Definition. Fix $\kappa, r > 0$. We say that $(M(\cdot), g(\cdot))$ is κ -collapsed at (x, t) on the scale r if for all $(x', t') \in P(x, t, r, -r^2)$ one has $|\text{Rm}(x', t')| \leq r^{-2}$, and $\text{vol}B(x, t, r) < \kappa r^n$. Otherwise, $(M(\cdot), g(\cdot))$ is κ -noncollapsed at (x, t) on the scale r .

We say that $(M(\cdot), g(\cdot))$ is κ -noncollapsed on the scale r if it is κ -noncollapsed on this scale at every point of \mathcal{M} .

4.2 Canonical neighbourhoods

Definition. Let (M, g) be a riemannian 3-manifold and x be a point of M . We say that U is an ε -cap centred at x if U is the union of two sets V, W such that $x \in \text{Int}V$, V is diffeomorphic to B^3 or $RP^3 \setminus B^3$, $\overline{W} \cap V = \partial V$, and W is an ε -neck. A subset V as above is called a *core* of U .

Let $\varepsilon > 0$, $C \gg \varepsilon^{-1}$, $\{(M(t), g(t))\}_{t \in I}$ be an evolving riemannian manifold and (x_0, t_0) be a point in spacetime.

We call *cylindrical flow* the manifold $S^2 \times \mathbf{R}$ together with the product flow on $(-\infty, 0]$, where the first factor is round, normalised so that the scalar curvature at time 0 is identically 1. We denote this evolving metric by $g_{\text{cyl}}(t)$.

Definition. An open subset $N \subset M(t_0)$ is called a *strong ε -neck*³ centred at (x_0, t_0) if there is a number $Q > 0$ such that $(N, \{g(t)\}_{t \in [t_0 - Q^{-1}, t_0]}, x_0)$ is unscathed, and after parabolic rescaling with factor Q at time t_0 , ε -close to $(S^2 \times (-\varepsilon^{-1}, \varepsilon^{-1}), \{g_{\text{cyl}}(t)\}_{t \in [-1, 0]}, *)$.

Remark. Let $Q > 0$, and consider the flow $(S^2 \times \mathbf{R}, Qg_{\text{cyl}}(tQ^{-1}))$ restricted to $(-Q, 0]$. Then for every $x \in S^2 \times \mathbf{R}$ and every $\varepsilon > 0$, the point $(x, 0)$ is centre of a strong ε -neck.

We recall that ε -round means ε -homothetic to a metric of positive constant sectional curvature.

Definition. Let $U \subset M(t)$ be an open subset and $x \in U$ such that $R(x) := R(x, t) > 0$. One says that U is an (ε, C) -canonical neighbourhood centred at (x, t) if:

- A. U is of a strong ε -neck centred at (x, t) , or
- B. U is an ε -cap centred at x for $g(t)$, or

³We use ‘strong neck’ to denote a subset of $M(t_0)$, rather than a subset of spacetime as other authors do.

C. $(U, g(t))$ has sectional curvatures $> C^{-1}R(x)$ and is diffeomorphic to S^3 or RP^3 , or

D. $(U, g(t))$ is ε -round,

and if moreover, the following estimates hold in cases A, B, C for $(U, g(t))$:
There exists $r \in (C^{-1}R(x)^{-\frac{1}{2}}, CR(x)^{-\frac{1}{2}})$ such that:

i. $\overline{B(x, r)} \subset U \subset B(x, 2r)$;

ii. The scalar curvature function restricted to U has values in a compact subinterval of $(C^{-1}R(x), CR(x))$;

iii. If $B(y, r) \subset U$ and if $|\text{Rm}| \leq r^{-2}$ on $B(y, r)$ then

$$C^{-1} < \frac{\text{vol}B(y, r)}{r^3} ; \quad (4)$$

iv.

$$|\nabla R(x)| < CR(x)^{\frac{3}{2}} , \quad (5)$$

v.

$$|\Delta R(x) + 2|\text{Ric}(x)|^2| < CR(x)^2 , \quad (6)$$

vi.

$$|\nabla \text{Rm}(x)| < C|\text{Rm}(x)|^{\frac{3}{2}} , \quad (7)$$

Remarks.

- In case D, Estimates (i)-(vi) hold except maybe (iii) (consider e.g. lens spaces.)
- (i) implies that $\text{diam } U$ is at most $4r$, which in turn is bounded above by a function of C and $R(x)$.
- (iii) implies that $\text{vol } U$ is bounded from below by $C^{-1}R(x)^{-3/2}$.
- Estimate (v) implies the following scale-invariant bound on the time-derivative of R (at a regular time):

$$\left| \frac{\partial R}{\partial t}(x, t) \right| < CR(x, t)^2. \quad (8)$$

- We call (ε, C) -cap any ε -cap of (M, g) which satisfies (i)-(vi),

- In cases C and D, U is diffeomorphic to a spherical manifold.
- Cases C and D are not mutually exclusive.
- Being the centre of an (ε, C) -canonical neighbourhood is an open property in spacetime: if $U \subset M(t)$ is unscathed on $(t - \alpha, t + \alpha)$ for some $\alpha > 0$, then there exists a neighbourhood Ω of (x, t) such that any $(x', t') \in \Omega$ is centre of an (ε, C) -canonical neighbourhood. In case A, one can use the same set $N = U$ and factor Q , but change the parametrisation so that the basepoint $*$ is sent to x rather than x_0 . Case B is similar. Cases C, D are obvious.
- The same argument shows that being the centre of an (ε, C) -canonical neighbourhood is also an open property with respect to a change of metric in the $C^{[\varepsilon^{-1}]}$ -topology.

4.3 Fixing the constants

In order to fix the constants, we recall some results of Perelman on κ -solutions and the standard solution.

Theorem 4.1. *For all $\varepsilon > 0$ there exists $C_{\text{sol}} = C_{\text{sol}}(\varepsilon)$ such that if $(M, \{g(t)\}_{t \in (-\infty, 0]})$ is a 3-dimensional κ -solution, then every $(x, t) \in M \times (-\infty, 0]$ is centre of an $(\varepsilon, C_{\text{sol}})$ -canonical neighbourhood.*

Proposition 4.2. *There exists $\kappa_{\text{st}} > 0$ such that the standard solution is κ_{st} -noncollapsed on all scales.*

Proposition 4.3. *For every $\varepsilon > 0$ there exists $C_{\text{st}}(\varepsilon) > 0$ such that if (x, t) is a point in the standard solution such that $t > 3/4$ or $x \notin B(p_0, 0, \varepsilon^{-1})$, then (x, t) has an $(\varepsilon, C_{\text{st}})$ -canonical neighbourhood. Moreover there is an estimate $R_{\min}(t) \geq \text{const}_{\text{st}}(1 - t)^{-1}$ for some constant $\text{const}_{\text{st}} > 0$.*

Next we recall two technical lemmas from [BBB⁺] which allow to fix universal constants ε_0 and β_0 .

Lemma 4.4. *There exists $\varepsilon_0 > 0$ such that the following holds. Let $\varepsilon \in (0, 2\varepsilon_0]$. Let (M, g) be a riemannian 3-manifold. Let y_1, y_2 be points of M . Let $U_1 \subset M$ be an ε -neck centred at y_1 with parametrisation $\psi_1 : S^2 \times (-\varepsilon^{-1}, \varepsilon^{-1}) \rightarrow U_1$ and middle sphere S_1 . Let $U_2 \subset M$ be a 10ε -neck centred at y_2 with middle sphere S_2 . Call $\pi : U_1 \rightarrow (-\varepsilon^{-1}, \varepsilon^{-1})$ the composition of ψ_1^{-1} with the projection of $S^2 \times (-\varepsilon^{-1}, \varepsilon^{-1})$ onto its second factor.*

Assume that $y_2 \in U_1$ and $|\pi(y_2)| \leq (2\varepsilon)^{-1}$. Then the following conclusions hold:

i. U_2 is contained in U_1 ;

ii. The boundary components of $\partial\overline{U_2}$ can be denoted by S_+, S_- in such a way that

$$\pi(S_-) \subset [\pi(y_2) - (10\varepsilon)^{-1} - 10, \pi(y_2) - (10\varepsilon)^{-1} + 10],$$

and

$$\pi(S_+) \subset [\pi(y_2) + (10\varepsilon)^{-1} - 10, \pi(y_2) + (10\varepsilon)^{-1} + 10];$$

iii. The spheres S_1, S_2 are isotopic in U_1 .

Proof. [BBB⁺, Lemma 1.2.1] □

Let K_{st} be the supremum of the sectional curvatures of the standard solution on $[0, 4/5]$.

Lemma 4.5. *For all $\varepsilon \in (0, 10^{-4})$ there exists $\beta = \beta(\varepsilon) \in (0, 1)$ such that the following holds.*

Let a, b be real numbers satisfying $a < b < 0$ and $|b| \leq 3/4$, let $(M, g(\cdot))$ be a surgical solution defined on $(a, 0]$, and $x \in M$ be a point such that:

- $R(x, b) = 1$;
- (x, b) is centre of a strong $\beta\varepsilon$ -neck;
- $P(x, b, (\beta\varepsilon)^{-1}, |b|)$ is unscathed and satisfies $|\text{Rm}| \leq 2K_{\text{st}}$.

Then $(x, 0)$ is centre of a strong ε -neck.

Proof. We can argue exactly as in [BBB⁺, Lemma 2.3.5.] □

Fix $\varepsilon_0 > 0$ so that Lemma 4.4 holds. Let $\beta := \beta(\varepsilon_0)$ be the constant given by Lemma 4.5. Finally, define $C_0 := \max(100, 2C_{\text{sol}}(\varepsilon_0/2), 2C_{\text{st}}(\beta\varepsilon_0/2))$.

Definition. Let $r > 0$. An evolving riemannian manifold $\{(M(t), g(t))\}_{t \in I}$ has property $(CN)_r$ if for all $(x, t) \in \mathcal{M}$, if $R(x, t) \geq r^{-2}$, then (x, t) admits an (ε_0, C_0) -canonical neighbourhood.

Definition. Let $\kappa > 0$. An evolving riemannian manifold $\{(M(t), g(t))\}_{t \in I}$ has property $(NC)_\kappa$ if it is κ -noncollapsed on all scales less than 1.

5 (r, δ, κ) -surgical solutions

5.1 Cutoff parameters and (r, δ) -surgery

Theorem 5.1 (Cutoff parameters). *For all $r, \delta > 0$, there exist $h \in (0, \delta r)$ and $D > 10$ such that if $(M(\cdot), g(\cdot))$ is a complete surgical solution of bounded curvature defined on an interval $[a, b]$, with curvature pinched toward positive and satisfying $(CN)_r$, then the following holds:*

Let $t \in [a, b]$ and $x, y, z \in M(t)$ such that $R(x, t) \leq 2/r^2$, $R(y, t) = h^{-2}$, and $R(z, t) \geq D/h^2$. Assume there is a curve γ connecting x to z via y , such that each point of γ with scalar curvature in $[2C_0r^{-2}, C_0^{-1}Dh^{-2}]$ is centre of an ε_0 -neck. Then (y, t) is centre of a strong δ -neck.

This will be proved in Section 6. In the sequel we fix functions $(r, \delta) \mapsto h(r, \delta)$ and $(r, \delta) \mapsto D(r, \delta)$ with the above property. We set $\Theta := 2Dh^{-2}$. This number will be used as a curvature threshold for the surgery process.

Definition. We say that two real numbers r, δ are *surgery parameters* if $0 < r < 10^{-3}$ and $0 < \delta < \min(\varepsilon_0, \delta_0)$. The *associated cutoff parameters* are $h := h(r, \delta)$, $D := D(r, \delta)$ and $\Theta := 2Dh^{-2}$.

From now on, we fix a function $\delta' : (0, \delta_0] \rightarrow (0, \varepsilon_0/10]$ as in the metric surgery theorem. A marked $(\delta, \delta'(\delta))$ -almost standard cap will be simply called a δ -almost standard cap. An open subset U of M is called a δ -almost standard cap if there exist V, p and y such that (U, V, p, y) is a δ -almost standard cap.

Definition. Fix surgery parameters r, δ and let h, D, Θ be the associated cutoff parameters. Let $\{(M(t), g(t))\}_{t \in I}$ be an evolving riemannian manifold. Let $t_0 \in I$ and (M_+, g_+) be a (possibly empty) riemannian manifold. We say that (M_+, g_+) is *obtained from $(M(\cdot), g(\cdot))$ by (r, δ) -surgery at time t_0* if the following conditions are satisfied:

- i. M_+ is obtained from $M(t_0)$ by cutting along a locally finite collection of disjoint 2-spheres, capping off 3-balls, and possibly removing some components that are spherical or diffeomorphic to \mathbf{R}^3 , $S^2 \times \mathbf{R}$, $RP^3 \setminus \{pt\}$, $RP^3 \# RP^3$, $S^2 \times S^1$. In addition, a spherical manifold U can only be removed if it is contained in $M(t_0)$, and $(U, g(t_0))$ is ε -round and satisfies $R \geq 1$;
- ii. For all $x \in M_+ \setminus M(t_0)$, there exists a δ -almost standard cap (U, V, p, y) in M_+ , such that
 - (a) $x \in V$;

- (b) $y \in M(t_0)$;
- (c) $R(y, t_0) = h^{-2}$;
- (d) (y, t_0) is centre of a strong δ -neck.

iii. $R_{\max}(g(t_0)) = \Theta$, and if $M_+ \neq \emptyset$, then $R_{\max}(g_+) \leq \Theta/2$.

Definition. Fix surgery parameters r, δ and let h, D, Θ be the associated cutoff parameters. Let $I \subset [0, \infty)$ be an interval and $\{(M(t), g(t))\}_{t \in I}$ be a surgical solution. We say that it is an (r, δ) -surgical solution if it has the following properties:

- i. It has curvature pinched toward positive and satisfies $R(x, t) \leq \Theta$ for all $(x, t) \in \mathcal{M}$;
- ii. For every singular time $t_0 \in I$, $(M_+(t_0), g_+(t_0))$ is obtained from $(M(\cdot), g(\cdot))$ by (r, δ) -surgery at time t_0 ;
- iii. Condition $(CN)_r$ holds.

Let $\kappa > 0$. An (r, δ) -surgical solution which in addition satisfies Condition $(NC)_\kappa$ will be called an (r, δ, κ) -surgical solution.

5.2 Existence theorem for (r, δ, κ) -surgical solutions

Theorem 1.3 is implied by the following result:

Theorem 5.2. *For every $\rho_0 > 0$ and $T \geq 0$, there exist $r, \delta, \kappa > 0$ such that for any complete riemannian 3-manifold (M_0, g_0) with $|\text{Rm}| \leq 1$ and injectivity radius at least ρ_0 , there exists an (r, δ, κ) -surgical solution defined on $[0, T]$ satisfying the initial condition $(M(0), g(0)) = (M_0, g_0)$.*

Theorem 5.2 is itself a special case of the following result, which has the advantage of being suitable for iteration:

Theorem 5.3. *For every $Q_0, \rho_0 > 0$ and all $0 \leq T_A < T_\Omega$, there exist $r, \delta, \kappa > 0$ such that for any complete riemannian 3-manifold (M_0, g_0) which satisfies $|\text{Rm}| \leq Q_0$, has injectivity radius at least ρ_0 , has curvature pinched toward positive at time T_A , there exists an (r, δ, κ) -surgical solution defined on $[T_A, T_\Omega]$ satisfying the initial condition $(M(T_A), g(T_A)) = (M_0, g_0)$.*

Note that in the statement of Theorem 5.2 the assumption of almost nonnegative curvature is not necessary since it is automatic. We shall prove Theorem 5.3 directly.

Our next aim is to reduce Theorem 5.3 to three results, called Propositions A, B, C, which are independent of one another.

Proposition A. There exists a universal constant $\bar{\delta}_A > 0$ having the following property: let r, δ be surgery parameters, a, b be positive numbers with $a < b$, and $\{(M(t), g(t))\}_{t \in (a, b]}$ be an (r, δ) -surgical solution. Suppose that $\delta \leq \bar{\delta}_A$, and $R_{\max}(b) = \Theta$.

Then there exists a riemannian manifold (M_+, g_+) , which is obtained from $(M(\cdot), g(\cdot))$ by (r, δ) -surgery at time b , and in addition satisfies:

- i. g_+ has ϕ_b -almost nonnegative curvature;
- ii. $R_{\min}(g_+) \geq R_{\min}(g(b))$.

Remark. The manifold M_+ may be empty. In this case, the second assertion in the conclusion follows from the convention $R_{\min}(\emptyset) = +\infty$.

Proposition B. For all $Q_0, \rho_0, \kappa > 0$ there exist $r = r(Q_0, \rho_0, \kappa) < 10^{-3}$ and $\bar{\delta}_B = \bar{\delta}_B(Q_0, \rho_0, \kappa) > 0$ with the following property: let $\delta \leq \bar{\delta}_B$, $0 \leq T_A < b$ and $(M(\cdot), g(\cdot))$ be a surgical solution defined on $[T_A, b]$ such that $g(T_A)$ satisfies $|\text{Rm}| \leq Q_0$ and has injectivity radius at least ρ_0 .

Assume that $(M(\cdot), g(\cdot))$ satisfies Condition $(NC)_{\kappa/16}$, has curvature pinched toward positive, and that for each singular time t_0 , $(M_+(t_0), g_+(t_0))$ is obtained from $(M(\cdot), g(\cdot))$ by (r, δ) -surgery at time t_0 .

Then $(M(\cdot), g(\cdot))$ satisfies Condition $(CN)_r$.

Proposition C. For all $Q_0, \rho_0 > 0$ and all $0 \leq T_A < T_\Omega$ there exists $\kappa = \kappa(Q_0, \rho_0, T_A, T_\Omega)$ such that for all $0 < r < 10^{-3}$ there exists $\bar{\delta}_C = \bar{\delta}_C(Q_0, \rho_0, T_A, T_\Omega, r) > 0$ such that the following holds.

For all $0 < \delta \leq \bar{\delta}_C$ and $b \in (T_A, T_\Omega]$, every (r, δ) -surgical solution defined on $[T_A, b]$ such that $g(T_A)$ satisfies $|\text{Rm}| \leq Q_0$ and has injectivity radius at least ρ_0 , satisfies $(NC)_\kappa$.

Remark. The formulation of Proposition B, and its use below, are somewhat different in $[\text{BBB}^+]$. In the compact case, it is fairly easy to prove that the $(CN)_r$ property is open with respect to time (see $[\text{BBB}^+, \text{Lemma 3.3.2}]$). This is not the case here.

Proof of Theorem 5.3 assuming Propositions A, B, C. We start with two easy lemmas. The first one allows to control the density of surgery times by the surgery parameters.

Lemma 5.4. *Let r, δ be surgery parameters. Let $\{(M(t), g(t))\}_{t \in I}$ be an (r, δ) -surgical solution. Let $t_1 < t_2$ be two singular times. Then $t_2 - t_1$ is bounded from below by a positive number depending only on r, δ .*

Proof. We can suppose that $M(\cdot)$ is constant and $g(\cdot)$ is smooth on $(t_1, t_2]$. Since $R_{\max}(t_2) = \Theta$ we can choose a point $x \in M(t_2)$ such that $R(x, t_2) \geq R_{\max}(t_2) - 1$. Since $R_{\max}(g_+(t_1)) \leq \Theta/2$, there exists $t_+ \in [t_1, t_2]$ maximal such that $\lim_{t \rightarrow t_+, t > t_+} R(x, t) = \Theta/2$. In particular, (x, t) admits an (ε_0, C_0) -canonical neighbourhood for all $t \in (t_+, t_2]$. Integrating inequality (8) on $(t_+, t_2]$ gives a positive lower bound for $t_2 - t_+$ depending only on Θ , hence only on r, δ . \square

The second one says that $(NC)_\kappa$ is a closed condition:

Lemma 5.5. *Let $(M(\cdot), g(\cdot))$ be a surgical solution defined on an interval $(a, b]$, $x \in M(b)$ and $r, \kappa > 0$. Suppose that for all $t \in (a, b)$, $x \in M(t)$, and $(M(\cdot), g(\cdot))$ is κ -noncollapsed at (x, t) on all scales less than or equal to r . Then it is κ -noncollapsed at (x, b) on the scale r .*

Proof. [BBB⁺, Lemma 2.1.5.] \square

Let $Q_0, \rho_0 > 0$ and $0 \leq T_A < T_\Omega$. Proposition C gives a constant $\kappa = \kappa(Q_0, \rho_0, T_A, T_\Omega)$. Proposition B gives constants $r, \bar{\delta}_B$ depending on κ . We can assume $r^{-2} > 12Q_0$. Then apply Proposition C again to get a constant $\bar{\delta}_C$. Set $\delta = \min(\bar{\delta}_A, \bar{\delta}_B, \bar{\delta}_C)$. Without loss of generality, we assume that $\kappa \leq \kappa_{st}$.

From r, δ we get the cutoff parameters h, D, Θ .

Let (M_0, g_0) be a riemannian manifold which has ϕ_A -almost nonnegative curvature, satisfies $R_{\min}(g_0) \geq -6/(4T_A + 1)$, $|\text{Rm}| \leq Q_0$, and has injectivity radius at least ρ_0 .

Let \mathcal{X} be the set of ordered pairs $(b, \{(M(t), g(t))\}_{t \in [T_A, b)})$ consisting of a number $b \in (T_A, T_\Omega]$ and an (r, δ, κ) -surgical solution such that $(M(T_A), g(T_A)) = (M_0, g_0)$. We first show that \mathcal{X} is nonempty. By standard results on the Ricci flow (see e.g. [CLN06, Lemma 6.1]) there exists a complete Ricci flow solution $g(\cdot)$ defined on $[T_A, T_A + (16Q_0)^{-1}]$, such that $g(T_A) = g_0$ and $|\text{Rm}| \leq 2Q_0$ on the interval. By Proposition 3.1, $g(\cdot)$ has curvature pinched toward positive on $[T_A, T_A + (16Q_0)^{-1}]$. As $R \leq 12Q_0 < r^{-2} < \Theta$, $g(\cdot)$ satisfies Property (i) of an (r, δ) -surgical solution, and Properties (ii), (iii) are vacuously satisfied. By Proposition C, it satisfies $(NC)_\kappa$ on the interval. Hence $g(\cdot)$ is a (r, δ, κ) -surgical solution on $[T_A, T_A + (16Q_0)^{-1}]$.

The set \mathcal{X} has a partial ordering, defined by $(b_1, (M_1(\cdot), g_1(\cdot))) \leq (b_2, (M_2(\cdot), g_2(\cdot)))$ if $b_1 \leq b_2$ and $(M_2(\cdot), g_2(\cdot))$ is an extension of $(M_1(\cdot), g_1(\cdot))$.

We want to use Zorn's lemma to prove existence of a maximal element in \mathcal{X} . In order to do this, we consider an *infinite chain*, i. e. an infinite sequence of numbers $T_A < b_1 < b_2 < \dots < b_n < \dots < T_\Omega$ and of (r, δ, κ) -surgical solutions

defined on the intervals $[T_A, b_n)$, and which extend one another. In this way we get an evolving manifold $\{(M(t), g(t))\}$ defined on $[T_A, b_\infty)$, where b_∞ is the supremum of the b_n 's. By Lemma 5.4, the set of singular times is a discrete subset of \mathbf{R} , so $\{(M(t), g(t))\}_{t \in [T_A, b_\infty)}$ is an (r, δ, κ) -surgical solution, thus a majorant of the increasing sequence.

Hence we can apply Zorn's lemma. Let $(b_{\max}, (M(\cdot), g(\cdot))) \in \mathcal{X}$ be a maximal element. Its scalar curvature lies between -6 and Θ , so it is bounded independently of t . Its curvature is pinched toward positive so the sectional curvature is also bounded independently of t . Using the Shi estimates, we deduce that all derivatives of the curvature are also bounded at time b_{\max} . This allows to take a smooth limit and extend $(M(\cdot), g(\cdot))$ to a surgical solution defined on $[T_A, b_{\max}]$, with $R_{\max}(b_{\max}) \leq \Theta$. Condition $(NC)_\kappa$ is still satisfied on this closed interval by Lemma 5.5. Hence we can apply Proposition B, which implies that Property $(CN)_r$ is satisfied on $[T_A, b_{\max}]$. We thus obtain an (r, δ, κ) -surgical solution on the closed interval $[T_A, b_{\max}]$.

To conclude, we prove by contradiction that $b_{\max} = T_\Omega$. Assume that $b_{\max} < T_\Omega$ and consider the following two cases:

Case 1 $R_{\max}(b_{\max}) < \Theta$.

Applying the short time existence theorem for Ricci flow with initial metric $g(b_{\max})$, we can extend $g(\cdot)$ to a surgical solution defined on an interval $[T_A, b_{\max} + \alpha)$ for some $\alpha > 0$. We choose α sufficiently small so that we still have $R_{\max}(t) < \Theta$ on $[T_A, b_{\max} + \alpha)$. There are no singular times in $[b_{\max}, b_{\max} + \alpha)$, and by Proposition 3.1 the extension satisfies the hypothesis that the curvature is pinched toward positive.

Lemma 5.6. *There exists $\alpha' \in (0, \alpha]$ such that Condition $(NC)_{\kappa/16}$ holds for $\{g(t)\}_{t \in [T_A, b_{\max} + \alpha')}$.*

Proof. Let $x \in M(b_{\max})$, $t \in (b_{\max}, b_{\max} + \alpha')$ and $\rho \in (0, 10^{-3})$ be such that $|\text{Rm}| \leq \rho^{-2}$ on $P(x, t, \rho, -\rho^2)$. Choosing α' small enough, we can ensure that $B(x, b_{\max}, \rho/2) \subset B(x, t, \rho)$ and moreover that $P(x, b_{\max}, \rho/2, -\rho^2/4) \subset P(x, t, \rho, -\rho^2)$. It follows that $|\text{Rm}| \leq 4\rho^{-2}$ on $P(x, b_{\max}, \rho/2, -\rho^2/4)$. Since $(CN)_\kappa$ is satisfied up to time b_{\max} , we deduce that $\text{vol}B(x, b_{\max}, \rho/2) \geq \kappa(\rho/2)^3$. Again by proper choice of α' , $\text{vol}_{g(t)}B(x, b_{\max}, \rho/2)$ is at least half of $\text{vol}B(x, b_{\max}, \rho/2)$. Hence

$$\text{vol}B(x, t, \rho) \geq \text{vol}_{g(t)}B(x, b_{\max}, \rho/2) \geq \frac{1}{2}\text{vol}B(x, b_{\max}, \rho/2) \geq \frac{\kappa}{16}\rho^3.$$

□

Applying Proposition B, we deduce that $\{(M(t), g(t))\}_{t \in [T_A, b_{\max} + \alpha']}$ is an (r, δ) -surgical solution. By Proposition C, it is an (r, δ, κ) -surgical solution. This contradicts maximality of b_{\max} .

Case 2 $R_{\max}(b_{\max}) = \Theta$.

Proposition A yields a riemannian manifold (M_+, g_+) . If M_+ is empty, then the construction stops. Suppose $M_+ \neq \emptyset$. Applying Shi's short time existence theorem for Ricci flow on M_+ with initial metric g_+ , we obtain a positive number α and an evolving metric $\{g(t)\}_{t \in (b_{\max}, b_{\max} + \alpha)}$ on M_+ whose limit from the right as t tends to b_{\max} is equal to g_+ . Since $R_{\max}(g_+) \leq \Theta/2$, we may also assume that R_{\max} remains bounded above by Θ . By Proposition 3.1 it has curvature pinched toward positive. Setting $M(t) := M_+$ for $t \in (b_{\max}, b_{\max} + \alpha)$, we obtain an evolving manifold $\{(M(t), g(t))\}_{t \in [T_A, b_{\max} + \alpha]}$ satisfying the first two properties of the definition of (r, δ) -surgical solutions.

Lemma 5.7. *There exists $\alpha' \in (0, \alpha]$ such that Condition $(NC)_{\kappa/16}$ holds on $[T_A, b_{\max} + \alpha')$.*

Proof. Let $x \in M(b_{\max})$, $t \in (b_{\max}, b_{\max} + \alpha')$ and $\rho \in (0, 10^{-1})$ be such that $|\text{Rm}| \leq \rho^{-2}$ on $P(x, t, \rho, -\rho^2)$. If $B(x, t, \rho/2)$ is unscathed and stays so until b_{\max} , then we can repeat the argument used to prove Lemma 5.6. Otherwise it follows from the assumption $\kappa \leq \kappa_{st}$ and properties of almost standard caps. \square

Applying Proposition B, we deduce that $\{(M(t), g(t))\}_{t \in [T_A, b_{\max} + \alpha']}$ is an (r, δ) -surgical solution. By Proposition C, it is an (r, δ, κ) -surgical solution. Again this contradicts the assumption that b_{\max} should be maximal. \square

6 Choosing cutoff parameters

In this section, we give some technical results necessary to prove Theorem 5.1. Their statements are nearly identical to those of the corresponding results of [BBB⁺, Section 4], *surgical solutions* replacing *Ricci flow with bubbling-off*. The proofs are also almost identical, the minor adaptations being precised below.

6.1 Bounded curvature at bounded distance

We have the following technical lemmas, as in [BBB⁺, Section 4.2]:

Lemma 6.1 (Local curvature-distance lemma). *Let (U, g) be a Riemannian manifold. Let $Q \geq 1$, $C > 0$, $x \in U$ and set $Q_x = |R(x)| + Q$. Suppose that there exist $y \in U$ such that $R(y) \geq 2Q_x$, and a minimising segment $[xy]$ where*

$$|\nabla R| \leq CR^{3/2} \quad (*)$$

holds at each point of scalar curvature at least Q . Then $d(x, y) \geq \frac{1}{2C\sqrt{Q_x}}$.

Lemma 6.2 (Local curvature-time lemma). *Let $(U, g(\cdot))$ be a Ricci flow defined on $[t_1, t_2]$. Let $Q \geq 1$, $C > 0$, $x \in U$ and set $Q_x = |R(x, t_2)| + Q$. Suppose that there exists $t \in [t_1, t_2]$ such that $R(x, t) \geq 2Q_x$, and that*

$$\left| \frac{dR}{dt} \right| \leq CR^2 \quad (**)$$

holds at (x, s) if $R(x, s) \geq Q$. Then $t_2 - t \geq (2CQ_x)^{-1}$.

Lemma 6.3 (Local curvature-control lemma). *Let $Q > 0$, $C > 0$, $\varepsilon \in (0, 2\varepsilon_0]$, and $\{(M(t), g(t))\}_{t \in I}$ be a surgical solution on M . Let $(x_0, t_0) \in M \times I$ and set $Q_0 = |R(x_0, t_0)| + Q$. Suppose that $P = P(x_0, t_0, \frac{1}{2C\sqrt{Q_0}}, -\frac{1}{8CQ_0})$ is unscathed and that each $(x, t) \in P$ with $R(x, t) \geq Q$ has an (ε, C) -canonical neighbourhood. Then for all $(x, t) \in P$,*

$$R(x, t) \leq 4Q_0.$$

We shall use repeatedly the following well-known consequences of curvature pinching:

Proposition 6.4. *Let $(U_k, g_k(\cdot), *_{k})$ be a sequence of pointed evolving metrics defined on intervals $I_k \subset \mathbf{R}_+$, and having curvature pinched toward positive. Let $(x_k, t_k) \in U_k \times I_k$ be a sequence such that $(1 + t_k)R(x_k, t_k)$ goes to $+\infty$. Then the sequence $\bar{g}_k := R(x_k, t_k)g(t_k)$ has the following properties:*

- i. The sequence $R_{\min}(\bar{g}_k)$ tends to 0.*
- ii. If $(U_k, \bar{g}_k, *_{k})$ converges in the pointed \mathcal{C}^2 sense, then the limit has non-negative curvature operator.*

We also recall:

Lemma 6.5. *Let $\varepsilon \in (0, 10^{-1}]$. Let (M, g) be a Riemannian 3-manifold, $N \subset M$ be an ε -neck, and S be a middle sphere of N . Let $[xy]$ be a geodesic segment such that $x, y \in M \setminus N$ and $[xy] \cap S \neq \emptyset$. Then the intersection number of $[x, y]$ with S is odd. In particular, if S is separating in M , then x, y lie in different components of $M \setminus S$.*

Proof. [BBB⁺, Lemma 1.3.2.] □

We summarise the conclusion of Lemma 6.5 by saying that N is *traversed* by the segment $[xy]$.

Corollary 6.6. *Let $\varepsilon \in (0, 10^{-1}]$. Let (M, g) be a riemannian 3-manifold, $U \subset M$ be an ε -cap and V be a core of U . Let x, y be points of $M \setminus U$ and $[xy]$ a geodesic segment connecting x to y . Then $[xy] \cap V = \emptyset$.*

As for Ricci flow with bubbling-off, we then have

Theorem 6.7 (Curvature-distance). *For all $A, C > 0$ and all $\varepsilon \in (0, 2\varepsilon_0]$, there exist $Q = Q(A, \varepsilon, C) > 0$ and $\Lambda = \Lambda(A, \varepsilon, C) > 0$ with the following property. Let $I \subset [0, +\infty)$ be an interval and $\{(M(t), g(t))\}_{t \in I}$ be a surgical solution with curvature pinched toward positive. Let $(x_0, t_0) \in \mathcal{M}$ be such that:*

i. $R(x_0, t_0) \geq Q$;

ii. For each point $y \in B(x_0, t_0, AR(x_0, t_0)^{-1/2})$, if $R(y, t) \geq 2R(x_0, t)$, then (y, t) has an (ε, C) -canonical neighbourhood.

Then for all $y \in B(x_0, t_0, AR(x_0, t_0)^{-1/2})$, we have

$$\frac{R(y, t_0)}{R(x_0, t_0)} \leq \Lambda.$$

Proof. It suffices to redo the proof of [BBB⁺, Theorem 4.2.1], with the following minor differences:

- In Step 1, to control the injectivity radius, one can use property iii) in the definition of (ε, C) -canonical neighbourhoods, as the canonical neighbourhood considered is not ε -round.
- In Step 2, to prove that $[x'_k y'_k]$ is covered by strong ε -necks, one has to rule out closed canonical neighbourhoods. This is clear by the curvature ratio properties. Then use Corollary 6.6 instead of [BBB⁺, Lemma 1.3.2]

□

6.2 Existence of cutoff parameters

For the convenience of the reader, we restate Theorem 5.1.

Theorem 6.8 (Cutoff parameters). *For all $r, \delta > 0$, there exist $h \in (0, \delta r)$ and $D > 10$ such that if $(M(\cdot), g(\cdot))$ is a complete surgical solution of bounded curvature defined on an interval $[a, b]$, with curvature pinched toward positive and satisfying $(CN)_r$, then the following holds:*

Let $t \in [a, b]$ and $x, y, z \in M(t)$ such that $R(x, t) \leq 2/r^2$, $R(y, t) = h^{-2}$, and $R(z, t) \geq D/h^2$. Assume there is a curve γ connecting x to z and containing y , such that each point of γ with scalar curvature in $[2C_0r^{-2}, C_0^{-1}Dh^{-2}]$ is centre of a ε_0 -neck. Then (y, t) is centre of a strong δ -neck.

Proof. The proof is almost the same as for [BBB⁺, Theorem 4.3.1], arguing by contradiction. We only need to adapt Step 1.

Fix two constants $r > 0, \delta > 0$, sequences $h_k \rightarrow 0, D_k \rightarrow +\infty$, a sequence $(M_k(\cdot), g_k(\cdot))$ of surgical solutions satisfying the above hypotheses, and sequences $t_k > 0, x_k, y_k, z_k \in M$ such that $R(x_k, t_k) \leq 2r^{-2}$, $R(z_k, t_k) \geq D_k h_k^{-2}$, and $R(y_k, t_k) = h_k^{-2}$. Let γ_k be a curve from x_k to z_k such that $y_k \in \gamma_k$, whose points of scalar curvature in $[2C_0r^{-2}, C_0^{-1}Dh^{-2}]$ are centre of ε_0 -neck. Finally assume that (y_k, t_k) is not centre of a strong δ -neck.

Consider the sequence $(\bar{M}_k(\cdot), \bar{g}_k(\cdot))$ defined by the following parabolic rescaling

$$\bar{g}_k(t) = h_k^{-2} g_k(t_k + th_k^2).$$

In order to clarify notation, we shall put a bar on points when they are involved in geometric quantities computed with respect of the metric \bar{g}_k . Thus for instance, we have $R(\bar{y}_k, 0) = 1$. The contradiction will come from extracting a converging subsequence of the pointed sequence $(\bar{M}_k(\cdot), \bar{g}_k(\cdot), \bar{y}_k, 0)$ and showing that the limit is the cylindrical flow on $S^2 \times \mathbf{R}$, which implies that for k large enough, y_k is centre of some strong δ -neck, contradicting our hypothesis.

Step 1. $(\bar{M}_k(0), \bar{g}_k(0), \bar{y}_k)$ subconverges in the pointed C^∞ sense to $(S^2 \times \mathbf{R}, g_\infty)$ where g_∞ is a product metric of nonnegative curvature operator and scalar curvature at most 2.

Proof. First we control the curvature on balls around \bar{y}_k . Since $R(y_k, t_k)$ goes to $+\infty$, Theorem 6.7 implies that for all $\rho > 0$, there exists $\Lambda(\rho) > 0$ and $k_0(\rho) > 0$ such that $\bar{g}_k(0)$ has scalar curvature bounded above by $\Lambda(\rho)$ on $B(\bar{y}_k, \rho)$ for $k \geq k_0(\rho)$. Moreover, by Assumption (iii) of the definition of canonical neighbourhoods, $\bar{g}_k(\cdot)$ is C_0^{-1} -noncollapsed at $(y_k, 0)$. Indeed $R(y_k, t_k) = h_k^{-2} \in [2C_0r^{-2}, C_0^{-1}Dh^{-2}]$, hence y_k is centre of a ε_0 -neck.

Thus we can apply Gromov's compactness theorem to extract a converging subsequence with regularity $C^{1,\alpha}$.

Let us prove that for large k , the ball $B(\bar{y}_k, \rho)$ is covered by ε_0 -necks. Recall that $g_k(t_k)$ satisfies

$$|\nabla R| < C_0 R^{3/2},$$

at points covered by canonical neighbourhoods. Take a point y such that $R(y, t_k) \leq 2C_0 r^{-2}$ and integrate the previous inequality on the portion of $[y_k y]$ where $R \geq 2C_0 r^{-2}$. An easy computation yields

$$d(\bar{y}, \bar{y}_k) \geq \frac{1}{h_k} \frac{2}{C_0} \left(\frac{r}{\sqrt{2C_0}} - h_k \right) \geq \rho, \quad (9)$$

for k larger than some $k_1(\rho) \geq k_0(\rho)$. It follows that the scalar curvature of $g_k(t_k)$ is at least $2C_0 r^{-2}$ on $B(\bar{y}_k, \rho)$ for every integer $k \geq k_1(\rho)$. It follows that $x_k \notin B(\bar{y}_k, \rho)$ and that $B(\bar{y}_k, \rho)$ is covered by (ε_0, C_0) -canonical neighbourhoods. On the other hand, for k larger than some $k_2(\rho)$, we have $R(\bar{y}, 0) \leq \Lambda(\rho) < C_0^{-1} D h^{-2}$ for all $\bar{y} \in B(\bar{y}_k, \rho)$. It follows that $\gamma \cap B(\bar{y}_k, \rho)$ is covered by ε_0 -necks. As $z_k \notin B(\bar{y}_k, \rho)$, it follows that $B(\bar{y}_k, \rho)$ is contained in the union $U_{\rho, k}$ of these necks: indeed, every segment coming from \bar{y}_k and of length less than ρ lies there.

Now by the $(CN)_r$ assumption, these necks are strong ε_0 -necks. The scalar curvature on $B(\bar{y}_k, \rho)$ being less than $\Lambda(\rho)$ for $k \geq k_0$, we deduce that on each strong neck, $\bar{g}_k(t)$ is smoothly defined on $[-\frac{1}{2\Lambda(\rho)}, 0]$, and has curvature bounded above by $2\Lambda(\rho)$. Hence for each $\rho > 0$, the parabolic balls $P(\bar{y}_k, 0, \rho, -\frac{1}{2\Lambda(\rho)})$ are unscathed, with scalar curvature bounded above by $2\Lambda(\rho)$ for all $k \geq k_2(\rho)$. Since $g_k(\cdot)$ has curvature pinched toward positive, this implies a uniform control of the curvature operator there.

Hence we can apply the local compactness theorem B.1. Up to extracting, $(\bar{M}_k(0), \bar{g}_k(0), \bar{y}_k)$ converges to some complete noncompact pointed riemannian 3-manifold $(\bar{M}_\infty, \bar{g}_\infty, \bar{y}_\infty)$. By Proposition 6.4, the limit has nonnegative curvature operator.

Passing to the limit, we get a covering of \bar{M}_∞ by $2\varepsilon_0$ -necks. Then Proposition 7.5 shows that \bar{M}_∞ is diffeomorphic to $S^2 \times \mathbf{R}$. In particular, it has two ends, so it contains a line, and Toponogov's theorem implies that it is the metric product of some (possibly nonround) metric on S^2 with \mathbf{R} .

As a consequence, the spherical factor of this product must be $2\varepsilon_0$ -close to the round metric on S^2 with scalar curvature 1. Hence the scalar curvature is bounded above by 2 everywhere. This finishes the proof of Step 1. \square

Henceforth we pass to a subsequence, so that $(\bar{M}_k(0), \bar{g}_k(0))$ satisfies the conclusion of Step 1.

The rest of the proof is the same as for [BBB⁺, Theorem 4.3.1]. □

7 Proof of Proposition A

7.1 Piecing together necks and caps

Definition. An ε -tube is an open subset $U \subset M$ which is equal to a union of ε -necks, and whose closure in M is diffeomorphic to $S^2 \times I$, $S^2 \times \mathbf{R}$, or $S^2 \times [0, +\infty)$.

Proposition 7.1. *Let $\varepsilon \in (0, 2\varepsilon_0]$. Let (M, g) be a connected, orientable riemannian 3-manifold. Let X be a closed, connected subset of M such that every point of X is the centre of an ε -neck or an ε -cap. Then there exists an open subset $U \subset M$ containing X such that either*

i. U is equal to M and diffeomorphic to S^3 , $S^2 \times S^1$, RP^3 , $RP^3 \# RP^3$, \mathbf{R}^3 , $S^2 \times \mathbf{R}$, or a punctured RP^3 , or

ii. U is a 10ε -cap, or

iii. U is a 10ε -tube.

Proof. First we deal with the case where X is covered by ε -necks.

Lemma 7.2. *If every point of X is centre of an ε -neck, then there exists an open set U containing X such that U is a 10ε -tube, or U is equal to M and diffeomorphic to $S^2 \times S^1$ or $S^2 \times \mathbf{R}$.*

Proof. Let x_0 be a point of X and N_0 be a 10ε -neck centred at x_0 , contained in an ε -neck U_0 , also centred at x_0 . If $X \subset N_0$ we are done. Otherwise, since X is connected, we can pick a point $x_1 \in X \cap N_0$ and a 10ε -neck N_1 centred at x_1 , with x_1 arbitrarily near the boundary of N_0 . By Lemma 4.4, an appropriate choice of x_1 ensures that $N_1 \subset U_0$ and the middle spheres of N_0 and N_1 are isotopic. In particular, the closure of $N_0 \cup N_1$ is diffeomorphic to $S^2 \times I$, so $N_0 \cup N_1$ is a 10ε -tube.

If $X \subset N_0 \cup N_1$ then we can stop. Otherwise, we pick a 10ε -neck N_2 centred at some point x_2 near the boundary component of N_1 that does not lie in N_0 , and iterate the construction as long as possible. Three cases may occur.

Case 1 The construction stops with some 10ε -tube $N_0 \cup \dots \cup N_k$ containing X . Then we are done.

Case 2 The construction stops with some 10ε -tube $N_0 \cup \dots \cup N_k$ such that adding another neck N_{k+1} does *not* produce a 10ε -tube.

This can only happen if $N_{k+1} \cap N_0$ is non empty. In this case, by adjusting the centre x_{k+1} of N_{k+1} , we can ensure that N_0, \dots, N_{k+1} cover M and that the intersection of N_{k+1} and N_0 is topologically standard. In this case, M fibers over the circle with fiber S^2 . Since M is orientable, it follows that M is diffeomorphic to $S^2 \times S^1$.

Case 3 The construction can be iterated forever.

In this case, the union U of all N_k 's is a 10ε -tube.

Claim. The frontier of U is connected, equal to the boundary component of \bar{N}_0 which does not lie in N_1 .

We prove the claim by contradiction. If it is not true, then we can pick two points $x, y \in X$, each one being close to a distinct component of the frontier of U . Since $U \cap X$ is connected, we can find a path γ connecting x to y in $U \cap X$. Now γ is compact, so it can be covered by finitely many 10ε -necks, each of which is contained in some ε -neck. We thus obtain a finite collection of ε -necks which cover U . Hence U is relatively compact. This shows that the scalar curvature is bounded on U . Hence each N_k has a definite size, and adding each N_k to N_0, \dots, N_{k-1} adds definite volume. It follows that $\text{vol}U$ is infinite, which is a contradiction. This proves the claim.

We continue the proof of Lemma 7.2. If U contains X , then we are done. Otherwise, we pick a point $x_{-1} \in N_0 \cap X$ close to the frontier, and choose a neck N_{-1} centred at x_{-1} . We perform the same iterated construction as before. At each stage, we have a 10ε -tube $N_{-k} \cup \dots \cup N_{-1} \cup U$ whose frontier is connected. Hence the analogue of Case 2 above cannot occur. If the construction stops, then we have found a 10ε -tube containing X . Otherwise the union V of all N_k 's for $k \in \mathbf{Z}$ is a 10ε -tube. Repeating the argument used to prove the claim, we see that the frontier of V is empty. Since M is connected, it follows that $V = M \cong S^2 \times \mathbf{R}$. \square

To complete the proof of Proposition 7.1, we need to deal with the case where there is a point $x_0 \in X$ which is the centre of an ε -cap C_0 . By definition of a cap, some collar neighbourhood of the boundary of C_0 is an ε -neck U_0 . If $X \not\subset C_0$, pick a point x_1 close to the boundary of C_0 . If x_1 is centre of a 10ε -neck N_1 , then we apply Lemma 4.4 again to find that $C_1 := C_0 \cup N_1$ is a 10ε -cap. Again we iterate this construction until one of the following things occur:

Case 1 The construction stops with a 10ε -cap containing X .

Case 2 The construction stops with a 10ε -cap $C_k = C_0 \cup \dots \cup N_k$ and a point x_{k+1} near its frontier, such that x_{k+1} is centre of a 10ε -cap C whose boundary is contained in C_k . Then $C_k \cup C$ equals M and is diffeomorphic to S^3 , RP^3 , or $RP^3 \# RP^3$.

Case 3 The construction goes on forever. Then the same volume argument as in the proof of the above Claim shows that the union of all C'_k s is M . Thus M itself is a 10ε -cap, diffeomorphic to \mathbf{R}^3 or a punctured RP^3 . \square

Putting $X = M$, we obtain the following corollary:

Theorem 7.3. *Let $\varepsilon \in (0, 2\varepsilon_0]$. Let (M, g) be a connected, orientable riemannian 3-manifold. If every point of M is the centre of an ε -neck or an ε -cap, then M is diffeomorphic to S^3 , $S^2 \times S^1$, RP^3 , $RP^3 \# RP^3$, \mathbf{R}^3 , $S^2 \times \mathbf{R}$, or a punctured RP^3 .*

Here is another consequence of Proposition 7.1:

Corollary 7.4. *Let $\varepsilon \in (0, 2\varepsilon_0]$. Let (M, g) be an orientable riemannian 3-manifold. Let X be a closed submanifold of M such that every point of X is the centre of an ε -neck or an ε -cap. Then one of the following conclusions holds:*

- i. M is diffeomorphic to S^3 , $S^2 \times S^1$, RP^3 , $RP^3 \# RP^3$, \mathbf{R}^3 , $S^2 \times \mathbf{R}$, or a punctured RP^3 , or*
- ii. There exists a locally finite collection N_1, \dots, N_p of 10ε -caps and 10ε -tubes with disjoint closures such that $X \subset \bigcup_i N_i$.*

Proof. We apply Proposition 7.1 to each connected component of X . If Case (i) of the required conclusion does not hold, then we have found a locally finite collection of 10ε -caps and 10ε -tubes which cover X . By merging some of them if necessary, we can ensure that they have disjoint closures. \square

Finally, we have a more precise result when there are just necks:

Proposition 7.5. *Let $\varepsilon \in (0, 2\varepsilon_0]$. Let (M, g) be an open riemannian 3-manifold such that every point of M is centre of an ε -neck. Then M is diffeomorphic to $S^2 \times \mathbf{R}$.*

This follows immediately from the proof of Lemma 7.2.

7.2 Proof of Proposition A

Recall the statement:

Proposition A. There exists a universal constant $\bar{\delta}_A > 0$ having the following property: let r, δ be surgery parameters, a, b be positive numbers with $a < b$, and $\{(M(t), g(t))\}_{t \in (a, b]}$ be an (r, δ) -surgical solution. Suppose that $\delta \leq \bar{\delta}_A$, and $R_{\max}(b) = \Theta$.

Then there exists a riemannian manifold (M_+, g_+) , which is obtained from $(M(\cdot), g(\cdot))$ by (r, δ) -surgery at time b , and in addition satisfies:

- i. g_+ has ϕ_b -almost nonnegative curvature;
- ii. $R_{\min}(g_+) \geq R_{\min}(g(b))$.

Throughout this section we shall work in the riemannian manifold $(M(b), g(b))$. In particular all curvatures and distances are taken with respect to this metric.

Let \mathcal{G} (resp. \mathcal{O} , resp. \mathcal{R}) be the set of points of $M(b)$ of scalar curvature less than $2r^{-2}$, (resp. $\in [2r^{-2}, \Theta/2)$, resp. $\geq \Theta/2$.)

For brevity, we call *cutoff neck* a strong δ -neck centred at some point of scalar curvature h^{-2} . Note that cutoff necks are contained in \mathcal{O} , and have diameter and volume bounded by functions of h, δ -alone.

Lemma 7.6. *There exists a locally finite collection $\{N_i\}$ of pairwise disjoint cutoff necks such that any connected component of $M(b) \setminus \bigcup_i N_i$ is contained in either $\mathcal{G} \cup \mathcal{O}$ or $\mathcal{R} \cup \mathcal{O}$.*

Proof. By Zorn's Lemma, there exists a maximal collection $\{N_i\}$ of pairwise disjoint cutoff necks. Such a collection is automatically locally finite, e.g. because if K is any compact subset, all cutoff necks that meet K are contained in the $h(2\delta^{-1} + 1)$ -neighbourhood of K , which has finite volume.

Suppose that some component X of $M(b) \setminus \bigcup_i N_i$ contains at least one point $x \in \mathcal{G}$ and one point $z \in \mathcal{R}$. Since X is a closed subset of $M(b)$, there exists a geodesic path γ in X connecting x to z .

Claim. The intersection of γ and ∂X is empty.

Proof of the claim. First observe that if y is a point of ∂X , then y has a canonical neighbourhood U . This neighbourhood cannot be a cap, because then U would contain the whole of X , which would imply that $X \subset \mathcal{O}$. Hence U is a neck.

If such a point y belonged to γ , then by Lemma 6.5 the neck U would be traversed by γ . This contradicts the fact that $\gamma \subset X$. \square

In order to apply Theorem 5.1, one has to prove the following

Claim. Each point of γ with scalar curvature in $[2C_0r^{-2}, C_0^{-1}Dh^{-2}]$ is centre of some ε_0 -neck.

Proof of the claim. Let $y \in \gamma$ be such a point. By the curvature assumptions, y is centre of a (ε_0, C_0) -canonical neighbourhood U , disjoint from x and z . Hence U cannot be a closed manifold. It remains to rule out the (ε_0, C_0) -cap case. We argue by contradiction. Assume that U is an (ε_0, C_0) -cap. Then $U = N \cup C$, where N is a ε_0 -neck, $N \cap C = \emptyset$, $\overline{N} \cap C = \partial C$ and $y \in \text{Int}C$. For simplicity dilate the metric by a factor such that the scalar curvature of N is close to 1. Denote by S the middle sphere of N . The curve γ is clearly not minimizing in U . In particular if x' (resp. z') is an intersection point of γ with S lying between x and y (resp. y and z), then $d(x', z') \leq \text{diam}(S) \ll 2\varepsilon_0^{-1} < d(x', y) + d(y, z')$. The geodesic segment $[x'z'] \subset U$ is not contained in X , otherwise this would contradict the minimality of γ in X . Hence there exists $p \in [x', z'] \cap \partial X$. By definition of X , the corresponding component of ∂X is a boundary component of some neck N_i . Let us prove that γ intersects N_i , which is a contradiction. Denote by S_i^+ the above boundary component of N_i , and note that $d(S_i^+, S) < \text{diam}(S)$. Let N' be a $10\varepsilon_0$ -subneck of N_i which admits S_i^+ as a boundary component, and $p' \in N'$ be its centre. Then $d(p', S) < \text{diam}(S) + (10\varepsilon_0)^{-1} < (4\varepsilon_0)^{-1}$. It follows from Lemma 4.4 that S' is isotopic to S in N . In particular γ intersects S' . \square

Let y be a point of γ of scalar curvature h^{-2} . Theorem 5.1 yields a cutoff neck N centred at y . Any δ -neck meeting N has to be traversed by γ , so N is disjoint from the N_i 's. This contradicts maximality of $\{N_i\}$. \square

Having established Lemma 7.6, we prove Proposition A. Let $\{N_i\}$ be a collection of cutoff necks given by that lemma. Applying Theorem 3.4, we obtain a Riemannian manifold (M', g_+) . By construction, the components of M' fall into two types. Either they have curvature less than $\Theta/2$, or they are covered by canonical neighbourhoods. Applying Theorem 7.3, we may safely throw away the components of the second type, obtaining the manifold (M_+, g_+) . We remark that the operation cannot decrease R_{\min} (in fact $R_{\min}(g_+)$ is equal to $R_{\min}(g(b))$ unless M_+ is empty, in which case it is equal to $+\infty$). Thus the proof of Proposition A is complete.

8 Persistence

Notation If $(M(\cdot), g(\cdot))$ is a piecewise \mathcal{C}^1 evolving manifold defined on some interval $I \subset \mathbf{R}$ and $[a, b] \subset I$, we call *restriction of g to $[a, b]$* the

evolving manifold

$$t \mapsto \begin{cases} (M_+(a), g_+(a)) & \text{if } t = a \\ (M(t), g(t)) & \text{if } t \in (a, b] \end{cases}$$

We shall still denote by $g(\cdot)$ the restriction. Given $(x, t) \in \mathcal{M}$, $r > 0$ and $\Delta t > 0$ we define the forward parabolic neighbourhood $P(x, t, r, \Delta t)$ as the set

$$P(x, t, r, \Delta t) = \{(x', t') \in \mathcal{M} \mid x' \in B(x, t, r), t \leq t' \leq t + \Delta t\}$$

When we consider a restriction of $g(\cdot)$ to some $[a, b] \subset I$, the parabolic neighbourhood $P(x, a, r, \Delta t)$ will be defined using the ball $B(x, a, r)$ of radius r with respect to the metric $g_+(a)$.

A parabolic neighbourhood $P(x, t, r, \Delta t)$ is said to be *unscathed* if $x' \in M_{\text{reg}}(t')$ for all $x' \in B(x, t, r)$ and $t' \in [t, t + \Delta t)$. Otherwise it is *scathed*.

Given two surgical solutions $(M(\cdot), g(\cdot))$ and $(M_0(\cdot), g_0(\cdot))$, we say that an unscathed parabolic neighbourhood $P(x, t, r, \Delta t)$ of $(M(\cdot), g(\cdot))$ is ε -close to another unscathed parabolic neighbourhood $P(x_0, t, r_0, \Delta t)$ of $(M_0(\cdot), g_0(\cdot))$ if $(B(x, t, r), g(\cdot))$ is ε -close to $(B(x_0, t, r_0), g_0(\cdot))$ on $[t, t + \Delta t]$. We say that $P(x, t, r, \Delta t)$ is ε -homothetic to $P(x_0, t_0, r_0, \lambda \Delta t)$ if it is ε -close after a parabolic rescaling by λ .

The goal of this section is to prove the following technical theorem:

Theorem 8.1 (Persistence of almost standard caps). *For all $A > 0$, $\theta \in [0, 1)$ and $\hat{r} > 0$, there exists $\bar{\delta} = \bar{\delta}_{\text{per}}(A, \theta, \hat{r})$ with the following property. Let $(M(\cdot), g(\cdot))$ be a surgical solution defined on some interval $[a, b]$, which is a (r, δ) -surgical solution on $[a, b]$, with $r \geq \hat{r}$ and $\delta \geq \bar{\delta}$. Let $t_0 \in [a, b)$ be a singular time and consider the restriction of $(M(\cdot), g(\cdot))$ to $[t_0, b]$. Let $p \in (M(t_0), g(t_0))$ be the tip of some δ -almost standard cap of scale h . Let $t_1 \leq \min(b, t_0 + \theta h^2)$ be maximal such that $P(p, t_0, Ah, t_1 - t_0)$ is unscathed. Then the following holds:*

- i. The parabolic neighbourhood $P(p, t_0, Ah, t_1 - t_0)$ is A^{-1} -homothetic to $P(p_0, 0, A, (t_1 - t_0)h^{-2})$;*
- ii. If $t_1 < \min(b, t_0 + \theta h^2)$, then $B(p, t_0, Ah) \subset M_{\text{sing}}(t_1)$ disappear at time t_1 .*

Remark. In [BBB⁺], the conclusion in the last case was that $B(p, t_0, Ah) \subset M_{\text{sing}}(t_1)$.

Before giving the proof of the theorem, we summarize some technical results from [BBB⁺] Sections 6.1 and 6.2.

Let T_0 be a positive real number. Let $\mathcal{M}_0 = (X_0, g_0(\cdot), p_0)$ (the model) be a complete 3-dimensional Ricci flow defined on $[0, T_0]$ such that the quantity

$$\Lambda(N) := \max_{X_0 \times [0, T_0]} \{ |\nabla^p \text{Rm}| \mid 0 \leq p \leq N \}$$

is finite for all $N \in \mathbf{N}$.

Corollary 8.2 (Persistence of the model in dimension 3). *Let $A > 0$, there exists $\rho = \rho(\mathcal{M}_0, A) > A$ with the following property. Let $\{(M(t), g(t))\}_{t \in [0, T]}$ be a surgical solution with $T \leq T_0$. Suppose that*

- a) $(M(\cdot), g(\cdot))$ has curvature pinched toward positive.
- b) $|\frac{\partial R}{\partial t}| \leq C_0 R^2$ at any (x, t) with $R(x, t) \geq 1$.

Let $p \in M(0)$ and $t \in (0, T]$ be such that

- c) $B(p, 0, \rho)$ is ρ^{-1} -close to $B(p_0, 0, \rho) \subset X_0$,
- d) $P(p, 0, \rho, t)$ is unscathed and $|\text{Rm}| \leq \Lambda([A] + 1)$ there.

Then $P(p, 0, A, t)$ is A^{-1} -close to $P(p_0, 0, A, t)$.

Proof. The proofs of [BBB⁺, Corollary 6.2.4 and 6.2.6] work for surgical solutions. □

Proof of Theorem 8.1. We consider as model the standard solution $\mathcal{X}_0 := (\mathcal{S}_0, g_0(\cdot), p_0)$ restricted to $[0, \theta]$. Let us assume for simplicity that $T \geq t_0 + \theta h^2$, so that $t_1 = t_0 + \theta h^2$. For any nonnegative integer N , recall that

$$\Lambda(N) = \max_{\mathcal{S}_0 \times [0, \theta]} \{ |\nabla^p \text{Rm}|, |R|; 0 \leq p \leq N \}.$$

In the sequel we consider the restriction of $(M(\cdot), g(\cdot))$ to $[t_0, b]$ and we define:

$$\bar{g}(t) := h^{-2} g(t_0 + th^2) \text{ for } t \in [0, \min\{\theta, (b - t_0)h^{-2}\}].$$

Note that $\bar{g}(\cdot)$ satisfies Assumptions a) and b) of Corollary 8.2. Indeed, it is readily checked that the curvature pinched toward positive property is preserved by the parabolic rescaling, since $t_0 \geq 0$ and $h^{-2} \geq 1$. On the other hand, if $g(\cdot)$ satisfies $(CN)_r$ on $[0, b]$, it follows easily by a continuity argument that any (x, b) with $R(x, b) \geq 2r(b)^{-2}$ satisfies the estimate $|\frac{\partial R}{\partial t}| \leq C_0 R^2$ at (x, b) . After rescaling by $h(b)^{-2} \gg 2r^{-2}$, this property holds at points with scalar curvature above 1.

Fix $A > 0$ and set $\rho := \rho(\mathcal{M}_0, A)$. By the definition of an δ -almost standard cap, the ball $B_{\bar{g}}(p, 0, 5 + \delta^{-1})$ is δ' -close to $B(p_0, 0, 5 + \delta^{-1}) \subset \mathcal{S}_0$. Let $T_{\max} \in [0, \theta]$ be the maximal time such that $P_{\bar{g}}(p, 0, A, T_{\max})$ is unscathed. By closeness at time 0 one has $|R_{\bar{g}}| \leq 2\Lambda_0$ on $B_{\bar{g}}(p, 0, \delta^{-1})$.

Now for $t \in [0, \min((4\Lambda C_0)^{-1}, \theta)]$ such that $P_{\bar{g}}(p, 0, \rho, t)$ is unscathed, we have $|R_{\bar{g}}| \leq 4\Lambda_0$ on $P_{\bar{g}}(p, 0, \rho, t)$ by the time derivative estimate on the scalar curvature. Using the pinching assumptions, we deduce $|\text{Rm}_{\bar{g}}| \leq \Lambda'_0$ on the same neighbourhood.

Set $T_{\times 2} := \min(\theta, (4\Lambda_0 C_0)^{-1}, (4\Lambda'_0)^{-1})$. The above curvature bound gives, for $t \leq \min(\theta, T_{\times 2})$,

$$1/2 \leq \bar{g}(t)/\bar{g}(0) \leq 2$$

on $B_{\bar{g}}(p, 0, \delta^{-1})$. In particular, for all $x \in B_{\bar{g}}(p, 0, \rho)$ and all $0 < t \leq \min(\theta, T_{\times 2})$, (x, t) is not centre of a δ -neck because $d_{\bar{g}(t)}(x, p) \leq 2d_{\bar{g}(0)}(x, p) \leq 2\rho$ and the length of a δ -neck at time t is larger than $1/2\delta^{-1}R(x, t)^{-1/2} \geq (4\delta\Lambda_0)^{-1} > 4\rho$, if δ is small enough.

This implies that $P_{\bar{g}}(p, 0, \rho, t)$ is unscathed if $t \leq \min(T_{\times 2}, T_{\max})$. Indeed, if not, there exists $t' < t$ such that $P_{\bar{g}}(p, 0, \rho, t')$ is unscathed but $B_{\bar{g}}(p, 0, \rho) \cap M_{\text{sing}}(t') \neq \emptyset$. If $B_{\bar{g}}(p, 0, \rho)$ is not contained in $M_{\text{sing}}(t')$, then it must intersect a surgery sphere of $\mathcal{S}(t')$, which is the middle sphere of a δ -neck centred at (x, t') . The above estimate rules out this possibility. Hence $B_{\bar{g}}(p, 0, A) \subset B_{\bar{g}}(p, 0, \rho) \subset M_{\text{sing}}(t')$ for $t' < T_{\max}$. This is impossible by assumption. Remark that if $B(p, 0, \rho) \cap M_{\text{sing}}(t) \neq \emptyset$ the same arguments shows that $B(p, 0, \rho)$ is contained in $M_{\text{sing}}(t)$ and disappears at time t .

We can now apply Corollary 8.2. We get that $P_{\bar{g}}(p, 0, \rho_1, t)$ is ρ_1^{-1} -close to $P(p_0, 0, \rho_1, t)$ for all $t \leq \min(T_{\times 2}, T_{\max})$. If $T_{\times 2} \geq T_{\max}$ we are done. Otherwise by closeness we have that $|\text{Rm}_{\bar{g}}|$ and $|R_{\bar{g}}|$ are no greater than $2\Lambda_0$ on $P_{\bar{g}}(p, 0, \rho_1, T_{\times 2})$. Then $|R_{\bar{g}}| \leq 4\Lambda_0$ on $P_{\bar{g}}(p, 0, \rho_1, \min(2T_{\times 2}, T_{\max}))$ where $\rho_1 = \rho(\mathcal{M}_0, \rho_2)$ and $\rho_2 > 0$. We then iterate the above argument, which terminates in finitely many steps, as in [BBB⁺, Corollary 6.2.4]. If $T_{\max} < \theta$, then Conclusion (ii) follows from the previous remark. This finishes the proof of Theorem 8.1. \square

9 Proposition B

Recall the statement of Proposition B:

Proposition B. For all $Q_0, \rho_0, \kappa > 0$ there exist $r = r(Q_0, \rho_0, \kappa) < 10^{-3}$ and $\bar{\delta}_B = \bar{\delta}_B(Q_0, \rho_0, \kappa) > 0$ with the following property: let $\delta \leq \bar{\delta}_B$, $0 \leq T_A < b$ and $(M(\cdot), g(\cdot))$ be a surgical solution defined on $[T_A, b]$ such that $g(T_A)$ satisfies $|\text{Rm}| \leq Q_0$ and has injectivity radius at least ρ_0 .

Assume that $(M(\cdot), g(\cdot))$ satisfies Condition $(NC)_{\kappa/16}$, has curvature pinched toward positive, and that for each singular time t_0 , $(M_+(t_0), g_+(t_0))$ is obtained from $(M(\cdot), g(\cdot))$ by (r, δ) -surgery at time t_0 .

Then $(M(\cdot), g(\cdot))$ satisfies Condition $(CN)_r$.

We recall a lemma from [BBB⁺].

Lemma 9.1 (distance distortion). *Let $\{g(t)\}$ be a Ricci flow solution on a n -dimensional manifold U , defined for $t \in [t_1, t_2]$. Suppose that $|\text{Rm}| \leq \Lambda$ on $U \times [t_1, t_2]$. Then*

$$e^{-2(n-1)\Lambda(t_2-t_1)} \leq \frac{g(t_2)}{g(t_1)} \leq e^{2(n-1)\Lambda(t_2-t_1)}$$

Proof. [BBB⁺, Lemma 0.6.6.] □

In order to prove Proposition B, we argue by contradiction. Suppose that some fixed numbers $Q_0, \rho_0, \kappa > 0$ have the property that for all $r \in (0, 10^{-3})$ and $\bar{\delta}_B > 0$ there exist counterexamples. Then we can consider sequences $r_k \rightarrow 0$, $\delta_k \rightarrow 0$, and a sequence of (r_k, δ_k, κ) -surgical solutions $(M_k(\cdot), g_k(\cdot))$ on $[0, b)$ which satisfy Condition $(NC)_{\kappa/16}$, have curvature pinched toward positive, and such that for each singular time t_0 , $(M_{k,+}(t_0), g_{k,+}(t_0))$ is obtained from $(M(\cdot), g(\cdot))$ by (r, δ) -surgery at time t_0 , but $(CN)_{r_k}$ fails for some t_k . This last assertion means that there exists $x_k \in M_k(t_k)$ such that

$$Q_k := R(x_k, t_k) \geq r_k^{-2},$$

and yet (x_k, t_k) does not have a (ε_0, C_0) -canonical neighbourhood.

By a standard point-picking argument (see [KL08, Lemma 52.5]), we may choose the sequence of bad points (x_k, t_k) and $H_k \rightarrow +\infty$ such that for all $t \in [t_k - H_k Q_k^{-1}, t_k]$ and $x \in M_k(t)$, if $R(x, t) \geq 2Q_k$ then (x, t) has a (ε_0, C_0) -canonical neighbourhood.

Without loss of generality, we assume that

$$\delta_k \leq \bar{\delta}(k, 1 - \frac{1}{k}, r_k)$$

(the right-hand side being the parameter given by the Persistence Theorem 8.1). From now on, the proof follows the lines of [BBB⁺, Section 7.2].

We need a preliminary lemma.

Lemma 9.2 (Parabolic balls of bounded curvature are unscathed). *For all $K > 0, \rho > 0$ and $\tau > 0$ there exists an integer $k_0 = k_0(K, \rho, \tau)$ such that for all $k \geq k_0$, if $|\text{Rm}| \leq K$ on $B_{\bar{g}_k}(x_k, 0, \rho) \times (-\tau, 0]$ then $P_{\bar{g}_k}(x_k, 0, \rho, -\tau)$ is unscathed.*

Proof. Arguing by contradiction, fix k and assume that there exist $z_k \in B_{\bar{g}_k}(x_k, 0, \rho)$ and $s_k \in [-\tau, 0)$ such that $z_k \notin M_{\text{reg}}(s_k)$. As z_k exists after s_k , there is an added cap V in $M_+(s_k)$ such that $z_k \in V$. We can take s_k to be maximal satisfying this property, i.e. the set $B_{\bar{g}_k}(x_k, 0, \rho) \times (s_k, 0]$ is unscathed. In the sequel, we consider the restriction of $\bar{g}_k(\cdot)$ to $[s_k, 0]$, as explained in the beginning of Section 8. We drop indices for simplicity.

By definition, there exists a marked δ -almost standard cap (U, V, p, y) such that $(U, R_{\bar{g}}(y, s)\bar{g}(y, s))$ is δ' -close to $B(p_0, 5 + \delta^{-1}) \subset \mathcal{S}_0$. Set $\tilde{g}(y, s) := R_{\bar{g}}(y, s)\bar{g}(y, s)$. We shall now show that $d_{\tilde{g}}(x, p)$ is bounded independently of k (if k is large enough.)

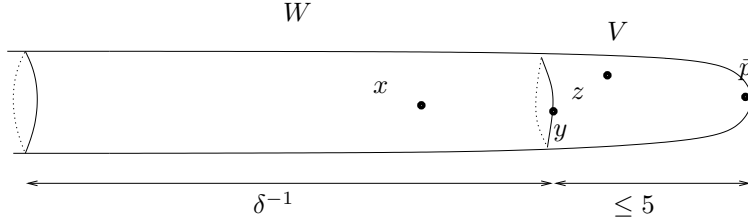

Since $B_{\bar{g}}(x, 0, \rho) \times (s, 0]$ is unscathed with $|\text{Rm}| \leq K$, by the distance-distorsion Lemma 9.1 we have

$$e^{-4K\tau} \leq \bar{g}(0)/\bar{g}(s) \leq e^{4K\tau},$$

which implies $d_{\bar{g}(s)}(x, z) \leq e^{2K\tau}\rho$. Since $y \in U$,

$$R_{\bar{g}}(y, s) \leq 2R_{\bar{g}}(z, s) \leq 12K.$$

Notice that since $y \in \partial V$, $R_{\tilde{g}}(y, s) = R_{\bar{g}}(y, s)$. We now get

$$d_{\tilde{g}}(x, y) \leq \sqrt{12K}e^{2K\tau} =: K'(K, \rho, \tau).$$

Finally,

$$d_{\tilde{g}}(x, p) \leq K' + 5.$$

Let $A > 2(K' + 5)$ and $\theta < 1$. The persistence theorem 8.1 implies that the set $P_{\tilde{g}}(p, s, AR_{\tilde{g}}(y, s)^{-1/2}, \min(\theta R_{\tilde{g}}(y, s)^{-1}, |s|))$ is, after parabolic rescaling at time s , A^{-1} -close to $P(p_0, 0, A, \min(\theta, |s|\bar{R}_k(y, s)))$. Indeed, the second alternative of the persistence theorem does not occur since in this case, $x \in B_{\tilde{g}}(p, A) \subset M_{\text{sing}}(t_+)$ for some $t_+ \in (s, 0)$, and x disappears at time t_+ .

We now choose $A := k$ and $\theta := 1 - 1/k$.

Claim. We have $s + \theta R_{\tilde{g}}(y, s)^{-1} > 0$ for large k .

Proof. If $R_{\bar{g}}(y, s) < 1/2\tau$ then

$$s + \theta R_{\bar{g}}(y, s)^{-1} \geq -\tau + 1/2R_{\bar{g}}(y, s)^{-1} > 0,$$

since $\theta > 1/2$.

Suppose that $R_{\bar{g}}(y, s) \geq 1/2\tau$. Seeking a contradiction, assume that $s_1 := s + \theta R_{\bar{g}}(y, s)^{-1} \leq 0$ and apply the persistence theorem up to this time. By Proposition 4.3, $R_{\min}(t) \geq \text{const}_{\text{st}}(1-t)^{-1}$, hence we have

$$R_{\bar{g}}(x, s_1) \geq \frac{1}{2}R_{\bar{g}}(y, s)\text{const}_{\text{st}}(1-\theta)^{-1} \geq \text{const}_{\text{st}}(4\tau(1-\theta))^{-1} = \frac{k \cdot \text{const}_{\text{st}}}{4\tau}.$$

On the other hand, $R_{\bar{g}}(x, s_1) \leq 6K$, which gives a contradiction for sufficiently large k . This proves the claim. \square

Denote by $\tilde{g}(\cdot)$ the parabolic rescaling of \bar{g} by $R_{\bar{g}}(y, s)$ at time s :

$$\tilde{g}(t) = R_{\bar{g}}(y, s)g(s + tR_{\bar{g}}(y, s)^{-1}).$$

By the conclusion of the persistence theorem, there exists a diffeomorphism $\psi : B(p_0, 0, A) \rightarrow B_{\bar{g}}(p, 0, A)$ such that $\psi^*\tilde{g}(\cdot)$ is A^{-1} -close to $g_0(\cdot)$ on $B(p_0, 0, A) \times [0, \min\{\theta, |s|R_{\bar{g}}(y, s)\}]$. By the above claim, the minimum is $|s|R_{\bar{g}}(y, s) := s'$. Set $x' := \psi^{-1}(x)$. Proposition 4.3 implies that for every $\epsilon > 0$, there exists $C_{st}(\epsilon)$ such that any point (x', t) of the standard solution has an $(\epsilon, C_{st}(\epsilon))$ -canonical neighbourhood unless $t < 3/4$ and $x' \notin B(p_0, 0, \epsilon^{-1})$. Let us choose $\epsilon := \epsilon_0\beta/2 \ll \epsilon$ and $C_{st} := C_{st}(\epsilon)$. There are again two possibilities.

Case 1 The point (x', s') has an (ϵ, C_{st}) -canonical neighbourhood $U' \subset B(x', s', 2C_{st}R(x', s')^{-1/2})$, where $R(x', s')$ is the scalar curvature of the standard solution at (x', s') . The A^{-1} -closeness between $g_0(s')$ and $\psi^*\tilde{g}(s')$ gives

$$R(x', s') \simeq R_{\bar{g}}(x, s') = R_{\bar{g}}(y, s)^{-1}R_{\bar{g}}(x, 0) = R_{\bar{g}}(y, s)^{-1}.$$

On the other hand,

$$U' \subset B(x', s', \frac{\rho}{2}R_{\bar{g}}(y, s)^{1/2}) \subset \psi^{-1}(B_{\bar{g}}(x, 0, \rho))$$

since

$$\frac{\rho}{2}R_{\bar{g}}(y, s)^{1/2} \simeq \frac{\rho}{2}R(x', s')^{-1/2} > 2C_{st}R(x', s')^{-1/2}.$$

Therefore $\psi(U')$ is a $(2\epsilon, 2C_{st})$ -canonical neighbourhood for $(x, 0)$, hence an (ϵ_0, C_0) -canonical neighbourhood for this point.

Case 2 The point (x', s') has no (ε, C_{st}) -canonical neighbourhood. Then $s' \leq 3/4$ and $x' \notin B(p_0, 0, \varepsilon_{st}^{-1})$. Hence we have

$$d_{\bar{g}}(x, s', p) \geq 9/10\varepsilon_{st}^{-1} \geq 3/2(\varepsilon\beta)^{-1} > (\varepsilon\beta)^{-1} + 5.$$

We infer that $(x, -s')$ is centre of an $(\varepsilon_0\beta)$ -neck, coming from the strong δ -neck there at the singular time. We now apply the neck strengthening lemma 4.5 which asserts that $(x, 0)$ is centre of a strong ε -neck. Indeed the closeness with the standard solution ensures that $P_{\bar{g}}(x, -s', (\varepsilon_0\beta)^{-1}, 0) \subset P_{\bar{g}}(x, -s', A, 0)$ is unscathed and has $|\text{Rm}| \leq 2K_{st}$. This proves Lemma 9.2. \square

Now we begin the proof of Proposition B proper. We consider parabolic rescalings.

Step 1. The sequence $(\bar{M}_k(0), \bar{g}_k(0), \bar{x}_k)$ subconverges to some complete pointed riemannian manifold $(M_\infty, g_\infty, x_\infty)$ of nonnegative curvature operator.

Proof. We have to show that the sequence satisfies the hypothesis of the local compactness theorem for flows (Theorem B.1.) By choice of the basepoint and curvature pinching, we can apply Theorem 6.7. Hence for every ρ , the scalar curvature of $\bar{g}_k(0)$ is bounded above on $B(\bar{x}_k, 0, \rho)$ by some constant $\Lambda(\rho)$ if $k \geq k(\rho)$.

Next we wish to obtain similar bounds on parabolic balls $P(\bar{x}_k, 0, \rho, -\tau(\rho))$ for some $\tau(\rho) > 0$, and show that they are unscathed. Set $C(\rho) := \Lambda(\rho) + 2$. Let $k_1(\rho) := k_0(K(\rho), \rho, (2C_0C(\rho))^{-1})$ be the parameter given by Lemma 9.2.

Claim. If $k \geq k_1(\rho)$, then $P_{\bar{g}_k}(\bar{x}_k, 0, \rho, -(2C_0C(\rho))^{-1})$ is unscathed and satisfies $|\text{Rm}| \leq 2C(\rho)$.

Proof. Choose $s = s_k \in [-(4C_0C(\rho))^{-1}, 0]$ minimal such that $\bar{B}_k(x_k, 0, \rho) \times (s, 0]$ is unscathed. By the curvature-time lemma 6.2 we have $R \leq 2C(\rho)$ on this set, which implies $|\text{Rm}| \leq 2C(\rho)$ by the Pinching Lemma 3.3. By Lemma 9.2, $P_{\bar{g}_k}(x_k, 0, \rho, s)$ is unscathed. By minimality of s we then have $s = -(2C_0C(\rho))^{-1}$. \square

By hypothesis, the solutions $g_k(\cdot)$ are κ -noncollapsed on scales less than r_0 . Hence $\bar{g}_k(0)$ is κ -noncollapsed on scales less than $\sqrt{Q_k}r_0$. This, together with the curvature bound implies a positive lower bound for the injectivity radius at $(\bar{x}_k, 0)$. Hence Theorem B.1 applies to the sequence $(\bar{M}_k, \bar{g}_k(\cdot), x_k)$. It implies that the sequence subconverges to $(M_\infty, g_\infty(\cdot), x_\infty)$, where M_∞ is a smooth manifold, $g_\infty(0)$ is complete and $g_\infty(\cdot)$ is defined on $B(x_\infty, 0, \rho) \times (-(2C_0C(\rho))^{-1}, 0]$ for each $\rho > 0$.

Lastly, since the metrics $g_k(0)$ are normalised and the scaling factor Q_k goes to $+\infty$, the limit metric $g_\infty(t)$ has nonnegative curvature operator by curvature pinching. This argument completes the proof of Step 1. \square

Since $R(x_\infty) = 1$, M_∞ is a complete, nonflat, nonnegatively curved riemannian 3-manifold. By the Cheeger-Gromoll-Hamilton classification of such manifolds, M is diffeomorphic to \mathbf{R}^3 , $S^1 \times \mathbf{R}^2$, $S^1 \times S^2$, a line bundle over a closed surface, or a spherical space form. In particular, if M_∞ is noncompact, then every smoothly embedded 2-sphere in M_∞ is separating.

Step 2. The riemannian manifold $(M_\infty, g_\infty(0))$ has bounded curvature.

Proof. Of course we may assume that M_∞ is noncompact. By passing to the limit, we see that every point $p_0 \in M_\infty$ of scalar curvature at least 3 is centre of a $(2\varepsilon_0, 2C_0)$ -cap or a (not necessarily strong) $2\varepsilon_0$ -neck. In the sequel, we refer to this fact by saying that the limiting partial flow $g_\infty(\cdot)$ satisfies the *weak canonical neighbourhood property*.

Let (p_k) be a sequence of points of M_∞ such that $R_\infty(p_k, 0) \rightarrow +\infty$; in particular, $d_\infty(p_k, x_\infty) \rightarrow +\infty$ as $k \rightarrow +\infty$. Consider segments $[x_\infty p_k]$ which, after passing to a subsequence, converge to a geodesic ray c starting at x_∞ .

On $[x_\infty p_k]$ we pick a point q_k such that $R_\infty(q_k) = \frac{R_\infty(p_k)}{3C_0}$. For sufficiently large k , the point $(q_k, 0)$ is centre of a weak $(2\varepsilon_0, 2C_0)$ -canonical neighbourhood U_k . Now the curvatures on U_k belong to $[(2C_0)^{-1}R_\infty(q_k, 0), 2C_0R_\infty(q_k, 0)]$. As a consequence, for large k , x_∞ and p_k do not belong to U_k . By Corollary 6.6 this neighbourhood is a $2\varepsilon_0$ -neck.

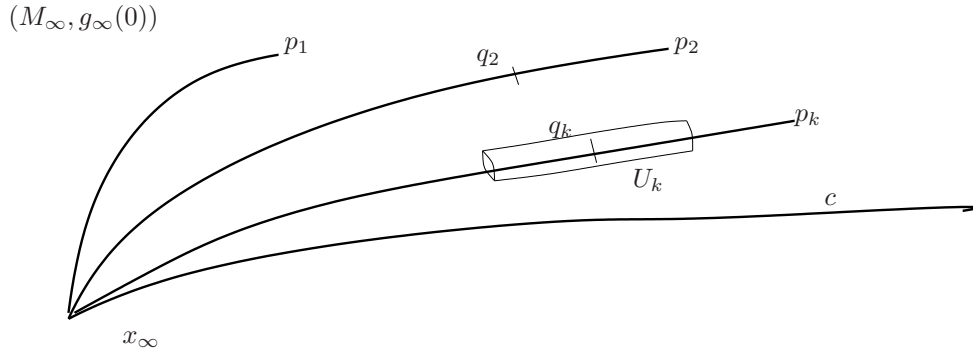

Lemma 9.3. For k large enough, c traverses U_k .

Proof. Assume it does not. Recall that $g_\infty(0)$ is nonnegatively curved. Consider a geodesic triangle $x_\infty q_k c(t)$ for $t \geq 10C_0$. Choose k large enough so that $\angle(p_k x_\infty c(t)) \leq \pi/100$. Let S_- (resp. S_+) be the component of ∂U_k

which is closest to (resp. farthest from) x_∞ . By comparison with a Euclidean triangle, we see that $\liminf_{t \rightarrow \infty} \angle(x_\infty q_k c(t)) \geq \pi$.

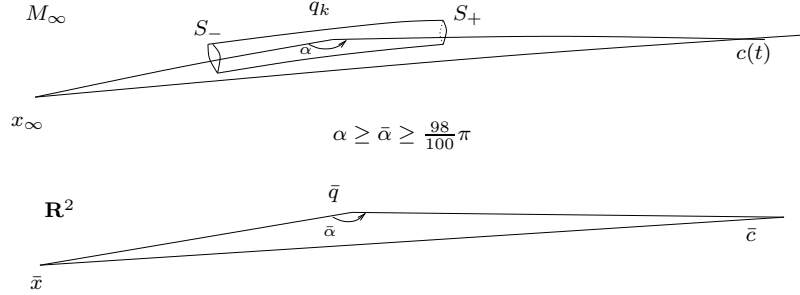

Fix t large enough so that this angle is greater than $98/100\pi$. Then $q_k c(t)$ intersects S_+ . The loop γ obtained by concatenating $x_\infty q_k$, $q_k c(t)$ and $c(t)x_\infty$ has odd intersection number with S_+ . This implies that S_+ is nonseparating. This contradiction proves Lemma 9.3. \square

We proceed with the proof of Step 2. Pick k_0 large enough so that U_k is traversed by c , and let S_0 be the middle sphere of U_{k_0} . Let $a_0, a'_0 \in S_0$ be two points maximally distant from each other. Call a_k, a'_k the respective intersections of the segments $[a_0 c(t)]$ and $[b_0 c(t)]$ with the middle sphere S_k of U_k .

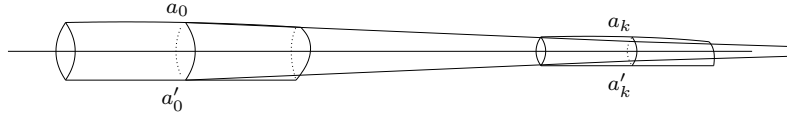

By comparison with Euclidian triangles, when t is large enough, the distance between a_k and a'_k is greater than $1/2 d_\infty(a_0, a'_0)$. Thus we have

$$\text{diam}(S_k) \geq d_\infty(a_k, a'_k) \geq 1/2 d_\infty(a_0, a'_0) = 1/2 \text{diam}(S_0).$$

Now the diameter of S_k is close to $\pi\sqrt{2}R_\infty(q_k, 0)^{-1}$ and tends to 0 by hypothesis, which gives a contradiction. This completes the proof of Step 2. \square

Applying again Lemma 9.2 and the distance-curvature Lemma, there exists $\tau > 0$ such that $(\bar{M}_k, \bar{g}_k(t), (\bar{x}_k, 0))$ converges to some Ricci flow on $M_\infty \times [-\tau, 0]$. Define

$$\tau_0 := \sup\{\tau \geq 0, \exists K(\tau), \forall \rho > 0, \exists k(\rho, \tau) \text{ s.t. } B(\bar{x}_k, 0, \rho) \times [-\tau, 0] \text{ is unscathed and has curvature bounded by } K(\tau) \text{ for } k \geq k(\rho, \tau)\}.$$

We already know that $\tau_0 > 0$. The compactness theorem A.1 enables us to construct a flow $g_\infty(\cdot)$ on $M_\infty \times (-\tau_0, 0]$, which is a pointed limit of the flows $(\bar{M}_k, \bar{g}_k(\cdot))$. Moreover, passing to the limit, we see that the scalar curvature of g_∞ is bounded by $K(\tau)$ on $(-\tau, 0]$ for all $\tau \in [0, \tau_0)$.

Step 3. There exists $Q > 0$ such that the curvature of $g_\infty(t)$ is bounded above by Q for all $t \in (-\tau_0, 0]$.

Proof. We know that $g_\infty(t)$ is nonnegatively curved and has the above-mentioned ‘weak canonical neighbourhood property’. We show that the conclusion of the curvature-distance theorem holds on M_∞ , at points of scalar curvature > 1 . For this, we let $p \in M_\infty$ and $t \in (-\tau_0, 0]$ be such that $R_\infty(p, t) > 1$. Then there exists a sequence (\bar{p}_k, t_k) , where $\bar{p}_k \in \bar{M}_k$, converging to (p, t) and such that $R(\bar{p}_k, t_k) \geq 1$ for k large enough. As a consequence, they satisfy the hypotheses of the curvature-distance theorem as explained in the proof of Step 1. Passing to the limit, we deduce that for every $A > 0$, there exists $\Lambda(A) > 0$ such that for all $q \in M_\infty$,

$$\frac{R_\infty(q, t)}{R_\infty(p, t)} \leq \Lambda(d_\infty(p, q, t)R_\infty(p, t)^{-1}). \quad (10)$$

Let us estimate the variation of curvatures and distances on $M_\infty \times (-\tau_0, 0]$. We recall Hamilton’s Harnack inequality for the scalar curvature (cf. [KL08, Appendix F])

$$\frac{\partial R_\infty}{\partial t} + \frac{R_\infty}{t + \tau_0} \geq 0,$$

which implies

$$R_\infty(\cdot, t) \leq K(0) \frac{\tau_0}{t + \tau_0}.$$

Ricci curvature, which is positive, satisfies a similar estimate, which implies

$$\text{const} \left(\frac{\tau_0}{t + \tau_0} \right) g_\infty \leq \frac{\partial g_\infty}{\partial t} \leq 0,$$

thus

$$\text{const} \sqrt{\frac{\tau_0}{t + \tau_0}} \leq \frac{\partial d_\infty}{\partial t}(x, y, t) \leq 0.$$

By integration we obtain

$$|d_\infty(x, y, t) - d_\infty(x, y, 0)| \leq C.$$

Since M_∞ is nonnegatively curved, there exists $D > 0$ such that for all $y \in M_\infty$, if $d_\infty(x_\infty, y, 0) > D$, then there exists $z \in M_\infty$ such that

$$d_\infty(y, z, 0) = d_\infty(x_\infty, y, 0) \text{ and } d_\infty(x_\infty, z, 0) \geq 1.99d_\infty(x, y, 0) \quad (11)$$

i.e. the points x_∞, y, z almost lie on a line. (Note that this is true even if M_∞ is compact, because then it is vacuous!)

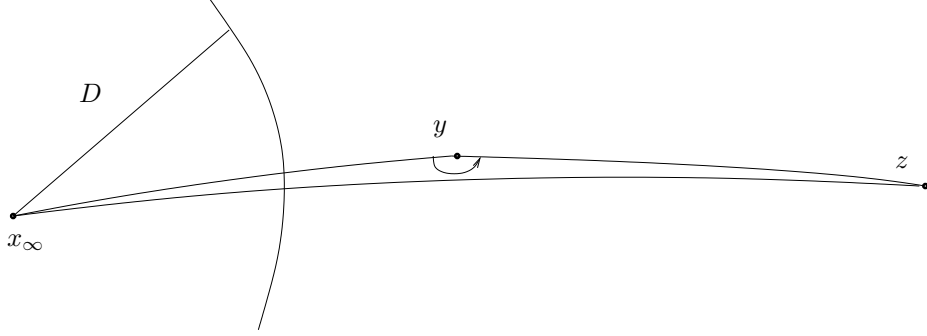

By comparison with Euclidean space, if D is large enough we have $\pi - 1/100 \leq \angle(x_\infty y z) \leq \pi$ for any such y and z . Observe that since $|d_\infty(\cdot, \cdot, t) - d_\infty(\cdot, \cdot, 0)| < C$ uniformly in t , we can choose $D \gg C$ large enough so that, for all $t \in (-\tau_0, 0]$, we have

$$|d_\infty(y, z, t) - d_\infty(x_\infty, y, t)| < 2C \text{ and } d_\infty(x_\infty, z, t) \geq 1.98d_\infty(x_\infty, y, t),$$

thus $\angle_t(x_\infty y z) \geq \pi - 1/50$.

Let us show that the scalar curvature of $g_\infty(t)$ is uniformly bounded above on $M_\infty \setminus B_\infty(x_\infty, 0, 2D)$. We argue by contradiction. Suppose that there exists (y_i, t_i) such that $d_\infty(x_\infty, y_i, 0) > 2D$ and such that $R_\infty(y_i, t_i) \xrightarrow{i \rightarrow +\infty} +\infty$. Each (y_i, t_i) has a weak $(3\varepsilon_0, C_0)$ -canonical neighbourhood. If this neighbourhood is a $(3\varepsilon_0, C_0)$ -cap, then we let y'_i be the centre of its $3\varepsilon_0$ -neck. Since the diameter for $g(t_i)$ of the cap is small (less than $4C_0 R_\infty(y_i, t_i)^{-1} < C$ for large i), we still have (for large i):

$$\begin{aligned} d_\infty(x_\infty, y'_i, 0) &\geq d_\infty(x_\infty, y'_i, t_i) - C \\ &\geq d_\infty(x_\infty, y_i, t_i) - 2C \\ &\geq d_\infty(x_\infty, y_i, 0) - 3C > D. \end{aligned}$$

Furthermore, the curvature of $R_\infty(y'_i, t_i) \geq \frac{1}{3C_0} R_\infty(y_i, t_i)$ tends to $+\infty$. Up to replacing y_i by y'_i , we may assume that there exists a sequence (y_i, t_i) such that $d_\infty(x_\infty, y_i, 0) > D$, $R_\infty(y_i, t_i) \xrightarrow{i \rightarrow +\infty} +\infty$ and (y_i, t_i) is centre of a $3\varepsilon_0$ -neck U_i . For each $i \in \mathbf{N}$, pick $z_i \in M_\infty$ satisfying (11). By the above remark, $\angle_{t_i}(x_\infty y_i z_i) \geq \pi - \frac{1}{50}$.

The points x_∞ and z_i being outside U_i , we deduce that $x_\infty y_i$ and $y_i z_i$ each intersect some component ∂U_i . Let S_i be the middle sphere of U_i . This sphere separates x_∞ from z_i in the sense that any curve connecting x_∞ to

z_i passes through S_i . Indeed, otherwise the loop obtained by concatenating $[x_\infty y_i]$, $[y_i z_i]$ and $[z_i x_\infty]$ would have odd intersection number with S_i . As before this leads to a contradiction.

Now $\text{diam}(S_i, t_i) \rightarrow 0$ since $R_\infty(y_i, t_i) \rightarrow +\infty$ as $i \rightarrow +\infty$. Since $g_\infty(t)$ is nonnegatively curved, distances are nonincreasing in t . As a consequence,

$$\text{diam}(S_i, 0) \xrightarrow{i \rightarrow +\infty} 0 .$$

At time 0 the curvature bounds and the hypothesis of κ -noncollapsing imply a uniform lower bound on the injectivity radius. Then for large i , the diameter of S_i is less than the injectivity radius of $g_\infty(0)$. This implies that S_i bounds a 3-ball which contains neither x_∞ nor z_i . Hence we can connect x_∞ to z_i by an arc which avoids S_i .

This implies that the curvature is bounded outside the $g_\infty(0)$ -ball of radius $2D$ around x_∞ . We deduce a uniform curvature bound on $(-\tau_0, 0]$ in the ball using Equation (10). \square

Step 4. We have $\tau_0 = +\infty$.

Proof. Consider a subsequence $(\bar{M}_k \times (-\tau_0, 0], \bar{g}_k(t), (x_k, 0))$ that converges to $(M_\infty \times (-\tau_0, 0], g_\infty(t), (x_\infty, 0))$. Since the limit has scalar curvature bounded above by Q we deduce that (up to replacing Q by $Q+1$), for all $0 < \tau < \tau_0$, for all $\rho > 0$, there exists $k'(\tau, \rho) \in \mathbf{N}$ such that for all $k \geq k'(\tau, \rho)$, the parabolic neighbourhood $P_{\bar{g}_k}(x_k, 0, \rho, -\tau)$ is scathed and has scalar curvature $\leq Q$.

Suppose that $\tau_0 < +\infty$ and let $0 < \sigma < (4C_0(Q+2))^{-1}$. Then up to extracting a subsequence, for every $K > 0$, there exists $\rho = \rho(\sigma, K)$ such that $P_k := P_{\bar{g}_k}(x_k, 0, \rho, -(\tau_0 + \sigma))$ is scathed or does not have curvature bounded above by K .

Set $K := 2(Q+2)$ and $\rho := \rho(\sigma, K)$. If $k \geq k'(\tau_0 - \sigma, \rho)$, then P_k is scathed. Indeed, if $k \geq k'(\tau_0 - \sigma, \rho)$, we have $R \leq Q$ on $P_{\bar{g}_k}(x_k, 0, \rho, -\tau_0 + \sigma)$. If P_k is unscathed, the curvature-time lemma (6.2) applied between $-\tau_0 + \sigma$ and $-\tau_0 - \sigma$ (since $2\sigma \leq (2C_0(Q+2))^{-1}$) implies that $R \leq 2(Q+2)$ on P_k , which excludes the second alternative.

Thus there exists $x'_k \in \bar{B}_k(x_k, 0, \rho)$, and $t_k \in [-\tau_0 - \sigma, -\tau_0 + \sigma]$, assumed to be maximal, such that $\bar{g}_k(t_k) \neq \bar{g}_{k+}(t_k)$ at x'_k . Since $B(x_k, 0, \rho) \times (t_k, 0]$ is unscathed, the above argument shows that $R \leq 2(Q+2)$ on this set, for all sufficiently large k . This implies an upper bound on the Riemann tensor on this set and hence by Lemma 9.2 the parabolic neighbourhood $P_{\bar{g}_k}(x_k, 0, \rho, t_k)$ is unscathed. This contradicts the definition of t_k . \square

We can now finish the proof of Proposition B: since $\tau_0 = +\infty$, the flow $(M_\infty, g_\infty(\cdot))$ is defined on $(-\infty, 0]$, and has bounded, nonnegative curvature

operator. Moreover, the rescaled evolving metric $\bar{g}_k(\cdot)$ is κ -noncollapsed on scales less than $\sqrt{R(x_k, b_k)}r_0$, so passing to the limit we see that $g_\infty(\cdot)$ is κ -noncollapsed on all scales. The metric $g_\infty(\cdot)$ is not flat since it has scalar curvature 1 at the point $(x_\infty, 0)$.

This shows that $(M_\infty, g_\infty(\cdot))$ is a κ -solution. By Theorem 4.1 and the choice of constants in Subsection 4.3, every point of M_∞ has an $(\frac{\varepsilon_0}{2}, \frac{C_0}{2})$ -canonical neighbourhood. Hence for sufficiently large k , $(\bar{x}_k, 0)$ has an (ε_0, C_0) -canonical neighbourhood. This contractiction finishes the proof of Proposition B.

10 Proof of Proposition C

We recall the statement:

Proposition C. For all $Q_0, \rho_0 > 0$ and all $0 \leq T_A < T_\Omega$ there exists $\kappa = \kappa(Q_0, \rho_0, T_A, T_\Omega)$ such that for all $0 < r < 10^{-3}$ there exists $\bar{\delta}_C = \bar{\delta}_C(Q_0, \rho_0, T_A, T_\Omega, r) > 0$ such that the following holds.

Let $0 < \delta \leq \bar{\delta}_C$ and $b \in (T_A, T_\Omega]$, and $(M(\cdot), g(\cdot))$ be a (r, δ) -surgical solution defined on $[T_A, b)$ such that $g(T_A)$ satisfies $|\text{Rm}| \leq Q_0$, has injectivity radius at least ρ_0 , ϕ_A -almost nonnegative curvature and satisfies $R_{\min}(g_0) \geq -6/(4T_A + 1)$. Then $g(\cdot)$ satisfies $(NC)_\kappa$.

Note that by Cheeger's theorem and standard estimates on Ricci flow, there exists a constant κ_{norm} depending only on the normalisation of the initial condition, i.e. Q_0, ρ_0 , such that $(M(\cdot), g(\cdot))$ satisfies $(NC)_{\kappa_{\text{norm}}}$ on $[T_A, T_A + 2^{-4}Q_0^{-1}]$.

We set $\kappa_0 := \min(\kappa_{\text{norm}}, \kappa_{\text{sol}}/2, \kappa_{\text{st}}/2)$.

10.1 Preliminaries

Let $v_k(\rho)$ denote the volume of a ball of radius ρ in the model space of constant sectional curvature k and dimension n .

Let $\kappa > 0$. One says that a Riemannian ball $B(x, \rho)$ is κ -noncollapsed if $|\text{Rm}| \leq \rho^{-2}$ on $B(x, \rho)$ and if $\text{vol}B(x, \rho) \geq \kappa\rho^3$. Similarly, a parabolic ball $P(x, t, \rho, -\rho^{-2})$ is κ -noncollapsed if $|\text{Rm}| \leq \rho^{-2}$ on $P(x, t, \rho, -\rho^{-2})$ and $\text{vol}B(x, t, \rho) \geq \kappa\rho^3$.

We recall the following elementary lemma from [BBB⁺, Section 8.1].

Lemma 10.1. *i. If $B(x, \rho)$ is κ -noncollapsed, then for every $\rho' \in (0, \rho)$, $B(x, \rho')$ is $C\kappa$ -noncollapsed, where $C := \frac{v_0(1)}{v_{-1}(1)}$. The same property holds for $P(x, t, \rho', -\rho'^2) \subset P(x, t, \rho, -\rho^2)$.*

ii. Let r, δ be surgery parameters and $g(\cdot)$ be an (r, δ) -surgical solution. Assume that $P_0 = P(x_0, t_0, \rho_0, -\rho_0^2)$ is a scathed parabolic neighbourhood such that $|\text{Rm}| \leq \rho_0^{-2}$ on P_0 . Then P_0 is $e^{-12}\kappa_{st}/2$ -noncollapsed.

Remark.

- From (i), we deduce that in order to establish noncollapsing at some point (x, t) on all scales ≤ 1 , it suffices to do it on the maximal scale $\rho \leq 1$ such that $|\text{Rm}| \leq \rho^{-2}$ on $P(x, t, \rho, \rho^{-2})$. This observation will be useful later.
- If some metric ball $B(y, \rho)$ is contained in a (ε, C_0) -canonical neighbourhood which is not ε_0 -round and satisfies $|\text{Rm}| \leq \rho^{-2}$, then $B(y, \rho)$ is C_0^{-1} -noncollapsed on the scale ρ by (4).

10.2 The proof

We turn to the proof of Proposition C.

Let M_{reg} be the set of regular points in spacetime. This is an open, arcwise connected 4-manifold. Likewise we let M_{sing} be the set of singular points in spacetime. Let $\gamma : [t_0, t_1] \rightarrow \bigcup_t M(t)$ be a map such that $\gamma(t) \in M(t)$ for every t . Let $\bar{t} \in [t_0, t_1]$. Here we adopt the convention that $M_+(t) = M(t)$ if t is regular.

Definition. One says that γ is *continuous at \bar{t}* if there is $\sigma > 0$ such that

- 1) $t \rightarrow \gamma(t) \in M(\bar{t})$ on $[\bar{t} - \sigma, \bar{t})$ and is left continuous at \bar{t}
- 2) $t \rightarrow \gamma(t) \in M_+(\bar{t})$ on $]\bar{t}, \bar{t} + \sigma]$ and has a right limit at \bar{t} denoted $\gamma_+(\bar{t})$
- 3) Assume $\bar{t} < t_1$. If $\gamma(\bar{t}) \in M_{\text{reg}}(\bar{t})$, then $\gamma(\bar{t}) = \gamma_+(\bar{t})$ under the identification of $M_{\text{reg}}(\bar{t})$ and $M(\bar{t}) \cap M_+(\bar{t})$; if $\gamma(\bar{t}) \in S \subset \mathcal{S}$, then $\gamma(\bar{t}) = \gamma_+(\bar{t})$ under the identification of S and the corresponding component of $\partial M \cap M_+(\bar{t})$.

In particular, if $\gamma(\bar{t}) \in M_{\text{sing}}(\bar{t}) \setminus \mathcal{S}$ for $\bar{t} < t_1$, it is not continuous at \bar{t} . Indeed, $\gamma(\bar{t})$ disappears at time \bar{t} .

We say that γ is *unscathed* if $\gamma(t) \in M_{\text{reg}}(t)$ for all $t \in [t_0, t_1]$. Otherwise γ is *scathed*.

We adapt the arguments from the smooth case, replacing Perelman's reduced volume \tilde{V} ([Per02, Section 7]) by:

$$\tilde{V}_{\text{reg}}(\tau) := \int_{Y(\tau)} \tau^{-3/2} e^{-\ell(\mathcal{L} \exp(v), \tau)} J(v, \tau) dv,$$

where $\tau = t_0 - t$ and

$$Y(\tau) := \{v \in T_{x_0} M \mid \mathcal{L} \exp(v) : [0, \tau] \rightarrow M \text{ is minimal and unscathed} \}.$$

Let (x_0, t_0) be a point. By Lemma 10.1 and the remark following this lemma, we restrict attention to the scale $\rho_0 \leq 1$ which is maximal such that $|\text{Rm}| \leq \rho_0^{-2}$ on $P_0 := P(x_0, t_0, \rho_0, -\rho_0^2)$ and assume that P_0 is unscathed.

As before we set $B_0 := B(x_0, t_0, \rho_0)$.

10.3 The case $\rho_0 \geq \frac{r}{100}$

Lemma 10.2. *Let \hat{r}, Δ, Λ be positive numbers. Then there exists $\bar{\delta} = \bar{\delta}(\hat{r}, \Delta, \Lambda) > 0$ with the following property. Let $(M(\cdot), g(\cdot))$ be an (r, δ) -surgical solution on an interval $I = [a, a + \Delta]$ with $\delta \leq \bar{\delta}$ and $r \geq \hat{r}$ on I . Let $(x_0, t_0) \in M \times I$ and $\rho_0 \geq \hat{r}$ be such that $P_0 := P(x_0, t_0, \rho_0, -\rho_0^2) \subset M \times I$ is unscathed and $|\text{Rm}| \leq \rho_0^{-2}$ on P_0 .*

Let γ be a continuous spacetime curve defined on $[t_1, t_0]$ with $t_1 \in [0, t_0]$ and such that $\gamma(t_0) = x_0$ and γ is scathed. Then $\mathcal{L}_{t_0-t_1}(\gamma) \geq \Lambda$.

Here $\mathcal{L}_{t_0-t_1}$ denotes the \mathcal{L} -length based at (x_0, t_0) , that is

$$\mathcal{L}_{t_0-t_1}(\gamma) = \int_{t_1}^{t_0} \sqrt{t_0 - t} (R(\gamma(t), t) + |\dot{\gamma}(t)|_{g(t)}^2) dt.$$

Proof. To prove the lemma, it suffices to obtain one of the two inequalities:

$$\int_{t_1}^{t_0} \sqrt{t_0 - t} R(\gamma(t), t) dt \geq \Lambda, \quad (12)$$

$$\int_{t_1}^{t_0} \sqrt{t_0 - t_1} |\dot{\gamma}(t)|_{g(t)}^2 dt \geq \Lambda + 4\Delta^{3/2} =: \Lambda'. \quad (13)$$

Indeed $\mathcal{L}_{t_0-t_1}(\gamma) \geq \int_{t_1}^{t_0} \sqrt{t_0 - t} R(\gamma(t), t) dt$, hence (12) implies the lemma. For (13), this comes from the fact that $R \geq -6$, hence

$$\int_{t_1}^{t_0} \sqrt{t_0 - t} R dt \geq -4[\tau^{3/2}]_0^{t_0-t_1} \geq -4\Delta^{3/2}.$$

Intuitively, those two conditions mean that a curve has large \mathcal{L} -length if it has large energy (which is the case if it moves very fast or goes a very long way), or if it stays long enough in an area of large scalar curvature.

Since γ is scathed, it cannot remain in P_0 . We shall make a first dichotomy according to whether γ goes out very fast or not.

Set

$$\alpha := \min \left\{ \left(\frac{\hat{r}}{4\Lambda'} \right)^2, 10^{-2} \right\} \in (0, 10^{-2}).$$

Case 1: There exists $t' \in [t_0 - \alpha\rho_0^2, t_0]$ such that $\gamma(t') \notin B_0$.

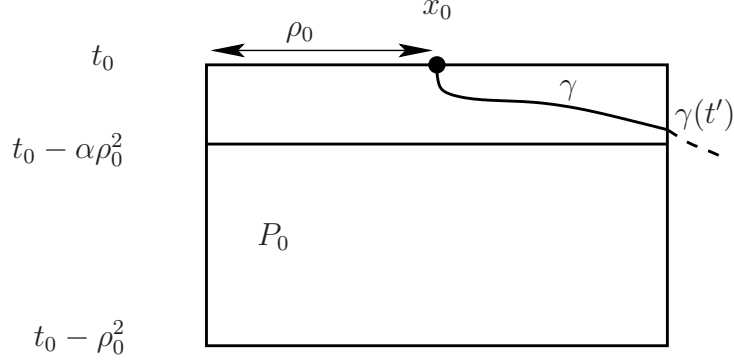

Choose t' maximal with this property. We then have

$$\int_0^{t_0-t'} |\dot{\gamma}| d\tau \leq \left(\int \sqrt{\tau} |\dot{\gamma}|^2 \right)^{1/2} \left(\int \frac{1}{\sqrt{\tau}} \right)^{1/2},$$

so

$$\int_0^{\tau_1} \sqrt{\tau} |\dot{\gamma}|^2 d\tau \geq \int_0^{t_0-t'} \sqrt{\tau} |\dot{\gamma}|^2 d\tau \geq \left(\int_0^{t_0-t'} |\dot{\gamma}| d\tau \right)^2 \left(\int_0^{t_0-t'} \frac{1}{\sqrt{\tau}} d\tau \right)^{-1}.$$

On $(t', t_0]$, we have $\gamma \subset P_0$. Since P_0 is unscathed, we have

$$g(t_0)e^{-4\rho_0^{-2}(t_0-t')} \leq g(t) \leq g(t_0)e^{4\rho_0^{-2}(t_0-t')},$$

hence

$$\frac{1}{2}g(t_0) \leq e^{-4\alpha}g(t_0) \leq g(t) \leq e^{4\alpha}g(t_0) \leq 2g(t_0).$$

Since $\gamma(t') \notin B_0$,

$$\int_0^{t_0-t'} |\dot{\gamma}|_{g(t_0-\tau)} \geq \frac{1}{\sqrt{2}} \int_0^{t_0-t'} |\dot{\gamma}|_{g(t_0)} \geq \frac{\rho_0}{\sqrt{2}},$$

so

$$\int_0^{t_0-t'} |\dot{\gamma}|^2 \sqrt{\tau} d\tau \geq \frac{\rho_0^2}{2} ([2\sqrt{\tau}]_0^{t_0-t'})^{-1} \geq \frac{\rho_0}{4\sqrt{\alpha}} \geq \frac{\hat{r}}{4\sqrt{\alpha}}.$$

By choice of α , this last quantity is bounded below by Λ' . This shows that γ satisfies Inequality (13).

Remark. In this case, there is no constraint on δ .

Case 2: For all $t \in [t_0 - \alpha\rho_0^2, t_0]$, $\gamma(t) \in B_0$.

Since γ is scathed, there exists (\bar{x}, \bar{t}) such that $\gamma(\bar{t}) \notin M_{\text{reg}}(\bar{t})$. Since P_0 is unscathed, we have $\bar{t} < t_0 - \alpha\rho_0^2$. Since γ is continuous and defined after \bar{t} , we have $\gamma(\bar{t}) \in \partial M_{\text{sing}}(\bar{t}) \subset \mathcal{S}(\bar{t})$. Assume that \bar{t} is maximal for this property. We have $R(\bar{x}, \bar{t}) \approx h^{-2}$, where, for the sake of simplicity we set $h := h(\bar{t})$. We may choose $\bar{\delta}$ small enough (depending on \hat{r}) so as to make h so small that $R(\bar{x}, \bar{t})$ is strictly greater than $12\hat{r}^{-2} \geq 12\rho_0^{-2}$.

For constants $\theta \in [0, 1)$ and $A \gg 1$ to be chosen later, we set

$$P := P_+(\bar{x}, \bar{t}, Ah, \theta h^2)$$

and take $\bar{\delta} \leq \bar{\delta}_{\text{per}}(A, \theta, r)$, so that Theorem 8.1 applies. In particular, we have $R \geq \frac{1}{2}h^{-2} > 6\rho_0^{-2}$ on P . This implies that $P_0 \cap P = \emptyset$.

We distinguish two subcases.

Subcase i: $\gamma([\bar{t}, \bar{t} + \theta h^2]) \subset B(\bar{x}, \bar{t}, Ah)$.

Then by Theorem 8.1, P is unscathed. Indeed, otherwise $B_{g_+(\bar{t})}(\bar{x}, Ah) \subset \Sigma_{t'}$ for some $t' \in (\bar{t}, \bar{t} + \theta h^2)$. Hence $\gamma(t') \in \Sigma_{t'}$, which contradicts our choice of \bar{t} .

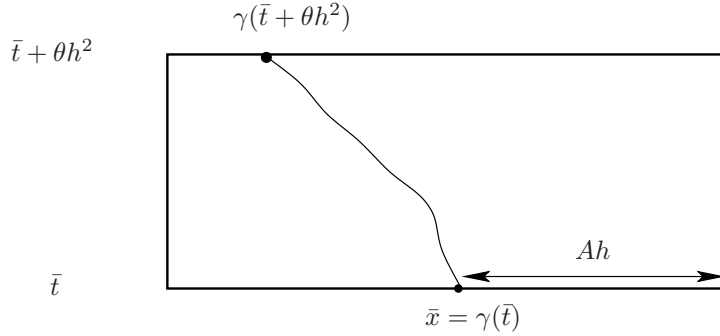

Moreover, $\bar{t} + \theta h^2 \leq t_0 - \alpha\rho_0^2$, so $t_0 - t \geq \alpha\rho_0^2$ for all $t \in [\bar{t}, \bar{t} + \theta h^2]$.

Closeness with the standard solution implies

$$\begin{aligned}
\int_{\bar{t}}^{\bar{t}+\theta h^2} \sqrt{t_0-t} R \, dt &\geq \frac{\text{const}_{\text{st}}}{2} \int_{\bar{t}}^{\bar{t}+\theta h^2} \sqrt{t_0-t} \frac{h^{-2}}{1-(t-\bar{t})h^{-2}} \, dt \\
&\geq \text{const}_{\text{st}} \frac{\sqrt{\alpha \rho_0^2}}{2} \int_{\bar{t}}^{\bar{t}+\theta h^2} \frac{h^{-2}}{1-(t-\bar{t})h^{-2}} \, dt \\
&= \text{const}_{\text{st}} \frac{\sqrt{\alpha \rho_0^2}}{2} \int_0^\theta \frac{1}{1-u} \, du \\
&\geq -\text{const}_{\text{st}} \frac{\sqrt{\alpha \hat{r}}}{2} \ln(1-\theta) \\
&\geq \Lambda',
\end{aligned}$$

for θ close enough to 1, depending only on \hat{r}, Δ, Λ .

We deduce

$$\begin{aligned}
\int_{t_1}^{t_0} \sqrt{t_0-t} R \, dt &= \int_{\bar{t}}^{\bar{t}+\theta h^2} \sqrt{t_0-t} R \, dt + \int_{t_1}^{\bar{t}} \sqrt{t_0-t} R \, dt + \int_{\bar{t}+\theta h^2}^{t_0} \sqrt{t_0-t} R \, dt \\
&\geq \Lambda' - 4\Delta^{3/2} = \Lambda.
\end{aligned}$$

Hence Inequality (12) holds. Fix $\theta := \theta(\hat{r}, \Delta, \Lambda)$ such that this condition is satisfied.

Subcase ii: There exists $t' \in [\bar{t}, \bar{t} + \theta h^2]$ such that $\gamma(t') \notin B(\bar{x}, \bar{t}, Ah)$.

We assume that t' is minimal with this property. By the same argument as before, $P' := P + (\bar{x}, \bar{t}, Ah, t')$ is unscathed, and A^{-1} -close to the standard solution by the persistence theorem. As before, this implies that for all $s, s' \in (\bar{t}, t']$,

$$g(s) \leq e^{\frac{C}{1-\theta}} g(s'),$$

where C is a universal constant. Thus we have

$$\int_{\bar{t}}^{t'} \sqrt{\tau} |\dot{\gamma}|_{g(t)}^2 \geq e^{\frac{-C}{1-\theta}} \left(\int |\dot{\gamma}|_{g(\bar{t})} \right)^2 \left(\int \frac{1}{\sqrt{\tau}} \right)^{-1}.$$

Since $t' \leq t_0 - \alpha \rho_0^2$ we bound τ from below by $\alpha \rho_0^2$ on $[\bar{t}, t']$, so

$$\int_{\bar{t}}^{t'} \sqrt{\tau} |\dot{\gamma}|^2 \geq e^{\frac{-C}{1-\theta}} (Ah)^2 \sqrt{\alpha \rho_0^2} (t' - \bar{t})^{-1} \geq e^{\frac{-C}{1-\theta}} (Ah)^2 \frac{\hat{r}}{10} \sqrt{\alpha} \frac{1}{\theta h^2} = e^{\frac{-C}{1-\theta}} \sqrt{\alpha} \frac{\hat{r} A^2}{10\theta}.$$

Fixing A large enough, Inequality (13) holds. \square

A consequence of the previous lemma is the following result (see [KL08, Lemmas 78.3 and 78.6] or [BBB⁺] for more details).

Lemma 10.3. *Let \hat{r}, Δ, Λ be positive numbers. There exists $\bar{\delta} := \bar{\delta}(\hat{r}, \Delta, \Lambda)$ with the following property. Let $g(\cdot)$ be a (r, δ) -surgical solution defined on $[a, a + \Delta]$ such that $r \geq \hat{r}$ and $\delta \leq \bar{\delta}$. Let (x_0, t_0) and $\rho_0 \geq \hat{r}$ be such that $P_0 := P(x_0, t_0, \rho_0, -\rho_0^2)$ is unscathed and $|\text{Rm}| \leq \rho_0^{-2}$ on P_0 . Then*

- i. $\forall (q, t) \in M \times [a, a + \Delta]$, if $\ell(q, t_0 - t) < \Lambda$, then there is an unscathed minimising \mathcal{L} -geodesic γ connecting x_0 to q .*
- ii. $\forall \tau > 0$, $\min_q \ell(q, \tau) \leq 3/2$ and is attained.*

We come back to the proof of Proposition C. Recall that P_0 is unscathed, and satisfies $|\text{Rm}| \leq \rho_0^{-2}$. The arguments of [Per02, §7] apply to unscathed minimising \mathcal{L} -geodesics. In particular, if $\gamma(\tau) = \mathcal{L}_\tau \exp_{(x_0, t_0)}(v)$ is minimising and unscathed on $[0, \tau_0]$, then $\tau^{-3/2} e^{-\ell(v, \tau)} J(v, \tau)$ is nonincreasing on $[0, \tau_0]$.

Define

$$Y(\tau) := \{v \in T_{x_0} M; \mathcal{L} \exp(v) : [0, \tau] \longrightarrow M \text{ is minimising and unscathed} \}.$$

It is easy to check that $\tau \leq \tau' \Rightarrow Y(\tau) \supset Y(\tau')$. Then we set

$$\tilde{V}_{\text{reg}}(\tau) := \int_{Y(\tau)} \tau^{-3/2} e^{-\ell(v, \tau)} J(v, \tau) dv.$$

This function is nondecreasing on $[0, t_0]$. We shall adapt the proof of κ -noncollapsing in the smooth case, replacing \tilde{V} by \tilde{V}_{reg} . Set

$$\kappa := \frac{\text{vol}_{g(t_0)} B_0}{\rho_0^3}, \quad \tau_0 = \kappa^{1/3} \rho_0^2.$$

Upper bound on $\tilde{V}_{\text{reg}}(\tau_0)$: As in the smooth case, we get

$$\mathcal{L}_\tau \exp(\{v \in Y(\tau); |v| \leq \frac{1}{10} \kappa^{-1/6}\}) \subset B_0$$

thus

$$I := \int_{\{v \in Y(\tau); |v| \leq \frac{1}{10} \kappa^{-1/6}\}} \tau^{-3/2} e^{-\ell(v, \tau)} J(v, \tau) dv \leq e^{C\kappa^{1/6}} \sqrt{\kappa}$$

and

$$\begin{aligned} I' &:= \int_{\{v \in Y(\tau); |v| \geq \frac{1}{10} \kappa^{-1/6}\}} \tau^{-3/2} e^{-\ell(v, \tau)} J(v, \tau) dv \\ &\leq \int_{\{v \in Y(\tau); |v| \geq \frac{1}{10} \kappa^{-1/6}\}} \lim_{\tau \rightarrow 0} (\tau^{-3/2} e^{-\ell(v, \tau)} J(v, \tau)) dv \\ &\leq e^{-\frac{1}{10} \kappa^{-1/6}}. \end{aligned}$$

In conclusion,

$$\begin{aligned} I + I' &\leq e^{C\kappa^{1/3}} \sqrt{\kappa} + e^{-\frac{1}{10}\kappa^{-1/6}} \\ &\leq C\sqrt{\kappa} \end{aligned}$$

for $\kappa \leq \kappa(3)$ and some universal C .

Lower bound for $\tilde{V}_{\text{reg}}(t_0)$ Monotonicity of $\tilde{V}_{\text{reg}}(\tau_0)$ implies

$$\tilde{V}_{\text{reg}}(\tau_0) \geq \tilde{V}_{\text{reg}}(t_0).$$

We are going to bound $\tilde{V}_{\text{reg}}(t_0)$ from below as a function of $\text{vol}B(q_0, 0, 1)$, where $q_0 \in M$.

Set $\Lambda := 21$ and apply Lemma 10.3 with parameter $\bar{\delta}(\hat{r}, T, \Lambda)$. There exists $q_0 \in M$ such that $\ell(q_0, t_0 - \frac{1}{16}) \leq \frac{3}{2}$ and the first part of Lemma 10.3 gives us a minimising curve γ connecting x_0 to q_0 realising the minimum $\ell(q_0, t_0 - 1/16)$. Let $q \in B(q_0, 0, 1)$. Consider a curve γ obtained by concatenating some $g(0)$ -geodesic from $(q, 0)$ to $(q_0, 1/16)$ with some minimising \mathcal{L} -geodesic between $(q_0, 1/16)$ and (x_0, t_0) . We have

$$\begin{aligned} \ell(q, t_0) &= \frac{L(q, t_0)}{2\sqrt{t_0}} \leq \\ &\frac{1}{2\sqrt{t_0}} L(q_0, t_0 - 1/16) + \frac{1}{2\sqrt{t_0}} \int_{t_0-1/16}^{t_0} \sqrt{\tau} (R_{g(t_0-\tau)} + |\dot{\gamma}(\tau)|_{g(t_0-\tau)}^2) d\tau, \quad (14) \end{aligned}$$

which leads to

$$\ell(q, t_0) \leq \frac{3}{2} + \frac{1}{2} \int_{t_0-1/16}^{t_0} (12 + e^{1/2} |\dot{\gamma}(\tau)|_{g(0)}^2) d\tau$$

since for $s \in [0, 1/16]$ (i.e. $\tau \in [t_0 - 1/16, t_0]$) the metrics $g(s)$ satisfy $\text{Rm} \leq 2$, hence $R \leq 12$, and are 1/2-Lipschitz equivalent. We obtain

$$\ell(q, t_0) \leq \frac{3}{2} + \frac{1}{2} \left(\frac{1}{16} 12 + 16e^{1/2} d_{g(0)}^2(q, q_0) \right) \leq 20.$$

Hence $\ell(q, t_0) < \Lambda$, and Lemma 10.3 i) re-gives an unscathed minimising \mathcal{L} -geodesic $\tilde{\gamma}$ connecting x_0 to q . Hence $q = \tilde{\gamma}(t_0) = \mathcal{L}_{t_0} \exp(\tilde{v})$ for $\tilde{v} \in Y(t_0)$. This shows that $\mathcal{L}_{t_0} \exp(Y(t_0)) \supset B(q, 0, 1)$.

Moreover, we have $\{\tilde{v} \in Y(t_0); \mathcal{L}_{t_0} \exp(\tilde{v}) \in B(q, 0, 1)\}$, $\ell \leq 10$, which implies

$$\begin{aligned} \tilde{V}_{\text{reg}}(t_0) &= \int_{Y(t_0)} t_0^{-3/2} e^{-\ell(v, t_0)} J(v, t_0) dv \geq \int_{B(q_0, 0, 1)} t_0^{-3/2} e^{-20} dv_{g(0)} \\ &\geq T^{-3/2} e^{-20} \text{vol}_{g(0)} B(q_0, 0, 1). \end{aligned}$$

10.4 The case $\rho_0 \leq \frac{r}{100}$

In this case ρ_0 is below the scale of the canonical neighbourhood for all t in the interval and hence any point with scalar curvature greater than ρ_0^{-2} has a canonical neighbourhood. At such a point the noncollapsing is given by this neighbourhood if it is not ε -round.

Since $\rho_0 < 1$, there exists $(y, t) \in \bar{P}_0$ such that $|\text{Rm}(y, t)| = \rho_0^{-2}$. Hence we have

$$|\text{Rm}(y, t)| \geq r^{-2} \geq 10^6.$$

Since $\{g(t)\}$ has curvature pinched toward positive,

$$R(y, t) \geq |\text{Rm}(y, t)| = \rho_0^{-2} \geq 10000r(t)^{-2}.$$

Hence (y, t) has an (ε_0, C_0) -canonical neighbourhood U .

Case 1: U is not ε_0 -round Let us show that $B(x_0, t, e^{-2}\rho_0) \subset U$. This is clear if U is closed, so we only have to deal with the cases of necks and caps.

By the curvature bounds on \bar{P}_0 we have $d_t(x_0, y) \leq e^2\rho_0$ and $B(x_0, t, e^{-2}\rho_0) \subset B(x_0, t_0, \rho_0)$. If U is an ε_0 -neck, then $d_t(y, \partial\bar{U}) \geq (2\varepsilon_0)^{-1}R(y, t)^{-1/2}$. Since $R(y, t) \leq 6\rho_0^{-2}$, we get

$$d_t(y, \partial\bar{U}) \geq (2\sqrt{6}\varepsilon_0)^{-1}\rho_0 \geq (e^2 + e^{-2})\rho_0,$$

hence $B(x_0, t, e^{-2}\rho_0) \subset U$.

If U is an (ε_0, C_0) -cap, write it $U = V \cap W$ where V is a core. Let $\gamma : [0, 1] \rightarrow \bar{B}_0$ be a minimising $g(t_0)$ -geodesic connecting y to x_0 . If $x_0 \notin V$, let $s \in [0, 1]$ be maximal such that $\gamma(s) \in \partial V$. Since $\gamma(s) \in B_0$, we have $R(\gamma(s), t) \geq 6\rho_0^{-2}$ and we deduce that $d(\gamma(s), \partial\bar{U}) \geq (\sqrt{6}\varepsilon_0)^{-1}\rho_0$. As $d_t(\gamma(s), x_0) \leq e^2\rho_0$ we get $B(x_0, t, e^{-2}\rho_0) \subset U$.

Comparing this to Equation (4), we see that

$$\text{vol}_{g(t)}B(x_0, t, e^{-2}\rho_0) \geq C_0^{-1}(e^{-2}\rho_0)^3.$$

By estimates on distortion of distances and volume as in the proof of Lemma 10.1, we conclude that

$$\text{vol}_{g(t_0)}B_0 \geq C_0^{-1}e^{-18}\rho_0^3.$$

Case 2: U is ε_0 -round Note that the method of Case 1 applies equally well if U is homeomorphic to S^3 or RP^3 , so we assume it is not the case.

The only thing we have to do is to prove that there are only finitely many possible topologies for U . For simplicity of notation we assume $(x_0, t_0) = (y, t)$, i.e. the point (x_0, t_0) has an ε_0 -round canonical neighbourhood U , and $|\text{Rm}(x_0, t_0)| \geq 1000r^{-2}$.

Lemma 10.4. *There exists $t'_0 < t_0$ such that*

- *U is unscathed on $[t'_0, t_0]$;*
- *for every $t \in [t'_0, t_0]$ $(U, g(t))$ is ε_0 -round;*
- *letting ρ'_0 be defined at (x_0, t'_0) in the obvious way, we have $2r \geq \rho'_0 \geq \frac{r}{2}$.*

Proof. Let $t''_0 < t_0$ be minimal such that U is unscathed and for every $t \in [t''_0, t_0]$, $(U, g(t))$ is ε_0 -round and $R \geq r^{-2}$ on $(U, g(t))$. We claim that $R_{\min} = r^{-2}$ on $(U, g(t''_0))$. Indeed by continuity $R \geq r^{-2}$ on $(U, g(t''_0))$. Hence (x_0, t''_0) has a canonical neighbourhood V . By continuity, $(U, g(t''_0))$ is $2\varepsilon_0$ -round, so $V = U$; since we have excluded S^3 and RP^3 , we deduce that V is in fact ε_0 -round. Since ε_0 -roundness is an open property, it follows that if $R_{\min} > r^{-2}$ on $(U, g(t''_0))$ then t''_0 is not minimal. This proves the claim.

By ε_0 -roundness, $R(\cdot, t''_0) \approx r^{-2}$ on U and $|\text{Rm}(\cdot, t''_0)| \approx r^{-2}/6$. Therefore we can find $t'_0 \in (t''_0, t_0)$ such that $|\text{Rm}(\cdot, t'_0)| \approx r^{-2}$ on U and $|\text{Rm}| \leq r^{-2}$ on $P(x_0, t'_0, r, -r^{-2})$ (comparing with the evolving round metric one can find t'_0 close to $t''_0 + \frac{5}{4}r^2$). It follows that the maximal radius ρ'_0 such that $|\text{Rm}| \leq \rho'^{-2}$ on $P(x_0, t'_0, \rho'_0, -\rho'^2) =: P_0$ with P_0 unscathed, is close to r . \square

Since $\rho'_0 \geq r/2$ we can argue as in subsection 10.3 to get uniform noncollapsing at (x_0, t'_0) on the unit scale. As $(U, g(t'_0))$ is ε_0 -homothetic to $(U, g(t_0))$ and $\rho'_0 \leq 2r < 1$, we also have uniform noncollapsing at (x_0, t_0) on the unit scale.

11 Generalisations and open questions

11.1 Consequences and generalisations

First we state a finiteness result which follows immediately from Theorem 5.2 and Corollary 2.2.

Corollary 11.1. *Let R_0, Q, ρ be positive numbers. Then the class of prime 3-manifolds admitting complete riemannian metrics of scalar curvature greater than R_0 , sectional curvature bounded in absolute value by Q , and injectivity radius greater than ρ is finite up to diffeomorphism.*

Remark that the primeness hypothesis is necessary: otherwise, one could have, say, a connected sum of arbitrarily many copies of the same manifold. The key point is that the geometric bounds considered here do *not* imply any diameter bound (nor compactness of the manifold for that matter.) Hence

Corollary 11.1 is not a purely geometric finiteness theorem, but rather a mixed geometrico-topological finiteness theorem.

Next we discuss an equivariant version of our main technical theorem.

Definition. Let $(M(\cdot), g(\cdot))$ be a surgical solution defined on some interval I . Let Γ be a group endowed with an action on each $M(t)$ for $t \in I$, which is constant in between singular times. We say that $(M(\cdot), g(\cdot))$ is Γ -equivariant if for each t , the action of Γ on $M(t)$ is isometric, and for each singular time t , the union of all 2-spheres along which surgery is performed is Γ -invariant.

Theorem 11.2. *Let M be an orientable 3-manifold. Let g_0 be a complete riemannian metric on M which has bounded geometry. Let Γ be a group acting properly discontinuously on M by isometries for g_0 . Then there exists a complete surgical solution $(M(\cdot), g(\cdot))$ of bounded geometry defined on $[0, +\infty)$, with initial condition $(M(0), g(0)) = (M, g_0)$, and such that there is for each t a properly discontinuous action of Γ on $M(t)$ such that $(M(\cdot), g(\cdot))$ is Γ -equivariant, and such that if t is a singular time and x a point belonging to some disappearing component, then (x, t) has an (ε_0, C_0) -canonical neighbourhood. Furthermore, if the action of Γ on M is free, then one can ensure that for each t , the action of Γ on $M(t)$ is also free.*

Proof. We repeat the proof of Theorem 5.3, paying attention to equivariance with respect to the group Γ . By the Chen-Zhu uniqueness theorem [CZ06], Ricci flow automatically preserves the symmetries of the original metric, so the only thing to check is that surgery can be done equivariantly. For this we can apply [DL09, Lemma 3.9]. Note that the constant ϵ appearing in that paper is *a priori* smaller than our ε_0 . However, it is easy to check that if we replace ε_0 by some smaller positive number ε'_0 in the proof of Theorem 5.3 and subsequently the constants β_0 and C_0 by the appropriate constants β'_0 and C'_0 , then the proof goes through without changes.

For the addendum where it is assumed that the action of Γ is free, there is an additional point to check: that surgery can be done so that the action of Γ on the post-surgery manifold is still free. For simplicity, we are going to explain this in a riemannian setting, ignoring the issue of strong necks, which is irrelevant here.

Let (X, \tilde{g}) be a 3-manifold with an isometric, free, properly discontinuous action of Γ and $\{N_i\}$ be a Γ -invariant, locally finite collection of pairwise disjoint δ -necks in X . Let (Y, g) be the quotient riemannian manifold X/Γ .

Suppose first that for each N_i and each nontrivial element $\gamma \in \Gamma$ we have $N_i \cap \gamma N_i = \emptyset$. Then the collection $\{N_i\}$ projects to a locally finite collection of pairwise disjoint δ -necks in Y . Hence we can do metric surgery on Y , obtaining a riemannian manifold (Y_+, g_+) . We then lift the construction,

getting a riemannian manifold (X_+, \tilde{g}_+) which on the one hand is obtained from (X, \tilde{g}) by metric surgery on $\{N_i\}$, and on the other hand inherits a free, properly discontinuous, isometric action of Γ .

Thus we are done unless there exists i and γ such that $N_i \cap \gamma N_i \neq \emptyset$. In this case, N_i is invariant by γ . Since γ acts freely, it must act on N_i by an involution, so that N_i projects to a cap $C \subset Y$ diffeomorphic to a punctured RP^3 . In this case, C contains, say a 4δ -neck whose preimage in X contains two 4δ -necks interchanged by γ . Thus, up to replacing δ by 4δ , we can apply the construction of the first paragraph. \square

Corollary 11.3. *Let M be a connected, orientable 3-manifold which carries a complete metric g of uniformly positive scalar curvature. Assume that the riemannian universal cover of (M, g) has bounded geometry. Then M is a connected sum of spherical manifolds and copies of $S^2 \times S^1$.*

Proof. We apply Theorem 11.2 to the universal cover of (M, g) endowed with the action of $\Gamma := \pi_1(M)$. Let $(\tilde{M}(\cdot), \tilde{g}(\cdot))$ be a surgical solution satisfying the conclusion of that theorem. By Corollary 2.2, this surgical solution must be extinct. Thus M is a connected sum of metric quotients of the disappearing components of $(\tilde{M}(\cdot), \tilde{g}(\cdot))$. There remains to check that such quotients are themselves connected sums of spherical manifolds and copies of $S^2 \times S^1$.

We use the fact that the disappearing components are covered by canonical neighbourhoods, and the action of Γ on them is isometric. Let X be such a component. Remark that X is simply-connected, since the van Kampen theorem implies that surgery along 2-spheres on a simply-connected 3-manifold produces simply-connected 3-manifolds. If X is compact, then by Perelman's Geometrisation Theorem, X is diffeomorphic to the 3-sphere, and its quotients are spherical manifolds.

If X is noncompact, then it is diffeomorphic to $S^2 \times \mathbf{R}$ or \mathbf{R}^3 . In the former case, it is an exercise in topology (cf. [Sco83]) to show that the quotient can only be $S^2 \times \mathbf{R}$ itself, a punctured RP^3 , $S^2 \times S^1$, or a connected sum of two copies of RP^3 .

In the latter case, we obviously need to use the geometry. As in [DL09, Section 3], we consider the open subset T consisting of all points that are centres of ε_0 -necks. Since X is diffeomorphic to \mathbf{R}^3 , T is an ε_0 -tube, and its complement C is the core of an ε_0 -cap and diffeomorphic to the 3-ball. By definition, T is automatically invariant by any isometry. Hence C is also invariant by any isometry. Thus by the Brouwer fixed point theorem, X does not admit any nontrivial free isometric group action. \square

Here is a more precise theorem which may be useful for subsequent applications:

Theorem 11.4. *There exist sequences $r_k, \delta_k, \kappa_k > 0$ such that for any complete normalised riemannian 3-manifold (M_0, g_0) , there exists a surgical solution $(M(\cdot), g(\cdot))$ defined on $[0, +\infty)$, satisfying the initial condition $(M(0), g(0)) = (M_0, g_0)$, and such that for every nonnegative integer k , the restriction of $(M(\cdot), g(\cdot))$ to $[k, k+1]$ is an $(r_k, \delta_k, \kappa_k)$ -surgical solution.*

Moreover, if (M_0, g_0) is endowed with a properly discontinuous isometric action of some group Γ , then the surgical solution can be made Γ -equivariant. In addition, if the action of Γ on M_0 is free, then the action on each $M(t)$ can be chosen to be free.

This follows from iteration of Theorem 5.3. Indeed, assuming the parameters $r_k, \delta_k, \kappa_k > 0$ are known, we deduce from $\Theta_k := \Theta(r_k, \delta_k)$ a bound for the sectional curvature Q_k . From this and the κ_k -noncollapsing property, we deduce a lower bound for volumes of balls of radius at most $Q_k^{-1/2}$. This gives a lower bound ρ_k for the injectivity radius of every metric, in particular the metric $g(k+1)$.

The addendum about equivariance follows as explained in the proof of Theorem 11.2.

11.2 Open questions

The first question asks whether the hypotheses of Corollary 11.3 are necessary.

Question. Let M be a connected, orientable 3-manifold which admits a complete riemannian metric of uniformly positive scalar curvature. Is M a connected sum of spherical manifolds and copies of $S^2 \times S^1$?

Next we consider what happens when we relax the hypothesis on the scalar curvature from uniform positivity to positivity. This class is significantly wider, e.g. it includes $S^1 \times \mathbf{R}^2$. One could even relax the condition further to nonnegativity.

Question (Problem 27 in [Yau82]). Classify 3-manifolds admitting complete riemannian metrics of positive (resp. nonnegative) scalar curvature up to diffeomorphism.

A Hamilton's compactness theorem

A *pointed evolving metric* is a triple $(M, \{g(t)\}_{t \in I}, (x_0, t_0))$ where M is a manifold, $g(\cdot)$ is an evolving metric on M , and (x_0, t_0) belongs to $M \times I$. We say that a sequence of pointed evolving metrics $(M_k, \{g_k(t)\}_{t \in I}, (x_k, t_0))$

converges smoothly to a pointed evolving metric $(M_\infty, \{g_\infty(t)\}_{t \in I}, (x_\infty, t_0))$ if there exists an exhaustion of M by open sets U_k , such that $x \in U_k$ for all k , and smooth embeddings $\psi_k : U_k \rightarrow M_k$ sending x to x_k and such that $\psi_k^* g_k(\cdot) - g(\cdot)$ and all its derivatives converge to zero uniformly on compact subsets of $M \times I$.

Theorem A.1 (Hamilton's compactness). *Let $(M_k, \{g_k(t)\}_{t \in (a,b]}, (x_k, t_0))$ be a sequence of complete pointed Ricci flows of the same dimension. Assume:*

i. For all $\rho > 0$,

$$\sup_{k \in \mathbf{N}} \sup_{B(x_k, t_0, \rho) \times (a,b]} |\text{Rm}| < +\infty$$

ii.

$$\inf_{k \in \mathbf{N}} \text{inj}(M_k, g_k(t_0), x_k) > 0.$$

Then $(M_k, \{g_k(t)\}_{t \in (a,b]}, (x_k, t_0))$ converges smoothly to a complete Ricci flow of the same dimension, defined on $(a, b]$.

Remark. If $g(t)$ is defined on $[a, b]$, one can take $t_0 = a$ if one has also uniform bounds on the derivatives of the curvature operator at time t_0 , i.e. if for any $\rho > 0$, for any integer p , $\sup_{k \in \mathbf{N}} \sup_{B(x_k, t_0, \rho) \times \{t_0\}} |\nabla^p \text{Rm}| < +\infty$.

B Partial Ricci flows

Definition. Let $(a, b]$ a time interval. A *partial Ricci flow*⁴ on $U \times (a, b]$ is a pair $(\mathcal{P}, g(\cdot, \cdot))$, where $\mathcal{P} \subset U \times (a, b]$ is an open subset which contains $U \times \{b\}$ and $(x, t) \mapsto g(x, t)$ is a smooth map defined on \mathcal{P} such that the restriction of g to any subset $V \times I \subset \mathcal{P}$ is a Ricci flow on $V \times I$.

Inspection of the proof of Theorem A.1 shows that the following natural extension holds.

Theorem B.1 (Local compactness for flows). *Let $(U_k, \{g_k(t)\}_{t \in (a,0]}, (x_k, 0))$ be a sequence of pointed Ricci flows of the same dimension. Suppose that for some $\rho_0 \in (0, +\infty]$, all the balls $B(x_k, 0, \rho)$ of radius $\rho < \rho_0$ are relatively compact in U_k and that the following holds :*

i. For any $\rho \in (0, \rho_0)$, there exists $\Lambda(\rho) < +\infty$ and $\tau(\rho) > 0$ such that $|\text{Rm}| < \Lambda(\rho)$ on all $P(x_k, 0, \rho, -\tau(\rho))$.

⁴This definition differs from that of *local Ricci flow* introduced by D. Yang [Yan92].

ii.

$$\inf_{k \in \mathbf{N}} \operatorname{inj}(U_k, g_k(0), x_k) > 0.$$

Then there is a riemannian ball $B(x_\infty, \rho_0)$ of the same dimension such that the pointed sequence $(B(x_k, 0, \rho_0), g_k(\cdot), x_k)$ subconverges smoothly to a partial Ricci flow $g_\infty(\cdot)$ defined on $\bigcup_{\rho < \rho_0} (B(x_\infty, \rho) \times (-\tau(\rho), 0])$. Moreover, if $\rho_0 = +\infty$ then for any $t \in [\sup_\rho -\tau(\rho), 0]$, $g_\infty(t)$ is complete.

References

- [BBB⁺] Laurent Bessières, Gérard Besson, Michel Boileau, Sylvain Maillot, and Joan Porti. Geometrisation of 3-manifolds. To appear in *Tracts of the EMS*.
- [CCG⁺08] Bennett Chow, Sun-Chin Chu, David Glickenstein, Christine Guenther, James Isenberg, Tom Ivey, Dan Knopf, Peng Lu, Feng Luo, and Lei Ni. *The Ricci flow: techniques and applications. Part II*, volume 144 of *Mathematical Surveys and Monographs*. American Mathematical Society, Providence, RI, 2008. Analytic aspects.
- [CLN06] Bennett Chow, Peng Lu, and Lei Ni. *Hamilton's Ricci flow*, volume 77 of *Graduate Studies in Mathematics*. American Mathematical Society, Providence, RI, 2006.
- [CTZ08] Bing-Long Chen, Siu-Hung Tang, and Xi-Ping Zhu. Complete classification of compact four-manifolds with positive isotropic curvature. <http://arxiv.org/abs/0810.1999v1>, Oct 2008.
- [CZ06] Bing-Long Chen and Xi-Ping Zhu. Uniqueness of the Ricci flow on complete noncompact manifolds. *J. Differential Geom.*, 74(1):119–154, 2006.
- [DL09] Jonathan Dinkelbach and Bernhard Leeb. Equivariant Ricci flow with surgery and applications to finite group actions on geometric 3-manifolds. *Geom. Topol.*, 13:1129–1173, 2009.
- [GL80] Mikhael Gromov and H. Blaine Lawson, Jr. Spin and scalar curvature in the presence of a fundamental group. I. *Ann. of Math. (2)*, 111(2):209–230, 1980.

- [GL83] Mikhael Gromov and H. Blaine Lawson, Jr. Positive scalar curvature and the Dirac operator on complete Riemannian manifolds. *Inst. Hautes Études Sci. Publ. Math.*, 58:83–196 (1984), 1983.
- [Gro91] M. Gromov. Sign and geometric meaning of curvature. *Rend. Sem. Mat. Fis. Milano*, 61:9–123 (1994), 1991.
- [Ham97] Richard S. Hamilton. Four-manifolds with positive isotropic curvature. *Comm. Anal. Geom.*, 5(1):1–92, 1997.
- [HS09] Gerhard Huisken and Carlo Sinestrari. Mean curvature flow with surgeries of two-convex hypersurfaces. *Invent. Math.*, 175(1):137–221, 2009.
- [Hua09] Hong Huang. Complete 4-manifolds with uniformly positive isotropic curvature. <http://arxiv.org/abs/0912.5405v1>, Dec 2009.
- [KL08] Bruce Kleiner and John Lott. Notes on Perelman’s papers. *Geom. Topol.*, 12(5):2587–2855, 2008.
- [Kne29] H. Kneser. Geschlossene Flächen in dreidimensionalen Mannigfaltigkeiten. *Jahresbericht D. M. V.*, 38:248–260, 1929.
- [Mai07] Sylvain Maillot. A spherical decomposition for Riemannian open 3-manifolds. *Geom. Funct. Anal.*, 17(3):839–851, 2007.
- [Mai08] Sylvain Maillot. Some open 3-manifolds and 3-orbifolds without locally finite canonical decompositions. *Alg. Geom. Topol.*, 8:1794–1810, 2008.
- [MT07] John Morgan and Gang Tian. *Ricci Flow and the Poincaré Conjecture*, volume 3 of *Clay mathematics monographs*. American Mathematical Society, 2007.
- [Per02] Grisha Perelman. The entropy formula for the Ricci flow and its geometric applications. ArXiv : math.DG/0211159, november 2002.
- [Per03a] Grisha Perelman. Finite extinction time for the solutions to the Ricci flow on certain three-manifolds. ArXiv : math.DG/0307245, july 2003.
- [Per03b] Grisha Perelman. Ricci flow with surgery on three-manifolds. ArXiv : math.DG/0303109, march 2003.

- [Ros07] Jonathan Rosenberg. Manifolds of positive scalar curvature: a progress report. In *Surveys in differential geometry. Vol. XI*, volume 11 of *Surv. Differ. Geom.*, pages 259–294. Int. Press, Somerville, MA, 2007.
- [Sco83] Peter Scott. The geometries of 3-manifolds. *Bull. London Math. Soc.*, 15:401–487, 1983.
- [Shi89] Wan-Xiong Shi. Ricci deformation of the metric on complete non-compact Riemannian manifolds. *J. Differential Geom.*, 30(2):303–394, 1989.
- [Sim09] Miles Simon. Ricci flow of non-collapsed 3-manifolds whose ricci curvature is bounded from below. <http://arxiv.org/abs/0903.2142v1>, october 2009.
- [Sma59] Stephen Smale. Diffeomorphisms of the 2-sphere. *Proc. Amer. Math. Soc.*, 10:621–626, 1959.
- [ST89] Peter Scott and Thomas Tucker. Some examples of exotic noncompact 3-manifolds. *Quart. J. Math. Oxford Ser. (2)*, 40(160):481–499, 1989.
- [SY79] R. Schoen and Shing Tung Yau. Existence of incompressible minimal surfaces and the topology of three-dimensional manifolds with nonnegative scalar curvature. *Ann. of Math. (2)*, 110(1):127–142, 1979.
- [Whi35] J. H. C. Whitehead. A certain open manifold whose group is unity. *Quart. J. Math. Oxford*, 6:268–279, 1935.
- [Xu09] Guoyi Xu. Short-time existence of the ricci flow on noncompact riemannian manifolds. <http://arxiv.org/abs/0907.5604v1>, july 2009.
- [Yan92] Deane Yang. Convergence of Riemannian manifolds with integral bounds on curvature. I. *Ann. Sci. École Norm. Sup. (4)*, 25(1):77–105, 1992.
- [Yau82] Shing Tung Yau. Problem section. In *Seminar on Differential Geometry*, volume 102 of *Ann. of Math. Stud.*, pages 669–706. Princeton Univ. Press, Princeton, N.J., 1982.